

▶ CMK56500MM
KME565000M
KMK565000M
KMS565000M

EN **User Manual**
Microwave combi-oven

USER MANUAL



AEG

CONTENTS

1. SAFETY INFORMATION.....	2
2. SAFETY INSTRUCTIONS.....	5
3. PRODUCT DESCRIPTION.....	7
4. CONTROL PANEL.....	8
5. BEFORE FIRST USE.....	8
6. DAILY USE.....	9
7. CLOCK FUNCTIONS.....	10
8. USING THE ACCESSORIES.....	12
9. ADDITIONAL FUNCTIONS.....	13
10. HINTS AND TIPS.....	13
11. CARE AND CLEANING.....	31
12. TROUBLESHOOTING.....	32
13. ENERGY EFFICIENCY.....	33

FOR PERFECT RESULTS

Thank you for choosing this AEG product. We have created it to give you impeccable performance for many years, with innovative technologies that help make life simpler features you might not find on ordinary appliances. Please spend a few minutes reading to get the very best from it.

Visit our website for:



Get usage advice, brochures, trouble shooter, service information:

www.aeg.com/webselfservice



Register your product for better service:

www.registeraeg.com



Buy Accessories, Consumables and Original spare parts for your appliance:

www.aeg.com/shop

CUSTOMER CARE AND SERVICE

Always use original spare parts.

When contacting our Authorised Service Centre, ensure that you have the following data available: Model, PNC, Serial Number.

The information can be found on the rating plate.

 Warning / Caution-Safety information

 General information and tips

 Environmental information

Subject to change without notice.

1. SAFETY INFORMATION

Before the installation and use of the appliance, carefully read the supplied instructions. The

manufacturer is not responsible for any injuries or damages that are the result of incorrect installation or usage. Always keep the instructions in a safe and accessible location for future reference.

1.1 Children and vulnerable people safety

- This appliance can be used by children aged from 8 years and above and persons with reduced physical, sensory or mental capabilities or lack of experience and knowledge if they have been given supervision or instruction concerning the use of the appliance in a safe way and understand the hazards involved.
- Children between 3 and 8 years of age and persons with very extensive and complex disabilities shall be kept away unless continuously supervised.
- Children of less than 3 years of age should be kept away unless continuously supervised.
- Do not let children play with the appliance.
- Keep all packaging away from children and dispose of it appropriately.
- Keep children and pets away from the appliance when it operates or when it cools down. Accessible parts are hot.
- If the appliance has a child safety device, it should be activated.
- Children shall not carry out cleaning and user maintenance of the appliance without supervision.

1.2 General Safety

- Only a qualified person must install this appliance and replace the cable.
- **WARNING:** The appliance and its accessible parts become hot during use. Care should be taken to avoid touching heating elements.
- Always use oven gloves to remove or put in accessories or ovenware.
- Before carrying out any maintenance, disconnect the appliance from the power supply.

- Ensure that the appliance is switched off before replacing the lamp to avoid the possibility of electric shock.
- Do not use a steam cleaner to clean the appliance.
- Do not use harsh abrasive cleaners or sharp metal scrapers to clean the glass door since they can scratch the surface, which may result in shattering of the glass.
- If the mains power supply cable is damaged, it must be replaced by the manufacturer, its Authorised Service Centre or similarly qualified persons to avoid an electrical hazard.
- Do not activate the appliance when it is empty. Metal parts inside the cavity can create electric arcing.
- Metallic containers for food and beverages are not allowed during microwave cooking. This requirement is not applicable if the manufacturer specifies size and shape of metallic containers suitable for microwave cooking.
- If the door or door seals are damaged, the appliance must not be operated until it has been repaired by a qualified person.
- Only a qualified person can carry out any service or repair operation that involves the removal of a cover which gives protection against exposure to microwave energy.
- Do not heat liquids and other foods in sealed containers. They are liable to explode.
- Only use utensils that are suitable for use in microwave ovens.
- When heating food in plastic or paper containers, keep an eye on the appliance due to the possibility of ignition.
- The appliance is intended for heating food and beverages. Drying of food or clothing and heating of warming pads, slippers, sponges, damp cloth and similar may lead to risk of injury, ignition or fire.
- If smoke is emitted, switch off or unplug the appliance and keep the door closed in order to stifle any flames.

- Microwave heating of beverages can result in delayed eruptive boiling. Care must be taken when handling the container.
- The contents of feeding bottles and baby food jars shall be stirred or shaken and the temperature checked before consumption, in order to avoid burns.
- Eggs in their shell and whole hard-boiled eggs should not be heated in the appliance since they may explode, even after microwave heating has ended.
- The appliance should be cleaned regularly and any food deposits removed.
- Failure to maintain the appliance in a clean condition could lead to deterioration of the surface that could adversely affect the life of the appliance and possibly result in a hazardous situation.

2. SAFETY INSTRUCTIONS

2.1 Installation



WARNING!

Only a qualified person must install this appliance.

- Remove all the packaging.
- Do not install or use a damaged appliance.
- Follow the installation instructions supplied with the appliance.
- Always take care when moving the appliance as it is heavy. Always use safety gloves and enclosed footwear.
- Do not pull the appliance by the handle.
- Keep the minimum distance from other appliances and units.
- Make sure that the appliance is installed below and adjacent safe structures.
- The sides of the appliance must stay adjacent to appliances or units with the same height.
- The appliance is equipped with an electric cooling system. It must be operated with the electric power supply.

2.2 Electrical connection



WARNING!

Risk of fire and electric shock.

- All electrical connections should be made by a qualified electrician.
- The appliance must be earthed.
- Make sure that the parameters on the rating plate are compatible with the electrical ratings of the mains power supply.
- Always use a correctly installed shockproof socket.
- Do not use multi-plug adapters and extension cables.
- Make sure not to cause damage to the mains plug and to the mains cable. Should the mains cable need to be replaced, this must be carried out by our Authorised Service Centre.
- Do not let mains cables touch or come near the appliance door, especially when the door is hot.
- The shock protection of live and insulated parts must be fastened in such a way that it cannot be removed without tools.
- Connect the mains plug to the mains socket only at the end of the

installation. Make sure that there is access to the mains plug after the installation.

- If the mains socket is loose, do not connect the mains plug.
- Do not pull the mains cable to disconnect the appliance. Always pull the mains plug.
- Use only correct isolation devices: line protecting cut-outs, fuses (screw type fuses removed from the holder), earth leakage trips and contactors.
- The electrical installation must have an isolation device which lets you disconnect the appliance from the mains at all poles. The isolation device must have a contact opening width of minimum 3 mm.
- This appliance complies with the E.E.C. Directives.

2.3 Use



WARNING!

Risk of injury, burns and electric shock or explosion.

- This appliance is for household use only.
- Do not change the specification of this appliance.
- Make sure that the ventilation openings are not blocked.
- Do not let the appliance stay unattended during operation.
- Deactivate the appliance after each use.
- Be careful when you open the appliance door while the appliance is in operation. Hot air can release.
- Do not operate the appliance with wet hands or when it has contact with water.
- Do not apply pressure on the open door.
- Do not use the appliance as a work surface or as a storage surface.
- Open the appliance door carefully. The use of ingredients with alcohol can cause a mixture of alcohol and air.
- Do not let sparks or open flames to come in contact with the appliance when you open the door.
- Do not put flammable products or items that are wet with flammable products in, near or on the appliance.

- Do not use microwave function to preheat the oven.



WARNING!

Risk of damage to the appliance.

- To prevent damage or discoloration to the enamel:
 - do not put aluminium foil directly on the bottom of cavity of the appliance.
 - do not put water directly into the hot appliance.
 - do not keep moist dishes and food in the appliance after you finish the cooking.
 - be careful when you remove or install the accessories.
- Discoloration of the enamel or stainless steel has no effect on the performance of the appliance.
- Use a deep pan for moist cakes. Fruit juices cause stains that can be permanent.
- This appliance is for cooking purposes only. It must not be used for other purposes, for example room heating.
- Always cook with the oven door closed.
- If the appliance is installed behind a furniture panel (e.g. a door) make sure the door is never closed when the appliance is in operation. Heat and moisture can build up behind a closed furniture panel and cause subsequent damage to the appliance, the housing unit or the floor. Do not close the furniture panel until the appliance has cooled down completely after use.

2.4 Care and cleaning



WARNING!

Risk of injury, fire, or damage to the appliance.

- Before maintenance, deactivate the appliance and disconnect the mains plug from the mains socket.
- Make sure the appliance is cold. There is the risk that the glass panels can break.
- Replace immediately the door glass panels when they are damaged.

Contact the Authorised Service Centre.

- Make sure the cavity and the door are wiped dry after each use. Steam produced during the operation of the appliance condensates on cavity walls and can cause corrosion.
- Clean regularly the appliance to prevent the deterioration of the surface material.
- Fat and food remaining in the appliance can cause fire and electric arcing when the microwave function operates.
- Clean the appliance with a moist soft cloth. Only use neutral detergents. Do not use any abrasive products, abrasive cleaning pads, solvents or metal objects.
- If you use an oven spray, follow the safety instruction on it's packaging.
- Do not clean the catalytic enamel (if applicable) with any kind of detergent.

2.5 Internal lighting



WARNING!
Risk of electric shock.

- The type of light bulb or halogen lamp used for this appliance is for household appliances only. Do not use it for house lighting.
- Before replacing the lamp, disconnect the appliance from the power supply.
- Only use lamps with the same specifications.

2.6 Service

- To repair the appliance contact an Authorised Service Centre.
- Use original spare parts only.

2.7 Disposal



WARNING!
Risk of injury or suffocation.

- Disconnect the appliance from the mains supply.
- Cut off the mains electrical cable close to the appliance and dispose of it.
- Remove the door catch to prevent children or pets from becoming trapped in the appliance.

3. PRODUCT DESCRIPTION

3.1 General overview

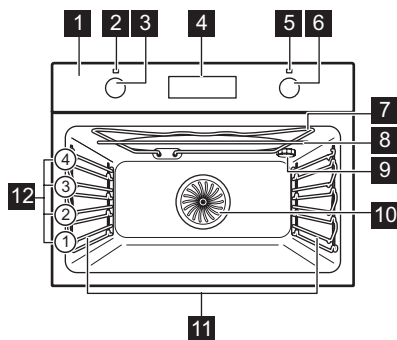

- 1 Control panel
- 2 Power lamp / symbol
- 3 Knob for the heating functions
- 4 Display
- 5 Temperature and microwave power indicator / symbol
- 6 Control knob
- 7 Heating element
- 8 Microwave generator
- 9 Lamp
- 10 Fan
- 11 Shelf support, removable
- 12 Shelf positions

3.2 Accessories

Wire shelf

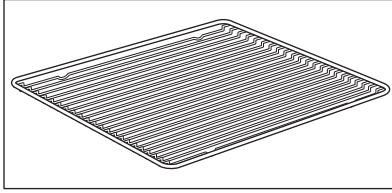

For cookware, cake tins, roasts.

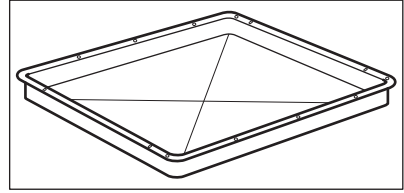

Baking tray



For cakes and biscuits.

4. CONTROL PANEL

4.1 Buttons

Sensor field / Button	Function	Description
 start	MICROWAVE	To set the microwave function. Hold it for more than 3 seconds to turn on or turn off the oven lamp. You can turn on the light also when the oven is turned off.
	CLOCK	To set a clock function.
	TEMPERATURE	To check the oven temperature or the temperature of the core temperature sensor (if applicable). Use only while the heating function operates.

4.2 Display

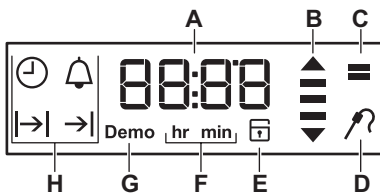

- A. Timer / Temperature / Microwave power
- B. Heat-up and residual heat indicator
- C. Microwave mode
- D. Core temperature sensor (selected models only)
- E. Door lock (selected models only)
- F. Hours / minutes
- G. Demo mode (selected models only)
- H. Clock functions

5. BEFORE FIRST USE



WARNING!
Refer to Safety chapters.



To set the Time of day refer to "Clock functions" chapter.

5.1 Initial Cleaning

Remove all accessories and removable shelf supports from the oven.

 Refer to "Care and cleaning" chapter.

Clean the oven and the accessories before first use.





6. DAILY USE

 **WARNING!**
Refer to Safety chapters.







6.1 Retractable knobs

To use the appliance, press the control knob. The control knob comes out.

6.2 Heating functions

Oven function	Application
 Off position	The oven is off.
 Light	To turn on the lamp without a cooking function.
 Microwave	Creates the heat directly in the food. Use it to heat pre-prepared meals and drinks, to defrost meat or fruit, and to cook vegetables and fish.
 True Fan Cooking	To bake on up to two shelf positions at the same time and to dry food. Set the temperature 20 - 40 °C lower than for Conventional Cooking.
 Pizza Setting	To bake food on one shelf position for a more intensive browning and a crispy bottom. Set the temperature 20 - 40 °C lower than for Conventional Cooking.

Put the accessories and the removable shelf supports back to their initial position.

Oven function	Application
 Conventional Cooking (Top / Bottom Heat)	To bake and roast food on one shelf position.
 Bottom Heat	To bake cakes with crispy bottom and to preserve food.
 Defrost	This function can be used for defrosting frozen foods, such as vegetables and fruits. The defrosting time depends on the amount and size of the frozen food.
 Grilling	To grill flat food and to toast bread.
 Fast Grilling	To grill flat food in large quantities and to toast bread.
 Turbo Grilling	To roast larger meat joints or poultry with bones on one shelf position. Also to make gratins and to brown.

 The lamp may turn off automatically at a temperature below 60 °C during some oven functions.

6.3 Turning the oven on and off

1. Turn the knob for the oven functions to select an oven function.
2. Turn the knob for the temperature to select a temperature.
3. To turn off the oven, turn the knobs for the oven functions and temperature to the off position.

The lamp turns on when the oven operates.



6.4 Setting the function: Microwave

Remove all accessories.

1. Turn the knob for the oven functions to select the function: Microwave .

The display shows first a default microwave power and then a default time for: Duration.

Press  to start with the default values for microwave power and for: Duration.

2. Turn the knob for the temperature / microwave power to change the microwave power. The power setting changes in 100 Watt steps.
3. Press  and then turn the knob for the temperature / microwave power right or left to change:Duration.
4. Press: .

When the time set for Duration ends, the signal sounds and the function Microwave stops.

5. Turn the knob for the oven functions to the off position.



When you open the oven door, the function Microwave stops. To start it again, close the door and press .

6.5 Setting the function: Microwave Combi

You can combine the microwave function with any of the heating functions.

1. Turn the knob for the heating functions to select the function. The display shows a default temperature.
2. Turn the control knob to change the temperature.
3. Press  to combine heating function with the microwave mode.
4. Turn the control knob to change the microwave power settings. The power setting changes in 100 Watt steps.

Around 5 degrees before the set temperature is reached the signal sounds. When the set time for Duration ends the signal sounds again and the oven stops.

5. Turn the knob for the heating functions to the off position.



While using Microwave Combi function the oven can make various noises. They are normal for this function.

6.6 Heat-up indicator

When the oven function operates, the bars in the display  appear one by one when the temperature in the oven increases, and disappear when it decreases.

7. CLOCK FUNCTIONS

7.1 Clock functions table

Clock function	Application
 TIME OF DAY	To show or change the time of day. You can change the time of day only when the oven is off.

Clock function	Application
 DURATION	To set how long the oven works. Use only when a heating function is set.

Clock function	Application
→ END	To set when the oven turns off. Use only when a heating function is set.
→ → TIME DELAY	Combination of DURATION and END function.
 MINUTE MINDER	Use to set a countdown time. This function has no effect on the operation of the oven. You can set the MINUTE MINDER at any time, also if the oven is off.

7.2 Setting and changing the time

After the first connection to the mains, wait until the display shows **hr** and "12:00". "12" flashes.

1. Turn the knob for the temperature / microwave power right or left to set the hours.
2. Press to confirm and switch to set the minutes.

The display shows **min** and the set hour. "00" flashes.

3. Press to confirm or the set time of day will be saved automatically after 5 seconds.

The display shows the new time.

To change the time of day press again and again until the indicator for the time of day flashes in the display.

7.3 Setting the DURATION

1. Set an oven function.
2. Press again and again until |→| starts to flash.
3. Turn the knob for the temperature / microwave power right or left to set the minutes and press to confirm. Turn the knob for the temperature / microwave power right or left to set the hours and press to confirm.

When the set Duration time ends the signal sounds for 2 minutes. |→| and time setting flash in the display. The oven turns off automatically.

4. Press any button or open the oven door to stop the signal.
5. Turn the knob for the oven functions to the off position.

7.4 Setting the END

1. Set an oven function.
2. Press again and again until →| starts to flash.
3. Turn the knob for the temperature / microwave power right or left to set the hours and press to confirm. Turn the knob for the temperature / microwave power right or left to set the minutes and press to confirm.

At the set End time the signal sounds for 2 minutes. →| and time setting flash in the display. The oven turns off automatically.

4. Press any button or open the oven door to stop the signal.
5. Turn the knob for the oven functions to the off position.

7.5 Setting the TIME DELAY function

1. Set an oven function.
2. Press again and again until |→| starts to flash.
3. Turn the knob for the temperature / microwave power right or left to set the minutes for DURATION time and press to confirm. Turn the knob for the temperature / microwave power right or left to set the hours for DURATION time and press to confirm.

The display shows flashing →|.

4. Turn the knob for the temperature / microwave power right or left to set the hours for END time and press to confirm. Turn the knob for the temperature / microwave power right or left to set the minutes for END time and press to confirm.



Oven turns on automatically later on, works for the set DURATION time and stops at the set END time.

At the set END time the signal sounds for 2 minutes. →| and time setting flash in the display. The oven turns off.

5. Press any button or open the oven door to stop the signal.
6. Turn the knob for the oven functions to the off position.

7.6 Setting the MINUTE MINDER

Minute minder can be both set when the oven is turned on and off.

1. Press  again and again until  and "00" flash in the display.
2. Turn the knob for the temperature / microwave power right or left to set the seconds and then the minutes. When the time you set is longer than 60 minutes, **hr** flash in the display.
3. Set the hours.
4. The MINUTE MINDER starts automatically after 5 seconds. After 90% of the set time the signal sounds.
5. When the set time ends the signal sounds for 2 minutes. "00:00" and  flash in the display. Press any button to stop the signal.

8. USING THE ACCESSORIES



WARNING!
Refer to Safety chapters.

8.1 Inserting the accessories

Use only suitable cookware and material.



WARNING!
Refer to "Hints and tips" chapter, Microwave suitable cookware and materials.

Wire shelf:

Push the shelf between the guide bars of the shelf support and make sure that the feet point down.

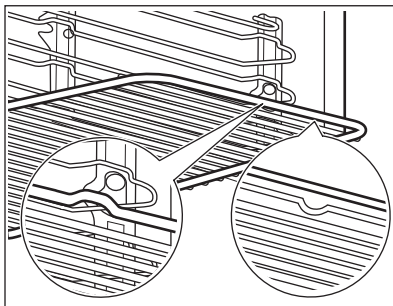

Baking tray:

Push the baking tray between the guide bars of the shelf support.

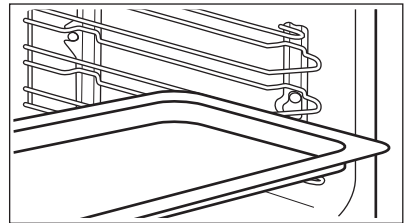

Wire shelf and baking tray together:

Push the baking tray between the guide bars of the shelf support and the wire shelf on the guide bars above.

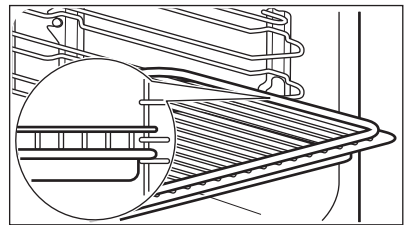

Small indentation at the top increase safety. The indentations are also anti-tip devices. The high rim around the shelf prevents cookware from slipping of the shelf.

9. ADDITIONAL FUNCTIONS

9.1 Using the Child Lock

When the Child Lock is on the oven cannot be turned on accidentally.

1. Ensure the knob for the oven functions is in the off position.
2. Press and hold  and **°C** at the same time for 2 seconds. The signal sounds. SAFE appears on the display.
To turn off the Child Lock, repeat step 2.

9.2 Using the Function Lock

You can turn on the Function Lock function only when the oven operates.

When the Function lock is on the temperature and time settings of a running oven function cannot be changed accidentally.

1. Select an oven function and set it according your preferences.
2. Press and hold  and **°C** at the same time for 2 seconds. The signal sounds. Loc appears on the display for 5 seconds.

 Loc appears on the display when you turn the knob for the temperature or press any button when the Function lock is on.

When you turn the knob for the oven functions, the oven stops.

When you turn off the oven while the Function Lock is on, the Function Lock switches automatically to the Child Lock. Refer to "Using the Child Lock".

To turn off the Function Lock, repeat step 2.

9.3 Residual heat indicator

When you turn off the oven, the display shows the residual heat indicator  if the temperature in the oven is more than 40 °C. Turn the control knob left or right to check the oven temperature.

9.4 Automatic Switch-off

For safety reasons the oven turns off automatically after some time if a heating function operates and you do not change the oven temperature.

Temperature (°C)	Switch-off time (h)
30 - 115	12.5
120 - 195	8.5
200 - 230	5.5

After an automatic switch-off, press any button to operate the oven again.

 The Automatic switch-off does not work with the functions: Light, Duration, End.

9.5 Cooling fan

When the oven operates, the cooling fan turns on automatically to keep the surfaces of the oven cool. If you turn off the oven, the cooling fan can continue to operate until the oven cools down.

10. HINTS AND TIPS

 **WARNING!**
Refer to Safety chapters.

 The temperature and baking times in the tables are guidelines only. They depend on the recipes and the quality and quantity of the ingredients used.

10.1 Cooking recommendations

Your oven may bake or roast differently to the oven you had before. The below tables provide you with the standard settings for temperature, cooking time and shelf position.

If you cannot find the settings for a special recipe, look for the similar one.

10.2 Microwave recommendations

Place the food on a plate on the bottom of the cavity.

Turn or stir the food halfway through the defrosting and cooking time.

Cover the food for cooking and reheating.

Put the spoon to the bottle or glass when heating drinks to ensure better heat distribution.

Put the food into the oven without any packaging. The packaged ready meals can be put into the oven only when the packaging is microwave safe (check information on the packaging).

Microwave cooking

Cook food covered. If you want to keep a crust cook food without a cover.

Do not overcook the dishes by setting the power and time too high. The food can dry out, burn or cause fire.

Do not use the oven to cook eggs or snails in their shells, because they can burst. Pierce the yolk of fried egg before reheating it.

Pierce food with skin or peel with a fork several times before cooking.

Cut vegetables into similar-sized pieces.

Stir liquid dishes from time to time.

Stir the food before serving.

After you turn off the oven, take the food out and let it stand for a few minutes.

Microwave defrosting

Put the frozen, unwrapped food on a small upturned plate with a container below it, or on a defrosting rack or plastic sieve so that the defrosting liquid can run off.

Remove defrosted pieces subsequently.

To cook fruit and vegetables without defrosting them first, you can use a higher microwave power.

10.3 Microwave suitable cookware and materials

For the microwave use only suitable cookware and materials. Use below table as a reference.

Cookware / Material	Microwave function		Microwave Combi function
	Defrosting	Heating, Cooking	
Ovenproof glass and porcelain with no metal components, e.g. heat-proof glass	✓	✓	✓
Non-ovenproof glass and porcelain without any silver, gold, platinum or other metal decorations	✓	X	X
Glass and glass ceramic made of ovenproof / frost-proof material	✓	✓	✓
Ceramic and earthenware without any quartz or metal components and glazes which contain metal	✓	✓	X
Ceramic, porcelain and earthenware with unglazed bottom or with small holes, e.g. on handles	X	X	X

Cookware / Material	Microwave function		Microwave Combi function
	Defrosting	Heating, Cooking	
Heat-resistant plastic up to 200 °C (please always check the plastic container specification before use)	✓	✓	X
Cardboard, paper	✓	X	X
Clingfilm	✓	X	X
Roasting film with microwave safe closure (please always check the film specification before use)	✓	✓	X
Roasting dishes made of metal, e.g. enamel, cast iron	X	X	✓
Baking tins, black lacquer or silicon-coated (please always check the baking tins specification before use)	X	X	✓
Baking tray	X	X	X
Wire shelf	X	X	✓
Cookware for microwave use, e.g. crisp pan	X	✓	X

10.4 Baking

- Use the lower temperature the first time.
 - You can extend baking times by 10 – 15 minutes if you bake cakes on more than one shelf position.
 - Cakes and pastries at different heights do not always brown equally.
- There is no need to change the temperature setting if an unequal browning occurs. The differences equalize during baking.
- Trays in the oven can twist during baking. When the trays become cold again, the distortions disappear.

10.5 Tips on baking

Baking results	Possible cause	Remedy
The bottom of the cake is not browned sufficiently.	The shelf position is incorrect.	Put the cake on a lower shelf.

Baking results	Possible cause	Remedy
The cake sinks and becomes soggy, lumpy or streaky.	The oven temperature is too high.	The next time you bake, set a slightly lower oven temperature.
	The baking time is too short.	Set a longer baking time. You cannot decrease baking times by setting higher temperatures.
	There is too much liquid in the mixture.	Use less liquid. Be careful with mixing times, especially if you use a mixing machine.
The cake is too dry.	The oven temperature is too low.	The next time you bake, set a higher oven temperature.
	The baking time is too long.	The next time you bake, set a shorter baking time.
The cake browns unevenly.	The oven temperature is too high and the baking time is too short.	Set a lower oven temperature and a longer baking time.
	The mixture is unevenly distributed.	Spread the mixture evenly on the baking tray.
The cake is not ready in the baking time given.	The oven temperature is too low.	The next time you bake, set a slightly higher oven temperature.

10.6 Baking on one oven level

Baking in tins

Food	Function	Temperature (°C)	Time (min)	Shelf position
Ring cake or brioche	True Fan Cooking	150 - 160	50 - 70	1
Madeira cake / Fruit cakes	True Fan Cooking	140 - 160	70 - 90	1
Sponge cake / Sponge cake	True Fan Cooking	140 - 150	35 - 50	1
Sponge cake / Sponge cake	Top / Bottom Heat	160	35 - 50	2
Flan base - short pastry ¹⁾	True Fan Cooking	170 - 180	10 - 25	1
Flan base - sponge mixture	True Fan Cooking	150 - 170	20 - 25	1

Food	Function	Temperature (°C)	Time (min)	Shelf position
Apple pie / Apple pie (2 tins Ø 20 cm, diagonally off set)	True Fan Cooking	160	70 - 90	1
Apple pie / Apple pie (2 tins Ø 20 cm, diagonally off set)	Top / Bottom Heat	180	70 - 90	1
Cheesecake, tray ²⁾	Top / Bottom Heat	160 - 170	60 - 90	1

¹⁾ Preheat the oven.

²⁾ Use a deep pan.

Cakes / pastries / breads on baking trays

Food	Function	Temperature (°C)	Time (min)	Shelf position
Plaited bread / bread crown	Top / Bottom Heat	170 - 190	30 - 40	2
Christmas stollen ¹⁾	Top / Bottom Heat	160 - 180	50 - 70	2
Bread (rye bread) ¹⁾	Top / Bottom Heat			2
first		230	20	
then		160 - 180	30 - 60	
Cream puffs / Eclairs ¹⁾	Top / Bottom Heat	190 - 210	20 - 35	2
Swiss Roll ¹⁾	Top / Bottom Heat	180 - 200	10 - 20	2
Cake with crumble topping (dry)	True Fan Cooking	150 - 160	20 - 40	1
Buttered almond cake / sugar cakes ¹⁾	Top / Bottom Heat	190 - 210	20 - 30	2
Fruit flans (made with yeast dough / sponge mixture) ²⁾	True Fan Cooking	150 - 160	35 - 55	1
Fruit flans (made with yeast dough / sponge mixture) ²⁾	Top / Bottom Heat	170	35 - 55	1

Food	Function	Temperature (°C)	Time (min)	Shelf position
Fruit flans made with short pastry	True Fan Cooking	160 - 170	40 - 80	1
Yeast cakes with delicate toppings (e.g. quark, cream, custard) ¹⁾	Top / Bottom Heat	160 - 180	40 - 80	2

¹⁾ Preheat the oven.

²⁾ Use a deep pan.

Biscuits

Food	Function	Temperature (°C)	Time (min)	Shelf position
Short pastry biscuits	True Fan Cooking	150 - 160	10 - 20	1
Short bread / Short bread / Pastry Stripes	True Fan Cooking	140	20 - 35	1
Short bread / Short bread / Pastry Stripes ¹⁾	Top / Bottom Heat	160	20 - 30	2
Biscuits made with sponge mixture	True Fan Cooking	150 - 160	15 - 20	1
Pastries made with egg white, meringues	True Fan Cooking	80 - 100	120 - 150	1
Macaroons	True Fan Cooking	100 - 120	30 - 50	1
Biscuits made with yeast dough	True Fan Cooking	150 - 160	20 - 40	1
Puff pastries ¹⁾	True Fan Cooking	170 - 180	20 - 30	1
Rolls ¹⁾	Top / Bottom Heat	190 - 210	10 - 25	2
Small cakes / Small cakes ¹⁾	True Fan Cooking	160	20 - 35	3
Small cakes / Small cakes ¹⁾	Top / Bottom Heat	170	20 - 35	2

¹⁾ Preheat the oven.

10.7 Bakes and gratins

Food	Function	Temperature (°C)	Time (min)	Shelf position
Pasta bake	Top / Bottom Heat	180 - 200	45 - 60	1
Lasagne	Top / Bottom Heat	180 - 200	25 - 40	1
Vegetables au gratin ¹⁾	Turbo Grilling	160 - 170	15 - 30	1
Baguettes topped with melted cheese	True Fan Cooking	160 - 170	15 - 30	1
Sweet bakes	Top / Bottom Heat	180 - 200	40 - 60	1
Fish bakes	Top / Bottom Heat	180 - 200	30 - 60	1
Stuffed vegetables	True Fan Cooking	160 - 170	30 - 60	1

¹⁾ Preheat the oven.

10.8 Multilevel baking

Use the function True Fan Cooking.

Cakes / pastries / breads on baking trays

Food	Temperature (°C)	Time (min)	Shelf position
Cream puffs / Eclairs ¹⁾	160 - 180	25 - 45	1 / 3
Dry streusel cake	150 - 160	30 - 45	1 / 3

¹⁾ Preheat the oven.

Biscuits / small cakes / pastries / rolls

Food	Temperature (°C)	Time (min)	Shelf position
Short pastry biscuits	150 - 160	20 - 40	1 / 3
Short bread / Short bread / Pastry Stripes	140	25 - 45	1 / 3
Biscuits made with sponge mixture	160 - 170	25 - 40	1 / 3

Food	Temperature (°C)	Time (min)	Shelf position
Pastries made with egg white, meringues	80 - 100	130 - 170	1 / 3
Macaroons	100 - 120	40 - 80	1 / 3
Biscuits made with yeast dough	160 - 170	30 - 60	1 / 3

10.9 Pizza Setting

Food	Temperature (°C)	Time (min)	Shelf position
Pizza (thin crust) ¹⁾	200 - 230	15 - 20	3
Pizza (with a lot of topping) ²⁾	180 - 200	20 - 30	3
Tarts	180 - 200	40 - 55	3
Spinach flan	160 - 180	45 - 60	3
Quiche Lorraine (Savoury flan)	170 - 190	45 - 55	3
Swiss Flan	170 - 190	45 - 55	3
Cheesecake	140 - 160	60 - 90	3
Apple cake, covered	150 - 170	50 - 60	3
Vegetable pie	160 - 180	50 - 60	3
Unleavened bread ¹⁾	230	10 - 20	3
Puff pastry flan ¹⁾	160 - 180	45 - 55	3
Flammekuchen ¹⁾	230	12 - 20	3
Piroggen (Russian version of calzone) ¹⁾	180 - 200	15 - 25	3

¹⁾ Preheat the oven.

²⁾ Use a deep pan.

10.10 Roasting

Use heat-resistant ovenware.

Roast large roasting joints directly in the tray or on the wire shelf placed above the tray.

Put some water in the tray to prevent the meat juices or fat from burning.

Meat with crackling can be roasted in the roasting tin without the lid.

Turn the roast after 1/2 - 2/3 of the cooking time.

To keep meat more succulent:

- roast lean meat in the roasting tin with the lid or use roasting bag.

- roast meat and fish in large pieces (1 kg or more).
- baste large roasts and poultry with their juices several times during roasting.

10.11 Roasting

Beef

Food	Function	Quantity (kg)	Power (Watts)	Temperature (°C)	Time (min)	Shelf position
Pot roast	Top / Bottom Heat	1 - 1.5	200	230	60 - 80	1

Pork

Food	Function	Quantity (kg)	Power (Watts)	Temperature (°C)	Time (min)	Shelf position
Shoulder, neck, ham joint	Turbo Grilling	1 - 1.5	200	160 - 180	50 - 70	1
Meat loaf	Turbo Grilling	0.75 - 1	200	160 - 170	35 - 50	1
Pork knuckle (pre-cooked)	Turbo Grilling	0.75 - 1	200	150 - 170	60 - 75	1

Veal

Food	Function	Quantity (kg)	Power (Watts)	Temperature (°C)	Time (min)	Shelf position
Roast veal	Turbo Grilling	1	200	160 - 180	50 - 70	1
Knuckle of veal	Turbo Grilling	1.5 - 2	200	160 - 180	75 - 100	1

Lamb

Food	Function	Quantity (kg)	Power (Watts)	Temperature (°C)	Time (min)	Shelf position
Leg of lamb, roast lamb	Turbo Grilling	1 - 1.5	200	150 - 170	50 - 70	1

Poultry

Food	Function	Quantity (kg)	Power (Watts)	Temperature (°C)	Time (min)	Shelf position
Poultry portions	Turbo Grilling	0.2 - 0.25 each	200	200 - 220	20 - 35	1
Chicken half	Turbo Grilling	0.4 - 0.5 each	200	190 - 210	25 - 40	1
Chicken poulard	Turbo Grilling	1 - 1.5	200	190 - 210	60 - 80	1
Duck	Turbo Grilling	1.5 - 2	200	180 - 200	80 - 110	1

Fish (steamed)

Food	Function	Quantity (kg)	Power (Watts)	Temperature (°C)	Time (min)	Shelf position
Whole fish	Top / Bottom Heat	1 - 1.5	200	210 - 220	30 - 45	1

Dishes

Food	Function	Quantity (kg)	Power (Watts)	Temperature (°C)	Time (min)	Shelf position
Dishes sweet	True Fan Cooking	-	200	160 - 180	20 - 35	1
Savoury dishes with cooked ingredients (noodles, vegetables)	True Fan Cooking	-	400 - 600	160 - 180	20 - 45	1
Savoury dishes with raw ingredients (potatoes, vegetables)	True Fan Cooking	-	400 - 600	160 - 180	30 - 45	2

10.12 Grilling

Preheat the empty oven for 5 minutes.

Put the pan to collect the fat into the first shelf position.

Grilling

Food	Temperature (°C)	Grilling time (min)		Shelf position
		1st side	2nd side	
Roast beef, medium	210 - 230	30 - 40	30 - 40	1
Filet of beef, medium	230	20 - 30	20 - 30	1
Back of pork	210 - 230	30 - 40	30 - 40	1
Back of veal	210 - 230	30 - 40	30 - 40	1
Back of lamb	210 - 230	25 - 35	20 - 35	1
Whole Fish, 0.5 - 1 kg	210 - 230	15 - 30	15 - 30	1

Fast Grilling

Preheat the empty oven for 3 minutes.

Grill with the maximum temperature setting.

Food	Grilling time (min)		Shelf position
	1st side	2nd side	
Pork fillet	10 - 12	6 - 10	2
Sausages	10 - 12	6 - 8	3
Fillet steaks, veal steaks	7 - 10	6 - 8	3
Toast with topping	6 - 8	-	2

10.13 Frozen foods

- Remove the food packaging. Put the food on a plate.

- Do not cover it with a bowl or a plate. This can extend the defrost time. Use the function True Fan Cooking.

Food	Temperature (°C)	Time (min)	Shelf position
Pizza, frozen	200 - 220	15 - 25	3
Pizza American, frozen	190 - 210	20 - 25	3
Pizza, chilled	210 - 230	13 - 25	3
Pizza Snacks, frozen	180 - 200	15 - 30	3
French Fries, thin ¹⁾	210 - 230	20 - 30	3
French Fries, thick ¹⁾	210 - 230	25 - 35	3

Food	Temperature (°C)	Time (min)	Shelf position
Wedges / Croquettes ¹⁾	210 - 230	20 - 35	3
Hash Browns	210 - 230	20 - 30	3
Lasagne / Cannelloni, fresh	170 - 190	35 - 45	2
Lasagne / Cannelloni, frozen	160 - 180	40 - 60	2
Chicken Wings	190 - 210	20 - 30	3

1) Turn 2 or 3 times during roasting.

Frozen Ready Meals Table

Food	Function	Temperature (°C)	Time (min)	Shelf position
Frozen pizza ¹⁾	Top / Bottom Heat	as per manufacturer's instructions	as per manufacturer's instructions	2
Chips ²⁾ (300 - 600 g)	Top / Bottom Heat or Turbo Grilling	200 - 220	as per manufacturer's instructions	2
Baguettes ³⁾	Top / Bottom Heat	as per manufacturer's instructions	as per manufacturer's instructions	2
Fruit cake	Top / Bottom Heat	as per manufacturer's instructions	as per manufacturer's instructions	2

1) Preheat the oven.

2) Turn 2 or 3 times during cooking.

3) Preheat the oven.

10.14 Defrost

- Remove the food packaging and put the food on a plate.
- Use the first shelf position from the bottom.
- Do not cover the food with a bowl or a plate, as this can extend the defrost time.
- For large portions of food place an upturned empty plate on the bottom of the oven cavity. Put the food in a deep plate or dish and set it on top of the plate inside the oven. Remove shelf supports if necessary.

Food	Quantity (kg)	Defrosting time (min)	Further defrosting time (min)	Comments
Chicken	1	100 - 140	20 - 30	Put the chicken on an upturned saucer in a big plate. Turn halfway through.
Meat	1	100 - 140	20 - 30	Turn halfway through.
Trout	0.15	25 - 35	10 - 15	-
Strawberries	0.3	30 - 40	10 - 20	-
Butter	0.25	30 - 40	10 - 15	-
Cream	2 x 0.2	80 - 100	10 - 15	Whip the cream when still slightly frozen in places.
Gateau	1.4	60	60	-

10.15 Preserving - Bottom Heat

- Use only preserve jars of the same dimensions available on the market.
- Do not use jars with twist-off and bayonet type lids or metal tins.
- Use the first shelf from the bottom for this function.
- Put no more than six one-litre preserve jars on the baking tray.
- Fill the jars equally and close with a clamp.

- The jars cannot touch each other.
- Put approximately 1/2 litre of water into the baking tray to give sufficient moisture in the oven.
- When the liquid in the jars starts to simmer (after approximately 35 - 60 minutes with one-litre jars), stop the oven or decrease the temperature to 100 °C (see the table).

Soft fruit

Food	Temperature (°C)	Cooking time until simmering (min)	Continue to cook at 100 °C (min)
Strawberries / Blueberries / Raspberries / Ripe gooseberries	160 - 170	35 - 45	-

Stone fruit

Food	Temperature (°C)	Cooking time until simmering (min)	Continue to cook at 100 °C (min)
Pears / Quinces / Plums	160 - 170	35 - 45	10 - 15

Vegetables

Food	Temperature (°C)	Cooking time until simmering (min)	Continue to cook at 100 °C (min)
Carrots ¹⁾	160 - 170	50 - 60	5 - 10
Cucumbers	160 - 170	50 - 60	-
Mixed pickles	160 - 170	50 - 60	5 - 10
Kohlrabi / Peas / Asparagus	160 - 170	50 - 60	15 - 20

¹⁾ Leave standing in the oven after it is deactivated.

10.16 Drying - True Fan Cooking

Food	Temperature (°C)	Time (h)	Shelf position
Beans	60 - 70	6 - 8	3
Peppers	60 - 70	5 - 6	3
Vegetables for soup	60 - 70	5 - 6	3
Mushrooms	50 - 60	6 - 8	3
Herbs	40 - 50	2 - 3	3
Plums	60 - 70	8 - 10	3
Apricots	60 - 70	8 - 10	3
Apple slices	60 - 70	6 - 8	3
Pears	60 - 70	6 - 9	3

10.17 Microwave cooking

Tips for the Microwave

Cooking/Defrosting results	Possible cause	Remedy
The food is too dry.	The power was too high. The time was too long.	Next time select a lower power and a longer time.
The food is still not defrosted, hot or cooked after the end of cooking time.	The time was too short.	Set a longer time. Do not increase the microwave power.
The food is overheated at the edges but is still not ready in the middle.	The power was too high.	Next time select a lower power and a longer time.

Defrosting meat

Food	Power (Watts)	Time (min)	Standing time (min)
Steak (0.2 kg)	100	5 - 7	5 - 10
Minced meat (0.5 kg)	100	10 - 15	5 - 10

Defrosting poultry

Food	Power (Watts)	Time (min)	Standing time (min)
Chicken (1 kg)	100	25 - 30	10 - 20
Chicken breast (0.15 kg)	100	3 - 5	10 - 15
Chicken legs (0.15 kg)	100	3 - 5	10 - 15

Defrosting fish

Food	Power (Watts)	Time (min)	Standing time (min)
Whole Fish (0.5 kg)	100	10 - 15	5 - 10
Fish fillets (0.5 kg)	100	12 - 15	5 - 10

Defrosting dairy products

Food	Power (Watts)	Time (min)	Standing time (min)
Butter (0.25 kg)	100	3 - 4	5 - 10
Grated cheese (0.2 kg)	100	2 - 3	10 - 15

Defrosting cakes / pastries

Food	Power (Watts)	Time (min)	Standing time (min)
Yeast cake (1 piece)	200	2 - 3	15 - 20
Cheesecake (1 piece)	100	2 - 4	15 - 20
Dry cake (e.g. Pound cake) (1 piece)	200	2 - 4	15 - 20
Bread (1 kg)	200	15 - 20	5 - 10
Sliced bread (0,2 kg)	200	3 - 5	5 - 10
Bread rolls (4 pieces)	200	2 - 4	2 - 5

Defrosting fruit

Food	Power (Watts)	Time (min)	Standing time (min)
Fruit (0.25 kg)	100	5 - 10	10 - 15

Reheating

Food	Power (Watts)	Time (min)	Standing time (min)
Baby food in jars (0.2 kg)	300	1 - 2	-
Baby milk (180 ml); Put spoon into the bottle	600	0:20 - 0:40	-
Convenience food (0.5 kg)	600	6 - 9	2 - 5
Frozen ready meals (0.5 kg)	400	10 - 15	2 - 5
Milk (200 ml)	1000	1 - 1:30	-
Water (200 ml)	1000	1:30 - 2	-
Sauce (200 ml)	600	1 - 3	-
Soup (300 ml)	600	3 - 5	-

Melting

Food	Power (Watts)	Time (min)	Standing time (min)
Chocolate / Chocolate coating (0.15 kg)	300	2 - 4	-
Butter (0.1 kg)	400	0:30-1:30	-

Cooking

Food	Power (Watts)	Time (min)	Standing time (min)
Whole fish (0.5 kg)	500	8 - 10	2 - 5
Fish fillets (0.5 kg)	400	4 - 7	2 - 5
Vegetables, fresh (0.5 kg + 50 ml of water)	600	5 - 15	-
Vegetables, frozen (0.5 kg + 50 ml of water)	600	10 - 20	-
Jacked potatoes (0.5 kg)	600	7 - 10	-
Rice (0.2 kg + 400 ml of water)	600	15 - 18	-
Popcorn	1000	1:30 - 3	-

Microwave Combi function

Use this function to cook food in a shorter time and to brown it.

Combine functions: Turbo Grilling and Microwave.

Food	Ovenware	Power (Watts)	Temperature (°C)	Time (min)	Shelf position	Standing time (min)
2 chicken halves (2 x 0.55 kg)	Round glass dish, Ø 26 cm	300	220	40	2	5
Au gratin potatoes (1 kg)	Gratin dish	300	200	40	2	10
Roast pork neck (1.1 kg)	Glass dish with strainer	300	200	70	1	10

10.18 Examples of cooking applications for power settings

The data in the table is for guidance only.

Power setting	Use
<ul style="list-style-type: none"> • 1000 Watt • 900 Watt • 800 Watt • 700 Watt 	Heating liquids Searing at the start of the cooking process Cooking vegetables
<ul style="list-style-type: none"> • 600 Watt • 500 Watt 	Defrosting and heating frozen meals Heating one-plate meals Simmering stews Cooking egg dishes
<ul style="list-style-type: none"> • 400 Watt • 300 Watt 	Continuing to cook meals Cooking delicate food Heating baby food Simmering rice Heating delicate food Melting cheese, chocolate, butter
<ul style="list-style-type: none"> • 200 Watt • 100 Watt 	Defrosting meat, fish Defrosting cheese, cream, butter Defrosting fruit and cakes Defrosting bread

10.19 Information for test institutes

Microwave function

Tests according to IEC 60705.

Food	Power (Watts)	Quantity (kg)	Shelf position ¹⁾	Time (min)	Comments
Sponge cake	600	0.475	Bottom	7 - 9	Turn container around by 1/4, halfway through the cooking time.
Meatloaf	400	0.9	2	25 - 32	Turn container around by 1/4, halfway through the cooking time.
Egg custard	300	1	Bottom	18	-
Meat defrosting	100	0.5	Bottom	7 - 8	Turn the meat upside down halfway through the cooking time.

¹⁾ Use wire shelf unless otherwise specified.

Microwave Combi function

Tests according to IEC 60705.

Food	Function	Power (Watts)	Quantity (kg)	Temperature (°C)	Shelf position ¹⁾	Time (min)	Comments
Cake	True Fan Cooking + MW	100	0.7	180	2	29 - 31	Turn container around by 1/4, halfway through the cooking time.
Potato gratin	Grill + Fan + MW	300	1.1	180	2	40 - 45	Turn container around by 1/4, halfway through the cooking time.

Food	Function	Power (Watts)	Quantity (kg)	Temperature (°C)	Shelf position 1)	Time (min)	Comments
Chicken	Grill + Fan + MW	200	1.1	230	1	45 - 55	Put the meat in round glass container and turn it upside down halfway through the cooking time.

1) Use wire shelf unless otherwise specified.

11. CARE AND CLEANING



WARNING!
Refer to Safety chapters.

11.1 Notes on cleaning

Clean the front of the oven with a soft cloth with warm water and a mild cleaning agent.

To clean metal surfaces, use a dedicated cleaning agent.

Clean the oven interior after each use. Fat accumulation or other food remains may result in a fire.

Clean the cavity roof carefully from food residuals and fat.

Clean all accessories after each use and let them dry. Use a soft cloth with warm water and a cleaning agent.

Clean stubborn dirt with a special oven cleaner.

If you have nonstick accessories, do not clean them using aggressive agents, sharp-edged objects or a dishwasher. It can cause damage to the nonstick coating.

Clean the moisture from the cavity after each use.

11.2 Removing the shelf supports

Before maintenance, make sure that the oven is cool. There is a risk of burns.

To clean the oven, remove the shelf supports.

1. Pull carefully the supports up and out of the front catch.

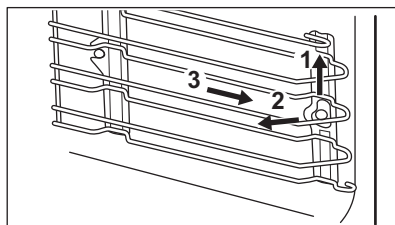

2. Pull the front end of the shelf support away from the side wall.
 3. Pull the supports out of the rear catch.
- Install the shelf supports in the opposite sequence.

11.3 Replacing the lamp



WARNING!
Risk of electric shock.
The lamp can be hot.

1. Turn off the oven. Wait until the oven is cooled down.
2. Disconnect the oven from the mains.
3. Put a cloth on the bottom of the cavity.



CAUTION!
Always hold the halogen lamp with a cloth to prevent grease residue from burning on the lamp.

The top lamp

1. Turn the lamp glass cover to remove it.
2. Clean the glass cover.
3. Replace the lamp with a suitable 300 °C heat-resistant lamp.
4. Install the glass cover.

12. TROUBLESHOOTING



WARNING!

Refer to Safety chapters.

12.1 What to do if...

Problem	Possible cause	Remedy
You cannot activate or operate the oven.	The oven is not connected to an electrical supply or it is connected incorrectly.	Check if the oven is correctly connected to the electrical supply (refer to the connection diagram if available).
The oven does not heat up.	The oven is deactivated.	Activate the oven.
The oven does not heat up.	The clock is not set.	Set the clock.
The oven does not heat up.	The necessary settings are not set.	Make sure that the settings are correct.
The oven does not heat up.	The automatic switch-off is activated.	Refer to "Automatic switch-off".
The oven does not heat up.	The Child Lock is on.	Refer to "Using the Child Lock".
The oven does not heat up.	The fuse is blown.	Make sure that the fuse is the cause of the malfunction. If the fuse is blown again and again, contact a qualified electrician.
The lamp does not operate.	The lamp is defective.	Replace the lamp.
It takes too long to cook the dishes or they cook too quickly.	The temperature is too low or too high.	Adjust the temperature if necessary. Follow the advice in the user manual.
Steam and condensation settle on the food and in the cavity of the oven.	You left the dish in the oven for too long.	Do not leave the dishes in the oven for longer than 15 - 20 minutes after the cooking process ends.

Problem	Possible cause	Remedy
The display shows an error code that is not in this table.	There is an electrical fault.	<ul style="list-style-type: none"> Deactivate the oven with the house fuse or the safety switch in the fuse box and activate it again. If the display shows the error code again, contact the Customer Care Department.

12.2 Service data

If you cannot find a solution to the problem yourself, contact your dealer or an Authorised Service Centre.

The necessary data for the service centre is on the rating plate. The rating plate is

on the front frame of the oven cavity. Do not remove the rating plate from the oven cavity.

We recommend that you write the data here:	
Model (MOD.)
Product number (PNC)
Serial number (S.N.)

13. ENERGY EFFICIENCY

13.1 Energy saving



The oven contains features which help you save energy during everyday cooking.

General hints

Make sure that the oven door is closed properly when the oven operates. Do not open the door too often during cooking. Keep the door gasket clean and make sure it is well fixed in its position.

Use metal dishes to improve energy saving, but only when you use a non-microwave function.

When possible, do not preheat the oven before you put the food inside.

When the cooking duration is longer than 30 minutes, reduce the oven temperature to minimum 3 - 10 minutes before the end of the cooking time, depending on the duration of the

cooking. The residual heat inside the oven will continue to cook.

Use the residual heat to warm up other dishes.

Keep breaks between baking as short as possible when you prepare few dishes at one time.

Cooking with fan

When possible, use the cooking functions with fan to save energy.

Residual heat

If a programme with the Duration or End Time selection is activated and the cooking time is longer than 30 minutes, the heating elements automatically deactivate earlier in some oven functions.

The fan and lamp continue to operate.

Keep food warm

Choose the lowest possible temperature setting to use residual heat and keep a

meal warm. The residual heat indicator or temperature appears on the display.

14. ENVIRONMENTAL CONCERNS

Recycle materials with the symbol . Put the packaging in relevant containers to recycle it. Help protect the environment and human health by recycling waste of electrical and electronic appliances. Do not dispose of

appliances marked with the symbol  with the household waste. Return the product to your local recycling facility or contact your municipal office.

www.aeg.com/shop



867343895-B-062018



AEG

Free Manuals Download Website

<http://myh66.com>

<http://usermanuals.us>

<http://www.somanuals.com>

<http://www.4manuals.cc>

<http://www.manual-lib.com>

<http://www.404manual.com>

<http://www.luxmanual.com>

<http://aubethermostatmanual.com>

Golf course search by state

<http://golfingnear.com>

Email search by domain

<http://emailbydomain.com>

Auto manuals search

<http://auto.somanuals.com>

TV manuals search

<http://tv.somanuals.com>