

# **315/318      Electric**

***Operator's Manual***

***English: page 1-22***

***Manuale do utilizador***

***Portugês: página 23-44***

***Manual del operador***

***Espanol: página 45-66***

***Οδηγίες χρήσεως***

***Ελληνικά: σελίδα 67-88***



108 07 09-56

# SYMBOLS USED IN OPERATOR S MANUAL:

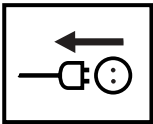

Always disconnect power before performing cleaning or maintenance work.



Visual inspection.

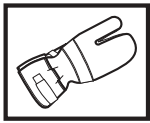

Always use approved safety gloves.



Use approved face mask or safety goggles.

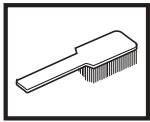

Clean your chain saw regularly.

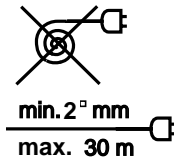

Do not use a coiled extension cord.

Minimum wire cross-section: 1 mm<sup>2</sup>

Maximum cable length: 30 m

Voltage: 230 V



**CAUTION!**  
Chain saws are dangerous!  
Careless or improper use can result in severe or fatal injury.

# SYMBOLS ON THE CHAIN SAW:



**CAUTION!**  
Chain saws are dangerous! Careless or improper use can result in serious or fatal injury.



Do not expose saw to rain or moisture.



Read operating instructions and make certain you understand them thoroughly before using the chain saw.

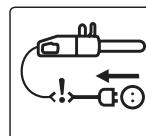

Disconnect power in case of damage to power cable.



Always use:

- Approved helmet
- Approved hearing protection
- Approved safety goggles or face mask

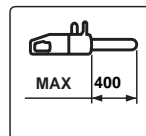

Maximum permissible guide bar length.



This product conforms to applicable CE directives.

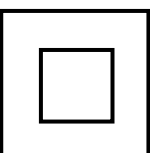

The chain saw is double-insulated.



Noise emission to the environment according to the European Community's Directive. The machine's emission is specified in «TECHNICAL SPECIFICATIONS» p. 3 and on label.

# CONTENTS

<b>Symbols</b>	<b>1</b>
<b>Contents</b>	<b>2</b>
<b>Technical specifications</b>	<b>3</b>
<b>Chain saw parts</b>	<b>4</b>
<b>EC declaration of conformity</b>	<b>5</b>
<b>Important! Read before using chain saw</b>	<b>5</b>
<b>Safe use</b>	<b>6</b>
<b>Kickback prevention</b>	<b>8</b>
<b>Chain brake with kickback guard</b>	<b>9</b>
- Brake band inspection	11
- Kickback guard inspection	11
- Manual chain brake function check	11
- Inertia chain brake function check	11
<b>Chain catcher</b>	<b>12</b>
<b>Right handguard</b>	<b>12</b>
<b>Slip clutch</b>	<b>12</b>
<b>Electronic overload protection 1800W</b>	<b>12</b>
<b>Mounting guide bar and adjusting chain</b>	<b>13</b>
<b>Cutting equipment</b>	<b>14</b>
<b>Chain and guide bar lubrication</b>	<b>15</b>
- Chain oil	15
- Filling chain oil	15
- Checking automatic chain lubrication system	15
- Checking chain wear	16
- Checking drive sprocket	16
<b>Starting and stopping</b>	<b>17</b>
<b>Filing chain</b>	<b>17</b>
<b>Crosscutting</b>	<b>19</b>
<b>Limbing</b>	<b>20</b>
<b>Felling operations</b>	<b>20</b>
- Danger zone	20
- Felling direction	20
- Clearing branches/Line of retreat	21
- Felling	21
<b>Daily inspection and maintenance</b>	<b>22</b>

# TECHNICAL SPECIFICATIONS

## Motor

		1500	1800
Rated voltage	VAC	220-240	230
Rated output	W	1500	1800
Frequency	Hz	50/60	50/60
Slip clutch		Yes	Yes
Electronic start control		-	Yes
Electronic speed control		-	Yes
Electronic overload protection		-	Yes

## Weight

	kg	3.8	3.8
Without guide bar and chain			
With 14" guide bar and chain	kg	4.4	4.4

## Chain lubrication

	litres	0.1	0.1
Oil tank volume			
Oil consumption	approx. litres	0.1/20 min.	0.1/20 min.
Oil pump		auto	auto

## Noise levels

Equivalent noise intensity at operator's ear, according to international standards	dB(A)	81	81

## Noise emissions

Sound power, measured	LW dB(A)	102	102
Sound power, guaranteed	LWA dB(A)	103	103

## Vibration

Front handle	m/s <sup>2</sup>	4.5	4.5
Rear handle	m/s <sup>2</sup>	7.0	7.0

## Chain/guide bar

Recommended bar length	inches/cm	12/30	12/30
	inches/cm	14/35	14/35
	inches/cm	16/40	16/40
Effective cutting length	inches/cm	12/30	12/30
	inches/cm	14/35	14/35
	inches/cm	16/40	16/40
Chain speed, unloaded	m/sec. (drive)	14 (6 tooth)	14 (6 tooth)
Chain speed, rated output	m/sec. (drive)	14 (6 tooth)	14 (6 tooth)
Chain pitch	inches	3/8"	3/8"
Gauge	inches/mm	.050"/1.3	.050"/1.3
Number of drive links	12"/14"/16"	45/52/56	45/52/56

inch	inch/mm	inch/mm	°	°	°	inch/mm	inch/cm/dl
S 36 3/8" Oregon 91Vg	.050/1,3	5/32" / 4,0	85°	30°	0°	.025/0,65	12"/30/45 14"/35/52 16"/40/56

# CHAIN SAW PARTS

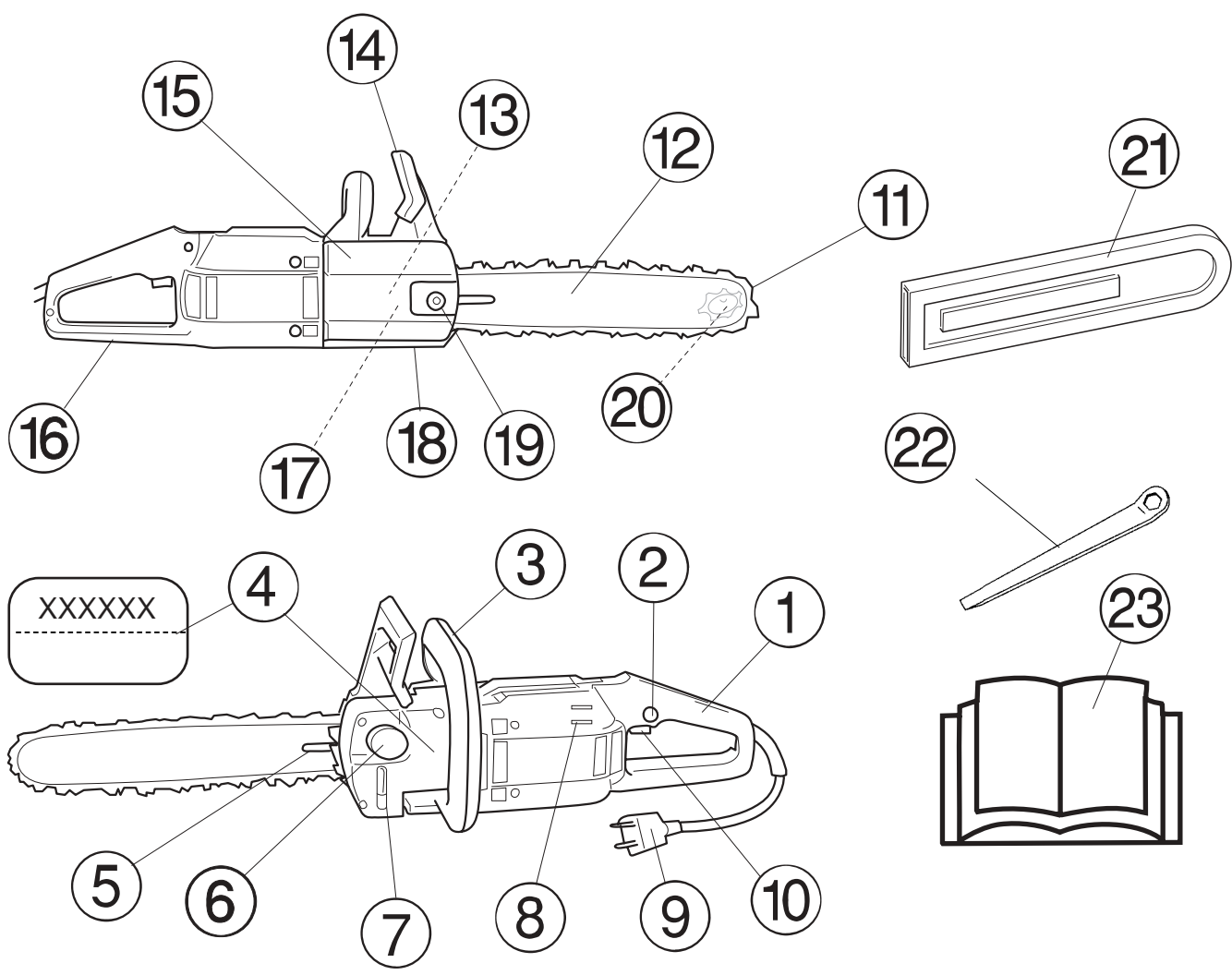

- 1. Rear handle
- 2. Power trigger lockout
- 3. Front handle
- 4. Serial No. plate
- 5. Chain tensioner
- 6. Chain oil reservoir
- 7. Chain oil level
- 8. Ventilation slots
- 9. Power cable
- 10. Power trigger
- 11. Chain
- 12. Guide bar
- 13. Chain brake inside chain drive cover
- 14. Kickback guard
- 15. Chain drive cover
- 16. Right handguard - protects right hand in case chain breaks or derails
- 17. Drive sprocket - concealed by chain drive cover
- 18. Chain catcher - deflects chain in case chain breaks or derails
- 19. Guide bar nut
- 20. Nose sprocket
- 21. Scabbard
- 22. Combination tool
- 23. Operator's manual

# EC DECLARATION OF CONFORMITY

## **(GB)** EC DECLARATION OF CONFORMITY

**Electrolux Motor AS**, N-1708 Sarpsborg, Norway hereby declares that the following chain saws:

- Husqvarna 315 Electric and Husqvarna 318 Electric, with serial numbers starting at 20100000,**
- are manufactured in compliance with EU Machine Directive 98/37/EC, EU directive 73/23/EEA (Low Voltage Directive), 89/336/EEC (Electromagnetic Compatibility), and 2000/14/EC (Noise Emission in the environment by equipment for use outdoors)
  - are manufactured in compliance with the following harmonized standards: EN 292-1-2, prEN 50144-2-13:96, HD 400.3 L S2, EN 55014-1:97, EN 55014-2:97, EN 61000-3-2:95 and EN 61000-3-3:95

Notified body 0404 SMP Svensk Maskinprovning AB, Fyrisborgsgatan 3, SE-754 50 Uppsala, Sweden, has:

- performed the type examination required by the third indent of Article 8(2)(c)
- issued EC type examination certificate No. **404/99/686 - Husqvarna 315 Electric and 404/99/687 - Husqvarna 318 Electric** pursuant to Directive 98/37/EC, Annex VI (4)

The chain saw submitted is identical to the samples submitted for EU type examination.

The measured and guaranteed sound power levels in accordance with Directive 2000/14/EC are set forth under Technical Data in the User's Manual.

Sarpsborg, 1 December 2001.

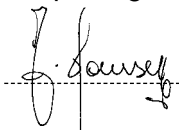

Jan Hansen, President

## **IMPORTANT! BEFORE USING CHAIN SAW**



### **CAUTION!**

**The chain saw must not be modified in any way under any circumstances without the permission of the manufacturer. Use only original accessories. Unauthorized modifications and/or accessories may cause serious or fatal injury of the operator or others.**

- Read operating instructions carefully.
- Always observe the «Safe Use» recommendations on page 6.
- Check chain and guide bar for correct assembly and adjustment.
- Start the saw.
- Do not start sawing until an adequate amount of oil has reached the chain.
- Incorrect chain tensioning increases wear on chain, sprocket and guide bar, and may result in damage to these parts.
- Improper use of power cable may lead to serious motor damage.

### **IMPORTANT!**

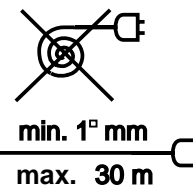

Do not use a coiled power cable!

Minimum wire cross-section: 1 mm<sup>2</sup>

Maximum cable length: 30 m

Voltage: 230 V

# SAFE USE



## CAUTION!

Never operate a chain saw with one hand only. Doing so may lead to a serious injury to operator, helpers or bystanders. An electric chain saw is designed for operation with both hands.



## DANGER!

Use of accessories not conforming to the recommendations outlined in the Operating Instructions could lead to injury.

- Dress safely. Avoid jewellery and loose-fitting clothing, which may be caught in moving parts. Approved safety mitts and sturdy footwear which gives a good footing are recommended (also for helpers).

Wear:

- Approved face mask or safety goggles
- Approved hearing protection
- Approved helmet
- Approved safety boots with protective reinforcement, steel toecap and non-slip soles
- Clothing which is snug without hampering movement
- Approved gloves with protective reinforcement

### Always keep a first-aid kit on hand!

- See to it that others keep their distance as long as the chain is in motion. Keep onlookers, children and animals away from the work area. Do not let inexperienced persons handle the chainsaw or power cable.
- Keep work area clear and well-lighted. Do not operate chain saw under wet or humid conditions, around water or in rain or snow. Ingress of moisture into the motor can cause short-circuiting.
- Show caution, care and common sense. Do not operate the chain saw when you are tired or under the influence of alcohol or drugs which may affect vision, judgement or physical control. Keep all body parts well away from the chain as long as the motor is running. Always ensure that the chain is not touching anything before starting the chain saw.
- Be on your guard against electric shock. Avoid touching metal objects imbedded in or in electrical contact with the ground.
- Do not abuse power cables. Never lift or carry the chain saw by the power cable, and never disconnect the power by jerking on the cable. Keep cable away from water, oil and sharp objects. Avoid crushing cable in or against doors, fences, or other metal objects which can conduct electricity.
- Inspect the chain saw and power cable before use. Do not use a chain saw with a damaged cable. it repaired by qualified service personnel. Keep handles clean, dry and free of grease and oil.
- See to it that all tools are removed from the chain saw before connecting the power.
- Ensure that the extension cord is in good condition and approved for outdoor use. It must be of sufficient dimension for the chain saw's rated power.  
See section «IMPORTANT! READ BEFORE USING CHAIN SAW» on page 5.
- When carrying the chain saw, stop the motor, keep your finger **AWAY** from the power trigger and turn the saw with the guide bar to the rear and pointing away from your body.
- Connect chain saw to a power supply equipped with a current-operated earth-fault protection device.

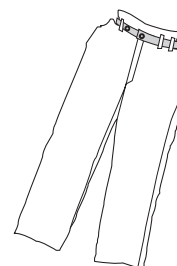

- **Double-insulated!** Your electric chain saw is double-insulated for added protection against electric shock. A double-insulated electric tool is designed with two separate «layers» of electrical insulation or one layer of insulation of double thickness between the operator and the tool's conducting parts. Double-insulated tools do not use earthed mains connections and may therefore be connected to any normal 220-240 VAC outlet. Observe the same precautions required with all electric tools. Double insulation gives added protection only against defective insulation.
- Tighten chain firmly but not so hard that it does not turn easily by hand.
- Use chain saw only on wood. Do not attempt to cut metal, plastic, masonry or any non-wood building materials. Do not use the guide bar to push away branches, roots or other objects.
- Ensure that you can move and stand safely at all times. Watch out for roots, stones, branches, holes, mounds and so forth when moving around. Be particularly careful when working on slopes. Work with the trunk to your right, keeping the log between you and the guide bar. Always grip your chain saw with both hands, holding it as close to your body as possible for best control. Wherever possible, let the log take the weight of the chain saw. Always keep the log between you and the guide bar when moving forward.
- Do not bear down hard when cutting. With the chain properly sharpened, light pressure is sufficient. Forcing the saw at the end of a cut can make you lose control when you break through.
- Secure short logs before sawing.
- Show particular care when cutting small branches, and avoid sawing bushes or many small branches at once. Small branches can get caught in the chain with a violent jerk and cause serious personal injury.
- We recommend limiting tree diameter to guide bar length so that the NOTCH and FELLING CUT may be done with single cuts.  
(See «Technical Specifications» for recommended guide bar lengths for your chain saw model).
- Disconnect power supply before servicing chain saw.
- Your chain saw complies with all relevant safety standards. Repairs should be performed only by qualified service personnel using only original parts.
- Examine saw closely for damaged parts before use to avoid malfunctions and to ensure safe and efficient operation. Verify that all moving parts are fitted and adjusted correctly. Except for the maintenance described in this operator's manual, damaged parts must be replaced at an authorized service centre. Defective power triggers are to be replaced by authorized service personnel. Do not operate the saw if the power trigger does not work properly.
- Store the chain saw in a safe, dry place out of the reach of children, with the power disconnected and the guide bar scabbard in place.

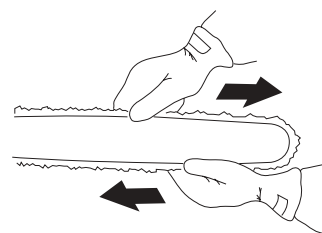



# KICKBACK PREVENTION



## DANGER!

Kickbacks occur suddenly and without warning. A kickback may be violent enough to throw a chainsaw back at the user. A running chain can inflict severe and even fatal injury. It is imperative for users to be familiar with the causes of kickbacks in order to exercise the proper care and use working techniques to prevent kickback.



## CAUTION!

Improperly sharpened cutters or the wrong chain and guide bar combination will increase the risk of kickback.

See «Technical Specifications» on page 3.



## CAUTION!

Do not let the chain come in contact with the ground or any objects.

Chain link and wire fencing materials present a particular kickback hazard.

Observe all safety rules in order to avoid kickbacks and other accidents which may cause injury.

- A kickback is a sudden reaction in which a chain saw is thrown back as a result from contact with the upper part of the bar nose known as the kickback danger zone.
- The direction of a kickback is always in the same plane as the guide bar. The most common reaction is that the guide bar and saw are thrown up and back towards the operator. The saw can be thrown in other directions, too, however, depending on the position of the saw at the moment of kickback.

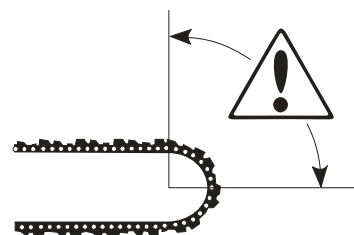

## Basic rules

- Knowing the cause and nature of a kickback helps reduce or eliminate the element of surprise. Surprise increases the danger of an accident. Most kickbacks are small, but some are violent, and all are lightning-fast.
- Always grip the chain saw firmly with thumb and fingers wrapped around the handles, right hand on the rear handle and left hand on the front handle. All users, whether right or left-handed, must use this grip, which will reduce the effect of a kickback and help keep the saw under control.

**Do not let go of the chain saw handles!**

- Most accidents caused by kickbacks take place in connection with limbing. Make certain your footing is secure and that there are no objects nearby which may trip you or make you lose your balance. If you are not careful, the kickback danger zone could make contact with a branch, a nearby tree or some other object which could cause a kickback.
- Never use a chain saw to cut above shoulder height, and do not cut with the guide bar nose.

**Never operate a chain saw while holding it with only one hand!**

- Maintain full speed while cutting.
- Take extreme care when cutting with the top chain (on the underside of a log). The force of the chain action pushes the saw backwards, and if the operator does not maintain firm control, the kickback danger zone may move far enough back into the kerf to produce a kickback. Cutting with the bottom chain (on the top side of the log) pulls the saw forward. This presses the power head firmly against the tree, providing a steady support and giving the operator added control over the saw and consequently over the kickback danger zone.
- Follow the maintenance and sharpening instructions for the chain and guide bar. When replacing chains and guide bars, use only combinations recommended by us. See «Technical Specifications».
- The smaller the bar nose radius, the smaller the kickback danger zone and thus the kickback tendency.
- By using low-kickback cutting equipment and keeping the cutters properly sharpened, the strength of a kickback can be greatly reduced.

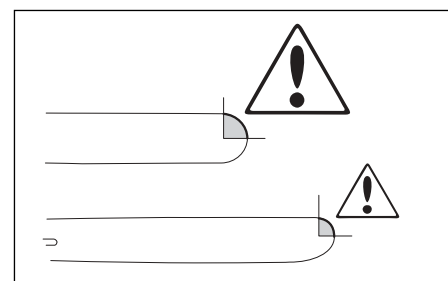
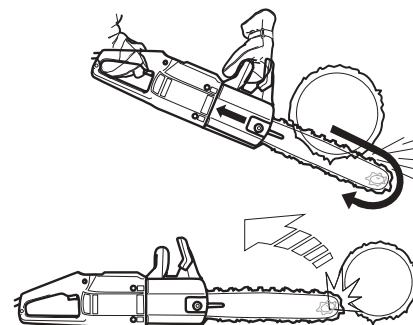

## CHAIN BRAKE WITH KICKBACK GUARD

Your chain saw is equipped with a chain brake designed to stop the chain instantaneously in the event of a kickback. A chain brake can reduce the risk of accident, but only the operator can prevent accidents from happening.

Be extremely careful when operating a chain saw and do not allow the kickback danger zone to make contact with anything.

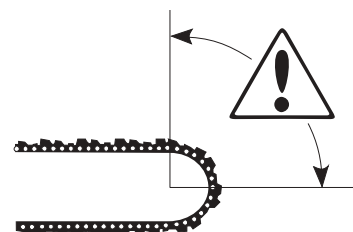

- The chain brake (A) is activated either manually (with the left hand) or by the force of inertia (the inertia of the kickback guard resisting the motion of the saw from the force of the kickback). However it is activated, the kickback protection mechanism works in the opposite direction to the force of the kickback. The saw incorporates a slip clutch which protects the saw against overload. If the chain stops while the motor is running, the saw is overloaded. Ease up on the cutting pressure until the chain starts running again. If the saw jams in the tree, stop the saw immediately and free it.

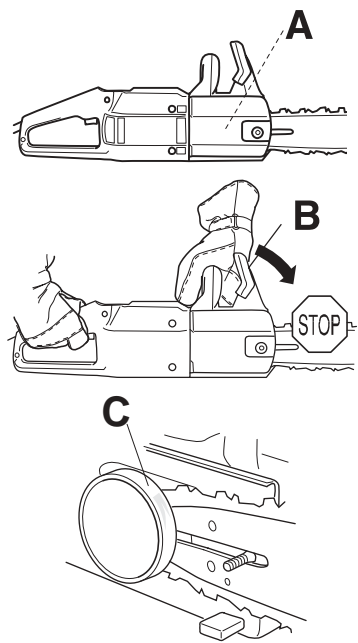

- The chain brake is also activated when the kickback guard (B) is pushed forward. This releases a springloaded mechanism which jerks the brake band tightly around the clutch drum (C), which in this case also acts as a brake drum.
- The purpose of the kickback guard is not only to activate the chain brake. Its other important function is to reduce the danger of contact with the chain in the event that the operator loses his grip on the front handle.
- Use the chain brake as a «parking brake» when carrying the chain saw around or putting it down for short periods! Besides automatic activation in the event of a kickback, the chain brake may also be activated manually and must be activated in the event of any inadvertent contact with a rotating chain.
- An activated chain brake is released by pulling the kickback guard back towards the front handle.
- As pointed out on page 9, a kickback can be extremely violent and lightning-fast. **Most kickbacks are small and do not activate the chain brake. When this happens, it is important to maintain a firm grip on the saw and not let go.**
- The chain brake may be activated manually or by the force of inertia depending on the strength of the kickback and the position of the saw in relation to the object which made contact with the kickback danger zone.
  - If the kickback is sufficiently violent and the left hand is too far from the kickback guard, the chain brake is activated by the INERTIA of the chain brake against the force of the kickback.
  - In the event of smaller kickbacks or when the left hand is near the kickback guard, the chain brake is activated manually with the left hand.
- When the chain saw is turned on its side and the operator is holding the side of the front handle, the kickback guard will not strike the left hand in the event of a kickback and will thus not activate the chain brake. In a situation of this type, inertia is the only thing that can activate the chain brake, but like manual activation, it will not work in every situation.

## Brake band inspection

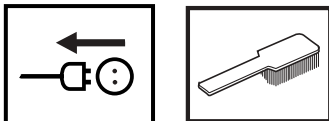

- Clean sawdust, pitch, and debris from the chain brake and clutch drum. Wear and debris both affect brake function.
- Inspect the brake band regularly, ensuring that it is nowhere less than 0.6 mm thick

## Kickback guard inspection

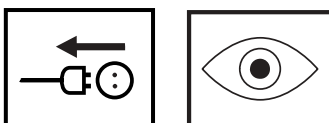

- Inspect kickback guard for visible defects, such as cracks.
- Move kickback guard back and forth to ensure that it moves freely without being loose.

## Manual chain brake function check

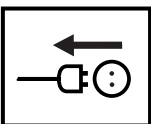

- Check chain brake daily or every time the saw is used. Holding the running saw firmly with the left hand on the front handle and the right hand on the rear handle, twist your left wrist, pushing the kickback guard to activate the chain brake without letting go of the front handle. The chain should stop instantaneously.

**If the chain brake does not perform as required, have it serviced by authorized personnel.**

## Inertia chain brake function check

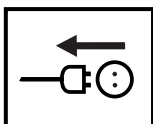

- Hold the running saw level with the guide bar approximately 45 cm above a stump or other solid wooden object.

**Release the power trigger.**

- Release the front handle, letting the chain saw pivot in your right hand as the guide bar falls down and strikes the stump. The brake should activate when the bar nose hits the stump.

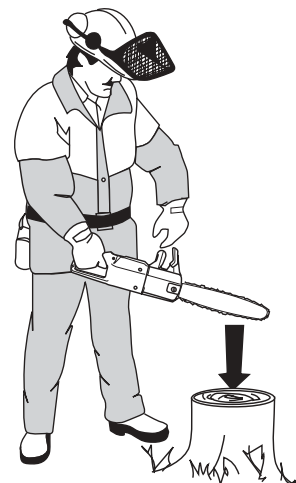

## CHAIN CATCHER

The chain catcher is designed to catch a chain which breaks or jumps out of its groove. This problem will generally be avoided, however, if the chain is tensioned properly (see chapter on «Assembly and Adjustment of Guide Bar and Chain») and the chain and guide bar properly maintained.

Ensure that the CHAIN CATCHER is undamaged.

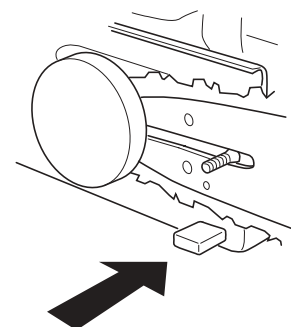

## RIGHT HANDGUARD

The right handguard protects the right hand in the event that the chain breaks or jumps out of its groove, as well as keeping twigs and branches from interfering with your grip on the handle.

Ensure that the RIGHT HANDGUARD is undamaged.

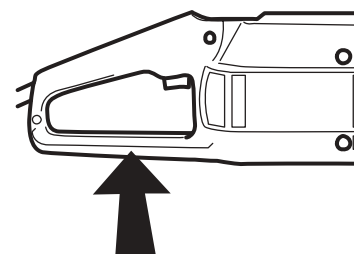

## SLIP CLUTCH

Your chain saw features a slip clutch which protects it from overload.

The slip clutch may require cleaning after long periods of operation.

Contact your nearest service dealer in the event of malfunction.

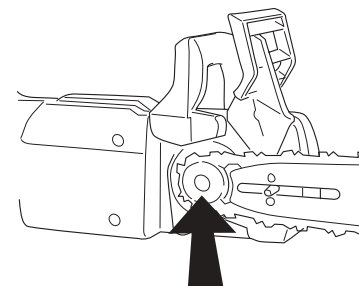

## ELECTRONIC OVERLOAD PROTECTION 1800W

The 1800W electric chain saw is provided with electronic overload protection.

- When the overload protection trips, the saw stops.
- Release the power trigger. Ensure that the chain is not stuck.
- Squeeze the power trigger again.

# MOUNTING GUIDE BAR AND ADJUSTING CHAIN



**CAUTION!**  
Always wear gloves when handling chain.



**CAUTION!**  
A loose chain can jump out of its groove during operation and cause serious or even fatal injury.

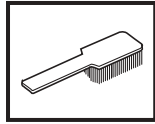
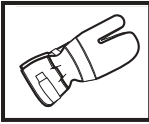
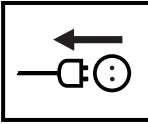

1. Pull kickback guard back against the front handle to ensure that the chain brake is not applied.

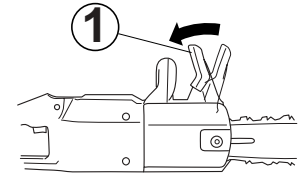

2. Screw out the guide bar nut and remove the chain drive cover.

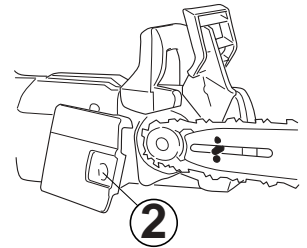

3. Fit the chain around guide bar nose with the top cutters facing forwards.

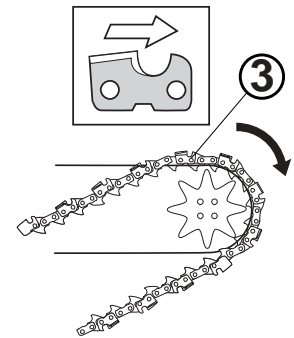

4. Holding the chain over the guide bar nose, position the back end of the guide bar against the drive sprocket at a 45° angle to the power head. Pass the free end of the chain around the drive sprocket, swing the guide bar into place over the mounting bolt and against the power head, and guide the chain into the guide bar groove.

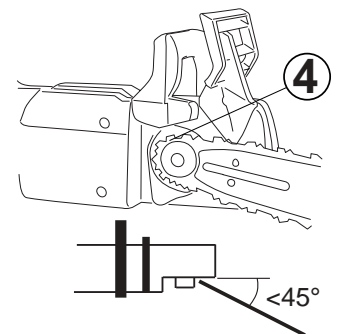

5. Seat the guide bar tensioner pin in its hole in the guide bar.

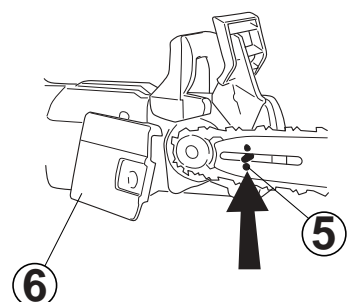

6. Replace the chain drive cover and screw the mounting nut hand tight.

7. Tension the chain by screwing the tensioning screw clockwise using the screwdriver tip on the combination tool.

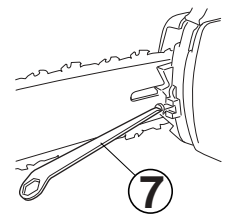

8. The chain is correctly tensioned when the slack on the bottom of the bar is gone, yet the chain is still easily pulled around by hand.

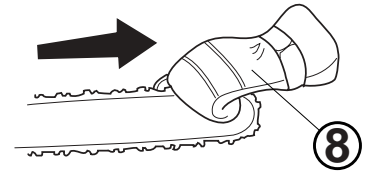

9. Tighten the mounting nut with the combination tool while holding the tip of the guide bar up.

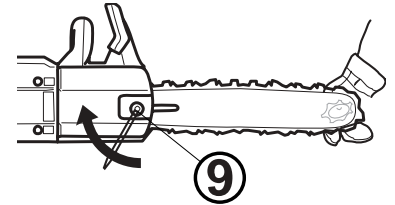

The tension of a new chain must be checked frequently until it is broken in.

Continue to check the tension at regular intervals to ensure good performance and a long service life.

- Wear causes a chain to become looser with use. Regular tensioning is important to compensate for this wear.
- Check the chain tension at least every time you refill the chain oil reservoir.

## CUTTING EQUIPMENT

This section explains how correct maintenance and use of the right cutting equipment:

- **Reduces kickback tendencies.**
- **Reduces the frequency of chain derailing and breakage.**
- **Achieves maximum cutting effect.**
- **Increases the service life of the chain.**

### The five basic rules

- **Use only the recommended cutting equipment!**  
See «Technical Specifications» on page 3.
- **Ensure that the cutter teeth are always correctly sharpened! Follow our instructions and use the recommended filing guide.** A chain which is damaged or improperly maintained increases the risk of accident.
- **Maintain the correct depth-gauge height.**  
Worn depth gauges increase the risk of kickback.

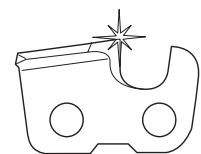
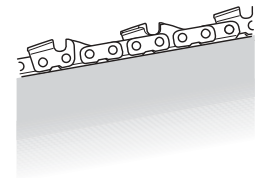

- **Keep chain properly tensioned!**

A loose chain derails more easily and accelerates wear on guide bar, chain and drive socket.

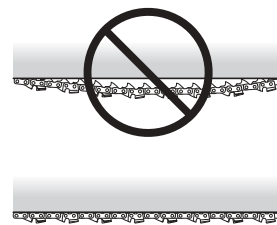

- **Ensure that the automatic oiling system works and that the cutting equipment is properly maintained.**

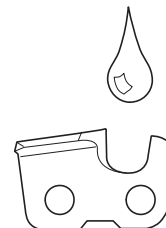

## CHAIN AND GUIDE BAR LUBRICATION



### CAUTION!

Inadequate lubrication can lead to cutting equipment failure and serious or fatal personal injury.

### Chain oil

- The chain and bar are lubricated by an automatic oiling system. We recommend using only chain saw oil, which is formulated for good adhesion and flow characteristics in hot or cold weather. Nonetheless, it is important to use the viscosity appropriate to the season. Oil thickens in subfreezing temperatures and can overload the oil pump and cause parts to fail.
- As a manufacturer of chain saws, we have developed an ideal chain oil which, being based on vegetable oils, is completely biodegradable. We recommend our oil for the sake of your chain and guidebar and for the sake of the environment.
- Where chain oil is not available, EP 90 gear oil may be used.
- If you need help choosing chain oil, contact your service dealer.
- **Never use old motor oil!**  
Used motor oil contains impurities which may be harmful to oil pump, guide bar and chain.

### Filling chain oil

- All our chain saw models feature automatic chain lubrication.

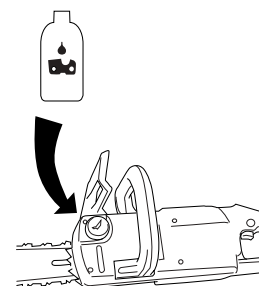

### Checking automatic chain lubrication system

- Start the chain saw and point the guide bar towards a fixed, light-coloured object at a distance of approximately 20 cm. After running the saw for a minute, a streak of oil spatter should be clearly visible on the light surface.
- A full reservoir is sufficient for 20 minutes of steady use.





• If the lubrication system does not seem to be working, and the following steps do not help, **take your saw to a service dealer.**

- Check the guide bar's oil passage and clean if necessary.

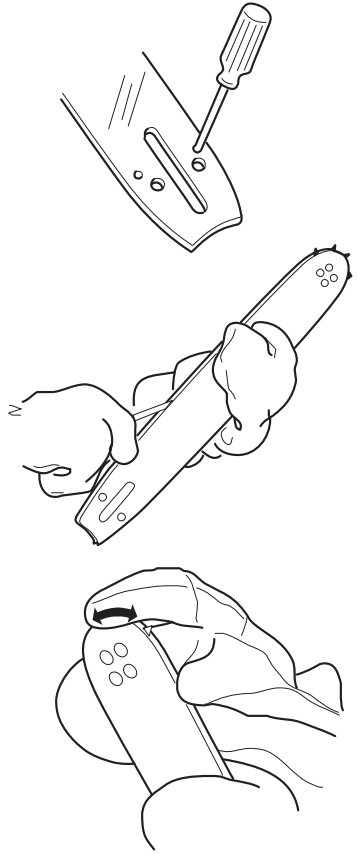

- Check guide bar groove and clean if necessary.

- Ensure that the nose sprocket turns easily and is not clogged. Clean and grease if necessary.

### Checking chain wear

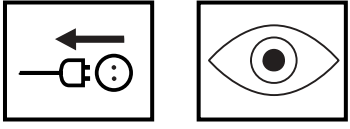

• Inspect chain every day for:

- Visible cracks in rivets or links.
- Stiffness.
- Abnormal wear in rivets or links.
- Min. 3 mm (1/8") horizontal cutter length.
- Any deviation on any of these points indicates a worn chain which must be discarded.

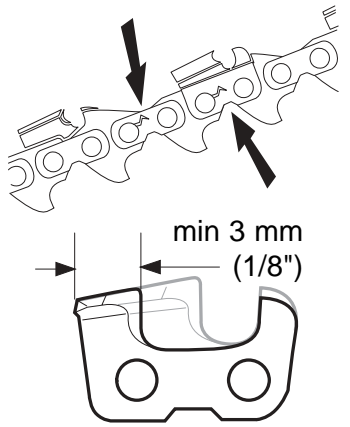

### Checking drive sprocket

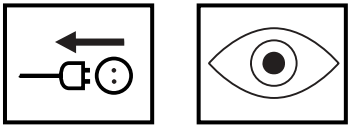

• Check drive sprocket wear regularly and replace when wear becomes excessive.

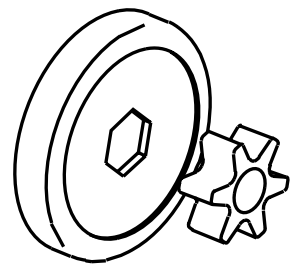

# STARTING AND STOPPING



## CAUTION!

- Make certain at all times that your footing is secure and that the chain touches nothing but the wood you are cutting.
- Keep bystanders away from your work area.

## Starting

- Grip the front handle firmly with your left hand.
- Grip the rear handle firmly with your right hand.
- Press and hold the power trigger lockout button with your right thumb and squeeze the power trigger with your index finger.

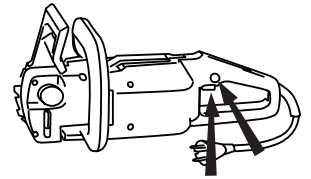
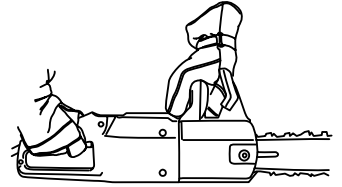

## Stopping

Stop the saw by releasing the power trigger. If the saw does not stop, trip the chain brake and disconnect the power cable.

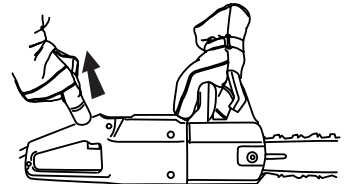

# FILING CHAIN



## CAUTION!

Improperly filed cutters heighten kickback tendencies!

## General instructions regarding cutters

- Never cut wood using a dull chain. Having to press hard is a sure sign of a dull chain, as are very small chips. A very dull chain will produce sawdust rather than chips.
- A sharp chain will produce large chips, and the saw will feed itself through the wood.
- The part of the chain that saws is called the CUTTING LINK, which consists of a CUTTER (A) and DEPTH GAUGE (B). The difference in height between them determines the depth of the cut.

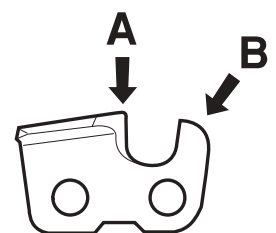
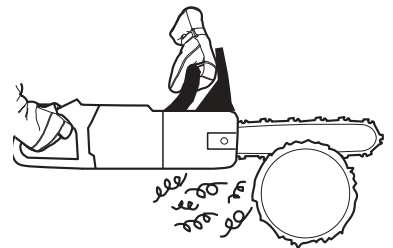

- When filing a saw, pay close attention to:

TOP-PLATE ANGLE

CUTTING ANGLE

HORIZONTAL FILE ANGLE

FILE DIAMETER

FILE DEPTH

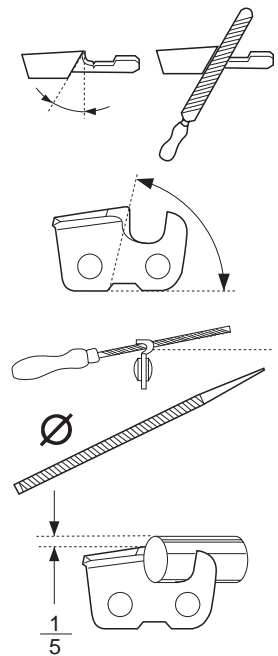

See «Technical Specifications» for the details which apply to your chain.

It is very difficult to file a chain saw correctly without the proper aids. We recommend the use of a file guide to ensure maximum cutting efficiency with the least tendency to kickback.

### Filing cutters

To file cutters correctly, a ROUND FILE and a FILE GUIDE are required. Look under «Technical Specifications» for the correct file diameter and file guide for your saw and chain.

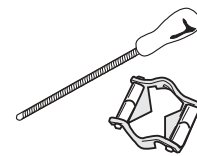

- File only with the chain properly tensioned. A loose chain wiggles, making it difficult to file.



- Always file from the inside of each cutter towards the outside. Lift the file on the return stroke.
- File the cutters on one side first. Then turn the saw around and file the cutters on the other side.

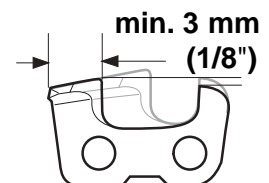
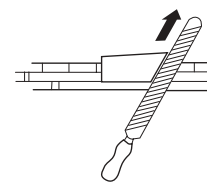

- Make certain that all cutters are of equal length. When the horizontal length is down to 3 mm (1/8"), the chain is worn out and must be discarded.

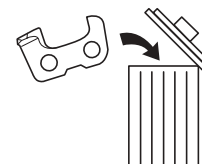

# CROSSCUTTING



## CAUTION!

If the chain becomes stuck in the kerf, **STOP THE SAW!**

Do not attempt to jerk the saw free. You could be harmed by the chain if the saw suddenly comes loose. Lever the saw free instead.

- Cutting a log on the ground. There is little danger of the saw jamming or the log splintering, but it is difficult to avoid running the saw into the ground when breaking through at the end of the cut.

Saw straight through the log. Be careful at the end of the cut to avoid contact with the ground. Keep the saw running at full speed, but be prepared for the breakthrough.

- If it is possible to turn the log, stop cutting 2/3 of the way through the log.

- Turn the log and cut the remaining section from above.

- Cutting a log supported at one end. The log is more than likely to splinter if cut straight through from the top down.

- Make an initial cut from below (approx. 1/3 of the diameter).

- Finish the cut from above.

- Cutting a log supported at both ends. The saw is more than likely to jam in the kerf if cut straight through from above.

- Make an initial cut from the top (approx. 1/3 of the diameter).

- Finish the cut from below.

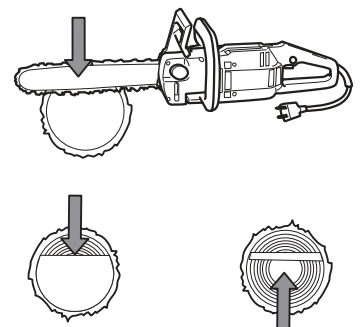
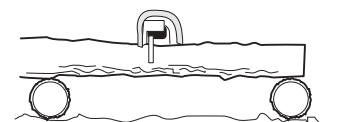
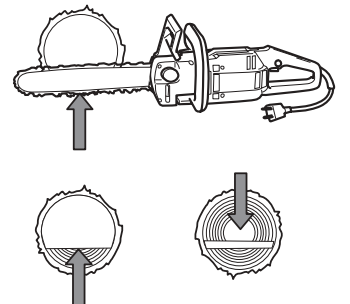
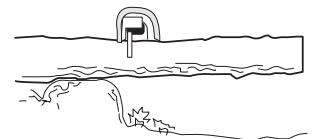
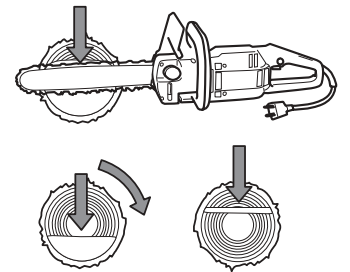
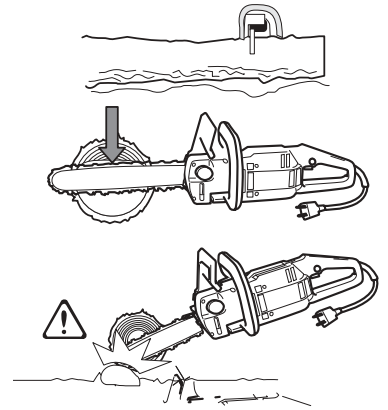

# LIMBING



## CAUTION!

Most kickback accidents take place when limbing. Pay very close attention to the kickback danger zone when cutting limbs under tension!

All the principles which apply to crosscutting also apply when cutting thick branches.

Cut complicated branches in several stages.

Ensure that your footing is secure at all times, whether moving about or standing in one place. Always work with the log to your right. For best control, hold the chain saw as close to your body as possible.

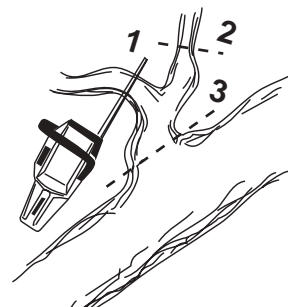

# FELLING OPERATIONS



## CAUTION!

Felling a tree is a job which calls for experience. Do not attempt to fell trees if you are inexperienced. DO NOT CARRY OUT ANY OPERATIONS FOR WHICH YOU DO NOT FEEL QUALIFIED!



## CAUTION!

Beginning chain saw operators should gain experience cutting logs on a sawhorse or similar arrangement.



## CAUTION!

We advise operators without sufficient experience against felling trees with trunk diameters exceeding their guide bar length.

## Danger zone

A danger zone surrounds the tree to a distance of 2 1/2 times the height of the tree. See to it that no one is standing within this zone while you are felling the tree.

## Felling direction

When felling a tree, one always aims to place it where neither objects nor difficult terrain will hamper limbing and cutting. Unobstructed movement and secure footing are essential.

It is also important to avoid lodging the tree against another tree. A lodged tree is extremely dangerous.

After determining where you want the tree to fall, you must also consider the likely unaided direction of fall.

This is affected by the straightness and lean of the tree, wind direction, concentration of branches and any snow that may weigh the tree down.

After assessing all these factors, you may find you have no choice but to fell the tree in its natural direction of fall because your preferred direction of fall is likely to fail.

Another important factor affecting your personal safety, though it has no bearing on the direction of fall, is the presence of any dead branches which could fall while you are felling the tree.

## Clearing branches/Line of retreat

Remove any branches from around the base of the tree which may interfere with your work. It is safest to work from the top down and to keep the tree trunk between you and the running chain. Never cut branches above shoulder height. Clear undergrowth around the tree and identify your line of retreat or escape, taking note of any obstructions (stones, branches, holes, etc.). Your line of retreat should be at an angle, around 135° behind the direction of fall.

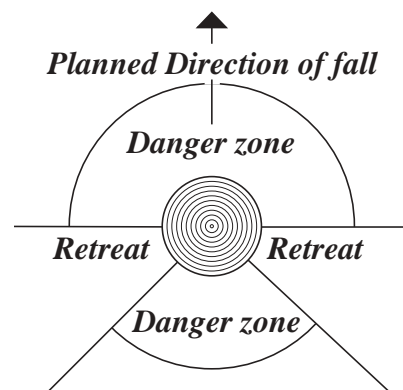

## Felling

Three cuts are made to fell a tree. The «TOP NOTCH CUT» and the «BOTTOM» or «HORIZONTAL NOTCH CUT» form the «NOTCH», which determines the direction in which the tree will fall. The final cut is the «FELLING CUT», which allows the tree to topple over.

### Notch

To form the NOTCH, start with the TOP NOTCH CUT. Using the bottom of the guide bar (pulling chain), make a 45° downward angled cut at right angles to the intended direction of fall.

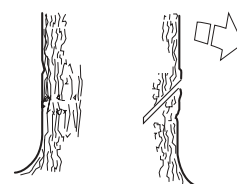

Next do the BOTTOM NOTCH CUT, ensuring that it meets the bottom of the TOP NOTCH CUT precisely.

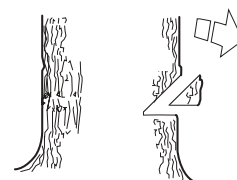

Notch depth should be around 1/4 of the diameter of the tree and the angle should be around 45°.

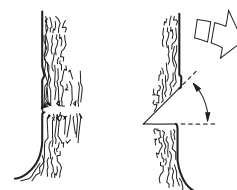

The line defined by the inside angle of the notch must be precisely horizontal and at a precise right angle to the direction of fall.

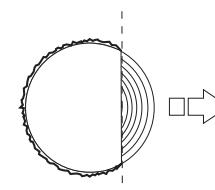

### Felling cut

The felling cut is done from the opposite side of the tree and must also be horizontal. Stand with the tree to your left and cut with the bottom of the guide bar (pulling chain).

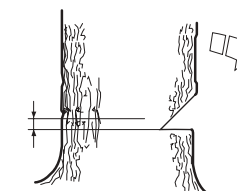

Place the FELLING CUT approximately 3-5 cm (1 1/2 - 2") above the BOTTOM NOTCH CUT.

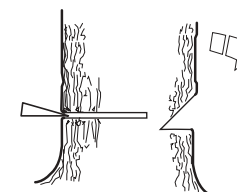

Cut at full motor speed, feeding the saw slowly into the tree. Watch out for tree movement opposite to the intended direction of fall. Insert a WEDGE or FELLING BAR in the FELLING CUT as soon as the depth of the cut permits.

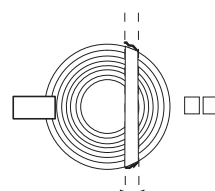

When complete, the FELLING CUT must be parallel to the notch and leave a strip of HINGE WOOD at least 1/10 the diameter of the tree.

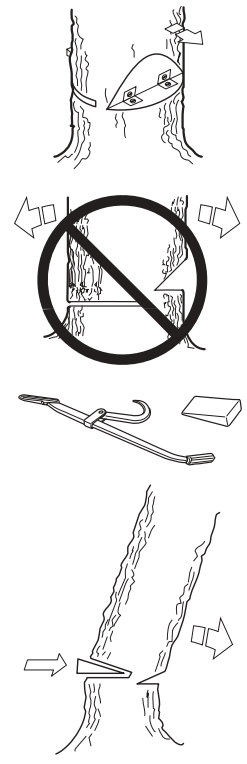

The HINGE WOOD acts as a hinge, steering the direction of the falling tree.

If the HINGE WOOD is too small or has been sawn through, or if the notch and the felling cut are mismatched, the tree is no longer under control.

As the felling cut approaches the notch, the tree should start falling, either by itself or with the help of a WEDGE or FELLING BAR.

# DAILY INSPECTION AND MAINTENANCE



**CAUTION!**  
Always disconnect the power before cleaning or performing maintenance.

Here are a few general instructions for main-taining your chain saw. If you are in doubt on any of these points, contact your service dealer.

1. Inspect power cable and plug for defects.  
A damaged power cable or plug must be replaced.
2. Clean ventilation openings and keep them open.
3. Clean the chain brake and ensure that it works correctly.
4. Check automatic chain lubrication.
5. Turn guide bar over at regular intervals to distribute the wear on both sides. Check to see that the oil passage is clear. Clean the guide bar groove.
6. Check chain tension, sharpen the cutters and ensure that chain turns easily.
7. Check drive sprocket for abnormal wear, replacing it if necessary.
8. Remove any burrs from the edges of the guide bar

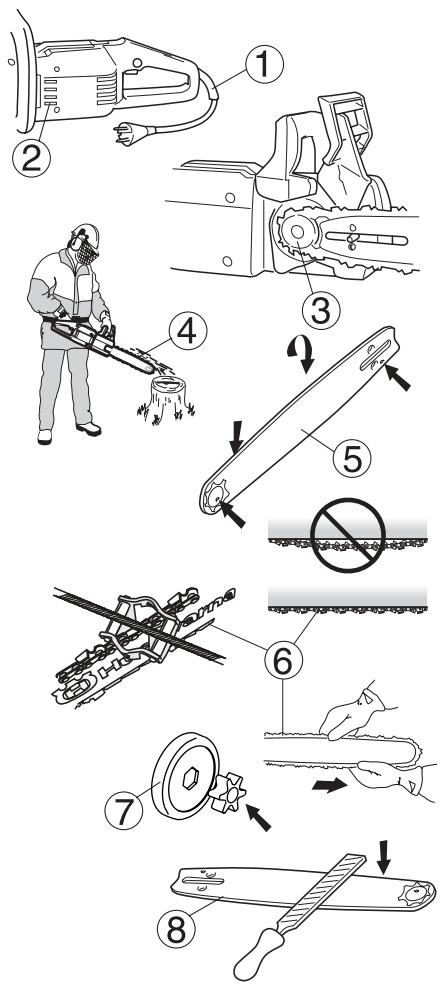



---

**ELECTROLUX MOTOR AS**

**Trøskenveien 36  
P.O.B. 10  
N - 1708 Sarpsborg  
Norway**



## Free Manuals Download Website

<http://myh66.com>

<http://usermanuals.us>

<http://www.somanuals.com>

<http://www.4manuals.cc>

<http://www.manual-lib.com>

<http://www.404manual.com>

<http://www.luxmanual.com>

<http://aubethermostatmanual.com>

Golf course search by state

<http://golfingnear.com>

Email search by domain

<http://emailbydomain.com>

Auto manuals search

<http://auto.somanuals.com>

TV manuals search

<http://tv.somanuals.com>