



Husqvarna®



**HUSQVARNA AUTOMOWER®  
230 ACX/220 AC  
OPERATOR'S MANUAL**





# TABLE OF CONTENTS

<b>1. Introduction and safety</b> .....	5
1.1 Introduction .....	5
1.2 Symbols on Automower® .....	6
1.3 Symbols in the Operator's Manual .....	7
1.4 Safety instructions .....	8
<b>2. Presentation</b> .....	10
2.1 Automower®, what's what? .....	11
2.2 Function of Automower® .....	12
2.3 Search method .....	15
2.4 More than one Automower® in a garden .....	16
2.5 One Automower® in several gardens .....	16
<b>3. Installation</b> .....	17
3.1 Preparations .....	17
3.2 Installation of the charging station .....	18
3.3 Charging the battery .....	21
3.4 Installation of the boundary wire .....	21
3.5 Connecting the boundary wire .....	29
3.6 Checking the installation .....	31
3.7 Linking Automower® to the charging station .....	31
3.8 Installation of the guide wire .....	32
<b>4. Use</b> .....	37
4.1 Charging a discharged battery .....	37
4.2 Using the timer .....	38
4.3 Starting Automower® .....	38
4.4 Stopping Automower® .....	38
4.5 Restart .....	39
4.6 Switching off Automower® .....	39
4.7 Adjusting the cutting height .....	40
<b>5. Control panel</b> .....	41
5.1 Shortcuts .....	42
5.2 Programs .....	43
5.3 Select .....	43
5.4 Numbers .....	44
5.5 Main switch .....	44
<b>6. Menu functions</b> .....	45
6.1 Main menu .....	45
6.2 Automower® main menu, menu overview .....	46
6.3 Commands (1) .....	47
6.4 Timer (2) .....	47
6.5 Installation (3) .....	49
6.6 Settings (4) .....	57
<b>7. Garden example</b> .....	61
<b>8. Maintenance</b> .....	66
8.1 Battery .....	66
8.2 Winter storage .....	67
8.3 Service .....	68
8.4 After winter storage .....	68
8.5 Cleaning .....	68
8.6 Replacing the blades .....	70
8.7 In the event of a thunderstorm .....	71
8.8 Transport and moving .....	71
<b>9. Trouble shooting</b> .....	72
9.1 Fault messages .....	72
9.2 Fault symptom .....	74
<b>10. Technical data</b> .....	75
<b>11. Guarantee terms</b> .....	76
<b>12. Environmental information</b> .....	77
12.1 Removing the battery for recycling .....	77

---

# TABLE OF CONTENTS

---

Husqvarna AB has a policy of continuous product development and therefore reserves the right to modify the design and appearance and function of products without prior notice.



---

# 1. INTRODUCTION AND SAFETY

---

## 1. Introduction and safety

### 1.1 Introduction

Congratulations on your choice of an exceptionally high quality product. To get the best results from your Husqvarna Automower® requires knowledge of its function. This Operator's manual contains important information about the mower, how you install it and how you use it.

The following system is used in the Operator's manual to make this easier:

- Text written in *italics* is a text that is shown on the mower's display or is a reference to another section of the Operator's manual.
- Words written in **bold** are one of the buttons on the mower's keypad.
- Words written in *UPPERCASE* and *italics* refer to the position of the main switch and the different operating modes on the mower.

#### IMPORTANT INFORMATION

Read through the Operator's Manual carefully and understand the content before using your Automower®.



#### WARNING

Automower® can be dangerous if incorrectly used.



#### WARNING

Never use the robotic lawnmower when persons, especially children, or pets, are in the cutting area.

# 1. INTRODUCTION AND SAFETY

## 1.2 Symbols on Automower®

These symbols can be found on the lawn mower. Study them carefully so you understand their significance.

- Read through the Operator's Manual carefully and understand the content before using your Automower®.
- The warnings and safety instructions in this Operator's Manual must be carefully followed if the mower is to be used safely and efficiently.
- Automower® can only start when the main switch is moved to the *ON* position and the correct PIN code has been entered. Inspection and/or maintenance must be carried out with the main switch set to *OFF*.
- Keep your hands and feet away from the rotating blades. Never place your hands or feet close to or under the body when Automower® is in operation.
- Do not ride on Automower®.
- Noise emission to surroundings. The machine's emission is specified in chapter Technical data and on label.
- This product must be left at an appropriate recycling station.
- Never use running water to clean the robotic lawn mower.

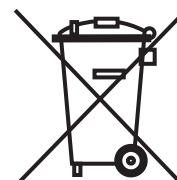
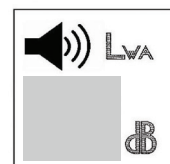
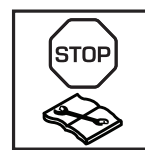

**Other symbols/decals on the machine refer to special certification requirements for certain markets.**

# 1. INTRODUCTION AND SAFETY

- The low voltage cable must not be shortened, extended or spliced.
- Do not use a trimmer nearby the low voltage cable. Be careful when trimming edges where the cables are placed.



## 1.3 Symbols in the Operator's Manual

These symbols can be found in the Operator's Manual. Study them carefully so you understand their significance.

- Inspection and/or maintenance must be carried out with the main switch set to *OFF*.



- Always wear protective gloves when working with the mower's underframe.



- Never use a high-pressure washer or even running water to clean Automower®.

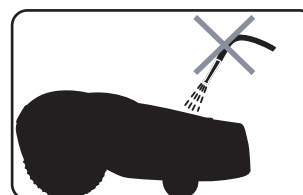

- A warning box indicates a risk of personal injury exist, especially when the stated instructions are not followed.

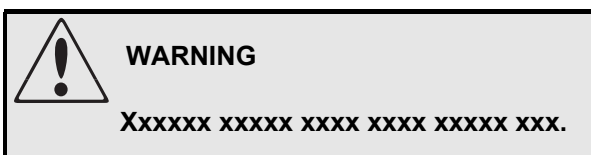

- An information box indicates a risk of material damage exist, especially when the stated instructions are not followed. The box is also used where there is a risk of user error.

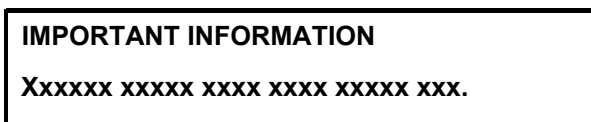

# 1. INTRODUCTION AND SAFETY

## 1.4 Safety instructions

### Use

- Please read the Operator's Manual carefully and make sure you understand the instructions before using Automower®.
- Never use the robotic lawnmower when persons, especially children, or pets, are in the cutting area. If there are persons, or pets, in the cutting area it is recommended that the lawnmower be programmed for use during hours when the area is free from persons, e.g. at night. See *6.4 Timer (2)*.
- It is not permitted to modify the original design of Automower®. All modifications are made at your own risk.
- Check that there are no stones, branches, tools, toys or other objects on the lawn that can damage the blades and cause the mower to stop.
- Start Automower® according to the instructions. When the main switch is in the *ON* position; make sure you keep your hands and feet away from the rotating blades. Never put your hands and feet under the mower.
- Never lift up Automower® or carry it around when the main switch is in the *ON* position.
- Do not let persons who do not know how Automower® works and behaves use the mower.
- The robotic lawnmower must never be allowed to collide with persons or other living creatures. If a person or other living creature comes in the lawnmower's way it shall be stopped immediately. See *4.4 Stopping Automower®*.
- Do not put anything on top of Automower® or its charging station.
- Do not allow Automower® to be used with a defective blade disc or body. Neither should it be used with defective blades, screws, nuts or cables.
- Do not use Automower® if the main switch does not work.
- Always switch off Automower® using the main switch when you do not intend to use the mower. Automower® can only start when the main switch is moved to the *ON* position and the correct PIN code has been entered.
- Automower® must never be used at the same time as a sprinkler. In this case use the timer function, see *6.4 Timer (2)* on page 47, so the mower and sprinkler never run simultaneously.

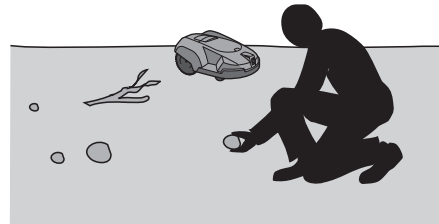



# 1. INTRODUCTION AND SAFETY

- Husqvarna AB does not guarantee full compatibility between Automower® and other types of wireless systems such as remote controls, radio transmitters, buried electric animal fencing or similar.
- The built-in alarm is very loud. Be careful, especially if the robotic lawnmower is handled indoors.

## Transport

The original packaging should be used when transporting Automower® over long distances.

To safely move from or within the working area:

1. Press the **STOP** button to stop the mower.  
If the anti-theft alarm (see page 58) is activated; enter the first digit of the PIN code.  
You select the four digit PIN code when you start the mower for the first time, see page 31.
2. Move the main switch to the *OFF* position if you intend to carry the mower.
3. Carry the mower by the handle at the rear under the mower. Carry the mower with the blade disc away from the body.

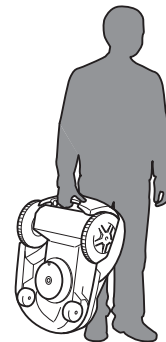
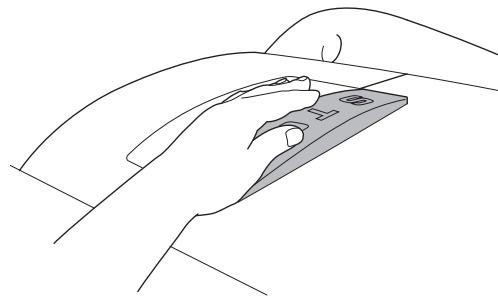

## Maintenance



### WARNING

When the mower is turned upside down the main switch must always be set to the *OFF* position.

The main switch should be set to the *OFF* position during all work on the mower's underframe, such as cleaning or replacing the blades.

ON  
▲  
▼  
OFF



- Inspect Automower® each week and replace any damaged or worn parts.  
Check especially that the blades and blade disc are not damaged. Replace all blades and screws at the same time if necessary so that the rotating parts are balanced, see 8. *Maintenance* on page 66.

## 2. PRESENTATION

### 2. Presentation

This chapter contains information you should be aware of when planning the installation.

An installation of Husqvarna Automower® includes four main components:

Automower®, an automatic lawn mower that mows the lawn by moving in essentially an irregular pattern. The mower is powered by a maintenance-free battery.

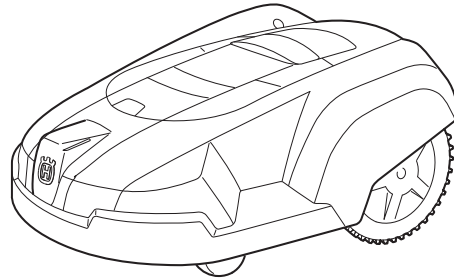

Charging station, where your Automower® returns when the charge level in the battery becomes too low.

The charging station has three functions:

- To send control signals along the boundary wire.
- To send out signals so Automower® finds the charging station.
- To charge Automower® battery.

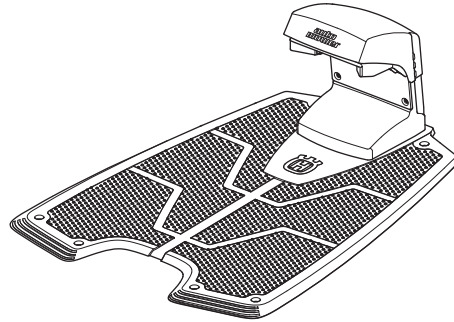

Transformer, which is connected between the charging station and a 120V(230V) wall socket. The transformer is connected to the wall socket via an integrated power cord and to the charging station via a 66 ft (20 m) long low voltage cable. The low voltage cable must not be extended. The low voltage cable must not be shortened nor extended.

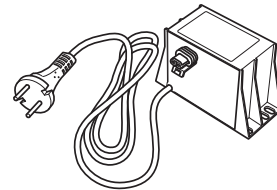

Wire, laid in a loop around Automower®'s working area. The boundary wire is laid around the edges of the lawn and around objects and plants that the mower must not run into. The wire is also used for any guide wires.

The wire supplied with the installation is 1300 ft (400 m) long (800 ft (250 m) for 220 AC). If this is not sufficient more wire can be purchased, with a connector, and spliced onto the existing wire.

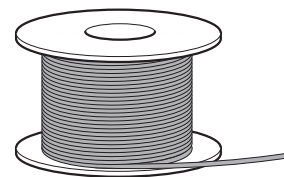

## 2. PRESENTATION

### 2.1 Automower®, what's what?

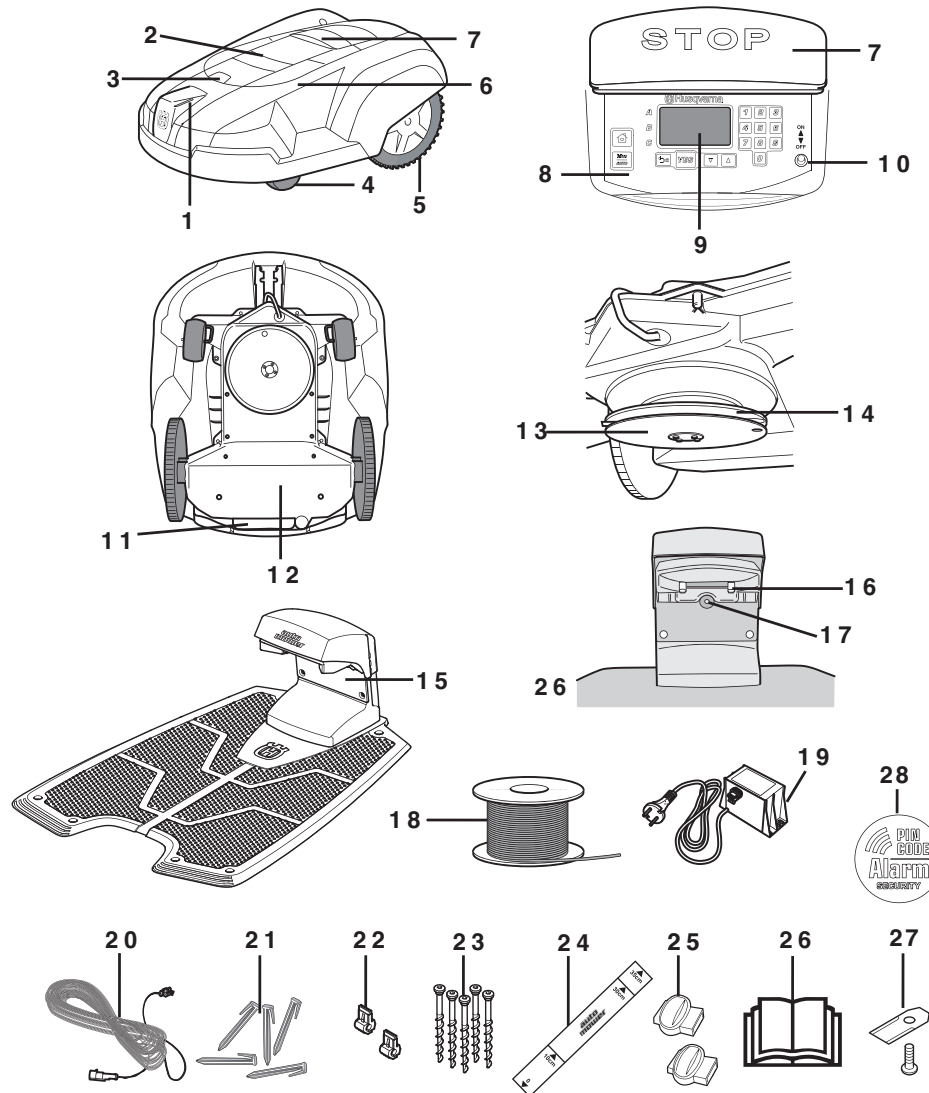

The numbers in the picture correspond to:

- |   |  |
|---|--|
| 1. Charging strip   | 15. Charging station   |
| 2. Cutting height adjustment cover                          | 16. Contact strips   |
| 3. Catch button to open the cutting height adjustment cover | 17. LED for operation check of the boundary wire                 |
| 4. Front wheel  | 18. Loop wire for the boundary wire and guide wire               |
| 5. Drive wheel  | 19. Transformer with power cord                                  |
| 6. Body   | 20. Low voltage cable  |
| 7. Stop button  | 21. Staples  |
| 8. Keypad   | 22. Connector for the loop wire                                  |
| 9. Display  | 23. Screws for securing the charging station                     |
| 10. Main switch   | 24. Measurement gauge for help when installing the boundary wire |
| 11. Handle  | 25. Solderless coupler for the loop wire                         |
| 12. Chassis box with electronics, battery and motors        | 26. Operator's Manual  |
| 13. Skid plate  | 27. Extra blades   |
| 14. Blade disc  | 28. Alarm decal  |

---

## 2. PRESENTATION

---

### 2.2 Function of Automower®

#### Capacity

Automower® is recommended for lawns up to 0.75 acre (3000 m<sup>2</sup>) (0.5 acre (1800 m<sup>2</sup>) for 220 AC).

How large an area is mown depends primarily on the condition of the blades and the type of grass, growth rate and humidity. The shape of the garden is also significant. If the garden mainly consists of open lawns, Automower® can mow more per hour than if the garden consists of several small lawns separated by trees, flower beds and passages.

How long Automower® mows and recharges can vary depending on, among others, the ambient temperature. Up to about 77 °F (25 °C) a fully charged Automower® mows for approximately 60 - 90 minutes, (40 - 60 minutes for 220 AC), depending on the age of the battery and the thickness of the grass. The mower then charges for 45 - 60 minutes. Above 77 °F (25 °C) both the mowing and charging times gradually drop.

#### Mowing technique

The mowing system used by Automower® is based on an effective and energy efficient principle. Unlike normal lawn mowers, Automower® cuts the grass instead of striking it off.

We recommend you allow Automower® to mainly mow in dry weather to obtain the best possible result. Automower® can even mow in the rain, however, wet grass easily collects on the mower and the risk of slipping on steep slopes is greater. To keep the drive wheels clean and thus increase traction, use Automower® wheel brushes (505 13 27-01).

When there is a risk of thunder Automower® should not stand in the charging station. When there is a risk of a thunder storm, the 120V (230V) plug should be removed from the mains socket and the boundary wire disconnected from the charging station.

The blades must be in good condition to obtain the best mowing result. In order to keep the blades sharp for as long as possible it is important to keep the lawn free from branches, small stones and other objects.

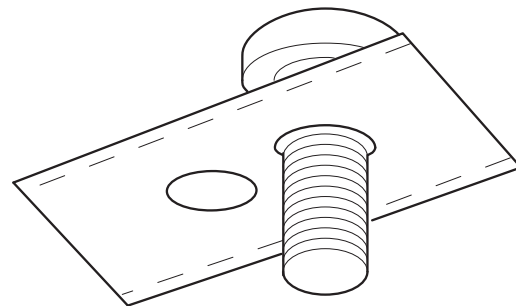



## 2. PRESENTATION

### Working method

Automower® automatically mows the lawn. It continuously combines mowing and charging.

The charging station sends out a signal that Automower® can sense at a distance of 20 - 23 ft (6 - 7 meters). The mower starts to search for the charging station when the battery charge becomes too low. Automower® does not mow when it is searching for the charging station.

When Automower® searches for the charging station it uses one or more of three different search methods: Irregular, Follow boundary wire and Follow guide wire. For more information about the search methods, see *2.3 Search method* on page 15 and *Follow loop in (3-2-2)* on page 53.

When the battery is charged the mower reverses, turns around and leaves the charging station in a randomly selected direction within the exit sector 90° - 270°.

To make it easier for Automower® to reach all parts of the garden you can manually set how the mower will leave the charging station, see *6.5 Installation (3)* on page 49.

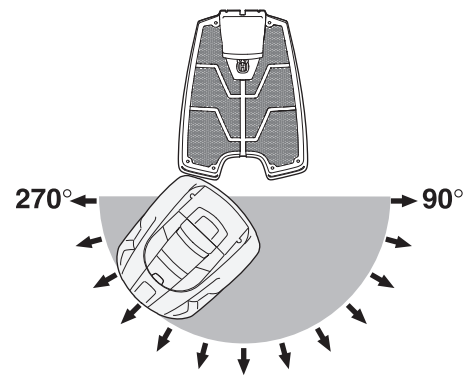
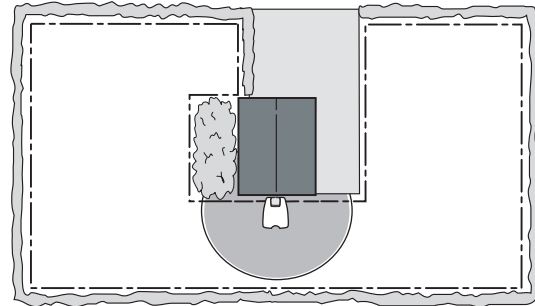

When Automower® body hits an obstacle, the mower reverses and selects a new direction.

Two sensors, at the front and back on Automower®, sense when the mower approaches the boundary wire. Automower® overruns the wire by up to 27 centimeters (11") before it turns. The overrun length can be set, see *Drive past wire (3-4-1)* on page 56.

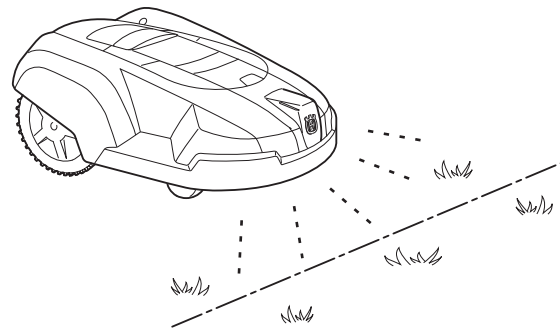

The **STOP** button on the top of Automower® is mainly used to stop the mower when it's running. When the **STOP** button is pressed a cover opens, behind which there is a control panel. The **STOP** button remains depressed until the cover is closed again. This acts as start inhibitor.

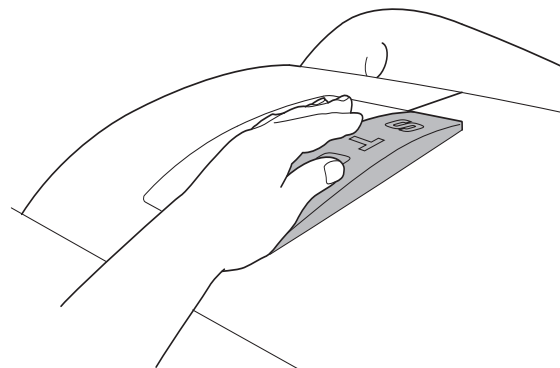

## 2. PRESENTATION

The control panel on the top of Automower® is where you manage all the mower settings. The main switch is also located on the control panel. Open the control panel cover by pressing down the **STOP** button.

When the main switch is turned *ON* for the first time, a start-up sequence begins which includes: selection of the language, time format, date format and four digit PIN code, plus setting of the time and date, see page 31.

The selected PIN code must then be entered each time the main switch is moved to the *ON* position. This theft-prevention function is called *Time lock (4-1-2)* and Automower® has this function activated as a default setting. The function also means that the mower stops mowing after a set number of days and will not continue until the correct PIN code has been entered. The function can be deactivated or changed as required. For more information about *Time lock (4-1-2)*, see page 58.

Automower® can enter a sleep mode to save power. The display on the control panel is then completely dimmed.

The sleep mode is activated 25 minutes after the **STOP** button has been pressed and then not reset to the operating mode. Automower® is then activated by switching the main switch off and on.

The sleep mode can also be activated in the event of a fault occurring during mowing or charging and which is not rectified within 25 minutes. Automower® is then activated by pressing the **STOP** button.

### Movement pattern

The mower's movement pattern is irregular and is determined by Automower® itself. A movement pattern is never repeated. This mowing system means the lawn is mown equally without any mowing lines.

If Automower® enters an area where it senses the grass is longer than earlier, it can change the movement pattern. It can then mow in a square pattern to cover the area of longer grass more systematically.

When Automower® mows in a square pattern, this is known as square mode cutting. The mower must have been operational for more than 6 hours in order for Automower® to start square mode cutting.

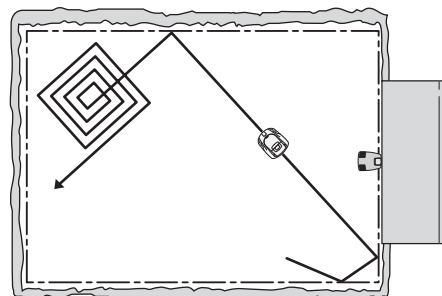
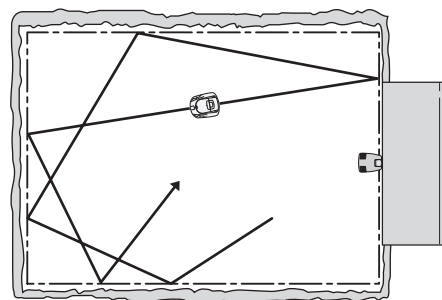
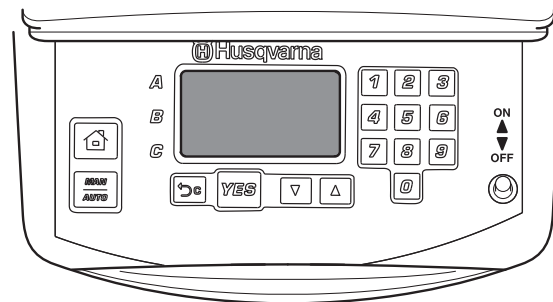
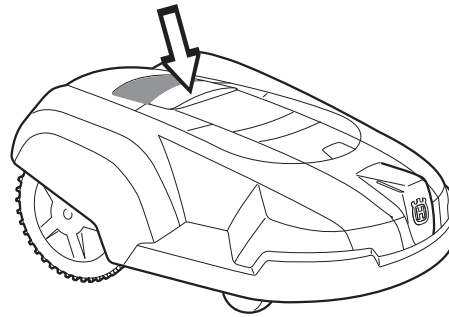

## 2. PRESENTATION

### 2.3 Search method

Automower® can be set to search for the charging station in three different ways. Using the setting options the three search methods can be combined to optimize the search for the charging station. The required search method or methods depends on the shape of the garden.

#### Search method 1: Irregular

Automower® runs irregularly until it finds the charging station.

This search method is best for an installation that has an open lawn and no narrow passages (narrower than about 10 ft (3 metres)).

The advantage of this search method is that there is no risk of leaving tracks in the grass after the mower.

The disadvantage is that the search times can be somewhat longer.

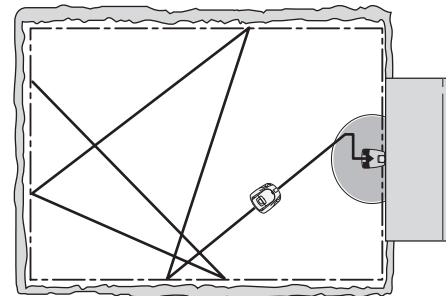

#### Search method 2: Follow boundary wire

Automower® runs irregularly until it reaches the boundary wire. The mower then follows the boundary wire in to the charging station.

This search method is best for an installation that has an open lawn with wide passages (wider than about 10 ft (3 metres)) and no, or only a small, island.

The advantage of this search method is that the search times are generally short.

The disadvantage is that tracks can be formed to a certain extent in the grass behind the mower. Problems can also arise if there are narrow passages or a large number of islands, for example, bushes. Automower® circles an island roughly twice, which can take a long time and create tracks.

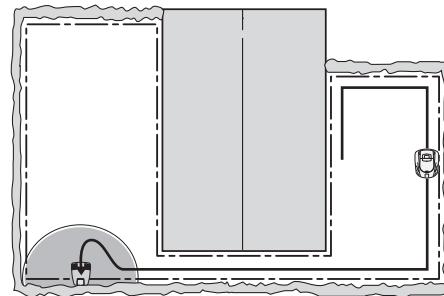

---

## 2. PRESENTATION

---

### Search method 3: Follow guide wire

Automower® runs irregularly until it reaches the guide wire. The mower then follows the guide wire in to the charging station.

The guide wire is an extra wire that is laid from the charging station, out towards a remote part of the working area or through a narrow passage and is then connected to the boundary wire. Up to two guide wires can be installed for 230 ACX. For more information, see *3.8 Installation of the guide wire* on page 32.

This search method is best for an installation that has numerous or large islands, narrow passages or steep slopes.

The advantage of this search method is that the search times are generally short.

The disadvantage is that the mower can leave tracks in the grass along the length of the guide wire.

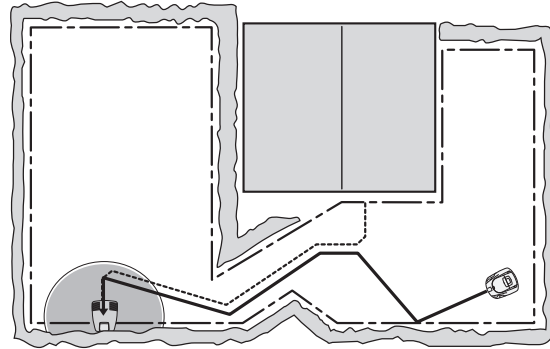

### 2.4 More than one Automower® in a garden

If you install more than one Automower® in the same area of lawn, each mower must have its own PIN code. A complete installation, including charging station, is required for each mower. The boundary wires for the different installations can be routed next to each other.

Contact your dealer for further information.

### 2.5 One Automower® in several gardens

One Automower® can easily be used for more than one garden, where each garden has its own charging station and boundary wire. The mower can then have the same PIN code for all gardens.

Contact your dealer for further information.



## 3. INSTALLATION

### 3. Installation

This chapter describes how you install Husqvarna Automower®. Before starting the installation read the previous chapter 2. *Presentation*.

Read the whole of this chapter too before starting the installation. How the installation is made also affects how well Automower® will work. It is therefore important to plan the installation carefully.

Planning is simplified if you make a sketch of the working area, including all obstacles. This makes it easier to see the ideal positions for the charging station, boundary wire and guide wire, if used. Draw on the sketch how the boundary wire and the guide wire, if used, should be routed.

**Carry out the installation in the following steps:**

- 3.1 Preparations.
- 3.2 Installation of the charging station.
- 3.3 Charging the battery.
- 3.4 Installation of the boundary wire.
- 3.5 Connecting the boundary wire.
- 3.6 Checking the installation.
- 3.7 Linking Automower® to the charging station.
- 3.8 Installation of the guide wire.

To carry out a complete start-up of Automower® the charging station must be in position and connected, the boundary wire connected, and the mower connected to the charging station. If you would like to start the mower without having completed the full boundary installation, you can connect a temporary short loop around the mower.

#### 3.1 Preparations

1. If the lawn in the proposed working area is taller than 4" (10 cm), mow it using a normal lawn mower. Then collect the clippings.
2. Read carefully through all the steps before the installation.
3. Check that all parts for the installation are included:

The numbers in brackets refer to the detail diagram 2.1 *Automower®*, *what's what?* on page 11.

- Operator's Manual (26)
- Automower®
- Charging station (15)



## 3. INSTALLATION

- Loop wire for the boundary wire and guide wire (18)
- Transformer (19)
- Low voltage cable (20)
- Staples (21)
- Connector for the loop wire (22)
- Screws for the charging station (23)
- Measurement gauge (24)
- Solderless coupler for the loop wire (25)

During installation you will also need: A hammer to knock the staples into the ground, combination pliers, polygrip (for pressing the couplers together) and a straight spade if the boundary wire is to be buried.

### 3.2 Installation of the charging station

#### Ideal position of the charging station

For examples of good positioning of the charging station, see 7. *Garden example - Proposed installation and settings* on page 61.

If you are going to install a guide wire, read 3.8 *Installation of the guide wire*, see page 32, before choosing the position of the charging station.

The charging station must be positioned with a great deal of free area in front of it (at least 10 ft (3 metres)). It should also be positioned centrally in the working area so that Automower® can easily find the charging station and quickly reach all parts of the working area.

It is a good idea to place the charging station in the shadow. The battery is spared if it is charged in the lowest possible ambient temperature.

The charging station must be positioned on relatively level ground. The height difference must not differ more than 2" (5 cm) between the front and rear of the charging station.

The charging station must not be positioned so that its plate bends.

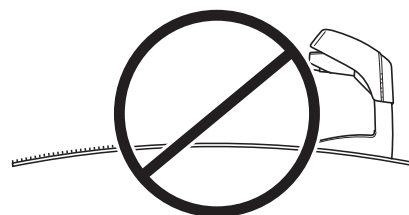
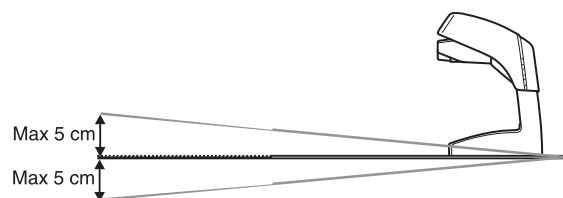
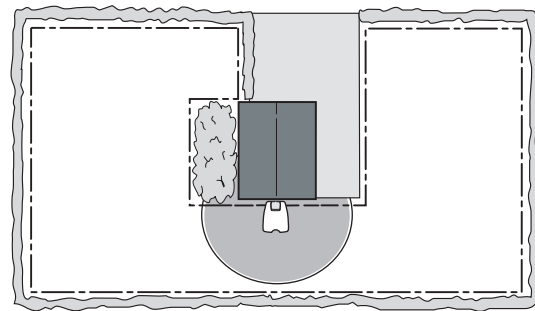

## 3. INSTALLATION

Consider the distance to a wall socket when choosing the position. The charging station should be connected to a 120V (230V) wall socket via the low voltage cable and transformer.

The supplied low voltage cable is 66 ft (20 metres) long.

**Tip!** It is possible to let the low voltage cable cross the working area. It must then be either stapled down or buried. In some cases there is a better positioning option for the charging station than close to a house wall or by the closest wall socket.

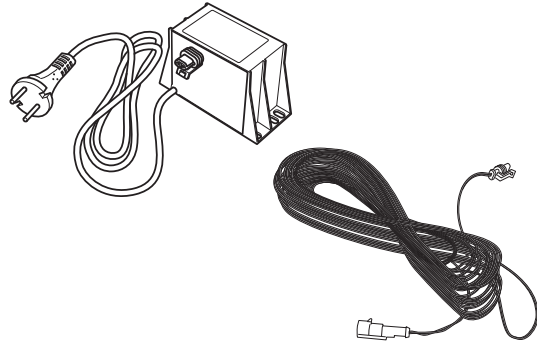

### IMPORTANT INFORMATION

**The low voltage cable must not under any circumstances be shortened or extended.**

The transformer must be placed where it is well ventilated and is not exposed to direct sunlight.

### IMPORTANT INFORMATION

**The power cord on the transformer must not be replaced. In those cases where the power cord has been damaged, the transformer must be discarded and replaced by a new one.**

It is recommended to use an earth fault-breaker when connecting the transformer to the wall socket.

Do not put the charging station in a corner or pocket in the working area.

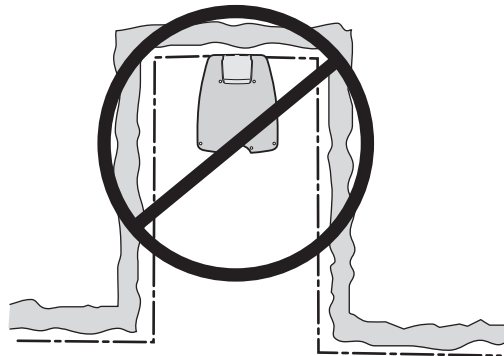

Avoid placing the charging station in a narrow passage (narrower than about 10 ft (3 metres)).

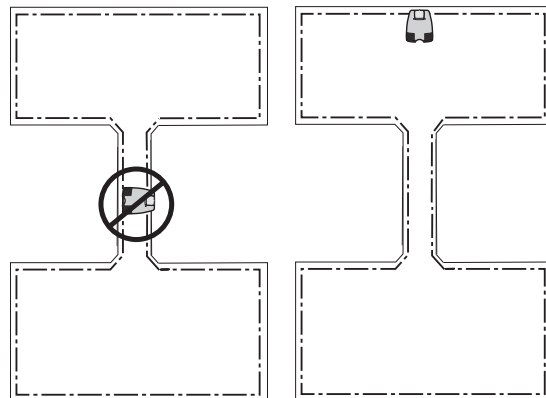

## 3. INSTALLATION

Do not position the charging station so that the mower can come closer than 10 ft (3 metres) behind the charging station (for example on a narrow point). The mower will not then find the charging station.

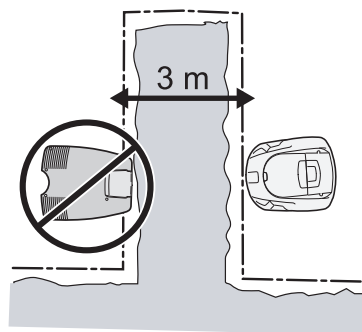

### Installation and connecting the charging station

1. Position the charging station in a suitable spot.
2. Attach the charging station to the ground using the supplied screws.
3. Ensure the screws are secured all the way down in the countersink.

#### IMPORTANT INFORMATION

It is not permitted to make new holes in the plate. Only the existing holes may be used to secure the plate to the ground.

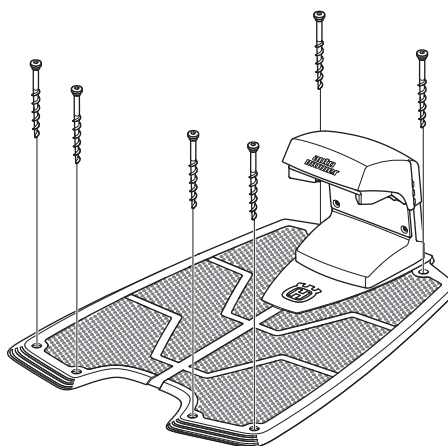

4. Connect the low voltage cable to the charging station.

Only use original cable and transformer.

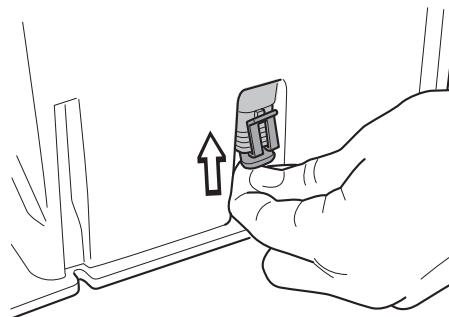

5. Connect the low voltage cable to the transformer.

The connectors may be slightly difficult to connect, as they are moisture-proof.

6. Connect the transformer's power cord to a 120 V (230V) wall socket. It is preferable to use an earth-fault breaker as recommended.

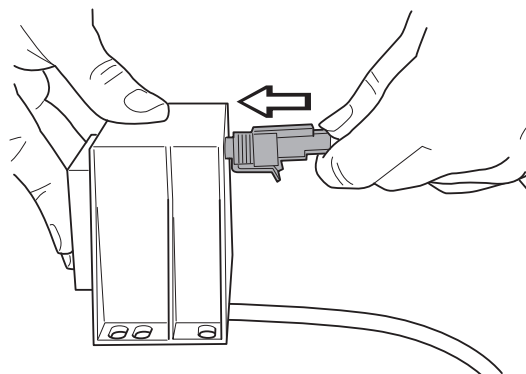



## 3. INSTALLATION

### IMPORTANT INFORMATION

Do not tread or walk on the charging station plate.



### 3.3 Charging the battery

Automower® is supplied with an uncharged battery. As soon as the charging station is connected, it is possible to charge the mower.

1. Set the main switch to the *OFF* position.
2. Place Automower® in the charging station to charge the battery while you are laying the boundary wire.

From an uncharged state the battery takes about 1 1/2 to 2 1/2 hours until it is fully charged.

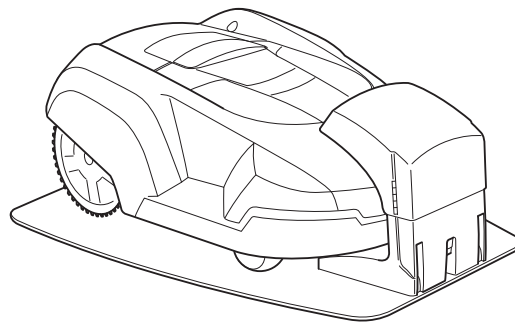

### IMPORTANT INFORMATION

Automower® cannot be used before the installation is complete.

### 3.4 Installation of the boundary wire

The boundary wire can be installed in one of the following ways:

- Securing the wire to the ground with staples.  
It is preferable to staple down the boundary cable, if you want to make adjustments to the boundary wire during the first few weeks of operation.
- Bury the wire.  
It is preferable to bury the boundary wire if you want to dethatch or aerate the lawn.

If necessary both methods can be combined so one part of the boundary wire is stapled down and the remainder is buried.

## 3. INSTALLATION

### Best position for the boundary wire

The boundary wire should be laid so it:

- Forms a loop around the working area for Automower®. Only an original boundary wire must be used. This is tinned and has a high quality insulation to withstand the dampness in the ground.
- Maintains a maximum distance of 100 ft (35 metres) from Automower® in the entire working area.
- Ideally not longer than 1600 ft (500 metres). For installations where a longer boundary wire of up to 800 metres is required, we recommend a Signal amplifier (522 42 58-01) which is available as an accessory.
- The boundary wire is laid at different distances from obstacles depending on what the working area borders. The picture below shows how the boundary wire should be routed around the working area and around obstacles.

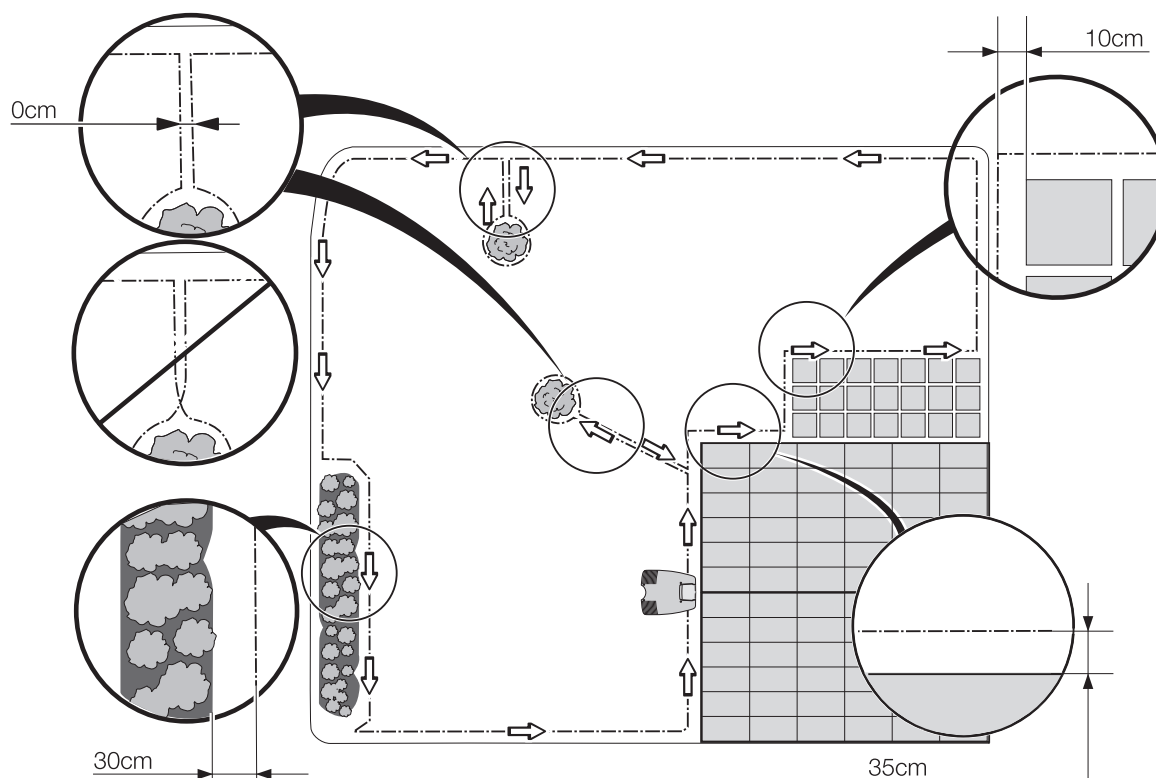

## 3. INSTALLATION

### Boundaries for the working area

If a high obstacle, for example a wall or fence, borders the working area, the boundary wire should be laid 14" (35 cm) from the obstacle. This will prevent Automower® from colliding with the obstacle and reduce body wear.

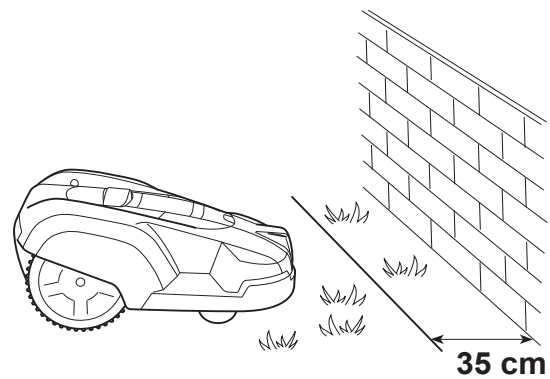

If the working area borders against a small ditch, for example, a flower bed or a small elevation, e.g. a low verge (1" - 2") (3 - 5 cm), the boundary wire should be laid 12" (30 cm) inside the working area. This prevents the wheels from driving into the ditch or up onto the verge.

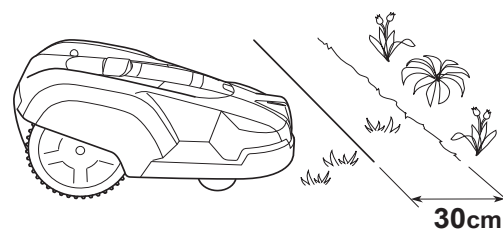

If the working area borders against a flat path or the like that lies level with the lawn, it is possible to allow Automower® to run a little over the path. The boundary wire should then be laid 4" (10 cm) from the edge of the path.

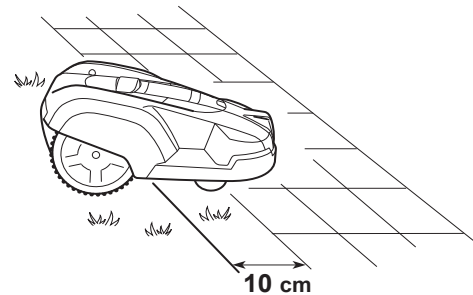

When the working area is divided by a flat slab path that is level with the lawn, it is possible to allow Automower® to run over the path. It can be an advantage to lay the boundary wire under the slabs. The boundary wire can also be laid in the joint between the slabs.

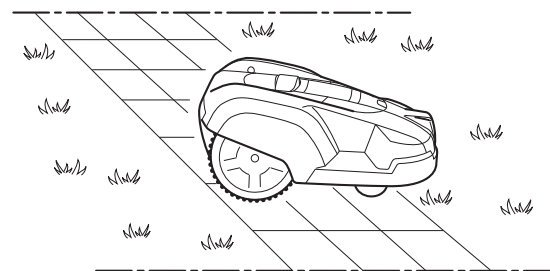

**Note!** Automower® must never run over a gravel path or similar material, which can damage the blades.

### IMPORTANT INFORMATION

**If the working area is adjacent to water bodies, slopes or precipices, the boundary wire should be supplemented with a fence or the like. The height must then be at least 6" (15 cm). This will prevent Automower® from ending up outside the working area under any circumstances.**

## 3. INSTALLATION

When Automower® searches for the charging station or follows the loop according to the function *Follow loop (3-2)* (see page 51), it runs along the side of the boundary wire at a specific distance. The *Corridor width (3-2-3)* function determines the distance from the boundary wire that the mower shall run. It is recommended to state as high a *Corridor width* value as possible. A high *Corridor width* value reduces the risk of tracks forming. For more information about *Corridor width (3-2-3)*, see page 54.

In exceptional cases Automower® can be set to straddle the boundary wire, that is to say, half the mower inside the loop and the other half outside. The boundary wire must then be kept at a distance of about 16" (40 cm) from all the boundaries of the working area and from the edges of a passage.

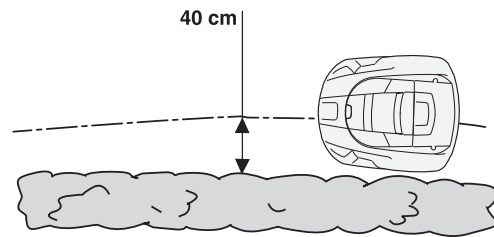

### Boundaries within the working area

Use the boundary wire to demarcate areas inside the working area by creating islands around obstacles that can not withstand a collision, for example, flower beds and fountains. Run the cable out to the area, route it around the area to be demarcated and then back along the same route. If staples are used, the wire should be laid under the same staple on the return route. When the boundary wire to and from the island are close together, the mower can drive over the wire.

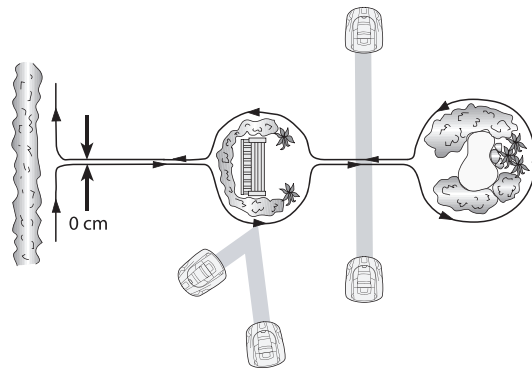

Obstacles that can withstand a collision, for example, trees or bushes higher than 6" (15 cm), do not need to be demarcated by the boundary wire. Automower® will turn when it collides with this type of obstacle.

However, for the most gentle and silent operation, it is preferable to demarcate all fixed objects in and around the working area.

Obstacles that slope slightly, for example, stones or large trees with raised roots, should be demarcated or removed. Automower® can otherwise slide up onto this kind of obstacle causing the blades to be damaged.

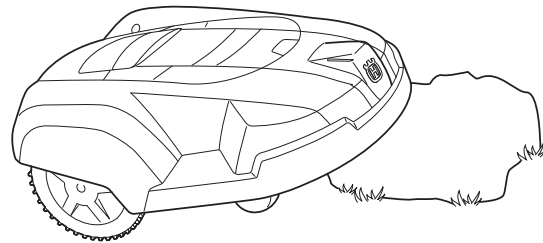

## 3. INSTALLATION

### Secondary areas

It is recommended to create a secondary area when the working area is made up of two areas that are joined by a passage where the distance between the boundary wires is less than 24" (60 cm). Run the boundary wire then around the secondary area so that it forms an island outside of the main area.

Automower® must be moved manually between the main and secondary areas. Use the *MAN* operating mode when Automower® shall mow a secondary area.

Instead of creating an island with the existing boundary wire, a secondary area generator can ideally be used. A secondary area generator can be purchased as an accessory. Contact your dealer for further information.

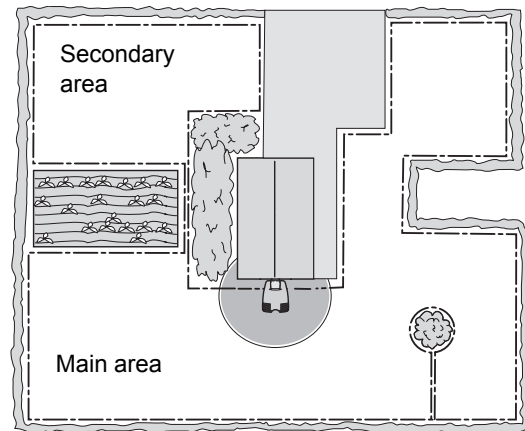

### Passages when mowing

Long narrow passages and areas, narrower than 5 - 7 ft (1.5 - 2 metres), should be avoided. When Automower® mows there is a risk that it runs around in the passage or area for a too long a period. The lawn will then look flattened.

### Passages when searching for the charging station

The distance between the boundary wires in a passage must be at least 10 ft (3 metres) in order for Automower® to follow the boundary wire through the passage without the need of changing the mower's default settings. When the distance is less than 10 ft (3 metres), there are two options available that permit Automower® to run through the passage.

1. Install a guide wire.

When the distance between the boundary wires is less than 10 ft (3 metres), it is recommended to install a guide wire through the passage. For more information about the guide wire, see 3.8 *Installation of the guide wire* on page 32.

Usually the installation of the guide wire is the best solution with narrow passages.

The narrowest passage that Automower® can run through with the help of a guide wire is 2 ft (60 cm) between the boundary wires.

2. Change the Corridor width setting (3-2-3).

When the distance between the boundary wires in a narrow passage is more than 7 ft (2 metres) it is possible for Automower® to run through the passage if a low value is set for the *Corridor width* (3-2-3) function (see page 54). However, a low value involves a large risk of tracks forming along the entire boundary wire.

The transition between a large area and a passage should be, if possible, designed like a funnel, with rounded corners, to make it easier for Automower® to enter the passage.

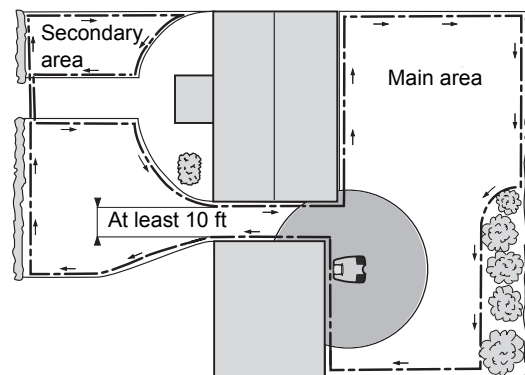

### 3. INSTALLATION

#### Slopes

The boundary wire can be laid across a slope that slants less than 20 %.

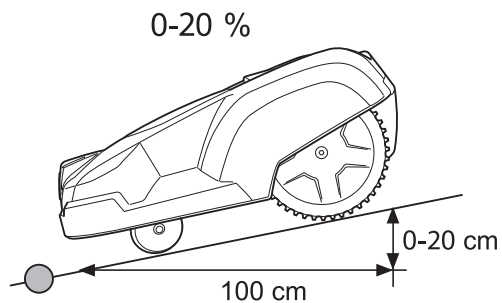

The boundary wire should not be laid across a slope that is steeper than 20 %. There is a risk of Automower® finding it difficult to turn there. The mower will then stop and show the fault message *Outside working area*. The risk is at its greatest in damp weather conditions, as the wheels can slip on the wet grass.

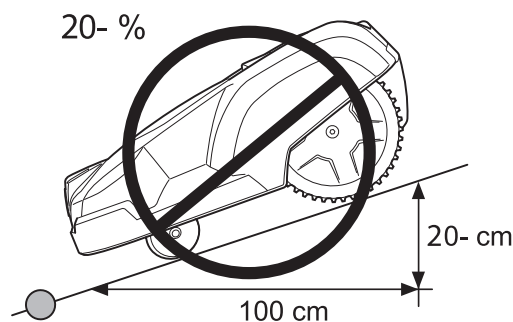

However, the boundary wire can be laid across a slope steeper than 20 % when there is an obstacle that Automower® can be permitted to collide with, for example, a fence or a dense hedge.

Automower® can mow areas inside the working area that slope up to 35 % (see picture). Areas that slope more must be demarcated by the boundary wire.

When any part of the working area's boundary slopes more than 20" (10 cm) per distance metre (20 %), the boundary wire must be routed about 14" (35 cm) in on flat ground before the slope starts.

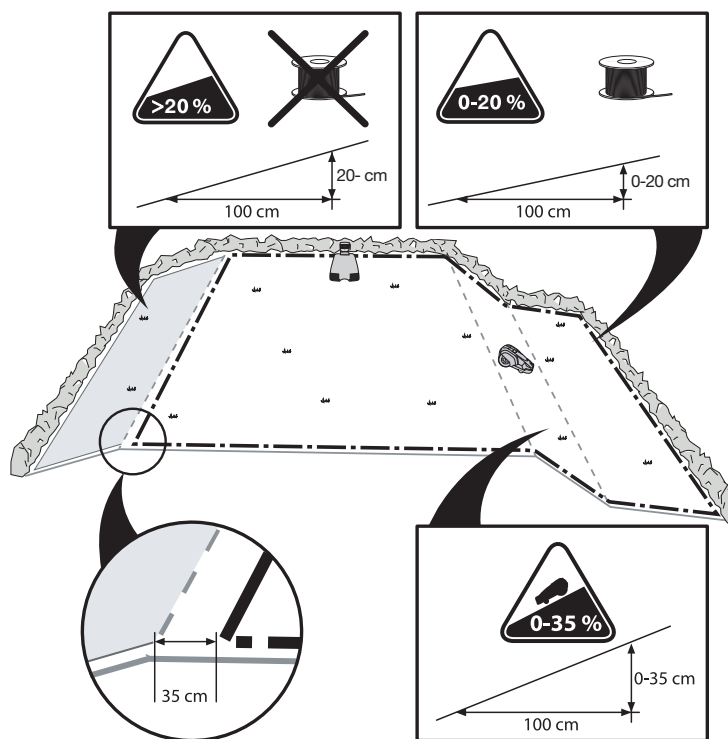



## 3. INSTALLATION

### Laying out the boundary wire

Run the boundary wire around the working area, but wait before connecting the wire to the charging station.

#### IMPORTANT INFORMATION

**Extra wire must not be placed in coils outside the boundary wire. This can disrupt Automower®.**

**Tip!** Use the supplied measurement gauge as a guide when you lay out the boundary wire. This helps you to easily set the correct distance between the boundary wire and the boundary/obstacle.

If you intend to staple down the boundary wire:

- **Tip!** Mow the lawn where the wire is to be laid using a normal lawn mower or a trimmer. It will then be easier to lay the wire close to the ground and the risk of the mower cutting the wire off is reduced.
- Make sure to lay the boundary wire tight to the ground and secure the staples close together with approximately 30" (75 cm) between each staple. The wire must generally lie close to the ground, so as not to be cut off before the grass roots have grown over it.
- Use a hammer to knock down the staples in the ground. Exercise care when knocking in the staples and make sure the wire is not under strain. Avoid forming the wire in sharp bends.

If you intend to bury the boundary wire:

- Make sure to place the boundary wire at least 0.5" (1 cm) and a maximum of 8" (20 cm) into the ground.

The boundary wire must not be crossed on the path to and from an island.

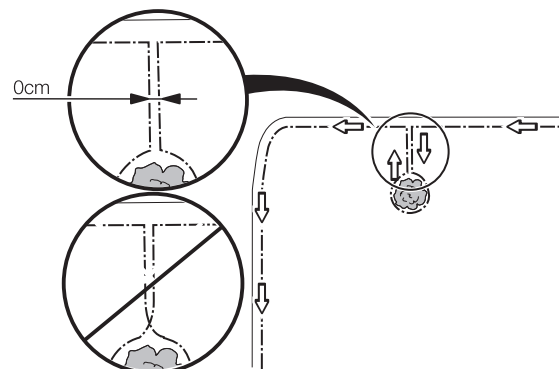
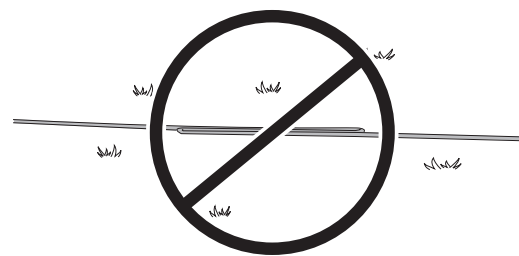
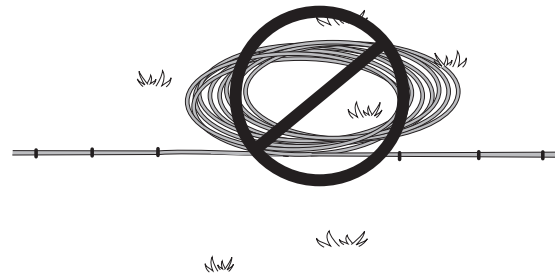
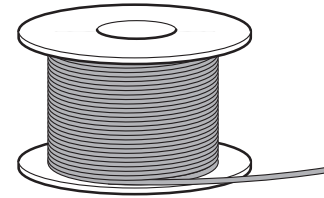

## 3. INSTALLATION

### Laying the boundary wire in towards the charging station

The boundary wire can be routed in several different ways in towards the charging station. The best alternative is to route the wire completely outside the charging station, see alternative 1. The wire can also be placed under the charging station plate as shown in alternative 2 in the illustration. However, the wire should not be placed outside alternative 2 because it can then be difficult for Automower® to find the charging station.

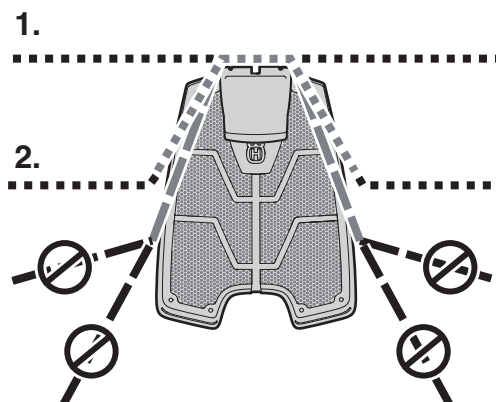

When connecting to the charging station, the right end of the boundary wire should be guided into the right-hand hole and the cable's left end in the left-hand hole.

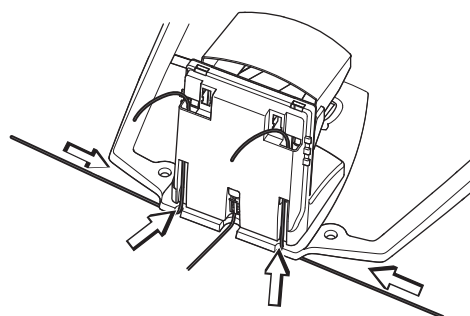

### Joining the boundary wire

If the boundary wire is not long enough and needs to be spliced: Use original solderless coupler. It is waterproof and gives a reliable electrical connection.

To splice: Insert both cable ends in the coupler. Now press down the button on top of the connector fully. Use a polygrip to completely press down the button on the coupler.

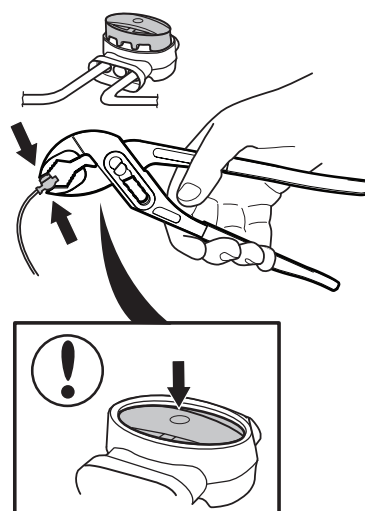

#### IMPORTANT INFORMATION

**Twisted cables, or a screw terminal (chock-block), insulated with insulation tape is not a satisfactory splice. Soil moisture will cause the conductors to oxidize and after a while result in a broken circuit.**

## 3. INSTALLATION

### 3.5 Connecting the boundary wire

Connect the boundary wire to the charging station:

1. Lift up the cover on the charging station:
  - Grip under the edge of the cover with both hands and pull straight out towards the sides.
  - Now lift the cover straight up.

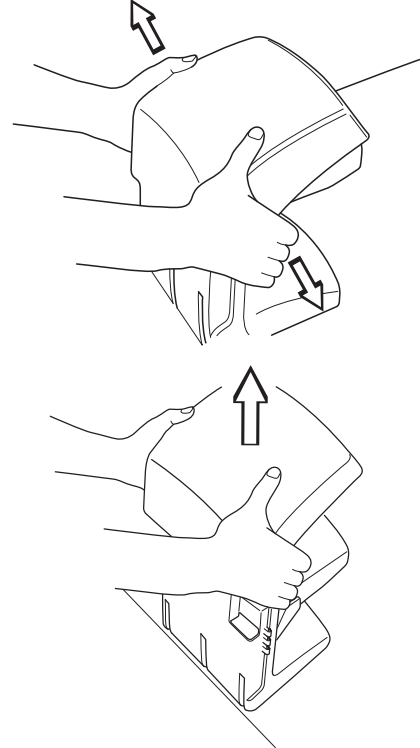

2. Slide in the ends of the boundary wire in the lowermost holes on the charging station and catch them in the uppermost holes.

The right hand wire end should be inserted in the right hand hole, and the left hand wire end in the left hand hole.

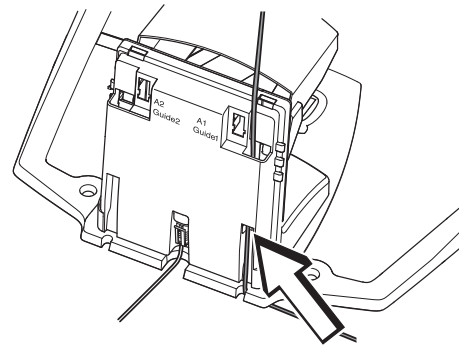

#### IMPORTANT INFORMATION

**The boundary wire must not be crossed when connecting to the charging station. Therefore the right hand wire end must be connected to the right hand connector on the charging station and vice versa.**

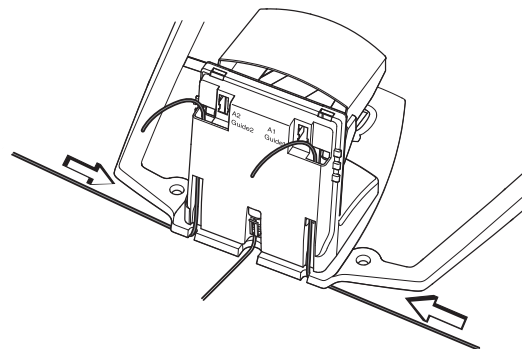

## 3. INSTALLATION

3. Place the cable ends in the connector:

- Open the connector.
- Place the wire in the connector grip.

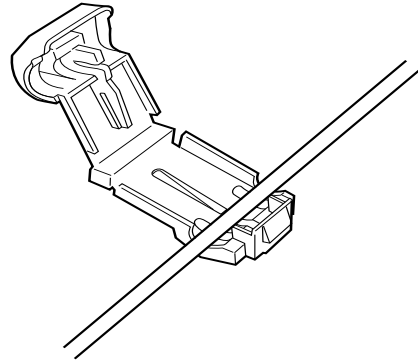

4. Press the connector together using a pair of pliers. Press until you hear a click.

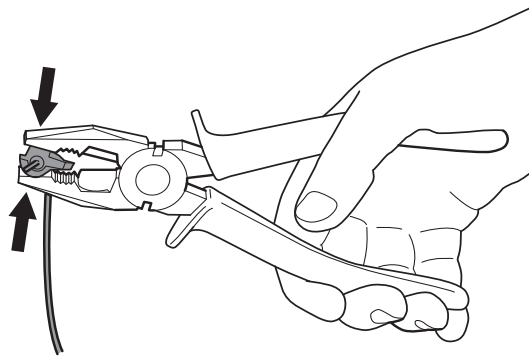

5. Cut off any surplus boundary wire. Cut 0.4" - 0.8" (1 - 2 cm) above respective connectors.

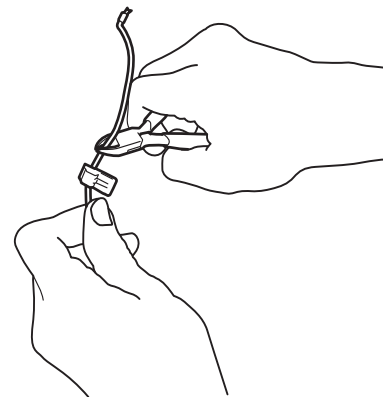

6. Press the connector onto the contact pin, marked A, on the charging station.

### IMPORTANT INFORMATION

**The right hand connector should be connected on the right hand contact pin on the charging station and vice versa.**

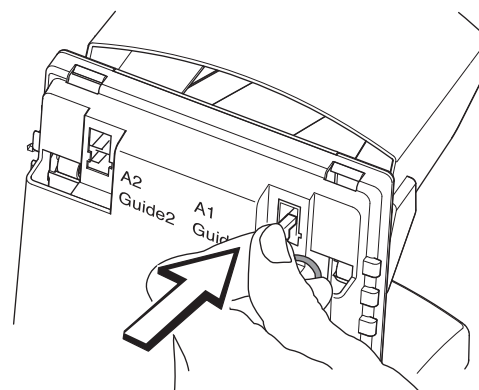

## 3. INSTALLATION

7. Refit the cover on the charging station. Ensure the three guides on the charging station enter the right holes in the cover.

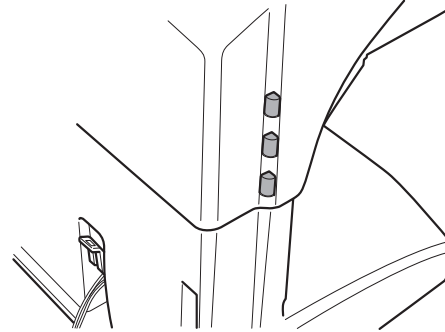

### 3.6 Checking the installation

Check the loop signal by looking to see what indication the green LED on the charging station is giving.

- Steady light = the signal is okay.
- Flashing once every other second = break in the loop and no signal found.
- Flashing twice every other second = weak signal. This may be due to the boundary wire exceeding 1600 ft (500 m) or that the cable is damaged. If the mower works, it is not a problem. In case of operational disturbance, we recommend a Signal amplifier (522 42 58-01) which is available as an accessory. This allows a boundary wire of up to 800 metres.

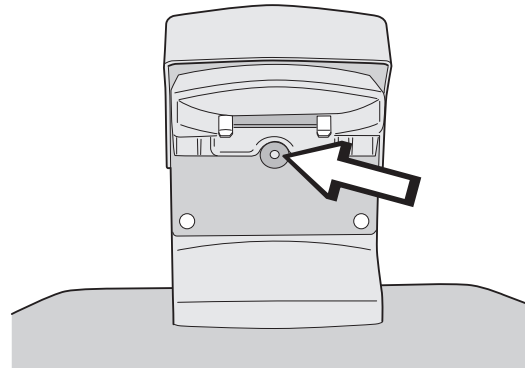

### 3.7 Linking Automower® to the charging station

1. Open the control panel cover by pressing the **STOP** button.
2. Place Automower® in the charging station.
3. Set the main switch to the *ON* position.

A start-up sequence begins when Automower® is started for the first time. The following is requested: Language, time format, correct time, date format, date, and four-digit PIN code. All combinations except 0000 are permitted.

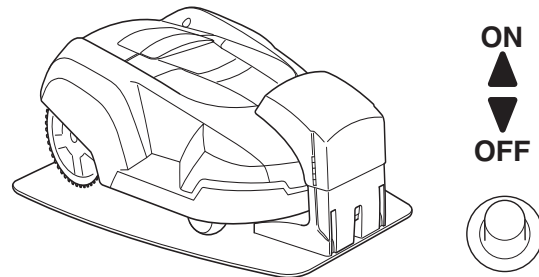

When you have chosen a PIN code with Automower® placed in the charging station, the mower and charging station are then linked to each other.

## 3. INSTALLATION

### 3.8 Installation of the guide wire

The guide wire is an extra wire that is laid from the charging station, out towards a remote part of the working area or through a narrow passage and is then connected to the boundary wire. The same wire used for the boundary wire is also used for the guide wire.

Up to two guide wires can be installed for 230 ACX. In similarity to the boundary wire, the guide wire can either be stapled down or buried.

When a guide wire is installed, Automower® can also be set to follow the guide wire out from the charging station using the function *Follow loop out (3-2-1)*, see page 51.

#### Need of a guide wire

The guide wire may be necessary in installations where the search methods Irregular and Follow boundary wire are not adequate for the mower to quickly and easily find the charging station.

A few examples of installations where a guide wire is recommended follow below:

- Narrow passages.

In passages where the distance between the boundary wires is less than 10 ft (3 metres), it is recommended to install a guide wire through the passage. This is a better solution than allowing Automower® to follow close to the boundary wire by setting a low *Corridor width* value.

- The boundary wire runs along a steep slope (steeper than 25 %).

When Automower® follows the boundary wire that runs along a steep slope, the mower will change direction and run away from the boundary wire.

- Numerous or large islands.

If Automower® is permitted to follow the boundary wire it may circle an island roughly twice before it leaves the island and once again searches for the boundary wire.

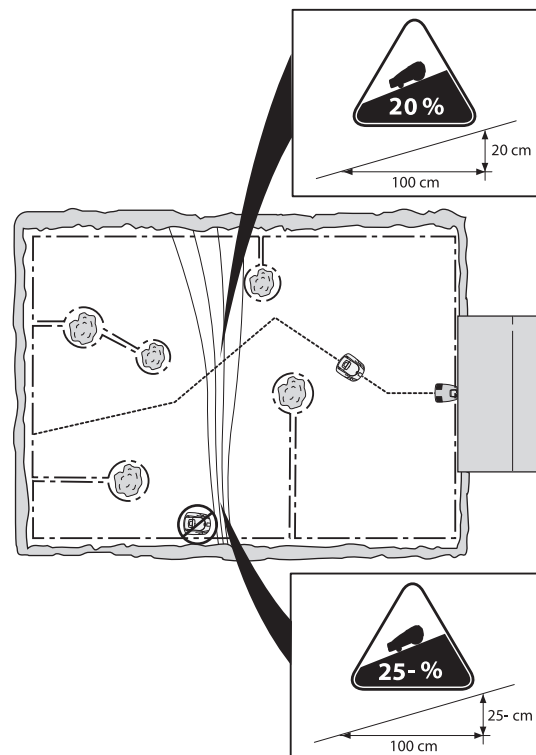



## 3. INSTALLATION

- The route to a remote area is long or complicated.

When Automower® shall follow the boundary wire to or from a remote area and the route along the boundary wire to the area is long or complicated.

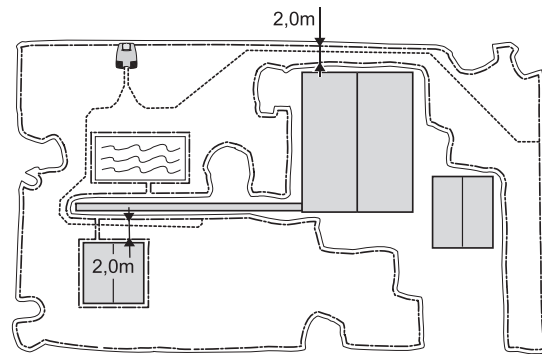

- The boundary wire runs across a long slope (steeper than 10 %).

When Automower® follows the boundary wire across a slope (steeper than 10 %) the mower must compensate for the slope. The mower then follows the boundary wire at a slower speed. The risk of the mower running outside of the working area due to skidding increases.

- The charging station is positioned on an island.

When there is more than 13 ft (4 metres) between the charging station and the outer edge of the boundary wire, it can take a long time for Automower® to find the charging station when it follows the boundary wire. There is a risk of the mower following the outer edge of the working area 2 - 3 turns before it changes direction and starts to follow the loop at another spot.

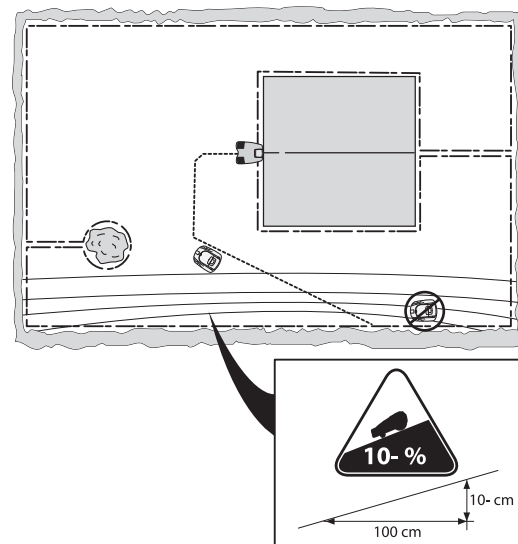

### Placement and connection of the guide wire

In the text below the guide wires are called guide 1 and guide 2, as is the case on the rear of the charging station (220 AC only has guide 1).

- Check that the charging station has the best placement.

The guide wire together with the part of the boundary wire that makes up the return to the charging station is known as the guide loop. The current in the guide loop always goes to the left in the connection between the guide wire and the boundary wire.

The adjoining picture shows what is considered a guide loop.

The picture is also a good example of an ideal position for the charging station to give the shortest possible guide loop.

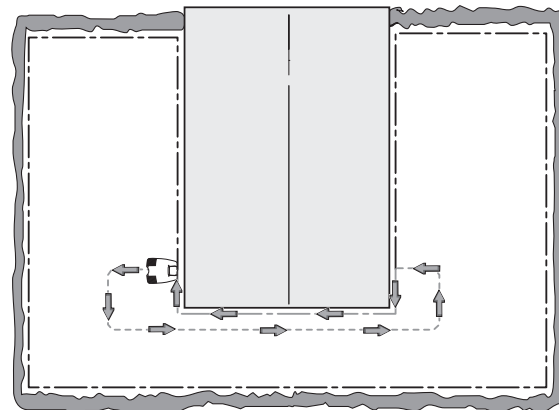

## 3. INSTALLATION

The longer the guide wire, the closer the mower follows the guide wire. If the guide wire is longer than 1000 ft (300 metres), the mower may find it difficult to follow the wire. This varies depending on the design of the garden and installation.

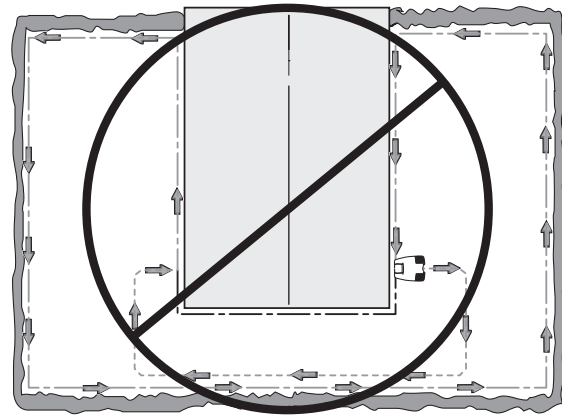

2. Lift up the cover on the charging station.
3. If you intend to install guide 1:
  - Insert the end of guide 1 into the lower right-hand hole on the charging station and catch it in the upper hole.
  - Secure a connector on the guide wire.
  - Connect guide 1 to the contact pin on the charging station marked guide 1.

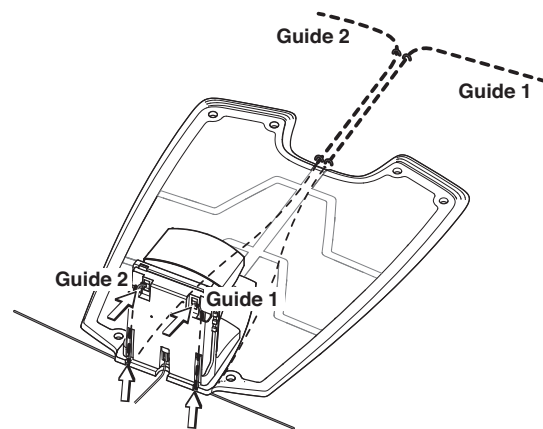

If you intend to install guide 2:

- Insert the end of guide 2 into the lower left-hand hole on the charging station and catch it in the upper hole.
  - Secure a connector on the guide wire.
  - Connect guide 2 to the contact pin on the charging station marked guide 2.
4. Route the cable straight under the charging station plate.

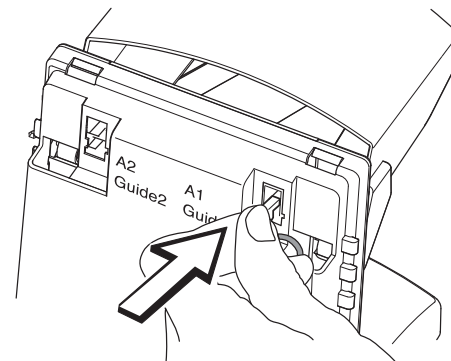

## 3. INSTALLATION

5. Route the guide wire at least 7 ft (2 metres) straight out from the front edge of the charging plate.

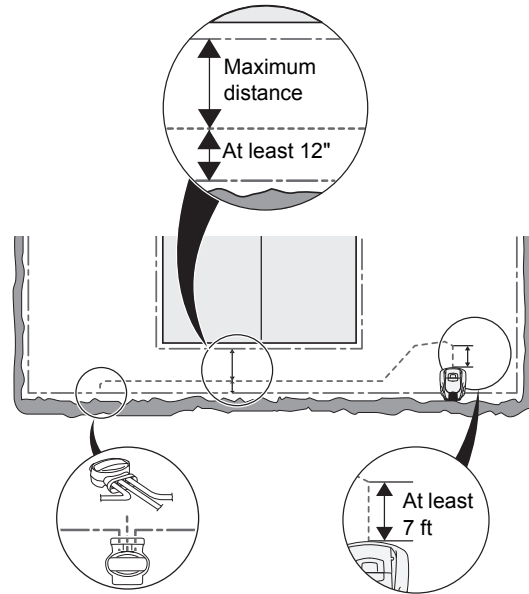

If you shall install the guide wire through a passage:

- Automower® follows the guide wire on the same side of the wire both to and from the charging station. This means that in towards the charging station the guide wire is on the right side of the mower and away from the charging station the guide wire is on the left side of the mower.

In the passage, the guide wire must be placed so that the mower has as much space to run as possible. The distance between the boundary wire and the guide wire must however be at least 12" (30 cm) (see the picture above).

The same minimum distance (12" (30 cm)) also applies between the guide wire and the guide wire in the passage,

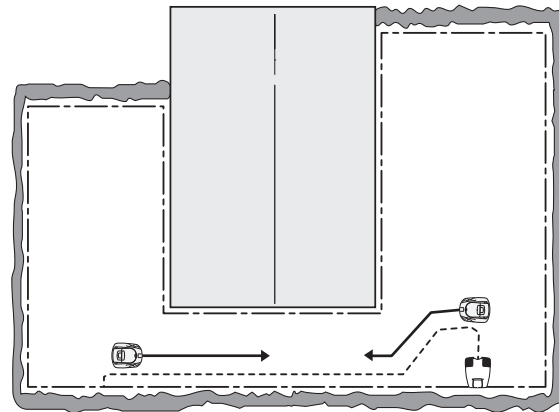

Avoid laying the wire at sharp angles. This can make it difficult for the mower to follow the guide wire.

6. Run the guide wire to the spot on the boundary wire where you want to make the connection.
7. Lift out the boundary wire.
8. Cut off the boundary wire using a pair of wire cutters.

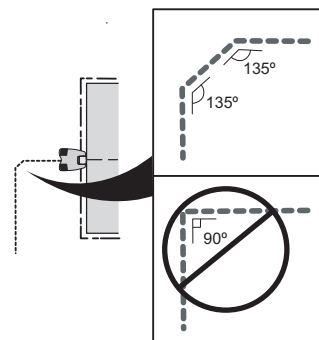

## 3. INSTALLATION

9. Connect the guide wire to the boundary wire with the help of a solderless coupler:
  - Insert the ends of the boundary wire in the right respective left-hand holes on the connector.
  - Insert the end of the guide wire in the centre hole.
  - Press down the button on the connector fully.
10. Staple down/bury the connector in the lawn.

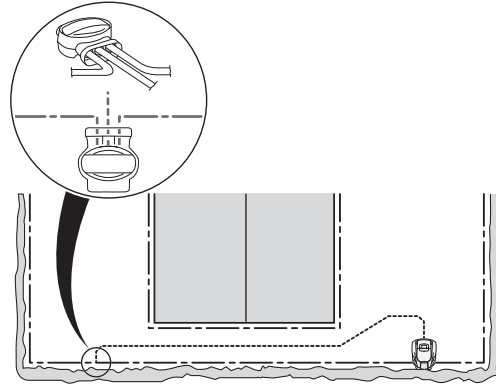

### IMPORTANT INFORMATION

The function of the guide wire varies depending on how the working area appears. It is therefore recommended to test the installation with the help of the function *Test IN (3-2-4)*, see page 55.

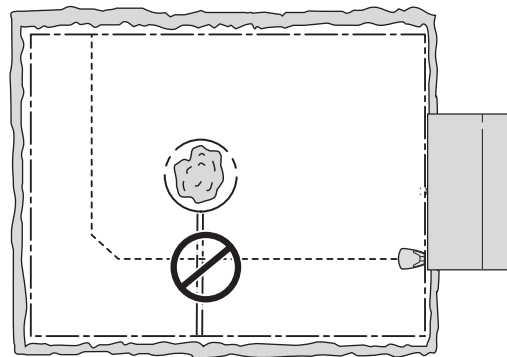

3018-073

### IMPORTANT INFORMATION

The guide wire may not cross the boundary wire, for instance a boundary wire that is laid out to an island.

## 4. USE

### 4. Use

#### 4.1 Charging a discharged battery

When Husqvarna Automower® is new or has been stored for a long period the battery will not be charged and needs to be charged before starting. Charging takes between 1 1/2 and 2 1/2 hours.

1. Place Automower® in the charging station. Insert the mower as far as possible.

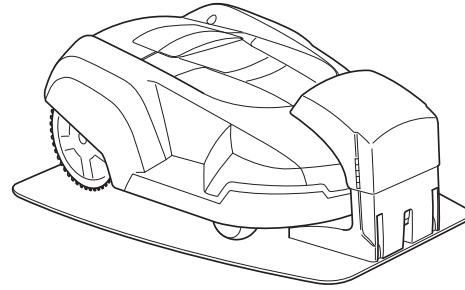

Good contact is made when both the charging strips on the mower touch the centre of the contact strips on the charging station.

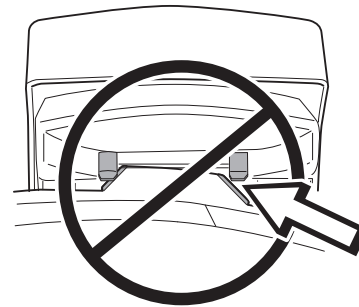

2. Open the control panel cover.
3. Set the main switch to the *ON* position.

Information about the charging process is shown on the display during the entire charging process.



#### WARNING

Read the safety instructions before you start your Automower®.



#### WARNING

Keep your hands and feet away from the rotating blades.  
Never put your hands or feet close to or under the body when the motor is running.



#### WARNING

Never use the robotic lawnmower when persons, especially children, or pets, are in the cutting area.

---

## 4. USE

---

### 4.2 Using the timer

The lawn should not be cut too often to obtain the best mowing result. Use the timer function (see 6.4 *Timer* (2) on page 47) to avoid a downtrodden lawn and to get the maximum life from your Automower®.

For example, the quality of your lawn will improve if it is mown every other day instead of 12 hours each day. In addition, the grass benefits from resting completely during at least a three-day period once a month.

### 4.3 Starting Automower®

1. Press the **STOP** button to open the control panel cover.
2. Set the main switch to the *ON* position.
3. Enter the PIN code.

The default setting for the theft prevention function *Time lock* (4-1-2) on Automower® is active. The function requires the PIN code to be stated each time the main switch is moved to the *ON* position when this is not done correctly the mower will stop mowing after the set number of days and will not start again until the correct PIN code has been entered. The function can be deactivated or changed as required. For more information about *Time lock* (4-1-2), see page 58.

4. Close the cover.

The message *Starting* is shown on the display. 5 beeps are heard over 2 seconds when the blade disc starts.

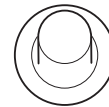

### 4.4 Stopping Automower®

1. Press the **STOP** button.

Automower® stops, the blade motor stops and the control panel cover opens.

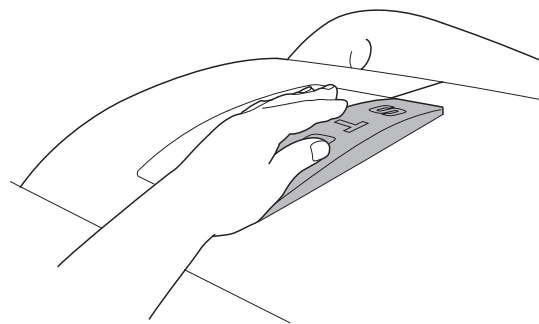



## 4. USE

### 4.5 Restart

#### Restart within 20 seconds

1. Close the control panel cover.  
Automower® starts automatically.

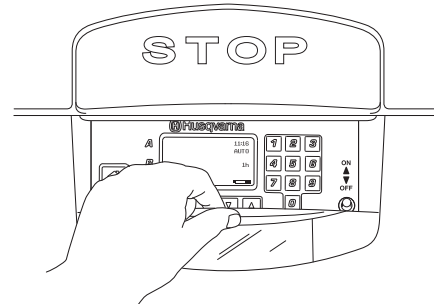

#### Restart after more than 20 seconds

If more than 20 seconds has elapsed since the last time the **STOP** button or the keypad was pressed it is not possible to start Automower® by just closing the cover.

To start:

1. Press the **YES** button.
2. Close the control panel cover.

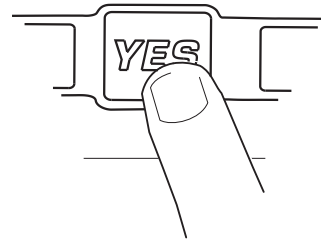

### 4.6 Switching off Automower®

1. Press the **STOP** button.
2. Set the main switch to the *OFF* position.

Always switch off Automower® using the main switch if you intend to perform maintenance or move the mower outside of the working area.

ON  
▲  
▼  
OFF



---

## 4. USE

---

### 4.7 Adjusting the cutting height

The cutting height can be varied from MIN (0.8" (2 cm)) to MAX (2.5" (6 cm)).

If the grass is long it is appropriate to let Automower® start mowing at the MAX cutting height. Once the grass is shorter, you can gradually lower the cutting height.

To adjust the cutting height:

1. Press the **STOP** button to stop the mower.
2. Open the cutting height adjustment cover:  
Press down the catch button and then open the cover.

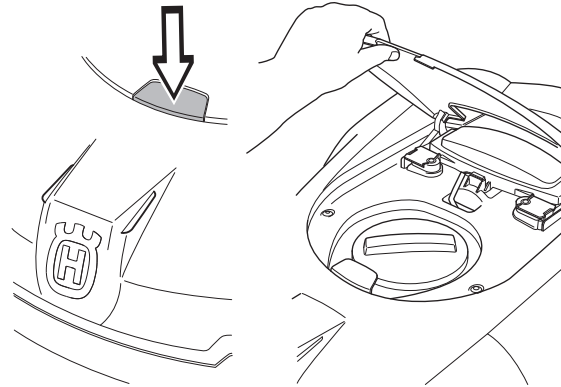

3. Turn the knob to the required position. The selected position is the marking on the knob that aligns with the arrow on the body.
  - Turn clockwise to raise the cutting height.
  - Turn anticlockwise to lower the cutting height.

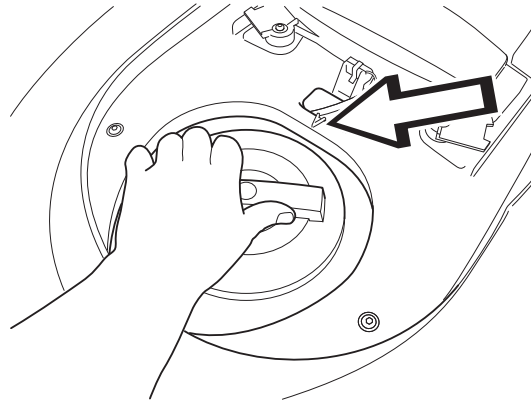

4. Close the cover. Ensure that the catch button locks.

## 5. CONTROL PANEL

### 5. Control panel

All forms of commands and settings for Husqvarna Automower® are made via the control panel. All functions are accessed via a number of menus.

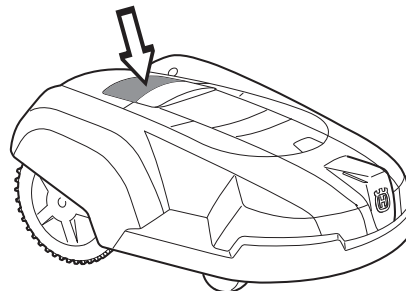

The control panel consists of a display and a keypad. All information is shown on the display and all input is done using the buttons.

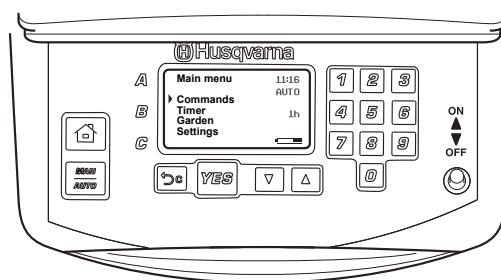

The main page shows the main menu, cursor, clock, selected operating mode, number of mowing hours, clock icon, program selection and battery status.

- The main menu is the uppermost level in the entire menu structure.
- The cursor shows which menu has been selected when the **YES** button is pressed.
- The clock shows the current time.
- The text *AUTO* or *MAN* shows which operating mode has been selected.
- The number of operating hours indicates the number of hours since the day of manufacture that Automower® has been in operation. The time that Automower® has spent mowing or looking for the charging station is counted as operating time.
- The clock icon shows when Automower® should be or is switched off by the timer, i.e. stands in the charging station or is on its way to the charging station to switch off.
- The program icon shows when one of the programs under the buttons **A**, **B** or **C** is selected.
- The battery status shows the remaining battery charge.



## 5. CONTROL PANEL

The keypad consists of five groups of buttons: Shortcuts, program, selection, numbers and the main switch.

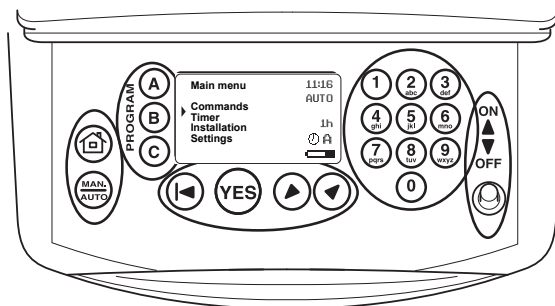

### 5.1 Shortcuts

#### 1. Home:

- Sends the mower to the charging station. Where it stays until the button is pressed again.

The house icon is lit on the right-hand side of the display when the button is pressed. When the battery is fully charged the mower will remain in the charging station and show the message *Waiting*.

When the *Test IN (3-2-4)* function (see page 55) is selected, Automower® will, once it reaches the charging station, remain there until the **Home** button is pressed again.

- Move the cursor in the menu structure back to the main page.

#### 2. Operating mode:

The selected operating mode is shown on the right-hand side of the display as *AUTO* respective *MAN*.

Press the button to choose between:

- *AUTO*, the normal automatic operating mode where Automower® mows and charges continuously.
- *MAN*. If you select *MAN* and close the control panel cover when Automower® is on the lawn, it will mow until the battery is discharged. It will then stop and show the message "Need manual charging". The mower must then be moved manually to the charging station and then started manually after charging.

If you select *MAN* and close the control panel cover when Automower® is in the charging station the mower will charge completely, reverse 8" and stop.

The *MAN* operating mode must be used when mowing secondary areas. Automower® will never start to search for the charging station but continues to mow until the battery is discharged.

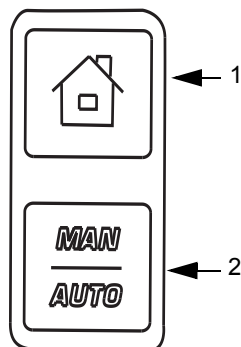

## 5. CONTROL PANEL

### 5.2 Programs

3. A
4. B
5. C

**A** ← 3

**B** ← 4

**C** ← 5

Under the program buttons you can save sets of different settings, to reuse or to simplify the use of Automower® in several gardens. Under respective buttons there are some preset settings. You can choose to use these or change them.

- To change settings: Make the required settings. Save by holding down the selected button for 2 seconds, until two beeps are heard close together. If, for example, button **A** is pressed the message *Program A changed* will be shown for 2 seconds on the display.
- Use the saved information by quickly pressing the required button.

If, for example, button **A** is pressed the question *Use program A?* will appear on the display. If **YES** is pressed, the *Program A* will be selected. The letter **A** is then shown on the right-hand side of the display to indicate which program is selected.

### 5.3 Select

6. Cancel:
  - Press to go back one step in the menu structure, or to interrupt an ongoing input.
7. YES:
  - Press to confirm an entry or selection.
  - Press to start the mower if more than 20 seconds has elapsed since you last pressed a button and you want to close the control panel cover.
8. Arrow up and arrow down:
 

Press any of the arrow buttons to move the cursor between menus or different selections.

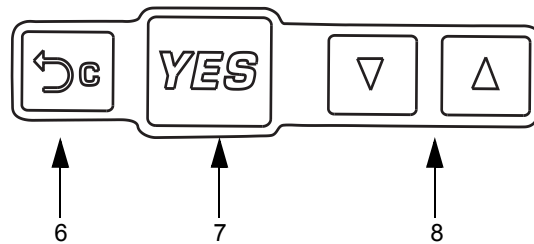

## 5. CONTROL PANEL

### 5.4 Numbers

9. Used in the menu structure to enter settings, for example, PIN code, time or exit direction.

Also used to specify a number series as a shortcut to the different menus. See more about number series in *Number series* on page 45.

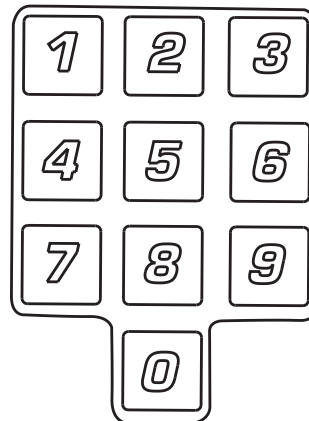

### 5.5 Main switch

10. Set the main switch in the *ON* position to start Automower®.

Set the main switch in the *OFF* position when you are not using the mower or if you want to work on the blade disc.

When the main switch is set in the *OFF* position the motors on the mower cannot start.

When the main switch is turned *ON* for the first time, a start-up sequence begins which includes: selection of the language, time format, date format and four-digit PIN code, plus setting of the time and date, see page 31.

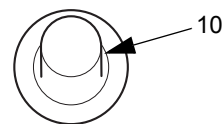

# 6. MENU FUNCTIONS

## 6. Menu functions

### 6.1 Main menu

The main menu consists of four options:

- 6.3 *Commands* (1)
- 6.4 *Timer* (2)
- 6.5 *Installation* (3)
- 6.6 *Settings* (4)

The numbers in brackets refer to the menu rows on the display of Husqvarna Automower®.

There are a number of submenus under each option. You can access all the functions to set Automower® settings via these.

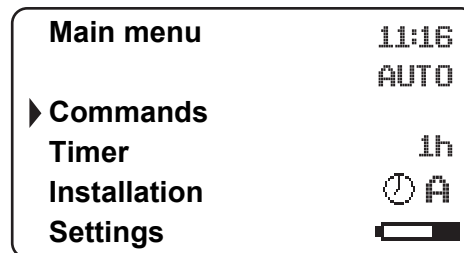

### Browse between menus

Browse through the main menu and submenus with the help of the arrow buttons. Enter values and the time with the help of the numerical buttons and confirm each selection with the **YES** button. Press the **Cancel button** to go one menu step back, and press the **Home button** to return directly to the main menu.

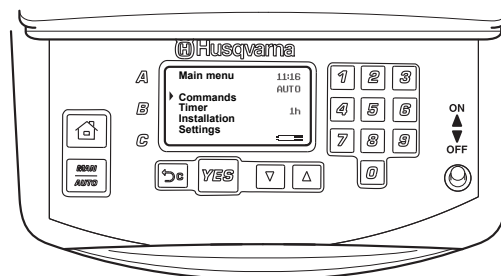

### Number series

The selection you have made in the main menu as well as subsequent selections made in submenus are shown as a number series in the right hand corner of the display.

The first number in the series refers to the selection in the main menu. The second number refers to the first sub-menu, etc.

You can use the number series as a shortcut to reach a specific function directly. For example: Press 2 2 in the main menu and the submenu *Day timer* is shown.

The headings on the following pages include respective number series within brackets.

### Submenus

In some of the submenus there is a box to the right of specific rows. When this box is checked with a tick it means the function is selected.

In some of the submenus there is information to the right of specific rows. This information indicates which selection has been made for the function.

#### Day timer

#### ▶ Reset all timers

- Start Time 1
- Stop Time 1
- Start Time 2
- Stop Time 2

2-2-1

#### ▶ PIN code

- Time lock
- Alarm

4-1-1



# 6. MENU FUNCTIONS

## 6.2 Automower® main menu, menu overview

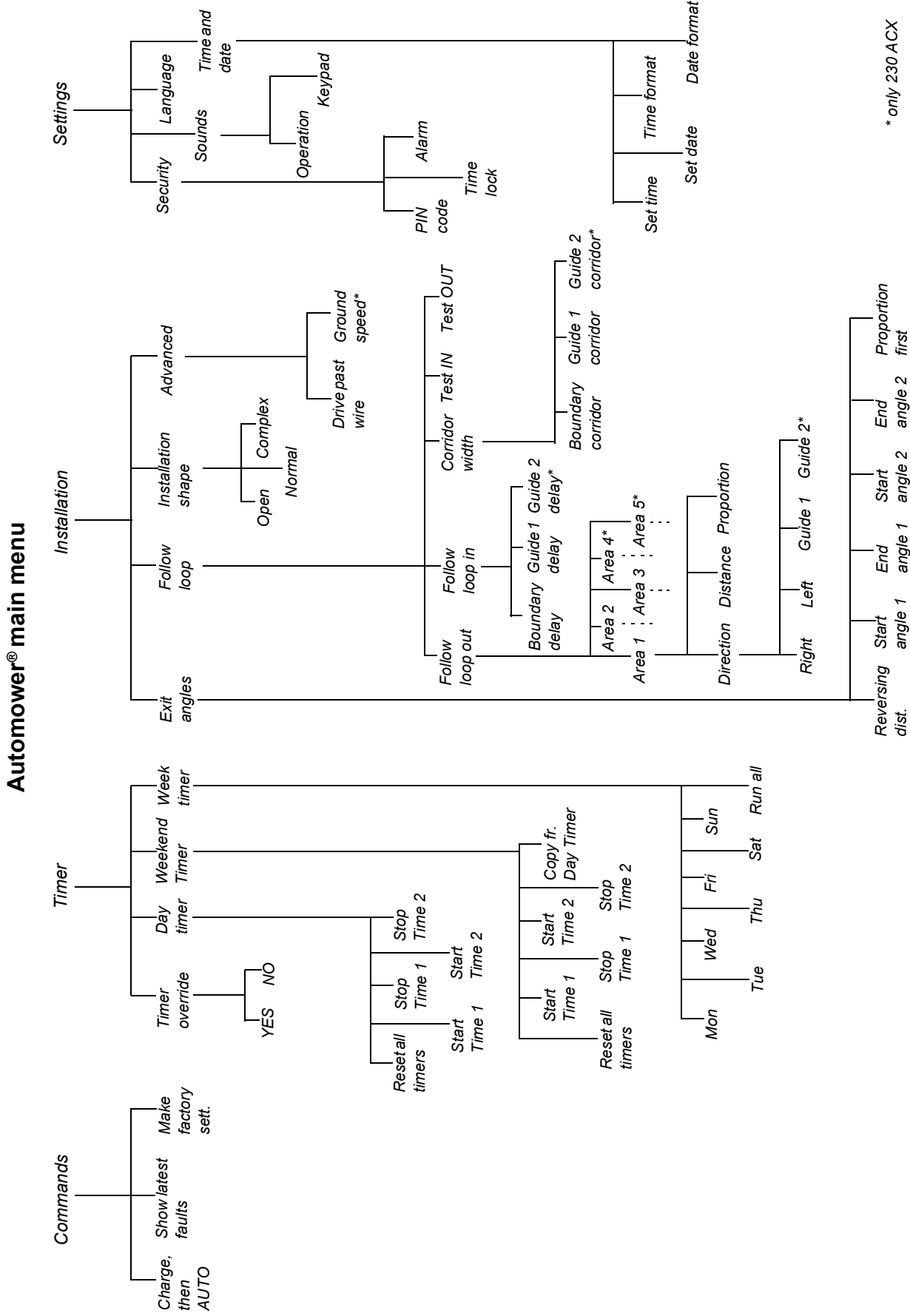

## 6. MENU FUNCTIONS

### 6.3 Commands (1)

This option in the main menu allows you to access the following functions on Automower®.

- **Charge then AUTO (1-1)**

in order for Automower® to drive immediately to the charging station, charge the battery and then return to the automatic operating mode. Select the function and press **YES** when the cursor is on Yes.

- **Show latest faults (1-2)**

to show the list of saved fault messages. Browse with the arrow buttons. The list can contain up to 20 fault messages and each message is shown with the date and time.

- **Make factory settings (1-3)**

to restore all settings to their original values. All except the selected language and PIN code are reset. Select the function, enter your PIN code and press **YES** when the cursor is on Yes.

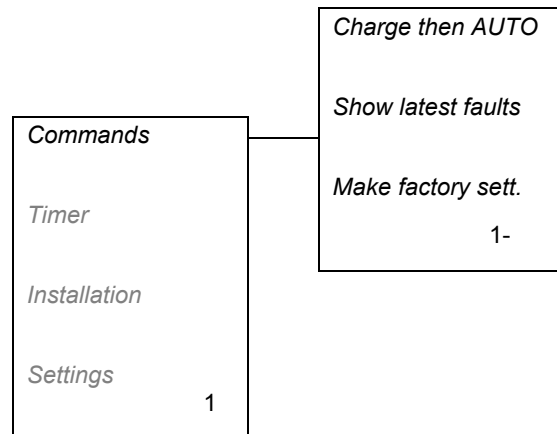

### 6.4 Timer (2)

The lawn should not be cut too often to obtain the best mowing result. Consequently, it is important to limit the operating time using the timer function if the working area is less than the mower's working capacity. When Automower® is allowed to mow too much, the lawn may appear flattened. Besides, the mower is subjected to unnecessary wear.

The timer function is also an ideal means to control during which periods Automower® should not mow, for example, when the children are playing in the garden.

When you set the timer, assume that Automower® mows about 1300 ft (125 m<sup>2</sup>) per hour (800 ft (75 m<sup>2</sup>) for 220 AC).

- **Timer override (2-1)**

to temporarily disconnect the timer function.

- **Day timer (2-2)**

to set the start and stop times.

- **Weekend timer (2-3)**

to set other start and stop times for the days Friday - Sunday.

- **Week timer (2-4)**

to select which days of the week Automower® should mow.

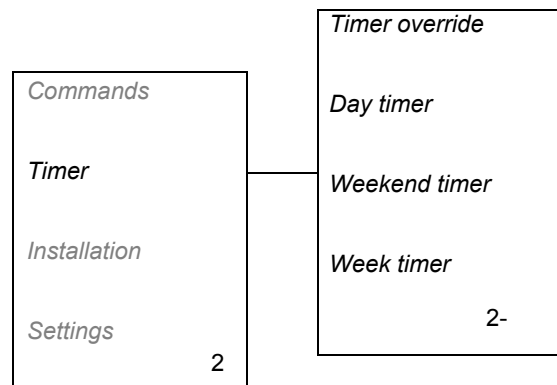

## 6. MENU FUNCTIONS

### Timer override (2-1)

If you set the timer on your Automower®, you can use this function to temporarily abandon the settings.

- **YES (2-1-1)**  
Move the cursor to **YES** and press **YES** to turn off the timer function.
- **NO (2-1-2)**  
Move the cursor to **NO** and press **YES** to turn on the timer function.

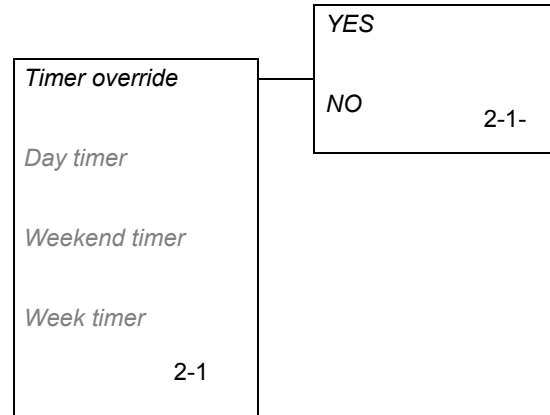

### Day timer (2-2)

It is possible to set two different start and stop times for each day. Enter the required time in hours and minutes and press **YES** to confirm the entered time.

- **Reset all timers (2-2-1)**  
To delete all set times: Select the function and press **YES** when the cursor is on Yes.
- **Start time 1 (2-2-2)**
- **Stop time 1 (2-2-3)**
- **Start time 2 (2-2-4)**
- **Stop time 2 (2-2-5)**

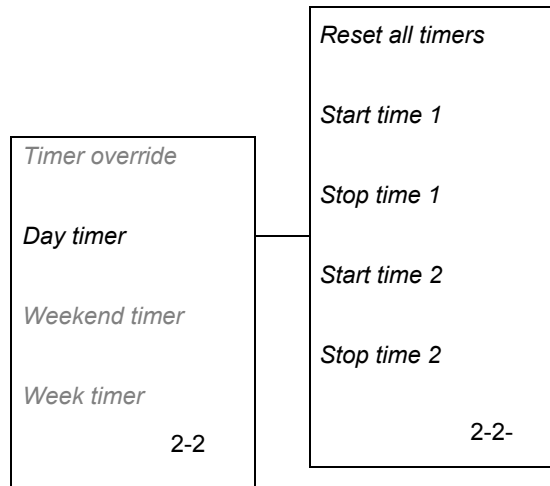

### Weekend timer (2-3)

The *Weekend timer* function controls the times when Automower® should mow during the days, Friday - Sunday. When you do not state any times in *Weekend timer*, Automower® will mow at the same times on these days as set for other days.

- **Reset all timers (2-3-1)**  
To delete all set times: Select the function and press **YES** when the cursor is on Yes.
- **Start time 1 (2-3-2)**
- **Stop time 1 (2-3-3)**
- **Start time 2 (2-3-4)**
- **Stop time 2 (2-3-5)**
- **Copy from day timer (2-3-6)**  
Press **YES** when asked *Copy?* to transfer all times set in the *Day timer*.

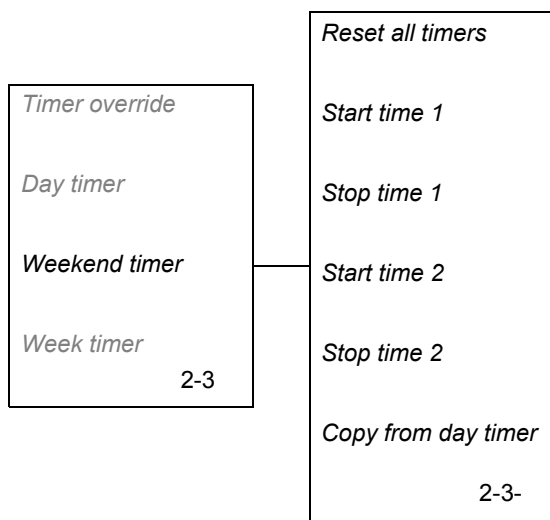

## 6. MENU FUNCTIONS

### Week timer (2-4)

Use the **YES** button to select/deselect the days you would like Automower® to mow/not mow. Automower® will mow on the days prefixed by a checkmark.

- *Mon* (2-4-1)
- *Tue* (2-4-2)
- *Wed* (2-4-3)
- *Thu* (2-4-4)
- *Fri* (2-4-5)
- *Sat* (2-4-6)
- *Sun* (2-4-7)
- *Run all* (2-4-8)

The function Run all selects all the days. If you would like the mower to mow every day of the week move the cursor to Run all and press **YES**. Then press **YES** again to the question *All ON?*

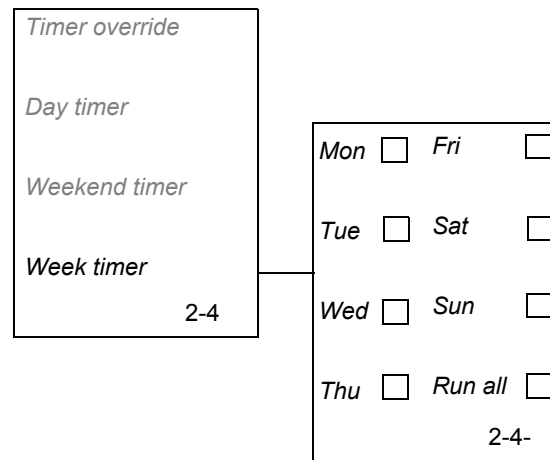

### 6.5 Installation (3)

From this option in the main menu you access the driving settings.

- **Exit angles (3-1)**  
to set how far Automower® should reverse out of the charging station before it turns and in what direction the mower should leave the charging station.
- **Follow loop (3-2)**  
to guide the mower to easily reach a remote area of the garden, to make it easier to find the charging station and to determine at what distance the mower shall follow the loop.
- **Installation shape (3-3)**  
to tell Automower® which type of garden you have.
- **Advanced (3-4)**  
to check that the loop is intact or where in the lawn exactly the cable is, to set the distance Automower® shall run via the boundary wire, and to change the mower's speed (speed setting not available for 220 AC).

For examples of Installation settings, see 7. *Garden example - Proposed installation and settings* on page 61.

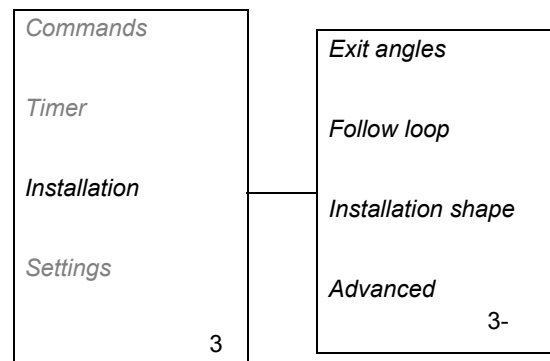

## 6. MENU FUNCTIONS

### Exit angles (3-1)

Normally Automower® leaves the charging station in a direction within the exit sector 90°-270°, where 90° is called the *Start angle* and 270° is called the *End angle*. By setting the start and end angles, you can set the direction in which Automower® is to leave the charging station.

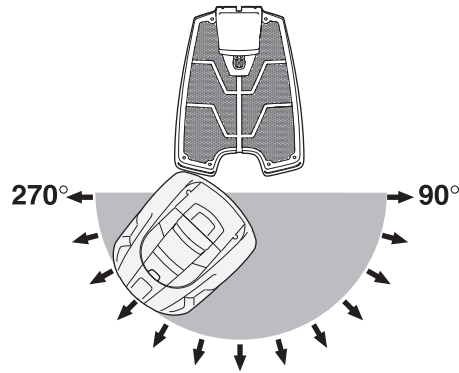

The mower can be set for up to two exit sectors. If the charging station is placed in a passage it may be necessary to have two exit sectors, e.g. 70° - 110° and 250° - 290°.

When you use two exit sectors, you also need to state how often the mower should leave the charging station in sector 1. This is done using the *Proportion first* function by stating a percentage. For example, the percentage 75 % means the mower will leave the charging station in sector 1, 75 % of the time and in sector 2, 25 % of the time.

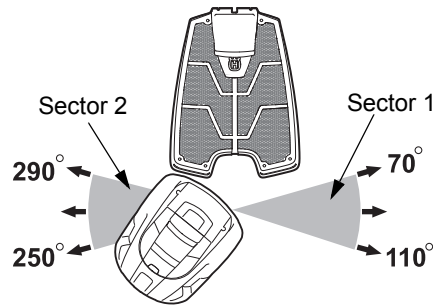

- *Reversing distance (3-1-1)*  
Specify the number of centimeters you want Automower® to reverse before it turns to drive out of the charging station.  
The default reversing distance is (24"(60 cm)).
- *Start angle 1 (3-1-2)*  
Specify in degrees where you want the sector/sector 1 to start.
- *End angle 1 (3-1-3)*  
Specify in degrees where you want the sector/sector 1 to end.
- *Start angle 2 (3-1-4)*  
Specify in degrees where you want the sector 2 to start.
- *End angle 2 (3-1-5)*  
Specify in degrees where you want the sector 2 to end.

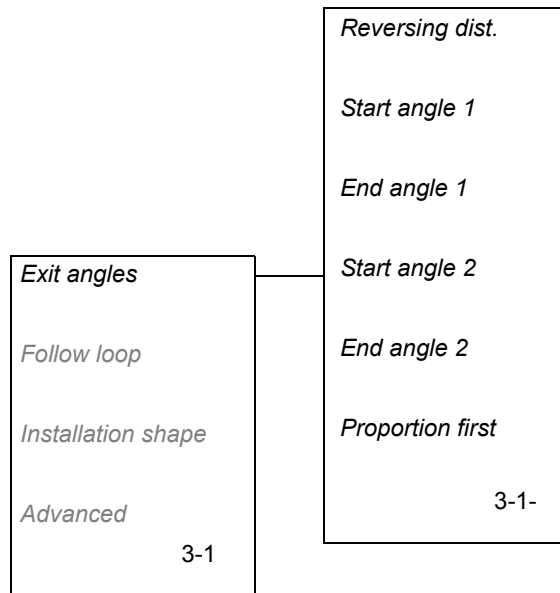

## 6. MENU FUNCTIONS

- **Proportion first (3-1-6)**

When you use two exit sectors: Specify a percentage to define on how many occasions Automower® should leave the charging station in sector 1.

To test the settings in *Exit angles*: State the value 100 % for *Proportion first* when sector 1 is to be tested. State the value 0 % for *Proportion first* when sector 2 is to be tested. Place Automower® in the charging station and select the *Test OUT* (3-2-5) function. The mower will now leave the charging station directly according to the settings under *Exit angles*. Reset the *Proportion first* value when testing is finished. For more information about *Test OUT* (3-2-5), see page 55.

### Follow loop (3-2)

These functions in this sub-menu are for situations when the mower needs to be guided to reach remote areas, to find the charging station more easily, and to determine at what distance the mower shall follow the loop. You will also find test functions here to see how different charge exit settings work and how the mower finds its way into the charging station.

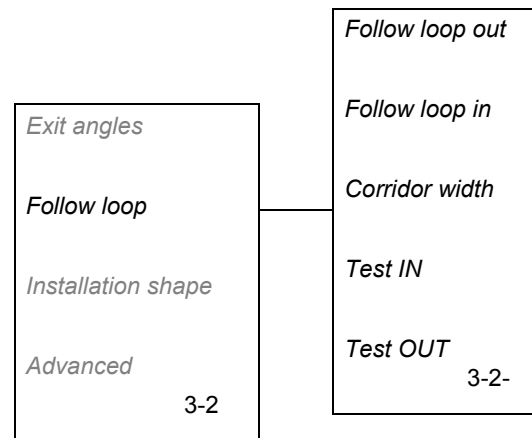

- **Follow loop out (3-2-1)**

This function means that Automower® can be set to follow the boundary wire or a guide wire away from the charging station to reach a more remote area of the garden. This function is very useful in gardens where the front and back are joined by a passage where the charging station cannot be placed.

When this function is activated Automower® will follow the boundary wire or guide wire away from the charging station in the set direction. It will start mowing when it reaches the area.

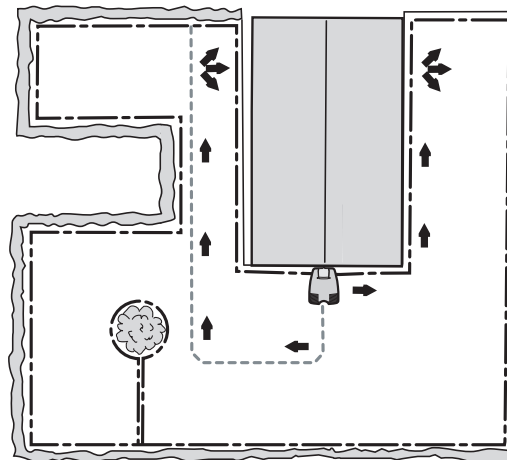

## 6. MENU FUNCTIONS

Up to five remote areas can be activated: *Area 1*, *Area 2*, *Area 3*, *Area 4* and *Area 5* (only three areas on 220 AC). Three values need to be stated to activate an area:

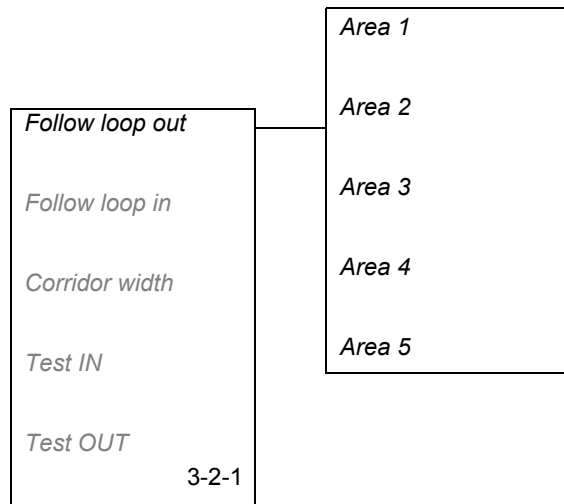

- **Direction**

Specify to the right, left, guide 1 or guide 2 depending on which direction the area lies from the charging station. The direction is set looking at the charging station in the approach direction of the mower.

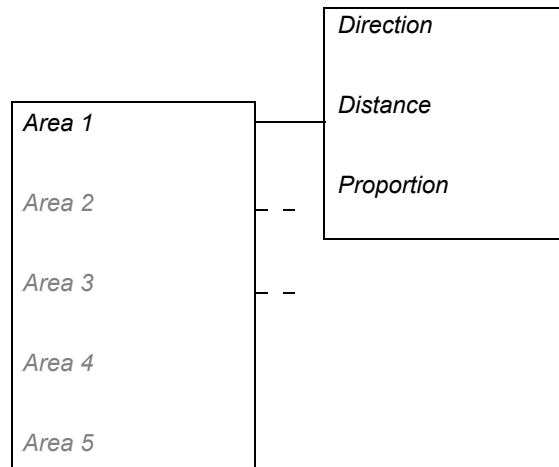

When a guide wire is installed the direction can be specified as the guide wire. The mower will now follow the selected guide wire instead of the boundary wire, (only guide 1 is available on 220 AC).

- **Distance**

Specify the number of metres along the boundary wire or guide wire from the charging station to the place in the remote area where the mower shall start mowing.

Tip! Use the *Test OUT* (3-2-5) function (see page 55) to find out how far it is to the remote area. The distance, stated in meters, will appear on the mower display.

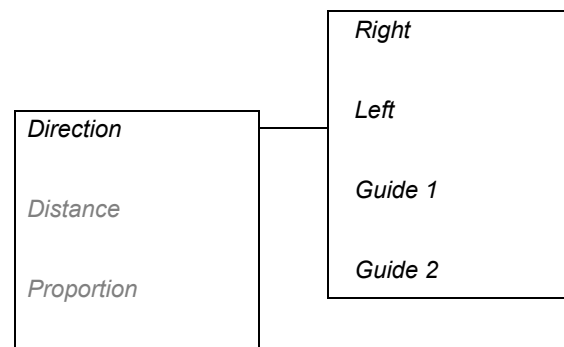

- **Proportion**

Specify a value for how often of the occasions Automower® leaves the charging station it should follow the loop out to the remote area.

For example the value 20 % means that in 20 % of the occasions Automower® leaves the charging station, it does it in the direction to the remote area. In the remaining 80 % of the occasions the mower leaves the charging station according to the setting made for its function *Exit angles* (3-1).

If a value of 20 % is specified for Area 1 and 10 % for Area 2, the remaining 70 % is allocated to the selection under *Exit angles* (3-1).



## 6. MENU FUNCTIONS

- *Follow loop in (3-2-2)*

This function is used to control how Automower® searches for the charging station.

Automower® always starts the search for the charging station in an irregular search method. In some gardens this is not sufficient for the mower to quickly find the charging station. The search can then be epitomized using the *Follow loop in* function.

When the mower still can not find the charging station after a specific period of irregular searching, it also starts to search for the guide wires and after a further period also the boundary wire to follow one of them into the charging station instead. This time is stated in minutes, and delays searching for guide 1, guide 2 and the boundary wire.

The delay time can be adapted to the shape of the garden in the *Follow loop in* function.

Automower® has a default delay setting of 4 minutes for guide 1 and guide 2 and 11 minutes for the boundary wire. A delay of 99 minutes means that the function is deactivated.

If both search methods are to be activated, it is possible for example to set 4 minutes for Guide 1 delay and Guide 2 delay and 9 minutes for Boundary delay. Automower® then searches irregularly for 4 minutes and then searches for the guide wires for 5 minutes. If by this time it has not found one of the guide wires, the mower will now search for both the boundary wire and guide wires.

If it is not suitable in the installation to follow the boundary wire, 99 minutes should be specified as the delay for the boundary wire.

It is of course possible to specify the same delay time for both the guide wires and the boundary wire, e.g. 5 minutes. Automower® then searches irregularly for 5 minutes and when it does not find the charging station, it continues to search either by following the guide wires or the boundary wire, depending on which one it reaches first. Different delay times can also be chosen for guide 1 and guide 2.

The mower does not change the search method: If the mower starts to follow the boundary wire it will not switch to follow a guide wire.

(Automower® 220 AC only has guide 1)

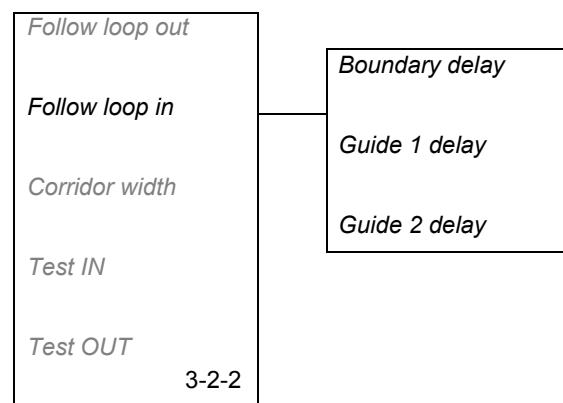
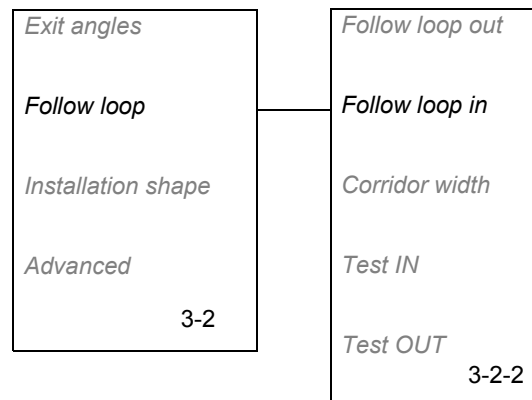

## 6. MENU FUNCTIONS

- *Corridor width (3-2-3)*

The *Corridor width* setting defines the distances from the mower's path to the boundary wire or the guide wire when following these to/from the charging station. The area beside the wires used by the mower is called the *Corridor*.

A low corridor width value represents a narrow corridor while a high value represents a wide corridor. With a narrow corridor Automower® always runs close to the boundary wire respective guide wire. With a wide corridor Automower® varies how it runs, i.e. close to and further from the boundary wire respective guide wire.

Corridor width is a relative distance and is stated on a scale from 0 to 20. The lower the *Corridor width* value the closer Automower® follows the boundary wire and/or guide wire.

Different corridor widths can be set for the boundary wire, guide 1 and on guide 2. The default setting on Automower® is set to a value of 10 for both the boundary wire and guide wires.

The higher the stated *Corridor width* value, the less risk there is of tracks forming. However, a high corridor value means that Automower® may find it difficult to enter passages.

A garden with large open areas should have a wide *Corridor*, i.e. a high *Corridor width* value. A garden with passages should have a narrow *Corridor*, i.e. a low value for the *Corridor width*.

When the value is set to 0 for the *Corridor width*, Automower® will run along the boundary wire, which means it will run with half the mower inside the loop and half the mower outside. As there are often flower beds, hedges and walls along with the boundary wire *Corridor width* 0 is not normally recommended. Should you still like to state this value, the boundary wire must lay 16" (40 cm) from solid objects instead of the normal 14" (35 cm).

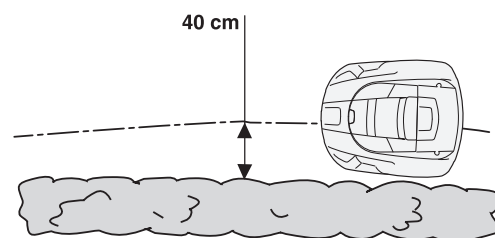
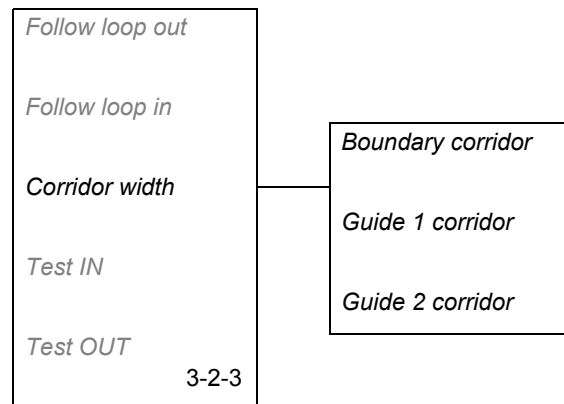
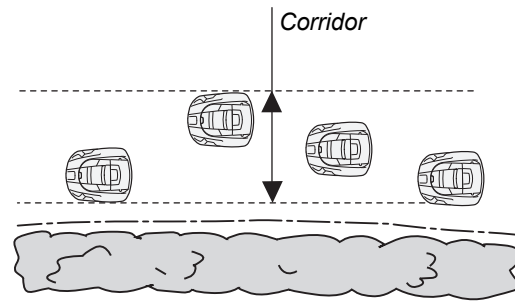

### IMPORTANT INFORMATION

The distance at which the mower follows the boundary wire varies depending on how the working area appears. You should perform some tests to find the highest possible *Corridor width*. Use the *Test IN (3-2-4)* function to try different values.

## 6. MENU FUNCTIONS

- *Test IN (3-2-4)*

The *Test IN (3-2-4)* function is used to test how Automower® finds its way into the charging station.

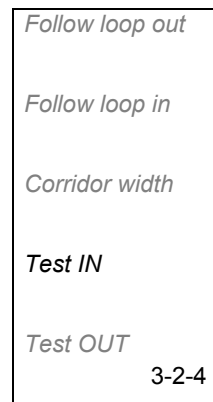

When the function is selected the mower will immediately follow the boundary wire, guide 1 or guide 2, depending on which one it finds first, in to the charging station. If there is a passage and the mower can not run through it, the *Corridor width* value is set too high. When Test IN is activated, the mower runs at the greatest distance from the wire that the selected corridor width permits.

The adjacent picture shows how Automower® negotiates a passage when a value of 8 is set for the *Corridor width*, but not when a value of 10 is set.

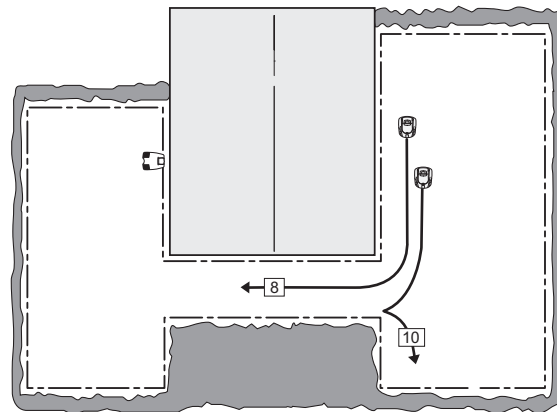

### IMPORTANT INFORMATION

**When *Test IN (3-2-4)* is used, the house icon on the display will come on and the mower will remain in the charging station. Press the Home button to return to operations.**

- *Test OUT (3-2-5)*

The *Test OUT (3-2-5)* function is used to try different charge exit settings and to find out how far it is from the charging station to a remote area.

To test the settings for *Follow loop out (3-2-1)*:

- State the value 100 % for *Proportion* for the remote area to be tested and 0 % for the other areas. Place Automower® in the charging station and select *Test OUT (3-2-5)*. The mower will now leave the charging station directly according to the stated direction and start mowing after the stated distance. Reset the *Proportion* values when testing is finished.

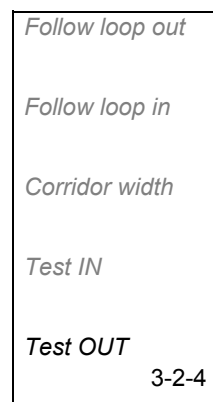

## 6. MENU FUNCTIONS

To find out the distance from the charging station to a remote area:

- State a distance that easily exceeds the true distance. The maximum distance that can be stated is 1600 ft (500 meters). State the value 100 % for *Proportion* for the area to which the distance is to be measured and 0 % for the other areas. Place Automower® in the charging station and select *Test OUT (3-2-5)*. The mower will now leave the charging station directly according to the stated direction. The distance will be shown on the display, stated in meters, as the mower runs. Stop the mower after the required distance and read the distance. Enter the number of metres shown in *Distance* for the area in question. Reset the *Proportion* values when testing is finished.

### Installation shape (3-3)

Automower® can be set according to three installation shapes: *Open*, *Normal* and *Complex*.

This setting affects how Automower® covers a working area when it mows. Above all it influences the turning angles and how often the mower changes direction. The *Open* setting optimizes the pattern of movement for an open garden. If the garden contains a lot of small areas linked with passages a better function will be obtained with the *Complex* setting. Select:

- *Open (3-3-1)*  
for an open lawn area with few obstacles and no passages.  
when steep slopes give an uneven mowing result.
- *Normal (3-3-2)*  
for an average number of obstacles and/or passages.
- *Complex (3-3-3)*  
for a large lawn area and large number of obstacles and/or passages.

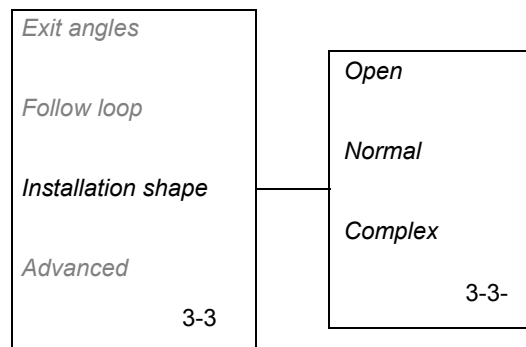

### Advanced (3-4)

- *Drive past wire (3-4-1)*

The front of Automower® always passes the boundary wire by a specific distance before the mower turns. The default distance is 11" (27 cm), but this can be changed if required. The minimum value is 6" (15 cm) and the maximum value is 20" (50 cm).

To adjust the distance: Move the cursor to *Drive past wire* and press **YES**. Now specify the number of centimeters you want Automower® to pass the boundary wire.

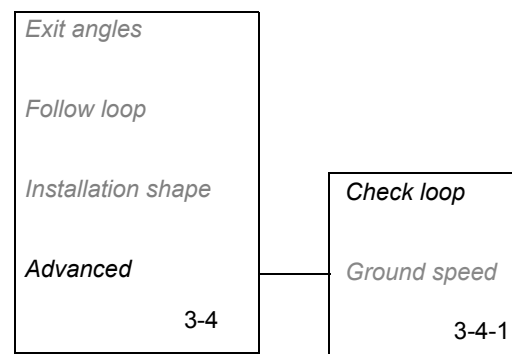

## 6. MENU FUNCTIONS

- **Ground speed (3-4-2)**

When Automower® is run on areas smaller than the recommended maximum area, the speed can be reduced. The advantage of this is reduced wear on the mower and somewhat more even speed on steep hills.

To change the speed: Set the marker to *Ground speed* and press **YES**. Then choose between *Normal* and *Reduced* speed by moving the marker to your selection and pressing **YES**.

(Speed setting not available on 220 AC)

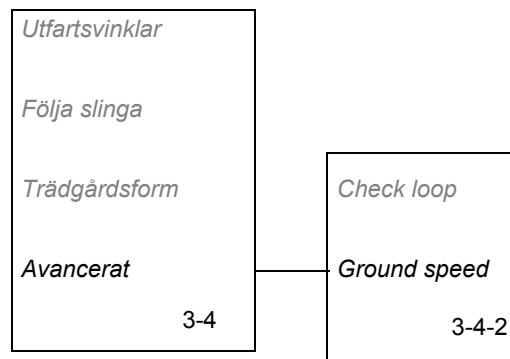

### 6.6 Settings (4)

From this option in the main menu you access the settings.

- **Security (4-1)**

to make settings concerning PIN code, time lock and alarm. The PIN code must be specified for the *Security* menu to be shown.

- **Sounds (4-2)**

to activate/deactivate audio messages for mower activities and to activate/deactivate keypad sounds.

- **Language (4-3)**

to select the menu language.

- **Time and date (4-4)**

to set the current time and day as well as the required time and date format.

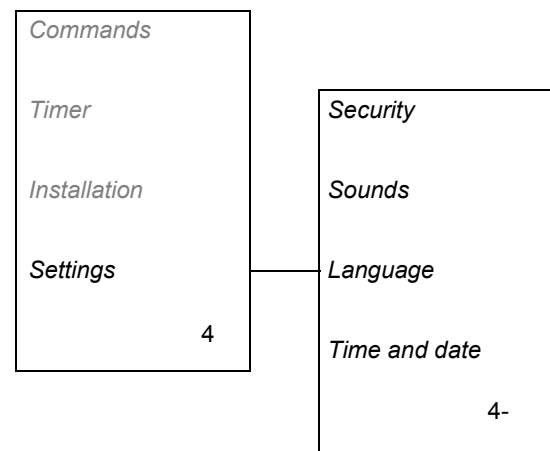

### Security (4-1)

- **PIN code (4-1-1)**

Via this function you can change your PIN code at any time.

- To change the PIN code: Move the cursor to *PIN code* and press **YES**. Place Automower® in the charging station. Enter the new PIN code and press **YES**. Enter the same code again to confirm, and press **YES**.

When the PIN code has been changed, the message *PIN code changed* is displayed for a few seconds. The *Security* menu will then appear again.

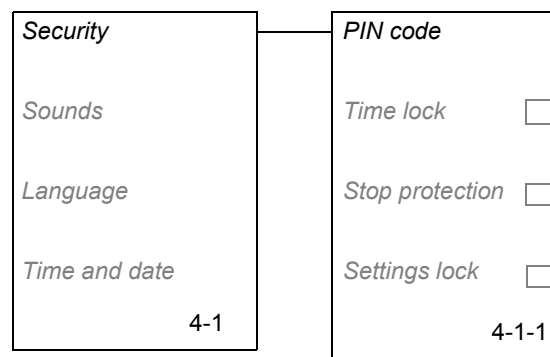

## 6. MENU FUNCTIONS

- *Time lock (4-1-2)*

This function partly involves Automower® stopping to mow after a predetermined number of days and not continuing until the correct PIN code has been entered, and partly that the PIN code must be entered when the main switch is set to the *ON* position. The default setting on Automower® is 30 days, but can be changed as required.

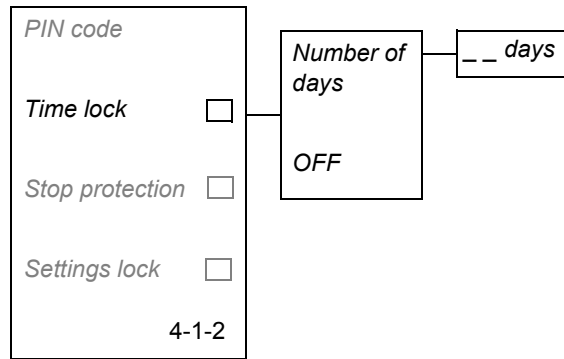

**IMPORTANT INFORMATION**

***Time lock* is the most important theft-prevention function. Accordingly, it is recommended to have this activated.**

To:

- **Activate:** Move the cursor to *Time lock* and press **YES**. Now move the cursor to *Number of days* and press **YES**. Specify how many days you would like Automower® to mow before it requests the PIN code. Finish by pressing **YES**.

When the selected number of days has elapsed, Automower® completes mowing and charges the battery. The message *Enter PIN code* is then shown on the display. You then enter your code and press **YES**.

In addition, Automower® will now request the PIN-code each time the main switch is switched to **ON**.

- **Deactivate:** Move the cursor to *Time lock* and press **YES**. Now move the cursor to *OFF* and press **YES**.

- *Alarm (4-1-3)*

This function means that the first digit of the PIN code must be entered within 10 seconds after the **STOP**-button has been pressed or the mower has been lifted up for any reason. If the correct number is not entered after three attempts, the alarm sounds. The alarm can then be stopped by entering the complete PIN code.

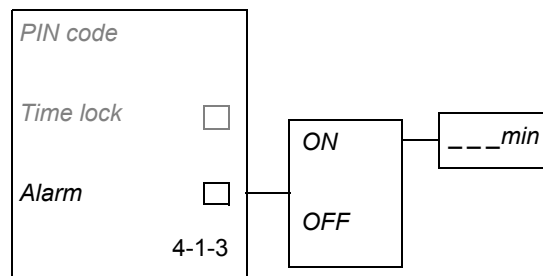

**IMPORTANT INFORMATION**

**The alarm can be activated on the mower using the *Alarm* function. It is recommended that this function is used.**

## 6. MENU FUNCTIONS

To:

- **Activate:** Move the cursor to *Alarm* and press **YES**. Select *ON* to activate and press **YES**. Then specify for how long the alarm should sound, by answer the question *Duration of alarm?*
- **Deactivate:** Move the cursor to *Alarm* and press **YES**. Select *OFF* to deactivate and press **YES**. When you select *OFF*, the alarm function is also deactivated.

### Sounds (4-2)

A number of audio messages are used to indicate what Automower® is currently doing.

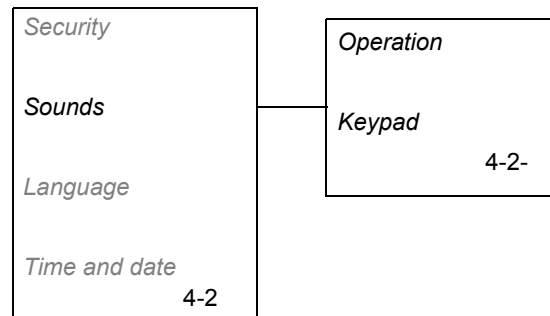

- **Operation (4-2-1)**

To activate: Move the cursor to *Operation* and press **YES**. Select *ON* and press **YES**.

To deactivate: Move the cursor to *Operation* and press **YES**. Select *OFF* and press **YES**.

5 beeps are heard over 2 seconds when the blade disc starts. This sound can not be deactivated.

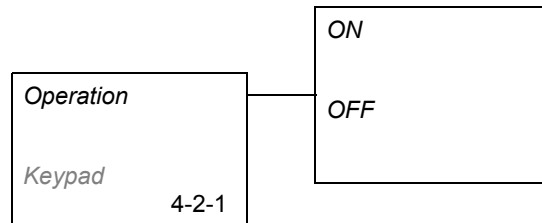

- **Keypad (4-2-2)**

To activate: Move the cursor to *Keypad* and press **YES**. Select *ON* and press **YES**.

To deactivate: Move the cursor to *Keypad* and press **YES**. Select *OFF* and press **YES**.

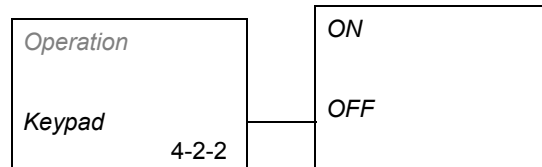

Sound	Significance
2 beeps/10 seconds	Charging
5 beeps over 2 seconds	Starting blade disc
3 beeps/second	Fault message
One long beep	Blade disc blocked
Short click sound	A button on the keypad has been pressed
Muffled long beep	Incorrect input
	The mower is removed from the charging station manually while charging is in progress.
Short double beep	A change to the setting has been made
	The mower is placed in the charging station manually.



## 6. MENU FUNCTIONS

### Language (4-3)

Using this function you can change the language selection you made when Automower® was first started.

To select the language: Move the cursor to *Language* and press **YES**. Now move the cursor to the required language and press **YES**.

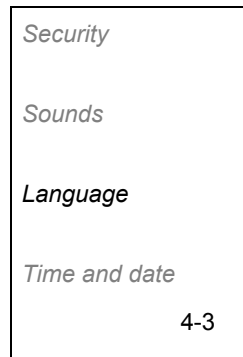

### Time and date (4-4)

Using this function you can change the time and date on Automower®.

You can also change the format selections you made when Automower® was first started via this function.

- *Set time (4-4-1)*  
Move the cursor to *Set time* and press **YES**. Now enter the correct time and finish with **YES**.
- *Set date (4-4-2)*  
Move the cursor to *Set date* and press **YES**. Now enter the correct date and finish with **YES**.
- *Time format (4-4-3)*  
Move the cursor to *Time format* and press **YES**.  
Move the cursor to the required time format:
  - 12h
  - 24h
 Finish by pressing **YES**.
- *Date format (4-4-4)*  
Move the cursor to *Date format* and press **YES**.  
Move the cursor to the required date format:
  - YY-MM-DD (year-month-day)
  - MM-DD-YY (month-day-year)
  - DD-MM-YY (day-month-year)
 Finish by pressing **YES**.

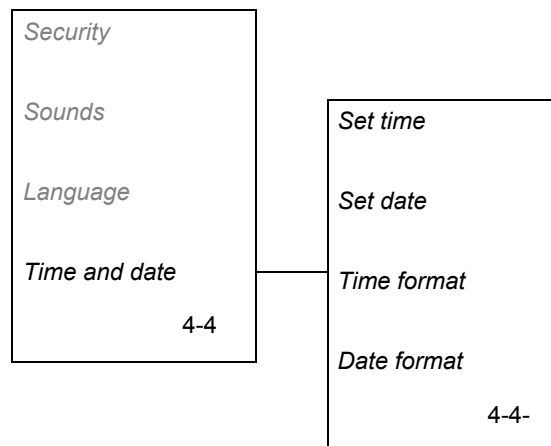

## 7. GARDEN EXAMPLE - PROPOSED INSTALLATION

### 7. Garden example - Proposed installation and settings

The behavior of the mower is controlled by the settings that are made. Adapting the mower's garden settings according to the shape of the garden makes it easier for Husqvarna Automower® to frequently reach all parts of the garden and in doing so achieve a perfect mowing result.

Different gardens require different settings. A number of garden examples and proposed installations and settings are presented on the following pages. Functions where the settings deviate from the mower's default settings are shown in **bold**.

For further and more detailed information about the different settings, see chapter 6. *Menu functions* on page 45.

#### IMPORTANT INFORMATION

**The default setting for Automower® has been chosen to work on as many different gardens as possible. The settings only need to be adjusted when special installation conditions exist, for example, narrow passages.**

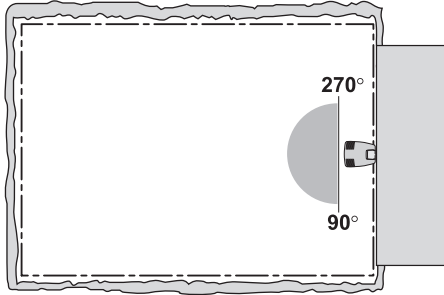
Proposals for installation and settings	
<p>Area: 0.1 acre (400m<sup>2</sup>). No default settings, except Timer, need to be changed.</p> <p><b>Timer:</b> Operating time of 5 hours per day.</p> <p><b>Exit angles:</b> One sector 90° - 270°.</p> <p><b>Search method:</b> Irregular.</p> <p><b>Delay:</b> Guide1, 4 minutes, Guide2, 74 minutes, and boundary wire 11 minutes.</p> <p><b>Corridor width:</b> 10</p>	

## 7. GARDEN EXAMPLE - PROPOSED INSTALLATION

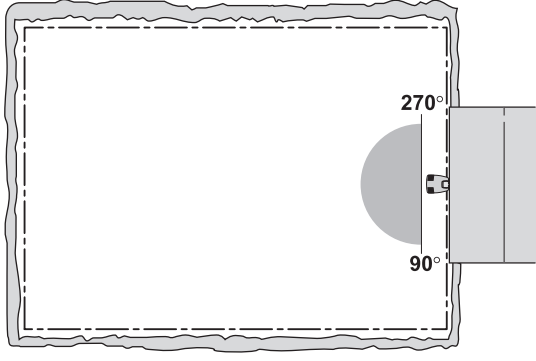
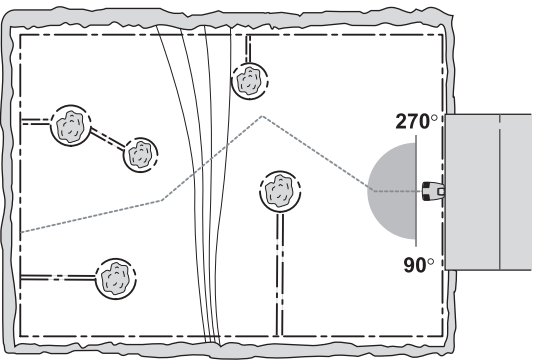
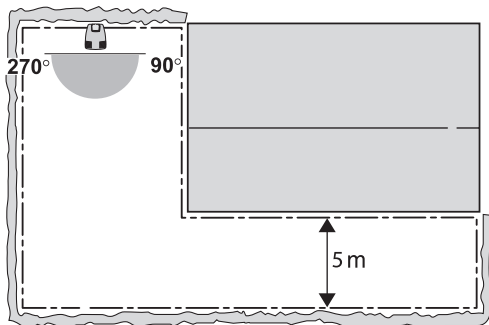
Proposals for installation and settings	
<p>Area: 0.5 acre (1,800m<sup>2</sup>). No guide wire is necessary.</p> <p><b>Timer:</b> Operating time of 24 hours per day.</p> <p><b>Exit angles:</b> One sector 90° - 270°.</p> <p><b>Search method:</b> Irregular and Follow boundary wire in.</p> <p><b>Delay:</b> Guide1, 4 minutes, Guide2, 4 minutes, and boundary wire 11 minutes.</p> <p><b>Corridor width:</b> Boundary wire 20</p>	
<p>Area: 0.5 acre (1,800m<sup>2</sup>). A number of islands and a steep slope along the boundary wire. Guide wire recommended.</p> <p><b>Timer:</b> Operating time of 24 hours per day.</p> <p><b>Exit angles:</b> One sector 90° - 270°.</p> <p><b>Search method:</b> Irregular and Follow guide wire in.</p> <p><b>Delay:</b> Guide1, 4 minutes, Guide2, 4 minutes and boundary wire 99 minutes. Automower® is never permitted to follow the boundary wire.</p> <p><b>Corridor width:</b> Guide1 20, Guide2 20</p>	
<p>Area: 0.15 acre (600 m<sup>2</sup>). L-shaped garden with the charging station placed in the large open area. No guide wire is necessary.</p> <p><b>Timer:</b> Operating time of 8 hours per day.</p> <p><b>Exit angles:</b> One sector 90° - 270°.</p> <p><b>Search method:</b> Irregular and Follow boundary wire in.</p> <p><b>Delay:</b> Guide1, 4 minutes, Guide2, 4 minutes and boundary wire 11 minutes.</p> <p><b>Corridor width:</b> Boundary wire 20</p>	

## 7. GARDEN EXAMPLE - PROPOSED INSTALLATION

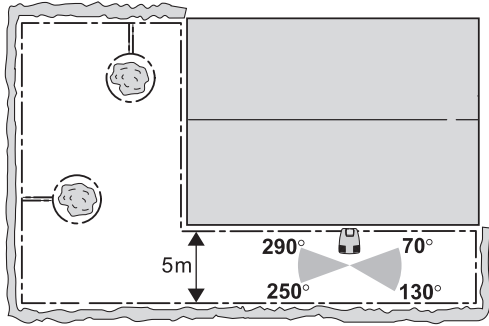
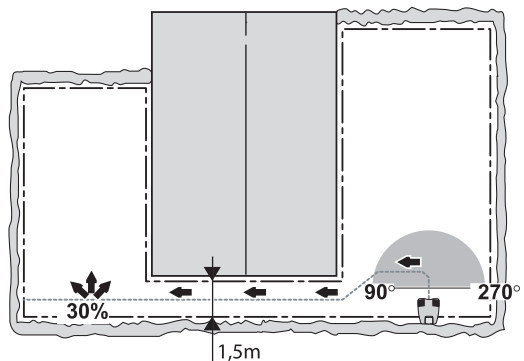
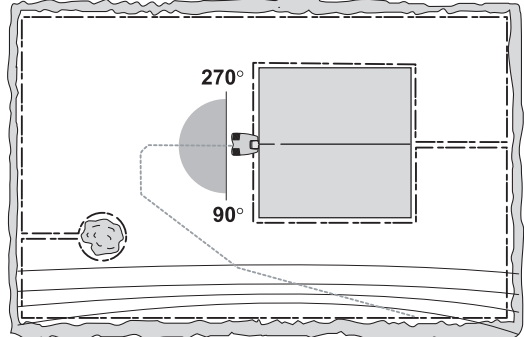
Proposals for installation and settings	
<p>Area: 0.15 acre (600 m<sup>2</sup>). L-shaped garden with the charging station placed in the narrow area. There are two islands. No guide wire is necessary.</p> <p><b>Timer:</b> Operating time of 8 hours per day.</p> <p><b>Exit angles:</b> Sector 1 70° - 130° and Sector 2 250° - 290°. <i>Proportion first 10 %.</i></p> <p>Search method: Irregular and Follow boundary wire in.</p> <p><b>Delay:</b> Guide1, 4 minutes, Guide2, 4 minutes and boundary wire 11 minutes.</p> <p><b>Corridor width:</b> 10</p>	
<p>Area: 0.17 acre (700 m<sup>2</sup>). U-shaped garden with the charging station placed on one of the large open areas. Guide wire recommended through the passage.</p> <p><b>Timer:</b> Operating time of 10 hours per day.</p> <p>Exit angles: One sector 90° - 270°.</p> <p><b>Follow loop out:</b> Direction Guide 1, Distance 25 meters (80 ft) and <i>Proportion 30 %.</i></p> <p>Search method: Irregular and Follow guide wire in.</p> <p><b>Delay:</b> Guide1, 3 minutes, Guide2, 4 minutes and boundary wire 99 minutes. Automower® is never permitted to follow the boundary wire.</p> <p><b>Corridor width:</b> Guide1 3</p>	
<p>Area: 0.20 acre (800 m<sup>2</sup>). Rectangular garden with the charging station placed by an island. A large part of the boundary wire is routed on a slope that is steeper than 10 %. Guide wire recommended.</p> <p><b>Timer:</b> Operating time of 10 hours per day.</p> <p>Exit angles: One sector 90° - 270°.</p> <p>Search method: Irregular and Follow guide wire in.</p> <p><b>Delay:</b> Guide1, 4 minutes, Guide2, 4 minutes and boundary wire 99 minutes. Automower® is never permitted to follow the boundary wire.</p> <p><b>Corridor width:</b> Guide1 20</p>	

## 7. GARDEN EXAMPLE - PROPOSED INSTALLATION

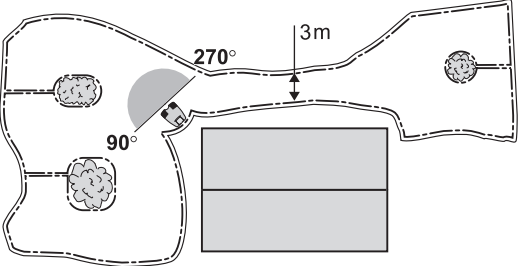
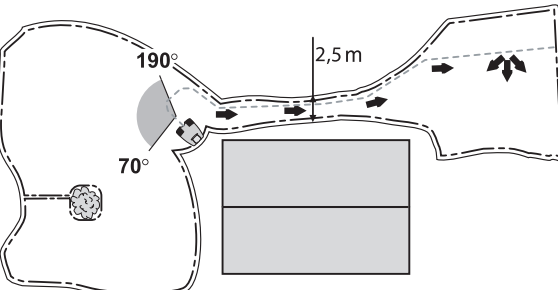
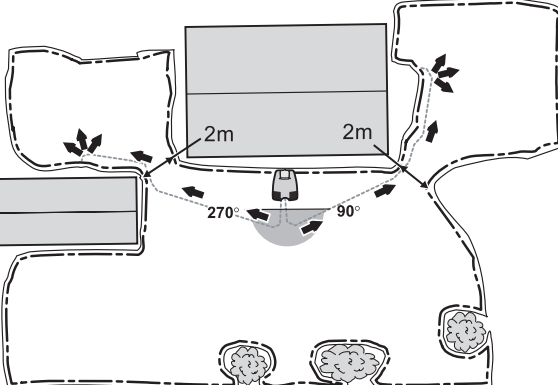
Proposals for installation and settings	
<p>Area: 0.12 acre (500 m<sup>2</sup>). There are several islands. No guide wire is necessary. The mower's default settings do not need to be changed.</p> <p><b>Timer:</b> Operating time of 7 hours per day.</p> <p><b>Exit angles:</b> One sector 90° - 270°.</p> <p>Search method: Irregular.</p> <p>Delay: Guide1, 4 minutes, Guide2, 4 minutes and boundary wire 11 minutes.</p> <p><b>Corridor width:</b> 10</p>	
<p>Area: 0.25 acre (1,000 m<sup>2</sup>). There is one small island. Guide wire recommended through the passage.</p> <p><b>Timer:</b> Operating time of 14 hours per day.</p> <p><b>Exit angles:</b> One sector 70° - 190°.</p> <p><b>Follow loop out:</b> Direction Guide 1, Distance 20 m (65 ft) and Proportion 25 %.</p> <p>Search method: Irregular, Follow guide wire in and Follow boundary wire in.</p> <p>Delay: Guide1, 4 minutes, Guide2, 4 minutes and boundary wire 11 minutes.</p> <p><b>Corridor width:</b> Guide1 7, boundary wire 20</p>	
<p><b>This example only applies to 230 ACX.</b></p> <p>Area: 0.5 acre (2200 m<sup>2</sup>). Two guide wires are recommended.</p> <p><b>Timer:</b> Operating time of 19 hours per day.</p> <p><b>Exit angles:</b> One sector 90°-270°.</p> <p><b>Follow loop out:</b> Area 1; Direction Guide 1, Distance (100 ft (30 metres)) and Proportion 15 %. Area 2; Direction Guide 2, Distance (100 ft (30 metres)) and Proportion 30 %.</p> <p>Search method: Irregular, Follow guide wire in and Follow boundary wire in.</p> <p><b>Delay:</b> Guide1, 2 minutes, Guide2, 2 minutes and boundary wire 11 minutes.</p> <p><b>Corridor width:</b> Guide1 4, Guide2 4, and boundary wire 6.</p>	

## 7. GARDEN EXAMPLE - PROPOSED INSTALLATION

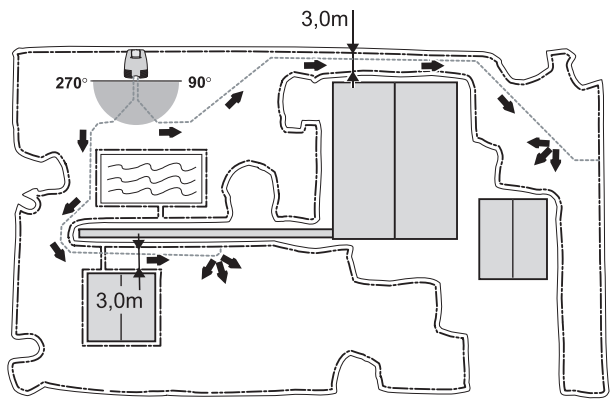
Proposals for installation and settings	
<p><b>This example only applies to 230 ACX.</b>                      Area: 0.75 acre (3000 m<sup>2</sup>). Two guide wires are recommended.</p> <p><i>Timer:</i> Operating time of 24 hours per day.  <i>Exit angles:</i> One sector 90° - 270°.</p> <p><b>Follow loop out:</b> Area 1; <i>Direction Guide 1, Distance 130 ft (40 meters)) and Proportion 20 %.</i> Area 2; <i>Direction Guide 2, Distance 100 ft (30 metres)) and Proportion 40 %.</i></p> <p><i>Search method:</i> Irregular, Follow guide wire in and Follow boundary wire in.</p> <p><b>Delay:</b> Guide1, 2 minutes, Guide2, 2 minutes and boundary wire 11 minutes.</p> <p><b>Corridor width:</b> Guide1 8, Guide2 8, and boundary wire 8.</p>	

---

## 8. MAINTENANCE

---

### 8. Maintenance

Check and clean Husqvarna Automower® regularly and replace worn parts if necessary to improve operating reliability and to ensure a longer service life. For further information on cleaning, see *8.5 Cleaning* on page 68.

During the initial period Automower® is used the blade disc, skid plate and blades should be checked once a week. If the amount of wear during this period has been low, the inspection interval can be increased.

It is important that the blade disc rotates easily. In addition the skid plate should rotate easily in relation to the blade disc. The edges of the blades should not be damaged. The service life of the blades depends on:

- Operating time and size of the working area.
- Type of grass.
- Type of soil.
- The presence of objects such as cones, windfalls, toys, tools, stones, roots and the like.

The service life can vary greatly, but is normally 2 - 4 weeks of operation over areas larger than 0.25 acre (1,000 m<sup>2</sup>) and longer in smaller areas. To replace the blades, see *8.6 Replacing the blades* on page 70.

#### IMPORTANT INFORMATION

**Working with dull blades gives a poorer mowing result. The edges of the grass are not cut clean and more energy is needed resulting in Automower® not mowing such a large area.**

### 8.1 Battery

The battery is maintenance-free, but has a limited life span of 1 - 4 years.

Battery life is dependent on the length of the season and how many hours per day Automower® is used. A long season or many hours of use per day, means that the battery must be replaced more regularly.

#### IMPORTANT INFORMATION

**Charge the battery fully at the end of the season before winter storage.**



## 8. MAINTENANCE

### 8.2 Winter storage

#### Automower®

Automower® must be carefully cleaned before winter storage, see *8.5 Cleaning* on page 68.

Charge the battery fully before winter storage. Turn the main switch to the *OFF* position.

For maximum battery life, in addition to be fully charged before winter storage the battery should also be fully loaded twice during winter storage. The charging station must then be connected to a 230 V wall socket via the low voltage cable and transformer (with or without connecting the boundary wire). Now place the mower in the charging station with the main switch set to ON and check that the control panel cover is open. The charger should be charged for about 24 hours. Remove the mower from the charging station and turn OFF main switch.

Store the mower standing on all four wheels in an area that is dry and free from frost, preferably in the original packaging, or hung on the wall with the help of Automower® wall bracket (504 82 13-01).

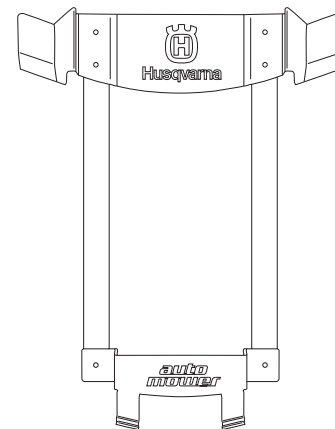
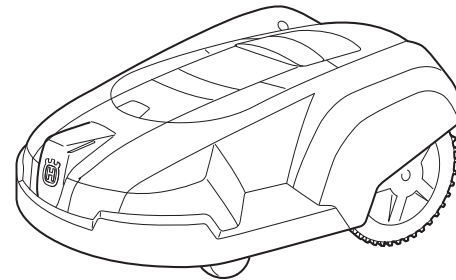

#### Charging station

If possible store the charging station, transformer and low voltage cable indoors. The boundary wire can be left in the ground. If the charging station is taken in you should protect the ends of the boundary wire from moisture by placing them, for example, in a tin with grease. If indoor storage is not possible the boundary wire should remain connected. The charging station should remain connected to the mains supply. When using Automower® house (504 82 14-01), then in the lowered position, the charging station can ideally be left outdoors even during the winter.

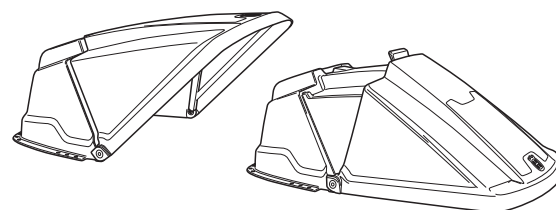
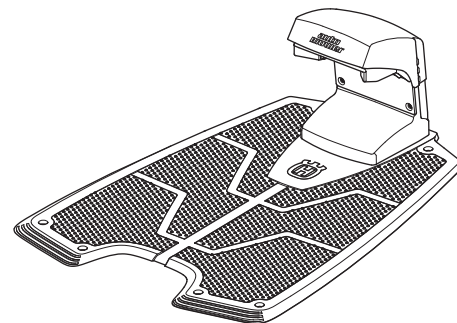

## 8. MAINTENANCE

### 8.3 Service

Leave your Automower® to a dealer for service prior to winter storage. This is essential in order to keep the mower in a good condition.

Service usually includes the following:

- Thorough cleaning of body, chassis, blade disc, skid plate and all other moving parts.
- Testing of the mower's function and components.
- Checking of wear components such as mower blades and bearings.
- Testing of the mower's battery capacity as well as a recommendation of change if necessary.
- Relubrication of both chassis halves of the mower in order to maintain moisture and wetness resistance.
- If necessary the dealer can also load Automower® with new software, possibly including newly added features.

### 8.4 After winter storage

Check whether Automower®, contact strips and charging strips need to be cleaned before using. If the charging or contact strips appear to be burnt, clean them using fine grade emery cloth. Check that the mower's time and date are correct.

### 8.5 Cleaning

It is important to keep Automower® clean. A mower with a large amount of clippings negotiates slopes very poorly. It is recommended to clean using a brush.

#### IMPORTANT INFORMATION

**Never use a high-pressure washer or even running water to clean the Automower®.  
Solvent must never be used when cleaning.**

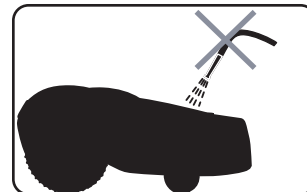

#### Underframe and blade disc

1. Set the main switch to the *OFF* position.
2. Wear protective gloves.
3. Lift Automower® onto its side.

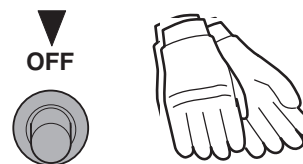

## 8. MAINTENANCE

4. Clean the blade disc and underframe using, e.g. a dish-brush.

At the same time, check that the blade disc rotates freely in relation to the motor support, directly above. Check also that the skid plate rotates freely in relation to the blade disc.

If long blades of grass or other objects work their way in this can brake the blade disc and/or skid plate. Even a slight braking effect leads to a higher consumption of energy and longer mowing times, and at the worst will prevent the mower from being able to mow a large lawn. If more thorough cleaning is necessary the skid plate, and possibly the blade disc, must be dismantled. If necessary, contact your dealer.

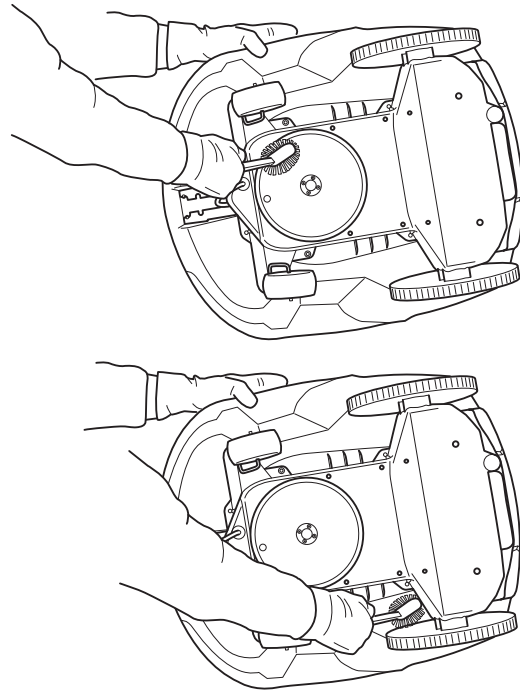

### Chassis

Clean the underside of the chassis. Brush or wipe with a damp cloth.

#### IMPORTANT INFORMATION

**Do not use running water when cleaning.**

### Wheels

Clean around the front and rear wheels and around the front wheel suspension.

### Body

Use a damp, soft sponge or cloth to clean the body. If the body is very dirty it may be necessary to use a soap solution or washing-up liquid.

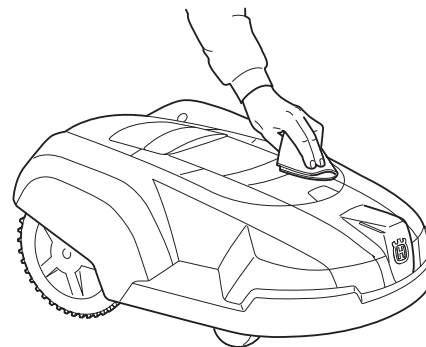

## 8. MAINTENANCE

### 8.6 Replacing the blades



#### WARNING

**Always use original blades and screws when replacing. Only replacing the blades and reusing the screw can result in the screw wearing during mowing and shearing off. The blades can then be thrown out and cause serious injury.**

All three blades and screws must be replaced at the same time to obtain a balanced mowing system.

There are several different types of mower blades to choose from as accessories, with different features. Use Husqvarna AB approved blades only. Please contact your dealer for more information.

To replace the blades:

1. Set the main switch to the *OFF* position.
2. Wear protective gloves.
3. Turn Automower® upside down.
4. Rotate the skid plate so that its hole aligns with the screw for the blade.
5. Unscrew the blade. Use a straight slot or cross-tip screwdriver.
6. Pry apart the skid plate and blade disc a little and remove the blade and screw.
7. Screw tight the new blade.

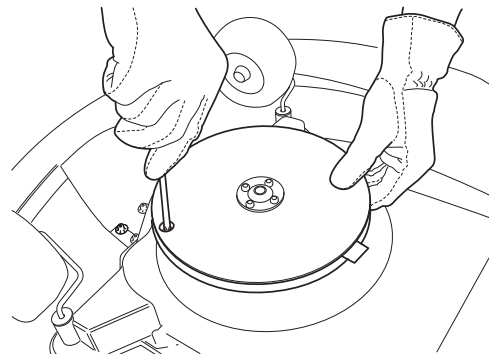

## 8. MAINTENANCE

### 8.7 In the event of a thunderstorm

To reduce the risk of damage to components in the robotic lawnmower, we recommend that all connections to the charging station are disconnected (power supply, boundary wire and guide wire) if there is a risk of a thunderstorm.

To reduce the risk of damage to electrical components in the robotic lawnmower and its charging station, we recommend that all connections to the charging station are disconnected (power supply, boundary wire and guide wires) if there is a risk of a thunderstorm.

1. Make sure the wires are marked with the supplied markers to simplify reconnecting. The charging station's connections are marked AR, AL, G1, G2.
2. Disconnect all wires.
3. Close the cover to the charging station to protect the connections from rain.
4. Connect all the wires if there is no longer a risk of thunder. It is important that each wire is connected to the right place.

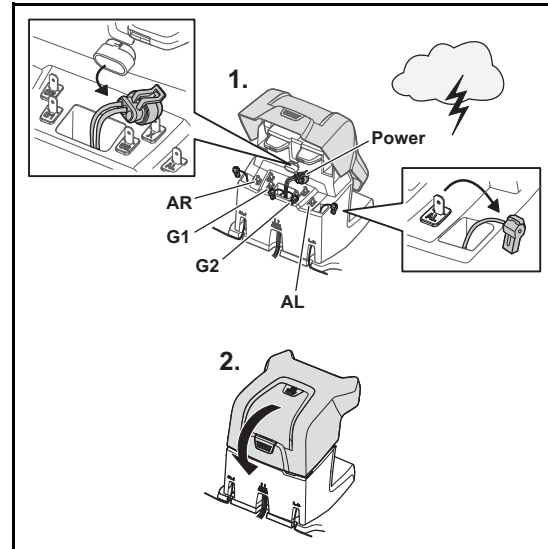

### 8.8 Transport and moving

Secure the machine during transport. It is important that the Automower® does not move around while being transported e.g. between different grass areas. There is an Automower® bag (522 91 67-01) designed especially to facilitate transport. Please contact your dealer for more information.

## 9. TROUBLE SHOOTING

### 9. Trouble shooting

#### 9.1 Fault messages

A number of fault messages are listed below that can be shown on Husqvarna Automower®. If the same fault occurs frequently: contact your dealer.

<b>Fault message</b>	<b>Cause</b>	<b>Action</b>
<i>Left wheel motor blocked</i>	Grass or other object has wrapped around the drive wheel.	Check the drive wheel and remove the grass or other object.
<i>Right wheel motor blocked</i>	Grass or other object has wrapped around the drive wheel.	Check the drive wheel and remove the grass or other object.
<i>Blade disc blocked</i>	Grass or other object has wrapped around the blade disc.	Check the blade disc and remove the grass or other object.
<i>No loop signal</i>	The transformer is not connected to the mains supply or its miniature circuit-breaker has tripped.	Check the wall socket connection and whether the miniature circuit-breaker has tripped.  Reset the miniature circuit-breaker by removing the transformer's power cord from the wall socket, wait 10 seconds and then reconnect the power cord in the wall socket again.
	Boundary wire broken.	Check the signal given by the LED on the charging station. If it flashes the loop is damaged. Repair the broken cable using an original waterproof coupler.
	The connection between Automower® and the charging station has been lost.	Place Automower® in the charging station and change the PIN-code via Settings - Security - PIN code (shortcut 4-1-1). You can use the same PIN code as earlier.
	This may be due to the boundary wire being routed in the wrong direction around an island, which blanks out the signal.	Check that the boundary wire has been routed correctly.
	If this occurs in isolated areas it may be due to interference from metallic objects (perimeter fence, reinforcement bar) or buried cables in the vicinity.	Try moving the boundary wire.
<i>Trapped</i>	Automower® has got caught in something.	Free Automower® and rectify the reason for it getting trapped.

## 9. TROUBLE SHOOTING

<b>Fault message</b>	<b>Cause</b>	<b>Action</b>
<i>Outside working area</i>	If this occurs in isolated areas it may be due to interference from metallic objects (perimeter fence, reinforcement bar) or buried cables in the vicinity.	Try moving the boundary wire.
	The working area slopes too much.	Check that the boundary wire has been routed correctly.
	The boundary wire has been routed the wrong way around an "island".	Check that the boundary wire has been routed in accordance with the installation instructions.
	The boundary wire is too close to the edge of the working area.	Check that the boundary wire has been routed correctly.
<i>Low battery voltage</i>	Automower® cannot find the charging station.	Change the search settings according to the <i>Follow loop in (3-2-2)</i> on page 53.
		Change the position of the charging station.
	The battery is spent.	Expected life is 1 - 4 years. Contact your dealer to replace the battery.
<i>Wrong PIN code</i>	Wrong PIN code has been entered. Three attempts are permitted, the keypad is then blocked for five minutes.	Enter the correct PIN code.
<i>No drive</i>	Automower® has got caught in something.	Free the mower and rectify the reason for the lack of drive. If it is due to wet grass, wait until the lawn has dried before using the mower. To keep the drive wheels clean and thus increase traction, use Automower® wheel brushes (505 13 27-01).
<i>No contact in charging station</i>	Automower® makes poor contact with the contact strips in the charging station.	Check that Automower® has docked correctly in the charging station.
<i>Charging station blocked</i>	The contact between the charging strips and contact strips may be poor and Automower® has made a number of charging attempts.	Place Automower® in the charging station and check that the charging strips and contact strips make good contact.
	An object is obstructing Automower®.	Remove the object.
<i>Stuck in charging station</i>	An object is preventing Automower® from reversing out of the charging station.	Remove the object.
<i>Upside down</i>	Automower® leans too much or has turned over.	Turn the mower the right way up.
<i>Needs manual charging</i>	Automower® is set in <i>MAN</i> operating mode.	This behavior is normal; no action required.



## 9. TROUBLE SHOOTING

### 9.2 Fault symptom

If your Automower® does not work correctly, follow the trouble shooting guide below. If the fault persists; contact your dealer.

Symptom	Cause	Action
<b>Uneven mowing results</b>	Automower® works too few hours per day.	Increase the mowing time, see <i>6.4 Timer (2)</i> on page 47.
	Working area too large.	Try limiting the working area or extending the working time, see <i>6.4 Timer (2)</i> on page 47.
	Dull blades.	Replace all the blades and screws so that the rotating parts are balanced.
	Long grass in relation to the set cutting height.	Increase the cutting height and then successively lower.
	The mower seems to work more at the top of a slope than at the bottom.	Change the Installation shape (3-3) setting to Open.
	Accumulation of grass by the blade disc or around the motor shaft.	Check that the skid plate and blade disc rotate easily. If not, the skid plate and perhaps the blade disc must be removed and the grass and foreign objects removed. See <i>8.5 Cleaning</i> on page 68.
<b>Automower® runs at the wrong time</b>	The clock on Automower® needs to be set.	Set the clock, see <i>Time and date (4-4)</i> on page 60.
	The start and stop times for mowing are incorrect.	Adjust the start and stop time settings for mowing, see <i>6.4 Timer (2)</i> on page 47.
<b>Automower® vibrates</b>	Unbalanced blade disc or damaged blades.	Inspect the blades and screws and replace them if necessary.
<b>Automower® runs, but the blade disc does not rotate</b>	Automower® is looking for the charging station.	No action. The blade disc does not rotate when the mower is searching for the charging station.
<b>The mower mows for shorter periods than usual between charges</b>	Grass or a foreign object is blocking the blade disc or skid plate.	Dismantle and clean the skid plate and blade disc.
<b>Both the mowing and charging times are shorter than usual</b>	This behavior is normal in high temperatures (gradually increasing above 77 °F (25 °C)).	No action.
<b>Automower® starts mowing directly outside of the charging station instead of following the loop out</b>		Change corridor width and/or reversing distance.

## 10. TECHNICAL DATA

### 10. Technical data

Data	Automower® 230 ACX	Automower® 220 AC
<b>Dimensions</b>		
Length	28" (71 cm)	28" (71 cm)
Width	21.7" (55 cm)	21.7" (55 cm)
Height	11.8" (30 cm)	11.8" (30 cm)
Weight	22 lbs (10.7 kg)	20 lbs (9.0 kg)
<b>Electrical system</b>		
Battery	NiMH special battery 18 V / 4.4 Ah	NiMH special battery 18 V / 2.2 Ah
Transformer	120 V (230 V) / 24 V	120 V (230 V) / 24 V
Low voltage cable length	20 m	20 m
Mean energy consumption at maximum use	40 kWh/month with a working area of 0.75 acre (3,000 m <sup>2</sup> )	25 kWh/month with a working area of 0.5 acre (1,800 m <sup>2</sup> )
Charge current	4A	1,75A
Average mowing time	60-90 min	40-60 min
Average charging time	45-60 min	45-60 min
<b>Noise emissions</b>		
Measured noise level	60 dB(A)	60 dB(A)
Guaranteed noise level	63 dB(A)	63 dB(A)
<b>Mowing</b>		
Mowing system	Three, pivoted cutting knife blades	Three, pivoted cutting knife blades
Blade motor speed	2500 rpm	2500 rpm
Power consumption during cutting	42 W +/- 20%	30 W +/- 20%
Cutting height	0.8" - 2.5" (2-6 cm)	0.8" - 2.5" (2-6 cm)
Cutting width	8" (22 cm)	8" (22 cm)
Narrowest possible passage	60 cm	60 cm
Maximum angle for cutting area	35 %	35 %
Maximum angle for boundary wire	20 %	20 %
Maximum length boundary wire	500 m (800 m with the signal amplifier accessory)	500 m (800 m with the signal amplifier accessory)
Working capacity	0.75 acre (3,000 m <sup>2</sup> ) +/- 20%	0.5 acre (1,800 m <sup>2</sup> ) +/- 20%

---

# 11. GUARANTEE TERMS

---

## 11. Guarantee terms

Husqvarna AB guarantees this product's functionality for a period of two years (from date of purchase). The guarantee covers serious faults relating to materials or manufacturing faults. Within the guarantee period, we will replace the product or repair it at no charge if the following terms are met:

- The robotic lawnmower and the charging station may only be used in compliance with the instructions in this Operator's Manual.
- Users or non-authorized third parties must not attempt to repair the product.

Examples of faults which are not included in the guarantee:

- Damage caused by water seepage from underneath the robotic lawnmower. This damage is normally caused by laundry or irrigation systems or holes/hollows in the working area when pools of water are formed when it rains.
- Damage caused by shortened low-voltage cable.
- Damage caused by lightning.
- Damage caused by incorrect battery storage or handling.
- Damage caused by using a battery that is not an original battery.
- Damage to the loop wire.
- Damage to the body or its suspension caused by improper storage.

The blades and wheels are seen as disposable and are not covered by the guarantee.

If a fault occurs with your robotic lawnmower, please contact the dealer (see Memo on page 4) for further instructions. Please have your receipt and product serial number to hand for quicker assistance.

---

## 12. ENVIRONMENTAL INFORMATION

---

### 12. Environmental information

The symbol on Husqvarna Automower® or its packaging indicates that this product may not be treated as household waste. It should instead be left at a suitable recycling centre to recycle its electronic components and batteries. Contact your dealer for a disassembly of the batteries.

By ensuring this product is disposed of correctly, you will help prevent potential negative consequences for the environment and human health, which could otherwise be caused by inappropriate waste handling of this product.

For more detailed information about recycling of this product, please contact your local council office, your household waste disposal service or the shop where you purchased the product.

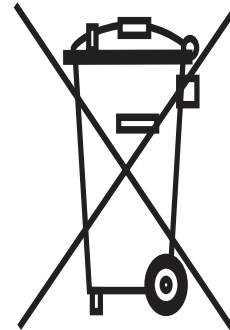

#### 12.1 Removing the battery for recycling

Follow these steps to remove the battery from the robotic lawnmower.

##### Disassembling the body

The body is fitted to the chassis using four quick-mounted, snap-on brackets. The charging cable fastened to the body's charging strip must be disconnected to be able to remove the body entirely from the chassis.

Set the main switch to position 0.

Clean the area around the grommet for the charging cable found at the very front under the mower.

Pull out the rubber grommet on the charging cable and carefully loosen the connector.

Loosen the body from the chassis by lifting the body one corner at a time while holding the chassis in place.

##### Disassembling the chassis

Loosen all 14 screws (Torx 20).

Remove the guarantee seal at the point of separation between the chassis halves on the right-hand side.

Carefully lift the back edge of the upper section of the chassis.

Disconnect the MMI cable from the main circuit board and remove the upper section of the chassis.

##### Disassembling the battery

Loosen the three screws (Torx 20) holding the battery cover in place.

Disconnect the battery connection from the main circuit board.

Open the battery cover and remove the battery.

---

## 12. ENVIRONMENTAL INFORMATION

---

**Serial number:** \_\_\_\_\_

**Personal code:** \_\_\_\_\_

**Dealer** \_\_\_\_\_

**Dealer's telephone number:** \_\_\_\_\_





**Husqvarna**<sup>®</sup>

ORIGINAL INSTRUCTIONS

AUTOMOWER is a trademark owned by Husqvarna AB. Copyright © 2014 HUSQVARNA. All rights reserved.

[www.automower.com](http://www.automower.com)

115 70 66-95



## Free Manuals Download Website

<http://myh66.com>

<http://usermanuals.us>

<http://www.somanuals.com>

<http://www.4manuals.cc>

<http://www.manual-lib.com>

<http://www.404manual.com>

<http://www.luxmanual.com>

<http://aubethermostatmanual.com>

Golf course search by state

<http://golfingnear.com>

Email search by domain

<http://emailbydomain.com>

Auto manuals search

<http://auto.somanuals.com>

TV manuals search

<http://tv.somanuals.com>