

Installation Instructions for the MX775i Multiplex PIR Intrusion Detector

1.0 Specifications

- **Input Power:** Connects directly to the Multiplex Bus of the control panel and optionally to an auxiliary 12 VDC source.
- **Current Draw:**
 - 2-Wire**
 - LED Off:** < 350 μ A draw on Mux Bus
 - In Alarm; LED On:** 2 mA draw on Mux Bus
 - 4-Wire**
 - LED Off:** < 350 μ A draw on Mux Bus.; 0 mA draw on Aux. power
 - In Alarm; LED On:** < 350 μ A draw on Mux Bus; 3 mA draw on Aux. power
- **Standby Power:** There is no internal standby battery. Connect to DC power sources capable of supplying standby power if primary power fails. For each hour of standby time needed, 350 μ Ah are required. For UL Listed requirements, a minimum of 4 hrs. (1400 μ Ah) is required.
- **Coverage:**
 - Broad (standard):** 15 m by 15 m (50 ft by 50 ft)
 - Barrier (option):** 24.4 m by 4.8 m (80 ft by 16 ft)
 - Long Range (option):** 36.6 m by 3.1 m (120 ft by 10 ft)
- **Sensitivity:** Selectable for Standard, Intermediate, or High
- **Tamper:** A tamper condition is signaled through the Multiplex Bus and appears at the keypads.
- **Temperature:** The storage and operating temperature range is -29°C to +49°C (-20°F to 20°F). For UL Listed requirements, the temperature range is 0°C to +49°C (+32°F to +120°F).
- **Control Panel Requirements:** DS7400, DS7400X, or DS7400Xi Control Panel with a DS7430 or DS7436 Multiplex Expansion Module. The DS7400 and DS7400X require ROM version 1.07 or greater. The 9000 Series Control/Communicators with the D8125MUX Module installed.
- **Options:** B328 Gimbal Mount Bracket, B335 Low Profile Swivel Mount Bracket, B338 Ceiling Mount Bracket, OMB77-3* Barrier Mirror, OMLR77-3* Long Range Mirror.
*Shipped in packages of three.

Note: When using an optional mounting bracket, detector misalignment can reduce range.

- **Reading Bosch Security Systems, Inc. Product Date Codes**
For Product Date Code information, refer to the Bosch Security Systems, Inc. Web site at: <http://www.boschsecurity.com/datecodes/>

2.0 Control Panel Programming

Refer to the Multiplex programming section of your *Control Panel Reference Guide* for information on programming Multiplex zones for this device.

3.0 Mounting

Avoid the following:

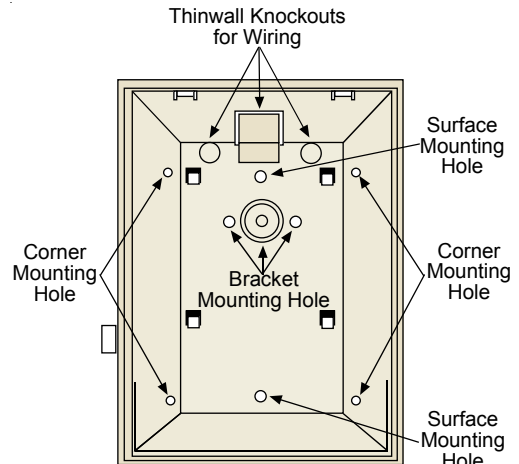
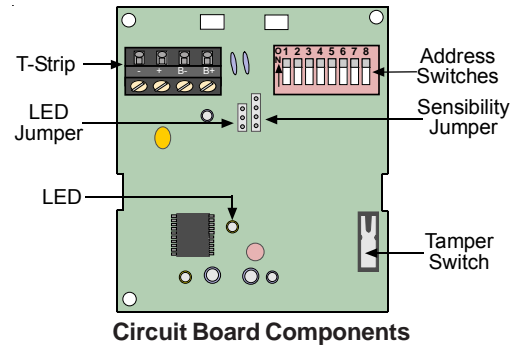
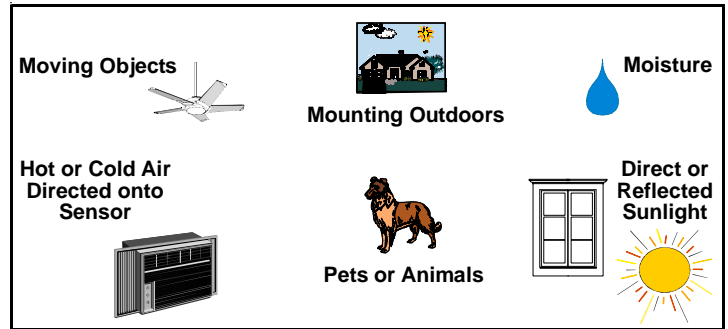

IMPORTANT

Ensure the mounting surface is solid and vibration free.

- Select a location that is most likely to intercept an intruder moving across the coverage pattern. The recommended mounting height range is 2 m to 2.6 m (6.5 ft to 8.5 ft).
- Remove the cover. Insert a thin flathead screwdriver into the notch at the bottom of the cover and pry up.
- Before lifting the circuit board from the enclosure, you must loosen the screw near the corner of the board.
- Remove the circuit board/mirror unit from the enclosure. Push the board/mirror unit toward the top of the enclosure until it clears its four retainer tabs. Then lift it out.
- Open the knockout wire entrance and route the wiring through.

3.1 Surface or Corner Mounting

- Open two holes for surface or corner mounting.
- Mark the location for the mounting screws. Use the enclosure as a template. Pre-start the mounting screws.
- Securely attach the detector.
- Replace the circuit board/mirror unit.
- Select the vertical angle.

3.2 Mirror Alignment

Note: Touching the mirror surfaces can lead to performance degradation.

For the best performance, the mirror must be adjusted vertically for the maximum desired detection range (distance) and mounting height. The angle adjustment markings are located on both sides of the mirror (see the chart below).

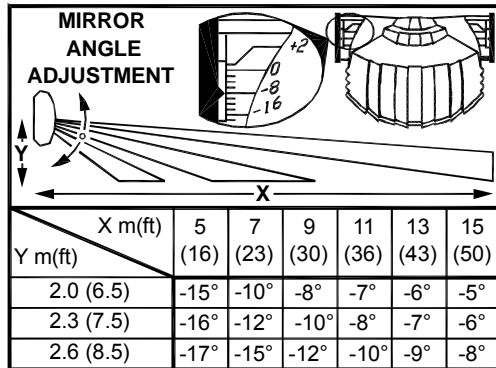

Mirror Alignment Chart

- Adjust by sliding the mirror forward or backward until the angle adjustment markings are in line with the markers on each side of the frame.
- Use the Mirror Alignment Chart to identify the correct vertical angle based on mounting height (X), mirror type, and maximum range (Y).
- Adjust the mirror horizontally by rotating (aiming) it from side to side.
- Walk test the unit as described in the *Section 7.0 Setup and Walk Testing*.

4.0 Wiring



Only apply power after all connections are made and inspected.

- Connect wiring as shown below.

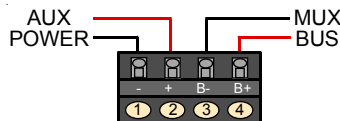

Note: Do not coil excess wiring inside unit.

- Seal the wire entrance using the foam plug provided.

Terminal Descriptions

- **1 (-) and 2 (+):** Connect to the AUX Power of the control panel. This connection is only required if LED operation (other than during the walk test) is required. Use no smaller than 0.8 mm (#22 AWG) wire between the detector and the control panel.
- **3 (-) and 4 (+):** Connect to the Multiplex Bus of the control panel. Use no smaller than 0.8 mm (#22 AWG) wire between the detector and the control panel.

5.0 Configuring the Detector

5.1 LED Operation Jumper

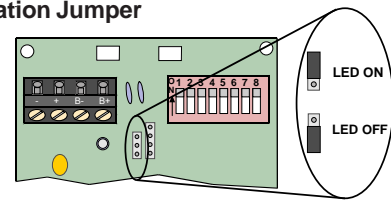

- **ON:** Allows the LED to operate when activated by alarm.
- **OFF:** The LED does not operate on alarm.



If the detector is powered by the MUX Bus only, the LED is for Walk Test purposes only. Disable the LED when Walk Testing is complete by placing the jumper in the OFF position. If the detector has AUX Power supplied, LED operation can remain on during normal use.

5.2 Sensitivity Mode

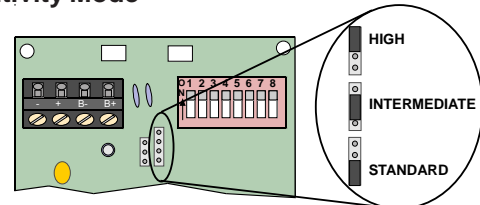

- **Standard Sensitivity:** The recommended setting for maximum false alarm immunity. Tolerates environment extremes on this setting. Not recommended for Long Range or Barrier type patterns. The detector is shipped in Standard Sensitivity Mode.
- **Intermediate Sensitivity:** The recommended setting for any location where an intruder is expected to cover only a small portion of the protected area. Tolerates normal environments on this setting. This setting improves your intruder catch performance.
- **High Sensitivity:** The fast response to intruder signals. For use in quiet environments where thermal and illumination transients are not anticipated.

6.0 Address Switch Settings

- Set the address switch settings before connecting the MX775i to the Multiplex Bus.



You cannot set two devices to the same address. Having two or more units set to the same address might prevent fault detection or cause Multiplex Bus failure.

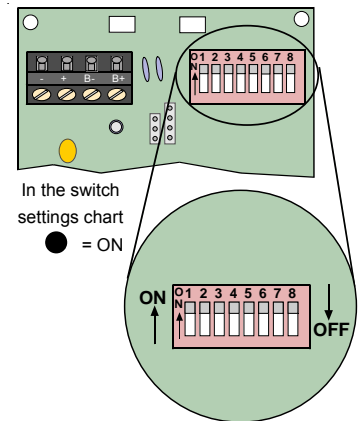

- You can find the address switch settings using the chart on the next page or by calculating the decimal number of the address.



Zone (Point) Addresses 001 through 008 are reserved for on-board points on the DS7400(Xi) Series Control Panels. Do not set the Multiplex devices for Addresses 001 through 008 when using a DS7400(Xi) Series Control Panel.

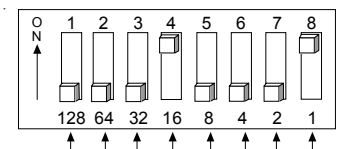

Binary Switch Values (Point 17 shown)

7.0 Setup and Walk Testing



Before walk testing, ensure the system is fully wired, powered, and programmed.

IMPORTANT

- Set the LED Operation Jumper to LED ON.
- Replace the front cover.

Note: Perform all testing with the front cover in place.

- Wait at least 2 min. (with no motion in the coverage area) for the detector to setup.
- Walk test across the coverage pattern.
- LED activation determines the edge of the coverage.
- Walk test the unit from both directions to determine the boundaries.

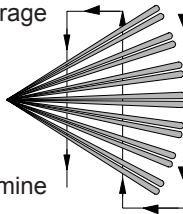

On 2-wire systems, set the LED to OFF when you finish Walk Tests.

IMPORTANT

8.0 Maintenance

Refer to the control panel's *User's Guide* for performing the Zone Test procedure. Performing Zone Tests regularly assures alarm output before arming the system.

9.0 Coverage Patterns

- Refer to the mirror module and pattern drawings for masking information.
- Before masking, ensure the selected mirror surface is the correct one. When removing masking, remember that many adhesives can either destroy the mirror's surface or leave behind residue that reduces coverage performance.
- This product is factory assembled with the look down zones (O, P, and Q) masked out. If you want to use these zones, remove the masking tape from the lens.

Remove the mask by peeling back the tab.

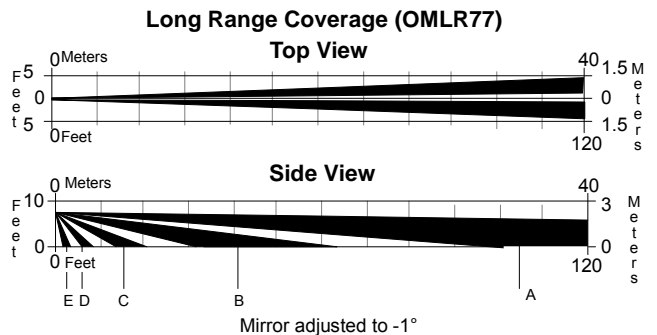
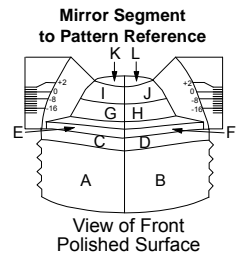
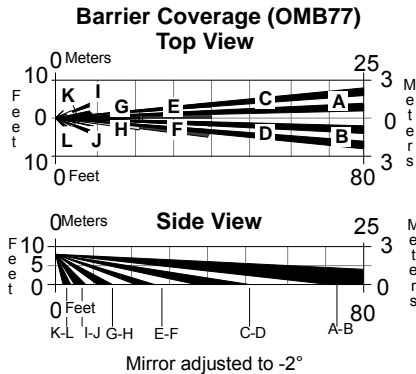
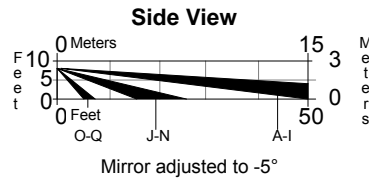
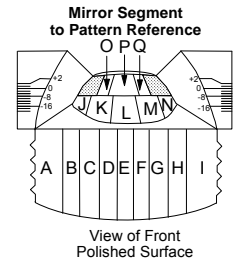
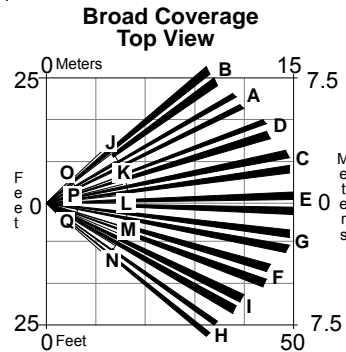
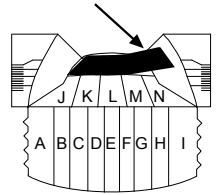

Free Manuals Download Website

<http://myh66.com>

<http://usermanuals.us>

<http://www.somanuals.com>

<http://www.4manuals.cc>

<http://www.manual-lib.com>

<http://www.404manual.com>

<http://www.luxmanual.com>

<http://aubethermostatmanual.com>

Golf course search by state

<http://golfingnear.com>

Email search by domain

<http://emailbydomain.com>

Auto manuals search

<http://auto.somanuals.com>

TV manuals search

<http://tv.somanuals.com>