

BOSE[®]



SOUNDDOCK[™]

DIGITAL MUSIC SYSTEM

Owner's Guide



Safety Information

-  **WARNING:** To reduce the risk of fire or electrical shock, do not expose the product to rain or moisture.
-  **WARNING:** The apparatus shall not be exposed to dripping or splashing, and objects filled with liquids, such as vases, shall not be placed on the apparatus. As with any electronic product, use care not to spill liquids into any part of the system. Liquids can cause a failure and/or a fire hazard.

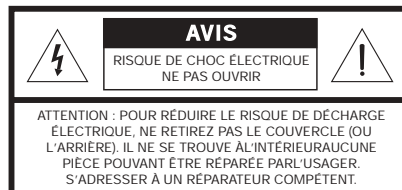
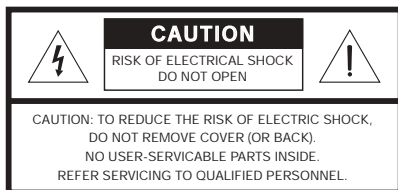

The lightning flash with arrowhead symbol, within an equilateral triangle, alerts the user to the presence of uninsulated dangerous voltage within the system enclosure that may be of sufficient magnitude to constitute a risk of electric shock.



The exclamation point within an equilateral triangle alerts the user to the presence of important operating and maintenance instructions in this owner's guide.



Note: The product label is located on the bottom of the product.



WARNING: No naked flame sources, such as lighted candles, should be placed on the apparatus.



Note: This product is intended to be used only with the power supply provided.



Note: Where the mains plug is used as the disconnect device, such disconnect device shall remain readily operable.



Note: This product must be used indoors. It is neither designed or tested for use outdoors, in recreation vehicles, or on boats.



This product conforms to the EMC directive 89/336/EEC and to the Low Voltage Directive 73/23/EEC. The complete Declaration of Conformity can be found on www.bose.com.

Please read this owner's guide

Please take the time to follow the instructions in this owner's guide carefully. It will help you set up and operate your system properly and enjoy all of its advanced features. Please save this owner's guide for future reference.



WARNING: Keep the remote control battery away from children. It may cause a fire or chemical burn if mishandled. Do not recharge, disassemble, heat above 100° C (212° F), or incinerate. Dispose of used batteries promptly. Replace only with a battery of the correct type and model number.



WARNING: Danger of explosion if battery is incorrectly replaced. Replace only with Duracell, Eveready, Energizer, Maxell, Toshiba, or Shun Wo CR2032 or DL2032 3-volt lithium battery.

Please dispose of used batteries properly, following any local regulations. Do not incinerate.



1. **Read these instructions** – for all components before using this product.
2. **Keep these instructions** – for future reference.
3. **Heed all warnings** – on the product and in the owner's guide.
4. **Follow all instructions.**
5. **Do not use this apparatus near water or moisture** – Do not use this product near a bathtub, washbowl, kitchen sink, laundry tub, in a wet basement, near a swimming pool, or anywhere else that water or moisture are present.
6. **Clean only with a dry cloth** – and as directed by Bose Corporation. Unplug this product from the wall outlet before cleaning.
7. **Do not block any ventilation openings. Install in accordance with the manufacturer's instructions** – To ensure reliable operation of the product and to protect it from overheating, put the product in a position and location that will not interfere with its proper ventilation. For example, do not place the product on a bed, sofa, or similar surface that may block the ventilation openings. Do not put it in a built-in system, such as a bookcase or a cabinet that may keep air from flowing through its ventilation openings.
8. **Do not install near any heat sources, such as radiators, heat registers, stoves or other apparatus (including amplifiers) that produce heat.**
9. **Protect the power cord from being walked on or pinched, particularly at plugs, convenience receptacles, and the point where they exit from the apparatus.**
10. **Only use attachments/accessories specified by the manufacturer.**
11. **Use only with the cart, stand, tripod, bracket or table specified by the manufacturer or sold with the apparatus. When a cart is used, use caution when moving the cart/apparatus combination to avoid injury from tip-over.**
12. **Unplug this apparatus during lightning storms or when unused for long periods of time** – to prevent damage to this product.
13. **Refer all servicing to qualified service personnel. Servicing is required when the apparatus has been damaged in any way: such as power supply cord or plug is damaged; liquid has been spilled or objects have fallen into the apparatus; the apparatus has been exposed to rain or moisture, does not operate normally, or has been dropped** – Do not attempt to service this product yourself. Opening or removing covers may expose you to dangerous voltages or other hazards. Please call Bose to be referred to an authorized service center near you.
14. **To prevent risk of fire or electric shock, avoid overloading wall outlets, extension cords, or integral convenience receptacles.**
15. **Do not let objects or liquids enter the product** – as they may touch dangerous voltage points or short-out parts that could result in a fire or electric shock.
17. **See product enclosure for safety related markings.**
18. **Use proper power sources** – Plug the product into a proper power source, as described in the operating instructions or as marked on the product.



Information about products that generate electrical noise

If applicable, this equipment has been tested and found to comply with the limits for a Class B digital device, pursuant to Part 15 of the FCC rules. These limits are designed to provide reasonable protection against harmful interference in a residential installation.

This equipment generates, uses, and can radiate radio frequency energy and, if not installed and used in accordance with the instructions, may cause harmful interference to radio communications.

However, this is no guarantee that interference will not occur in a particular installation. If this equipment does cause harmful interference to radio or television reception, which can be determined by turning the equipment off and on, you are encouraged to try to correct the interference by one or more of the following measures:

- Reorient or relocate the receiving antenna.
- Increase the separation between the equipment and receiver.
- Connect the equipment to an outlet on a different circuit than the one to which the receiver is connected.
- Consult the dealer or an experienced radio/TV technician for help.

This product complies with the Canadian ICES-003 Class B specification.

How this system takes your iPod sound public

Congratulations on your choice of the SoundDock™ digital music system from Bose. Designed specifically to work with your iPod, this system provides high-quality audio performance that invites your music to come out and play. Don't be surprised if it attracts a wider audience of people who love the sound.

The SoundDock digital music system:

- features a credit card-sized remote for command of the system volume and basic iPod functions from almost anywhere in the room
- allows full control of your iPod while it is docked in the system
- works with any size iPod with a docking connector on the bottom
- recharges the battery of your iPod while it is docked in the system

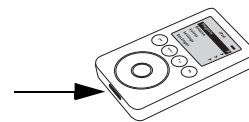

Unpacking the system

Check the carton for all of the parts shown (Figure 1). Save the carton for possible future use. Be sure to repack the system in its shipping carton to transport it outside your residence.

Figure 1

What's included in the carton

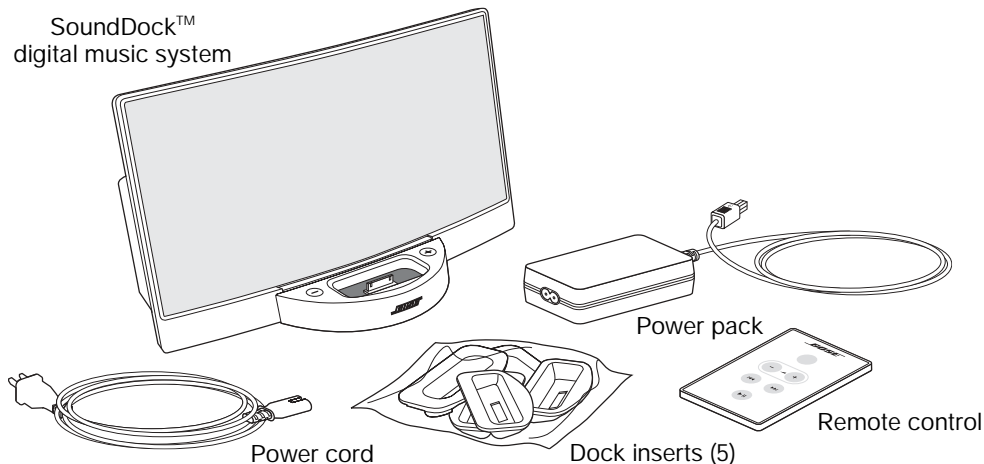

Place the system on a firm and level surface. Its speaker drivers are shielded, which limits the possibility of video interference if it is placed near a computer or video screen.

Getting it ready

Before you enjoy the sound, you need to install an insert in the dock on the front of the system. Then you can plug the system in.

To install an insert:

1. Check the bottom of each insert to identify the one that fits your iPod (Figure 2).
Using the correct insert ensures a snug fit for your iPod.

Figure 2

Labels on the five inserts

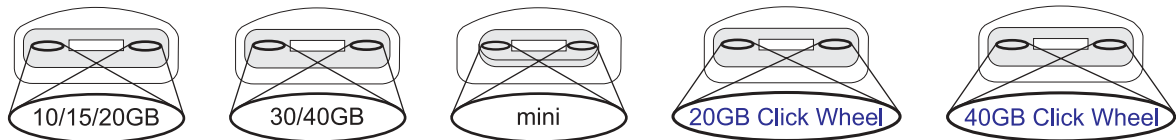

2. Position the selected insert over the dock.
3. Press on both sides of the insert until it rests firmly in place (Figure 3).

Figure 3

Installing an insert

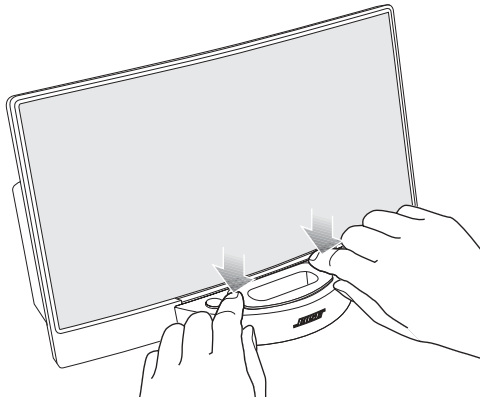

You can remove and replace the insert with any of the five provided. This allows you to use the system with an iPod of a different size. For details, see "To remove an insert from the dock" on page 9.

With the proper insert installed, you can now plug in the system.

Be sure you can see the symbol on top of the small connector end (Figure 4). Insert it into the jack on the back of the system matching the direction of the arrows on this connector and on the system.

Figure 4

Plugging in the system

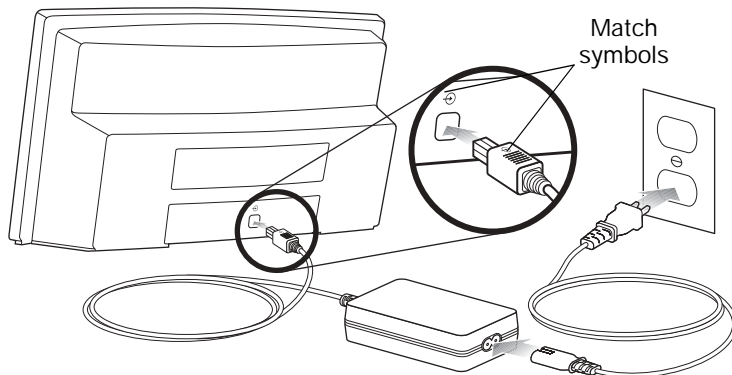

To check for iPod compatibility

For the SoundDock™ system remote control to work as intended with your iPod, it must be running Version 2.2 or later of the Apple software.

To check your iPod for the software version currently installed, select Settings, About, Version on the iPod display. If you need to upgrade, simply visit the Apple iPod website and follow the instructions there for a free download. Go to:

<http://www.apple.com/ipod/download/>

Using the system

Your SoundDock™ digital music system is ready to go as soon as you plug it in. Simply set your iPod to play what you want and insert it into the dock on the front of the system (below).

- You should hear the music immediately.
If you do not, refer to “Troubleshooting” on page 10.
- The + and – buttons on either side of the dock (right) allow you to adjust the system volume.
- Whenever your iPod is docked in the system, it recharges (until fully charged).

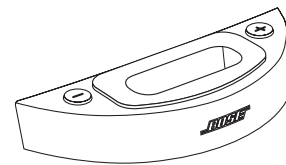



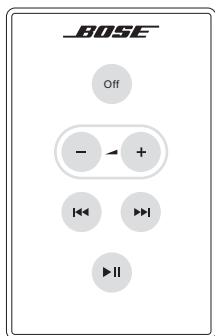

♪ **Note:** When earphones are plugged into your iPod, sound comes from both the earphones and the system.

Taking control

Use the remote to control the sound as you move around the room.



- Press  once to turn off your iPod.
It continues charging while in the dock.
- Turn on your iPod and press  to adjust the system volume.
Press and hold for faster adjustment.
- Press   to move to the previous or next track.
Press and hold to fast-forward or reverse the current track.
- Press  once to pause play; again to resume it.
Press and hold to turn off your iPod.

Other control options:

- To mute the system – Set the system volume to its lowest level, or press  to temporarily halt playback, or turn off your iPod.
- To turn off the SoundDock system – Remove your iPod from the dock or unplug the system from the outlet.

Using your iPod:

- Your iPod navigation controls are fully functional while it is docked in the system.
- Your iPod volume jog wheel changes the headphone volume only. It has no effect on the SoundDock system.

Maintaining the system

Changing the remote control battery is the only regular maintenance that is required. You may also clean the system as needed.

To replace the remote control battery

Replace the remote control battery when it stops operating (normally every year or two), or its range seems reduced. Use only a Duracell, Eveready, Energizer, Maxell, Toshiba, or Shun Wo CR2032 or DL2032 3-volt lithium battery.

Keep in mind that lighting and other room conditions, in addition to battery age, can affect the operating range of an infrared remote control.

Figure 5

Inserting a new battery

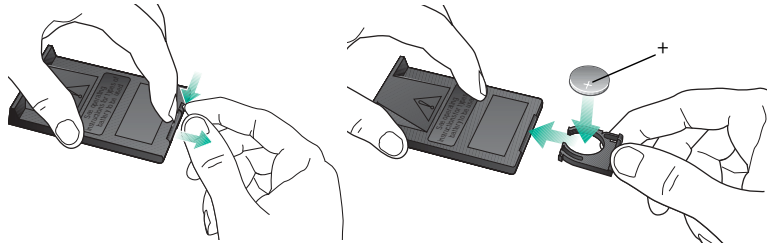

To clean the system

Wipe the system using a soft dry cloth. You can also lightly vacuum the grille.

- Do not use solvents, chemicals, or sprays.
- Do not allow liquids to spill or objects to drop into any openings.

To remove an insert from the dock

1. With your thumbs on the front of the dock near the Bose® logo, and your index fingers inside it, pinch until the rear of the insert lifts up (Figure 6).
2. Lift out the insert and replace it with the one you need.

Figure 6

Removing an insert

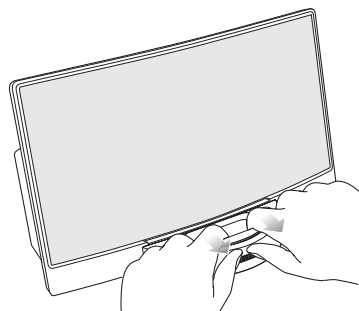

Troubleshooting

Problem	What to do
Your iPod does not dock properly	<ul style="list-style-type: none"> • Make sure the dock insert is the proper fit for your iPod (refer to “Getting it ready” on page 6). • Remove your iPod from the dock and check for obstructions on the connectors in the dock and on your iPod. Then reseal it in the dock.
No sound	<ul style="list-style-type: none"> • Make sure the system is plugged in, your iPod is turned on, and a music track is selected and playing. • Press the Play/Pause button on the remote control. • Increase the volume setting for the system. • Remove your iPod from the dock, wait briefly, then reseal it. You may need to do this a few times. • Make sure your iPod is running compatible software (refer to “To check for iPod compatibility” on page 7).
No sound <i>and</i> your iPod is not charging	<ul style="list-style-type: none"> • Make sure the power cable is securely plugged in to a functioning wall outlet and with the symbol on the small connector matched to the one on the back of the SoundDock™ system. Refer to Figure 4 on page 7. • Make sure your iPod is firmly seated in the dock.
No sound after quickly undocking or docking your iPod	<ul style="list-style-type: none"> • Remove your iPod from the dock, wait for 5 seconds, and return it to the dock. • Unplug the power cable for 1 minute, then plug it back in. This resets the system.
Your iPod does not respond to the SoundDock remote control buttons shown: 	<ul style="list-style-type: none"> • Remove your iPod from the dock, wait briefly, then reseal it. You may need to do this a few times. • Try the remote from a different location. If it works there, strong lighting or other room conditions may be causing the problem. • Make sure nothing blocks the infrared (IR) signal path from the remote to your SoundDock system. Wipe off the small red lens on the front end of the remote. • Check the remote control battery to make sure the + side is up as shown in Figure 5 on page 9. • Replace the remote control battery. • Upgrade software on your iPod. For details, refer to “To check for iPod compatibility” on page 7.
Your SoundDock system does not respond to its remote commands or to the + and – volume buttons on the front of the system	<ul style="list-style-type: none"> • Unplug the power cable for 1 minute, then plug it back in. This resets the system. • Contact Bose® Customer Service about the problem.

Customer Service

For questions about the SoundDock™ digital music system, contact your local Bose® dealer. To contact Bose directly, see the address list included in the carton.

Warranty

Your SoundDock digital music system is covered by a transferable limited warranty. See your product registration card for details.

Please be sure to fill out the information section on the card and mail it to Bose. Or, to register online, select Product Registration at the bottom of the Customer Service page of our website:

www.bose.com

Technical Information

Power rating

100-240V \sim 50-60Hz, 1.5A

System size and weight

6.65"H x 11.91"W x 6.48"D
(16.89 cm x 30.26 cm x 16.47 cm)
4.56 lb (2.1 kg)



277647

BOSE[®]
Better sound through research[®]

©2004 Bose Corporation, The Mountain,
Framingham, MA 01701-9168 USA
277647-ENG AM Rev.00 CCM-0007856

Free Manuals Download Website

<http://myh66.com>

<http://usermanuals.us>

<http://www.somanuals.com>

<http://www.4manuals.cc>

<http://www.manual-lib.com>

<http://www.404manual.com>

<http://www.luxmanual.com>

<http://aubethermostatmanual.com>

Golf course search by state

<http://golfingnear.com>

Email search by domain

<http://emailbydomain.com>

Auto manuals search

<http://auto.somanuals.com>

TV manuals search

<http://tv.somanuals.com>