



Online User's Guide

DCP-J1050DW

DCP-J1140DW

MFC-J1010DW

Table of Contents

Before You Use Your Machine	1
Definitions of Notes	2
Trademarks	3
Open Source Licensing Remarks	4
Copyright and License	5
Important Notes.....	6
Introduction to Your Machine	7
Before Using Your Machine	8
Control Panel Overview	9
LCD Overview	14
Touchscreen LCD Overview.....	16
Settings Screen Overview	19
Navigate the Touchscreen.....	21
Set the Ready Screen	22
Set Default Function Screens	23
Enter Text on Your Brother Machine	24
Access Brother Utilities (Windows)	27
Uninstall the Brother Software and Drivers (Windows)	28
USB Port Locations on Your Brother Machine	29
Paper Handling	30
Load Paper.....	31
Load Paper in the Paper Tray	32
Unprintable Area	40
Paper Settings.....	41
Acceptable Print Media	44
Load Documents	50
Load Documents in the Automatic Document Feeder (ADF)	51
Load Documents on the Scanner Glass	53
Unscannable Area	54
Print	55
Print from Your Computer (Windows).....	56
Print a Photo (Windows).....	57
Print a Document (Windows).....	58
Cancel a Print Job (Windows).....	59
Print More Than One Page on a Single Sheet of Paper (N in 1) (Windows).....	60
Print as a Poster (Windows).....	61
Print on Both Sides of the Paper Automatically (Automatic 2-sided Printing) (Windows)	62
Print as a Booklet Automatically (Windows).....	65
Print a Colour Document in Greyscale (Windows)	67
Prevent Smudged Printouts and Paper Jams (Windows)	68
Use a Preset Print Profile (Windows)	69
Change the Default Print Settings (Windows)	72
Print Settings (Windows)	73
Print from Your Computer (Mac)	77
Print Using Brother iPrint&Scan (Windows/Mac)	78

Print Photos or Documents Using Brother iPrint&Scan (Windows/Mac)	79
Print on Both Sides of the Paper Automatically Using Brother iPrint&Scan (Automatic 2-sided Printing)(Windows/Mac)	81
Print More Than One Page on a Single Sheet of Paper Using Brother iPrint&Scan (N in 1) (Windows/Mac)	83
Print a Colour Document in Greyscale Using Brother iPrint&Scan (Windows/Mac)	84
Print an Email Attachment	85
Scan	87
Scan Using the Scan Button on Your Machine	88
Scan Photos and Graphics	89
Save Scanned Data to a Folder as a PDF File	92
Scan to an Editable Text File Using OCR	95
Save Scanned Data as an Email Attachment	98
Web Services for Scanning on Your Network (Windows 7, Windows 8.1, and Windows 10)	101
Change Scan Settings Using Brother iPrint&Scan	105
Scan Using Brother iPrint&Scan (Windows/Mac)	106
Scan from Your Computer (Windows)	107
Scan Using Nuance™ PaperPort™ 14SE or Other Windows Applications	108
Scan Using Windows Fax and Scan	113
Scan from Your Computer (Mac)	117
Copy	118
Copy a Document	119
Enlarge or Reduce Copied Images	121
Sort Copies	123
Make Page Layout Copies (N in 1 or Poster)	124
Copy on Both Sides of the Paper (2-sided Copy)	128
Copy an ID Card	131
Copy Settings	133
Fax	137
Send a Fax	138
Send a Fax from Your Brother Machine	139
Send a Fax Manually	141
Send a Fax at the End of a Conversation	142
Send the Same Fax to More than One Recipient (Broadcasting)	143
Send a Fax in Real Time	146
Change the Fax Auto Redial Setting	147
Cancel a Fax in Progress	148
Check and Cancel a Pending Fax	149
Fax Options	150
Receive a Fax	151
Receive Mode Settings	152
Set Fax Detect	157
Shrink Page Size of an Oversized Incoming Fax	158
Set the Fax Receive Stamp	159
Receive a Fax at the End of a Telephone Conversation	160
Memory Receive Options	161
Voice Operations and Fax Numbers	164

Voice Operations	165
Store Fax Numbers	167
Set up Broadcasting Groups	172
Telephone Services and External Devices.....	176
Use BT Call Sign	177
Caller ID	179
Set the Telephone Line Type.....	181
Voice Over Internet Protocol (VoIP/Telephone Line Interference).....	183
External TAD (Telephone Answering Device).....	184
External and Extension Telephones	188
Fax Reports	194
Set the Transmission Verification Report's Style.....	195
Set the Fax Journal's Interval Period.....	196
PC-FAX	197
PC-FAX for Windows	198
PC-FAX for Mac	217
Network	218
Supported Basic Network Features	219
Configure Network Settings	220
Configure Network Settings Using the Control Panel.....	221
Wireless Network Settings	222
Use the Wireless Network	223
Use Wi-Fi Direct®	241
Enable/Disable Wireless LAN	246
Print the WLAN Report.....	247
Network Features.....	251
Print the Network Configuration Report.....	252
Reset the Network Settings to Factory Default	253
Brother Management Tools.....	254
Security	255
Before Using Network Security Features	256
Configure Certificates for Device Security	257
Supported Security Certificate Features	258
Step by Step Guide for Creating and Installing a Certificate	259
Create a Self-signed Certificate	260
Create CSR and Install a Certificate from a Certificate Authority (CA)	261
Import and Export the Certificate and Private Key	265
Manage Multiple Certificates	268
Use SSL/TLS	269
Introduction to SSL/TLS	270
Manage Your Network Machine Securely Using SSL/TLS.....	273
Print Documents Securely Using SSL/TLS	278
Use IEEE 802.1x Authentication for a Wired or a Wireless Network	280
What Is IEEE 802.1x Authentication?	281
Configure IEEE 802.1x Authentication for a Wired or a Wireless Network Using Web Based Management (Web Browser).....	282
IEEE 802.1x Authentication Methods.....	284

Lock the Machine Settings from the Control Panel	285
About Using TX Lock.....	286
Mobile/Web Connect.....	290
Brother Web Connect.....	291
Brother Web Connect Overview	292
Online Services Used with Brother Web Connect.....	295
Set Up Brother Web Connect.....	297
Scan and Upload Documents Using Brother Web Connect.....	305
Download and Print Documents Using Brother Web Connect	307
AirPrint	311
AirPrint Overview.....	312
Before Using AirPrint (macOS)	313
Print Using AirPrint	314
Scan Using AirPrint (macOS).....	317
Send a Fax Using AirPrint (macOS).....	318
Mopria® Print Service.....	319
Brother Mobile Connect	320
Brother iPrint&Scan for Windows and Mac	321
Brother iPrint&Scan Overview for Windows and Mac.....	322
Troubleshooting	323
Error and Maintenance Messages	324
Transfer Your Faxes or Fax Journal Report	335
Error Messages When Using the Brother Web Connect Feature.....	339
Document Jams	341
Document is Jammed in the Top of the ADF Unit	342
Document is Jammed inside the ADF Unit.....	343
Remove Paper Scraps Jammed in the ADF	344
Printer Jam or Paper Jam	345
Paper is Jammed Inside and in the Front of the Machine (Jam Inside/Front).....	346
Paper is Jammed in the Front of the Machine (Jam Front).....	351
Paper is Jammed in the Back of the Machine (Jam Rear)	354
If You Are Having Difficulty with Your Machine	356
Paper Handling and Printing Problems	357
Telephone and Fax Problems.....	363
Other Problems	369
Network Problems	371
AirPrint Problems	379
Check the Machine Information	380
Reset Your Machine	381
Reset Functions Overview	382
Routine Maintenance	383
Replace the Ink Cartridges.....	384
Clean Your Brother Machine	387
Clean the Scanner.....	388
Clean the Print Head from Your Brother Machine	390
Clean the Print Head Using Web Based Management	392
Clean the Print Head from Your Computer (Windows).....	393





Clean the Machine's LCD.....	395
Clean the Outside of the Machine	396
Clean the Machine's Printer Platen	397
Clean the Paper Feed Rollers	398
Clean the Base Pad	399
Clean the Paper Pick-up Rollers	400
Check Your Brother Machine	401
Check the Print Quality.....	402
Check the Print Alignment from Your Brother Machine.....	405
Check the Ink Volume (Page Gauge).....	407
Monitor Machine Status from Your Computer (Windows)	409
Monitor Machine Status Using Brother iPrint&Scan (Windows/Mac)	414
Correct the Paper Feed to Clear Vertical Lines.....	416
Change the Print Options to Improve Your Print Results	417
Pack and Ship Your Machine	418
Machine Settings.....	421
Change Machine Settings from the Control Panel.....	422
In the Event of Power Failure (Memory Storage)	423
General Settings.....	424
Save Your Favourite Settings as a Shortcut.....	439
Print Reports	442
Settings and Features Tables	445
Change Machine Settings Using Web Based Management	463
What is Web Based Management?.....	464
Access Web Based Management	465
Set or Change a Login Password for Web Based Management.....	467
Set Up Your Machine's Address Book Using Web Based Management.....	468
Appendix.....	469
Specifications	470
Supply Specifications	477
Information Regarding Recycled Paper	478
Brother Help and Customer Support.....	479

Before You Use Your Machine

- [Definitions of Notes](#)
- [Trademarks](#)
- [Open Source Licensing Remarks](#)
- [Copyright and License](#)
- [Important Notes](#)

Definitions of Notes

We use the following symbols and conventions throughout this User's Guide:

 WARNING	WARNING indicates a potentially hazardous situation which, if not avoided, could result in death or serious injuries.
 CAUTION	CAUTION indicates a potentially hazardous situation which, if not avoided, may result in minor or moderate injuries.
IMPORTANT	IMPORTANT indicates a potentially hazardous situation which, if not avoided, may result in damage to property or loss of product functionality.
NOTE	NOTE specifies the operating environment, conditions for installation, or special conditions of use.
	Tips icons indicate helpful hints and supplementary information.
	Electrical Hazard icons alert you to possible electrical shock.
Bold	Bold style identifies buttons on the machine's control panel or computer screen.
<i>Italics</i>	Italicised style emphasises an important point or refers you to a related topic.
Courier New	Courier New font identifies messages shown on the machine's LCD.



Related Information

- [Before You Use Your Machine](#)

Trademarks

Apple, App Store, AirPrint, Mac, iPad, iPhone, iPod touch, macOS, iPadOS and Safari are trademarks of Apple Inc., registered in the United States and other countries.

Nuance and PaperPort are trademarks or registered trademarks of Nuance Communications, Inc. or its affiliates in the United States and/or other countries.

Wi-Fi®, Wi-Fi Alliance® and Wi-Fi Direct® are registered trademarks of Wi-Fi Alliance®.

WPA™, WPA2™, and Wi-Fi Protected Setup™ are trademarks of Wi-Fi Alliance®.

Android, Google Drive, Google Play and Google Chrome are trademarks of Google LLC.

EVERNOTE is a trademark of Evernote Corporation and used under a license.

The Bluetooth® word mark is a registered trademark owned by the Bluetooth SIG, Inc. and any use of such marks by Brother Industries, Ltd. is under license. Other trademarks and trade names are those of their respective owners.

Mopria® and the Mopria® logo are registered and/or unregistered trademarks and service marks of Mopria Alliance, Inc. in the United States and other countries. Unauthorized use is strictly prohibited.

Each company whose software title is mentioned in this manual has a Software Licence Agreement specific to its proprietary programs.

Any trade names and product names of companies appearing on Brother products, related documents and any other materials are all trademarks or registered trademarks of those respective companies.



Related Information

- [Before You Use Your Machine](#)

Open Source Licensing Remarks

This product includes open-source software.

To view Open Source Licensing Remarks and Copyright Information, go to your model's **Manuals** page at support.brother.com.



Related Information

- [Before You Use Your Machine](#)
-

Copyright and License

©2021 Brother Industries, Ltd. All rights reserved.

This product includes software developed by the following vendors:

This product includes the “KASAGO TCP/IP” software developed by ZUKEN ELMIC, Inc.



Related Information

- [Before You Use Your Machine](#)
-

Important Notes

- Check support.brother.com for Brother driver and software updates.
- To keep your machine performance up to date, check support.brother.com for the latest firmware upgrade. Otherwise, some of your machine's functions may not be available.
- Do not use this product outside the country of purchase as it may violate the wireless telecommunication and power regulations of that country.
- When replacing or disposing of your machine, Brother strongly recommends resetting it to its factory settings to remove all personal information.
- Windows 10 in this document represents Windows 10 Home, Windows 10 Pro, Windows 10 Education and Windows 10 Enterprise.
- Windows Server 2008 in this document represents Windows Server 2008 and Windows Server 2008 R2.
- In this User's Guide, the LCD messages of the DCP-J1140DW/MFC-J1010DW are used unless otherwise specified.
- In this User's Guide, the illustrations of the MFC-J1010DW are used unless otherwise specified.
- The screens or images in this User's Guide are for illustration purposes only and may differ from those of the actual products.
- Unless otherwise specified, the screens in this manual are from Windows 10. Screens on your computer may vary depending on your operating system.
- The contents of this guide and the specifications of this product are subject to change without notice.
- In this document XXX-XXXX represents your machine's model name.



Related Information

- [Before You Use Your Machine](#)

Introduction to Your Machine

- [Before Using Your Machine](#)
- [Control Panel Overview](#)
- [LCD Overview](#)
- [Touchscreen LCD Overview](#)
- [Settings Screen Overview](#)
- [Navigate the Touchscreen](#)
- [Set the Ready Screen](#)
- [Set Default Function Screens](#)
- [Enter Text on Your Brother Machine](#)
- [Access Brother Utilities \(Windows\)](#)
- [USB Port Locations on Your Brother Machine](#)

Before Using Your Machine

Before attempting any printing operation, confirm the following:

- Make sure you have installed the correct software and drivers for your machine.
- For USB or network cable users: Make sure the interface cable is physically secure.

Selecting the correct type of paper

For high quality printing, it is important to select the correct type of paper. Be sure to read the information about acceptable paper before buying paper, and to determine the printable area depending on the settings in the printer driver or in the application you use to print.

Simultaneous printing and faxing

Your machine can print from your computer while receiving a fax into memory. However, when the machine is copying or receiving a fax on paper, it pauses the printing operation, and then continues printing when copying or fax receiving has finished.



DCP models do not support the fax feature.

Firewall (Windows)

If your computer is protected by a firewall and you are unable to network print, network scan, or PC-FAX, you may need to configure the firewall settings. If you are using the Windows Firewall and you installed the drivers using the steps in the installer, the necessary firewall settings have been already set. If you are using any other personal firewall software, see the User's Guide for your software or contact the software manufacturer.



Related Information

- [Introduction to Your Machine](#)

Control Panel Overview

Colours of the control panels and buttons shown in these illustrations may differ depending on the model.

>> [MFC-J1010DW](#)

>> [DCP-J1050DW](#)

>> [DCP-J1140DW](#)

MFC-J1010DW

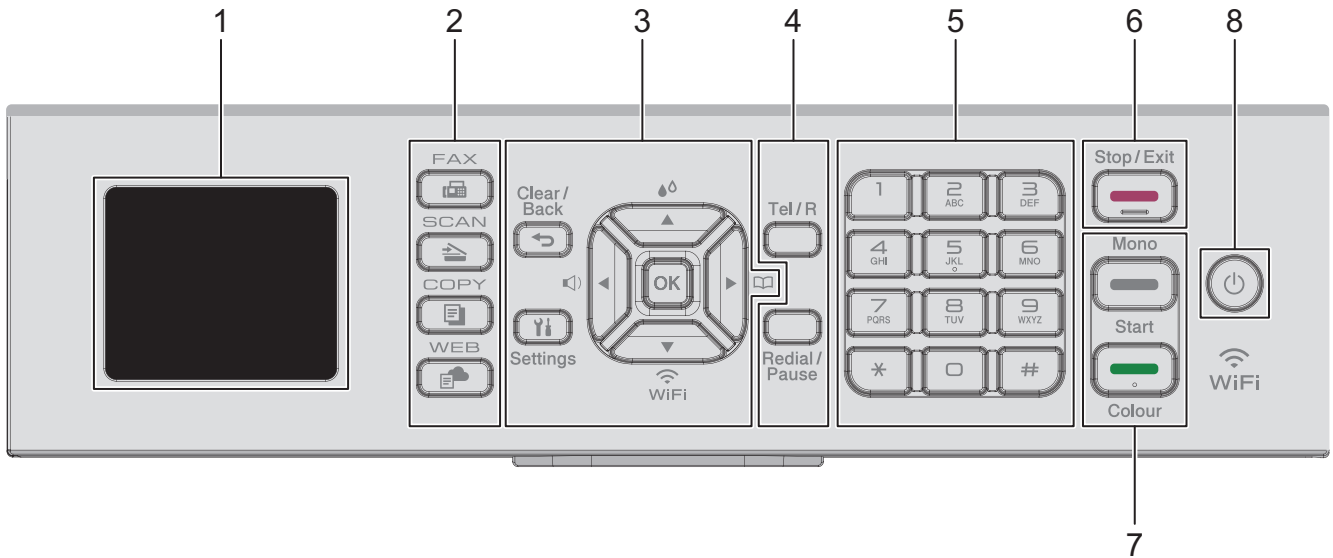

1. 1.8"(44.9 mm) Liquid Crystal Display (LCD)

Displays messages to help you set up and use the machine.

2. Mode Buttons



FAX

Press to switch the machine to Fax mode.



SCAN

Press to switch the machine to Scan mode.



COPY

Press to switch the machine to Copy mode.



WEB

Press to switch the machine to Web mode.

3. Settings Buttons



Clear/Back

Press to go back to the previous menu.



Settings

Press to access the main menu.

OK

Press to select a setting.



Press to access the ring volume adjustment menu while the machine is idle.



Press to access the ink menu while the machine is idle.



- Press to store Speed Dial and Group numbers in the machine's memory.
- Press to look up and dial numbers that are stored in the machine's memory.



Press to configure the wireless settings while the machine is idle.



Press to scroll through the menus and options.



- Press to move the cursor left or right on the LCD.
- Press to either confirm or cancel a procedure which is in progress.

4. Telephone Buttons

Tel/R

If the machine is in Fax/Tel (F/T) mode and you pick up the handset of an external telephone during the F/T ring (pseudo/double-ring), press **Tel/R** to talk.

When connected to a PBX, press to gain access to an outside line or to transfer a call to another extension.

Redial/Pause

- Press to redial the last number you called.
- Press to select and redial the numbers from the Outgoing Call History or Caller ID History.
- Press to insert a pause when dialling numbers.

5. Dial Pad

- Use to dial fax and telephone numbers.
- Use as a keyboard to enter text or characters.

6. Stop/Exit

- Press to stop an operation.
- Press to exit from a menu.

7. Start Buttons

Mono Start

- Press to start sending faxes in monochrome.
- Press to start making copies in monochrome.
- Press to start scanning documents (in colour or monochrome, depending on the scan setting).

Colour Start

- Press to start sending faxes in full colour.
- Press to start making copies in full colour.
- Press to start scanning documents (in colour or monochrome, depending on the scan setting).

8. Power On/Off

Press  to turn the machine on.

Press and hold  to turn the machine off. The LCD displays [Shutting Down] and stays on for a few seconds before turning itself off. A connected external telephone or Telephone Answering Device (TAD) will always remain available.

If you turn the machine off using , it will still clean the print head periodically to maintain print quality. To prolong print head life, provide better ink efficiency, and maintain print quality, keep your machine connected to a power source at all times.

DCP-J1050DW

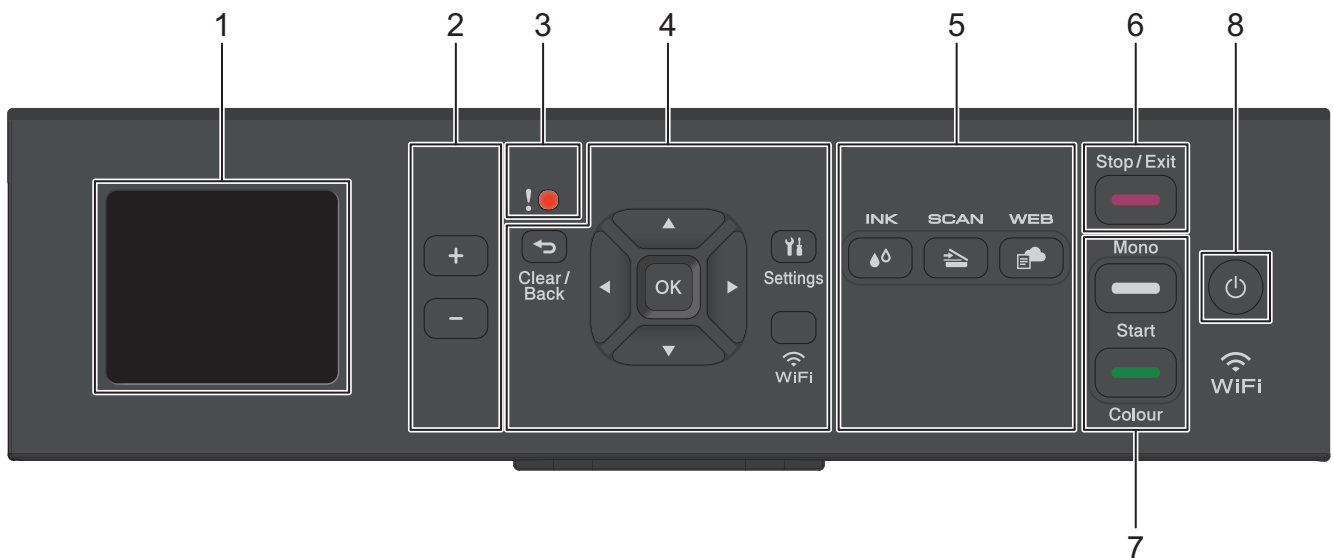

1. 1.8"(44.9 mm) Liquid Crystal Display (LCD)

Displays messages to help you set up and use the machine.

2. Number of Copies

Press + to increase or - to decrease the number of copies.

3. Warning icon

The warning icon lights up when there is an error or maintenance message.

4. Settings Buttons

Clear/Back

Press to go back to the previous menu.

Settings

Press to access the main menu.

OK

Press to select a setting.

WiFi

Press to configure the wireless settings while the machine is idle.

▲ or ▼

Press to scroll through the menus and options.

◀ or ▶

- Press to move the cursor left or right on the LCD.
- Press to either confirm or cancel a procedure which is in progress.

5. Mode Buttons



Press to access the ink menu while the machine is idle.



Press to switch the machine to Scan mode.



Press to switch the machine to Web mode.

6. Stop/Exit



- Press to stop an operation.
- Press to exit from a menu.

7. Start Buttons





- Press to start making copies in monochrome.
- Press to start scanning documents (in colour or monochrome, depending on the scan setting).



- Press to start making copies in full colour.
- Press to start scanning documents (in colour or monochrome, depending on the scan setting).

8. Power On/Off

Press  to turn the machine on.

Press and hold  to turn the machine off. The LCD displays [Shutting Down] and stays on for a few seconds before turning itself off.

If you turn the machine off using , it will still clean the print head periodically to maintain print quality. To prolong print head life, provide better ink efficiency, and maintain print quality, keep your machine connected to a power source at all times.

DCP-J1140DW

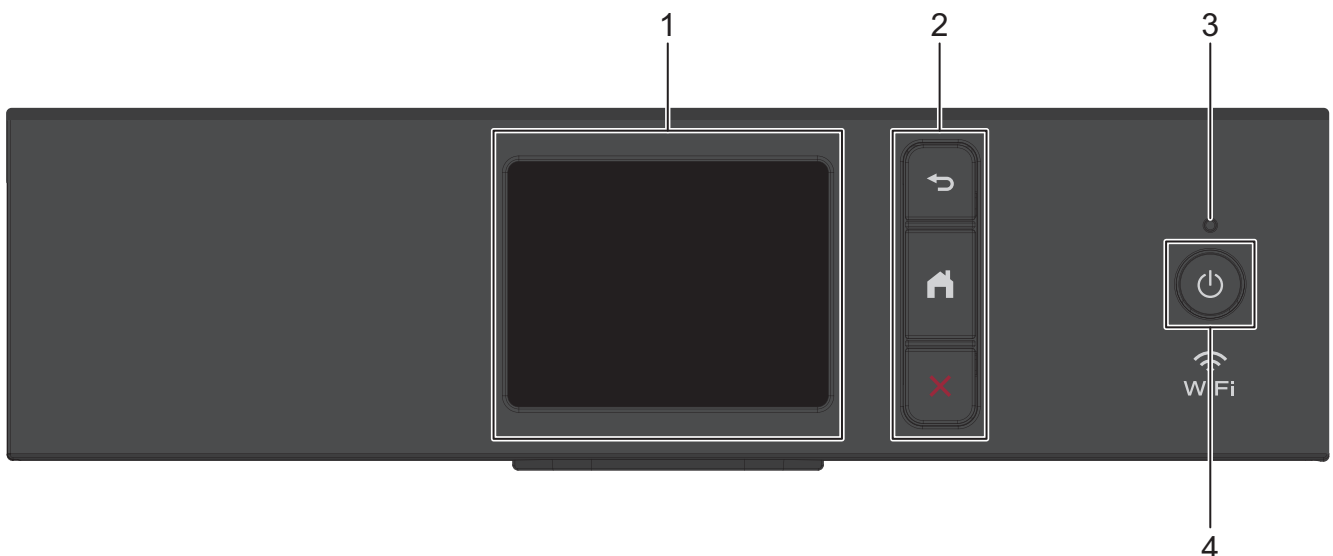

1. Touchscreen Liquid Crystal Display (LCD)

Access menus and options by pressing them on the touchscreen.

2. Menu Buttons



Press to go back to the previous menu.



Press to return to the Home screen.



Press to cancel an operation.

3. LED Power Indicator

The LED lights up depending on the machine's power status.

When the machine is in Sleep Mode, the LED blinks.

4. Power On/Off

Press  to turn the machine on.

Press and hold  to turn the machine off. The touchscreen displays [Shutting Down] and stays on for a few seconds before turning itself off.

If you turn the machine off using , it will still clean the print head periodically to maintain print quality. To prolong print head life, provide better ink efficiency, and maintain print quality, keep your machine connected to a power source at all times.



Related Information

- [Introduction to Your Machine](#)
-

LCD Overview

Related Models: DCP-J1050DW/MFC-J1010DW

>> [MFC-J1010DW](#)

>> [DCP-J1050DW](#)

MFC-J1010DW

The Home screen shows the machine's status when the machine is idle. When displayed, this indicates that your machine is ready for the next command.

Home Screen

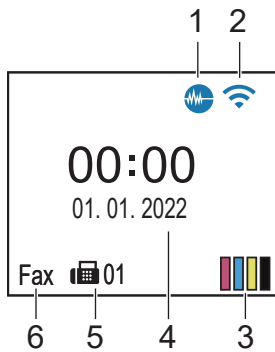



1.  **Quiet Mode**

This icon appears when the [Quiet Mode] setting is set to [On].

The Quiet Mode setting can reduce printing noise. When Quiet Mode is turned on, the print speed becomes slower.

2.  **Wireless Status**

Each icon in the following table shows the wireless network status:

	The wireless network is connected. A three-level indicator in the Home screen displays the current wireless signal strength.
	The wireless access point cannot be detected.
	The wireless setting is disabled.

3.  **[Ink]**

Displays the approximate available ink volume.

When an ink cartridge is near the end of its life or having a problem, an error icon is displayed on the ink colour indicator.

4. **Date and Time**

Displays the date and time set on the machine.

5. **Faxes in Memory**

Displays how many received faxes are in the machine's memory.

6. **Receive Mode**

Displays the current Receive Mode.

DCP-J1050DW

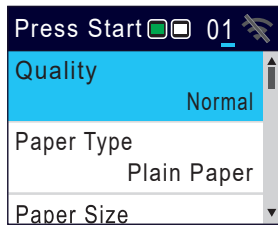

The LCD shows the machine's status when the machine is idle.

Home Screen



1. **Wireless Status**

Each icon in the following table shows the wireless network status:

	The wireless network is connected. A three-level indicator in the Home screens displays the current wireless signal strength.
	The wireless access point cannot be detected.
	The wireless setting is disabled.



You can configure wireless settings by pressing **WiFi** on the control panel.



Related Information

- [Introduction to Your Machine](#)
-

Touchscreen LCD Overview

Related Models: DCP-J1140DW

You can switch Home screens by pressing ◀ or ▶.
From the Home screens, you can access the various settings.

Home Screen

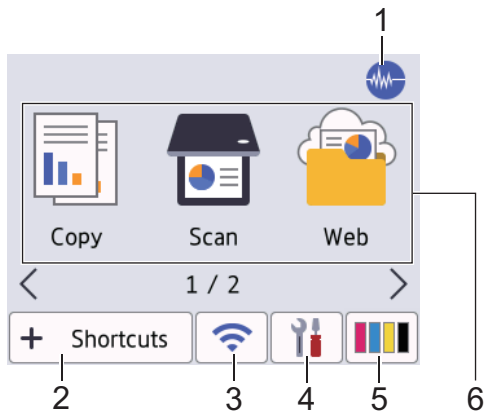

This screen shows the machine's status when the machine is idle. When displayed, it indicates that your machine is ready for the next command.

1. Quiet Mode

This icon appears when the [Quiet Mode] setting is set to [On].

The Quiet Mode setting can reduce printing noise. When Quiet Mode is turned on, the print speed becomes slower.

2. [Shortcuts]

Create Shortcuts for frequently-used operations, such as copying, scanning, Web Connect and Apps services.

 Three Shortcuts tabs are available with six Shortcuts on each tab.

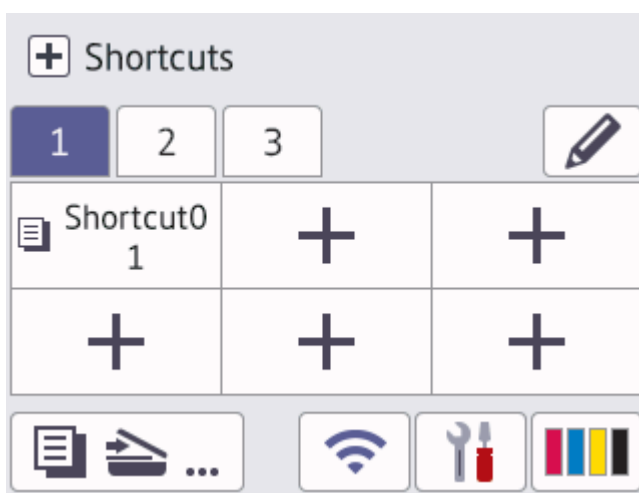

3. Wireless Status

Each icon in the following table shows the wireless network status:

	<ul style="list-style-type: none"> Your machine is not connected to the wireless access point/router. Press this button to configure wireless settings. For more detailed information, see the <i>Quick Setup Guide</i>. The wireless setting is disabled.
	The wireless network is connected. A three-level indicator in each of the Home screens displays the current wireless signal strength.
	The wireless access point/router cannot be detected.

You can configure wireless settings by pressing the Wireless Status button.

4. [Settings]

Press to access the [Settings] menu.

5. [Ink]

Displays the approximate available ink volume. Press to access the [Ink] menu.

When an ink cartridge is near the end of its life or having a problem, an error icon is displayed on the ink colour indicator.

6. **Modes:**

Press to switch to each mode.

[Copy] / [Scan] / [Web] / [Apps] / [Download Software] / [Print Head Cleaning]

7. **Information icon**

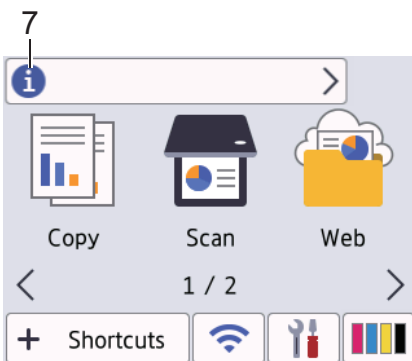

New information from Brother appears in the information bar when the notification settings such as [Message from Brother] and [Firmware Auto Check] are set to [On].

(Internet connection is needed, and data rates may apply.)

Press to view the details.

8. **Warning icon**

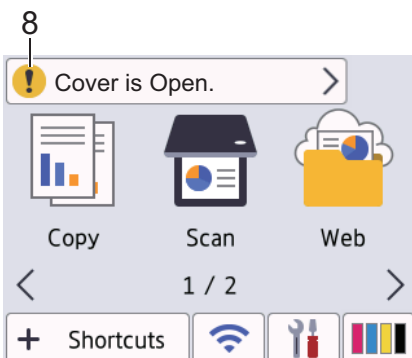

The warning icon appears when there is an error or maintenance message; press to view the details, and then press to return to the Home screen.



Related Information

- [Introduction to Your Machine](#)

Related Topics:

- [Set the Ready Screen](#)
- [Reduce Printing Noise](#)
- [Check the Ink Volume \(Page Gauge\)](#)
- [Settings Screen Overview](#)
- [Error and Maintenance Messages](#)

Settings Screen Overview

Related Models: DCP-J1140DW

The touchscreen shows the machine's status when you press  [Settings].

Use the Settings menu to access all of your Brother machine's settings.

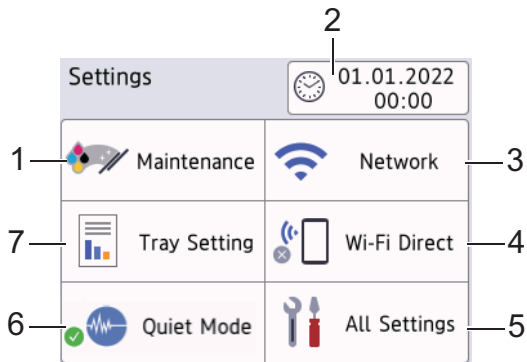

1. [Maintenance]

Press to access the following menus:

- [Improve Print Quality]
- [Print Head Cleaning]
- [Ink Volume]
- [Ink Cartridge Model]
- [Print Options]
- [Ink Cartridge Check]

2. [Date & Time]

Displays the date and time.

Press to access the [Date & Time] menu.

3. [Network]

Press to set up a wireless network connection.

If you are using a wireless connection, a three-level indicator  on the screen displays the current wireless signal strength.

4. [Wi-Fi Direct]

Press to set up a Wi-Fi Direct network connection.

5. [All Settings]

Press to access a menu of all of your machine's settings.

6. [Quiet Mode]

Displays the Quiet Mode setting.

Press to access the [Quiet Mode] menu.

When this menu is set to [On],  is displayed on the Home screen.

7. [Tray Setting]

Press to access the [Tray Setting] menu.

Use these options to change the paper size and type.

✓ Related Information

- [Introduction to Your Machine](#)

Related Topics:

- [Touchscreen LCD Overview](#)
 - [Check the Ink Volume \(Page Gauge\)](#)
-

Navigate the Touchscreen

Related Models: DCP-J1140DW

Using your finger, press ◀▶ or ▲▼ on the LCD to display and access the machine options.

IMPORTANT

DO NOT press the LCD with a sharp object such as a pen or stylus. It may damage the machine.

NOTE

DO NOT touch the LCD immediately after plugging in the power cord or turning on the machine. Doing this may cause an error.



This product adopts the font of ARPHIC TECHNOLOGY CO., LTD.



Related Information



- [Introduction to Your Machine](#)

Set the Ready Screen

Related Models: DCP-J1140DW

You can change the Ready screen to the [Screen 1], [Screen 2], [Shortcuts 1], [Shortcuts 2] or [Shortcuts 3] screen.

When the machine is idle or you press , the machine will go back to the screen that you have set.

1. Press  [Settings] > [All Settings] > [General Setup] > [Screen Settings] > [Home Screen].
2. Press ▲ or ▼ to display the [Screen 1], [Screen 2], [Shortcuts 1], [Shortcuts 2] or [Shortcuts 3] option, and then select the option you want.
3. Press .

The machine will go to your new Home screen.

Related Information

- [Introduction to Your Machine](#)



Related Topics:

- [Touchscreen LCD Overview](#)

Set Default Function Screens

Related Models: DCP-J1140DW

You can set the Scan default screen using the Screen Settings.

1. Press  [Settings] > [All Settings] > [General Setup] > [Screen Settings] > [Scan Screen].
2. Press ▲ or ▼ to display the scan options, and then select the option you want to set as the default screen.
3. Press .



Related Information

- [Introduction to Your Machine](#)

Enter Text on Your Brother Machine

- The characters that are available may differ depending on your country.
- For touchscreen models, the keyboard layout may differ depending on the function you are setting.

>> [DCP-J1050DW](#)

>> [MFC-J1010DW](#)

>> [DCP-J1140DW](#)

DCP-J1050DW

You may need to enter text into the machine, for example, when you set the network key.

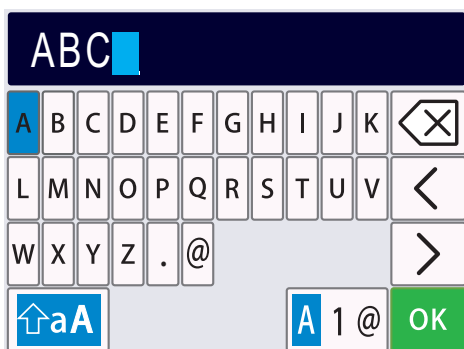

- Press ▲, ▼, ◀ or ▶ to select the number, letter or special character you want to select, and press **OK**. Repeat for each character until the number or name is complete and then press ▲, ▼, ◀ or ▶ to select **OK** and then press **OK**.
- Press ▲, ▼, ◀ or ▶ to select **A 1 @**, and then press **OK** to cycle between letters, numbers and special characters.
- Press ▲, ▼, ◀ or ▶ to select **↑aA**, and then press **OK** to cycle between lowercase and uppercase letters.

Inserting spaces

- To enter a space, press ▲, ▼, ◀ or ▶ to select **>**, and then press **OK**.

Making corrections

- If you entered an incorrect number or letter and want to change it, press ▲, ▼, ◀ or ▶ to select **<** or **>**. Press **OK** several times to move the highlight to the incorrect character. Then, press ▲, ▼, ◀ or ▶ to select **✕**, and press **OK**. Re-enter the correct letter.

MFC-J1010DW

When you are setting certain menu selections, such as the Station ID, you may need to enter text into the machine. Most dial pad buttons have three or four letters printed on the buttons. The buttons for **0**, **#** and ***** do not have printed letters because they are used for special characters.

Press the appropriate dial pad button the number of times shown in this reference table to access the character you want.

Press Button	One Time	Two Times	Three Times	Four Times	Five Times	Six Times	Seven Times	Eight Times	Nine Times
2	A	B	C	a	b	c	2	A	B
3	D	E	F	d	e	f	3	D	E
4	G	H	I	g	h	i	4	G	H

Press Button	One Time	Two Times	Three Times	Four Times	Five Times	Six Times	Seven Times	Eight Times	Nine Times
5	J	K	L	j	k	l	5	J	K
6	M	N	O	m	n	o	6	M	N
7	P	Q	R	S	p	q	r	s	7
8	T	U	V	t	u	v	8	T	U
9	W	X	Y	Z	w	x	y	z	9

- To move the cursor to the left or right, press ▲, ▼, ◀ or ▶ to select ◀ or ▶, and then press **OK**.

Inserting spaces

- To enter a space, press ▲, ▼, ◀ or ▶ to select ▶, and then press **OK**.

Making corrections

- If you entered an incorrect number or letter and want to change it, press ▲, ▼, ◀ or ▶ to select ◀ or ▶. Press **OK** several times to move the highlight to the incorrect character. Then, press ▲, ▼, ◀ or ▶ to select ◀, and press **OK**. Re-enter the correct letter.

Special characters and symbols

Press *, # or 0 repeatedly until you see the special character or symbol you want.

Press *	(space)! " # \$ % & ' () * + , - . / €
Press #	: ; < = > ? @ [] ^ _
Press 0	Ä Ë Ö Ü À Ç È É 0

DCP-J1140DW

When you need to enter text on your Brother machine, a keyboard will appear on the touchscreen.





- Press **A 1 @** to cycle between letters, numbers and special characters.
- Press **↑aA** to cycle between lowercase and uppercase letters.
- To move the cursor to the left or right, press ◀ or ▶.

Inserting spaces

- To enter a space, press [Space]. Or, you can press ▶ to move the cursor.

Making corrections

- If you entered an incorrect character and want to change it, press ◀ or ▶ to highlight the incorrect character. Press ◀, and then enter the correct character.

-
- To insert a character, press ◀ or ▶ to move the cursor to the correct place, and then enter the character.
 - Press  for each character you want to erase, or press and hold  to erase all the characters.

Related Information

- [Introduction to Your Machine](#)

Related Topics:

- [Send the Same Fax to More than One Recipient \(Broadcasting\)](#)
 - [Save Outgoing Call Numbers to the Address Book](#)
 - [Save Caller ID History Numbers to the Address Book](#)
 - [Change a Broadcasting Group Name](#)
 - [Set Your Station ID](#)
 - [Change or Delete Shortcuts](#)
-

Access Brother Utilities (Windows)

Brother Utilities is an application launcher that offers convenient access to all Brother applications installed on your computer.

1. Do one of the following:

- Windows 10

Click  > **Brother** > **Brother Utilities**.

- Windows 8.1

Move your mouse to the lower left corner of the **Start** screen and click  (if using a touch-based device, swipe up from the bottom of the **Start** screen to bring up the **Apps** screen).

When the **Apps** screen appears, tap or click  (**Brother Utilities**).

- Windows 7

Click  (**Start**) > **All Programs** > **Brother** > **Brother Utilities**.

2. Select your machine.

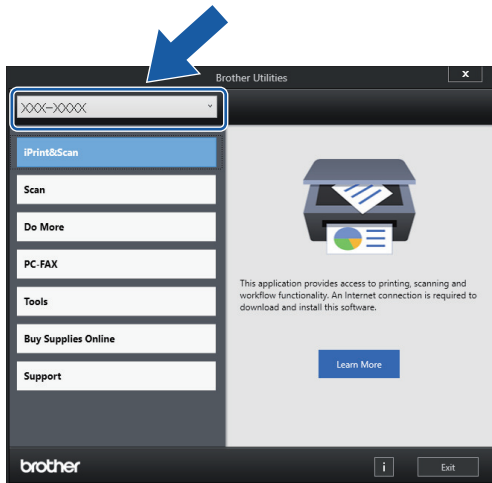

3. Select the operation you want to use.

Related Information

- [Introduction to Your Machine](#)
 - [Uninstall the Brother Software and Drivers \(Windows\)](#)

Uninstall the Brother Software and Drivers (Windows)

1. Do one of the following:

- Windows 10

Click  > **Brother** > **Brother Utilities**.

- Windows 8.1

Move your mouse to the lower left corner of the **Start** screen and click  (if using a touch-based device, swipe up from the bottom of the **Start** screen to bring up the **Apps** screen).

When the **Apps** screen appears, tap or click  (**Brother Utilities**).

- Windows 7

Click  (**Start**) > **All Programs** > **Brother** > **Brother Utilities**.

2. Click the drop-down list, and then select your model name (if not already selected). Click **Tools** in the left navigation bar, and then click **Uninstall**.

Follow the instructions in the dialog box to uninstall the software and drivers.

Related Information

- [Access Brother Utilities \(Windows\)](#)

USB Port Locations on Your Brother Machine

The USB port is located inside the machine.

To install the driver and software necessary to use your machine, go to your model's **Downloads** page at support.brother.com.

1. Place both hands under the plastic tabs on both sides of the machine to lift the scanner cover (1) into the open position.

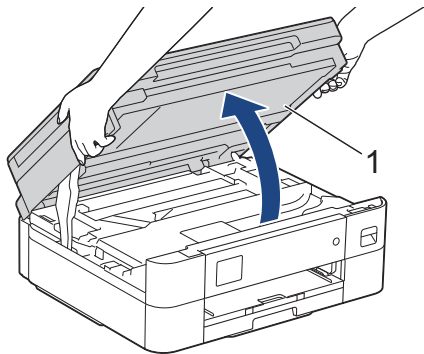

2. Locate the correct port (based on the cable you are using) inside the machine as shown.

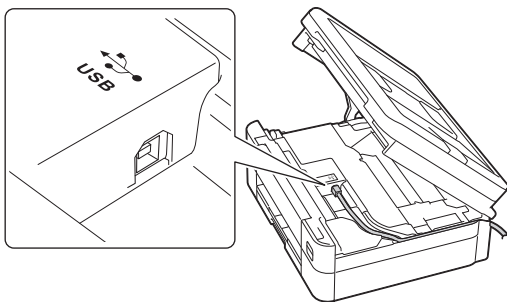

 Carefully guide the cable through the cable channel and out the back of the machine.

3. Gently close the scanner cover using both hands.

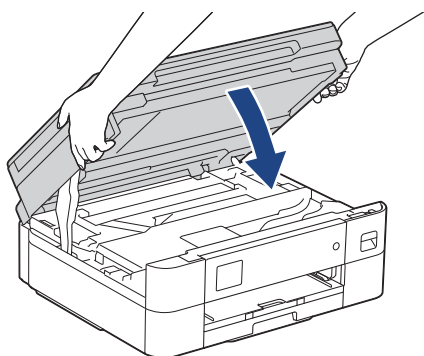

Related Information

- [Introduction to Your Machine](#)

Paper Handling

- [Load Paper](#)
- [Load Documents](#)

Load Paper

- [Load Paper in the Paper Tray](#)
- [Unprintable Area](#)
- [Paper Settings](#)
- [Acceptable Print Media](#)
- [Error and Maintenance Messages](#)
- [Paper Handling and Printing Problems](#)

Load Paper in the Paper Tray

- [Load Cut-Sheet Paper or Photo 2L Paper in the Paper Tray](#)
- [Load Envelopes in the Paper Tray](#)

Load Cut-Sheet Paper or Photo 2L Paper in the Paper Tray

- If the [Check Paper] setting is set to [On] and you pull the paper tray out of the machine, a message appears on the LCD, allowing you to change the paper size and paper type.
- Load only one size and type of paper in the paper tray at a time.
- When you load a different paper size in the tray, you must change the Paper Size setting in the machine or the paper size setting on your computer.

1. If the paper support flap (1) is open, close it, and then close the paper support (2).

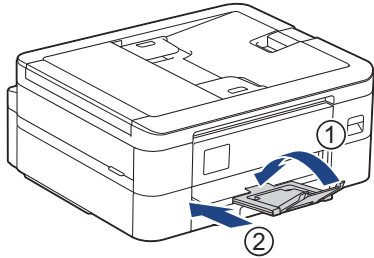

2. Pull the paper tray completely out of the machine.

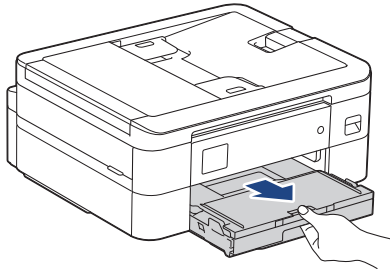

3. Lift the output paper tray cover (1).

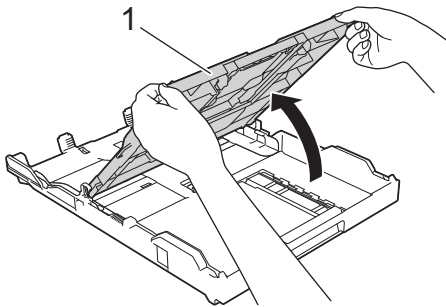

4. Gently press and slide the paper width guides (1) and then the paper length guide (2) to fit the paper size.

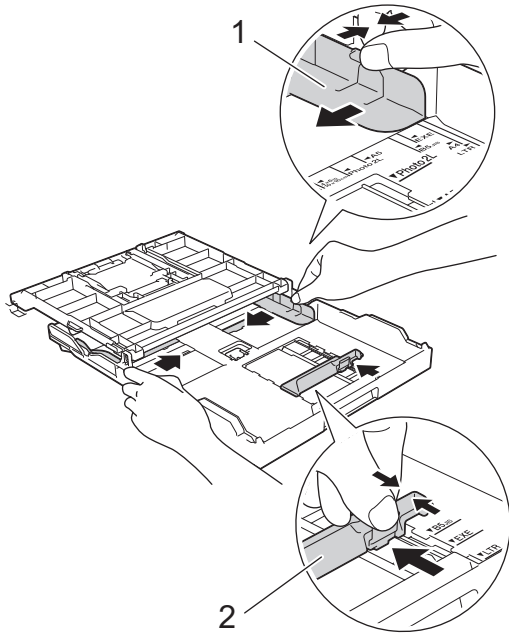

5. Fan the stack of paper well to avoid paper jams and misfeeds.

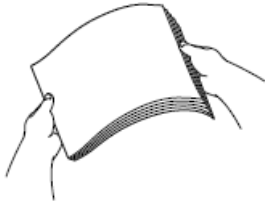

 Always make sure the paper is not curled or wrinkled.

6. Gently load paper in the paper tray with the printing surface **face down**.

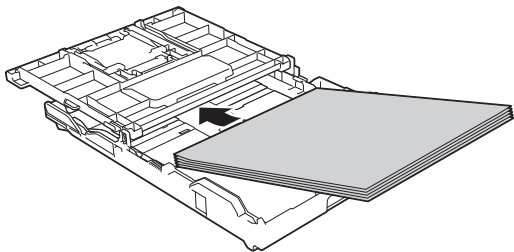

Make sure the paper is flat in the tray and the paper length guide (1) touches the edges of the paper.

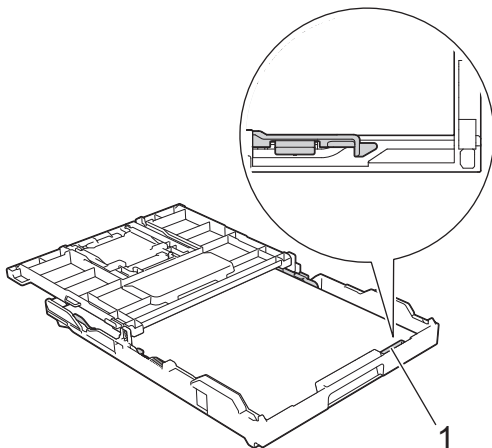

IMPORTANT

- Be careful not to push the paper in too far; it may lift at the back of the tray and cause paper feed problems.
- Loading more than 20 sheets of photo paper may cause paper jams.



To add paper before the tray is empty, remove the paper from the tray and combine it with the paper you are adding. Always fan the stack of paper well to prevent the machine from feeding multiple pages.

7. Gently adjust the paper width guides (1) to fit the paper.
Make sure the paper width guides touch the edges of the paper.

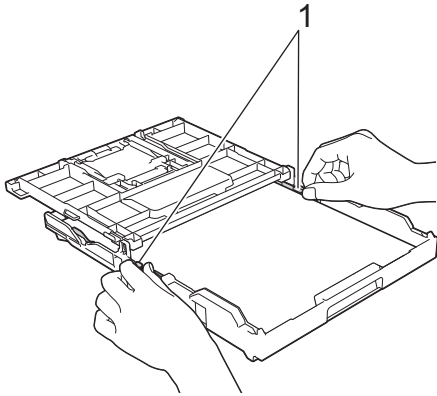

8. Close the output paper tray cover.

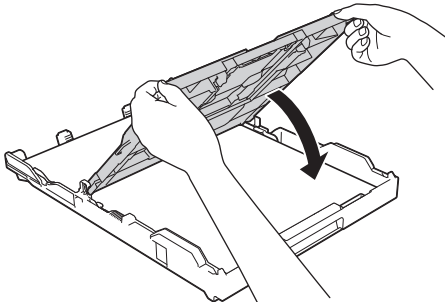

9. Slowly push the paper tray completely into the machine.

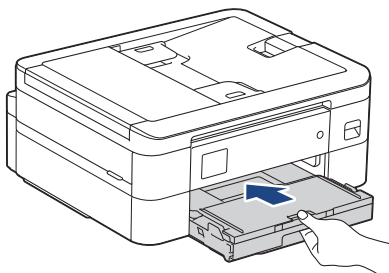

10. Pull out the paper support (1) until it locks into place, and then unfold the paper support flap (2).

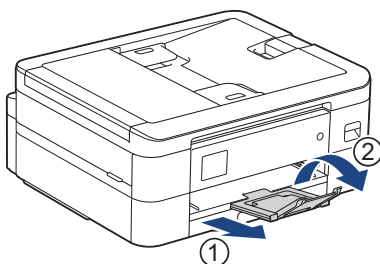



Related Information

- [Load Paper in the Paper Tray](#)

Related Topics:

- [Change the Check Paper Setting](#)
 - [Choose the Right Print Media](#)
 - [Change the Paper Size and Paper Type](#)
-

Load Envelopes in the Paper Tray

- If the [Check Paper] setting is set to [On] and you pull the paper tray out of the machine, a message appears on the LCD, allowing you to change the paper size and paper type.
- You can load envelopes in a variety of sizes. See *Related Information: Paper Type and Paper Size for Each Operation*.
- When you load envelopes in the tray, you must change the Paper Size setting in the machine or the paper size setting on your computer.
- Before loading envelopes in the tray, press the corners and sides of the envelopes to make them as flat as possible.



1. If the paper support flap (1) is open, close it, and then close the paper support (2).

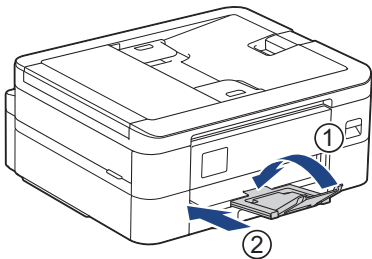

2. Pull the paper tray completely out of the machine.

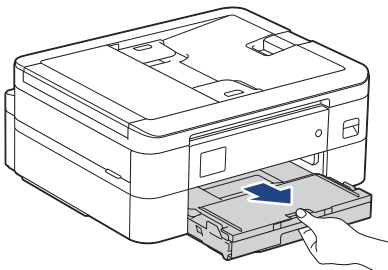

3. Lift the output paper tray cover (1).

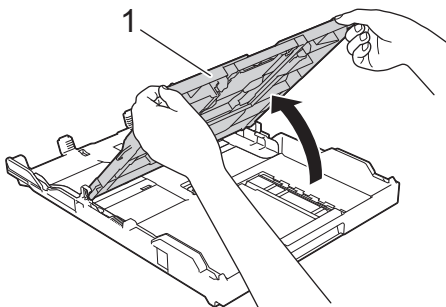

4. Load up to 10 envelopes in the paper tray with the printing surface **face down**. Loading more than 10 envelopes may cause paper jams.

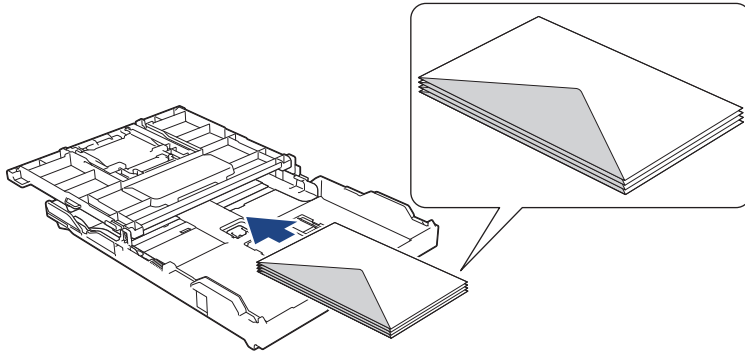

5. Gently press and slide the paper width guides (1) and paper length guide (2) to fit the size of the envelopes. Make sure the envelopes are flat in the tray.

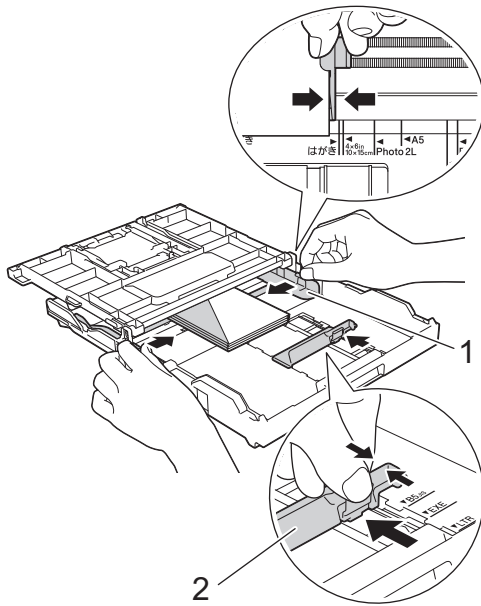

IMPORTANT

If envelopes are multi-feeding, load one envelope in the paper tray at a time.

6. Close the output paper tray cover.

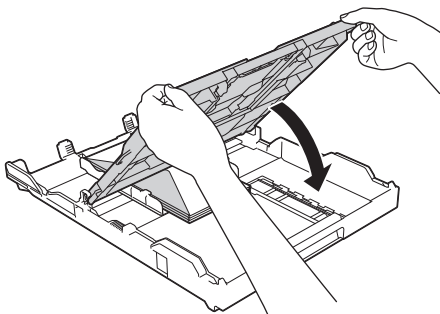

7. Slowly push the paper tray completely into the machine.

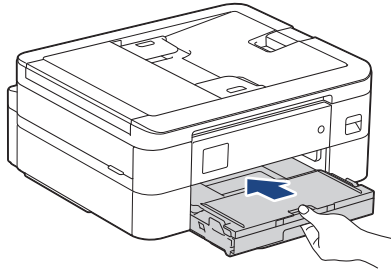

8. Pull out the paper support (1) until it locks into place, and then unfold the paper support flap (2).

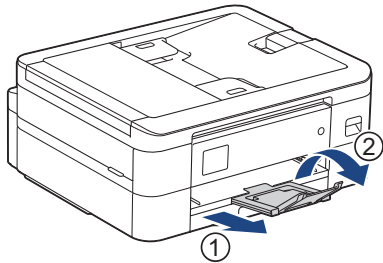

Related Information

- [Load Paper in the Paper Tray](#)

Related Topics:

- [Change the Check Paper Setting](#)
 - [Choose the Right Print Media](#)
 - [Change the Paper Size and Paper Type](#)
 - [Paper Type and Paper Size for Each Operation](#)
-

Unprintable Area

The unprintable area depends on the settings in the application you are using. The figures below show the unprintable areas on cut-sheet paper and envelopes. The machine can print in the shaded areas of cut-sheet paper only when the Borderless print feature is available and turned on.

Cut-Sheet Paper

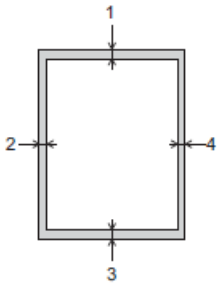

Envelopes

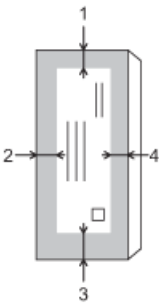

	Top (1)	Left (2)	Bottom (3)	Right (4)
Cut-Sheet	3 mm	3 mm	3 mm	3 mm
Envelopes	12 mm	3 mm	12 mm	3 mm



The Borderless print feature is not available for envelopes and 2-sided printing.



Related Information

- [Load Paper](#)

Related Topics:

- [Paper Handling and Printing Problems](#)

Paper Settings

- [Change the Paper Size and Paper Type](#)
- [Change the Check Paper Setting](#)
- [Shrink Page Size of an Oversized Incoming Fax](#)

Change the Paper Size and Paper Type

Set the Paper Size and Paper Type settings for the paper tray.

- To get the best print quality, set the machine for the type of paper you are using.
- When you change the size of the paper you load in the tray, you must change the Paper Size setting on the LCD at the same time.

>> [DCP-J1050DW/MFC-J1010DW](#)

>> [DCP-J1140DW](#)



DCP-J1050DW/MFC-J1010DW

1. Press **Settings**.
2. Press **▲** or **▼** to make your selections:
 - a. Select [General Setup]. Press **OK**.
 - b. Select [Paper Type]. Press **OK**.
 - c. Select [Plain Paper], [Inkjet Paper], [Brother BP71] or [Other Glossy]. Press **OK**.
 - d. Select [Paper Size]. Press **OK**.
 - e. Select the paper size option you want, and then press **OK**.
3. Press **Stop/Exit**.



The machine ejects paper with the printed surface face up onto the paper tray at the front of the machine. When you use glossy paper, remove each sheet at once to prevent smudging or paper jams.

DCP-J1140DW

1. Press  [Settings] > [All Settings] > [General Setup].
2. Press [Paper Type].
3. Press **▲** or **▼** to display the paper type options, and then press the option you want.
4. Press [Paper Size].
5. Press **▲** or **▼** to display the paper size options, and then press the option you want.
6. Press .



The machine ejects paper with the printed surface face up onto the paper tray at the front of the machine. When you use glossy paper, remove each sheet at once to prevent smudging or paper jams.

✓ Related Information

- [Paper Settings](#)

Related Topics:

- [Load Cut-Sheet Paper or Photo 2L Paper in the Paper Tray](#)
- [Load Envelopes in the Paper Tray](#)
- [Acceptable Print Media](#)
- [Error and Maintenance Messages](#)
- [Paper Handling and Printing Problems](#)

Change the Check Paper Setting

If this setting is set to [On] and the paper tray is removed, the LCD displays a message asking if you want to change the Paper Size and Paper Type settings.

The default setting is [On].



>> [DCP-J1050DW/MFC-J1010DW](#)

>> [DCP-J1140DW](#)

DCP-J1050DW/MFC-J1010DW

1. Press **Settings**.
2. Press **▲** or **▼** to make your selections:
 - a. Select [General Setup]. Press **OK**.
 - b. Select [Check Paper]. Press **OK**.
 - c. Select [On] or [Off]. Press **OK**.
3. Press **Stop/Exit**.

DCP-J1140DW

1. Press  [Settings] > [All Settings] > [General Setup].
2. Press **▲** or **▼** to display the [Check Paper] option, and then press it.
3. Press [On] or [Off].
4. Press .

Related Information

- [Paper Settings](#)

Related Topics:

- [Load Cut-Sheet Paper or Photo 2L Paper in the Paper Tray](#)
- [Load Envelopes in the Paper Tray](#)
- [Error and Maintenance Messages](#)

Acceptable Print Media

The print quality can be affected by the type of paper you use in the machine.

To get the best print quality for the settings you have selected, always set the Paper Type to match the type of paper you load.

You can use plain paper, inkjet paper (coated paper), glossy paper, recycled paper, and envelopes.

We recommend testing various paper types before buying large quantities.

For best results, use Brother paper.

- When you print on inkjet paper (coated paper) and glossy paper, be sure to select the correct print media in the printer driver or in the application you use to print, or the Paper Type setting on the machine.
- When you print on photo paper, load one extra sheet of the same photo paper in the paper tray.
- When using photo paper, remove each sheet at once to prevent smudging or paper jams.
- Avoid touching the printed surface of the paper immediately after printing; the surface may not be completely dry and may stain your fingers.



Related Information

- [Load Paper](#)
 - [Recommended Print Media](#)
 - [Handle and Use Print Media](#)
 - [Choose the Right Print Media](#)

Related Topics:

- [Change the Paper Size and Paper Type](#)
- [Paper Handling and Printing Problems](#)

Recommended Print Media

For the best print quality, we recommend using the Brother paper listed in the table.

Brother paper may not be available in all countries.

If Brother paper is not available in your country, we recommend testing various paper types before purchasing large quantities.

Brother paper

Paper Type	Item
A4 Plain	BP60PA
A4 Glossy Photo	BP71GA4
A4 Inkjet (Matte)	BP60MA
10 x 15 cm Glossy Photo	BP71GP



Related Information

- [Acceptable Print Media](#)

Handle and Use Print Media

- Store paper in its original packaging and keep it sealed. Keep the paper flat and away from moisture, direct sunlight and heat.
- Avoid touching the shiny (coated) side of photo paper.
- Some envelope sizes require that you set margins in the application. Make sure you do a test print first before printing many envelopes.

IMPORTANT

DO NOT use the following types of paper:

- Damaged, curled, wrinkled, or irregularly shaped

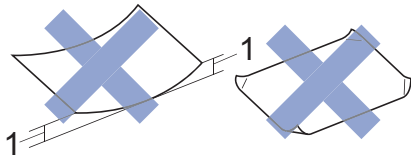

1. **2 mm or greater curl may cause jams to occur.**

- Extremely shiny or highly textured
- Paper that cannot be arranged uniformly when stacked
- Paper made with a short grain

DO NOT use envelopes that:

- Are loosely constructed
- Have windows
- Are embossed (have raised writing on them)
- Have clasps or staples
- Are pre-printed on the inside
- Are self-adhesive
- Have double flaps

Self-adhesive Double flaps

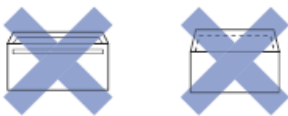

You may experience paper feed problems caused by the thickness, size and flap shape of the envelopes you are using.

✓ Related Information

- [Acceptable Print Media](#)

Related Topics:

- [Load Paper in the Paper Tray](#)

Choose the Right Print Media

- Paper Type and Paper Size for Each Operation
- Paper Capacity of the Paper Tray
- Load Cut-Sheet Paper or Photo 2L Paper in the Paper Tray
- Load Envelopes in the Paper Tray

Paper Type and Paper Size for Each Operation

Paper Type	Paper Size		Usage		
			Fax ¹	Copy	Printer
Cut-Sheet	A4	210 x 297 mm	Yes	Yes	Yes
	Letter	215.9 x 279.4 mm	Yes	Yes	Yes
	Executive	184.1 x 266.7 mm	-	-	Yes
	A5	148 x 210 mm	-	Yes	Yes
	A6	105 x 148 mm	-	-	Yes
Cards	Photo	10 x 15 cm	-	Yes	Yes
	Photo 2L	13 x 18 cm	-	-	Yes
	Index Card	13 x 20 cm	-	-	Yes
Envelopes	C5 Envelope	162 x 229 mm	-	-	Yes
	DL Envelope	110 x 220 mm	-	-	Yes
	Com-10	104.7 x 241.3 mm	-	-	Yes
	Monarch	98.4 x 190.5 mm	-	-	Yes

¹ MFC models only



Related Information

- [Choose the Right Print Media](#)

Related Topics:

- [Load Envelopes in the Paper Tray](#)

Paper Capacity of the Paper Tray

	Paper Size	Paper Types	No. of sheets	Weight	Thickness
Paper Tray	Letter, A4, Executive, A5, A6, Envelopes (C5, Com-10, DL, Monarch), Photo (10 x 15 cm), Photo 2L (13 x 18 cm), Index card (13 x 20 cm)]	Plain Paper, Recycled Paper	150 ¹	64 to 120 g/m ²	0.08 to 0.15 mm
		Inkjet Paper	20	64 to 200 g/m ²	0.08 to 0.25 mm
		Glossy Paper ² , Photo ²	20	Up to 220 g/m ²	Up to 0.25 mm
		Index Card	30	Up to 200 g/m ²	Up to 0.15 mm
		Envelopes	10	80 to 95 g/m ²	Up to 0.52 mm

¹ When using plain paper 80 g/m².

² BP71 260 g/m² paper is specially designed for Brother inkjet machines.



Related Information

- [Choose the Right Print Media](#)

Load Documents

- [Load Documents in the Automatic Document Feeder \(ADF\)](#)
- [Load Documents on the Scanner Glass](#)
- [Unscannable Area](#)

Load Documents in the Automatic Document Feeder (ADF)

Related Models: MFC-J1010DW

The ADF can hold multiple pages and feeds each sheet individually.

Use paper that is within the sizes and weights shown in the table. Always fan the pages before placing them in the ADF.

Document Sizes and Weights

Length ¹ :	148 to 355.6 mm
Width:	148 to 215.9 mm
Paper Weight:	64 to 90 g/m ²

¹ Documents that are longer than 297 mm must be fed one page at a time.

IMPORTANT

- DO NOT pull on the document while it is feeding.
- DO NOT use paper that is curled, wrinkled, folded, ripped, stapled, paper clipped, pasted or taped.
- DO NOT use cardboard, newspaper or fabric.
- Make sure documents with correction fluid or written in ink are completely dry.

1. Lift and unfold the ADF document support (1).

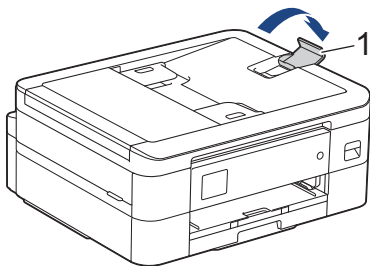

2. Fan the stack of paper well to avoid paper jams and misfeeds.
3. Adjust the paper guides (1) to fit the document size.

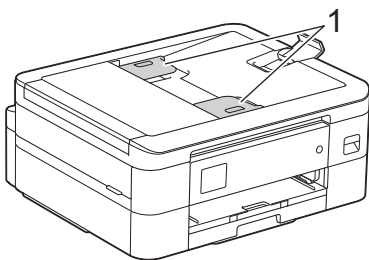

4. Place your document, **face down, top edge first** in the ADF underneath the paper guides until you feel the document touch the feed rollers and the LCD displays [ADF Ready].

IMPORTANT

DO NOT leave any documents on the scanner glass. If you do this, the ADF may jam.

✓ Related Information

- [Load Documents](#)

Related Topics:

- [Copy a Document](#)
 - [Error and Maintenance Messages](#)
 - [Telephone and Fax Problems](#)
 - [Other Problems](#)
-

Load Documents on the Scanner Glass

Use the scanner glass to fax, copy, or scan one page at a time.

Document Sizes Supported

Length:	Up to 297 mm
Width:	Up to 215.9 mm
Weight:	Up to 2 kg



(ADF models)

To use the scanner glass, the ADF must be empty and the ADF document support must be closed.

1. Lift the document cover.
2. Place the document **face down** in the upper left corner of the scanner glass as shown in the illustration.

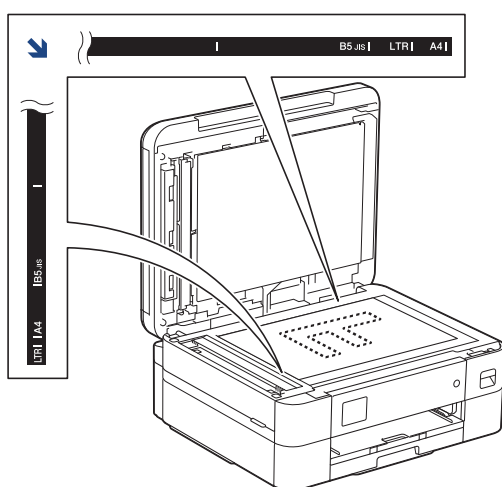

3. Close the document cover.

IMPORTANT

If you are scanning a book or thick document, DO NOT forcefully close or press on the document cover.



Related Information

- [Load Documents](#)

Related Topics:

- [Copy a Document](#)
- [Telephone and Fax Problems](#)
- [Other Problems](#)

Unscannable Area

The unscannable area of a page depends on the settings in the application you are using. The figures below show the typical unscannable measurements.

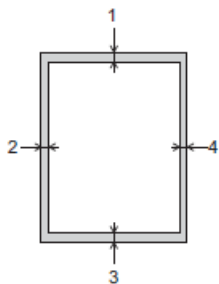

Usage	Document Size	Top (1) Bottom (3)	Left (2) Right (4)
Fax ¹	A4	3 mm	3 mm ²
	Letter		4 mm
	Legal		
Copy	All paper sizes	3 mm	3 mm
Scan		1 mm	1 mm

¹ MFC-J1010DW only

² The unscannable area is 1 mm when using the ADF.



Related Information

- [Load Documents](#)

Print

- [Print from Your Computer \(Windows\)](#)
- [Print from Your Computer \(Mac\)](#)
- [Print Using Brother iPrint&Scan \(Windows/Mac\)](#)
- [Print an Email Attachment](#)

Print from Your Computer (Windows)

- [Print a Photo \(Windows\)](#)
- [Print a Document \(Windows\)](#)
- [Cancel a Print Job \(Windows\)](#)
- [Print More Than One Page on a Single Sheet of Paper \(N in 1\) \(Windows\)](#)
- [Print as a Poster \(Windows\)](#)
- [Print on Both Sides of the Paper Automatically \(Automatic 2-sided Printing\) \(Windows\)](#)
- [Print as a Booklet Automatically \(Windows\)](#)
- [Print a Colour Document in Greyscale \(Windows\)](#)
- [Prevent Smudged Printouts and Paper Jams \(Windows\)](#)
- [Use a Preset Print Profile \(Windows\)](#)
- [Change the Default Print Settings \(Windows\)](#)
- [Print Settings \(Windows\)](#)

Print a Photo (Windows)



1. Select the print command in your application.
2. Select **Brother XXX-XXXX Printer** (where XXX-XXXX is the name of your model), and then click the printing properties or preferences button.
The printer driver window appears.
3. Make sure you have loaded the correct media in the paper tray.

IMPORTANT

- For best results, use Brother paper.
- When you print on photo paper, load one extra sheet of the same photo paper in the paper tray.

4. Click the **Basic** tab.
5. Click the **Media Type** drop-down list, and then select the type of paper you are using.

IMPORTANT

To get the best print quality for the settings you have selected, always set the **Media Type** option to match the type of paper you load.

6. Click the **Paper Size** drop-down list, and then select your paper size.
7. Select the **Borderless** check box, if needed.
8. For **Colour / Greyscale**, select **Colour**.
9. In the **Orientation** field, select the **Portrait** or **Landscape** option to set the orientation of your printout.



If your application contains a similar setting, we recommend that you set the orientation using the application.

10. Type the number of copies (1-999) you want in the **Copies** field.
11. Change other printer settings, if needed.
12. Click **OK**.
13. Complete your print operation.



Related Information

- [Print from Your Computer \(Windows\)](#)

Related Topics:

- [Print Settings \(Windows\)](#)

Print a Document (Windows)

1. Select the print command in your application.
2. Select **Brother XXX-XXXX Printer** (where XXX-XXXX is the name of your model), and then click the printing properties or preferences button.
The printer driver window appears.
3. Make sure you have loaded the correct size paper in the paper tray.
4. Click the **Basic** tab.
5. Click the **Media Type** drop-down list, and then select the type of paper you are using.

IMPORTANT

To get the best print quality for the settings you have selected, always set the **Media Type** option to match the type of paper you load.

6. Click the **Paper Size** drop-down list, and then select your paper size.
7. For **Colour / Greyscale**, select the **Colour** or **Greyscale** option.
8. In the **Orientation** field, select the **Portrait** or **Landscape** option to set the orientation of your printout.



If your application contains a similar setting, we recommend that you set the orientation using the application.

9. Type the number of copies (1-999) you want in the **Copies** field.
10. To print multiple pages on a single sheet of paper or print one page of your document on multiple sheets, click the **Multiple Page** drop-down list, and then select your options.
11. Change other printer settings, if needed.
12. Click **OK**.
13. Complete your print operation.



Related Information

- [Print from Your Computer \(Windows\)](#)

Related Topics:

- [Check the Ink Volume \(Page Gauge\)](#)
- [Print Settings \(Windows\)](#)

Cancel a Print Job (Windows)

If a print job was sent to the print queue and did not print, or was sent to the print queue in error, you may have to delete it to allow subsequent jobs to print.

1. Double-click the printer icon  in the task tray.
2. Select the print job you want to cancel.
3. Click the **Document** menu.
4. Select **Cancel**.
5. Click **Yes**.



Related Information

- [Print from Your Computer \(Windows\)](#)

Related Topics:

- [Monitor Machine Status from Your Computer \(Windows\)](#)
-

Print More Than One Page on a Single Sheet of Paper (N in 1) (Windows)



1. Select the print command in your application.
2. Select **Brother XXX-XXXX Printer** (where XXX-XXXX is the name of your model), and then click the printing properties or preferences button.
The printer driver window appears.
3. Click the **Basic** tab.
4. In the **Orientation** field, select the **Portrait** or **Landscape** option to set the orientation of your printout.



If your application contains a similar setting, we recommend that you set the orientation using the application.

5. Click the **Multiple Page** drop-down list, and then select the **2 in 1**, **4 in 1**, **9 in 1**, or **16 in 1** option.
6. Click the **Page Order** drop-down list, and then select your page order.
7. Click the **Border Line** drop-down list, and then select your border line type.
8. Change other printer settings, if needed.
9. Click **OK**, and then complete your print operation.



Related Information

- [Print from Your Computer \(Windows\)](#)

Related Topics:

- [Print Settings \(Windows\)](#)

Print as a Poster (Windows)

Enlarge your print size and print the document in poster mode.

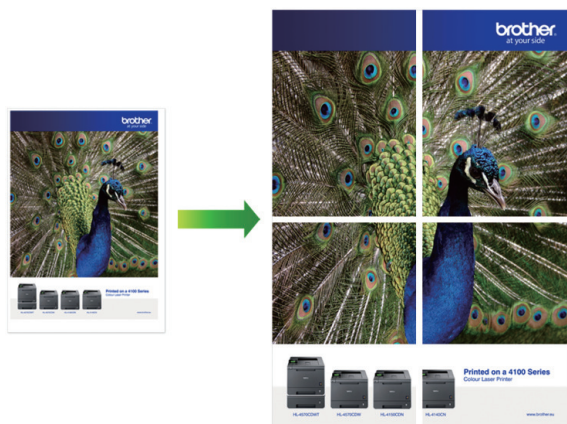

1. Select the print command in your application.
2. Select **Brother XXX-XXXX Printer** (where XXX-XXXX is the name of your model), and then click the printing properties or preferences button.
The printer driver window appears.
3. Click the **Basic** tab.
4. Click the **Multiple Page** drop-down list, and then select the **1 in 2x2 Pages** or **1 in 3x3 Pages** option.
5. Change other printer settings, if needed.
6. Click **OK**.
7. Complete your print operation.

✓ Related Information

- [Print from Your Computer \(Windows\)](#)

Related Topics:

- [Print Settings \(Windows\)](#)

Print on Both Sides of the Paper Automatically (Automatic 2-sided Printing) (Windows)



- Make sure the jam clear cover is closed.
- If paper is curled, straighten it and put it back in the paper tray.
- Use regular paper. DO NOT use bond paper.
- If the paper is thin, it may wrinkle.

1. Select the print command in your application.
2. Select **Brother XXX-XXXX Printer** (where XXX-XXXX is the name of your model), and then click the printing properties or preferences button.
The printer driver window appears.
3. Click the **Basic** tab.
4. In the **Orientation** field, select the **Portrait** or **Landscape** option to set the orientation of your printout.



If your application contains a similar setting, we recommend that you set the orientation using the application.

5. Click the **2-sided / Booklet** drop-down list, and then select **2-sided**.
6. Click the **2-sided Settings** button.
7. Select one of the options from the **2-sided Type** menu.

When 2-sided is selected, four types of 2-sided binding are available for each orientation:

Option for Portrait	Description
Long Edge (Left)	A diagram of a booklet bound on the left edge. The pages are numbered 1, 2, and 3 from left to right. Page 1 is on the left, page 2 is in the middle, and page 3 is on the right.
Long Edge (Right)	A diagram of a booklet bound on the right edge. The pages are numbered 3, 2, and 1 from left to right. Page 3 is on the left, page 2 is in the middle, and page 1 is on the right.

Option for Portrait	Description
---------------------	-------------

Short Edge (Top)

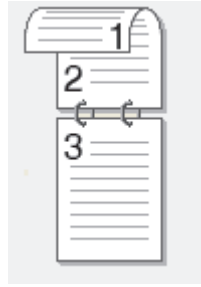

Short Edge (Bottom)

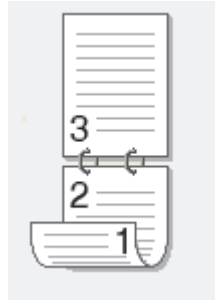

Option for Landscape	Description
----------------------	-------------

Long Edge (Top)



Long Edge (Bottom)

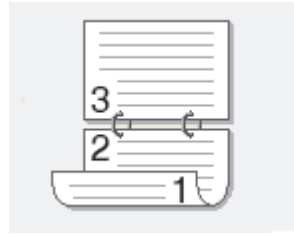

Short Edge (Right)

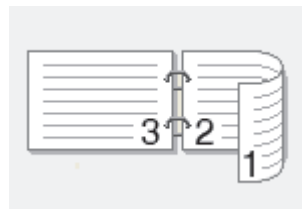

Short Edge (Left)

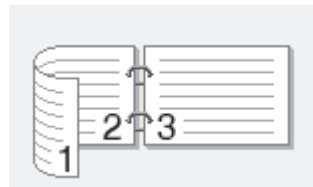

8. Select the **Binding Offset** check box to specify the offset for binding in inches or millimetres.
9. Click **OK** to return to the printer driver window.
10. Change other printer settings, if needed.



The Borderless feature is not available when using this option.

11. Click **OK** again, and then complete your print operation.



Related Information

- [Print from Your Computer \(Windows\)](#)

Related Topics:

- [Print Settings \(Windows\)](#)
 - [Print as a Booklet Automatically \(Windows\)](#)
-

Print as a Booklet Automatically (Windows)

Use this option to print a document in booklet format using 2-sided printing. The document's pages will be arranged according to the correct page number and will allow you to fold at the centre of the print output without having to change the order of the printed pages.



- Make sure the jam clear cover is closed.
- If paper is curled, straighten it and put it back in the paper tray.
- Use regular paper. DO NOT use bond paper.
- If the paper is thin, it may wrinkle.

1. Select the print command in your application.
2. Select **Brother XXX-XXXX Printer** (where XXX-XXXX is the name of your model), and then click the printing properties or preferences button.
The printer driver window appears.
3. Click the **Basic** tab.
4. In the **Orientation** field, select the **Portrait** or **Landscape** option to set the orientation of your printout.

 If your application contains a similar setting, we recommend that you set the orientation using the application.

5. Click the **2-sided / Booklet** drop-down list, and then select the **Booklet** option.
6. Click the **2-sided Settings** button.
7. Select one of the options from the **2-sided Type** menu.

There are two types of 2-sided binding directions available for each orientation:

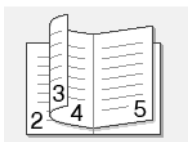
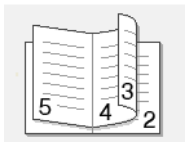
Option for Portrait	Description
Left Binding	
Right Binding	

Option for Landscape	Description
----------------------	-------------

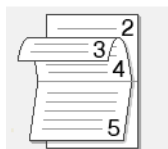

Top Binding

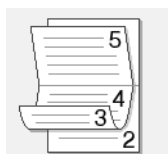

Bottom Binding



8. Select one of the options from the **Booklet Printing Method** menu.

Option	Description
All Pages at Once	Every page will be printed in booklet format (four pages to every piece of paper, two pages per side). Fold your printout in the middle to create the booklet. 
Divide into Sets	This option prints the whole booklet in smaller individual booklet sets, allowing you to fold at the centre of the smaller individual booklet sets without having to change the order of the printed pages. You can specify the number of sheets in each smaller booklet set (from 1-15). This option can be helpful when folding a printed booklet that has a large number of pages. 

9. Select the **Binding Offset** check box to specify the offset for binding in inches or millimetres.

10. Click **OK** to return to the printer driver window.

11. Change other printer settings, if needed.



The Borderless feature is not available when using this option.

12. Click **OK**.

13. Complete your print operation.



Related Information

- [Print from Your Computer \(Windows\)](#)

Related Topics:

- [Print Settings \(Windows\)](#)
- [Print on Both Sides of the Paper Automatically \(Automatic 2-sided Printing\) \(Windows\)](#)

Print a Colour Document in Greyscale (Windows)

Greyscale mode makes the print processing speed faster than colour mode. If your document contains colour, selecting Greyscale mode prints your document in 256 levels of greyscale.

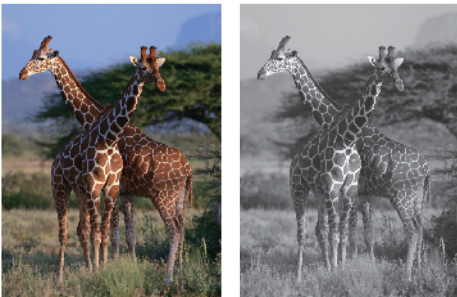

1. Select the print command in your application.
2. Select **Brother XXX-XXXX Printer** (where XXX-XXXX is the name of your model), and then click the printing properties or preferences button.
The printer driver window appears.
3. Click the **Basic** tab.
4. For **Colour / Greyscale**, select **Greyscale**.
5. Change other printer settings, if needed.
6. Click **OK**.
7. Complete your print operation.



Related Information

- [Print from Your Computer \(Windows\)](#)

Prevent Smudged Printouts and Paper Jams (Windows)

Some types of print media may need more drying time. Change the **Reduce Smudge** option if you have problems with smudged printouts or paper jams.

1. Select the print command in your application.
2. Select **Brother XXX-XXXX Printer** (where XXX-XXXX is the name of your model), and then click the printing properties or preferences button.

The printer driver window appears.

3. Click the **Advanced** tab.
4. Click the **Other Print Options** button.
5. Select the **Reduce Smudge** option on the left side of the screen.
6. Select one of the following options:

Media Type	Option	Description
Plain Paper	2-sided Printing or Simplex Printing	Off / On Select Off to print at normal speed, using a standard amount of ink. Select On to print at a slower speed, using less ink. Printouts may be lighter than they appear in Print Preview.

7. Click **OK** to return to the printer driver window.
8. Click **OK**.
9. Complete your print operation.



Related Information

- [Print from Your Computer \(Windows\)](#)

Related Topics:

- [Paper Handling and Printing Problems](#)
- [Change the Print Options to Improve Your Print Results](#)

Use a Preset Print Profile (Windows)

Print Profiles are presets designed to give you quick access to frequently-used printing configurations.

1. Select the print command in your application.
2. Select **Brother XXX-XXXX Printer** (where XXX-XXXX is the name of your model), and then click the printing properties or preferences button.
The printer driver window appears.
3. Click the **Print Profiles** tab.

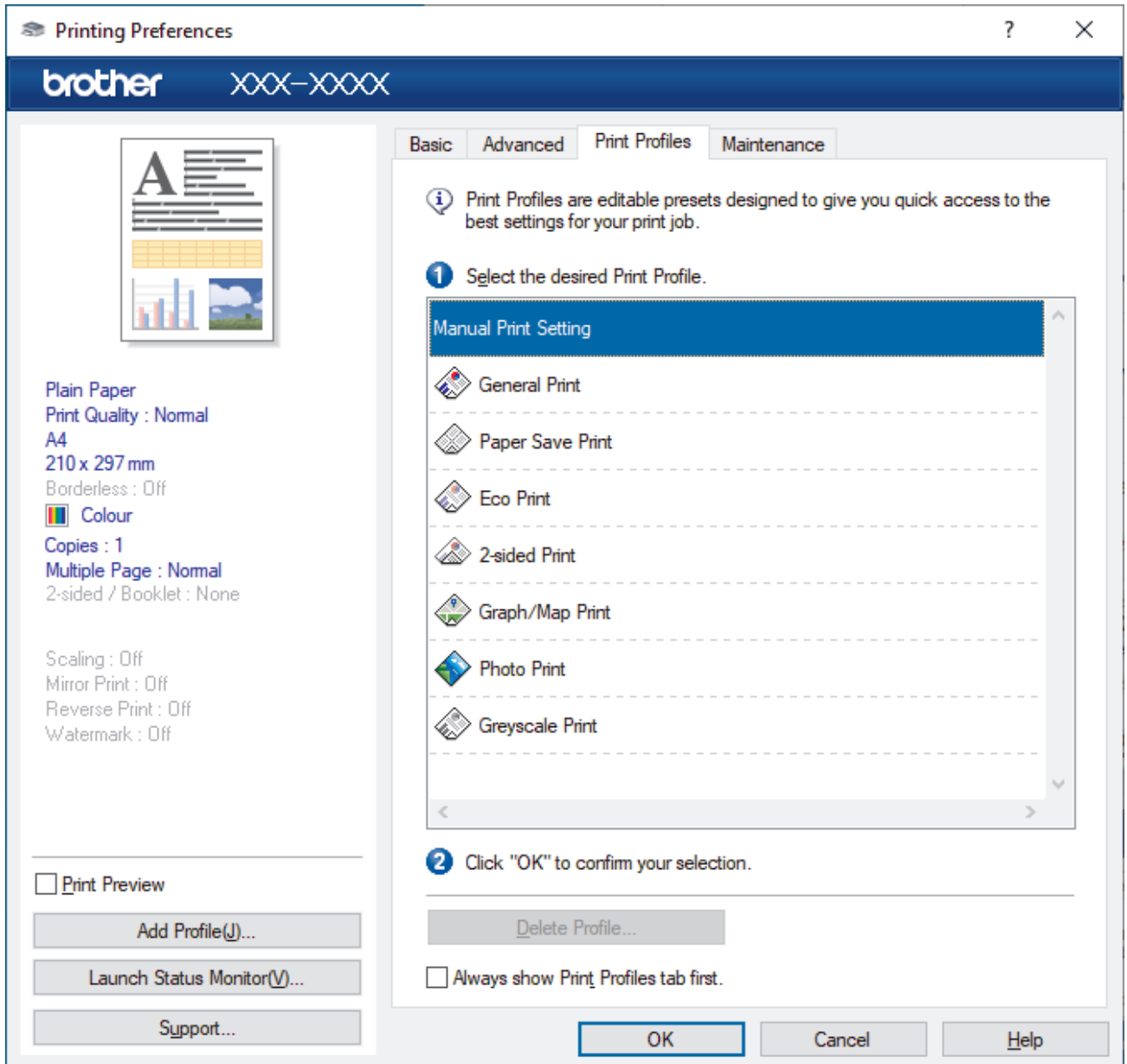

4. Select your profile from the print profile list.
The profile settings are shown on the left side of the printer driver window.
5. Do one of the following:
 - If the settings are correct for your print job, click **OK**.
 - To change the settings, go back to the **Basic** or **Advanced** tab, change settings, and then click **OK**.



To display the **Print Profiles** tab at the front of the window the next time you print, select the **Always show Print Profiles tab first**. check box.



Related Information

- [Print from Your Computer \(Windows\)](#)
 - [Create or Delete Your Print Profile \(Windows\)](#)

Related Topics:

- [Print Settings \(Windows\)](#)
-

Create or Delete Your Print Profile (Windows)

Add up to 20 new print profiles with customised settings.

1. Select the print command in your application.
2. Select **Brother XXX-XXXX Printer** (where XXX-XXXX is the name of your model), and then click the printing properties or preferences button.

The printer driver window appears.

3. Do one of the following:

To create a new print profile:

- a. Click the **Basic** tab and the **Advanced** tab, and configure the print settings you want for the new Print Profile.
- b. Click the **Print Profiles** tab.
- c. Click **Add Profile**.
The **Add Profile** dialog box appears.
- d. Type the new profile name in the **Name** field.
- e. Click the icon you want to use to represent this profile from the icon list.
- f. Click **OK**.

The new Print Profile name is added to the list in the **Print Profiles** tab.

To delete a print profile that you created:

- a. Click the **Print Profiles** tab.
- b. Click **Delete Profile**.
The **Delete Profile** dialog box appears.
- c. Select the profile you want to delete.
- d. Click **Delete**.
- e. Click **Yes**.
- f. Click **Close**.





Related Information

- [Use a Preset Print Profile \(Windows\)](#)

Change the Default Print Settings (Windows)

When you change an application's print settings, the changes only apply to documents printed with that application. To change print settings for all Windows applications, you must configure the printer driver properties.

1. Do one of the following:
 - For Windows Server 2008
Click  (**Start**) > **Control Panel** > **Hardware and Sound** > **Printers**.
 - For Windows 7 and Windows Server 2008 R2
Click  (**Start**) > **Devices and Printers**.
 - For Windows 8.1
Move your mouse to the lower right corner of your desktop. When the menu bar appears, click **Settings**, and then click **Control Panel**. In the **Hardware and Sound** group, click **View devices and printers**.
 - For Windows 10, Windows Server 2016 and Windows Server 2019
Click  > **Windows System** > **Control Panel**. In the **Hardware and Sound** group, click **View devices and printers**.
 - For Windows Server 2012
Move your mouse to the lower right corner of your desktop. When the menu bar appears, click **Settings**, and then click **Control Panel**. In the **Hardware** group, click **View devices and printers**.
 - For Windows Server 2012 R2
Click **Control Panel** on the **Start** screen. In the **Hardware** group, click **View devices and printers**.
2. Right-click the **Brother XXX-XXXX Printer** icon (where XXX-XXXX is the name of your model), and then select **Printer properties**. If printer driver options appear, select your printer driver.
The printer properties dialog box appears.
3. Click the **General** tab, and then click the **Printing Preferences...** or **Preferences...** button.
The printer driver dialog box appears.
4. Select the print settings you want to use as defaults for all of your Windows programs.
5. Click **OK**.
6. Close the printer properties dialog box.



Related Information

- [Print from Your Computer \(Windows\)](#)

Related Topics:

- [Print Settings \(Windows\)](#)

Print Settings (Windows)

- >> Basic Tab
- >> Advanced Tab

Basic Tab

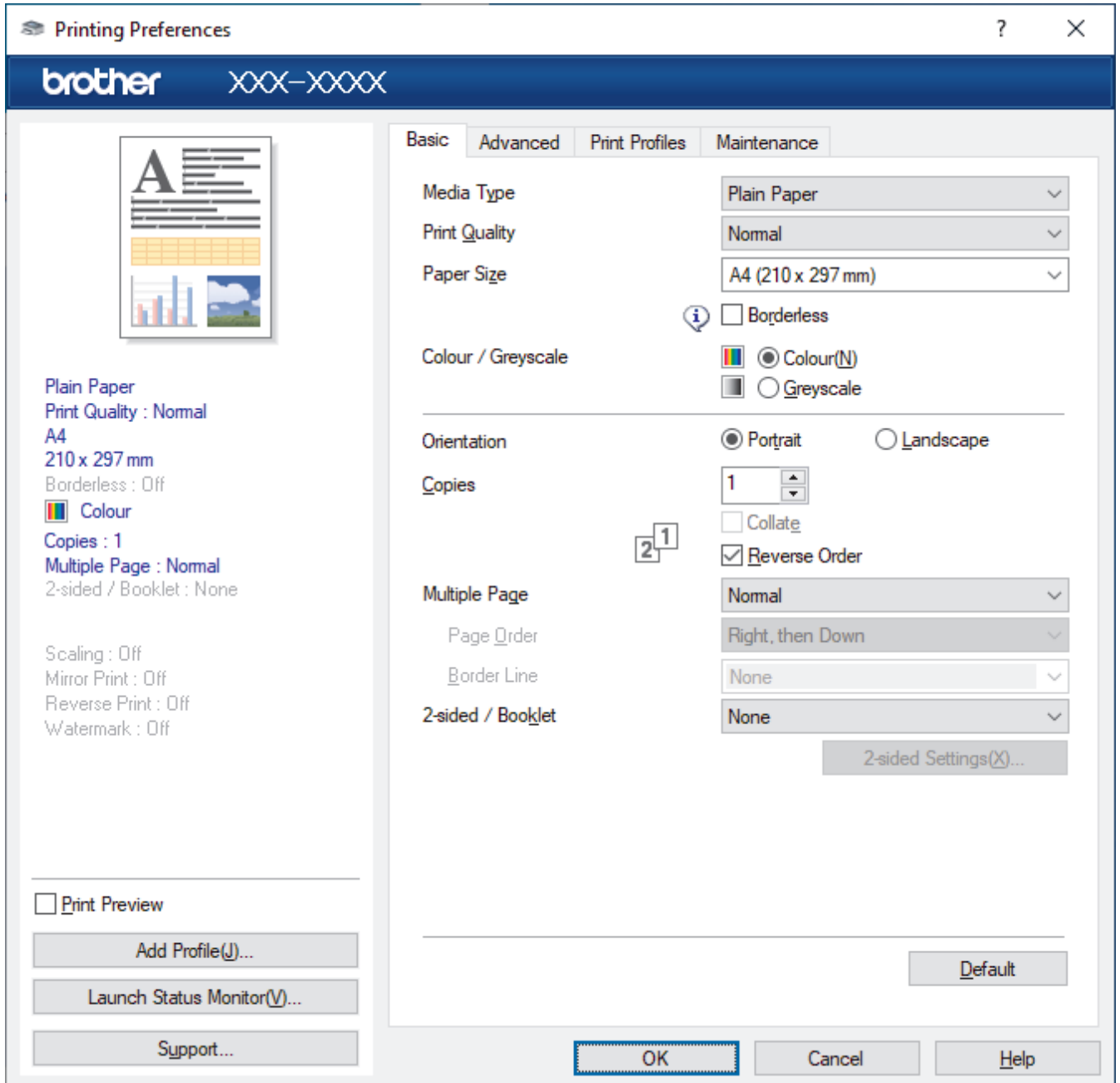

1. Media Type

Select the media type you want to use. To achieve the best print results, the machine automatically adjusts its print settings according to the selected media type.

2. Print Quality

Select the print quality you want. Because print quality and speed are related, the higher the quality, the longer it will take to print the document.

3. Paper Size

Select the paper size you want to use. You can either choose from standard paper sizes or create a custom paper size.

Borderless

Select this option to print photos without borders. Because the image data is created slightly larger than the paper size you are using, this will cause some cropping of the photo edges.

You may not be able to select the Borderless option for some combinations of media type and quality, or from some applications.

4. Colour / Greyscale

Select colour or greyscale printing. The print speed is faster in greyscale mode than it is in colour mode. If your document contains colour and you select greyscale mode, your document will be printed using 256 levels of greyscale.

5. Orientation

Select the orientation (portrait or landscape) of your printout.

If your application contains a similar setting, we recommend that you set the orientation using the application.

6. Copies

Type the number of copies (1-999) that you want to print in this field.

Collate

Select this option to print sets of multi-page documents in the original page order. When this option is selected, one complete copy of your document will print, and then reprint according to the number of copies you choose. If this option is not selected, then each page will print according to the number of copies chosen before the next page of the document is printed.

Reverse Order

Select this option to print your document in reverse order. The last page of your document will be printed first.

7. Multiple Page

Select this option to print multiple pages on a single sheet of paper, or print one page of your document on multiple sheets.

Page Order

Select the page order when printing multiple pages on a single sheet of paper.

Border Line

Select the type of border to use when printing multiple pages on a single sheet of paper.

8. 2-sided / Booklet

Select this option to print on both sides of the paper, or print a document in booklet format using 2-sided printing.

2-sided Settings button

Click this button to select the type of 2-sided binding. Four types of 2-sided bindings are available for each orientation.

Advanced Tab

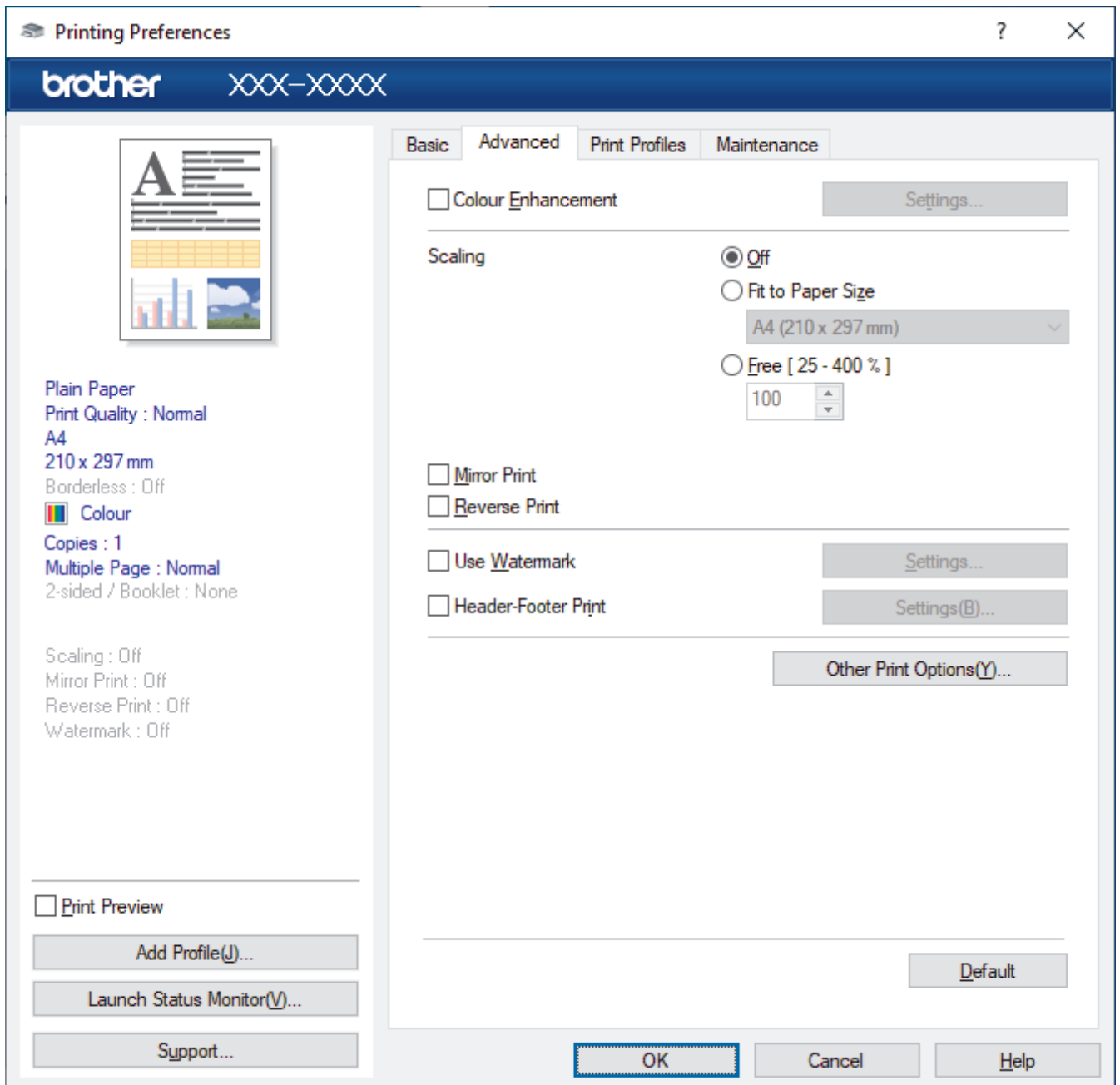

1. Colour Enhancement

Select this option to use the Colour Enhancement feature. This feature analyses your image to improve its sharpness, white balance and colour density. This process may take several minutes depending on the image size and your computer's specifications.

2. Scaling

Select these options to enlarge or reduce the size of the pages in your document.

Fit to Paper Size

Select this option to enlarge or reduce the document pages to fit a specified paper size. When you select this option, select the paper size you want from the drop-down list.

Free [25 - 400 %]

Select this option to enlarge or reduce the document pages manually. When you select this option, type a value into the field.

3. Mirror Print

Select this option to reverse the printed image on the page horizontally from left to right.

4. Reverse Print

Select this option to rotate the printed image 180 degrees.

5. Use Watermark

Select this option to print a logo or text on your document as a watermark. Select one of the preset watermarks, add a new watermark, or use an image file you have created.

6. Header-Footer Print

Select this option to print the date, time and PC login user name on the document.

7. Other Print Options button

Advanced Colour Settings

Select the method that the machine uses to arrange dots to express halftones.

The printout colour can be adjusted to achieve the closest match to what appears on your computer screen.

(DCP-J1050DW/MFC-J1010DW) Advanced Quality Settings

Select this option to print your documents at the highest quality.

Reduce Smudge

Some types of print media may need more drying time. Change this option if you have problems with smudged printouts or paper jams.

Retrieve Printer's Colour Data

Select this option to optimise the print quality using the machine's factory settings, which are set specifically for your Brother machine. Use this option when you have replaced the machine or changed the machine's network address.

Print Archive

Select this option to save the print data as a PDF file to your computer.



Related Information

- [Print from Your Computer \(Windows\)](#)

Related Topics:

- [Error and Maintenance Messages](#)
 - [Paper Handling and Printing Problems](#)
 - [Print a Photo \(Windows\)](#)
 - [Print a Document \(Windows\)](#)
 - [Print More Than One Page on a Single Sheet of Paper \(N in 1\) \(Windows\)](#)
 - [Print as a Poster \(Windows\)](#)
 - [Print on Both Sides of the Paper Automatically \(Automatic 2-sided Printing\) \(Windows\)](#)
 - [Print as a Booklet Automatically \(Windows\)](#)
 - [Use a Preset Print Profile \(Windows\)](#)
 - [Change the Default Print Settings \(Windows\)](#)
 - [Change the Print Options to Improve Your Print Results](#)
-

Print from Your Computer (Mac)

- [Print Using AirPrint](#)

Print Using Brother iPrint&Scan (Windows/Mac)

- [Print Photos or Documents Using Brother iPrint&Scan \(Windows/Mac\)](#)
- [Print on Both Sides of the Paper Automatically Using Brother iPrint&Scan \(Automatic 2-sided Printing\)\(Windows/Mac\)](#)
- [Print More Than One Page on a Single Sheet of Paper Using Brother iPrint&Scan \(N in 1\) \(Windows/Mac\)](#)
- [Print a Colour Document in Greyscale Using Brother iPrint&Scan \(Windows/Mac\)](#)

Print Photos or Documents Using Brother iPrint&Scan (Windows/Mac)



1. Make sure you have loaded the correct media in the paper tray.

IMPORTANT

For photo printing:

- For best results, use Brother paper.
- When you print on photo paper, load one extra sheet of the same photo paper in the paper tray.

2. Start Brother iPrint&Scan.

- Windows

Launch  (Brother iPrint&Scan).

- Mac

In the **Finder** menu bar, click **Go > Applications**, and then double-click the iPrint&Scan icon.

The Brother iPrint&Scan screen appears.

3. If your Brother machine is not selected, click the **Select your Machine** button, and then select your model name from the list. Click **OK**.
4. Click **Print**.
5. Do one of the following:
 - Windows
Click **Photo** or **Document**.
 - Mac
Click **Photo** or **PDF**.
6. Select the file you want to print, and then do one of the following:
 - Windows
Click **Next**.
 - Mac
Click **Open**.

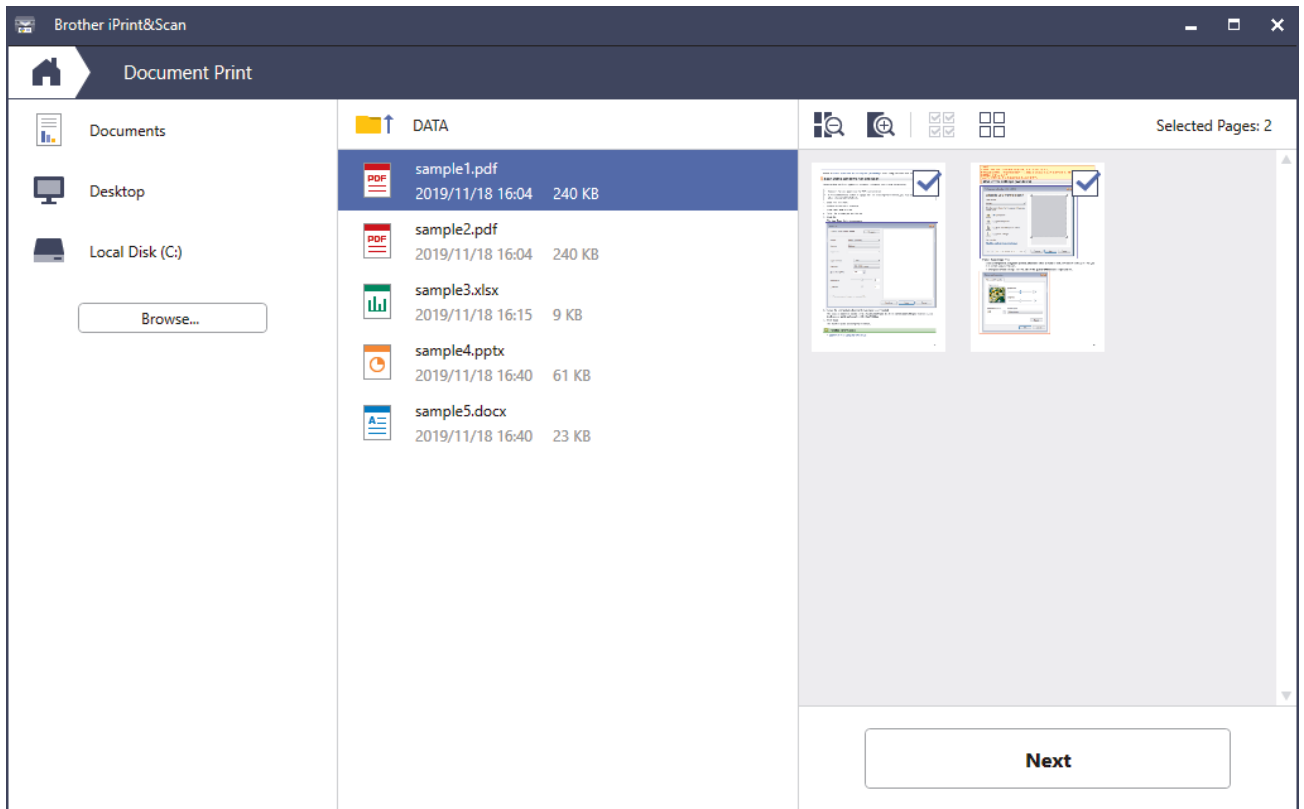

- The actual screen may differ depending on the version of the application.
- Use the latest application. See *Related Information*.
- When printing documents with many pages, you can also select the pages you want to print.

7. Change other printer settings, if needed.

8. Click **Print**.

IMPORTANT

For photo printing:

To get the best print quality for the settings you have selected, always set the **Media Type** option to match the type of paper you load.



Related Information

- [Print Using Brother iPrint&Scan \(Windows/Mac\)](#)

Print on Both Sides of the Paper Automatically Using Brother iPrint&Scan (Automatic 2-sided Printing)(Windows/Mac)



- Make sure the jam clear cover is closed.
- If paper is curled, straighten it and put it back in the paper tray.
- Use regular paper. DO NOT use bond paper.
- If the paper is thin, it may wrinkle.

1. Start Brother iPrint&Scan.

- Windows

Launch  (Brother iPrint&Scan).

- Mac

In the **Finder** menu bar, click **Go > Applications**, and then double-click the iPrint&Scan icon.

The Brother iPrint&Scan screen appears.

2. If your Brother machine is not selected, click the **Select your Machine** button, and then select your model name from the list. Click **OK**.

3. Click **Print**.

4. Do one of the following:

- Windows
Click **Document**.
- Mac
Click **PDF**.

5. Select the file you want to print, and then do one of the following:

- Windows
Click **Next**.
- Mac
Click **Open**.



When printing documents with many pages, you can also select the pages you want to print.

6. Select one of the options from the **2-sided** drop-down list.

Two types of 2-sided binding are available:

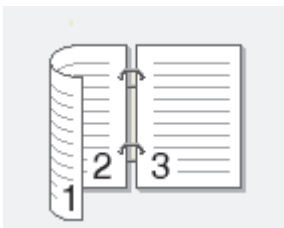
Option	Description
On (Flip on long edge)	

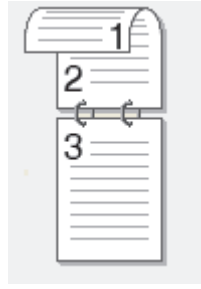
Option**Description****On (Flip on short edge)**

-
7. Change other printer settings, if needed.
 8. Click **Print**.

**Related Information**

- [Print Using Brother iPrint&Scan \(Windows/Mac\)](#)
-

Print More Than One Page on a Single Sheet of Paper Using Brother iPrint&Scan (N in 1) (Windows/Mac)



1. Launch  (**Brother iPrint&Scan**).

The Brother iPrint&Scan screen appears.

2. If your Brother machine is not selected, click the **Select your Machine** button, and then select your model name from the list. Click **OK**.
3. Click **Print**.
4. Do one of the following:
 - Windows
Click **Document**.
 - Mac
Click **PDF**.
5. Select the file you want to print, and then do one of the following:
 - Windows
Click **Next**.
 - Mac
Click **Open**.



When printing documents with many pages, you can also select the pages you want to print.

6. Click the **Layout** drop-down list, and then select the number of pages to print on each sheet.
7. Change other printer settings, if needed.
8. Click **Print**.





Related Information

- [Print Using Brother iPrint&Scan \(Windows/Mac\)](#)

Print a Colour Document in Greyscale Using Brother iPrint&Scan (Windows/Mac)

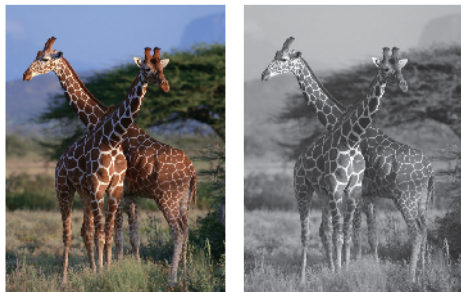
Greyscale mode makes the print processing speed faster than colour mode. If your document contains colour, selecting Greyscale mode prints your document in 256 levels of greyscale.



1. Start Brother iPrint&Scan.
 - Windows
Launch  (Brother iPrint&Scan).
 - Mac
In the **Finder** menu bar, click **Go > Applications**, and then double-click the iPrint&Scan icon.
The Brother iPrint&Scan screen appears.
2. If your Brother machine is not selected, click the **Select your Machine** button, and then select your model name from the list. Click **OK**.
3. Click **Print**.
4. Do one of the following:
 - Windows
Click **Photo** or **Document**.
 - Mac
Click **Photo** or **PDF**.
5. Select the file you want to print, and then do one of the following:
 - Windows
Click **Next**.
 - Mac
Click **Open**.



When printing documents with many pages, you can also select the pages you want to print.

6. Click the **Colour / Mono** drop-down list, and then select the **Mono** option.
7. Change other printer settings, if needed.
8. Click **Print**.



Related Information

- [Print Using Brother iPrint&Scan \(Windows/Mac\)](#)

Print an Email Attachment

You can print files by emailing them to your Brother machine.

- You can attach up to 10 documents, 20 MB in total, to an email.
- This feature supports the following formats:
 - Document files: PDF, TXT, and Microsoft Office files
 - Image files: JPEG, BMP, GIF, PNG, and TIFF
- The machine prints both the email content and attachments by default. To print only email attachments, change the settings as necessary.

>> [DCP-J1050DW/MFC-J1010DW](#)

>> [DCP-J1140DW](#)

DCP-J1050DW/MFC-J1010DW

1. Press **WEB**.



- If information regarding the Internet connection appears on the machine's LCD, read it, and then press **▶**.
- Occasionally, updates or announcements about Brother Web Connect's features will appear on the LCD. Read the information, and then press **OK**.

2. Press **▲** or **▼** to display the [Online Functions] option, and then press **OK**.



- If this function is locked, contact your Network Administrator for access.
- If information regarding [Online Functions] appears, read it, and then press **OK**.

3. Press **▲** or **▼** to display the [Enable] option, and then press **OK**.

Follow the on-screen instructions. Online Functions are enabled.

4. Press **▲** or **▼** to display the [Email Print] option, and then press **▶**.



If information regarding [Email Print] appears, read it, and then press **▶**.

5. Press **▲** or **▼** to display the [Enable] option, and then press **OK**.

Follow the on-screen instructions. The machine prints the Instruction Sheet.

6. Send your email to the email address included on the sheet. The machine prints the email attachments.



To change settings, including email address and printer settings, access Web Based Management, click **Online Functions > Online Functions Settings** in the left navigation bar, and then click the **Online Functions Settings Page** link.

DCP-J1140DW

1. Press **◀** or **▶** to display [Apps].

Press [Apps].



- If information regarding the Internet connection appears on the machine's LCD, read it, and then press [OK].
- Occasionally, updates or announcements about Brother Web Connect's features will appear on the LCD. Read the information, and then press [OK].

2. Press **▲** or **▼** to display the [Online Functions] option, and then press it.



- If this function is locked, contact your Network Administrator for access.
- If information regarding [Online Functions] appears, read it, and then press [OK].

3. Press ▲ or ▼ to display the [Enable] option, and then press it.

Follow the on-screen instructions. Online Functions are enabled.

4. Press ▲ or ▼ to display the [Email Print] option, and then press it.



If information regarding [Email Print] appears, read it, and then press [OK].

5. Press ▲ or ▼ to display the [Enable] option, and then press it.

Follow the on-screen instructions. The machine prints the Instruction Sheet.

6. Send your email to the email address included on the sheet. The machine prints the email attachments.



To change settings, including email address and printer settings, access Web Based Management, click **Online Functions > Online Functions Settings** in the left navigation bar, and then click the **Online Functions Settings Page** link.



Related Information

- [Print](#)

Related Topics:

- [Access Web Based Management](#)
-

Scan

- [Scan Using the Scan Button on Your Machine](#)
- [Scan Using Brother iPrint&Scan \(Windows/Mac\)](#)
- [Scan from Your Computer \(Windows\)](#)
- [Scan from Your Computer \(Mac\)](#)

Scan Using the Scan Button on Your Machine

- [Scan Photos and Graphics](#)
- [Save Scanned Data to a Folder as a PDF File](#)
- [Scan to an Editable Text File Using OCR](#)
- [Save Scanned Data as an Email Attachment](#)
- [Web Services for Scanning on Your Network \(Windows 7, Windows 8.1, and Windows 10\)](#)
- [Change Scan Settings Using Brother iPrint&Scan](#)

Scan Photos and Graphics

Send scanned photos or graphics directly to your computer.

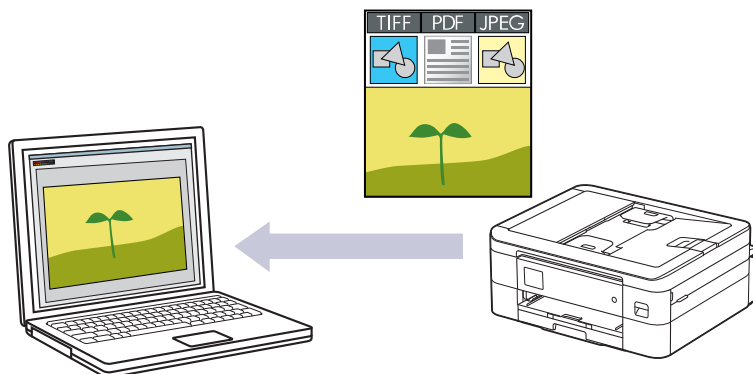

Use the Scan button on the machine to make temporary changes to the scan settings. To make permanent changes, use Brother iPrint&Scan.

>> [DCP-J1050DW/MFC-J1010DW](#)
>> [DCP-J1140DW](#)

DCP-J1050DW/MFC-J1010DW

1. Load your document.
2. Press  (**SCAN**).
3. Press **▲** or **▼** to select the [to PC] option, and then press **OK**.
4. Press **▲** or **▼** to select the [to Image] option, and then press **OK**.
5. If the machine is connected over the network, press **▲** or **▼** to select the computer where you want to send data, and then press **OK**.

 If the LCD message prompts you to enter a PIN, use the control panel to enter the four-digit PIN for the computer, and then press **OK**.

6. Do one of the following:
 - To change the settings, go to the next step.
 - To use the default settings, press **Mono Start** or **Colour Start**.

 [Colour Setting] depends on the default settings. Pressing **Mono Start** or **Colour Start** does not allow you to change the settings.

7. Press **▲** or **▼** to select the [Scan Settings] option, and then press **OK**.

 To use the [Scan Settings] option, you must connect a computer with Brother iPrint&Scan installed to the machine.

8. Press **▲** or **▼** to select the [Set at Device] option, and then press **OK**.
9. Select the scan settings you want to change, and then press **OK**.

Option	Description
Colour Setting	Select the scan colour format of your document.
Resolution	Select the scan resolution for your document.
File Type	Select the file format for your document.

Option	Description
Document Size	Select your document size.
Brightness	Select the brightness level.
Contrast	Select the contrast level.
Auto Deskew	Correct any skewed documents when they are scanned.
Skip Blank Page (MFC-J1010DW)	When On is selected, blank pages are skipped.
Remove Background	Change the amount of background colour that is removed.

10. Press **Mono Start** or **Colour Start**.



[Colour Setting] depends on the settings you have selected. Pressing **Mono Start** or **Colour Start** does not allow you to change the settings.

DCP-J1140DW

1. Load your document.
2. Press [Scan] > [to PC] > [to Image].
3. If the machine is connected over the network, press ▲ or ▼ to display the computer where you want to send data, and then select the computer name.



If the LCD message prompts you to enter a PIN, use the LCD to enter the four-digit PIN for the computer, and then press [OK].

4. Do one of the following:

- To change the settings, press  [Options].
- Press [Start] to start scanning without changing additional settings.

The machine starts scanning. If using the machine's scanner glass, follow the LCD instructions to complete the scanning job.



To use  [Options], you must connect a computer with Brother iPrint&Scan installed to the machine.

5. Press [Scan Settings] > [Set at Device].
6. Select the scan settings you want to change, and then press [OK].

Option	Description
Colour Setting	Select the colour format for your document.
Resolution	Select the scan resolution for your document.
File Type	Select the file format for your document.
Document Size	Select your document size.
Brightness	Select the brightness level.
Contrast	Select the contrast level.
Auto Deskew	Correct any skewed documents when they are scanned.
Remove Background Colour	Change the amount of background colour that is removed.



- To save the settings as a shortcut, press [Save as Shortcut]. You will be asked if you want to make this a One Touch Shortcut. Follow the LCD instructions.
-

7. Press [Start].

The machine starts scanning. If using the machine's scanner glass, follow the LCD instructions to complete the scanning job.



Related Information

- [Scan Using the Scan Button on Your Machine](#)
-

Save Scanned Data to a Folder as a PDF File

Scan documents and save them to a folder on your computer as PDF files.

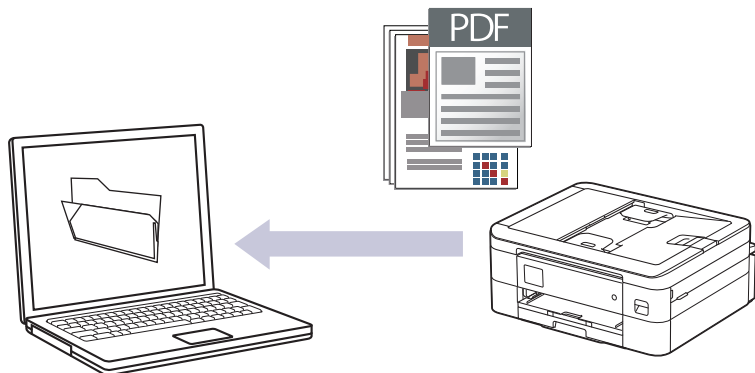



Use the Scan button on the machine to make temporary changes to the scan settings. To make permanent changes, use Brother iPrint&Scan.

>> [DCP-J1050DW/MFC-J1010DW](#)

>> [DCP-J1140DW](#)

DCP-J1050DW/MFC-J1010DW

1. Load your document.
2. Press  (**SCAN**).
3. Press **▲** or **▼** to select the [to PC] option, and then press **OK**.
4. Press **▲** or **▼** to select the [to File] option, and then press **OK**.
5. If the machine is connected over the network, press **▲** or **▼** to select the computer where you want to send data, and then press **OK**.

 If the LCD message prompts you to enter a PIN, use the control panel to enter the four-digit PIN for the computer, and then press **OK**.

6. Do one of the following:
 - To change the settings, go to the next step.
 - To use the default settings, press **Mono Start** or **Colour Start**.

 [Colour Setting] depends on the default settings. Pressing **Mono Start** or **Colour Start** does not allow you to change the settings.

7. Press **▲** or **▼** to select the [Scan Settings] option, and then press **OK**.

 To use the [Scan Settings] option, you must connect a computer with Brother iPrint&Scan installed to the machine.

8. Press **▲** or **▼** to select the [Set at Device] option, and then press **OK**.
9. Select the scan settings you want to change, and then press **OK**.

Option	Description
Colour Setting	Select the scan colour format of your document.
Resolution	Select the scan resolution for your document.

Option	Description
File Type	Select the file format for your document.
Document Size	Select your document size.
Brightness	Select the brightness level.
Contrast	Select the contrast level.
Auto Deskew	Correct any skewed documents when they are scanned.
Skip Blank Page (MFC-J1010DW)	When On is selected, blank pages are skipped.
Remove Background	Change the amount of background colour that is removed.

10. Press **Mono Start** or **Colour Start**.



[Colour Setting] depends on the settings you have selected. Pressing **Mono Start** or **Colour Start** does not allow you to change the settings.

DCP-J1140DW

1. Load your document.
2. Press [Scan] > [to PC] > [to File].
3. If the machine is connected over the network, press ▲ or ▼ to display the computer where you want to send data, and then select the computer name.



If the LCD message prompts you to enter a PIN, use the LCD to enter the four-digit PIN for the computer, and then press [OK].

4. Do one of the following:
 - To change the settings, press  [Options].
 - Press [Start] to start scanning without changing additional settings.

The machine starts scanning. If using the machine's scanner glass, follow the LCD instructions to complete the scanning job.



To use  [Options], you must connect a computer with Brother iPrint&Scan installed to the machine.

5. Press [Scan Settings] > [Set at Device].
6. Select the scan settings you want to change, and then press [OK].

Option	Description
Colour Setting	Select the colour format for your document.
Resolution	Select the scan resolution for your document.
File Type	Select the file format for your document.
Document Size	Select your document size.
Brightness	Select the brightness level.
Contrast	Select the contrast level.
Auto Deskew	Correct any skewed documents when they are scanned.

Option**Description**

Remove Background Colour Change the amount of background colour that is removed.



- To save the settings as a shortcut, press [Save as Shortcut]. You will be asked if you want to make this a One Touch Shortcut. Follow the LCD instructions.
-

7. Press [Start].

The machine starts scanning. If using the machine's scanner glass, follow the LCD instructions to complete the scanning job.

**Related Information**

- [Scan Using the Scan Button on Your Machine](#)
-

Scan to an Editable Text File Using OCR

Related Models: DCP-J1140DW/MFC-J1010DW

Your machine can convert characters in a scanned document to text using optical character recognition (OCR) technology. You can edit this text using your preferred text-editing application.

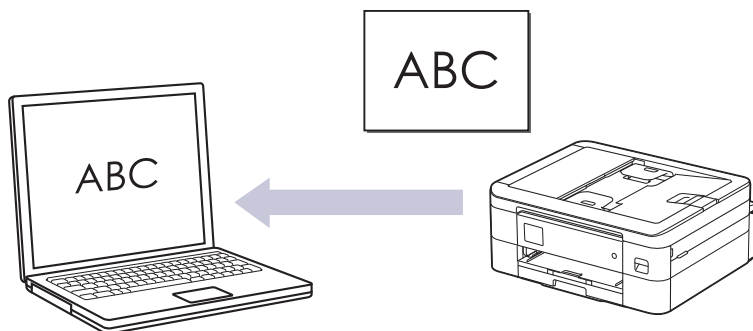

- The Scan to OCR feature is available for certain languages.
- Use the Scan button on the machine to make temporary changes to the scan settings. To make permanent changes, use Brother iPrint&Scan.

>> [MFC-J1010DW](#)

>> [DCP-J1140DW](#)

MFC-J1010DW

1. Load your document.
2. Press  (**SCAN**).
3. Press ▲ or ▼ to select the [to PC] option, and then press **OK**.
4. Press ▲ or ▼ to select the [to OCR] option, and then press **OK**.
5. If the machine is connected over the network, press ▲ or ▼ to select the computer where you want to send data, and then press **OK**.



If the LCD message prompts you to enter a PIN, use the control panel to enter the four-digit PIN for the computer, and then press **OK**.

6. Do one of the following:
 - To change the settings, go to the next step.
 - To use the default settings, press **Mono Start** or **Colour Start**.



[Colour Setting] depends on the default settings. Pressing **Mono Start** or **Colour Start** does not allow you to change the settings.

7. Press ▲ or ▼ to select the [Scan Settings] option, and then press **OK**.



To use the [Scan Settings] option, you must connect a computer with Brother iPrint&Scan installed to the machine.

8. Press ▲ or ▼ to select the [Set at Device] option, and then press **OK**.
9. Select the scan settings you want to change, and then press **OK**.

Option	Description
Colour Setting	Select the scan colour format of your document.
Resolution	Select the scan resolution for your document.
File Type	Select the file format for your document.
Document Size	Select your document size.
Brightness	Select the brightness level.
Contrast	Select the contrast level.
Auto Deskew	Correct any skewed documents when they are scanned.
Skip Blank Page	When On is selected, blank pages are skipped.
Remove Background	Change the amount of background colour that is removed.

10. Press **Mono Start** or **Colour Start**.



[Colour Setting] depends on the settings you have selected. Pressing **Mono Start** or **Colour Start** does not allow you to change the settings.

DCP-J1140DW

1. Load your document.
2. Press [Scan] > [to PC] > [to OCR].
3. If the machine is connected over the network, press ▲ or ▼ to display the computer where you want to send data, and then select the computer name.



If the LCD message prompts you to enter a PIN, use the LCD to enter the four-digit PIN for the computer, and then press [OK].

4. Do one of the following:
 - To change the settings, press  [Options].
 - Press [Start] to start scanning without changing additional settings.
The machine starts scanning. If using the machine's scanner glass, follow the LCD instructions to complete the scanning job.



To use  [Options], you must connect a computer with Brother iPrint&Scan installed to the machine.

5. Press [Scan Settings] > [Set at Device].
6. Select the scan settings you want to change, and then press [OK].

Option	Description
Colour Setting	Select the colour format for your document.
Resolution	Select the scan resolution for your document.
File Type	Select the file format for your document.
Document Size	Select your document size.
Brightness	Select the brightness level.
Contrast	Select the contrast level.

Option	Description
Auto Deskew	Correct any skewed documents when they are scanned.
Remove Background Colour	Change the amount of background colour that is removed.



- To save the settings as a shortcut, press [Save as Shortcut]. You will be asked if you want to make this a One Touch Shortcut. Follow the LCD instructions.
-

7. Press [Start].

The machine starts scanning. If using the machine's scanner glass, follow the LCD instructions to complete the scanning job.



Related Information

- [Scan Using the Scan Button on Your Machine](#)
-

Save Scanned Data as an Email Attachment

Send the scanned data from your machine to your email application as an attachment.

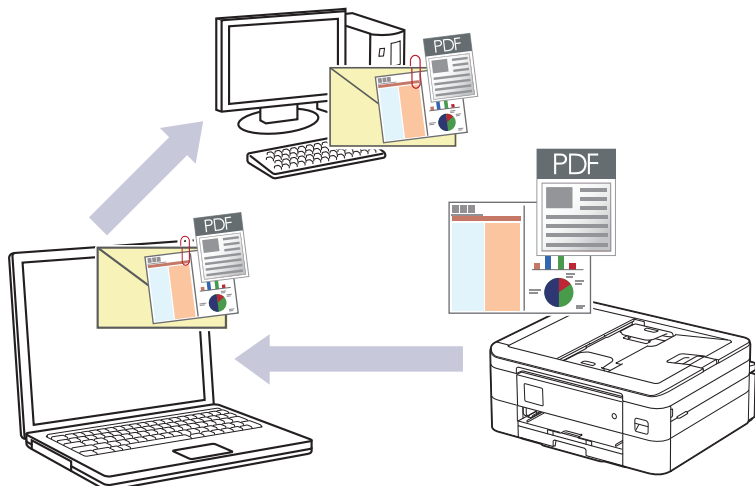

- Use the Scan button on the machine to make temporary changes to the scan settings. To make permanent changes, use Brother iPrint&Scan.
 - To scan to email using the machine's Scan Button, make sure you select one of these applications in Brother iPrint&Scan:
 - Windows: Microsoft Outlook
 - Mac: Apple Mail
- For other applications and Webmail services, use the Scan to Image or Scan to File feature to scan a document, and then attach the scanned file to an email message.

>> [DCP-J1050DW/MFC-J1010DW](#)

>> [DCP-J1140DW](#)

DCP-J1050DW/MFC-J1010DW

1. Load your document.
2. Press  (**SCAN**).
3. Press **▲** or **▼** to select the [to PC] option, and then press **OK**.
4. Press **▲** or **▼** to select the [to E-mail] option, and then press **OK**.
5. If the machine is connected over the network, press **▲** or **▼** to select the computer where you want to send data, and then press **OK**.



If the LCD message prompts you to enter a PIN, use the control panel to enter the four-digit PIN for the computer, and then press **OK**.

6. Do one of the following:
 - To change the settings, go to the next step.
 - To use the default settings, press **Mono Start** or **Colour Start**.



[Colour Setting] depends on the default settings. Pressing **Mono Start** or **Colour Start** does not allow you to change the settings.

7. Press **▲** or **▼** to select the [Scan Settings] option, and then press **OK**.



To use the [Scan Settings] option, you must connect a computer with Brother iPrint&Scan installed to the machine.

8. Press ▲ or ▼ to select the [Set at Device] option, and then press **OK**.
9. Select the scan settings you want to change, and then press **OK**.

Option	Description
Colour Setting	Select the scan colour format of your document.
Resolution	Select the scan resolution for your document.
File Type	Select the file format for your document.
Document Size	Select your document size.
Brightness	Select the brightness level.
Contrast	Select the contrast level.
Auto Deskew	Correct any skewed documents when they are scanned.
Skip Blank Page (MFC-J1010DW)	When On is selected, blank pages are skipped.
Remove Background	Change the amount of background colour that is removed.

10. Press **Mono Start** or **Colour Start**.



[Colour Setting] depends on the settings you have selected. Pressing **Mono Start** or **Colour Start** does not allow you to change the settings.

DCP-J1140DW

1. Load your document.
2. Press [Scan] > [to PC] > [to E-mail].
3. If the machine is connected over the network, press ▲ or ▼ to display the computer where you want to send data, and then select the computer name.



If the LCD message prompts you to enter a PIN, use the LCD to enter the four-digit PIN for the computer, and then press [OK].

4. Do one of the following:
 - To change the settings, press  [Options].
 - Press [Start] to start scanning without changing additional settings.
The machine scans the document and saves it as a file attachment. It then launches your email application and opens a new, blank email message with the scanned file attached.



To use  [Options], you must connect a computer with Brother iPrint&Scan installed to the machine.

5. Press [Scan Settings] > [Set at Device].
6. Select the scan settings you want to change, and then press [OK].

Option	Description
Colour Setting	Select the colour format for your document.
Resolution	Select the scan resolution for your document.

Option	Description
File Type	Select the file format for your document.
Document Size	Select your document size.
Brightness	Select the brightness level.
Contrast	Select the contrast level.
Auto Deskew	Correct any skewed documents when they are scanned.
Remove Background Colour	Change the amount of background colour that is removed.



- To save the settings as a shortcut, press [Save as Shortcut]. You will be asked if you want to make this a One Touch Shortcut. Follow the LCD instructions.

7. Press [Start].

The machine scans the document and saves it as a file attachment. It then launches your email application and opens a new, blank email message with the scanned file attached.



Related Information

- [Scan Using the Scan Button on Your Machine](#)
-

Web Services for Scanning on Your Network (Windows 7, Windows 8.1, and Windows 10)

The Web Services protocol enables Windows 7, Windows 8.1 and Windows 10 users to scan using a Brother machine on the network. You must install the driver via Web Services.

- [Use Web Services to Install Drivers Used for Scanning \(Windows 7, Windows 8.1, and Windows 10\)](#)
- [Scan Using Web Services from Your Machine \(Windows 7, Windows 8.1, and Windows 10\)](#)
- [Configure Scan Settings for Web Services](#)

Use Web Services to Install Drivers Used for Scanning (Windows 7, Windows 8.1, and Windows 10)

- Make sure you have installed the correct software and drivers for your machine.
- Verify that the host computer and the Brother machine are on the same subnet, or that the router is correctly configured to pass data between the two devices.
- You must configure the IP address on your Brother machine before you configure this setting.

1. Do one of the following:

- Windows 10

Click  > **Windows System** > **Control Panel**. In the **Hardware and Sound** group, click **Add a device**.

- Windows 8.1

Move your mouse to the lower right corner of your desktop. When the menu bar appears, click **Settings** > **Change PC settings** > **PC and devices** > **Devices** > **Add a device**.

The machine's Web Services Name appears.

- Windows 7

Click  (**Start**) > **Control Panel** > **Network and Internet** > **View network computers and devices**.

The machine's Web Services Name appears with the printer icon.

Right-click the machine you want to install.



- The Web Services Name for the Brother machine is your model name and the MAC Address (Ethernet Address) of your machine (for example, Brother XXX-XXXX (where XXX-XXXX is the name of your model) [XXXXXXXXXXXX] (MAC Address / Ethernet Address)).

- Windows 8.1/Windows 10

Move your mouse over the machine name to display the machine's information.

2. Do one of the following:

- Windows 8.1/Windows 10

Select the machine you want to install, and then follow the on-screen instructions.

- Windows 7

Click **Install** in the displayed menu.



To uninstall drivers, click **Uninstall** or  (**Remove device**).



Related Information

- [Web Services for Scanning on Your Network \(Windows 7, Windows 8.1, and Windows 10\)](#)

Scan Using Web Services from Your Machine (Windows 7, Windows 8.1, and Windows 10)

If you have installed the driver for scanning via Web Services, you can access the Web Services scanning menu on your Brother machine's LCD.

- Certain characters in the messages displayed on the LCD may be replaced with spaces if the language settings of your OS and your Brother machine are different.
- If the LCD displays an insufficient memory error message, choose a smaller size in the **Paper size** setting or a lower resolution in the **Resolution (DPI)** setting.

>> [DCP-J1050DW/MFC-J1010DW](#)

>> [DCP-J1140DW](#)

DCP-J1050DW/MFC-J1010DW

1. Load your document.
2. Press  (**SCAN**).
3. Press ▲ or ▼ to make your selections:
 - a. Select [WS Scan]. Press **OK**.
 - b. Select the type of scan you want. Press **OK**.
 - c. Select the computer where you want to send data. Press **OK**.
4. Press **Mono Start** or **Colour Start**.

The machine starts scanning.

DCP-J1140DW

1. Load your document.
2. Press [Scan] > [WS Scan].
3. Press ▲ or ▼ to select the type of scan you want, and then press it.
4. Press ▲ or ▼ to display the computer where you want to send data, and then select the computer name.
5. Press [Start].

The machine starts scanning.



Related Information

- [Web Services for Scanning on Your Network \(Windows 7, Windows 8.1, and Windows 10\)](#)

Configure Scan Settings for Web Services

1. Do one of the following:

- Windows 10

Click  > **Windows System** > **Control Panel**. In the **Hardware and Sound** group, click **View devices and printers**.

- Windows 8.1

Move your mouse to the lower right corner of your desktop. When the menu bar appears, click **Settings**, and then click **Control Panel**. In the **Hardware and Sound** group, click **View devices and printers**.

- Windows 7

Click  (**Start**) > **Devices and Printers**.

2. Right-click the machine icon, and then select **Scan profiles....** The **Scan Profiles** dialog box appears.

3. Select the scan profile you want to use.

4. Make sure the scanner selected in the **Scanner** list is a machine that supports Web Services for scanning, and then click the **Set as Default** button.

5. Click **Edit...**

The **Edit Default Profile** dialog box appears.

6. Select the **Source**, **Paper size**, **Colour format**, **File type**, **Resolution (DPI)**, **Brightness** and **Contrast** settings.

7. Click the **Save Profile** button.

These settings will be applied when you scan using the Web Services protocol.

If you are requested to select a scanning application, select Windows Fax and Scan from the list.



Related Information

- [Web Services for Scanning on Your Network \(Windows 7, Windows 8.1, and Windows 10\)](#)

Change Scan Settings Using Brother iPrint&Scan

Brother iPrint&Scan allows you to change the machine's Scan Button settings.

1. Start Brother iPrint&Scan.

- Windows

Launch  (Brother iPrint&Scan).

- Mac

In the **Finder** menu bar, click **Go > Applications**, and then double-click the iPrint&Scan icon.

The Brother iPrint&Scan screen appears.

2. If your Brother machine is not selected, click the **Select your Machine** button, and then select your model name from the list. Click **OK**.
3. Click the **Machine Scan Settings** button, and then follow the on-screen instructions to change the scan settings, such as document size, colour, and resolution.



Related Information

- [Scan Using the Scan Button on Your Machine](#)

Scan Using Brother iPrint&Scan (Windows/Mac)

1. Start Brother iPrint&Scan.

- Windows

Launch  (**Brother iPrint&Scan**).

- Mac

In the **Finder** menu bar, click **Go > Applications**, and then double-click the iPrint&Scan icon.

The Brother iPrint&Scan screen appears.

2. If your Brother machine is not selected, click the **Select your Machine** button, and then select your model name from the list. Click **OK**.
3. Click the **Scan** icon, and then follow the on-screen instructions to scan your documents.



Related Information

- [Scan](#)
-

Scan from Your Computer (Windows)

There are several ways you can use your computer to scan photos and documents on your machine. Use the software applications we provide or use your favourite scanning application.

- [Scan Using Nuance™ PaperPort™ 14SE or Other Windows Applications](#)
- [Scan Using Windows Fax and Scan](#)



Scan Using Nuance™ PaperPort™ 14SE or Other Windows Applications

You can use the Nuance™ PaperPort™ 14SE application for scanning.

- To download the Nuance™ PaperPort™ 14SE application, click  (**Brother Utilities**), select **Do More** in the left navigation bar, and then click **PaperPort**.
- Nuance™ PaperPort™ 14SE supports Windows 7, Windows 8.1, Windows 10 Home, Windows 10 Pro, Windows 10 Education and Windows 10 Enterprise.
- For detailed instructions on using each application, click the application's **Help** menu, and then click **Getting Started Guide** in the **Help** ribbon.



The instructions for scanning in these steps are for PaperPort™ 14SE. For other Windows applications, the steps will be similar. PaperPort™ 14SE supports both TWAIN and WIA drivers; the TWAIN driver (recommended) is used in these steps.

- Depending on the model of your machine, Nuance™ PaperPort™ 14SE may not be included. If it is not included, you can use other software applications that support scanning.
1. Load your document.
 2. Start PaperPort™ 14SE.
Do one of the following:
 - Windows 10
Click  > **Nuance PaperPort 14 > PaperPort**.
 - Windows 8.1
Click  (**PaperPort**).
 - Windows 7
Using your computer, click  (**Start**) > **All Programs > Nuance PaperPort 14 > PaperPort**.
 3. Click the **Desktop** menu, and then click **Scan Settings** in the **Desktop** ribbon.
The **Scan or Get Photo** panel appears on the left side of the screen.
 4. Click **Select**.
 5. From the available Scanners list, select **TWAIN: TW-Brother XXX-XXXX** or **TWAIN: TW-Brother XXX-XXXX LAN** (where XXX-XXXX is the name of your model).
 6. Select the **Display scanner dialog box** check box in the **Scan or Get Photo** panel.
 7. Click **Scan**.
The Scanner Setup dialog box appears.

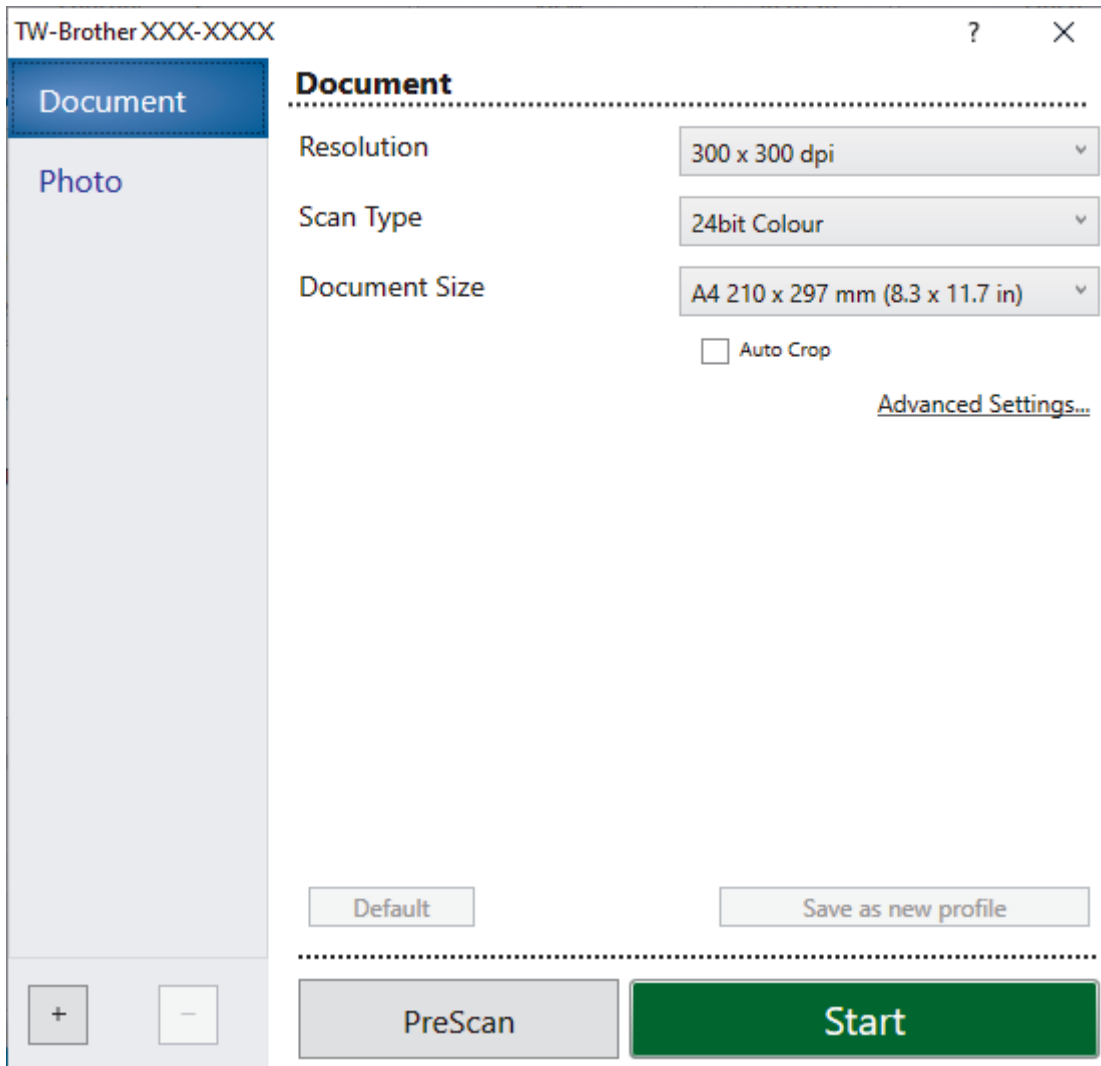

8. Adjust the settings in the Scanner Setup dialog box, if needed.
9. Click the **Document Size** drop-down list, and then select your document size.
10. Click **PreScan** to preview your image and crop unwanted portions before scanning.
11. Click **Start**.

The machine starts scanning.

✓ Related Information

- [Scan from Your Computer \(Windows\)](#)
- [TWAIN Driver Settings \(Windows\)](#)

TWAIN Driver Settings (Windows)

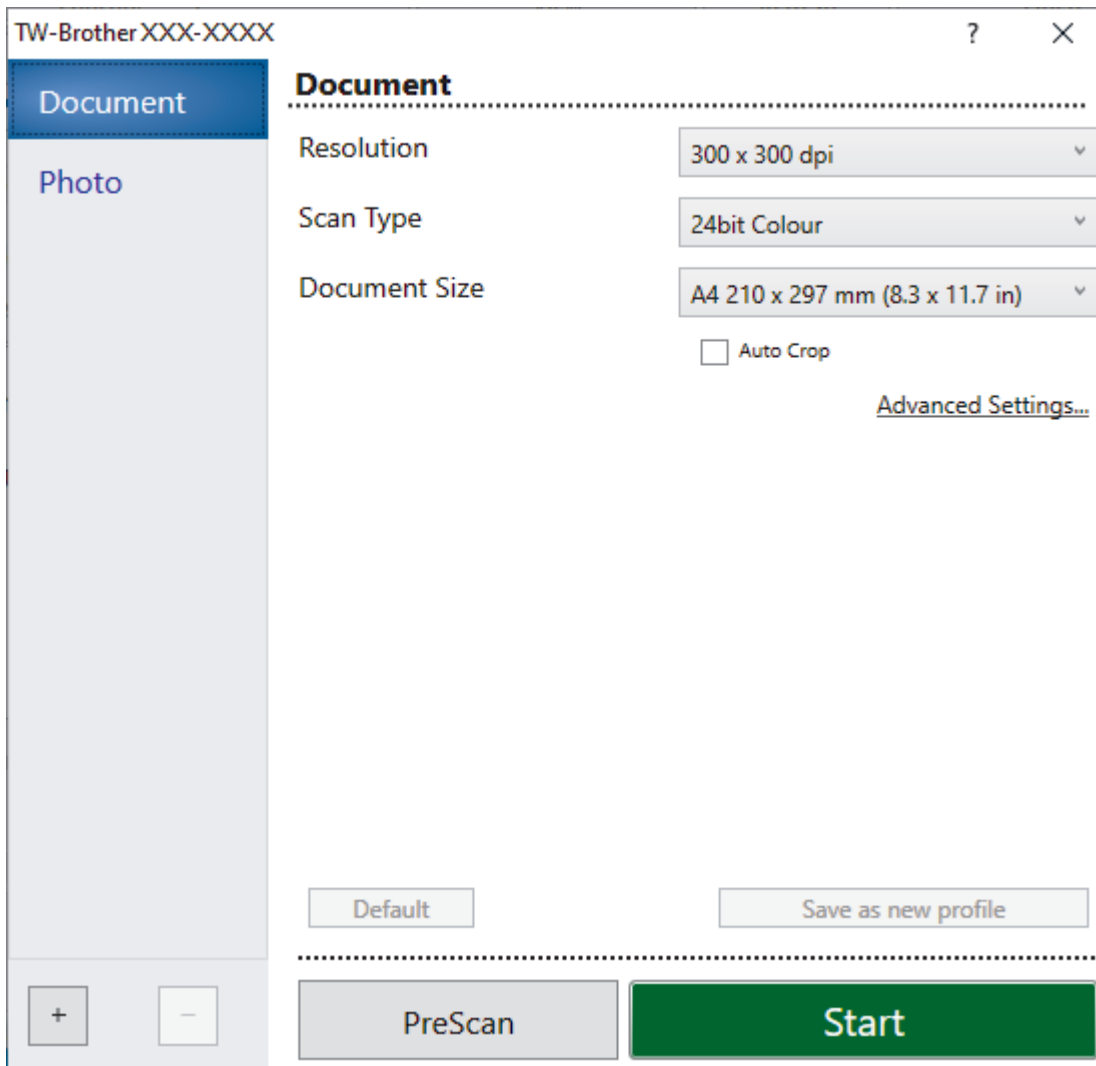

 Note that the item names and assignable values will vary depending on the machine.

1. Scan

Select the **Photo** or **Document** option depending on the type of document you want to scan.

Scan (Image Type)		Resolution	Scan Type
Photo	Use for scanning photo images.	300 x 300 dpi	24bit Colour
Document	Use for scanning text documents.	300 x 300 dpi	24bit Colour

2. Resolution

Select a scanning resolution from the **Resolution** drop-down list. Higher resolutions take more memory and transfer time, but produce a finer scanned image.

3. Scan Type

Select from a range of scan colour depths.

- **Black & White**

Use for text or line art images.

- **Grey (Error Diffusion)**

Use for photographic images or graphics. (Error Diffusion is a method for creating simulated grey images without using true grey dots. Black dots are put in a specific pattern to give a grey appearance.)

- **True Grey**

Use for photographic images or graphics. This mode is more accurate because it uses up to 256 shades of grey.

- **24bit Colour**

Use to create an image with the most accurate colour reproduction. This mode uses up to 16.8 million colours to scan the image, but it requires the most memory and has the longest transfer time.

4. Document Size

Select the exact size of your document from a selection of preset scan sizes.

If you select **Custom**, the **Custom Document Size** dialog box appears and you can specify the document size.

5. Auto Crop

Scan multiple documents placed on the scanner glass. The machine will scan each document and create separate files or a single multi-page file.

6. Advanced Settings

Configure advanced settings by clicking the **Advanced Settings** link in the Scanner Setup dialog box.

- **Document Correction**

- **Auto Deskew**

Set the machine to correct document skewing automatically as the pages are scanned from the scanner glass.

- **Margin Settings**

Adjust your document's margins.

- **Rotate Image**

Rotate the scanned image.

- **Edge Fill**

Fill in the edges on four sides of the scanned image using the selected colour and range.

- (MFC-J1010DW) **Skip Blank Page**

Remove the document's blank pages from the scanning results.

- **Image Quality**

- **Diffusion Adjustment -Grey**

Adjust the diffusion when selecting the **Grey (Error Diffusion)** option from the **Scan Type** drop-down list.

- **Colour Tone Adjustment**

Adjust the colour tone.

- **Background Processing**

- **Remove Bleed-through / Pattern**

Prevent bleed-through.

- **Remove Background Colour**

Remove the base colour of documents to make the scanned data more legible.

- **Colour Drop**

Select a colour to remove from the scanned image.

- **Edge Emphasis**

Sharpen the characters in the original.

- **Reduce Noise**

Improve and enhance the quality of your scanned images with this selection. The **Reduce Noise** option is available when selecting the **24bit Colour** option and the **300 x 300 dpi**, **400 x 400 dpi**, or **600 x 600 dpi** scan resolution.

- **B&W Image Quality**
 - **B&W Threshold Adjustment**
Adjust the threshold to generate a monochrome image.
 - **Character Correction**
Correct the broken or incomplete characters of the original to make them easier to read.
 - **B&W Inversion**
Invert black and white in the monochrome image.
- **Feed Control**
 - (MFC-J1010DW) **Layout**
Select the layout.
 - **Continuous Scan**
Select this option to scan multiple pages. After a page is scanned, select whether to continue scanning or finish.



Related Information

- [Scan Using Nuance™ PaperPort™ 14SE or Other Windows Applications](#)
-

Scan Using Windows Fax and Scan

Windows Fax and Scan application is another option that you can use for scanning.

- Windows Fax and Scan uses the WIA scanner driver.
- If you want to crop a portion of a page after pre-scanning the document, you must scan using the scanner glass (also called the flatbed).

1. Load your document.
2. Launch Windows Fax and Scan.
3. Click **File > New > Scan**.
4. Select the scanner you want to use.
5. Click **OK**.

The **New Scan** dialog box appears.

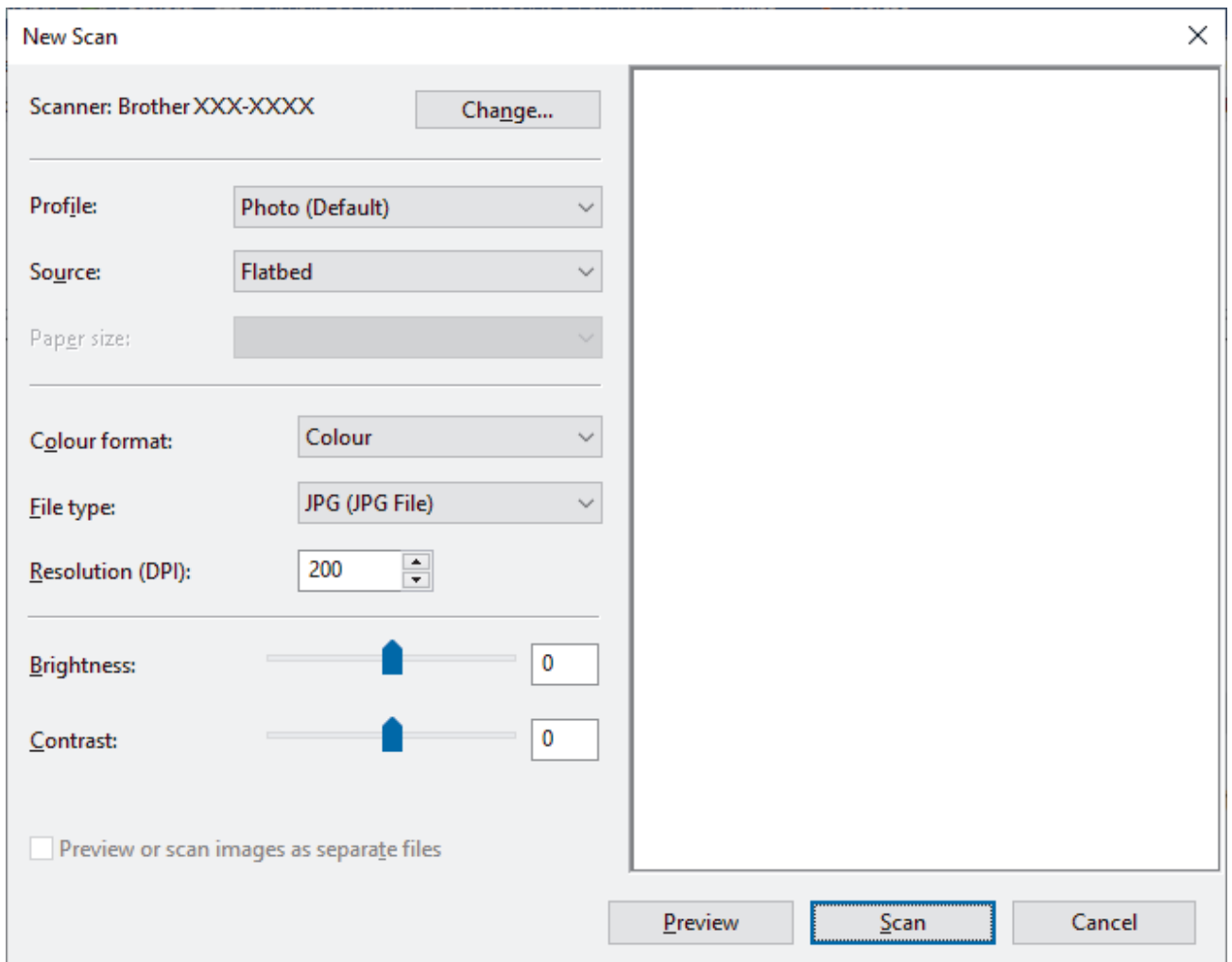

6. Adjust the settings in the dialog box, if needed.

The scanner resolution can be set to a maximum of 1200 dpi. If you want to scan at higher resolutions, use the **Scanner Utility** software from **Brother Utilities**.

7. Click **Scan**.

The machine starts scanning the document.

✓ Related Information

- [Scan from Your Computer \(Windows\)](#)

-
- WIA Driver Settings (Windows)
-

WIA Driver Settings (Windows)

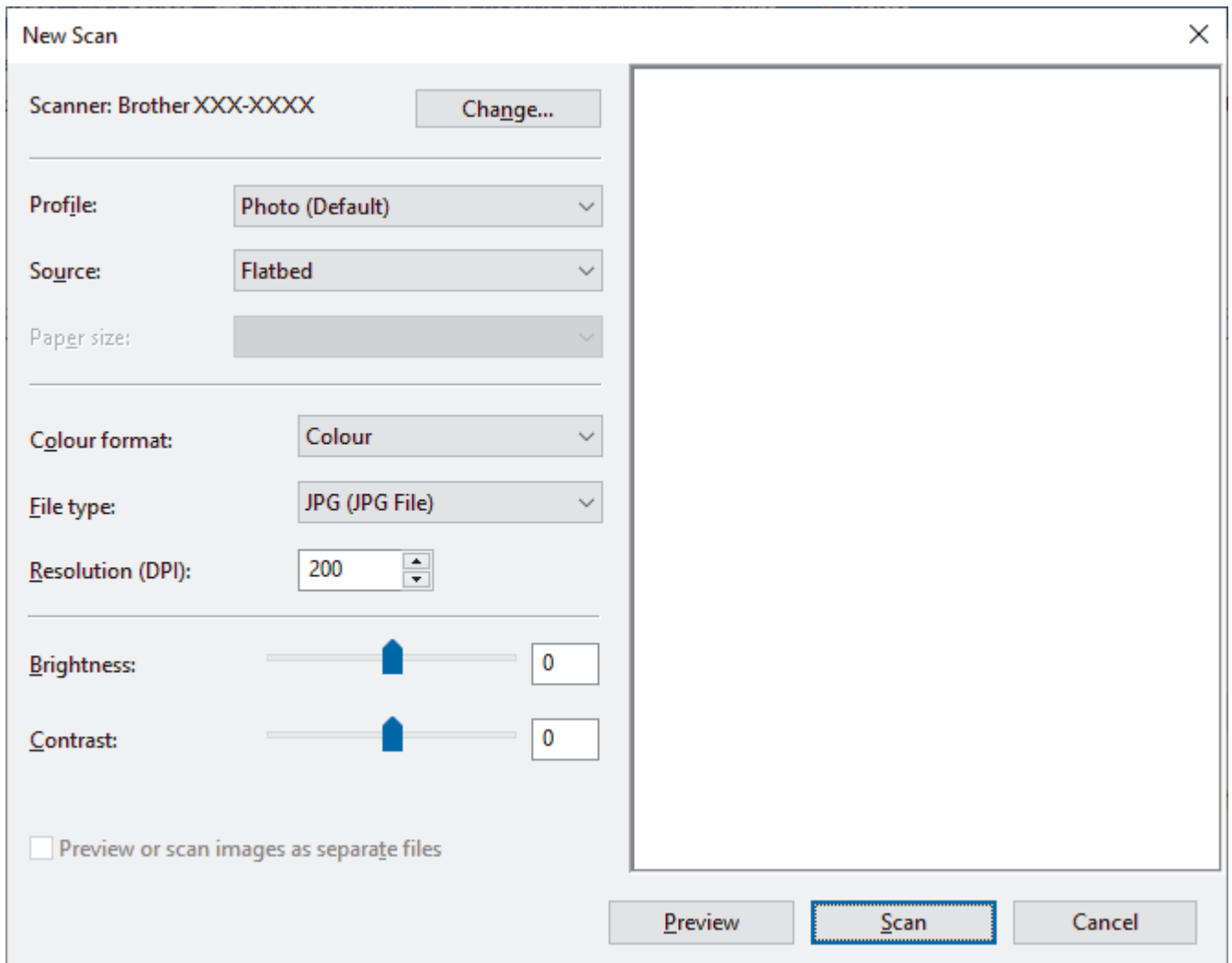

Profile

Select the scan profile you want to use from the **Profile** drop-down list.

Source

Select the **Flatbed** or **Feeder (Scan one side)** option from the drop-down list.

Paper size

The **Paper size** option is available if you select the **Feeder (Scan one side)** as the **Source** option.

Colour format

Select a scan colour format from the **Colour format** drop-down list.

File type

Select a file format from the **File type** drop-down list.

Resolution (DPI)

Set a scanning resolution in the **Resolution (DPI)** field. Higher resolutions take more memory and transfer time, but produce a finer scanned image.

Brightness

Set the **Brightness** level by dragging the slider to the right or left to lighten or darken the image. If the scanned image is too light, set a lower brightness level and scan the document again. If the image is too dark,

set a higher brightness level and scan the document again. You can also type a value in the field to set the brightness level.

Contrast

Increase or decrease the **Contrast** level by moving the slider to the right or left. An increase emphasises dark and light areas of the image, while a decrease reveals more details in grey areas. You can also type a value in the field to set the contrast level.



Related Information

- [Scan Using Windows Fax and Scan](#)

Home > [Scan](#) > Scan from Your Computer (Mac)

Scan from Your Computer (Mac)

- [Scan Using AirPrint \(macOS\)](#)

Copy

- [Copy a Document](#)
- [Enlarge or Reduce Copied Images](#)
- [Sort Copies](#)
- [Make Page Layout Copies \(N in 1 or Poster\)](#)
- [Copy on Both Sides of the Paper \(2-sided Copy\)](#)
- [Copy an ID Card](#)
- [Copy Settings](#)

Copy a Document

>> DCP-J1050DW/MFC-J1010DW
>> DCP-J1140DW

DCP-J1050DW/MFC-J1010DW

1. Make sure you have loaded the correct size paper in the paper tray.
2. Load your document.
3. (MFC-J1010DW) Press  (**COPY**).

The LCD displays:

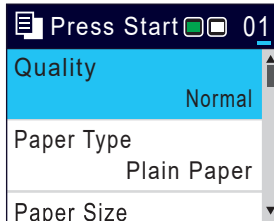

4. (MFC-J1010DW) Enter the number of copies using the dial pad.
5. (DCP-J1050DW) Press - or + on the control panel.
6. Change the copy settings, if needed.
Press ▲ or ▼ to scroll through the copy settings. Select a copy setting, and then press **OK**.



- When you load paper other than A4 size plain paper, you must change the [Paper Size] and [Paper Type] settings.

7. When finished, press **Mono Start** or **Colour Start**.



To interrupt copying, press **Stop/Exit**.

DCP-J1140DW

1. Make sure you have loaded the correct size paper in the paper tray.
2. Load your document.
3. Press  [Copy].



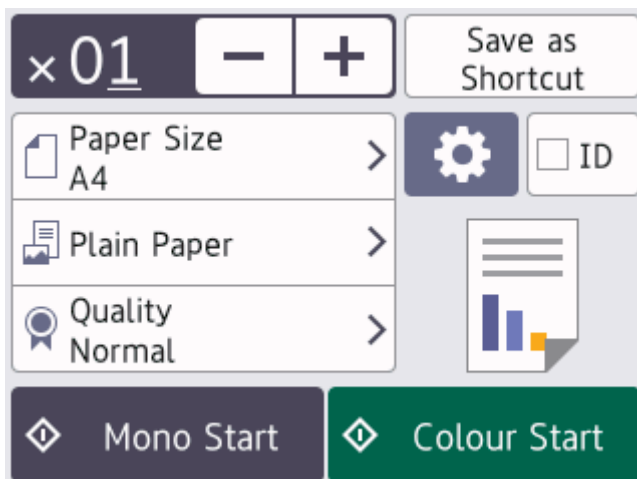



The touchscreen displays:



4. Change the copy settings, if needed.



When you load paper other than A4 size plain paper, you must change the [Paper Size] and [Paper Type] settings by pressing  [Options].

Option	Description
 (No. of Copies)	Enter the number of copies in one of the following ways: <ul style="list-style-type: none"> • Press - or + on the touchscreen. • Press  to display the keyboard on the touchscreen, and then enter the number of copies using the touchscreen keyboard. Press OK.
 (Options)	Press  [Options] to change the copy settings for the next copy only. When you have finished changing settings, press OK.
ID	To make an ID card copy with the [2in1 ID Vertical] layout, select the [ID] checkbox.
Current setting indications	Press the following icons to change these settings for the next copy only: <ul style="list-style-type: none"> •  Paper Size •  Paper Type •  Quality



After you have finished selecting new options, you can save them by pressing [Save as Shortcut].

5. Press [Mono Start] or [Colour Start].



To interrupt copying, press .



Related Information

- [Copy](#)

Related Topics:

- [Load Documents in the Automatic Document Feeder \(ADF\)](#)
- [Load Documents on the Scanner Glass](#)
- [Copy Settings](#)

Enlarge or Reduce Copied Images

Select an enlargement or reduction ratio to resize your copied data.

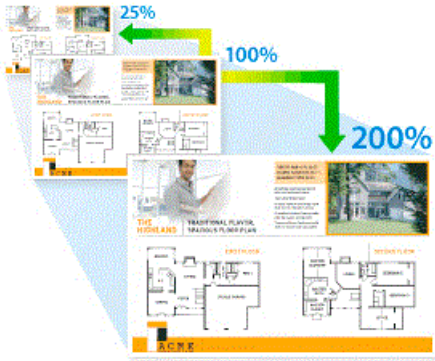

>> [DCP-J1050DW/MFC-J1010DW](#)

>> [DCP-J1140DW](#)

DCP-J1050DW/MFC-J1010DW



1. Load your document.
2. (MFC-J1010DW) Press  (COPY).
3. (MFC-J1010DW) Enter the number of copies using the dial pad.
4. (DCP-J1050DW) Press - or + on the control panel.
5. Press ▲ or ▼ to select [Enlarge/Reduce]. Press **OK**.
6. Press ▲ or ▼ to select the available options. Press **OK**.
7. Do one of the following:
 - If you selected the [Enlarge] or [Reduce] option, press ▲ or ▼ to select the enlargement or reduction ratio you want to use. Press **OK**.
 - If you selected the [Custom (25-400%)] option, enter an enlargement or reduction ratio from [25%] to [400%]. Press **OK**.
 - If you selected [100%] or the [Fit to Page] option, go to the next step.
8. When finished, press **Mono Start** or **Colour Start**.





If you selected the [Fit to Page] option, your machine adjusts the copy size to fit the paper size set in the machine.

- The [Fit to Page] option does not work correctly when the document on the scanner glass is skewed more than three degrees. Using the document guidelines on the left and top, place the document face down in the upper-left corner of the scanner glass.
- The [Fit to Page] option is not available for Legal size documents.

DCP-J1140DW

1. Load your document.
2. Press  [Copy].
3. Enter the number of copies in one of the following ways:
 - Press [-] or [+] on the touchscreen.
 - Press  to display the keyboard on the touchscreen, and then enter the number of copies using the touchscreen keyboard. Press [OK].

-
4. Press  [Options] > [Enlarge/Reduce].
 5. Press ▲ or ▼ to display the available options, and then press the option you want to change.
 6. Do one of the following:
 - If you selected the [Enlarge] or [Reduce] option, press the enlargement or reduction ratio you want to use.
 - If you selected the [Custom(25-400%)] option, press  (backspace) to erase the displayed percentage, or press ◀ to move the cursor, and then enter an enlargement or reduction ratio from [25%] to [400%].
Press [OK].
 - If you selected [100%] or the [Fit to Page] option, go to the next step.
 7. Read and confirm the displayed list of options you have selected, and then press [OK].
 8. When you have finished changing settings, press [Mono Start] or [Colour Start].



If you selected the [Fit to Page] option, your machine adjusts the copy size to fit the paper size set in the machine.

- The [Fit to Page] option does not work correctly when the document on the scanner glass is skewed more than three degrees. Using the document guidelines on the left and top, place the document face down in the upper-left corner of the scanner glass.
 - The [Fit to Page] option is not available for Legal size documents.
-



Related Information

- [Copy](#)
-

Sort Copies

Sort multiple copies. Pages will be stacked in the order they are fed, that is: 1, 2, 3, and so on.



>> [DCP-J1050DW/MFC-J1010DW](#)

>> [DCP-J1140DW](#)

DCP-J1050DW/MFC-J1010DW

1. Load your document.
2. (MFC-J1010DW) Press  (COPY).
3. (MFC-J1010DW) Enter the number of copies using the dial pad.
4. (DCP-J1050DW) Press - or + on the control panel.
5. Press ▲ or ▼ to select the following:
 - a. Select [Stack/Sort]. Press **OK**.
 - b. Select [Sort]. Press **OK**.
6. Press **Mono Start** or **Colour Start**. If you placed the document in the ADF (ADF models only), the machine scans the document and starts printing.
7. If you are using the scanner glass, repeat the following steps for each page of the document:
 - Place the next page on the scanner glass, and then press ► to scan the page.
 - After scanning all the pages, press ◀ to start printing.

DCP-J1140DW

1. Load your document.
2. Press  [Copy].
3. Enter the number of copies in one of the following ways:
 - Press [-] or [+] on the touchscreen.
 - Press  to display the keyboard on the touchscreen, and then enter the number of copies using the touchscreen keyboard. Press [OK].
4. Press  [Options] > [Stack/Sort] > [Sort].
5. Read and confirm the displayed list of settings you have selected, and then press [OK].
6. When you have finished changing settings, press [Mono Start] or [Colour Start].
7. If you are using the scanner glass, repeat the following steps for each page of the document:
 - Place the next page on the scanner glass, and then press [Continue] to scan the page.
 - After scanning all the pages, press [Finish].

✓ Related Information

- [Copy](#)

Make Page Layout Copies (N in 1 or Poster)

The N in 1 copy feature saves paper by copying two or four pages of your document onto one page of the copy. The poster feature divides your document into sections, then enlarges the sections so you can assemble them into a poster. To print a poster, use the scanner glass.





- Make sure the paper size is set to A4, or Letter.
- You can make only one Poster copy at a time.



>> [DCP-J1050DW/MFC-J1010DW](#)

>> [DCP-J1140DW](#)

DCP-J1050DW/MFC-J1010DW

1. Load your document.
2. (MFC-J1010DW) Press  (COPY).
3. (MFC-J1010DW) Enter the number of copies using the dial pad.
4. (DCP-J1050DW) Press - or + on the control panel.
5. Press ▲ or ▼ to select [Page Layout]. Press **OK**.
6. Press ▲ or ▼ to display the options, and then press **OK** to select the option you want.

Option	Description
Off (1in1)	-
2in1 (Portrait)	
2in1 (Landscape)	

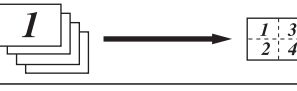
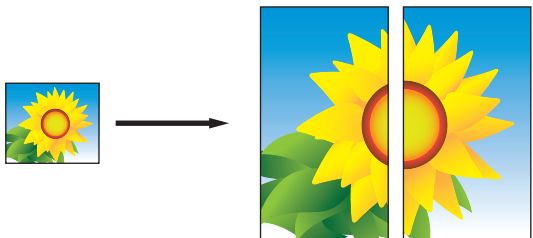
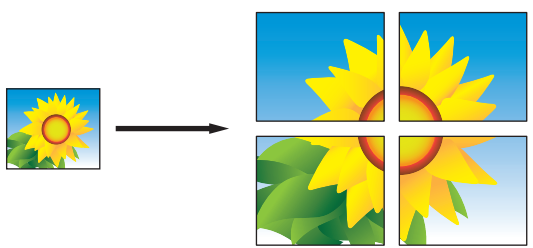
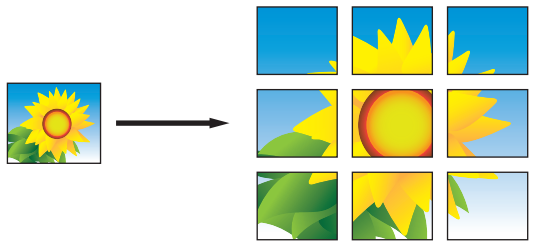





Option	Description
2in1 ID Vertical (Using the scanner glass)	
2in1 ID Horizontal (Using the scanner glass)	
4in1 (Portrait)	
4in1 (Landscape)	
Poster (2x1) (Using the scanner glass)	
Poster (2x2) (Using the scanner glass)	
Poster (3x3) (Using the scanner glass)	

7. Press **Mono Start** or **Colour Start**. If you placed the document in the ADF (ADF models only) or are making a poster, the machine scans the pages and starts printing.
8. If you are using the scanner glass, repeat the following steps for each page of the document:
 - Place the next page on the scanner glass, and then press ► to scan the page.
 - After scanning all the pages, press ◀ to start printing.

DCP-J1140DW

1. Load your document.
2. Press  [Copy].

3. Enter the number of copies in one of the following ways:
 - Press [-] or [+] on the touchscreen.
 - Press **x01** to display the keyboard on the touchscreen, and then enter the number of copies using the touchscreen keyboard. Press [OK].
4. Press  [Options] > [Page Layout].
5. Press ▲ or ▼ to display the options, and then press the option you want.

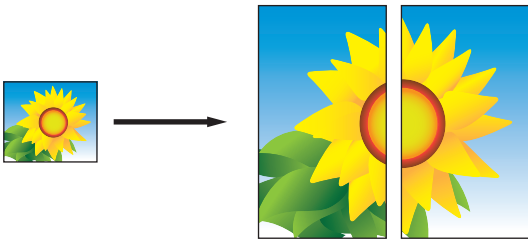
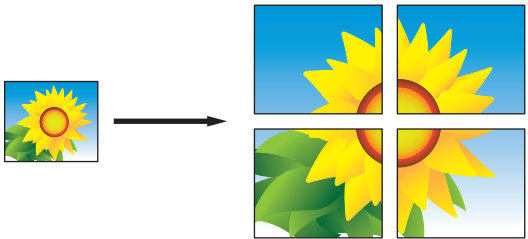
Option	Description
Off (1in1)	-
2in1 (Portrait)	
2in1 (Landscape)	
2in1 ID Vertical (Using the scanner glass)	
2in1 ID Horizontal (Using the scanner glass)	
4in1 (Portrait)	
4in1 (Landscape)	
Poster (2x1) (Using the scanner glass)	
Poster (2x2) (Using the scanner glass)	

Option**Description**

Poster (3x3)

(Using the scanner glass)

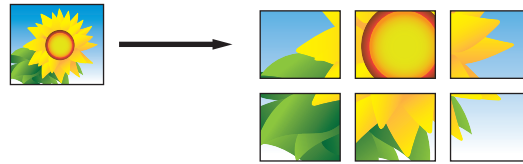

6. Read and confirm the displayed list of settings you have selected, and then press [OK].
7. When you have finished changing settings, press [Mono Start] or [Colour Start]. If you are making a poster, the machine scans the pages and starts printing.
8. If you are using the scanner glass, repeat the following steps for each page of the document:
 - Place the next page on the scanner glass, and then press [Continue] to scan the page.
 - After scanning all the pages, press [Finish].

**Related Information**

- [Copy](#)
-

Copy on Both Sides of the Paper (2-sided Copy)

Reduce the amount of paper you use by copying onto both sides of the paper.

- You must choose a 2-sided copy layout from the following options before you can start 2-sided copying.
- The layout of your original document determines which 2-sided copy layout you should choose.
- When you manually make 2-sided copies from a 2-sided document, use the scanner glass.
- You can use only A4, A5, or Letter size plain paper.

Portrait

1-sided to 2-sided (Long Edge Flip)

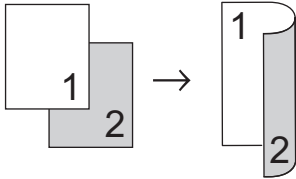

1-sided to 2-sided (Short Edge Flip)

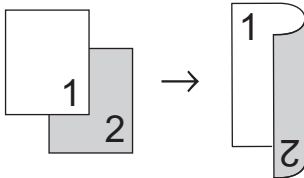

2-sided to 2-sided

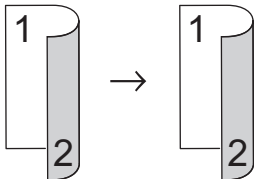

Landscape

1-sided to 2-sided (Long Edge Flip)

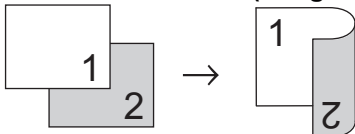

1-sided to 2-sided (Short Edge Flip)

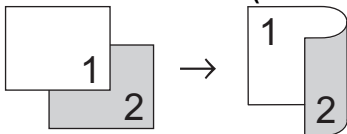

2-sided to 2-sided

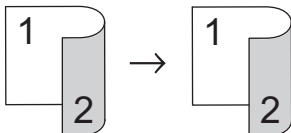

>> [DCP-J1050DW/MFC-J1010DW](#)

>> [DCP-J1140DW](#)

DCP-J1050DW/MFC-J1010DW

1. Load your document.
2. (MFC-J1010DW) Press  (COPY).
3. (MFC-J1010DW) Enter the number of copies using the dial pad.

4. (DCP-J1050DW) Press **-** or **+** on the control panel.
5. To sort multiple copies, press **▲** or **▼** to select the following:
 - a. Select [Stack/Sort]. Press **OK**.
 - b. Select [Sort]. Press **OK**.
6. Press **▲** or **▼** to select [2-sided Copy]. Press **OK**.
7. Do one of the following:
 - To make 2-sided copies from a 1-sided document, press **▲** or **▼** to select the following:
 - a. To change the layout options, select [Layout]. Press **OK**.
 - b. Select [Long Edge Flip] or [Short Edge Flip]. Press **OK**.
 - c. Select [1sided⇒2sided]. Press **OK**.
 - To make 2-sided copies of a 2-sided document manually, press **▲** or **▼** to select [2sided⇒2sided]. Press **OK**.



Use the scanner glass to make 2-sided copies of a 2-sided document manually.

8. Press **Mono Start** or **Colour Start**. If you placed the document in the ADF (ADF models only), the machine scans the pages and starts printing.
9. If you are using the scanner glass, repeat the following steps for each page of the document:
 - Place the next page on the scanner glass, and then press **▶** to scan the page.
 - After scanning all the pages, press **◀** to start printing.



DO NOT touch the printed page until it is ejected the second time. The machine will print the first side and eject the paper, and then pull the paper in to print the second side.



If you experience smudged printouts or paper jams, follow these steps:

1. Press **▲** (Ink) or **INK** on the control panel.
 2. Select [Print Options]. Press **OK**.
 3. Select [Reduce Smudging]. Press **OK**.
 4. Change settings. Press **OK**.
-

DCP-J1140DW

1. Load your document.
2. Press  [Copy].
3. Enter the number of copies in one of the following ways:
 - Press **-** or **+** on the touchscreen.
 - Press **x01** to display the keyboard on the touchscreen, and then enter the number of copies using the touchscreen keyboard. Press [OK].
4. To sort multiple copies, press  [Options] > [Stack/Sort] > [Sort].
5. Press **▲** or **▼** to display the [2-sided Copy] option, and then press it.
6. Do one of the following:
 - To make 2-sided copies from a 1-sided document, follow these steps:
 - a. To change the layout options, press [Layout], and then press [Long Edge Flip] or [Short Edge Flip].
 - b. Press [1-sided⇒2-sided].
 - To make 2-sided copies of a 2-sided document manually, press [2-sided⇒2-sided].



Use the scanner glass to make 2-sided copies of a 2-sided document manually.

-
7. Review your settings on the touchscreen, and then press [OK].
 8. Press [Mono Start] or [Colour Start].
 9. If you are using the scanner glass, repeat the following steps for each page of the document:
 - Place the next page on the scanner glass, and then press [Continue] to scan the page.
 - After scanning all the pages, press [Finish].

DO NOT touch the printed page until it is ejected the second time. The machine will print the first side and eject the paper, and then pull the paper in to print the second side.



If you experience smudged printouts or paper jams, press  [Ink] > [Print Options] > [Reduce Smudging], and then change settings.



Related Information

- [Copy](#)

Related Topics:

- [Change the Print Options to Improve Your Print Results](#)
-

Copy an ID Card

Use the [2in1 (ID)] feature to copy both sides of an identification card onto one page, keeping the original card size.



- Make sure the paper size is set to A4 or Letter.
- You may copy an identification card to the extent permitted under applicable laws. For more detailed information, see the *Product Safety Guide*.

>> [DCP-J1050DW/MFC-J1010DW](#)

>> [DCP-J1140DW](#)

DCP-J1050DW/MFC-J1010DW

1. Place your identification card face down near the upper-left corner of the scanner glass.

2 in 1 ID (Vertical)

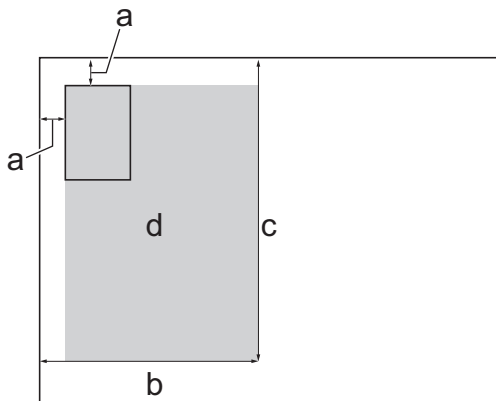

2 in 1 ID (Horizontal)

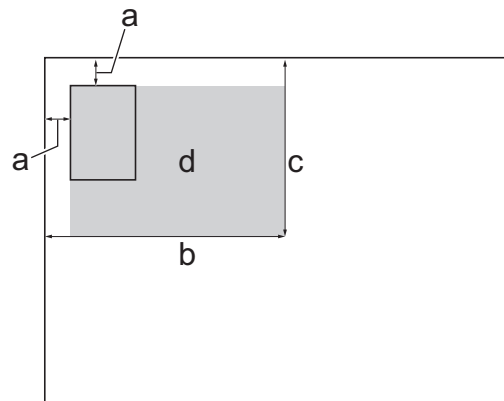

- a. 3 mm or greater (top, left)
- b. 145 mm
- c. 2 in 1 ID (Vertical): 207 mm
2 in 1 ID (Horizontal): 102 mm
- d. Scannable area

2. (MFC-J1010DW) Press  (COPY).
3. (MFC-J1010DW) Enter the number of copies using the dial pad.
4. (DCP-J1050DW) Press - or + on the control panel.
5. Press ▲ or ▼ to select the following:
 - a. Select [Page Layout]. Press **OK**.
 - b. Select [2in1 ID Vertical] or [2in1 ID Horizontal]. Press **OK**.
6. Press **Mono Start** or **Colour Start**.





The machine starts scanning one side of the identification card.

7. After the machine has scanned the first side, turn over the identification card and press ► to scan the other side.

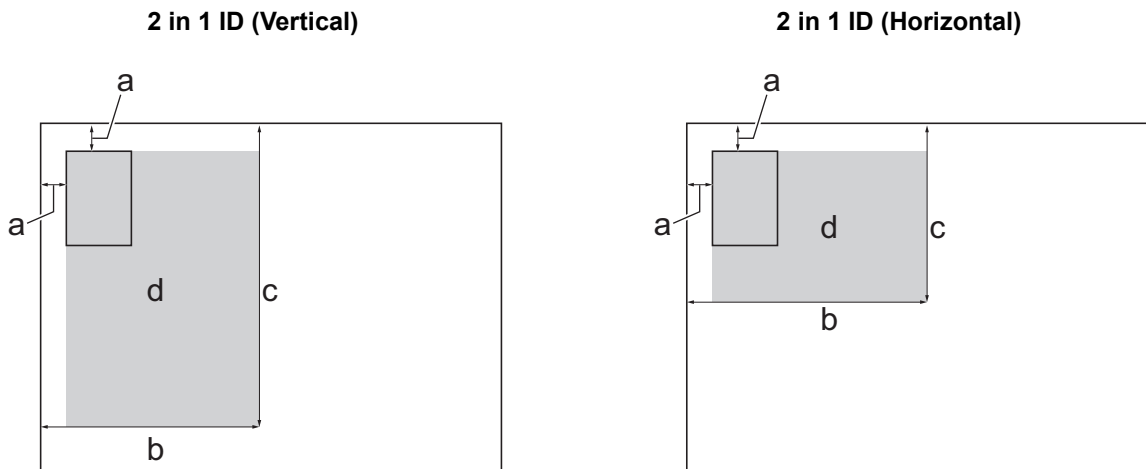
DCP-J1140DW

1. Place your identification card face down near the upper-left corner of the scanner glass.



- a. 3 mm or greater (top, left)
 - b. 145 mm
 - c. 2 in 1 ID (Vertical): 207 mm
2 in 1 ID (Horizontal): 102 mm
 - d. Scannable area
2. Press  [Copy].
 3. Enter the number of copies in one of the following ways:
 - Press [-] or [+] on the touchscreen.
 - Press  to display the keyboard on the touchscreen, and then enter the number of copies using the touchscreen keyboard. Press [OK].
 4. Press  [Options] > [Page Layout] > [2in1 ID Vertical] or [2in1 ID Horizontal].
-  You can also press [ID] for the [2in1 ID Vertical] setting.
5. Read and confirm the displayed list of settings you have selected. When you have finished changing settings, press [OK].
 6. Press [Mono Start] or [Colour Start].
The machine starts scanning one side of the identification card.
 7. After the machine has scanned the first side, turn over the identification card and press [Continue] to scan the other side.

Related Information

- [Copy](#)

Copy Settings

>> DCP-J1050DW/MFC-J1010DW

>> DCP-J1140DW

DCP-J1050DW/MFC-J1010DW

To change copy settings, press  (COPY).

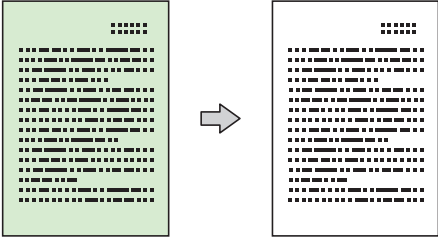
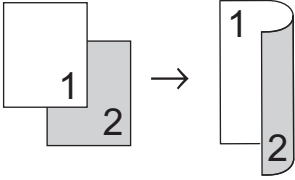
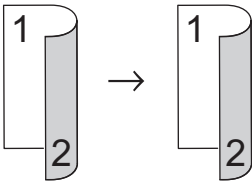
Option	Description	
Quality	Select the Copy resolution for your type of document.	
Paper Type	Select a paper type. If copying on special paper, set the machine for the type of paper you are using to get the best print quality.	
Paper Size	Select a paper size. If copying on paper other than A4 size, you must change the Paper Size setting.	
Enlarge/Reduce	100%	-
	Enlarge	Select an enlargement ratio for the next copy.
	Reduce	Select a reduction ratio for the next copy.
	Fit to Page	Adjusts the copy size to fit on the paper size you have set.
	Custom (25-400%)	Enter an enlargement or reduction ratio.
Density	Increase the density to make the text darker. Decrease the density to make the text lighter.	
Remove Background	Removes the document's background colour in copies. The white becomes more apparent. This saves some ink and may make certain copies easier to read. 	
2-sided Copy	Select to copy on both sides of the paper. 1-sided→2-sided  2-sided→2-sided 	

Option	Description
Stack/Sort	Select to stack or sort multiple copies.
	<div style="display: flex; justify-content: space-around;"> <div style="text-align: center;"> <p>Stack</p> </div> <div style="text-align: center;"> <p>Sort</p> </div> </div>
Page Layout	Make N in 1, 2 in 1 ID, or Poster copies.
	<div style="display: flex; justify-content: space-around;"> <div style="text-align: center;"> <p>4 in 1</p> </div> <div style="text-align: center;"> <p>Poster</p> </div> </div>
Auto Deskew	Select to correct a skewed copy. It is only available if the document is skewed by less than 3 degrees.
Set New Default	Saves the copy settings that you use most often by setting them as the default settings.
Factory Reset	Restores any changed copy settings to the factory settings.

DCP-J1140DW

To change copy settings, press  [Options].

Option	Description	
Quality	Select the Copy resolution for your type of document.	
Paper Type	Select a paper type. If copying on special paper, set the machine for the type of paper you are using to get the best print quality.	
Paper Size	Select a paper size. If copying on paper other than A4 size, you must change the Paper Size setting.	
Enlarge/Reduce	100%	-
	Enlarge	Select an enlargement ratio for the next copy.
	Reduce	Select a reduction ratio for the next copy.
	Fit to Page	Adjusts the copy size to fit on the paper size you have set.
	Custom (25-400%)	Enter an enlargement or reduction ratio.
Density	Increase the density to make the text darker. Decrease the density to make the text lighter.	

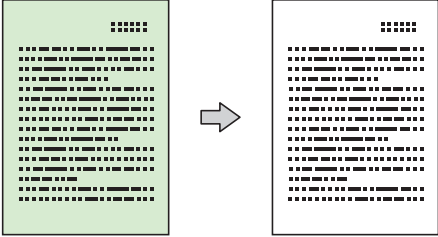
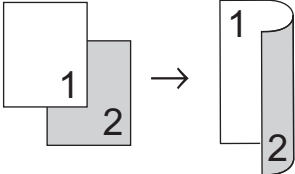
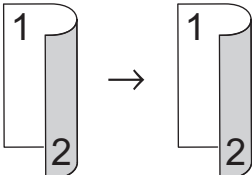
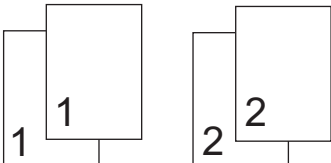
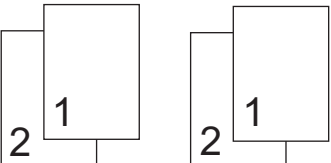
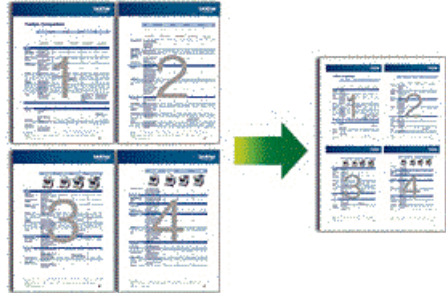
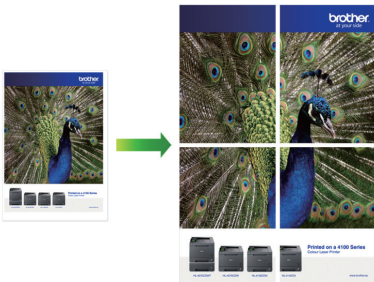
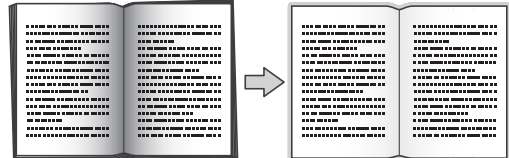
Option	Description
Remove Background Colour	<p>Removes the document's background colour in copies. The white becomes more apparent. This saves some ink and may make certain copies easier to read.</p> 
2-sided Copy	<p>Select to copy on both sides of the paper.</p> <p>1-sided→2-sided</p>  <p>2-sided→2-sided</p> 
Stack/Sort	<p>Select to stack or sort multiple copies.</p> <p>Stack</p>  <p>Sort</p> 
Page Layout	<p>Make N in 1, 2 in 1 ID, or Poster copies.</p> <p>4 in 1</p>  <p>Poster</p> 
Auto Deskw	<p>Select to correct a skewed copy.</p> <p>It is only available if the document is skewed by less than 3 degrees.</p>
Advanced Settings	<p>Book Copy</p> <p>Corrects dark borders and skew when copying from the scanner glass.</p> 

Option	Description
	<p>Watermark Copy Places text in your document as a watermark.</p> 
Set New Default	Saves the copy settings that you use most often by setting them as the default settings.
Factory Reset	Restores any changed copy settings to the factory settings.



You can save the current settings by pressing [Save as Shortcut].



Related Information

- [Copy](#)

Related Topics:

- [Copy a Document](#)

Fax

Related Models: MFC-J1010DW

- [Send a Fax](#)
- [Receive a Fax](#)
- [Voice Operations and Fax Numbers](#)
- [Telephone Services and External Devices](#)
- [Fax Reports](#)
- [PC-FAX](#)

Send a Fax

Related Models: MFC-J1010DW

- [Send a Fax from Your Brother Machine](#)
- [Send a Fax Manually](#)
- [Send a Fax at the End of a Conversation](#)
- [Send the Same Fax to More than One Recipient \(Broadcasting\)](#)
- [Send a Fax in Real Time](#)
- [Change the Fax Auto Redial Setting](#)
- [Cancel a Fax in Progress](#)
- [Check and Cancel a Pending Fax](#)
- [Fax Options](#)

Send a Fax from Your Brother Machine

Related Models: MFC-J1010DW

1. Load your document in the ADF or place it on the scanner glass.
2. Press  (FAX).

The LCD displays:

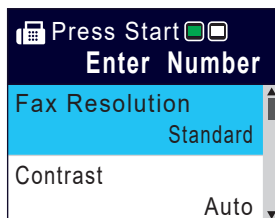

3. Enter the fax number in one of the following ways:
 - Dial Pad (Enter the fax number manually.)
Press all digits of the number using the dial pad.
 - Redial (Redial the last number you dialed.)
Press **Redial/Pause**.
 - Outgoing call (Select a number from the Outgoing Call History.)
Press ▲ or ▼ to select the following:
 - a. Select [Call History]. Press **OK**.
 - b. Select [Outgoing Call]. Press **OK**.
 - c. Select the number you want, and then press **OK**.
 - d. Press ► to select [Apply].
 - Caller ID (Select a number from the Caller ID History.)
Press ▲ or ▼ to select the following:
 - a. Select [Call History]. Press **OK**.
 - b. Select [Caller ID History]. Press **OK**.
 - c. Select the number you want, and then press **OK**.
 - d. Press ► to select [Apply].
 - [Address Book] (Select a number from the Address Book.)
Press ▲ or ▼ to select the following:
 - a. Select [Address Book]. Press **OK**.
 - b. Select [Search]. Press **OK**.
 - c. Do one of the following:
 - Enter the two-digit Speed Dial number using the dial pad.
 - Select a number from the list using these steps:
 - i. Select [Alphabetical Order] or [Numerical Order]. Press **OK**.
 - ii. Select the number you want. Press **OK**.
 - iii. Press ► to select [Apply].
4. To change the fax settings, press ▲ or ▼ to select the setting you want to change, and then press **OK**.
5. When finished, press **Mono Start** or **Colour Start**.
6. Do one of the following:
 - If you are using the ADF, the machine starts scanning and sending the document.
 - If you are using the scanner glass and pressed **Mono Start**, the machine starts scanning the first page.

Go to the next step.

- If you are using the scanner glass and pressed **Colour Start**, the LCD asks if you want to send a colour fax.

Press ► to confirm. The machine starts dialling and sending the document.

7. When the LCD displays [Next page?], do one of the following:

- Press ► to scan another page. Place the next page on the scanner glass, and then press ►. The machine starts scanning the page.

Repeat this step for each additional page.

- Press ◀ to send the fax when finished scanning pages. The machine starts sending the document.



Related Information

- [Send a Fax](#)

Related Topics:

- [Fax Options](#)
-

Send a Fax Manually

Related Models: MFC-J1010DW

Manual fax transmission lets you hear the dialling, ringing and fax-receiving tones while sending a fax.

1. Load your document.
2. To listen for a dial tone, pick up the handset of the external telephone.
3. Dial the fax number using the external telephone.
4. When you hear fax tones, press **Mono Start** or **Colour Start**.
 - If you are using the scanner glass, press ► to send a fax.
5. Replace the handset of the external phone.



Related Information

- [Send a Fax](#)

Send a Fax at the End of a Conversation

Related Models: MFC-J1010DW

At the end of a conversation, you can send a fax to the other party before you both hang up.

1. Ask the other party to wait for fax tones (beeps) and to press the Start key before hanging up.
2. Load your document.
3. Press **Mono Start** or **Colour Start**.
 - If you are using the scanner glass, press ► to send a fax.
4. Replace the handset of the external telephone.



Related Information

- [Send a Fax](#)

Send the Same Fax to More than One Recipient (Broadcasting)

Related Models: MFC-J1010DW

Use the Broadcasting feature to send the same fax to multiple fax numbers at the same time.

- This feature is available only for monochrome faxes.
- Address Book numbers must be stored in the machine's memory before they can be used in a broadcast.
- Group numbers must also be stored in the machine's memory before they can be used in a broadcast. Group numbers include many stored Address Book numbers for easier dialling.

You can include Groups, Address Book numbers, and up to 50 manually-dialled numbers in the same broadcast.

If you did not use any of the Address Book numbers for Groups, you can broadcast faxes to as many as 90 different numbers.

1. Load your document.
2. Press  (FAX).
3. Press ▲ or ▼ to select [Broadcasting], and then press **OK**.
4. Press ▲ or ▼ to select [Add Number], and then press **OK**.
5. You can add numbers to the broadcast in the following ways:
 - Enter a number using the dial pad:
 - a. Press ▲ or ▼ to select [Add Number], and then press **OK**.
 - b. Enter a number using the dial pad, and then press **OK**.
 - Select a number from the Address Book:
 - a. Press ▲ or ▼ to select [Add from Address book], and then press **OK**.
 - b. Press ▲ or ▼ to select [Alphabetical Order] or [Numerical Order], and then press **OK**.
 - c. Press ▲ or ▼ to select the Speed Dial name or number you want.
 - d. Press ◀ or ▶ to select the check box labelled with the Speed Dial name or number, and then press **OK**.
 - Search a number in the Address Book:
 - a. Press ▲ or ▼ to select [Search in Address book], and then press **OK**.
 - b. Enter the first letter of the name using the dial pad, and then press **OK**.
 - c. Press ▲ or ▼ to select the name, and then press **OK**.
 - d. Press **OK** again.
6. When finished, press ▲ or ▼ to select [Complete]. Press **OK**.
7. Press **Mono Start**.
8. Do one of the following:
 - If you are using the ADF, the machine starts scanning and sending the document.
 - If you are using the scanner glass, the machine starts scanning the first page.

When the LCD displays [Next page?], do one of the following:

 - Press ▶ to scan another page. Place the next page on the scanner glass, and then press ▶. The machine starts scanning the page.

Repeat this step for each additional page.
 - Press ◀ to send a fax when finished scanning pages. The machine starts sending the document.



If the [Out of Memory] message appears, press **Stop/Exit** to cancel.



Related Information

- [Send a Fax](#)
 - [Cancel a Broadcast in Progress](#)

Related Topics:

- [Set up Broadcasting Groups](#)
 - [Enter Text on Your Brother Machine](#)
-

Cancel a Broadcast in Progress

Related Models: MFC-J1010DW

While broadcasting multiple faxes, you can cancel just the fax currently being transmitted or cancel the whole broadcast job.

1. Press **Settings**.
2. Press ▲ or ▼ to select the following:
 - a. Select [Fax]. Press **OK**.
 - b. Select [Remaining Jobs]. Press **OK**.The LCD displays the fax number being dialled and the broadcasting job number.
3. Press ▲ or ▼ to select the job you want to cancel in the following ways:
 - To cancel the entire broadcast, select the broadcasting job number and then press **OK**. Press ► to confirm or press ◀ to exit without cancelling.
 - To cancel the current number being dialled, select the name or number on the LCD and then press **OK**. Press ► to confirm or press ◀ to exit without cancelling.
 - To exit without cancelling, press **Stop/Exit**.
4. Press **Stop/Exit**.



Related Information

- [Send the Same Fax to More than One Recipient \(Broadcasting\)](#)

Send a Fax in Real Time

Related Models: MFC-J1010DW

When sending a fax, the machine scans the document into the memory before sending it. As soon as the telephone line is free, the machine starts dialling and sending. If you want to send an important document immediately without waiting for the machine to retrieve the scan from its memory, turn on [Real Time TX].

- If you are sending a colour fax or if the machine's memory is full and you are sending a monochrome fax from the ADF, the machine sends the document in real time (even if [Real Time TX] is set to [Off]).
- In Real Time Transmission, the automatic redial feature does not work when using the scanner glass.

1. Load your document.
2. Press  (**FAX**).
3. Press ▲ or ▼ to select the following:
 - a. Select [Real Time TX]. Press **OK**.
 - b. Select [On] (or [Off]). Press **OK**.
4. Enter the fax number.
5. Press **Mono Start** or **Colour Start**.



Related Information

- [Send a Fax](#)

Change the Fax Auto Redial Setting

Related Models: MFC-J1010DW

If the line is busy when you are sending a fax automatically, and the Fax Auto Redial is set to [On], the machine redials up to three times at five-minute intervals.

The default setting for Fax Auto Redial is [On].

1. Press **Settings**.
2. Press **▲** or **▼** to select the following:
 - a. Select [Initial Setup]. Press **OK**.
 - b. Select [Fax Auto Redial]. Press **OK**.
 - c. Select [On] (or [Off]). Press **OK**.
3. Press **Stop/Exit**.



Related Information

- [Send a Fax](#)

Cancel a Fax in Progress

Related Models: MFC-J1010DW

1. Press **Stop/Exit** to cancel a fax that is already in progress.
2. When you press **Stop/Exit** while the machine is dialling or sending, the LCD displays [Cancel Job?]. Press **▶** to confirm.



Related Information

- [Send a Fax](#)

Related Topics:

- [Telephone and Fax Problems](#)

Check and Cancel a Pending Fax

Related Models: MFC-J1010DW

Follow these steps to view or to cancel faxes stored in the machine's memory and waiting to be sent. If there are no fax jobs in memory, the LCD displays [No Jobs Waiting]. You can cancel a fax job before it is sent.

1. Press **Settings**.
2. Press **▲** or **▼** to select the following:
 - a. Select [Fax]. Press **OK**.
 - b. Select [Remaining Jobs]. Press **OK**.
3. Do the following for each fax job you want to check or cancel:
 - a. Press **▲** or **▼** to scroll through the waiting jobs. If needed, select the job you want to cancel and then press **OK**.
 - b. Press **▶** to confirm or press **◀** to exit without cancelling.
4. When finished, press **Stop/Exit**.



Related Information

- [Send a Fax](#)

Related Topics:

- [Telephone and Fax Problems](#)

Fax Options

Related Models: MFC-J1010DW

To change fax-sending settings, press  (FAX).

Option	Description
Fax Resolution	Set the resolution for outgoing faxes. The fax quality often can be improved by changing the Fax Resolution.
Contrast	Adjust the contrast. If your document is very light or very dark, changing the contrast may improve the fax quality.
Glass Scan Size	Adjust the scan area of the scanner glass to the size of the document. <i>See Related Information: Scanner Specifications in Specifications.</i>
Broadcasting (monochrome only)	Send the same fax message to more than one fax number at the same time.
Real Time TX	Send a fax immediately without waiting for the machine to retrieve the scan from its memory.
Overseas Mode	Set to On if you have difficulty sending faxes overseas.
Call History	Select a number from the Call History.
Address Book	Select a number from the Address Book.
Set New Default	Save your settings as the default.
Factory Reset	Restore all settings back to the factory settings.



Related Information

- [Send a Fax](#)

Related Topics:

- [Send a Fax from Your Brother Machine](#)
- [Specifications](#)

Receive a Fax

Related Models: MFC-J1010DW

- [Receive Mode Settings](#)
- [Set Fax Detect](#)
- [Shrink Page Size of an Oversized Incoming Fax](#)
- [Set the Fax Receive Stamp](#)
- [Receive a Fax at the End of a Telephone Conversation](#)
- [Memory Receive Options](#)

Receive Mode Settings

Related Models: MFC-J1010DW

- [Receive Modes Overview](#)
- [Choose the Correct Receive Mode](#)
- [Set the Number of Rings Before the Machine Answers \(Ring Delay\)](#)
- [Set the F/T Ring Time \(Pseudo/Double-ring\)](#)

Receive Modes Overview

Related Models: MFC-J1010DW

Some receive modes answer automatically ([Fax Only] and [Fax/Tel]). You may want to change the Ring Delay before using these modes.

Fax Only

[Fax Only] mode automatically answers every call as a fax.

Fax/Tel

[Fax/Tel] mode helps you manage incoming calls, by recognising whether they are fax or voice calls and handling them in one of the following ways:

- Faxes are received automatically.
- Voice calls start the F/T ring to tell you to pick up the line. The F/T ring is a pseudo/double-ring made by your machine.

Manual

[Manual] mode turns off all automatic answering functions (unless you are using the BT Call Sign feature).

To receive a fax in [Manual] mode, lift the handset of the external telephone. When you hear fax tones (short repeating beeps), press the Start button, and then select [Receive] to receive a fax. You can also use the Fax Detect feature to receive faxes by lifting a handset on the same line as the machine.

External TAD

[External TAD] mode lets an external answering device manage your incoming calls.

Incoming calls are handled in the following ways:

- Faxes are received automatically.
- Voice callers can record a message on the external TAD.



Related Information

- [Receive Mode Settings](#)

Related Topics:

- [Set the Number of Rings Before the Machine Answers \(Ring Delay\)](#)
- [Set the F/T Ring Time \(Pseudo/Double-ring\)](#)
- [Set Fax Detect](#)
- [Connect an External TAD](#)

Choose the Correct Receive Mode

Related Models: MFC-J1010DW

You must choose a Receive Mode depending on the external devices and telephone services you have on your line.

By default, your machine automatically will receive any faxes that are sent to it. The diagram below will help you select the correct mode.

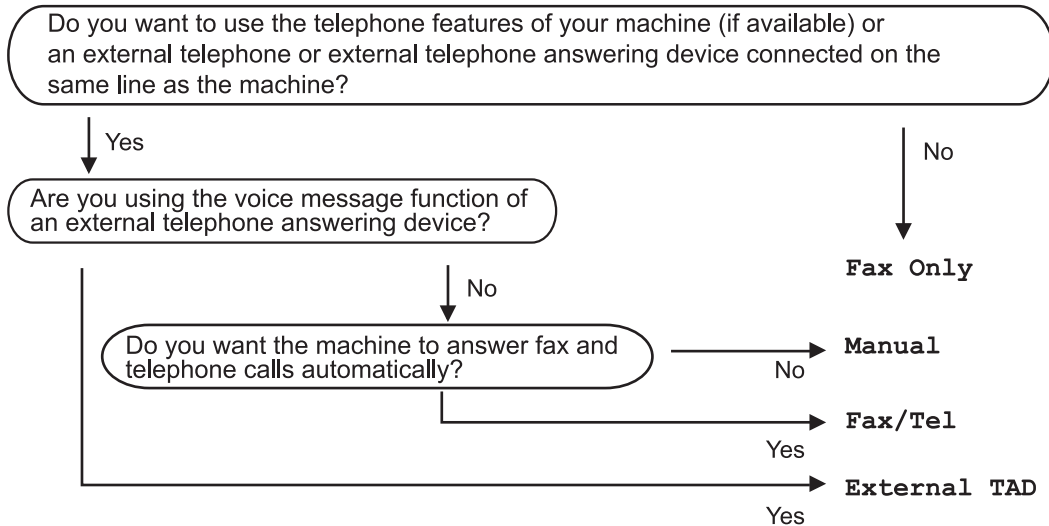

1. Press **Settings**.
2. Press **▲** or **▼** to select the following:
 - a. Select [Fax]. Press **OK**.
 - b. Select [Setup Receive]. Press **OK**.
 - c. Select [Receive Mode]. Press **OK**.



If the option to change the Receive Mode is unavailable, make sure the BT Call Sign feature is set to [Off].

3. Press **▲** or **▼** to select the [Fax Only], [Fax/Tel], [External TAD], or [Manual] option, and then press **OK**.
4. Press **Stop/Exit**.



Related Information

- [Receive Mode Settings](#)

Related Topics:

- [Enable the Machine to Work with BT Call Sign \(with Your External Telephone only\)](#)
- [Connect an External TAD](#)
- [Telephone and Fax Problems](#)

Set the Number of Rings Before the Machine Answers (Ring Delay)

Related Models: MFC-J1010DW

When somebody calls your machine, you will hear the normal telephone ring sound. The number of rings is set in the Ring Delay option.

- The Ring Delay setting sets the number of times the machine rings before it answers in [Fax Only] and [Fax/Tel] modes.
- If you have external or extension telephones on the same line as the machine, select the maximum number of rings.

1. Press **Settings**.
2. Press **▲** or **▼** to select the following:
 - a. Select [Fax]. Press **OK**.
 - b. Select [Setup Receive]. Press **OK**.
 - c. Select [Ring Delay]. Press **OK**.
 - d. Select the number of times you want the line to ring before the machine answers. Press **OK**.



- If you select [0], the machine answers immediately and the line will not ring at all. (available only for some countries)

3. Press **Stop/Exit**.



Related Information

- [Receive Mode Settings](#)

Related Topics:

- [Receive Modes Overview](#)
- [Operation from External and Extension Telephones](#)
- [Set Fax Detect](#)
- [Telephone and Fax Problems](#)

Set the F/T Ring Time (Pseudo/Double-ring)

Related Models: MFC-J1010DW

When you set the Receive Mode to [Fax/Tel], if the call is a fax, your machine will receive it automatically. However, if it is a voice call, the machine will sound the F/T ring (pseudo/double-ring) for the time you set in the F/T Ring Time option. When you hear the F/T ring, it means that a voice caller is on the line.

Because the F/T ring is a setting only on your Brother machine, extension and external telephones will not ring; however, you can still answer the machine's call on any telephone.

1. Press **Settings**.
2. Press **▲** or **▼** to select the following:
 - a. Select [Fax]. Press **OK**.
 - b. Select [Setup Receive]. Press **OK**.
 - c. Select [F/T Ring Time]. Press **OK**.
 - d. Select how long the machine will double-ring to alert you to a voice call. Press **OK**.
3. Press **Stop/Exit**.



Even if the caller hangs up during the pseudo/double-ringing, the machine will continue to ring for the set time.



Related Information

- [Receive Mode Settings](#)

Related Topics:

- [Receive Modes Overview](#)
- [Operation from External and Extension Telephones](#)

Set Fax Detect

Related Models: MFC-J1010DW

If Fax Detect is On: The machine receives a fax call automatically, even if you answer the call. When the message that your machine is receiving a fax appears on the LCD or when you hear “chirps” through the handset you are using, just replace the handset. Your machine will do the rest.

If Fax Detect is Off: If you are at the machine and answer a fax call by lifting the handset, press the Start button, and then select [Receive] to receive the fax. If you answered at an extension or external telephone, press *51.



- If Fax Detect is set to [On], but your machine does not connect a fax call when you lift an extension or external telephone handset, press the remote activation code *51.
- If you send faxes from a computer on the same telephone line and the machine intercepts them, set Fax Detect to [Off].

1. Press **Settings**.
2. Press ▲ or ▼ to select the following:
 - a. Select [Fax]. Press **OK**.
 - b. Select [Setup Receive]. Press **OK**.
 - c. Select [Fax Detect]. Press **OK**.
 - d. Select [On] (or [Off]). Press **OK**.
3. Press **Stop/Exit**.



Related Information

- [Receive a Fax](#)

Related Topics:

- [Receive Modes Overview](#)
- [Set the Number of Rings Before the Machine Answers \(Ring Delay\)](#)
- [Operation from External and Extension Telephones](#)
- [Use the Remote Codes](#)
- [Telephone and Fax Problems](#)

Shrink Page Size of an Oversized Incoming Fax

Related Models: MFC-J1010DW

When the [Auto Reduction] feature is [On], your Brother machine reduces any oversized incoming fax page to fit on your paper. The machine calculates the reduction ratio using the page size of the fax, and your Paper Size setting.

1. Press **Settings**.
2. Press **▲** or **▼** to select the following:
 - a. Select [Fax]. Press **OK**.
 - b. Select [Setup Receive]. Press **OK**.
 - c. Select [Auto Reduction]. Press **OK**.
 - d. Select [On] (or [Off]). Press **OK**.
3. Press **Stop/Exit**.



Related Information

- [Receive a Fax](#)

Related Topics:

- [Paper Settings](#)
- [Paper Handling and Printing Problems](#)

Set the Fax Receive Stamp

Related Models: MFC-J1010DW

Set the machine to print the date and time of receipt at the top of each incoming fax page. Make sure you have set the current date and time on the machine.

This feature is available only for monochrome faxes.

1. Press **Settings**.
2. Press **▲** or **▼** to select the following:
 - a. Select [Fax]. Press **OK**.
 - b. Select [Setup Receive]. Press **OK**.
 - c. Select [Fax Rx Stamp]. Press **OK**.
 - d. Select [On] (or [Off]). Press **OK**.
3. Press **Stop/Exit**.



Related Information

- [Receive a Fax](#)

Receive a Fax at the End of a Telephone Conversation

Related Models: MFC-J1010DW

If you are speaking on the telephone connected to your machine and the other party is also speaking on a telephone connected to his fax machine, at the end of the conversation, the other party can send you a fax before you both hang up.

- Your machine's ADF must be empty.

 1. Ask the other party to load the fax and to press the Start or Send key.
 2. When you hear CNG tones (slow, repeated beeps), press **Mono Start** or **Colour Start**.
 3. Press ◀ to receive the fax.
 4. Replace the external handset.



Related Information

- [Receive a Fax](#)

Memory Receive Options

Related Models: MFC-J1010DW

Use Memory Receive options to direct incoming faxes while you are away from the machine. You can use only one Memory Receive option at a time.

Memory Receive can be set to:

- PC-Fax Receive
- Forward to Cloud
The machine forwards your received faxes to the online services.
- Off

This feature is available only for monochrome faxes.

- [Use PC-Fax Receive to Transfer Received Faxes to Your Computer \(Windows only\)](#)
- [Print a Fax Stored in the Machine's Memory](#)

Use PC-Fax Receive to Transfer Received Faxes to Your Computer (Windows only)

Related Models: MFC-J1010DW

Turn on the PC-Fax Receive feature to automatically store incoming faxes to your machine's memory, and then send them to your computer. Use your computer to view and store these faxes.

- This feature is available only for monochrome faxes. When you receive a colour fax, your machine prints the colour fax but does not send the fax to your computer.
- Before you can set up PC-Fax Receive, you must install the Brother software and drivers on your computer. Make sure your computer is connected and turned on. You must have the PC-FAX Receiving software running on your computer.

Even if your computer is turned off, your machine will receive and store faxes in its memory. When you start your computer and the PC-FAX Receiving software runs, your machine transfers faxes to your computer automatically.

1. Press **Settings**.
2. Press **▲** or **▼** to select the following:
 - a. Select [Fax]. Press **OK**.
 - b. Select [Setup Receive]. Press **OK**.
 - c. Select [PC Fax Receive]. Press **OK**.
 - d. Select [On]. Press **OK**.

The LCD displays the message [Run the PC-Fax Receive program on your computer.].
 - e. Press **▶**.
 - f. Select [<USB>] or the name of the destination computer you want to receive faxes if you are on a network. Press **OK**.
 - g. Select [Backup Print: On] or [Backup Print: Off]. Press **OK**.
3. Press **Stop/Exit**.

To change the destination computer, repeat these steps.



Related Information

- [Memory Receive Options](#)

Related Topics:

- [Transfer Your Faxes or Fax Journal Report](#)
- [Transfer Faxes to Your Computer](#)
- [Receive Faxes Using PC-FAX Receive \(Windows\)](#)

Print a Fax Stored in the Machine's Memory

Related Models: MFC-J1010DW

- This feature is available only for monochrome faxes.
- After you print the fax, it is erased from the machine's memory.

If you turn on [PC Fax Receive], your machine will receive and store your faxes in its memory even when your PC is turned off.

1. Press **Settings**.
2. Press ▲ or ▼ to select the following:
 - a. Select [Fax]. Press **OK**.
 - b. Select [Print Document]. Press **OK**.
3. Press ▶.



Related Information

- [Memory Receive Options](#)

Related Topics:

- [Error and Maintenance Messages](#)
- [Telephone and Fax Problems](#)

Voice Operations and Fax Numbers

Related Models: MFC-J1010DW

- [Voice Operations](#)
- [Store Fax Numbers](#)
- [Set up Broadcasting Groups](#)

Voice Operations

Related Models: MFC-J1010DW

- [Pick up a Voice Call in Fax/Tel Receive Mode](#)

Pick up a Voice Call in Fax/Tel Receive Mode

Related Models: MFC-J1010DW

When the machine is in Fax/Tel mode, it will use the F/T Ring (pseudo/double-ringing) to alert you to pick up a voice call.

If you are at the machine, lift the external telephone's handset, and then press **Tel/R** button to answer.

If you are at an extension telephone, lift the handset during the F/T Ring and then press #51 between the pseudo/double rings. If no one is on the line, or if someone wants to send you a fax, send the call back to the machine by pressing *51.



Related Information

- [Voice Operations](#)

Store Fax Numbers

Related Models: MFC-J1010DW

- [Store Address Book Numbers](#)
- [Save Outgoing Call Numbers to the Address Book](#)
- [Save Caller ID History Numbers to the Address Book](#)
- [Change or Delete Address Book Names or Numbers](#)

Store Address Book Numbers

Related Models: MFC-J1010DW

You can store up to 40 Address Book numbers as two-digit Speed Dial numbers, and give each number a name.

1. Press **▶** **☰** (Address Book).
2. Press **▲** or **▼** to select [Set Speed Dial]. Press **OK**.
3. Press **▲** or **▼** to select the following:
 - a. Select the two-digit Speed Dial number where you want to store the number. Press **OK**.
 - b. Select [Name]. Press **OK**.
 - c. Enter the name (up to 16 characters) using the dial pad. Press **OK**.
 - d. Select [Fax/Tel]. Press **OK**.
 - e. Enter the fax or telephone number (up to 20 digits). Press **OK**.



- Press **Redial/Pause** to insert a pause between numbers. You can press **Redial/Pause** as many times as needed to increase the length of the pause.
- Be sure to include the area code when entering a fax or telephone number. Depending on the country, the Caller ID names and history may not be displayed correctly if the area code is not registered with the fax or telephone number.

- f. Select [OK] and then press **OK**.

To store another Speed Dial number, repeat these steps.

4. Press **Stop/Exit**.



Related Information

- [Store Fax Numbers](#)

Related Topics:

- [Set up Broadcasting Groups](#)

Save Outgoing Call Numbers to the Address Book

Related Models: MFC-J1010DW

You can copy numbers from your Outgoing Call history and save them in your Address Book.

1. Press  (FAX).
2. Press ▲ or ▼ to select the following:
 - a. Select [Call History]. Press **OK**.
 - b. Select [Outgoing Call]. Press **OK**.
 - c. Select the number you want to store. Press **OK**.
 - d. Press ◀ to select [Edit].
 - e. Select [Add to Address Book]. Press **OK**.



To delete the number from the Outgoing Call history list, select [Delete] and then press **OK**. Press ▶ [Yes] to confirm.

- f. Select [Name]. Press **OK**.
 - g. Enter the name (up to 16 characters) using the dial pad. Press **OK**.
 - h. Confirm the fax or telephone number.
 - i. Select [OK] and then press **OK**.
3. Press **Stop/Exit**.



Related Information

- [Store Fax Numbers](#)

Related Topics:

- [Enter Text on Your Brother Machine](#)

Save Caller ID History Numbers to the Address Book

Related Models: MFC-J1010DW

If you have a Caller ID subscriber service with your telephone company, you can copy numbers from your Caller ID History and save them in your Address Book.

1. Press  (FAX).
2. Press ▲ or ▼ to select the following:
 - a. Select [Call History]. Press **OK**.
 - b. Select [Caller ID History]. Press **OK**.
 - c. Select the number you want to store. Press **OK**.
 - d. Press ◀ to select [Edit].
 - e. Select [Add to Address Book]. Press **OK**.



To delete the number from the Caller ID History list, select [Delete] and then press **OK**. Press ▶ [Yes] to confirm.

- f. Select [Name]. Press **OK**.
 - g. Enter the name (up to 16 characters) using the dial pad. Press **OK**.
 - h. Confirm the fax or telephone number.
 - i. Select [OK] and then press **OK**.
3. Press **Stop/Exit**.



Related Information

- [Store Fax Numbers](#)

Related Topics:

- [Caller ID](#)
- [Enter Text on Your Brother Machine](#)

Change or Delete Address Book Names or Numbers

Related Models: MFC-J1010DW

1. Press **▶** **☐** (Address Book).
2. Do one of the following:
 - To change the number, press **▲** or **▼** to select the following:
 - a. Select [Change]. Press **OK**.
 - b. Select the Speed Dial name where you want to change the number. Press **OK**.Do the following steps:
 - a. To change the name, press **▲** or **▼** to select [Name], and then press **OK**. Press **▲**, **▼**, **◀** or **▶** to re-enter the name (up to 16 characters) using the keyboard on the LCD and select [OK]. Press **OK**.
 - b. To change the fax or telephone number, press **▲** or **▼** to select [Fax/Tel], and then press **OK**. Press **▲**, **▼**, **◀** or **▶** to re-enter the fax or telephone number (up to 20 digits) using the keyboard on the LCD and select [OK]. Press **OK**.Press **▲** or **▼** to select [OK] and then press **OK**.
 - To delete the number, press **▲** or **▼** to select [Delete]. Press **OK**.Do the following steps:
 - a. Press **▲** or **▼** to select the Speed Dial name where you want to delete the number.
 - b. Press **◀** or **▶** to select the check box labelled with the Speed Dial name. Press **OK**.
3. Press **Stop/Exit**.



Related Information

- [Store Fax Numbers](#)

Set up Broadcasting Groups

Related Models: MFC-J1010DW

Creating and sending to a Group, which can be stored in the Address Book, allows you to send the same fax message to many fax numbers, or Broadcast.

First, you must store each fax number in the Address Book. Then, you can include them as numbers in the Group. Each Group uses up a Speed Dial number. You can store up to six Groups or you can assign up to 39 numbers to a large Group.

1. Press **▶**  (Address Book).
2. Press **▲** or **▼** to select the following:
 - a. Select [Setup Groups]. Press **OK**.
 - b. Select the two-digit Speed Dial number you want to assign to the Group. Press **OK**.
 - c. Select [Name] and press **OK**.
 - d. Enter the new Group's name (up to 16 characters) using the dial pad. Press **OK**.
 - e. To add numbers to the Group, repeat the following steps:
 - i. Select [Add/Delete]. Press **OK**.
 - ii. Select [Alphabetical Order] or [Numerical Order]. Press **OK**.
 - iii. Press **▲** or **▼** to select a number from the list.
 - iv. Press **◀** or **▶** to select the check box labelled with the Speed Dial number. Press **OK**.
3. Select [OK] and then press **OK**.
4. Press **Stop/Exit**.



Related Information

- [Voice Operations and Fax Numbers](#)
 - [Change a Broadcasting Group Name](#)
 - [Delete a Broadcasting Group](#)
 - [Add or Delete a Broadcasting Group Member](#)

Related Topics:



- [Send the Same Fax to More than One Recipient \(Broadcasting\)](#)
- [Store Address Book Numbers](#)

Change a Broadcasting Group Name

Related Models: MFC-J1010DW

1. Press **▶**  (Address Book).
2. Press **▲** or **▼** to select the following:
 - a. Select [Change]. Press **OK**.
 - b. Select the Group to change. Press **OK**.
 - c. Select [Name] and then press **OK**. Enter the new Group name (up to 16 characters) using the dial pad and then press **OK**.



To change a character in the Group name, press **▲**, **▼**, **◀** or **▶** to select  or . Press **OK** several times to move the cursor under the incorrect character. Then press **▲**, **▼**, **◀** or **▶** to select , and press **OK**. Re-enter the correct letter.

3. Select [OK] and then press **OK**.
4. Press **Stop/Exit**.



Related Information

- [Set up Broadcasting Groups](#)

Related Topics:

- [Enter Text on Your Brother Machine](#)

Delete a Broadcasting Group

Related Models: MFC-J1010DW

1. Press **▶** **☰** (Address Book).
2. Press **▲** or **▼** to select [Delete]. Press **OK**.
3. Do the following steps:
 - a. Press **▲** or **▼** to select the Group you want to delete.
 - b. Press **◀** or **▶** to select the check box labelled with the Group name. Press **OK**.
4. Press **Stop/Exit**.



Related Information

- [Set up Broadcasting Groups](#)

Add or Delete a Broadcasting Group Member

Related Models: MFC-J1010DW

1. Press **▶** **☐** (Address Book).
2. Press **▲** or **▼** to select the following:
 - a. Select [Change]. Press **OK**.
 - b. Select the Group you want to change. Press **OK**.
 - c. Select [Add/Delete]. Press **OK**.
 - d. Select [Alphabetical Order] or [Numerical Order]. Press **OK**.
3. Do one of the following:
 - To add a member using his Speed Dial number, press **▲** or **▼** to select the Speed Dial number, and then press **◀** or **▶** to select the check box.
 - To delete a member using his Speed Dial number, press **▲** or **▼** to select the Speed Dial number, and then press **◀** or **▶** to remove the check box.Repeat this step until you have added or deleted all the fax numbers you want.
4. Press **OK**.
5. Select [OK] and then press **OK**.
6. Press **Stop/Exit**.



Related Information

- [Set up Broadcasting Groups](#)

Telephone Services and External Devices

Related Models: MFC-J1010DW

- [Use BT Call Sign](#)
- [Caller ID](#)
- [Set the Telephone Line Type](#)
- [Voice Over Internet Protocol \(VoIP/Telephone Line Interference\)](#)
- [External TAD \(Telephone Answering Device\)](#)
- [External and Extension Telephones](#)

Use BT Call Sign

Related Models: MFC-J1010DW

This feature of the machine lets you use the BT Call Sign subscriber service which allows you to have at least two separate telephone numbers on one telephone line. Each telephone number has its own distinctive ringing pattern, so you know which telephone number is ringing. This is one way you can have a separate telephone number for your machine.

Your machine has a BT Call Sign compatible distinctive ringing function, allowing you to dedicate a second telephone number (on the same telephone line) just for receiving faxes.



- This feature is available only in the U.K.
- You can switch BT Call Sign Off temporarily, then turn it back on. When you get a new fax number, make sure you reset this function. This machine will automatically answer incoming calls that use your new fax number.
- When you set the BT Call Sign feature to On, the receive mode is set to [Manual] automatically. [Manual] mode will not respond to incoming telephone calls, since the number you use for telephone calls will use the normal ring pattern.



Related Information

- [Telephone Services and External Devices](#)
 - [Enable the Machine to Work with BT Call Sign \(with Your External Telephone only\)](#)

Enable the Machine to Work with BT Call Sign (with Your External Telephone only)

Related Models: MFC-J1010DW

This feature is available only in the U.K.

1. Press **Settings**.
2. Press ▲ or ▼ to select the following:
 - a. Select [Fax]. Press **OK**.
 - b. Select [Miscellaneous]. Press **OK**.
 - c. Select [BT Call Sign]. Press **OK**.
 - d. Select [On] (or [Off]). Press **OK**.
3. Press **Stop/Exit**.

When you turn off BT Call Sign, the receive mode stays in [Manual]. You must set the receive mode again.



Related Information

- [Use BT Call Sign](#)

Related Topics:

- [Choose the Correct Receive Mode](#)
- [Error and Maintenance Messages](#)

Caller ID

Related Models: MFC-J1010DW

The Caller ID feature lets you use the Caller ID subscriber service offered by many local telephone companies. This service displays the telephone number, or name if it is available, of your caller as the line rings.

- The [ID Unknown] message means the call originated outside your Caller ID service area.
- The [ID Withheld] message means the caller has intentionally blocked transmission of Caller ID information.

Call your telephone company for more information.

Once you answer a call, the Caller ID information disappears from the LCD and is stored in Caller ID memory.

View the list or select a number and fax to it, add it to the Address Book, or delete it from the history.

You can print a list of the Caller ID information received by your machine.



- This feature is not available in some countries.
- The Caller ID service varies with different carriers. Contact your local telephone company to learn about the service available in your area.



Related Information

- [Telephone Services and External Devices](#)
 - [Set Caller ID to On](#)

Related Topics:

- [Save Caller ID History Numbers to the Address Book](#)
- [Print a Report](#)
- [Error and Maintenance Messages](#)

Set Caller ID to On

Related Models: MFC-J1010DW

This feature is available only in the U.K. and Ireland.

If you subscribe to the Caller ID service on your phone line, set Caller ID to On to display the caller's telephone number on the LCD as the telephone rings.

1. Press **Settings**.
2. Press **▲** or **▼** to select the following:
 - a. Select [Fax]. Press **OK**.
 - b. Select [Miscellaneous]. Press **OK**.
 - c. Select [Caller ID]. Press **OK**.
 - d. Select [On]. Press **OK**.
3. Press **Stop/Exit**.



Related Information

- [Caller ID](#)

Set the Telephone Line Type

Related Models: MFC-J1010DW

If you are connecting the machine to a line that features PBX or ISDN to send and receive faxes, you must select a Telephone Line Type that matches your line's features.

1. Press **Settings**.
2. Press **▲** or **▼** to select the following:
 - a. Select [Initial Setup]. Press **OK**.
 - b. Select [Phone Line Set]. Press **OK**.
 - c. Select [Normal], [PBX] or [ISDN]. Press **OK**.
3. Press **Stop/Exit**.



Related Information

- [Telephone Services and External Devices](#)
 - [PBX and TRANSFER](#)

Related Topics:

- [Telephone and Fax Problems](#)

PBX and TRANSFER

Related Models: MFC-J1010DW

The machine's [Phone Line Set] default setting is [Normal], which lets the machine connect to a standard Public Switched Telephone Network (PSTN) line. However, many offices use a central telephone system or Private Branch Exchange (PBX). Your machine can be connected to most types of PBX. The machine's recall feature supports timed break recall only (TBR). TBR will work with most PBX systems allowing you to gain access to an outside line, or transfer calls to another extension. Press the **Tel/R** button to use this feature.



Program a press of the **Tel/R** button as part of a number stored in the Address Book. When programming the Address Book number, press the **Tel/R** button first (the LCD displays '!'), then enter the telephone number. This avoids having to press the **Tel/R** button each time before you dial from the Address Book. However, your Telephone Line Type must be set to PBX on the machine for you to use this feature.



Related Information

- [Set the Telephone Line Type](#)

Voice Over Internet Protocol (VoIP/Telephone Line Interference)

Related Models: MFC-J1010DW

VoIP is a type of phone system that uses an Internet connection instead of a traditional telephone line. Telephone providers frequently bundle VoIP together with Internet and cable services.

Your machine may not work with some VoIP systems. If you want to use your machine to send and receive faxes on a VoIP system, make sure one end of your telephone cord is connected to the socket labelled **LINE** on your machine. The other end of the telephone cord may be connected to a modem, phone adapter, splitter, or other such device.

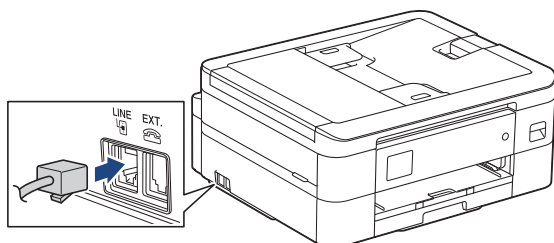

 If you have questions about how to connect your machine to the VoIP system, please contact your VoIP provider.

After you have connected your machine to the VoIP system, check for a dial tone. Lift the external telephone's handset and listen for a dial tone. If there is no dial tone, please contact your VoIP provider.

If you are having problems sending or receiving faxes over a VoIP system, we recommend changing the machine's modem speed to the [Basic (for VoIP)] setting.

Related Information

- [Telephone Services and External Devices](#)

Related Topics:

- [Telephone Line Interference/VoIP](#)

External TAD (Telephone Answering Device)

Related Models: MFC-J1010DW

You can connect an external Telephone Answering Device (TAD) to the same line as your machine. When the TAD answers a call, your machine will “listen” for the CNG (fax calling) tones sent by a sending fax machine. If it hears them it will take over the call and receive the fax. If it does not hear them, it will let your TAD take a voice message and the LCD will show [Telephone].

The external TAD must answer within four rings (we recommend setting it to two rings). This is because your machine cannot hear the CNG tones until the external TAD has picked up the call. The sending machine will send CNG tones for only eight to ten seconds longer. We do not recommend using the toll saver feature on your external TAD if it needs more than four rings to activate it.

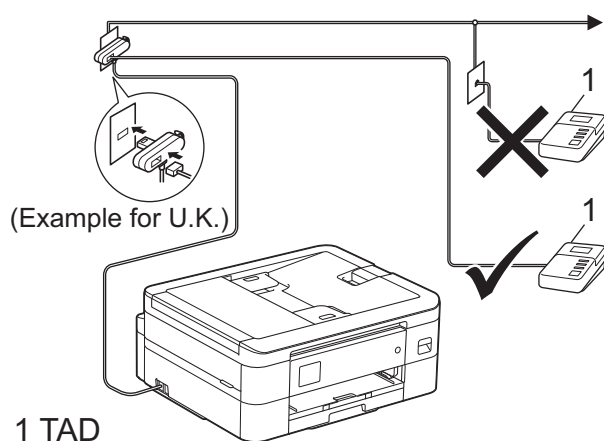

IMPORTANT

DO NOT connect a TAD elsewhere on the same telephone line.



If you have problems receiving faxes, reduce the Ring Delay setting on your external TAD.



Related Information

- [Telephone Services and External Devices](#)
 - [Connect an External TAD](#)
 - [Record an Outgoing Message \(OGM\) on the External TAD](#)
 - [Multi-line Connections \(PBX\)](#)

Related Topics:

- [Telephone and Fax Problems](#)

Connect an External TAD

Related Models: MFC-J1010DW

1. Set your external TAD to the minimum number of rings allowed. For more information, contact your telephone provider. (The machine's Ring Delay setting does not apply.)
2. Record the outgoing message on your external TAD.
3. Set the TAD to answer calls.
4. Set the Receive Mode on your machine to [External TAD].



Related Information

- [External TAD \(Telephone Answering Device\)](#)

Related Topics:

- [Receive Modes Overview](#)
- [Choose the Correct Receive Mode](#)
- [Telephone and Fax Problems](#)

Record an Outgoing Message (OGM) on the External TAD

Related Models: MFC-J1010DW

1. Record five seconds of silence at the beginning of your message. This allows your machine time to listen for fax tones.



We recommend beginning your OGM with an initial five second silence because the machine cannot hear fax tones over a loud voice. You may try leaving out this pause, but if your machine has trouble receiving faxes, then you should re-record the OGM to include it.

2. Limit your speaking to 20 seconds.
3. End your 20-second message by giving your Remote Activation Code for people sending manual faxes. For example: "After the beep, leave a message or press *51 and Start to send a fax."



Related Information

- [External TAD \(Telephone Answering Device\)](#)

Multi-line Connections (PBX)

Related Models: MFC-J1010DW

We suggest you ask the company that installed your PBX to connect your machine. If you have a multi line system we suggest you ask the installer to connect the unit to the last line on the system. This prevents the machine being activated each time the system receives telephone calls. If all incoming calls will be answered by a switchboard operator we recommend setting the Receive Mode to [Manual].

We cannot guarantee that your machine will operate correctly under all circumstances when connected to a PBX. Any difficulties with sending or receiving faxes should be reported first to the company that handles your PBX.



Related Information

- [External TAD \(Telephone Answering Device\)](#)

External and Extension Telephones

Related Models: MFC-J1010DW

- [Connect an External or Extension Telephone](#)
- [Operation from External and Extension Telephones](#)
- [Use Extension Telephones](#)
- [Use the Remote Codes](#)

Connect an External or Extension Telephone

Related Models: MFC-J1010DW

You can connect a separate telephone to your machine as shown in the diagram below.

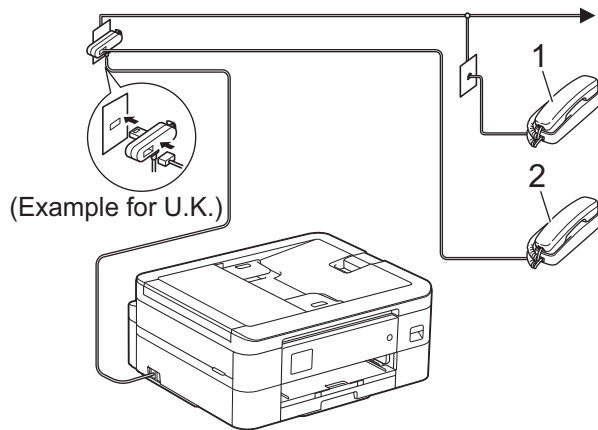

- 1 Extension telephone
- 2 External telephone



Please make sure you use an external telephone with a cable no more than three metres long.



Related Information

- [External and Extension Telephones](#)

Operation from External and Extension Telephones

Related Models: MFC-J1010DW

If you answer a fax call at an extension or an external telephone, you can make your machine take the call by using the Remote Activation Code. When you press the Remote Activation Code ***51**, the machine starts to receive the fax.

If the machine answers a voice call and pseudo/double-rings for you to take over, you can take the call at an extension telephone by pressing the Remote Deactivation Code **#51**.

If you answer a call and no one is on the line:

You should assume that you're receiving a manual fax.

Press ***51** and wait for the chirp or until the LCD shows [Receiving], and then hang up.



You can also use the Fax Detect feature to make your machine automatically take the call.



Related Information

- [External and Extension Telephones](#)

Related Topics:

- [Set the Number of Rings Before the Machine Answers \(Ring Delay\)](#)
- [Set Fax Detect](#)
- [Set the F/T Ring Time \(Pseudo/Double-ring\)](#)

Use Extension Telephones

Related Models: MFC-J1010DW

Your premises may already be wired with parallel extension telephones, or you may plan to add extension telephones to your line, as well as your machine. While the simplest arrangement is a straightforward parallel connection, there are some problems with this. The most obvious is inadvertent interruption of a fax transmission caused by someone picking up an extension telephone to make an outgoing call. Also, the remote activation code feature may not operate reliably in such a simple configuration.

This machine also may be set to make a delayed transmission (i.e. a transmission at a pre-set time). This pre-set job may coincide with someone picking up an extension handset.

These problems can easily be eliminated, if you arrange modification of your extension wiring circuit, such that extension devices are connected “downstream” of your machine in a master/slave configuration (see fig. 2). In this configuration the machine can always detect whether a telephone is in use. Thus it will not attempt to seize the line during that time. This is known as “telephone off-hook detection.”

The inadvisable configuration is shown in figure 1, and the recommended master/slave configuration is shown in figure 2.

This new connection configuration can be arranged by contacting BT, Kingston upon Hull Telecommunications, your PBX maintainer or a qualified telephone installation company as appropriate. Simply explained, the extension telephone circuit should be terminated on a normal modular plug (BT 431A style), which in turn should be put into the modular socket of the white “T”-shaped connector provided as part of the line cord assembly.

Inadvisable connection of extension sockets (Fig. 1.)

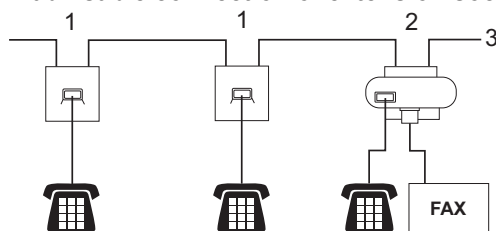

1. Extension socket
2. Master socket
3. Incoming line

Recommended connection of extension sockets (Fig. 2.)

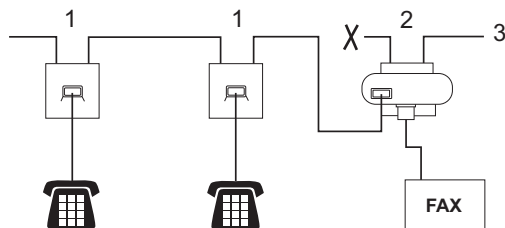

1. Extension socket
2. Master socket
3. Incoming line

The fax machine must be plugged into the master socket.



These telephones are now connected as external devices, because they are connected to the fax machine via the T-connector.



Related Information

- [External and Extension Telephones](#)

Use the Remote Codes

Related Models: MFC-J1010DW

Remote Activation Code

If you answer a fax call on an extension or external telephone, you can tell your machine to receive it by pressing the Remote Activation Code ***51**. Wait for the chirping sounds then replace the handset.

If you answer a fax call at the external telephone, you can make the machine receive the fax by pressing the Start button and then selecting the option to receive.

Remote Deactivation Code

If you receive a voice call and the machine is in F/T mode, it will start to sound the F/T ring (pseudo/double-ring) after the initial Ring Delay. If you pick up the call on an extension telephone you can turn the F/T ring off by pressing **#51** (make sure you press this between the rings).

If the machine answers a voice call and pseudo/double-rings for you to take over, you can take the call at the external telephone by pressing **Tel/R**.



Related Information

- [External and Extension Telephones](#)
 - [Change the Remote Codes](#)

Related Topics:

- [Set Fax Detect](#)

Change the Remote Codes

Related Models: MFC-J1010DW

The preset Remote Activation Code is ***51**. The preset Remote Deactivation Code is **#51**. If you are always disconnected when accessing your External TAD remotely, try changing the three-digit remote codes using the numbers 0-9, *, #.

1. Press **Settings**.
2. Press **▲** or **▼** to select the following:
 - a. Select [Fax]. Press **OK**.
 - b. Select [Setup Receive]. Press **OK**.
 - c. Select [Remote Codes]. Press **OK**.
 - d. Select [Remote Codes] again. Press **OK**.
 - e. Select [On]. Press **OK**.
3. Do one of the following:
 - To change the Remote Activation Code, press **▲** or **▼** to select [Act. Code] and then press **OK**. Enter the new code. Press **OK**.
 - To change the Remote Deactivation Code, press **▲** or **▼** to select [Deact. Code] and then press **OK**. Enter the new code. Press **OK**.
4. Press **Stop/Exit**.



Related Information

- [Use the Remote Codes](#)

Fax Reports

Related Models: MFC-J1010DW

- [Set the Transmission Verification Report's Style](#)
- [Set the Fax Journal's Interval Period](#)
- [Print Reports](#)
- [Set the Machine to Power Off Automatically](#)

Set the Transmission Verification Report's Style

Related Models: MFC-J1010DW

You can use the Transmission Verification Report as proof that you sent a fax. This report lists the receiving party's name or fax number, the time and date of transmission, duration of transmission, number of pages sent, and whether or not the transmission was successful.

There are several settings available for the Transmission Verification Report:

Option	Description
On	Prints a report after every fax you send.
On (+Image)	Prints a report after every fax you send. A portion of the fax's first page appears on the report.
Error only	Prints a report if your fax is unsuccessful due to a transmission error.
Error only (+Image)	Prints a report if your fax is unsuccessful due to a transmission error. A portion of the fax's first page appears on the report.
Off	The report will not be printed.

1. Press **Settings**.
2. Press **▲** or **▼** to select the following:
 - a. Select [Fax]. Press **OK**.
 - b. Select [Report Setting]. Press **OK**.
 - c. Select [XMIT Report]. Press **OK**.
 - d. Select the option you want. Press **OK**.

If you select [On (+Image)] or [Error only (+Image)], the image will not appear on the Transmission Verification Report if Real Time Transmission is set to [On]. The image will not appear on the report when you send a colour fax.

3. Press **Stop/Exit**.

If the transmission is successful, [OK] appears next to [RESULT] on the Transmission Verification Report. If the transmission is not successful, [ERROR] appears next to [RESULT].

Related Information

- [Fax Reports](#)

Set the Fax Journal's Interval Period

Related Models: MFC-J1010DW

You can set the machine to print a Fax Journal at specific intervals (every 50 faxes, 6, 12 or 24 hours, 2 or 7 days).



When using the Auto Power Off feature and the machine powers off before the chosen Interval Period, the machine will print a Fax Journal report, and then erase all fax jobs from the Journal's memory.

1. Press **Settings**.
2. Press **▲** or **▼** to select the following:
 - a. Select [Fax]. Press **OK**.
 - b. Select [Report Setting]. Press **OK**.
 - c. Select [Journal Period]. Press **OK**.
 - d. Select [Journal Period] once again. Press **OK**.
3. Press **▲** or **▼** to select an interval. Press **OK**.
 - 6, 12, 24 hours, 2 or 7 days
The machine will print the report at the selected interval and then erase all fax jobs from the Journal's memory. If the memory becomes full with 200 jobs before the time you selected has passed, the machine will print the Journal early and then erase all fax jobs from the memory. If you want an extra report before it is due to print, you can print it without erasing the jobs.
 - Every 50 Faxes
The machine will print the Journal when the machine has stored 50 fax jobs.
4. If you selected 6, 12, 24 hours, 2 or 7 days, press **▲** or **▼** to select [Time] and then press **OK**. Enter the time of day using the dial pad. Press **OK**.
5. If you selected [Every 7 Days], press **▲** or **▼** to select [Day] and then press **OK**. Press **▲** or **▼** to select the first day of the seven-day countdown. Press **OK**.
6. Press **Stop/Exit**.



Related Information

- [Fax Reports](#)

Related Topics:

- [Set the Machine to Power Off Automatically](#)

PC-FAX

Related Models: MFC-J1010DW

- [PC-FAX for Windows](#)
- [PC-FAX for Mac](#)

PC-FAX for Windows

Related Models: MFC-J1010DW

- [PC-FAX Overview \(Windows\)](#)
- [Send a Fax Using PC-FAX \(Windows\)](#)
- [Receive Faxes on Your Computer \(Windows\)](#)

PC-FAX Overview (Windows)

Related Models: MFC-J1010DW

Reduce paper consumption and save time by using the Brother PC-FAX software to send faxes directly from your computer.

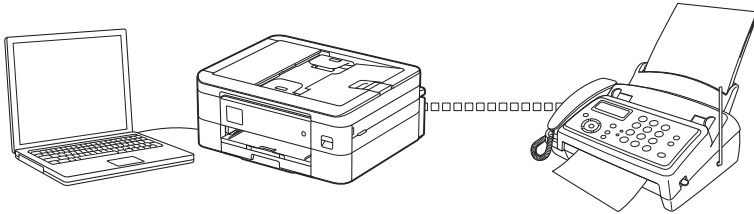

- [Configure PC-FAX \(Windows\)](#)
- [Configure your PC-Fax Address Book \(Windows\)](#)

Configure PC-FAX (Windows)

Related Models: MFC-J1010DW

Before sending faxes using PC-FAX, personalise the send options in each tab of the **PC-FAX Setup** dialog box.

1. Launch  (**Brother Utilities**), and then click the drop-down list and select your model name (if not already selected).
2. Click **PC-FAX** in the left navigation bar, and then click **Setup Sending**.

The **PC-FAX Setup** dialog box appears.

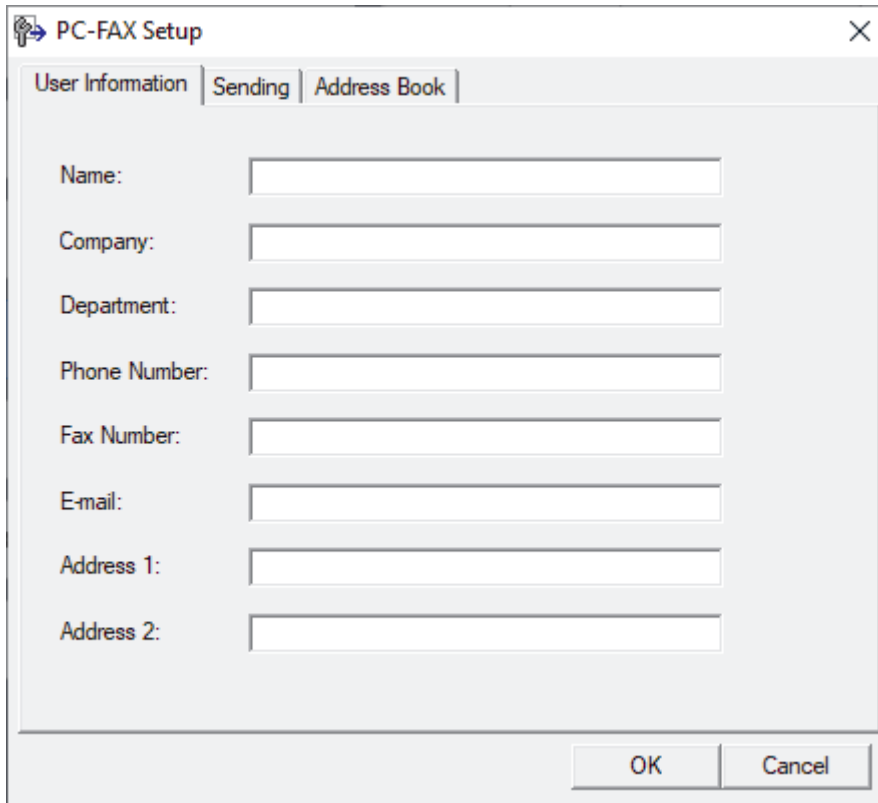

3. Do one of the following:
 - Click the **User Information** tab, and then type your user information in the fields.



Each Microsoft account can have its own customised **User Information** screen for custom fax headers and cover pages.

- Click the **Sending** tab, and then type the number needed to access an outside line (if needed) in the **Outside line access** field. Select the **Include header** check box to include the header information.
 - Click the **Address Book** tab, and then select the address book you want to use for PC-FAX from the **Select Address Book** drop-down list.
4. Click **OK**.



Related Information

- [PC-FAX Overview \(Windows\)](#)

Configure your PC-Fax Address Book (Windows)

Related Models: MFC-J1010DW

Add, edit and delete members and groups to personalise your **Address Book**.

- [Add a Member to your PC-FAX Address Book \(Windows\)](#)
- [Create a Group in your PC-FAX Address Book \(Windows\)](#)
- [Edit Member or Group Information in your PC-FAX Address Book \(Windows\)](#)
- [Delete a Member or Group in your PC-FAX Address Book \(Windows\)](#)
- [Export your PC-FAX Address Book \(Windows\)](#)
- [Import Information to your PC-FAX Address Book \(Windows\)](#)

Add a Member to your PC-FAX Address Book (Windows)

Related Models: MFC-J1010DW

Add new people and their fax information to the PC-Fax Address Book if you want to send a fax using the Brother PC-Fax software.

1. Launch  (**Brother Utilities**), and then click the drop-down list and select your model name (if not already selected).
2. Click **PC-FAX** in the left navigation bar, and then click **Address Book (Send)**.

The **Address Book** dialog box appears.

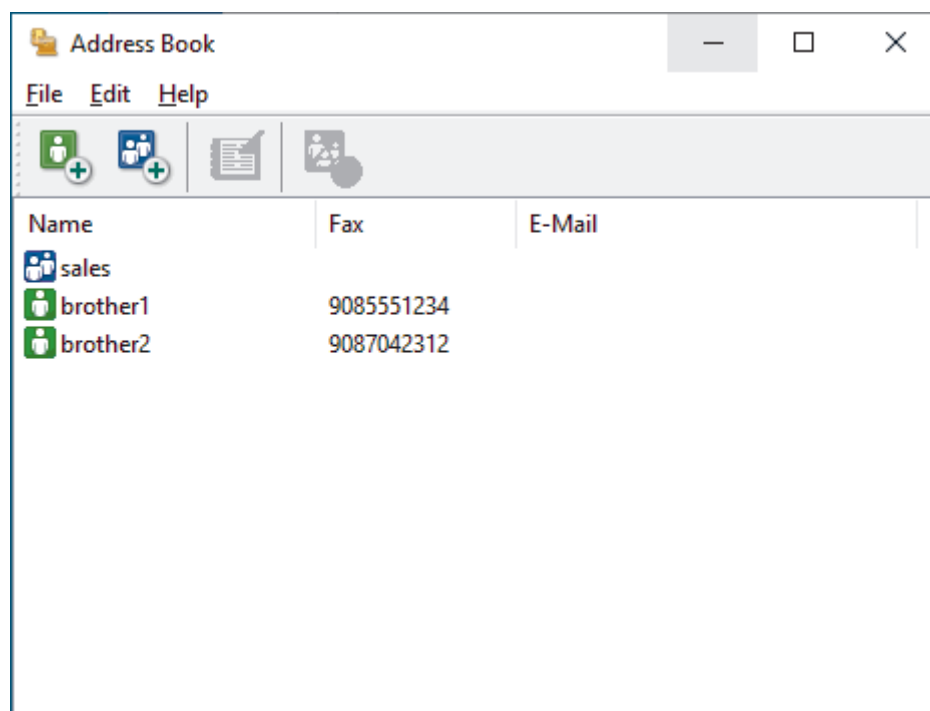

3. Click .
- The **Address Book Member Setup** dialog box appears.
4. Type the member's information in the corresponding fields. Only the **Name** field is required.
5. Click **OK**.

✓ Related Information

- [Configure your PC-Fax Address Book \(Windows\)](#)

Create a Group in your PC-FAX Address Book (Windows)

Related Models: MFC-J1010DW

Create a group to broadcast the same PC-FAX to several recipients at one time.

1. Launch  (**Brother Utilities**), and then click the drop-down list and select your model name (if not already selected).
2. Click **PC-FAX** in the left navigation bar, and then click **Address Book (Send)**.

The **Address Book** dialog box appears.

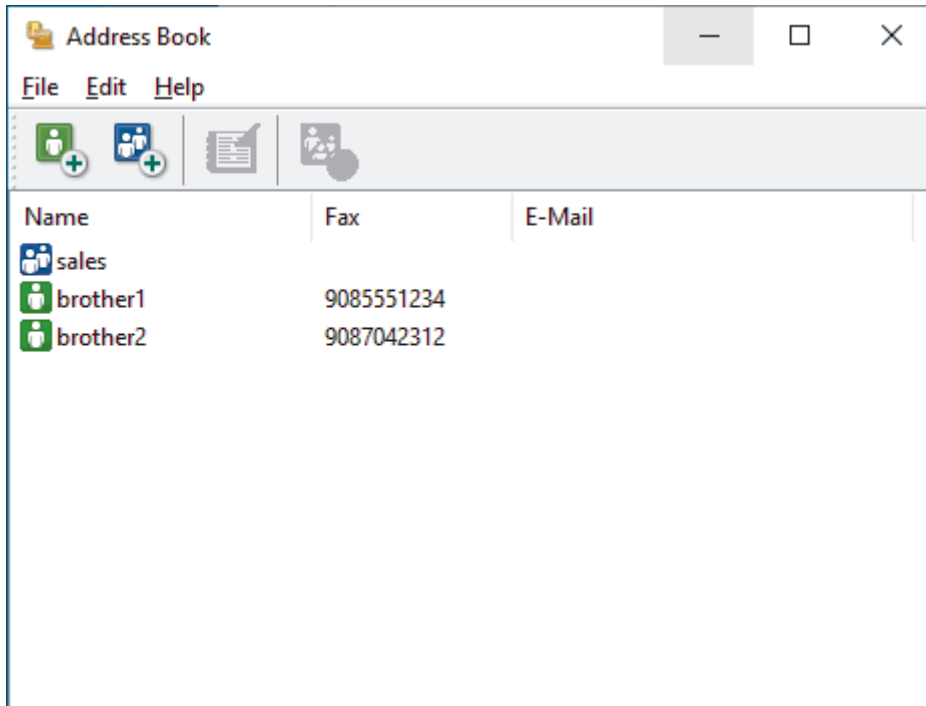

3. Click .

The **Address Book Group Setup** dialog box appears.

4. Type the name of the new group in the **Group Name** field.
5. In the **Available Names** field, select each name you want to include in the group, and then click **Add >>**.

Members added to the group appear in the **Group Members** box.

6. When finished, click **OK**.



Each group can contain up to 50 members.



Related Information

- [Configure your PC-Fax Address Book \(Windows\)](#)

Edit Member or Group Information in your PC-FAX Address Book (Windows)

Related Models: MFC-J1010DW

1. Launch  (**Brother Utilities**), and then click the drop-down list and select your model name (if not already selected).
2. Click **PC-FAX** in the left navigation bar, and then click **Address Book (Send)**.
The **Address Book** dialog box appears.

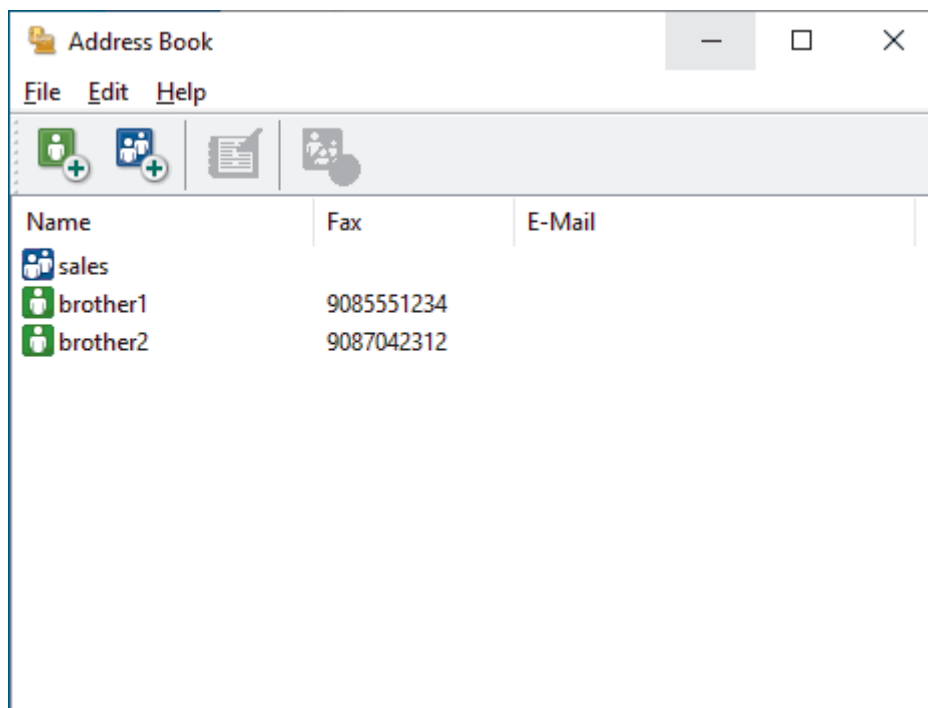

3. Select the member or group you want to edit.
4. Click  (**Properties**).
5. Change the member or group information.
6. Click **OK**.

Related Information

- [Configure your PC-Fax Address Book \(Windows\)](#)

Delete a Member or Group in your PC-FAX Address Book (Windows)

Related Models: MFC-J1010DW

1. Launch  (**Brother Utilities**), and then click the drop-down list and select your model name (if not already selected).
2. Click **PC-FAX** in the left navigation bar, and then click **Address Book (Send)**.
The **Address Book** dialog box appears.

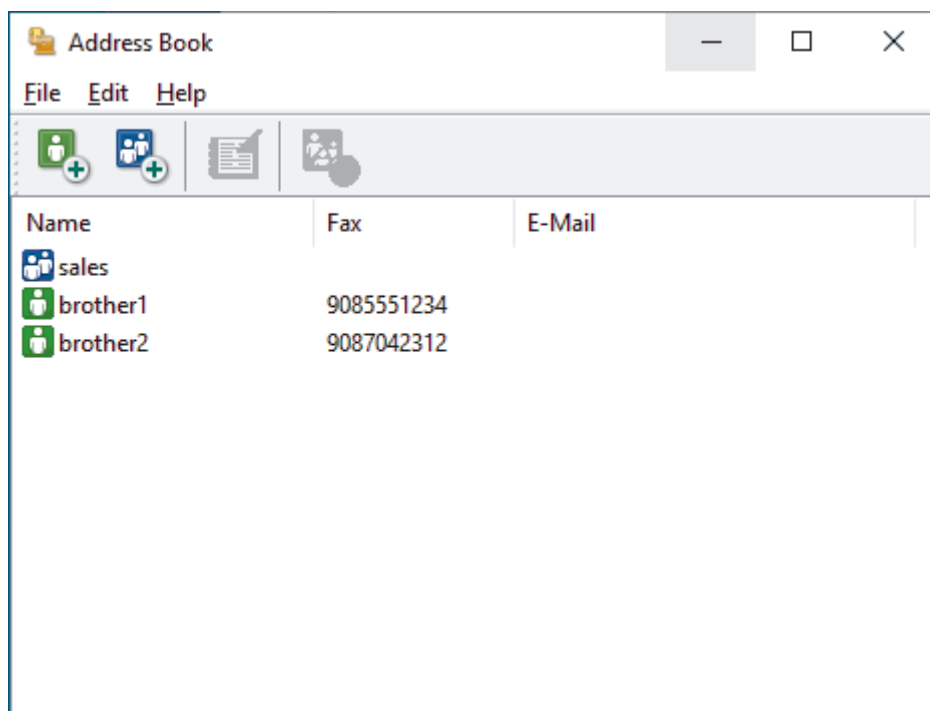

3. Select the member or group you want to delete.
4. Click  (**Delete**).
5. When the confirmation dialog box appears, click **OK**.

Related Information

- [Configure your PC-Fax Address Book \(Windows\)](#)

Export your PC-FAX Address Book (Windows)

Related Models: MFC-J1010DW

You can export the Address Book as an ASCII text file (*.csv) or a vCard (an electronic business card) and save it on your computer.

- You cannot export the group settings when you export the **Address Book** data.

- Launch  (**Brother Utilities**), and then click the drop-down list and select your model name (if not already selected).
- Click **PC-FAX** in the left navigation bar, and then click **Address Book (Send)**.

The **Address Book** dialog box appears.

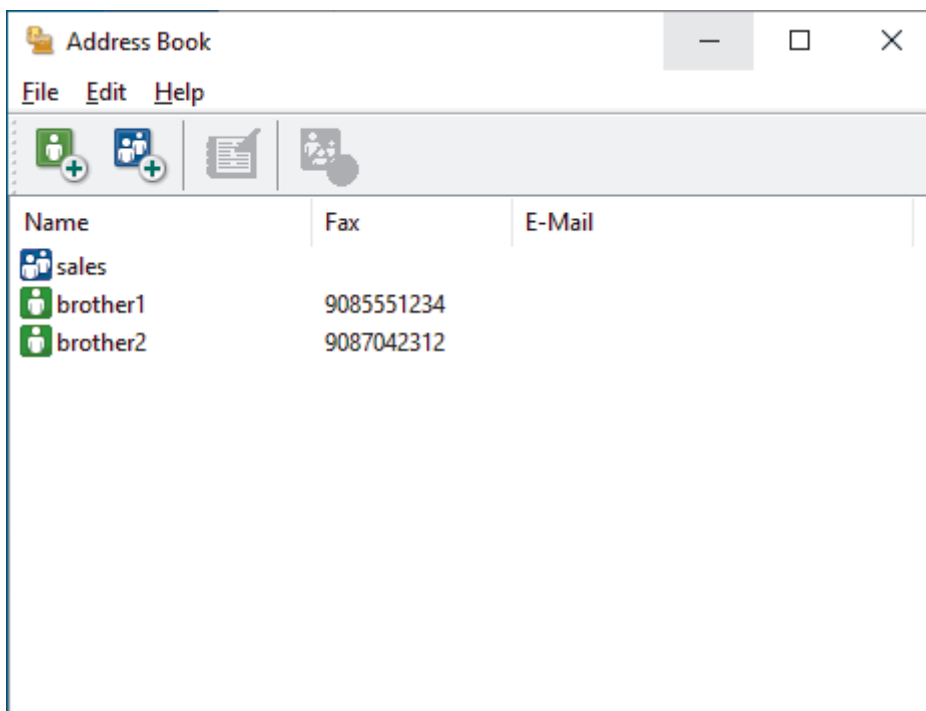

- Click **File > Export**.
- Select one of the following:
 - Text**
The **Select Items** dialog box appears. Go to the next step.
 - vCard**
You must select the member you want to export from your address book before selecting this option.
Browse to the folder where you want to save the vCard, type the vCard name in the **File name** field, and then click **Save**.
- In the **Available Items** field, select the data you want to export, and then click **Add >>**.



Select and add the items in the order you want them listed.

- If you are exporting to an ASCII file, under the **Divide Character** section, select the **Tab** or **Comma** option to separate the data fields.
- Click **OK**.
- Browse to the folder on your computer where you want to save the data, type the file name, and then click **Save**.



Related Information

- [Configure your PC-Fax Address Book \(Windows\)](#)
-

Import Information to your PC-FAX Address Book (Windows)

Related Models: MFC-J1010DW

You can import ASCII text files (*.csv) or vCards (electronic business cards) into your Address Book.

1. Launch  (**Brother Utilities**), and then click the drop-down list and select your model name (if not already selected).
2. Click **PC-FAX** in the left navigation bar, and then click **Address Book (Send)**.

The **Address Book** dialog box appears.

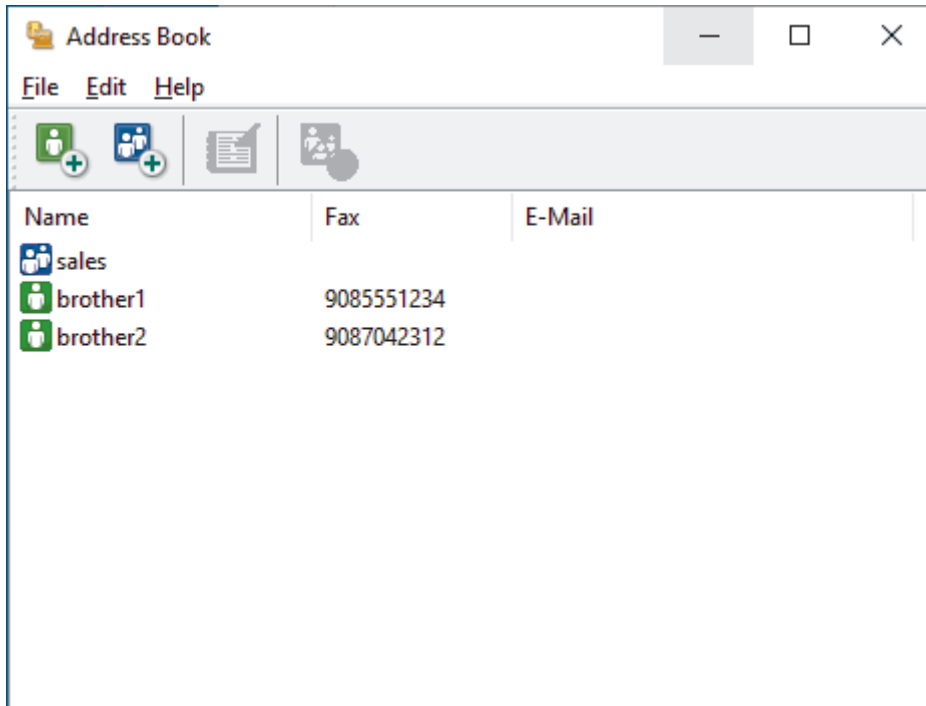

3. Click **File > Import**.
4. Select one of the following:
 - **Text**
The **Select Items** dialog box appears. Go to step 5.
 - **vCard**
Go to step 8.
5. In the **Available Items** field, select the data you want to import, and then click **Add >>**.



You must select and add fields from the **Available Items** list in the same order they are listed in the import text file.

6. If you are importing an ASCII file, under the **Divide Character** section, select the **Tab** or **Comma** option to separate the data fields.
7. Click **OK**.
8. Browse to the folder where you want to import the data, type the file name, and then click **Open**.



Related Information

- [Configure your PC-Fax Address Book \(Windows\)](#)

Send a Fax Using PC-FAX (Windows)

Related Models: MFC-J1010DW

PC-FAX supports only monochrome faxes. A monochrome fax will be sent even if the original data is colour and the receiving fax machine supports colour faxes.

1. Create a file in any application on your computer.
2. Select the print command in your application.
3. Select **Brother PC-FAX** as your printer, and then complete your print operation.

The **Brother PC-FAX** dialog box appears.

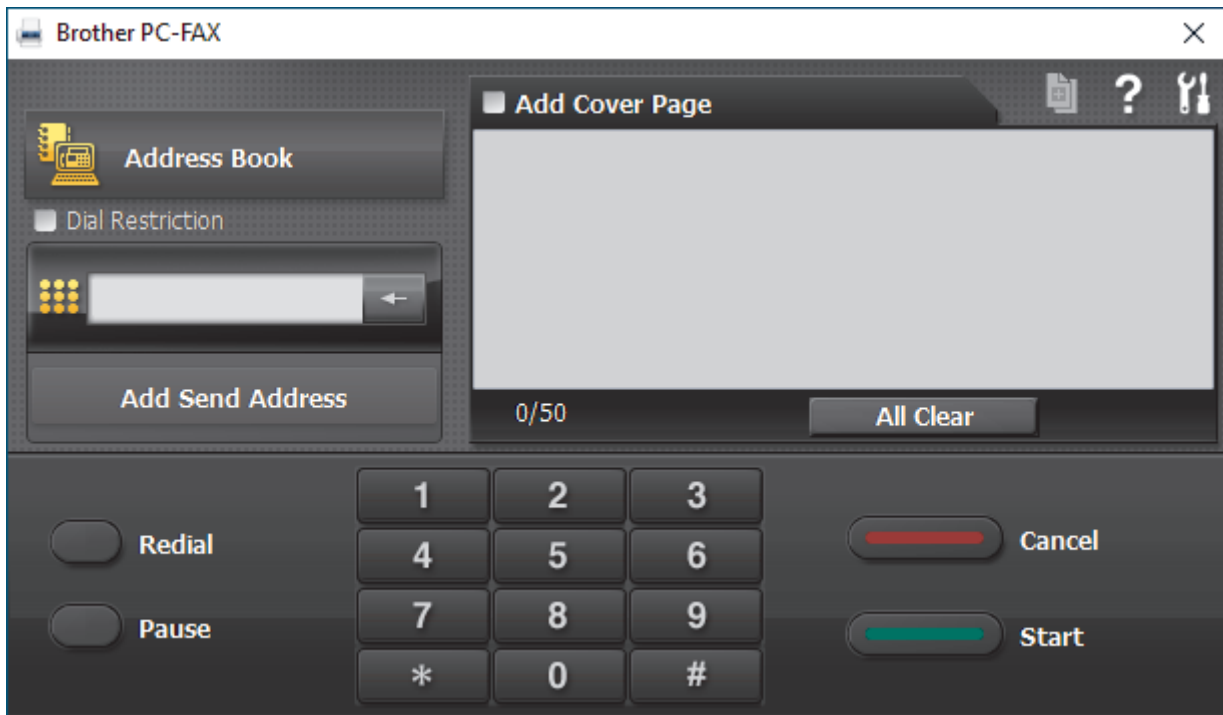

4. Type a fax number using one of the following methods:
 - Click the numbers on the dial pad to type the number, and then click **Add Send Address**.



If you select the **Dial Restriction** check box, a confirmation dialog box will appear for you to re-type the fax number using the keyboard. This feature helps to prevent transmissions to the wrong destination.

- Click the **Address Book** button, and then select a member or group from the Address Book.



If you make a mistake, click **All Clear** to delete all entries.

5. To include a cover page, select the **Add Cover Page** check box. You can also click  to create or edit a cover page.
6. Click **Start** to send the fax.



- To cancel the fax, click **Cancel**.
- To redial a number, click **Redial** to show the last five fax numbers, select a number, and then click **Start**.



Related Information

- [PC-FAX for Windows](#)

Receive Faxes on Your Computer (Windows)

Related Models: MFC-J1010DW

Use the Brother PC-FAX software to receive faxes on your computer, screen them and print only those faxes you want.

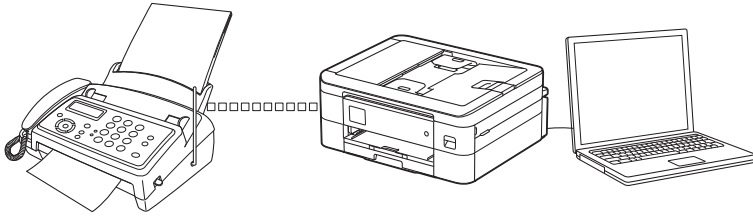

- [Receive Faxes Using PC-FAX Receive \(Windows\)](#)

Receive Faxes Using PC-FAX Receive (Windows)

Related Models: MFC-J1010DW

The Brother PC-FAX Receive software lets you view and store faxes on your computer. It is automatically installed when you install your machine's software and drivers and works on locally or network-connected machines.

- PC-FAX Receive supports only monochrome faxes. When you receive a colour fax, your machine prints the colour fax at your machine but does not send the fax to your computer.

When you turn off your computer, your machine will continue to receive and store faxes in your machine's memory. The machine's LCD will display the number of stored faxes received. When you start this application, the software will transfer all received faxes to your computer at once. You can enable the Backup Print option if you want the machine to print a copy of the fax before the fax is sent to your computer, or before the computer is switched off. You can configure the Backup Print settings from your machine.



Related Information

- [Receive Faxes on Your Computer \(Windows\)](#)
 - [Run the Brother PC-FAX Receive on Your Computer \(Windows\)](#)
 - [View Received PC-FAX Messages \(Windows\)](#)

Related Topics:

- [Use PC-Fax Receive to Transfer Received Faxes to Your Computer \(Windows only\)](#)

Run the Brother PC-FAX Receive on Your Computer (Windows)

Related Models: MFC-J1010DW



We recommend selecting the **Start PC-FAX Receive on computer startup** check box so that the software runs automatically and can transfer any faxes upon computer startup.

1. Launch  (**Brother Utilities**), and then click the drop-down list and select your model name (if not already selected).
2. Click **PC-FAX** in the left navigation bar, and then click **Receive**.
3. Confirm the message and click **Yes**.

The **PC-FAX Receive** window appears. The  (**PC-FAX Receive**) icon also appears in your computer task tray.



Related Information

- [Receive Faxes Using PC-FAX Receive \(Windows\)](#)
 - [Set Up Your Computer for PC-FAX Receiving \(Windows\)](#)
 - [Add Your Machine to PC-FAX Receiving \(Windows\)](#)

Set Up Your Computer for PC-FAX Receiving (Windows)

Related Models: MFC-J1010DW

1. Double-click the  (**PC-FAX Receive**) icon in your computer task tray.
The **PC-FAX Receive** window appears.
2. Click **Settings**.
3. Configure these options as needed:

Preferences

Configure to start PC-FAX Receive automatically when you start Windows.

Save

Configure the path to save PC-FAX files and select the received document format.

Upload to

Configure the path to the server and select the option to upload automatically or manually (available only for Administrators).

Device

Select the machine where you want to receive PC-FAX files.

Lock (available only for Administrators)

Restrict users who do not have administrator privileges from configuring the settings options shown above.

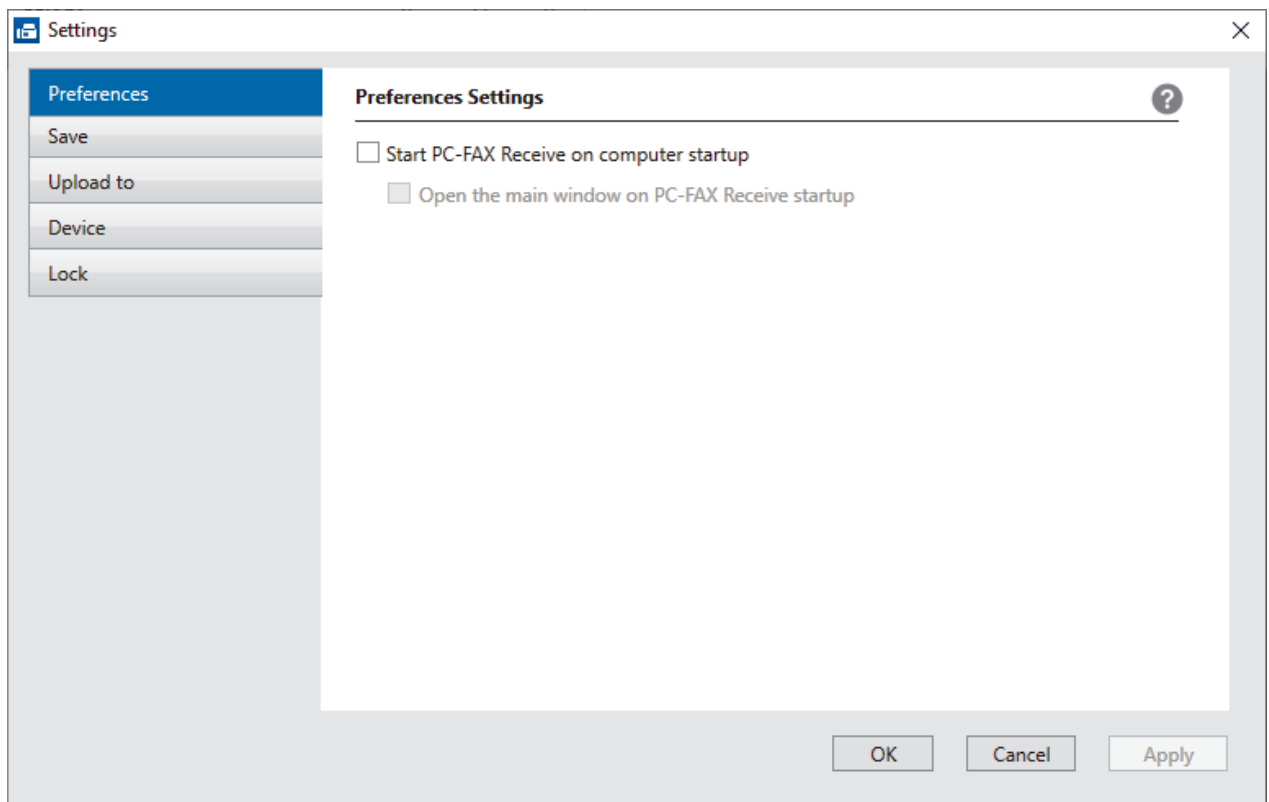

4. Click **OK**.



Related Information

- [Run the Brother PC-FAX Receive on Your Computer \(Windows\)](#)

Add Your Machine to PC-FAX Receiving (Windows)

Related Models: MFC-J1010DW

- If you installed the machine following the instructions for a network user, then the machine should already be configured for your network.

- Double-click the  (**PC-FAX Receive**) icon in your computer task tray.
The **PC-FAX Receive** window appears.
- Click **Settings**.
- Click **Device > Add**.

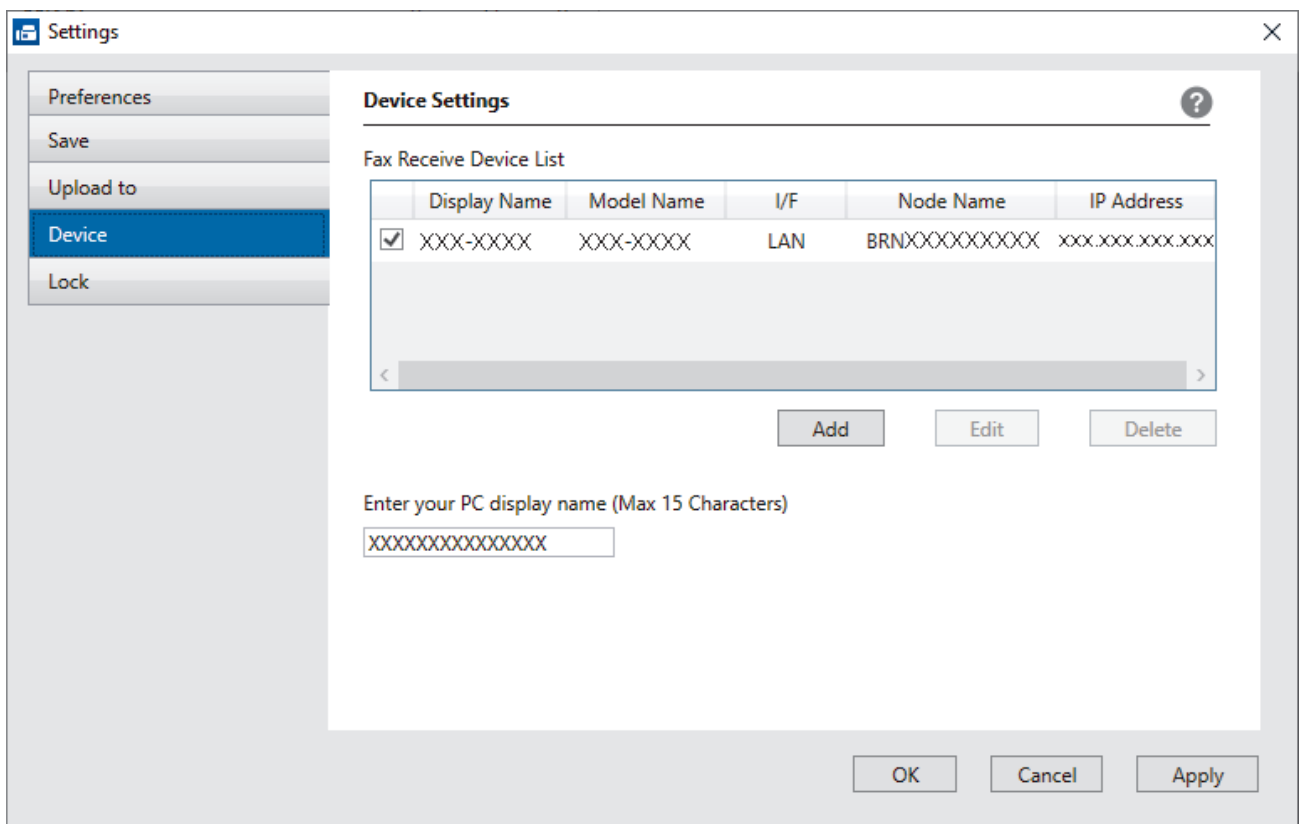

- Select the appropriate connection method.
Select your machine from the automatic search results below.
A list of connected machines appears. Select the machine you want. Click **OK**.
Specify your machine by IP address
Type the machine's IP address in the **IP Address** field, and then click **OK**.
- To change the computer name that will appear on the machine's LCD, type the new name in the **Enter your PC display name (Max 15 Characters)** field.
- Click **OK**.



Related Information

- [Run the Brother PC-FAX Receive on Your Computer \(Windows\)](#)

View Received PC-FAX Messages (Windows)

Related Models: MFC-J1010DW

Receiving Status

Icon	Indicated Status
	Standby mode No unread messages
	Receiving messages
	Messages received Unread messages

1. Double-click the  (PC-FAX Receive) icon in your computer task tray.

The **PC-FAX Receive** window appears.

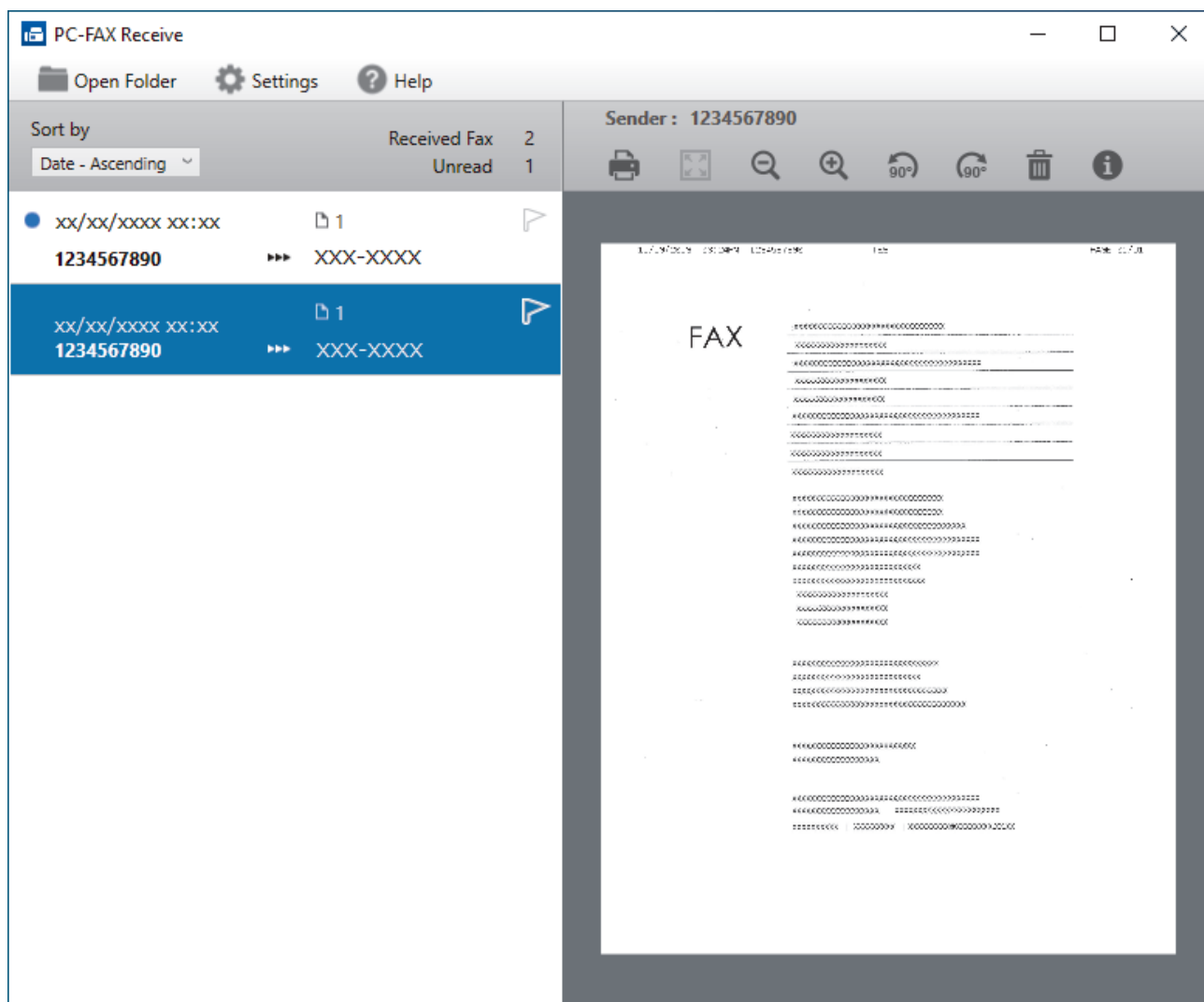

2. Click any faxes in the list to view them.
3. When finished, close the window.



Even after closing the window, PC-FAX Receive is active and the  (PC-FAX Receive) icon will remain in your computer task tray. To close PC-FAX Receive, click the icon in the computer task tray and click **Close**.



Related Information

- [Receive Faxes Using PC-FAX Receive \(Windows\)](#)
-

PC-FAX for Mac

Related Models: MFC-J1010DW

- [Send a Fax Using AirPrint \(macOS\)](#)

Network

- [Supported Basic Network Features](#)
- [Configure Network Settings](#)
- [Wireless Network Settings](#)
- [Network Features](#)
- [Brother Management Tools](#)

Supported Basic Network Features

The print server supports various features depending on the operating system. Use this table to see which network features and connections are supported by each operating system.

Operating Systems	Windows	Windows Server	macOS
Printing	Yes	Yes	Yes
Scanning	Yes	No	Yes
PC Fax Send (MFC-J1010DW)	Yes	No	Yes
PC Fax Receive (MFC-J1010DW)	Yes	No	No
Web Based Management ¹	Yes	Yes	Yes
Status Monitor	Yes	No	No
Driver Deployment Wizard	Yes	Yes	No

¹ The default password to manage this machine's settings is located on the back of the machine and marked "Pwd". We recommend immediately changing the default password to protect your machine from unauthorised access.



When connecting your machine to an outside network such as the Internet, make sure your network environment is protected by a separate firewall or other means in order to prevent information leaks due to inadequate settings or unauthorised access by malicious third parties.



Related Information

- [Network](#)

Related Topics:

- [Set or Change a Login Password for Web Based Management](#)

Configure Network Settings

- [Configure Network Settings Using the Control Panel](#)
- [Change Machine Settings Using Web Based Management](#)

Configure Network Settings Using the Control Panel

To configure the machine for your network, use the control panel's [Network] menu selections.



- For information about the network settings you can configure using the control panel, see *Related Information: Settings Tables*.
- You can also use management utilities, such as Web Based Management, to configure and change your Brother machine's network settings.

>> [DCP-J1050DW/MFC-J1010DW](#)

>> [DCP-J1140DW](#)

DCP-J1050DW/MFC-J1010DW

1. Press **Settings**.
2. Press **▲** or **▼** to display [Network], and then press **OK**.
3. Press **▲** or **▼** to display the network option, and then press **OK**. Repeat this step until you access the menu you want to configure, and then follow the LCD instructions.

DCP-J1140DW

1. Press  [Settings] > [Network].
2. Press **▲** or **▼** to display the network option, and then press it. Repeat this step until you access the menu you want to configure, and then follow the touchscreen LCD instructions.

✓ Related Information

- [Configure Network Settings](#)

Related Topics:

- [Settings Tables \(1.8"\(44.9 mm\) Colour LCD\)](#)
- [Settings Tables \(2.7"\(67.5 mm\) Touchscreen models\)](#)

Wireless Network Settings

- [Use the Wireless Network](#)
- [Use Wi-Fi Direct[®]](#)
- [Enable/Disable Wireless LAN](#)
- [Print the WLAN Report](#)

Use the Wireless Network

- [Before Configuring Your Machine for a Wireless Network](#)
- [Configure Your Machine for a Wireless Network Using the Setup Wizard from Your Computer](#)
- [Configure Your Machine for a Wireless Network Using the Setup Wizard from Your Mobile Device](#)
- [Configure Your Machine for a Wireless Network Using the Machine's Control Panel Setup Wizard](#)
- [Configure Your Machine for a Wireless Network Using the One Push Method of Wi-Fi Protected Setup™ \(WPS\)](#)
- [Configure Your Machine for a Wireless Network Using the PIN Method of Wi-Fi Protected Setup™ \(WPS\)](#)
- [Configure Your Machine for a Wireless Network When the SSID is Not Broadcast](#)
- [Configure Your Machine for an Enterprise Wireless Network](#)

Before Configuring Your Machine for a Wireless Network

Before attempting to configure a wireless network, confirm the following:

- If you are using an enterprise wireless network, you must know the User ID and Password.
- To achieve optimum results with normal everyday document printing, place your machine as close to the wireless LAN access point/router as possible with minimal obstructions. Large objects and walls between the two devices and interference from other electronic devices can affect the data transfer speed of your documents.

Due to these factors, wireless may not be the best method of connection for all types of documents and applications. If you are printing large files, such as multi-page documents with mixed text and large graphics, you may want to consider selecting USB for the fastest print speed.

- If there is a signal in the vicinity, wireless LAN allows you to freely make a LAN connection. However, if security settings are not correctly configured, the signal may be intercepted by malicious third-parties, possibly resulting in:
 - Theft of personal or confidential information
 - Improper transmission of information to parties impersonating the specified individuals
 - Dissemination of transcribed communication contents that were intercepted



Make sure you know your wireless router/access point's Network Name (SSID) and Network Key (Password). If you cannot find this information, consult the manufacturer of your wireless router/access point, your system administrator, or Internet provider. Brother cannot provide this information.



Related Information

- [Use the Wireless Network](#)

Configure Your Machine for a Wireless Network Using the Setup Wizard from Your Computer

1. Do one of the following:
 - Windows
Download the installer from your model's **Downloads** page at support.brother.com.
 - Mac
 - a. Download the installer from your model's **Downloads** page at support.brother.com.
 - b. Start the installer, and then double-click the **Start Here Mac** icon.
2. Follow the on-screen instructions.
3. Select **Wireless Network Connection (Wi-Fi)**, and then click **Next**.
4. Follow the on-screen instructions.

You have completed the wireless network setup.



Related Information

- [Use the Wireless Network](#)

Configure Your Machine for a Wireless Network Using the Setup Wizard from Your Mobile Device

1. Do one of the following:
 - Android™ devices
Download and install Brother Mobile Connect from Google Play™.
 - All iOS or iPadOS supported devices including iPhone, iPad and iPod touch
Download and install Brother Mobile Connect from the App Store.
2. Start Brother Mobile Connect, and then follow the on-screen instructions to connect your mobile device to your Brother machine.



Related Information

- [Use the Wireless Network](#)

Configure Your Machine for a Wireless Network Using the Machine's Control Panel Setup Wizard

>> [DCP-J1050DW/MFC-J1010DW](#)
>> [DCP-J1140DW](#)

DCP-J1050DW/MFC-J1010DW

Before configuring your machine, we recommend writing down your wireless network settings. You will need this information before you continue with the configuration.

1. Check and record the current wireless network settings of the computer to which you are connecting.

Network Name (SSID)

Network Key (Password)

For example:

Network Name (SSID)
HELLO

Network Key (Password)
12345



- Your access point/router may support the use of multiple WEP keys, however your Brother machine supports the use of the first WEP key only.
- If you need assistance during setup and want to contact Brother customer service, make sure you have your SSID (Network Name) and Network Key ready. We cannot assist you in locating this information.
- If you do not know this information (SSID and Network Key), you cannot continue the wireless setup.

How can I find this information?

- Check the documentation provided with your wireless access point/router.
- The initial SSID could be the manufacturer's name or the model name.
- If you do not know the security information, please consult the router manufacturer, your system administrator, or your Internet provider.

2. Press  or **WiFi** on the control panel.
3. Press **▲** or **▼** to select the [Find Wi-Fi Network] option, and then press **OK**.
4. When [Enable WLAN?] appears, press **▶**.
The wireless setup wizard starts. To cancel, press **◀**.
5. The machine searches for your network and displays a list of available SSIDs. When a list of SSIDs appears, press **▲** or **▼** to select the SSID you want. Press **OK**.
6. Do one of the following:
 - If you are using an authentication and encryption method that requires a Network Key, enter the Network Key you wrote down in the first step.
Enter the key, and then press **OK** to apply your settings.
 - If your authentication method is Open System and your encryption mode is None, go to the next step.
7. The machine attempts to connect to the wireless device you have selected.

When your wireless device connects successfully, the machine displays [Connected].

You have completed the wireless network setup. To install the drivers and software necessary to use your machine, go to your model's **Downloads** page at support.brother.com.

DCP-J1140DW

Before configuring your machine, we recommend writing down your wireless network settings. You will need this information before you continue with the configuration.

1. Check and record the current wireless network settings of the computer to which you are connecting.

Network Name (SSID)

Network Key (Password)

For example:

Network Name (SSID)
HELLO

Network Key (Password)
12345



- Your access point/router may support the use of multiple WEP keys, however your Brother machine supports the use of the first WEP key only.
- If you need assistance during setup and want to contact Brother customer service, make sure you have your SSID (Network Name) and Network Key ready. We cannot assist you in locating this information.
- If you do not know this information (SSID and Network Key), you cannot continue the wireless setup.

How can I find this information?

- Check the documentation provided with your wireless access point/router.
- The initial SSID could be the manufacturer's name or the model name.
- If you do not know the security information, please consult the router manufacturer, your system administrator, or your Internet provider.

2. Press  [Settings] > [Network] > [WLAN (Wi-Fi)] > [Find Wi-Fi Network].
3. When [Enable WLAN?] appears, press [Yes].
The wireless setup wizard starts. To cancel, press [No].
4. The machine searches for your network and displays a list of available SSIDs. When a list of SSIDs appears, press ▲ or ▼ to select the SSID you want. Press [OK].
5. Do one of the following:
 - If you are using an authentication and encryption method that requires a Network Key, enter the Network Key you wrote down in the first step.
Enter the key, and then press [OK] to apply your settings.
 - If your authentication method is Open System and your encryption mode is None, go to the next step.
6. The machine attempts to connect to the wireless device you have selected.

If your wireless device is connected successfully, the LCD displays [Connected].

You have completed the wireless network setup. To install the drivers and software necessary to use your machine, go to your model's **Downloads** page at support.brother.com.



Related Information

- [Use the Wireless Network](#)

Configure Your Machine for a Wireless Network Using the One Push Method of Wi-Fi Protected Setup™ (WPS)

If your wireless access point/router supports WPS (Push Button Configuration), you can use WPS from your machine's control panel menu to configure your wireless network settings.

>> [DCP-J1050DW/MFC-J1010DW](#)

>> [DCP-J1140DW](#)

DCP-J1050DW/MFC-J1010DW

1. Press  or **WiFi** on the control panel.
2. Press **▲** or **▼** to select the [WPS/Push Button] option, and then press **OK**.
3. When [Enable WLAN?] appears, press **▶**.
The wireless setup wizard starts. To cancel, press **◀**.
4. When the LCD instructs you to start WPS, press the WPS button on your wireless access point/router. Then press **▶** on your machine. Your machine automatically tries to connect to your wireless network.

When your wireless device connects successfully, the machine displays [Connected].

You have completed the wireless network setup. To install the drivers and software necessary to use your machine, go to your model's **Downloads** page at support.brother.com.

DCP-J1140DW

1. Press  [Settings] > [Network] > [WLAN (Wi-Fi)] > [WPS/Push Button].
2. When [Enable WLAN?] appears, press [Yes].
The wireless setup wizard starts. To cancel, press [No].
3. When the touchscreen instructs you to start WPS, press the WPS button on your wireless access point/router. Then press [OK] on your machine. Your machine automatically tries to connect to your wireless network.

If your wireless device is connected successfully, the LCD displays [Connected].

You have completed the wireless network setup. To install the drivers and software necessary to use your machine, go to your model's **Downloads** page at support.brother.com.

Related Information

- [Use the Wireless Network](#)

Configure Your Machine for a Wireless Network Using the PIN Method of Wi-Fi Protected Setup™ (WPS)

If your wireless LAN access point/router supports WPS, you can use the Personal Identification Number (PIN) Method to configure your wireless network settings.

The PIN Method is one of the connection methods developed by the Wi-Fi Alliance®. By submitting a PIN created by an Enrollee (your machine) to the Registrar (a device that manages the wireless LAN), you can set up the wireless network and security settings. For more information on how to access WPS mode, see the instructions provided with your wireless access point/router.

Type A

Connection when the wireless LAN access point/router (1) doubles as the Registrar.

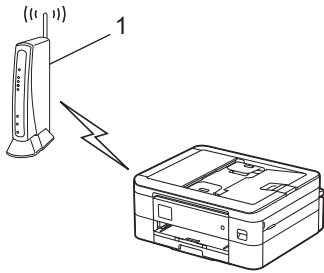

Type B

Connection when another device (2), such as a computer, is used as the Registrar.

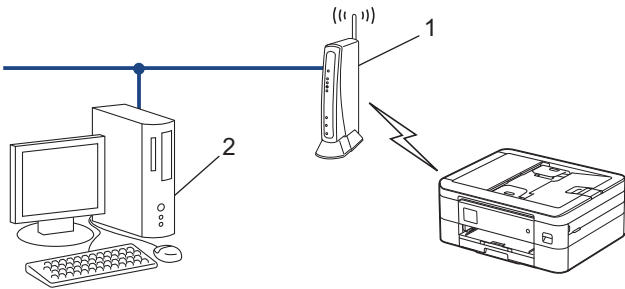

>> [DCP-J1050DW/MFC-J1010DW](#)

>> [DCP-J1140DW](#)

DCP-J1050DW/MFC-J1010DW

1. Press **Settings**.
2. Press **▲** or **▼** to make your selections:
 - a. Select [Network]. Press **OK**.
 - b. Select [WLAN (Wi-Fi)]. Press **OK**.
 - c. Select [WPS/PIN Code]. Press **OK**.
3. When [Enable WLAN?] appears, press **▶**.

The wireless setup wizard starts. To cancel, press **◀**.
4. The LCD displays an eight-digit PIN and the machine starts searching for a wireless LAN access point/router.
5. Using a computer connected to the network, in your browser's address bar, type the IP address of the device you are using as the Registrar. (For example: <http://192.168.1.2>)
6. Go to the WPS settings page and type the PIN, and then follow the on-screen instructions.



- The Registrar is usually the wireless LAN access point/router.
- The settings page may differ depending on the brand of wireless LAN access point/router. For more information, see the instructions supplied with your wireless LAN access point/router.

If you are using a Windows 7, Windows 8.1, or Windows 10 computer as a Registrar, complete the following steps:

7. Do one of the following:

- Windows 10

Click  > **Windows System** > **Control Panel**. In the **Hardware and Sound** group, click **Add a device**.

- Windows 8.1

Move your mouse to the lower right corner of your desktop. When the menu bar appears, click **Settings** > **Control Panel** > **Hardware and Sound** > **Devices and Printers** > **Add a device**.

- Windows 7

Click  (**Start**) > **Devices and Printers** > **Add a device**.



- To use a Windows 7, Windows 8.1, or Windows 10 computer as a Registrar, you must register it to your network in advance. For more information, see the instructions supplied with your wireless LAN access point/router.
- If you use Windows 7, Windows 8.1, or Windows 10 as a Registrar, you can install the printer driver after the wireless configuration by following the on-screen instructions. To install the driver and software necessary to use your machine, go to your model's **Downloads** page at support.brother.com.

8. Select your machine and click **Next**.

9. Type the PIN displayed on the machine's LCD, and then click **Next**.

10. (Windows 7) Select your network, and then click **Next**.

11. Click **Close**.

DCP-J1140DW

1. Press  [Settings] > [Network] > [WLAN (Wi-Fi)] > [WPS/PIN Code].

2. When [Enable WLAN?] appears, press [Yes].

The wireless setup wizard starts. To cancel, press [No].

3. The LCD displays an eight-digit PIN and the machine starts searching for a wireless LAN access point/router.

4. Using a computer connected to the network, in your browser's address bar, type the IP address of the device you are using as the Registrar. (For example: <http://192.168.1.2>)

5. Go to the WPS settings page and type the PIN, and then follow the on-screen instructions.



- The Registrar is usually the wireless LAN access point/router.
- The settings page may differ depending on the brand of wireless LAN access point/router. For more information, see the instructions supplied with your wireless LAN access point/router.

If you are using a Windows 7, Windows 8.1, or Windows 10 computer as a Registrar, complete the following steps:

6. Do one of the following:

- Windows 10

Click  > **Windows System** > **Control Panel**. In the **Hardware and Sound** group, click **Add a device**.

- Windows 8.1

Move your mouse to the lower right corner of your desktop. When the menu bar appears, click **Settings** > **Control Panel** > **Hardware and Sound** > **Devices and Printers** > **Add a device**.

- Windows 7

Click  (**Start**) > **Devices and Printers** > **Add a device**.



- To use a Windows 7, Windows 8.1, or Windows 10 computer as a Registrar, you must register it to your network in advance. For more information, see the instructions supplied with your wireless LAN access point/router.
- If you use Windows 7, Windows 8.1, or Windows 10 as a Registrar, you can install the printer driver after the wireless configuration by following the on-screen instructions. To install the driver and software necessary to use your machine, go to your model's **Downloads** page at support.brother.com.

7. Select your machine and click **Next**.
8. Type the PIN displayed on the machine's LCD, and then click **Next**.
9. (Windows 7) Select your network, and then click **Next**.
10. Click **Close**.



Related Information

- [Use the Wireless Network](#)
-

Configure Your Machine for a Wireless Network When the SSID is Not Broadcast

>> [DCP-J1050DW/MFC-J1010DW](#)
>> [DCP-J1140DW](#)

DCP-J1050DW/MFC-J1010DW

Before configuring your machine, we recommend writing down your wireless network settings. You will need this information before you continue with the configuration.

1. Check and write down the current wireless network settings.

Network Name (SSID)		
Authentication Method	Encryption Mode	Network Key (Password)
Open System	NONE	-
	WEP	
Shared Key	WEP	
WPA/WPA2-PSK	AES	
	TKIP	

For example:

Network Name (SSID)		
HELLO		
Authentication Method	Encryption Mode	Network Key (Password)
WPA2-PSK	AES	12345678



If your router uses WEP encryption, enter the key used as the first WEP key. Your Brother machine supports the use of the first WEP key only.

2. Press  or **WiFi** on the control panel.
3. Press **▲** or **▼** to select the [Find Wi-Fi Network] option, and then press **OK**.
4. When [Enable WLAN?] appears, press **▶**.
The wireless setup wizard starts. To cancel, press **◀**.
5. The machine will search for your network and display a list of available SSIDs. Press **▲** or **▼** to select the [<New SSID>] option, and then press **OK**.
6. Enter the SSID name, and then press **OK**.



For more information about how to enter text, see *Related Information*.

7. Select the Authentication Method, and then press **OK**.
8. Do one of the following:
 - If you selected the [Open System] option, press **▲** or **▼** to select the Encryption type [None] or [WEP], and then press **OK**.
If you selected the [WEP] option for Encryption type, enter the WEP key, and then press **OK**.
 - If you selected the [Shared Key] option, enter the WEP key, and then press **OK**.

- If you selected the [WPA/WPA2-PSK] option, press ▲ or ▼ to select the Encryption type [TKIP+AES] or [AES], and then press **OK**.

Enter the WPA key, and then press **OK**.



- For more information about how to enter text, see *Related Information*.
- Your Brother machine supports the use of the first WEP key only.

9. The machine attempts to connect to the wireless device you have selected.

If your wireless device is connected successfully, the machine's LCD displays [Connected].

You have completed the wireless network setup. To install the drivers and software necessary to use your machine, go to your model's **Downloads** page at support.brother.com.

DCP-J1140DW

Before configuring your machine, we recommend writing down your wireless network settings. You will need this information before you continue with the configuration.

1. Check and write down the current wireless network settings.

Network Name (SSID)		
Authentication Method	Encryption Mode	Network Key (Password)
Open System	NONE	-
	WEP	
Shared Key	WEP	
WPA/WPA2-PSK	AES	
	TKIP	

For example:

Network Name (SSID)		
HELLO		
Authentication Method	Encryption Mode	Network Key (Password)
WPA2-PSK	AES	12345678



If your router uses WEP encryption, enter the key used as the first WEP key. Your Brother machine supports the use of the first WEP key only.

2. Press  [Settings] > [Network] > [WLAN (Wi-Fi)] > [Find Wi-Fi Network].
3. When [Enable WLAN?] appears, press [Yes].
The wireless setup wizard starts. To cancel, press [No].
4. The machine searches for your network and displays a list of available SSIDs. Press ▲ or ▼ to display the [<New SSID>] option, and then press it.
5. Press [OK].
6. Enter the SSID name, and then press [OK].



For more information about how to enter text, see *Related Information*.

7. Select the Authentication Method, and then press it.
8. Do one of the following:

-
- If you selected the [Open System] option, press either [None] or [WEP].
If you selected the [WEP] option for Encryption type, enter the WEP key, and then press [OK].
 - If you selected the [Shared Key] option, enter the WEP key, and then press [OK].
 - If you selected the [WPA/WPA2-PSK] option, press either [TKIP+AES] or [AES].
Enter the WPA key, and then press [OK].



-
- For more information about how to enter text, see *Related Information*.
 - Your Brother machine supports the use of the first WEP key only.
-

9. The machine attempts to connect to the wireless device you have selected.

If your wireless device is connected successfully, the LCD displays [Connected].

You have completed the wireless network setup. To install the drivers and software necessary to use your machine, go to your model's **Downloads** page at support.brother.com.



Related Information

- [Use the Wireless Network](#)

Related Topics:

- [If You Are Having Difficulty with Your Machine's Network](#)
 - [Enter Text on Your Brother Machine](#)
-

Configure Your Machine for an Enterprise Wireless Network

- >> [DCP-J1050DW/MFC-J1010DW](#)
- >> [DCP-J1140DW](#)

DCP-J1050DW/MFC-J1010DW

Before configuring your machine, we recommend writing down your wireless network settings. You will need this information before you continue with the configuration.

1. Check and record the current wireless network settings.

Network Name (SSID)

Authentication Method	Encryption Mode	User ID	Password
EAP-FAST/NONE	AES		
	TKIP		
EAP-FAST/MS-CHAPv2	AES		
	TKIP		
EAP-FAST/GTC	AES		
	TKIP		
PEAP/MS-CHAPv2	AES		
	TKIP		
PEAP/GTC	AES		
	TKIP		
EAP-TTLS/CHAP	AES		
	TKIP		
EAP-TTLS/MS-CHAP	AES		
	TKIP		
EAP-TTLS/MS-CHAPv2	AES		
	TKIP		
EAP-TTLS/PAP	AES		
	TKIP		
EAP-TLS	AES		-
	TKIP		-

For example:

Network Name (SSID)
HELLO

Authentication Method	Encryption Mode	User ID	Password
EAP-FAST/MS-CHAPv2	AES	Brother	12345678



- If you configure your machine using EAP-TLS authentication, you must install the client certificate issued by a CA before you start configuration. Contact your network administrator about the client certificate. If you have installed more than one certificate, we recommend writing down the certificate name you want to use.
- If you verify your machine using the common name of the server certificate, we recommend writing down the common name before you start configuration. Contact your network administrator about the common name of the server certificate.

2. Press  or **WiFi** on the control panel.
3. Press **▲** or **▼** to select the [Find Wi-Fi Network] option, and then press **OK**.
4. When [Enable WLAN?] appears, press **►**.
The wireless setup wizard starts. To cancel, press **◀**.
5. The machine will search for your network and display a list of available SSIDs. Press **▲** or **▼** to select the [<New SSID>] option, and then press **OK**.
6. Enter the SSID name, and then press **OK**.



For more information about how to enter text, see *Related Information*.

7. Select the Authentication Method, and then press **OK**.
8. Do one of the following:
 - If you selected the [EAP-FAST], [PEAP] or [EAP-TTLS] option, select the Inner Authentication method [NONE], [CHAP], [MS-CHAP], [MS-CHAPv2], [GTC] or [PAP], and then press **OK**.



Depending on your Authentication method, the Inner Authentication method selections differ.

Select the encryption type [TKIP+AES] or [AES], and then press **OK**.

Select the verification method [No Verification], [CA] or [CA + Server ID], and then press **OK**.

- If you selected the [CA + Server ID] option, enter the server ID, user ID and password (if required), and then press **OK** for each option.
- For other selections, enter the user ID and Password, and then press **OK** for each option.



If you have not imported a CA certificate into your machine, the machine displays [No Verification].

- If you selected the [EAP-TLS] option, select the encryption type [TKIP+AES] or [AES], and then press **OK**.

The machine will display a list of available Client Certificates, and then select the certificate.

Select the verification method [No Verification], [CA] or [CA + Server ID], and then press **OK**.

- If you selected the [CA + Server ID] option, enter the server ID and user ID, and then press **OK** for each option.
- For other selections, enter the user ID, and then press **OK**.

9. The machine attempts to connect to the wireless device you have selected.

If your wireless device is connected successfully, the machine's LCD displays [Connected].

You have completed the wireless network setup. To install the drivers and software necessary to use your machine, go to your model's **Downloads** page at support.brother.com.

DCP-J1140DW

Before configuring your machine, we recommend writing down your wireless network settings. You will need this information before you continue with the configuration.

1. Check and record the current wireless network settings.

Network Name (SSID)			
Authentication Method	Encryption Mode	User ID	Password
EAP-FAST/NONE	AES		
	TKIP		
EAP-FAST/MS-CHAPv2	AES		
	TKIP		
EAP-FAST/GTC	AES		
	TKIP		
PEAP/MS-CHAPv2	AES		
	TKIP		
PEAP/GTC	AES		
	TKIP		
EAP-TTLS/CHAP	AES		
	TKIP		
EAP-TTLS/MS-CHAP	AES		
	TKIP		
EAP-TTLS/MS-CHAPv2	AES		
	TKIP		
EAP-TTLS/PAP	AES		
	TKIP		
EAP-TLS	AES		-
	TKIP		-

For example:

Network Name (SSID)			
HELLO			
Authentication Method	Encryption Mode	User ID	Password
EAP-FAST/MS-CHAPv2	AES	Brother	12345678



- If you configure your machine using EAP-TLS authentication, you must install the client certificate issued by a CA before you start configuration. Contact your network administrator about the client certificate. If you have installed more than one certificate, we recommend writing down the certificate name you want to use.
- If you verify your machine using the common name of the server certificate, we recommend writing down the common name before you start configuration. Contact your network administrator about the common name of the server certificate.

2. Press  [Settings] > [Network] > [WLAN (Wi-Fi)] > [Find Wi-Fi Network].
3. When [Enable WLAN?] appears, press [Yes].
The wireless setup wizard starts. To cancel, press [No].
4. The machine searches for your network and displays a list of available SSIDs. Press ▲ or ▼ to display the [<New SSID>] option, and then press it.
5. Press [OK].
6. Enter the SSID name, and then press [OK].



For more information about how to enter text, see *Related Information*.

7. Select the Authentication Method, and then press it.

8. Do one of the following:

- If you selected the [EAP-FAST], [PEAP] or [EAP-TTLS] option, select the Inner Authentication method [NONE], [CHAP], [MS-CHAP], [MS-CHAPv2], [GTC] or [PAP].



Depending on your Authentication method, the Inner Authentication method selections differ.

Select the encryption type [TKIP+AES] or [AES].

Select the verification method [No Verification], [CA] or [CA + Server ID].

- If you selected the [CA + Server ID] option, enter the server ID, user ID and password (if required), and then press [OK] for each option.
- For other selections, enter the user ID and Password, and then press [OK] for each option.



If you have not imported a CA certificate into your machine, the machine displays [No Verification].

- If you selected the [EAP-TLS] option, select the encryption type [TKIP+AES] or [AES].

The machine will display a list of available Client Certificates, and then select the certificate.

Select the verification method [No Verification], [CA] or [CA + Server ID].

- If you selected the [CA + Server ID] option, enter the server ID and user ID, and then press [OK] for each option.
- For other selections, enter the user ID, and then press [OK].

9. The machine attempts to connect to the wireless device you have selected.

If your wireless device is connected successfully, the LCD displays [Connected].

You have completed the wireless network setup. To install the drivers or your application necessary for operating your device, go to your model's **Downloads** page at support.brother.com.



Related Information

- [Use the Wireless Network](#)

Related Topics:

- [Enter Text on Your Brother Machine](#)
-

Use Wi-Fi Direct®

- [Wi-Fi Direct Overview](#)
- [Configure Your Wi-Fi Direct Network Using the Push Button Method](#)
- [Configure a Wi-Fi Direct Network Manually](#)
- [If You Are Having Difficulty with Your Machine's Network](#)

Wi-Fi Direct Overview

Wi-Fi Direct is one of the wireless configuration methods developed by the Wi-Fi Alliance®. It allows you to securely connect your mobile device to your Brother machine without using a wireless router/access point.

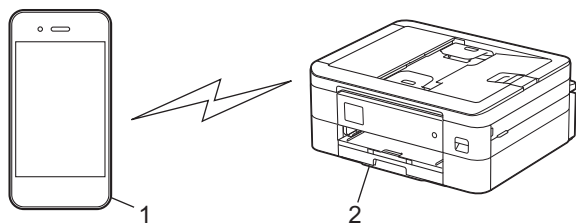

1. Mobile device
2. Your Brother machine



- You can use Wi-Fi Direct with either the wired or wireless network connection at the same time.
- The Wi-Fi Direct supported device can become a Group Owner. When configuring the Wi-Fi Direct network, the Group Owner serves as an access point.

✓ Related Information

- [Use Wi-Fi Direct®](#)

Related Topics:

- [Configure Your Wi-Fi Direct Network Using the Push Button Method](#)
- [Configure a Wi-Fi Direct Network Manually](#)

Configure Your Wi-Fi Direct Network Using the Push Button Method

>> [DCP-J1050DW/MFC-J1010DW](#)

>> [DCP-J1140DW](#)

DCP-J1050DW/MFC-J1010DW



When a machine receives the Wi-Fi Direct request from your mobile device, the message [Wi-Fi Direct connection request received.] appears on the LCD. Press ► to connect.

1. Press **Settings**.
2. Press ▲ or ▼ to select the following:
 - a. Select [Network]. Press **OK**.
 - b. Select [Wi-Fi Direct]. Press **OK**.
 - c. If your mobile device does not support Wi-Fi Direct, do the following:
 - i. Select [Group Owner]. Press **OK**.
 - ii. Select [On]. Press **OK**.
 - d. Press ▲ or ▼ to select [Push Button]. Press **OK**.
3. When the [Activate Wi-Fi Direct on other device.] message appears, turn your mobile device's Wi-Fi Direct function on (for more information, see your mobile device's user's guide). Press ► on your Brother machine.
4. Do one of the following:
 - If your mobile device displays a list of machines with Wi-Fi Direct enabled, select your Brother machine.
 - If your Brother machine displays a list of mobile devices with Wi-Fi Direct enabled, select your mobile device and press **OK**. To search for available devices again, select [Rescan].
5. When your wireless device connects successfully, the machine displays [Connected].

DCP-J1140DW



When the machine receives the Wi-Fi Direct request from your mobile device, the message [Wi-Fi Direct connection request received. Press [OK] to connect.] will appear on the LCD. Press [OK] to connect.

1. Press  [Settings] > [Network] > [Wi-Fi Direct].
2. If your mobile device does not support Wi-Fi Direct, press [Group Owner] > [On].
3. Press [Push Button].
4. When the [Activate Wi-Fi Direct on other device. Then Press [OK].] message appears, turn your mobile device's Wi-Fi Direct function on (for more information, see your mobile device's user's guide). Press [OK] on your Brother machine.
5. Do one of the following:
 - If your mobile device displays a list of machines with Wi-Fi Direct enabled, select your Brother machine.
 - If your Brother machine displays a list of mobile devices with Wi-Fi Direct enabled, select your mobile device. To search for available devices again, press [Rescan].

When your mobile device connects successfully, the machine displays [Connected].



Related Information

- [Use Wi-Fi Direct®](#)

Related Topics:

- [Wi-Fi Direct Overview](#)
 - [Configure a Wi-Fi Direct Network Manually](#)
-

Configure a Wi-Fi Direct Network Manually

Configure the Wi-Fi Direct setting from the machine's control panel.

>> [DCP-J1050DW/MFC-J1010DW](#)

>> [DCP-J1140DW](#)

DCP-J1050DW/MFC-J1010DW

1. Press **Settings**.
2. Press **▲** or **▼** to make your selections:
 - a. Select [Network]. Press **OK**.
 - b. Select [Wi-Fi Direct]. Press **OK**.
 - c. Select [Manual]. Press **OK**.
3. The machine displays the SSID (Network Name) and Password (Network Key). Go to your mobile device's wireless network settings screen, and enter the SSID and password.
4. When your wireless device connects successfully, the machine displays [Connected].

DCP-J1140DW

1. Press  [Settings] > [Network] > [Wi-Fi Direct] > [Manual].
2. The machine will display the SSID (Network Name) and Password (Network Key). Go to your mobile device's wireless network settings screen, select the SSID, and then enter the password.

When your mobile device connects successfully, the machine displays [Connected].

Related Information

- [Use Wi-Fi Direct®](#)

Related Topics:

- [Wi-Fi Direct Overview](#)
- [Configure Your Wi-Fi Direct Network Using the Push Button Method](#)

Enable/Disable Wireless LAN



>> [DCP-J1050DW/MFC-J1010DW](#)

>> [DCP-J1140DW](#)

DCP-J1050DW/MFC-J1010DW

1. Press **Settings**.
2. Press **▲** or **▼** to make your selections:
 - a. Select [Network]. Press **OK**.
 - b. Select [WLAN (Wi-Fi)]. Press **OK**.
 - c. Select [WLAN Enable]. Press **OK**.
 - d. Do one of the following:
 - To enable Wi-Fi, select [On]. Press **OK**.
 - To disable Wi-Fi, select [Off]. Press **OK**.

DCP-J1140DW

1. Press  [Settings] > [Network] > [WLAN (Wi-Fi)] > [WLAN Enable].
2. Do one of the following:
 - To enable Wi-Fi, select [On].
 - To disable Wi-Fi, select [Off].
3. Press .

Related Information

- [Wireless Network Settings](#)

Print the WLAN Report

The WLAN Report shows your machine's wireless status. If the wireless connection fails, check the error code on the printed report.

>> [DCP-J1050DW/MFC-J1010DW](#)

>> [DCP-J1140DW](#)

DCP-J1050DW/MFC-J1010DW

1. Press **Settings**.
2. Press **▲** or **▼** to select the [Print Reports] option, and then press **OK**.
3. Press **▲** or **▼** to select the [WLAN Report] option, and then press **OK**.
4. Press **▶**.

The machine will print the WLAN Report.

If the WLAN Report does not print, check your machine for errors. If there are no visible errors, wait for one minute and then try to print the report again.

DCP-J1140DW

1. Press  [Settings] > [All Settings] > [Print Reports] > [WLAN Report] > [Yes].

The machine will print the WLAN Report.

If the WLAN Report does not print, check your machine for errors. If there are no visible errors, wait for one minute and then try to print the report again.

Related Information

- [Wireless Network Settings](#)
 - [Wireless LAN Report Error Codes](#)

Related Topics:

- [If You Are Having Difficulty with Your Machine's Network](#)
- [Configure IEEE 802.1x Authentication for a Wired or a Wireless Network Using Web Based Management \(Web Browser\)](#)

Wireless LAN Report Error Codes

If the Wireless LAN Report shows that the connection failed, check the error code on the printed report and see the corresponding instructions in the table:

Error Code	Problem and Recommended Solutions
TS-01	<p>The WLAN (Wi-Fi) is not enabled.</p> <p>Check the following points and try to set up your wireless connection again:</p> <ul style="list-style-type: none">• Enable the WLAN setting on your machine.• If a network cable is connected to your machine, disconnect it.
TS-02	<p>The wireless router/access point cannot be detected.</p> <p>Check the following points and try to set up your wireless connection again:</p> <ul style="list-style-type: none">• Make sure the wireless router/access point is on.• Temporarily place your machine closer to the wireless router/access point when you are configuring the wireless settings.• If your wireless router/access point is using MAC address filtering, confirm that the MAC address of the machine is allowed in the filter. You can find the MAC address by printing the Network Configuration Report.• If you manually entered the Network Name (SSID) and security information (authentication method/encryption method), the information may be incorrect. Check the Network Name and security information again and re-enter the correct information.• Restart your wireless router/access point. If you cannot find the Network Name (SSID) and security information, see the documentation provided with your wireless router/access point, or contact the router manufacturer, your system administrator, or Internet service provider.
TS-03	<p>The wireless enterprise network and security settings you entered may be incorrect.</p> <p>Check the following points and try to set up your wireless connection again:</p> <ul style="list-style-type: none">• Verify the following information:<ul style="list-style-type: none">- Network Name (SSID) you selected to configure your machine.- Security information you selected to configure your machine (such as the authentication method, encryption method, or User ID). <p>If you still cannot find the Network Name (SSID) and security information, see the documentation provided with your wireless router/access point, or contact the router manufacturer, your system administrator, or Internet service provider.</p>
TS-04	<p>Your machine does not support the authentication and encryption methods used by the selected wireless router/access point.</p> <p>For infrastructure mode (Most common)</p> <p>Change the authentication and encryption methods of the wireless router/access point. Your machine supports the following authentication and encryption methods:</p> <ul style="list-style-type: none">• WPA-Personal:<ul style="list-style-type: none">TKIP / AES• WPA2-Personal:<ul style="list-style-type: none">TKIP / AES• Open:<ul style="list-style-type: none">WEP / NONE (without encryption)• Shared key:<ul style="list-style-type: none">WEP <p>If your issue is not solved, the Network Name (SSID) or security settings you entered may be incorrect. Check that all wireless network settings are correct for your network.</p>

Error Code	Problem and Recommended Solutions
TS-05	<p>The Network Name (SSID) and Network Key (Password) are incorrect.</p> <p>Check the following points and try to set up your wireless connection again:</p> <ul style="list-style-type: none"> • Confirm the Network Name (SSID) and Network Key (Password). • If your Network Key contains upper-case and lower-case letters, make sure you type them correctly. • If you cannot find the Network Name (SSID) and security information, see the documentation provided with your wireless router/access point, or contact the router manufacturer, your system administrator, or Internet service provider. • If your wireless router/access point uses WEP encryption with multiple WEP keys, write down and use only the first WEP key.
TS-06	<p>The wireless security information (authentication method/encryption method/Network Key (Password)) is incorrect.</p> <p>Check the following points and try to set up your wireless connection again:</p> <ul style="list-style-type: none"> • Confirm the Network Key. If your Network Key contains upper-case and lower-case letters, make sure you type them correctly. • Confirm whether the authentication method entered and the authentication method or encryption method supported by the wireless router/access point are the same. • If the network key, authentication method, and encryption method have been confirmed, restart your wireless router/access point and the machine. • If your wireless router/access point's Stealth Mode is on, you may need to disable it to connect to the wireless network. <p>If you cannot find the Network Name (SSID) and security information, see the documentation provided with your wireless router/access point, or contact the router manufacturer, your system administrator, or Internet service provider.</p>
TS-07	<p>The machine cannot detect a wireless router/access point that has WPS (Wi-Fi Protected Setup) enabled.</p> <p>Check the following points and try again:</p> <ul style="list-style-type: none"> • To check if your wireless router/access point supports WPS, look for the WPS symbol displayed on the router/access point. For more information, see the documentation provided with your wireless router/access point. • To set up your wireless connection using WPS, you must configure both your machine and the wireless router/access point. For more information, see the user's guide. • If you do not know how to set up your wireless router/access point using WPS, see the documentation provided with your wireless router/access point, or contact the router manufacturer, your system administrator, or Internet service provider.
TS-08	<p>Two or more wireless routers or access points that have WPS enabled are detected.</p> <p>Check the following points and try again:</p> <ul style="list-style-type: none"> • Make sure that only one wireless router/access point within range has WPS enabled, and then try to connect again. • Try to connect again after a few minutes to avoid interference from other access points/routers.



How to confirm wireless security information (SSID/authentication method/encryption method/Network Key) of your WLAN access point/router:

1. The default security settings may be provided on a label attached to the WLAN access point/router. Or the manufacturer's name or model number of the WLAN access point/router may be used as the default security settings.
2. See the documentation provided with your WLAN access point/router for information on how to find the security settings.
 - If the WLAN access point/router is set to not broadcast the SSID, the SSID will not automatically be detected. You will have to manually enter the SSID name.
 - The Network key may also be described as the Password, Security Key, or Encryption Key.

If you do not know the SSID and wireless security settings of your WLAN access point/router or how to change the configuration, see the documentation provided with your WLAN access point/router, ask the manufacturer of your access point/router or ask your Internet provider or network administrator.



Related Information

- [Print the WLAN Report](#)

Related Topics:

- [If You Are Having Difficulty with Your Machine's Network](#)
-

Network Features

- [Print the Network Configuration Report](#)
- [Reset the Network Settings to Factory Default](#)

Print the Network Configuration Report

The Network Configuration Report lists the network configuration, including the network print server settings.



- **Node Name:** The Node Name appears on the current Network Configuration Report. The default Node Name is "BRNxxxxxxxxxxx" for a wired network or "BRWxxxxxxxxxxx" for a wireless network (where "xxxxxxxxxxx" is your machine's MAC Address / Ethernet Address.)
- If the IP Address on the Network Configuration Report shows 0.0.0.0, wait for one minute and try printing it again.
- You can find your machine's settings, such as the IP address, subnet mask, node name, and MAC Address on the report, for example:
 - IP address: 192.168.0.5
 - Subnet mask: 255.255.255.0
 - Node name: BRN000ca0000499
 - MAC Address: 00-0c-a0-00-04-99

>> [DCP-J1050DW/MFC-J1010DW](#)
>> [DCP-J1140DW](#)

DCP-J1050DW/MFC-J1010DW

1. Press **Settings**.
2. Press **▲** or **▼** to make your selections:
 - a. Select [Print Reports]. Press **OK**.
 - b. Select [Network Config]. Press **OK**.
3. Press **▶**.

The machine prints the current Network Configuration Report.

DCP-J1140DW

1. Press  [Settings] > [All Settings] > [Print Reports] > [Network Configuration] > [Yes].

The machine prints the current Network Configuration Report.

✓ Related Information

- [Network Features](#)

Related Topics:

- [If You Are Having Difficulty with Your Machine's Network](#)
- [Configure IEEE 802.1x Authentication for a Wired or a Wireless Network Using Web Based Management \(Web Browser\)](#)
- [Error and Maintenance Messages](#)

Reset the Network Settings to Factory Default

You can use your machine's control panel to reset the print server to its default factory settings. This resets all information, such as the password and IP address.



- You can also reset the print server to its factory settings using Web Based Management.

>> [DCP-J1050DW/MFC-J1010DW](#)

>> [DCP-J1140DW](#)

DCP-J1050DW/MFC-J1010DW

- Press **Settings**.
- Press **▲** or **▼** to make your selections:
 - Select [Network]. Press **OK**.
 - Select [Network Reset]. Press **OK**.
- Press **▶** for two seconds to confirm.
The machine restarts.

DCP-J1140DW

- Press  [Settings] > [All Settings] > [Network] > [Network Reset].
- The reset confirmation message is displayed. Press [OK] for two seconds.
The machine will restart.



Related Information

- [Network Features](#)

Related Topics:

- [Transfer Your Faxes or Fax Journal Report](#)

Brother Management Tools

Use one of Brother's management tools to configure your Brother machine's network settings.
Go to your model's **Downloads** page at support.brother.com to download the tools.



Related Information

- [Network](#)
-

Security

- [Before Using Network Security Features](#)
- [Configure Certificates for Device Security](#)
- [Use SSL/TLS](#)
- [Use IEEE 802.1x Authentication for a Wired or a Wireless Network](#)
- [Lock the Machine Settings from the Control Panel](#)

Before Using Network Security Features

Your machine employs some of the latest network security and encryption protocols available today. These network features can be integrated into your overall network security plan to help protect your data and prevent unauthorised access to the machine.



We recommend disabling the FTP and TFTP protocols. Accessing the machine using these protocols is not secure.



Related Information

- [Security](#)
-

Configure Certificates for Device Security

You must configure a certificate to manage your networked machine securely using SSL/TLS. You must use Web Based Management to configure a certificate.

- [Supported Security Certificate Features](#)
- [Step by Step Guide for Creating and Installing a Certificate](#)
- [Create a Self-signed Certificate](#)
- [Create CSR and Install a Certificate from a Certificate Authority \(CA\)](#)
- [Import and Export the Certificate and Private Key](#)
- [Manage Multiple Certificates](#)

Supported Security Certificate Features

Your machine supports the use of multiple security certificates, which allows secure authentication and communication with the machine. The following security certificate features can be used with the machine:

- SSL/TLS communication
- IEEE 802.1x authentication

The Brother machine supports the following:

- Pre-installed certificate

Your machine has a pre-installed self-signed certificate. This certificate enables you to use SSL/TLS communication without creating or installing a different certificate.



The pre-installed self-signed certificate protects your communication up to a certain level. We recommend using a certificate that is issued by a trusted organisation for better security.

- Self-signed certificate

This print server issues its own certificate. Using this certificate, you can easily use the SSL/TLS communication without creating or installing a different certificate from a CA.

- Certificate from a Certificate Authority (CA)

There are two methods for installing a certificate from a CA. If you already have a certificate from a CA or if you want to use a certificate from an external trusted CA:

- When using a Certificate Signing Request (CSR) from this print server.
- When importing a certificate and a private key.



- If you are going to use SSL/TLS communication, we recommend contacting your system administrator first.
- When you reset the print server back to its default factory settings, the certificate and the private key that are installed will be deleted. If you want to keep the same certificate and the private key after resetting the print server, export them before resetting, and then reinstall them.



Related Information

- [Configure Certificates for Device Security](#)

Related Topics:

- [Configure IEEE 802.1x Authentication for a Wired or a Wireless Network Using Web Based Management \(Web Browser\)](#)

Step by Step Guide for Creating and Installing a Certificate

There are two options when choosing a security certificate: use a self-signed certificate or use a certificate from a Certificate Authority (CA).

Option 1

Self-Signed Certificate

1. Create a self-signed certificate using Web Based Management.
2. Install the self-signed certificate on your computer.

Option 2

Certificate from a CA

1. Create a Certificate Signing Request (CSR) using Web Based Management.
2. Install the certificate issued by the CA on your Brother machine using Web Based Management.
3. Install the certificate on your computer.



Related Information

- [Configure Certificates for Device Security](#)
-

Create a Self-signed Certificate

1. Start your web browser.
2. Type "https://machine's IP address" in your browser's address bar (where "machine's IP address" is the machine's IP address).

For example:

https://192.168.1.2



- If you are using a Domain Name System or enable a NetBIOS name, you can type another name, such as "SharedPrinter" instead of the IP address.

- For example:

https://SharedPrinter

If you enable a NetBIOS name, you can also use the node name.

- For example:

https://brnxxxxxxxxxxxxx

The NetBIOS name can be found in the Network Configuration Report.

3. If required, type the password in the **Login** field, and then click **Login**.



The default password to manage this machine's settings is located on the back of the machine and marked "Pwd".

4. Go to the navigation menu, and then click **Network > Security > Certificate**.



Start from , if the navigation menu is not shown on the left side of the screen.

5. Click **Create Self-Signed Certificate**.
6. Enter a **Common Name** and a **Valid Date**.
 - The length of the **Common Name** is less than 64 bytes. Enter an identifier, such as an IP address, node name, or domain name to use when accessing this machine through SSL/TLS communication. The node name is displayed by default.
 - A warning will appear if you use the IPPS or HTTPS protocol and enter a different name in the URL than the **Common Name** that was used for the self-signed certificate.
7. Select your setting from the **Public Key Algorithm** drop-down list. The default setting is **RSA(2048bit)**.
8. Select your setting from the **Digest Algorithm** drop-down list. The default setting is **SHA256**.
9. Click **Submit**.



Related Information

- [Configure Certificates for Device Security](#)

Related Topics:

- [Access Web Based Management](#)

Create CSR and Install a Certificate from a Certificate Authority (CA)

If you already have a certificate from an external trusted CA, you can store the certificate and private key on the machine and manage them by importing and exporting. If you do not have a certificate from an external trusted CA, create a Certificate Signing Request (CSR), send it to a CA for authentication, and install the returned certificate on your machine.

- [Create a Certificate Signing Request \(CSR\)](#)
- [Install a Certificate on Your Machine](#)

Create a Certificate Signing Request (CSR)

A Certificate Signing Request (CSR) is a request sent to a Certificate Authority (CA) to authenticate the credentials contained within the certificate.

We recommend installing a Root Certificate from the CA on your computer before creating the CSR.

1. Start your web browser.
2. Type "https://machine's IP address" in your browser's address bar (where "machine's IP address" is the machine's IP address).

For example:

https://192.168.1.2



- If you are using a Domain Name System or enable a NetBIOS name, you can type another name, such as "SharedPrinter" instead of the IP address.

- For example:

https://SharedPrinter

If you enable a NetBIOS name, you can also use the node name.

- For example:

https://brnxxxxxxxxxxxx

The NetBIOS name can be found in the Network Configuration Report.

3. If required, type the password in the **Login** field, and then click **Login**.



The default password to manage this machine's settings is located on the back of the machine and marked "Pwd".

4. Go to the navigation menu, and then click **Network > Security > Certificate**.



Start from ☰, if the navigation menu is not shown on the left side of the screen.

5. Click **Create CSR**.
6. Type a **Common Name** (required) and add other information about your **Organization** (optional).



- Your company details are required so that a CA can confirm your identity and verify it to the outside world.
- The length of the **Common Name** must be less than 64 bytes. Enter an identifier, such as an IP address, node name, or domain name to use when accessing this printer through SSL/TLS communication. The node name is displayed by default. The **Common Name** is required.
- A warning will appear if you type a different name in the URL than the Common Name that was used for the certificate.
- The length of the **Organization**, the **Organization Unit**, the **City/Locality** and the **State/Province** must be less than 64 bytes.
- The **Country/Region** should be a two character ISO 3166 country code.
- If you are configuring an X.509v3 certificate extension, select the **Configure extended partition** check box, and then select **Auto (Register IPv4)** or **Manual**.

7. Select your setting from the **Public Key Algorithm** drop-down list. The default setting is **RSA(2048bit)**.
8. Select your setting from the **Digest Algorithm** drop-down list. The default setting is **SHA256**.
9. Click **Submit**.

The CSR appears on your screen. Save the CSR as a file or copy and paste it into an online CSR form offered by a Certificate Authority.

10. Click **Save**.



- Follow your CA's policy regarding the method to send a CSR to your CA.
 - If you are using the Enterprise root CA of Windows Server 2008/2008 R2/2012/2012 R2/2016/2019, we recommend using the Web Server for the certificate template to securely create the Client Certificate. If you are creating a Client Certificate for an IEEE 802.1x environment with EAP-TLS authentication, we recommend using User for the certificate template.
-



Related Information

- [Create CSR and Install a Certificate from a Certificate Authority \(CA\)](#)

Related Topics:

- [Access Web Based Management](#)
-

Install a Certificate on Your Machine

When you receive a certificate from a CA, follow the steps below to install it into the print server:

Only a certificate issued with your machine's CSR can be installed onto the machine. When you want to create another CSR, make sure that the certificate is installed before creating another CSR. Create another CSR only after installing the certificate on the machine. If you do not, the CSR you create before installing will be invalid.

1. Start your web browser.
2. Type "https://machine's IP address" in your browser's address bar (where "machine's IP address" is the machine's IP address).

For example:

https://192.168.1.2



- If you are using a Domain Name System or enable a NetBIOS name, you can type another name, such as "SharedPrinter" instead of the IP address.

- For example:

https://SharedPrinter

If you enable a NetBIOS name, you can also use the node name.

- For example:

https://brnxxxxxxxxxxxx

The NetBIOS name can be found in the Network Configuration Report.

3. If required, type the password in the **Login** field, and then click **Login**.



The default password to manage this machine's settings is located on the back of the machine and marked "Pwd".

4. Go to the navigation menu, and then click **Network > Security > Certificate**.



Start from ☰, if the navigation menu is not shown on the left side of the screen.

5. Click **Install Certificate**.
6. Browse to the file that contains the certificate issued by the CA, and then click **Submit**.

The certificate has been created successfully and saved in your machine's memory successfully.

To use SSL/TLS communication, the Root Certificate from the CA must be installed on your computer. Contact your network administrator.



Related Information

- [Create CSR and Install a Certificate from a Certificate Authority \(CA\)](#)

Related Topics:

- [Access Web Based Management](#)

Import and Export the Certificate and Private Key

Store the certificate and private key on your machine and manage them by importing and exporting them.

- [Import a Certificate and Private Key](#)
- [Export the Certificate and Private Key](#)

Import a Certificate and Private Key

1. Start your web browser.
2. Type "https://machine's IP address" in your browser's address bar (where "machine's IP address" is the machine's IP address).

For example:

https://192.168.1.2



- If you are using a Domain Name System or enable a NetBIOS name, you can type another name, such as "SharedPrinter" instead of the IP address.

- For example:

https://SharedPrinter

If you enable a NetBIOS name, you can also use the node name.

- For example:

https://brnxxxxxxxxxxxx

The NetBIOS name can be found in the Network Configuration Report.

3. If required, type the password in the **Login** field, and then click **Login**.



The default password to manage this machine's settings is located on the back of the machine and marked "Pwd".

4. Go to the navigation menu, and then click **Network > Security > Certificate**.



Start from , if the navigation menu is not shown on the left side of the screen.

5. Click **Import Certificate and Private Key**.
6. Browse to the file you want to import.
7. Type the password if the file is encrypted, and then click **Submit**.

The certificate and private key are imported to your machine.



Related Information

- [Import and Export the Certificate and Private Key](#)

Related Topics:

- [Access Web Based Management](#)

Export the Certificate and Private Key

1. Start your web browser.
2. Type "https://machine's IP address" in your browser's address bar (where "machine's IP address" is the machine's IP address).

For example:

https://192.168.1.2



- If you are using a Domain Name System or enable a NetBIOS name, you can type another name, such as "SharedPrinter" instead of the IP address.

- For example:

https://SharedPrinter

If you enable a NetBIOS name, you can also use the node name.

- For example:

https://brnxxxxxxxxxxxx

The NetBIOS name can be found in the Network Configuration Report.

3. If required, type the password in the **Login** field, and then click **Login**.



The default password to manage this machine's settings is located on the back of the machine and marked "Pwd".

4. Go to the navigation menu, and then click **Network > Security > Certificate**.



Start from , if the navigation menu is not shown on the left side of the screen.

5. Click **Export** shown with **Certificate List**.
6. Enter the password if you want to encrypt the file.
If a blank password is used, the output is not encrypted.
7. Enter the password again for confirmation, and then click **Submit**.
8. Click **Save**.

The certificate and private key are exported to your computer.

You can also import the certificate to your computer.



Related Information

- [Import and Export the Certificate and Private Key](#)

Related Topics:

- [Access Web Based Management](#)

Manage Multiple Certificates

The multiple certificate feature allows you to use Web Based Management to manage each certificate installed on your machine. In Web Based Management, navigate to the **Certificate** or **CA Certificate** screen to view certificate content, delete, or export your certificates.

	Maximum Number of Certificates Stored on Brother Machine
Self-signed Certificate or Certificate Issued by a CA	3
CA Certificate	2

We recommend storing fewer certificates than allowed, reserving an empty spot in case of certificate expiration. When a certificate expires, import a new certificate into the reserved spot, and then delete the expired certificate. This ensures that you avoid configuration failure.



- When you use HTTPS/IPPS or IEEE 802.1x, you must select which certificate you are using.
- When you use SSL for SMTP communications, you do not have to choose the certificate. The necessary certificate will be chosen automatically.



Related Information

- [Configure Certificates for Device Security](#)

Use SSL/TLS

- [Introduction to SSL/TLS](#)
- [Manage Your Network Machine Securely Using SSL/TLS](#)
- [Print Documents Securely Using SSL/TLS](#)

Introduction to SSL/TLS

Secure Socket Layer (SSL) or Transport Layer Security (TLS) is an effective method of protecting data sent over a local or wide area network (LAN or WAN). It works by encrypting data, such as a print job, sent over a network, so anyone trying to capture it will not be able to read it.

SSL/TLS will work with other forms of security such as WPA keys and firewalls.



Related Information

- [Use SSL/TLS](#)
 - [Brief History of SSL/TLS](#)
 - [Benefits of Using SSL/TLS](#)

Brief History of SSL/TLS

SSL/TLS was originally created to secure web traffic information, particularly data sent between web browsers and servers. For example, when you use Internet Explorer for Internet Banking and you see https:// and the little padlock icon in the web browser, you are using SSL. SSL grew to work with additional applications, such as Telnet, printer, and FTP software, in order to become a universal solution for online security. Its original design intentions are still being used today by many online retailers and banks to secure sensitive data, such as credit card numbers, customer records, etc.

SSL/TLS uses extremely high levels of encryption and is trusted by banks all over the world.



Related Information

- [Introduction to SSL/TLS](#)
-

Benefits of Using SSL/TLS

The primary benefit of using SSL/TLS is to guarantee secure printing over an IP network by restricting unauthorised users from reading data sent to the machine. SSL's key selling point is that it can be used to print confidential data securely. For example, an HR department in a large company may be printing wage slips on a regular basis. Without encryption, the data contained on these wages slips can be read by other network users. However, with SSL/TLS, anyone trying to capture the data will see a confusing page of code and not the actual wage slip.



Related Information

- [Introduction to SSL/TLS](#)

Manage Your Network Machine Securely Using SSL/TLS

- [Configure a Certificate for SSL/TLS and Available Protocols](#)
- [Access Web Based Management Using SSL/TLS](#)
- [Install the Self-signed Certificate for Windows users with Administrator Rights](#)
- [Configure Certificates for Device Security](#)

Configure a Certificate for SSL/TLS and Available Protocols

Configure a certificate on your machine using Web Based Management before you use SSL/TLS communication.

1. Start your web browser.
2. Type "https://machine's IP address" in your browser's address bar (where "machine's IP address" is the machine's IP address).

For example:

https://192.168.1.2



- If you are using a Domain Name System or enable a NetBIOS name, you can type another name, such as "SharedPrinter" instead of the IP address.

- For example:

https://SharedPrinter

If you enable a NetBIOS name, you can also use the node name.

- For example:

https://brnxxxxxxxxxxxx

The NetBIOS name can be found in the Network Configuration Report.

3. If required, type the password in the **Login** field, and then click **Login**.



The default password to manage this machine's settings is located on the back of the machine and marked "Pwd".

4. Go to the navigation menu, and then click **Network > Network > Protocol**.



Start from ☰, if the navigation menu is not shown on the left side of the screen.

5. Click **HTTP Server Settings**.
6. Select the certificate you want to configure from the **Select the Certificate** drop-down list.
7. Click **Submit**.
8. Click **Yes** to restart your print server.



Related Information

- [Manage Your Network Machine Securely Using SSL/TLS](#)

Related Topics:

- [Access Web Based Management](#)
- [Print Documents Securely Using SSL/TLS](#)

Access Web Based Management Using SSL/TLS

To manage your network machine securely, you must use management utilities with security protocols.



- To use HTTPS protocol, HTTPS must be enabled on your machine. The HTTPS protocol is enabled by default.
- You can change the HTTPS protocol settings using the Web Based Management screen.

1. Start your web browser.
2. Type "https://machine's IP address" in your browser's address bar (where "machine's IP address" is the machine's IP address).

For example:

https://192.168.1.2

3. If required, type the password in the **Login** field, and then click **Login**.



The default password to manage this machine's settings is located on the back of the machine and marked "Pwd".

4. You can now access the machine using HTTPS.



Related Information





- [Manage Your Network Machine Securely Using SSL/TLS](#)

Related Topics:

- [Access Web Based Management](#)

Install the Self-signed Certificate for Windows users with Administrator Rights

The following steps are for Microsoft Internet Explorer. If you use another web browser, consult the documentation for your web browser to get help with installing certificates.

1. Do one of the following:
 - Windows 10, Windows Server 2016, and Windows Server 2019
Click  > **Windows Accessories**.
 - Windows 8.1
Right-click the  (**Internet Explorer**) icon on the taskbar.
 - Windows Server 2012 and Windows Server 2012 R2
Click , and then right-click the  (**Internet Explorer**) icon that appears on the taskbar.
 - Windows 7 and Windows Server 2008
Click  (**Start**) > **All Programs**.
2. Right-click **Internet Explorer**, and then click **Run as administrator**.



If the **More** option appears, click **More**.

If the **User Account Control** screen appears, click **Yes**.

3. Type "https://machine's IP address" in your browser's address bar to access your machine (where "machine's IP address" is the machine's IP address or the node name that you assigned for the certificate).
4. Click **More information**.
5. Click **Go on to the webpage (not recommended)**.
6. Click **Certificate error**, and then click **View certificates**.

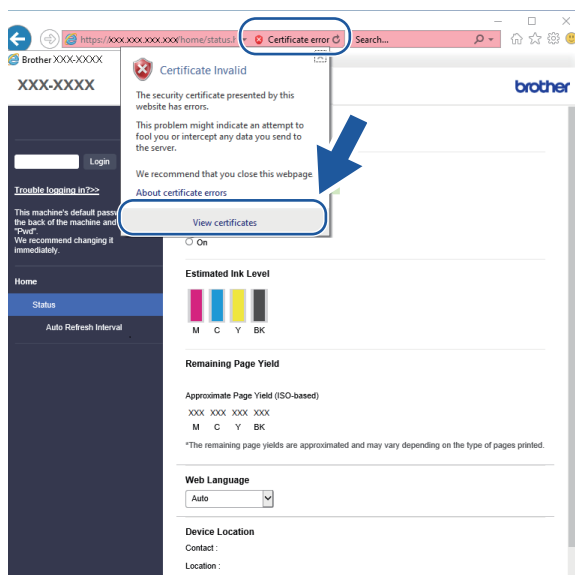

7. Click **Install Certificate....**
8. When the **Certificate Import Wizard** appears, click **Next**.
9. Select **Place all certificates in the following store**, and then click **Browse....**
10. Select **Trusted Root Certification Authorities**, and then click **OK**.
11. Click **Next**.

12. Click **Finish**.

13. Click **Yes**, if the fingerprint (thumbprint) is correct.

14. Click **OK**.



Related Information

- [Manage Your Network Machine Securely Using SSL/TLS](#)

Print Documents Securely Using SSL/TLS

- [Print Documents Using SSL/TLS](#)
- [Configure Certificates for Device Security](#)
- [Configure a Certificate for SSL/TLS and Available Protocols](#)

Print Documents Using SSL/TLS

To print documents securely with IPP protocol, use the IPPS protocol.

1. Start your web browser.
2. Type "https://machine's IP address" in your browser's address bar (where "machine's IP address" is the machine's IP address).

For example:

https://192.168.1.2



- If you are using a Domain Name System or enable a NetBIOS name, you can type another name, such as "SharedPrinter" instead of the IP address.

- For example:

https://SharedPrinter

If you enable a NetBIOS name, you can also use the node name.

- For example:

https://brnxxxxxxxxxxxx

The NetBIOS name can be found in the Network Configuration Report.

3. If required, type the password in the **Login** field, and then click **Login**.



The default password to manage this machine's settings is located on the back of the machine and marked "Pwd".

4. Go to the navigation menu, and then click **Network > Network > Protocol**.



Start from , if the navigation menu is not shown on the left side of the screen.

5. Make sure the **IPP** check box is selected.



If the **IPP** check box is not selected, select the **IPP** check box, and then click **Submit**.

Restart your machine to activate the configuration.

After the machine restarts, return to the machine's web page, type the password, go to the navigation menu, and then click **Network > Network > Protocol**.

6. Click **HTTP Server Settings**.
7. Select the **HTTPS (Port 443)** check box in the **IPP**, and then click **Submit**.
8. Restart your machine to activate the configuration.

Communication using IPPS cannot prevent unauthorised access to the print server.



Related Information

- [Print Documents Securely Using SSL/TLS](#)

Related Topics:

- [Access Web Based Management](#)

Use IEEE 802.1x Authentication for a Wired or a Wireless Network

- [What Is IEEE 802.1x Authentication?](#)
- [Configure IEEE 802.1x Authentication for a Wired or a Wireless Network Using Web Based Management \(Web Browser\)](#)
- [IEEE 802.1x Authentication Methods](#)

What Is IEEE 802.1x Authentication?

IEEE 802.1x is an IEEE standard for wired and wireless networks that limits access from unauthorised network devices. Your Brother machine (supplicant) sends an authentication request to a RADIUS server (Authentication server) through your access point or HUB. After your request has been verified by the RADIUS server, your machine can access the network.



Related Information

- [Use IEEE 802.1x Authentication for a Wired or a Wireless Network](#)
-

Configure IEEE 802.1x Authentication for a Wired or a Wireless Network Using Web Based Management (Web Browser)

- If you configure your machine using EAP-TLS authentication, you must install the client certificate issued by a CA before you start configuration. Contact your network administrator about the client certificate. If you have installed more than one certificate, we recommend writing down the certificate name you want to use.
- Before you verify the server certificate, you must import the CA certificate issued by the CA that signed the server certificate. Contact your network administrator or your Internet Service Provider (ISP) to confirm whether a CA certificate import is necessary.



You can also configure IEEE 802.1x authentication using Wireless setup wizard from the control panel (Wireless network).

1. Start your web browser.
2. Type "https://machine's IP address" in your browser's address bar (where "machine's IP address" is the machine's IP address).

For example:

https://192.168.1.2



- If you are using a Domain Name System or enable a NetBIOS name, you can type another name, such as "SharedPrinter" instead of the IP address.

- For example:

https://SharedPrinter

If you enable a NetBIOS name, you can also use the node name.

- For example:

https://brnxxxxxxxxxxxx

The NetBIOS name can be found in the Network Configuration Report.

3. If required, type the password in the **Login** field, and then click **Login**.



The default password to manage this machine's settings is located on the back of the machine and marked "Pwd".

4. Go to the navigation menu, and then click **Network**.



Start from ☰, if the navigation menu is not shown on the left side of the screen.

5. Click **Wireless > Wireless (Enterprise)**.
6. Configure the IEEE 802.1x authentication settings.



- To enable IEEE 802.1x authentication for wired networks, select **Enabled** for **Wired 802.1x status** on the **Wired 802.1x Authentication** page.
- If you are using **EAP-TLS** authentication, you must select the client certificate installed (shown with certificate name) for verification from the **Client Certificate** drop-down list.
- If you select **EAP-FAST**, **PEAP**, **EAP-TTLS**, or **EAP-TLS** authentication, select the verification method from the **Server Certificate Verification** drop-down list. Verify the server certificate using the CA certificate, imported to the machine in advance, issued by the CA that signed the server certificate.

Select one of the following verification methods from the **Server Certificate Verification** drop-down list:

Option	Description
No Verification	The server certificate can always be trusted. The verification is not performed.
CA Cert.	The verification method to check the CA reliability of the server certificate, using the CA certificate issued by the CA that signed the server certificate.
CA Cert. + ServerID	The verification method to check the common name ¹ value of the server certificate, in addition to the CA reliability of the server certificate.

7. When finished with configuration, click **Submit**.

For wired networks: After configuring, connect your machine to the IEEE 802.1x supported network. After a few minutes, print the Network Configuration Report to check the <**Wired IEEE 802.1x**> status.

Option	Description
Success	The wired IEEE 802.1x function is enabled and the authentication was successful.
Failed	The wired IEEE 802.1x function is enabled; however, the authentication failed.
Off	The wired IEEE 802.1x function is not available.

Related Information

- [Use IEEE 802.1x Authentication for a Wired or a Wireless Network](#)

Related Topics:

- [Print the Network Configuration Report](#)
- [Print the WLAN Report](#)
- [Access Web Based Management](#)
- [Configure Certificates for Device Security](#)
- [Supported Security Certificate Features](#)

¹ The common name verification compares the common name of the server certificate to the character string configured for the **Server ID**. Before you use this method, contact your system administrator about the server certificate's common name and then configure **Server ID**.

IEEE 802.1x Authentication Methods

EAP-FAST

Extensible Authentication Protocol-Flexible Authentication via Secured Tunneling (EAP-FAST) has been developed by Cisco Systems, Inc., which uses a user ID and password for authentication, and symmetric key algorithms to achieve a tunnelled authentication process.

The Brother machine supports the following inner authentication methods:

- EAP-FAST/NONE
- EAP-FAST/MS-CHAPv2
- EAP-FAST/GTC

PEAP

Protected Extensible Authentication Protocol (PEAP) is a version of EAP method developed by Cisco Systems, Inc., Microsoft Corporation and RSA Security. PEAP creates an encrypted Secure Sockets Layer (SSL)/Transport Layer Security (TLS) tunnel between a client and an authentication server, for sending a user ID and password. PEAP provides mutual authentication between the server and the client.

The Brother machine supports the following inner authentications:

- PEAP/MS-CHAPv2
- PEAP/GTC

EAP-TTLS

Extensible Authentication Protocol-Tunneled Transport Layer Security (EAP-TTLS) has been developed by Funk Software and Certicom. EAP-TTLS creates a similar encrypted SSL tunnel to PEAP, between a client and an authentication server, for sending a user ID and password. EAP-TTLS provides mutual authentication between the server and the client.

The Brother machine supports the following inner authentications:

- EAP-TTLS/CHAP
- EAP-TTLS/MS-CHAP
- EAP-TTLS/MS-CHAPv2
- EAP-TTLS/PAP

EAP-TLS

Extensible Authentication Protocol-Transport Layer Security (EAP-TLS) requires digital certificate authentication both at a client and an authentication server.



Related Information

- [Use IEEE 802.1x Authentication for a Wired or a Wireless Network](#)

Lock the Machine Settings from the Control Panel

Before turning on the machine's Access Lock, make a careful note of your password. If you forget the password, you must reset all passwords stored in the machine by contacting your administrator or Brother customer service.

- [About Using TX Lock](#)

About Using TX Lock

Related Models: MFC-J1010DW

Block unauthorised data transmission to and from the machine.

TX Lock lets you prevent unauthorised access to the machine.

While TX Lock is On, the following operations are available:

- Receiving faxes
- PC-Fax Receive (If PC-Fax Receive was already On)



While the TX Lock feature is turned on, your machine will receive faxes and store them in its memory. Then, when TX Lock is turned off, the faxes will be sent to your chosen PC.

While TX Lock is On, the following operations are NOT available:

- Operation from the control panel
- PC printing
- PC scanning



Related Information

- [Lock the Machine Settings from the Control Panel](#)
 - [Set the TX Lock Password](#)
 - [Change the TX Lock Password](#)
 - [Turn TX Lock On/Off](#)

Set the TX Lock Password

Related Models: MFC-J1010DW

1. Press **Settings**.
2. Press **▲** or **▼** to select the following:
 - a. Select [Fax]. Press **OK**.
 - b. Select [Miscellaneous]. Press **OK**.
 - c. Select [TX Lock]. Press **OK**.
3. Enter a four-digit number for the password. Press **OK**.
4. Re-enter the password. Press **OK**.
5. Press **Stop/Exit**.



Related Information

- [About Using TX Lock](#)

Change the TX Lock Password

Related Models: MFC-J1010DW

1. Press **Settings**.
2. Press **▲** or **▼** to select the following:
 - a. Select [Fax]. Press **OK**.
 - b. Select [Miscellaneous]. Press **OK**.
 - c. Select [TX Lock]. Press **OK**.
 - d. Select [Set Password]. Press **OK**.
3. Enter the four-digit number of the current password. Press **OK**.
4. Enter a four-digit number for the new password. Press **OK**.
5. Re-enter the new password. Press **OK**.
6. Press **Stop/Exit**.



Related Information

- [About Using TX Lock](#)

Turn TX Lock On/Off

Related Models: MFC-J1010DW

1. Press **Settings**.
2. Press **▲** or **▼** to select the following:
 - a. Select [Fax]. Press **OK**.
 - b. Select [Miscellaneous]. Press **OK**.
 - c. Select [TX Lock]. Press **OK**.
 - d. Select [Set TX Lock]. Press **OK**.
3. Enter the registered four-digit password. Press **OK**.

The machine goes offline and the LCD displays [TX Lock Mode].



Turning off TX Lock:

- a. Press **Settings**.
- b. Enter the current four-digit password, and then press **OK**.

If you enter the wrong password, the LCD displays [Wrong Password] and stays offline. The machine will stay in TX Lock Mode until the correct password is entered.



Related Information

- [About Using TX Lock](#)

Mobile/Web Connect

- [Brother Web Connect](#)
- [AirPrint](#)
- [Mopria® Print Service](#)
- [Brother Mobile Connect](#)

Brother Web Connect

- [Brother Web Connect Overview](#)
- [Online Services Used with Brother Web Connect](#)
- [Set Up Brother Web Connect](#)
- [Scan and Upload Documents Using Brother Web Connect](#)
- [Download and Print Documents Using Brother Web Connect](#)

Brother Web Connect Overview

Certain websites provide services that allow users to upload and view images and files on the website. Your Brother machine can scan images and upload them to these services, and also download from and print images that are already uploaded to these services.

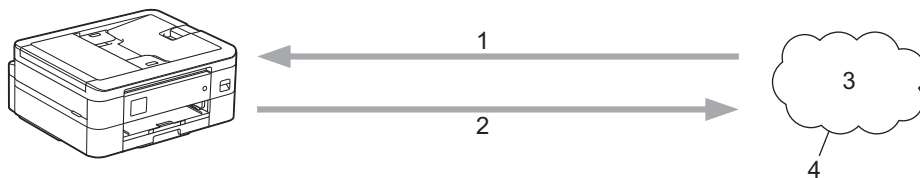



1. Printing
2. Scanning
3. Photos, images, documents and other files
4. Web Service

To use Brother Web Connect, your Brother machine must be connected to a network that has access to the Internet, through either a wired or wireless connection.

For network setups that use a proxy server, the machine must also be configured to use a proxy server. If you are unsure of your network configuration, check with your network administrator.



A proxy server is a computer that serves as an intermediary between computers without a direct Internet connection, and the Internet.

Press  (Web) or  (Apps) on the touchscreen, or press  (**WEB**) to use Brother Web Connect.

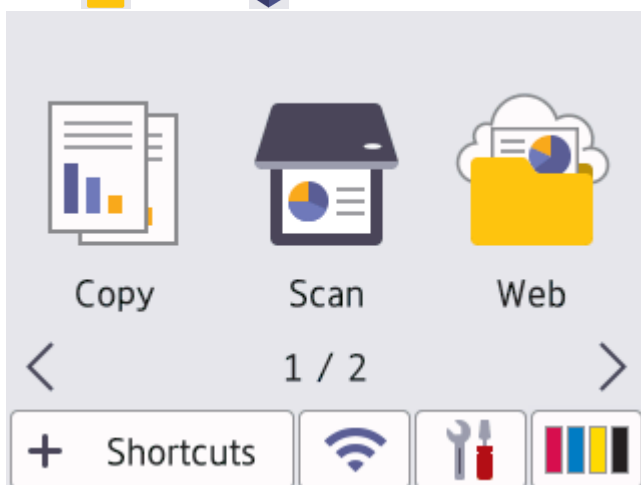

✓ Related Information

- [Brother Web Connect](#)
 - [Configure the Proxy Server Settings Using the Machine's Control Panel](#)
 - [Configure the Proxy Server Settings Using Web Based Management](#)

Configure the Proxy Server Settings Using the Machine's Control Panel

If your network uses a proxy server, the following proxy server information must be configured on the machine:

- Proxy server address
- Port number
- User Name
- Password



>> [DCP-J1050DW/MFC-J1010DW](#)

>> [DCP-J1140DW](#)

DCP-J1050DW/MFC-J1010DW

1. Press **Settings**.
2. Press **▲** or **▼** to select the following:
 - a. Select [Network]. Press **OK**.
 - b. Select [Web Connect Settings]. Press **OK**.
 - c. Select [Proxy Settings]. Press **OK**.
 - d. Select [Proxy Connection]. Press **OK**.
 - e. Select [On]. Press **OK**.
 - f. Select the option that you want to set. Press **OK**.
 - g. Enter the proxy server information. Press **OK**.
3. Press **Stop/Exit**.

DCP-J1140DW

1. Press  [Settings] > [All Settings] > [Network] > [Web Connect Settings] > [Proxy Settings] > [Proxy Connection].
2. Press [On].
3. Press the option that you want to set, and then enter the proxy server information.
Press [OK].
4. Press .



Related Information

- [Brother Web Connect Overview](#)

Configure the Proxy Server Settings Using Web Based Management

If your network uses a proxy server, the following proxy server information must be configured using Web Based Management:

- Proxy server address
- Port number
- User Name
- Password



We recommend Microsoft Internet Explorer 11/Microsoft Edge for Windows, Safari 10/11 for Mac, Google Chrome™ for Android (4.x or later), and Google Chrome™/Safari for iOS (10.x or later). Make sure that JavaScript and Cookies are always enabled in whichever browser you use.

1. Start your web browser.
2. Type "https://machine's IP address" in your browser's address bar (where "machine's IP address" is the machine's IP address).

For example:

https://192.168.1.2

3. If required, type the password in the **Login** field, and then click **Login**.



The default password to manage this machine's settings is located on the back of the machine and marked "Pwd".

4. Go to the navigation menu, and then click **Network > Network > Protocol**.



Start from , if the navigation menu is not shown on the left side of the screen.

5. Make sure the **Proxy** check box is selected, and then click **Submit**.
6. In the **Proxy** field, click **Advanced Settings**.
7. Enter the proxy server information.
8. Click **Submit**.



Related Information

- [Brother Web Connect Overview](#)

Related Topics:

- [Access Web Based Management](#)

Online Services Used with Brother Web Connect

Use Brother Web Connect to access online services from your Brother machine. Some of these web services offer business versions.

To use Brother Web Connect, you must have an account with the online service you want to use. If you do not already have an account, use a computer to access the service's website and create an account.

You do not need to create an account to use Brother Creative Center. (Brother CreativeCenter is available only for some models.)

Google Drive™

An online document storage, editing, sharing and file synchronisation service.

URL: drive.google.com

Evernote®

An online file storage and management service.

URL: www.evernote.com

Dropbox

An online file storage, sharing and synchronisation service.

URL: www.dropbox.com

OneDrive

An online file storage, sharing and management service.

URL: <https://onedrive.live.com>

Box

An online document editing and sharing service.

URL: www.box.com

OneNote

An online document editing and sharing service.

URL: www.onenote.com

Brother Creative Center

A website that offers various templates, such as greeting cards, brochures and calendars that you can print on your Brother machine. (available only for certain countries and models)

<https://www.creativecenter.brother/>

For more information about any of these services, refer to the respective service's website.

The following table describes which file types can be used with each Brother Web Connect feature:

Accessible Services	Google Drive™ Evernote® Dropbox OneDrive Box	OneNote	Brother Creative Center
Download and print images	JPEG PDF DOC DOCX XLS XLSX PPT	JPEG PDF DOC DOCX XLS XLSX PPT PPTX	(Print only)

Accessible Services	Google Drive™ Evernote® Dropbox OneDrive Box	OneNote	Brother Creative Center
	PPTX		
Upload scanned images	JPEG PDF DOCX XLSX PPTX TIFF	JPEG PDF DOCX XLSX PPTX TIFF	-



- Not all services are available in all countries.
- For Hong Kong, Taiwan and Korea:
Brother Web Connect supports only file names written in English. Files named in the local language will not be downloaded.



Related Information

- [Brother Web Connect](#)

Set Up Brother Web Connect

- [Brother Web Connect Setup Overview](#)
- [Create an Account for Each Online Service Before Using Brother Web Connect](#)
- [Apply for Brother Web Connect Access](#)
- [Register an Account on Your Brother Machine for Brother Web Connect](#)
- [Set Up Brother Web Connect for Brother CreativeCenter](#)

Brother Web Connect Setup Overview

Configure the Brother Web Connect settings using the following procedure (when using Brother CreativeCenter, this procedure is not necessary):

Step 1: Create an account with the service you want to use.

Access the service's website using a computer and create an account. (If you already have an account, there is no need to create an additional account.)

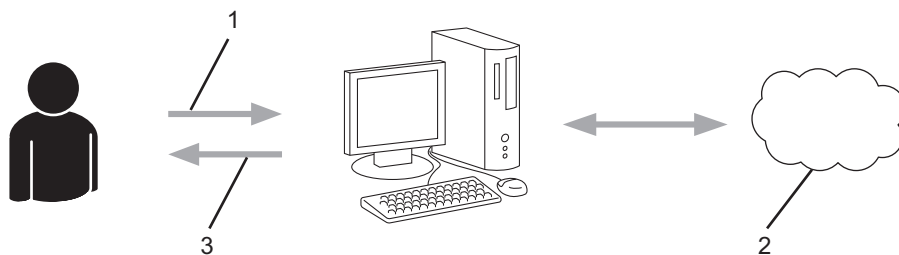

1. User registration
2. Web Service
3. Obtain account

Step 2: Apply for Brother Web Connect access.

Start Brother Web Connect access using a computer and obtain a temporary ID.

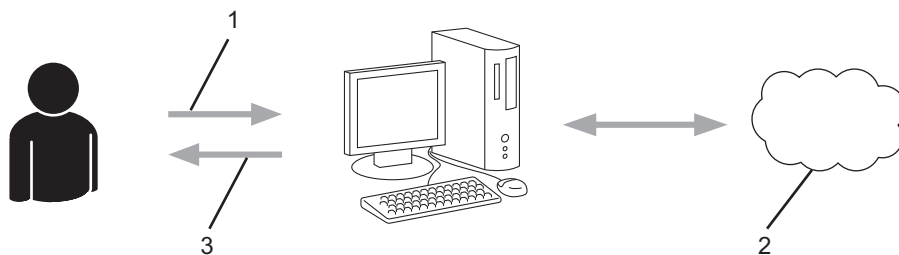

1. Enter account information
2. Brother Web Connect application page
3. Obtain temporary ID

Step 3: Register your account information on your machine so you can access the service you want to use.

Enter the temporary ID to enable the service on your machine. Specify the account name as you would like it to be displayed on the machine, and enter a PIN if you would like to use one.

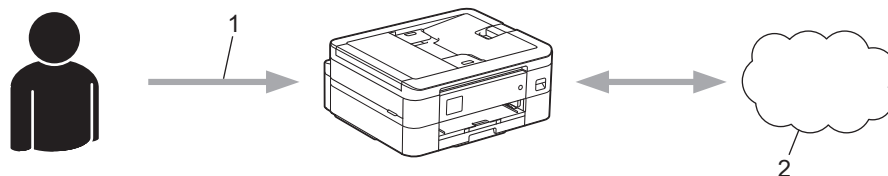

1. Enter temporary ID
2. Web Service

Your Brother machine can now use the service.



Related Information

- [Set Up Brother Web Connect](#)

Create an Account for Each Online Service Before Using Brother Web Connect

To use Brother Web Connect to access an online service, you must have an account with that online service. If you do not already have an account, use a computer to access the service's website and create an account. After creating an account, log on and use the account once with a computer before using the Brother Web Connect feature. Otherwise, you may not be able to access the service using Brother Web Connect.

If you already have an account, there is no need to create an additional account.

After you finish creating an account with the online service you want to use, apply for Brother Web Connect access.





Related Information

- [Set Up Brother Web Connect](#)
-

Apply for Brother Web Connect Access

To use Brother Web Connect to access online services, you must first apply for Brother Web Connect access using a computer that has the Brother Software installed.

1. Access the Brother Web Connect application website:

Option	Description
Windows	Launch  (Brother Utilities), and then click the drop-down list and select your model name (if not already selected). Click Do More in the left navigation bar, and then click Brother Web Connect .
	 You can also access the website directly: Type bwc.brother.com into your web browser's address bar.
Mac	Type bwc.brother.com into your web browser's address bar.

The Brother Web Connect page launches.

2. Select the service you want to use.
3. Follow the on-screen instructions and apply for access.

When finished, your temporary ID will appear.

Get connected with Brother Web Connect

Finished the registration.

Please enter the following temporary ID on the LCD screen of your machine.

Temporary ID (11 digits)

XXX XXXX XXXX

NOTE : The temporary ID will expire in 24 hours.

4. Make a note of your temporary ID, as you will need it to register accounts to the machine. The temporary ID is valid for 24 hours.
5. Close the web browser.

Now that you have a Brother Web Connect access ID, you must register this ID on your machine, and then use your machine to access the web service you want to use.



Related Information

- [Set Up Brother Web Connect](#)

Register an Account on Your Brother Machine for Brother Web Connect

You must enter your Brother Web Connect account information and configure your machine so that it can use Brother Web Connect to access the service you want.

- You must apply for Brother Web Connect access to register an account on your machine.
- Before you register an account, confirm that the correct date and time are set on the machine's control panel.

>> [DCP-J1050DW/MFC-J1010DW](#)

>> [DCP-J1140DW](#)

DCP-J1050DW/MFC-J1010DW

1. Press **WEB**.



- If information regarding the Internet connection appears on the machine's LCD, read the information and press **▶**.
- Occasionally, updates or announcements about Brother Web Connect's features will appear on the LCD. Read the information, and then press **▶**.

2. Press **▲** or **▼** to select the following:

- a. Select the service with which you want to register. Press **OK**.
- b. Select [Register/Delete]. Press **OK**.
- c. Select [Register Account]. Press **OK**.

3. The machine will prompt you to enter the temporary ID you received when you applied for Brother Web Connect access. Press **▶**.

4. Enter the temporary ID using the dial pad. Press **OK**.



An error message will appear on the LCD if the information you entered does not match the temporary ID you received when you applied for access, or if the temporary ID has expired. Either enter the temporary ID correctly, or apply for access again to receive a new temporary ID.

5. The machine will prompt you to enter the account name that you want to be displayed on the LCD. Press **▶**.

6. Enter the name, and then press **OK**.

7. Do one of the following:

- To set a PIN for the account, press **▶**. (A PIN prevents unauthorised access to the account.) Enter a four-digit number, and then press **OK**.
- If you do not want to set a PIN, press **◀**.



When the account information you entered appears, confirm that it is correct.

8. Press **▶** to register your information as entered.

9. Press **▶**.

Account registration is complete and your machine can now access the service.

10. Press **Stop/Exit**.

DCP-J1140DW

1. Press **◀** or **▶** to display [Web].

Press [Web].



- If information regarding the Internet connection appears on the machine's LCD, read the information and press [OK].
- Occasionally, updates or announcements about Brother Web Connect's features will appear on the LCD. Read the information, and then press [OK].

2. Press ▲ or ▼ to display the service with which you want to register.
Press the service name.
3. If information regarding Brother Web Connect appears, press [OK].
4. Press [Register/Delete] > [Register Account].
5. The machine will prompt you to enter the temporary ID you received when you applied for Brother Web Connect access.
Press [OK].
6. Enter the temporary ID using the LCD, and then press [OK].



An error message will appear on the LCD if the information you entered does not match the temporary ID you received when you applied for access, or if the temporary ID has expired. Either enter the temporary ID correctly, or apply for access again and receive a new temporary ID.

7. The machine will prompt you to enter the account name that you want to be displayed on the LCD.
Press [OK].
8. Enter the name using the LCD, and then press [OK].
9. Do one of the following:
 - To set a PIN for the account, press [Yes]. (A PIN prevents unauthorised access to the account.) Enter a four-digit number, and then press [OK].
 - If you do not want to set a PIN, press [No].



When the account information you entered appears, confirm that it is correct.

10. Press [Yes] to register your information as entered.
11. Press [OK].
Account registration is complete and your machine can now access the service.
12. Press .



Related Information

- [Set Up Brother Web Connect](#)

Set Up Brother Web Connect for Brother CreativeCenter

Related Models: DCP-J1140DW

Brother Web Connect is set up to work with Brother CreativeCenter automatically. No configuration is needed to create the calendars, business cards, posters and greeting cards available at <https://www.creativecenter.brother/>.



Brother CreativeCenter is not available in all countries.



Related Information

- [Set Up Brother Web Connect](#)

Scan and Upload Documents Using Brother Web Connect

Upload your scanned photos and documents directly to a web service without using a computer.

- When scanning and uploading JPEG files or searchable PDF, monochrome scanning is not available.
- When scanning and uploading Microsoft Office files, monochrome scanning and grey scanning are not available.
- When scanning and uploading JPEG files, each page is uploaded as a separate file.
- Uploaded documents are saved in an album named **From_BrotherDevice**.

For information regarding restrictions, such as the size or number of documents that can be uploaded, refer to the respective service's website.

>> [DCP-J1050DW/MFC-J1010DW](#)

>> [DCP-J1140DW](#)

DCP-J1050DW/MFC-J1010DW

1. Load your document.
2. Press **WEB**.



- If information regarding the Internet connection appears on the machine's LCD, read the information and press **▶**.
- Occasionally, updates or announcements about Brother Web Connect's features will appear on the LCD. Read the information, and then press **▶**.

3. Press **▲** or **▼** to select the following:
 - a. Select the service that hosts the account to which you want to upload. Press **OK**.
 - b. Select your account name. Press **OK**.
4. If the PIN entry screen appears, enter the four-digit PIN, and then press **OK**.
5. Follow the on-screen instructions to complete this operation.

DCP-J1140DW

1. Load your document.
2. Press **◀** or **▶** to display [Web].
Press [Web].



- You can also press [Scan] > [to Web].
- If information regarding the Internet connection appears on the machine's LCD, read the information and press [OK].
- Occasionally, updates or announcements about Brother Web Connect's features will appear on the LCD. Read the information, and then press [OK].

3. Press **▲** or **▼** to display the service that hosts the account to which you want to upload.
Press the service name.
4. Press **▲** or **▼** to display your account name, and then press it.
5. If the PIN entry screen appears, enter the four-digit PIN and press [OK].
6. Press **▲** or **▼** to display [Upload: Scanner].
Press [Upload: Scanner].



- If you pressed [Scan] > [to Web], this option does not appear.
- This option may not appear depending on the service.

7. Follow the on-screen instructions to complete this operation.



Related Information

- [Brother Web Connect](#)
-

Download and Print Documents Using Brother Web Connect

Documents that have been uploaded to your account can be downloaded directly to your machine and printed. Documents that other users have uploaded to their own accounts for sharing can also be downloaded to your machine and printed, as long as you have viewing privileges for those documents.

To download other users' documents, you must have access privileges to view the corresponding albums or documents.



For Hong Kong, Taiwan and Korea:

Brother Web Connect supports only file names written in English. Files named in the local language will not be downloaded.



Related Information

- [Brother Web Connect](#)
 - [Download and Print Using Web Services](#)
 - [Download and Print Brother CreativeCenter Templates](#)
-

Download and Print Using Web Services

For information on Brother CreativeCenter Templates, see *Related Information*.

>> [DCP-J1050DW/MFC-J1010DW](#)

>> [DCP-J1140DW](#)

DCP-J1050DW/MFC-J1010DW

1. Press **WEB**.



- If information regarding the Internet connection appears on the machine's LCD, read the information and press **▶**.
- Occasionally, updates or announcements about Brother Web Connect's features will appear on the LCD. Read the information, and then press **▶**.

2. Press **▲** or **▼** to select the following:

- a. Select the service that hosts the document you want to download and print. Press **OK**.
- b. Select your account name. Press **OK**.

3. If the PIN entry screen appears, enter the four-digit PIN, and then press **OK**.

4. Press **▲** or **▼** to select the [Download: Print] option, and then press **OK**.

5. Press **▲** or **▼** to select the album you want, and then press **OK**.



- An album is a collection of documents. However, the actual term may differ depending on the service you use. When using Evernote[®], you must select the notebook, and then select the note.
- Some services do not require documents to be saved in albums. For documents not saved in albums, select [See Unsorted Files] to select documents.

6. Press **▲** or **▼** to select the file name you want to print, and then press **OK**. Select additional documents to print (you can select up to 10 documents).

7. When finished, press **OK**.

8. Follow the on-screen instructions to complete this operation.

DCP-J1140DW

1. Press **◀** or **▶** to display [Web].

Press [Web].



- If information regarding the Internet connection appears on the machine's LCD, read the information and press [OK].
- Occasionally, updates or announcements about Brother Web Connect's features will appear on the LCD. Read the information, and then press [OK].

2. Press **▲** or **▼** to display the service that hosts the document you want to download and print.

Press the service name.

3. Press **▲** or **▼** to display your account name, and then press it. If the PIN entry screen appears, enter the four-digit PIN and press [OK].

4. Press **▲** or **▼** to display [Download: Print].

Press [Download: Print].

5. Press **▲** or **▼** to display the album you want, and then press it.



- An album is a collection of documents. However, the actual term may differ depending on the service you use. When using Evernote[®], you must select the notebook, and then select the note.
- Some services do not require documents to be saved in albums. For documents not saved in albums, select `[See Unsorted Files]` to select documents.

6. Press the file name you want to print. Confirm the document on the LCD and press `[OK]`. Select additional documents to print (you can select up to 10 documents).
7. When finished, press `[OK]`.
8. Follow the on-screen instructions to complete this operation.



Related Information

- [Download and Print Documents Using Brother Web Connect](#)

Related Topics:

- [Download and Print Brother CreativeCenter Templates](#)
-

Download and Print Brother CreativeCenter Templates

Related Models: DCP-J1140DW

Brother CreativeCenter is not available in all countries.

1. Press ◀ or ▶ to display [Apps].

Press [Apps].



- If information regarding the Internet connection appears on the machine's LCD, read it, and then press [OK].
- Occasionally, updates or announcements about Brother Web Connect's features will appear on the LCD. Read the information, and then press [OK].

2. Press ▲ or ▼ to display [Print "CreativeCenter" Templates].

Press [Print "CreativeCenter" Templates].

3. Press ▲ or ▼ to display the desired category, and then press it.
4. Select the desired file. Enter the number of copies you want to print and then press [OK]. Repeat this step until you have selected all the files that you want to print.
5. When finished, press [OK].



If information regarding the recommended print settings appears on the machine's LCD, read the information and press [OK].

6. Follow the on-screen instructions to complete this operation.



Related Information

- [Download and Print Documents Using Brother Web Connect](#)

Related Topics:

- [Download and Print Using Web Services](#)

AirPrint

- [AirPrint Overview](#)
- [Before Using AirPrint \(macOS\)](#)
- [Print Using AirPrint](#)
- [Scan Using AirPrint \(macOS\)](#)
- [Send a Fax Using AirPrint \(macOS\)](#)

AirPrint Overview

AirPrint is a printing solution for Apple operating systems that allows you to wirelessly print photos, email, web pages and documents from your iPad, iPhone, iPod touch and Mac computer without the need to install a driver.

AirPrint also lets you send faxes directly from your Mac computer without printing them and lets you scan documents to your Mac computer. (MFC-J1010DW)

For more information, visit Apple's website.

Use of the Works with Apple badge means that an accessory has been designed to work specifically with the technology identified in the badge and has been certified by the developer to meet Apple performance standards.



Related Information

- [AirPrint](#)

Before Using AirPrint (macOS)

Before printing using macOS, add your machine to the printer list on your Mac computer.

1. Select **System Preferences** from the Apple menu.
2. Click **Printers & Scanners**.
3. Click the + icon below the Printers pane on the left.
The **Add** screen appears.
4. Select your machine, and then select **AirPrint** from the **Use** pop-up menu.
5. Click **Add**.



Related Information



- [AirPrint](#)
-

Print Using AirPrint

- [Print from iPad, iPhone, or iPod touch](#)
- [Print Using AirPrint \(macOS\)](#)

Print from iPad, iPhone, or iPod touch

The procedure used to print may vary by application. Safari is used in the example below.

1. Make sure your machine is turned on.
2. Load the paper in the paper tray and change the paper tray settings on your machine, if necessary
3. Use Safari to open the page that you want to print.
4. Tap  or .
5. Tap **Print**.
6. Make sure your machine is selected.
7. If a different machine (or no printer) is selected, tap **Printer**.
A list of available machines appears.
8. Tap your machine's name in the list.
9. Select the options you want, such as the number of pages to print and 2-sided printing (if supported by your machine).
10. Tap **Print**.



Related Information

- [Print Using AirPrint](#)

Print Using AirPrint (macOS)

The procedure used to print may vary by application. Safari is used in the example below. Before printing, make sure your machine is in the printer list on your Mac computer.

1. Make sure your machine is turned on.
Make sure you have loaded the correct paper in the paper tray and change the paper settings for the paper tray on your machine.
2. On your Mac computer, use Safari to open the page that you want to print.
3. Click the **File** menu, and then select **Print**.
4. Make sure your machine is selected. If a different machine (or no printer) is selected, click the **Printer** pop-up menu, and then select your machine.
5. Select the desired options, such as the number of pages to print and 2-sided printing (if supported by your machine).
6. Click **Print**.



Related Information

- [Print Using AirPrint](#)

Related Topics:

- [Before Using AirPrint \(macOS\)](#)

Scan Using AirPrint (macOS)

Before scanning, make sure your machine is in the scanner list on your Mac computer.

1. Load your document.
2. Select **System Preferences** from the Apple menu.
3. Click **Printers & Scanners**.
4. Select your machine from the scanner list.
5. Click the **Scan** tab, and then click the **Open Scanner...** button.
The Scanner screen appears.
6. If you place the document in the ADF, select **Use Document Feeder** check box, and then select the size of your document from the scan size setting pop-up menu.
7. Select the destination folder or destination application from the destination setting pop-up menu.
8. Click **Show Details** to change the scanning settings if needed.
You can crop the image manually by dragging the mouse pointer over the portion you want to scan when scanning from the scanner glass.
9. Click **Scan**.



Related Information

- [AirPrint](#)

Related Topics:

- [Before Using AirPrint \(macOS\)](#)

Send a Fax Using AirPrint (macOS)

Related Models: MFC-J1010DW

Make sure your machine is in the printer list on your Mac computer. Apple TextEdit is used in the example below.



- AirPrint supports only monochrome fax documents.

1. Make sure your machine is turned on.
2. On your Mac computer, open the file that you want to send as a fax.
3. Click the **File** menu, and then select **Print**.
4. Click the **Printer** pop-up menu, and then select **Brother XXX-XXXX - Fax** (where XXX-XXXX is the name of your model).
5. Type the fax recipient information.
6. Click **Fax**.



Related Information

- [AirPrint](#)

Related Topics:

- [Before Using AirPrint \(macOS\)](#)

Mopria® Print Service

Mopria® Print Service is a print feature on Android™ mobile devices developed by the Mopria® Alliance. With this service, you can connect to the same network as your machine and print without additional setup.

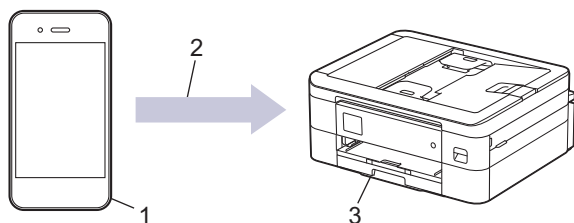

1. Android™ Mobile Device
2. Wi-Fi® Connection
3. Your Machine

You must download the Mopria® Print Service from the Google Play™ and install it on your Android™ device. Before using this service, you must turn it on.

Related Information

- [Mobile/Web Connect](#)

Brother Mobile Connect

Use Brother Mobile Connect to print and scan from your mobile device.

- For Android™ devices

Brother Mobile Connect allows you to use your Brother machine's features directly from your Android™ device.

Download and install Brother Mobile Connect from Google Play™.

- For all iOS or iPadOS supported devices including iPhone, iPad, and iPod touch

Brother Mobile Connect allows you to use your Brother machine's features directly from your iOS or iPadOS device.

Download and install Brother Mobile Connect from the App Store.



Related Information

- [Mobile/Web Connect](#)
-

Brother iPrint&Scan for Windows and Mac

- [Brother iPrint&Scan Overview for Windows and Mac](#)

Brother iPrint&Scan Overview for Windows and Mac

Use Brother iPrint&Scan for Windows and Mac to print and scan from your computer.

The following screen shows an example of Brother iPrint&Scan for Windows. The actual screen may differ depending on the version of the application.

- For Windows
Go to your model's **Downloads** page at support.brother.com to download the latest application.
- For Mac
Download and install Brother iPrint&Scan from the App Store.

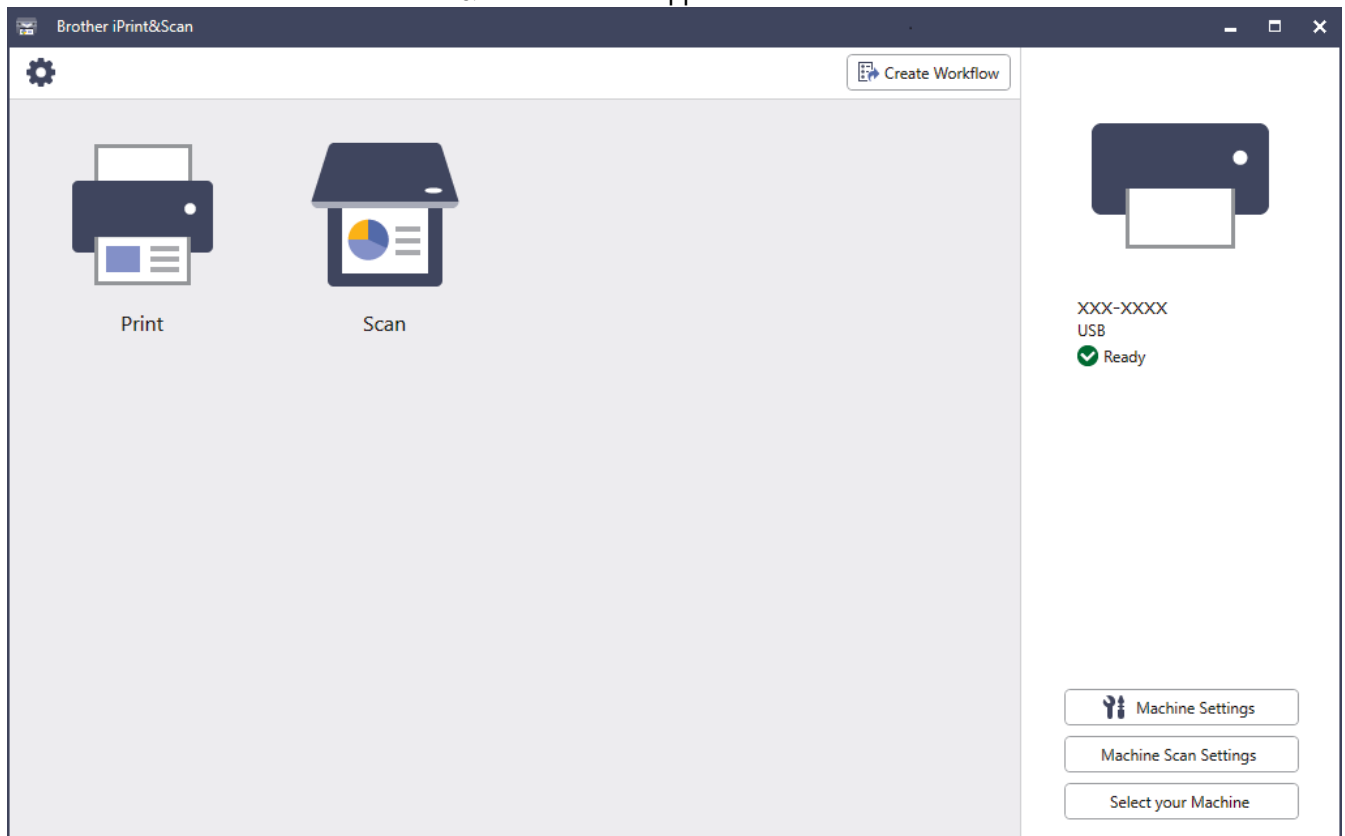

If prompted, install the driver and software necessary to use your machine. Download the installer from your model's **Downloads** page at support.brother.com.

✓ Related Information

- [Brother iPrint&Scan for Windows and Mac](#)

Related Topics:

- [Print Using Brother iPrint&Scan \(Windows/Mac\)](#)
- [Scan Using Brother iPrint&Scan \(Windows/Mac\)](#)
- [Change Scan Settings Using Brother iPrint&Scan](#)
- [Monitor Machine Status Using Brother iPrint&Scan \(Windows/Mac\)](#)

Troubleshooting

If you think there is a problem with your machine, first check each of the items below, then try to identify the problem, and follow our troubleshooting tips.

You can correct most problems yourself. If you need additional help, visit support.brother.com for the latest FAQs and troubleshooting tips:

1. Visit support.brother.com.
2. Click **FAQs & Troubleshooting** and search for your model name.

First, check the following:

- The machine's power cord is connected correctly and the machine's power is on.
- All of the machine's protective parts have been removed.
- The ink cartridges are installed correctly.
- The Scanner Cover and the Jam Clear Cover are fully closed.
- Paper is inserted correctly in the paper tray.
- The interface cables are securely connected to the machine and the computer, or the wireless connection is set up on both the machine and your computer.
- (For network models) The access point (for wireless), router, or hub is turned on and its link indicator is blinking.
- The machine's LCD is displaying messages.

If you did not solve the problem with the checks, identify the problem and then see *Related Information*.



Related Information

- [Error and Maintenance Messages](#)
- [Document Jams](#)
- [Printer Jam or Paper Jam](#)
- [If You Are Having Difficulty with Your Machine](#)
- [Check the Machine Information](#)
- [Reset Your Machine](#)

Related Topics:

- [Paper Handling and Printing Problems](#)
- [Telephone and Fax Problems](#)
- [Other Problems](#)
- [Network Problems](#)
- [AirPrint Problems](#)

Error and Maintenance Messages

As with any sophisticated office product, errors may occur and supply items may have to be replaced. If this happens, your machine identifies the error or required routine maintenance and shows the appropriate message. The most common error and maintenance messages are shown in the table.

You can correct most errors and perform routine maintenance yourself. If you need more tips, go to your model's **FAQs & Troubleshooting** page at support.brother.com.



- *Related Information* references are at the bottom of this page.

>> [DCP-J1050DW/MFC-J1010DW](#)

>> [DCP-J1140DW](#)

DCP-J1050DW/MFC-J1010DW

Error Message	Cause	Action
Absorber NearFull	The ink absorber box is nearly full.	The ink absorber box must be replaced soon. Contact Brother customer service or your local Brother dealer. <ul style="list-style-type: none"> • The ink absorber box absorbs the small amount of ink emitted during print head cleaning.
B&W Print Only	<p>One or more of the colour ink cartridges have reached the end of their lives. You can use the machine in monochrome mode for approximately four weeks depending on the number of pages you print.</p> <p>While this message appears on the LCD, each operation works in the following way:</p> <ul style="list-style-type: none"> • Printing If the media type is set to Plain Paper and you selected Greyscale in the printer driver, you can use the machine as a monochrome printer. • Copying If the paper type is set to Plain Paper, you can make copies in monochrome. • Faxing If the paper type is set to Plain Paper, the machine will receive and print the faxes in monochrome. 	<p>Replace the ink cartridges.</p> <p>See <i>Related Information: Replace the Ink Cartridges</i>.</p> <p>Although the Cause column lists options for using the machine after this error appears, you will not be able to use the machine until you replace one or more of the ink cartridges under the following condition:</p> <ul style="list-style-type: none"> • If you unplug the machine or remove the ink cartridge.
BT Call Sign On	BT Call Sign is set to On. You cannot change the Receive Mode from Manual to another mode.	Set BT Call Sign to Off. See <i>Related Information: Enable the Machine to Work with BT Call Sign (with Your External Telephone only)</i> .
Cannot Clean XX Cannot Start XX Cannot Print XX	<p>The machine has a mechanical problem.</p> <p>-OR-</p> <p>A foreign object, such as a paper clip or a piece of ripped paper, is in the machine.</p>	<p>Open the scanner cover and remove any foreign objects and paper scraps from inside the machine. If the error message continues, disconnect the machine from the power for several minutes, and then reconnect it.</p> <p>See <i>Related Information: Paper is Jammed Inside and in the Front of the Machine (Jam Inside/Front)</i>.</p>

Error Message	Cause	Action
		<p>If you cannot print documents and received faxes, transfer them to another fax machine or to your computer before disconnecting the machine so you will not lose any important messages. Then, disconnect the machine from the power for several minutes and reconnect it.</p> <p><i>See Related Information: Transfer Your Faxes or Fax Journal Report.</i></p>
Cannot Detect	You installed a new ink cartridge too quickly and the machine did not detect it.	Take out the new ink cartridge and reinstall it slowly and firmly until it locks into place.
	An ink cartridge is not installed correctly.	<i>See Related Information: Replace the Ink Cartridges.</i>
	A used ink cartridge was reinstalled.	Remove the used ink cartridge and install a new one.
	If you are using non Brother Original ink, the machine may not detect the ink cartridge.	Replace the ink cartridge with a Brother Original ink cartridge. If the error message remains, contact Brother customer service or your local Brother dealer.
	The ink cartridge must be replaced. The new ink cartridge has an air bubble.	Replace the ink cartridge with a Brother Original ink cartridge. Slowly turn the ink cartridge so that the ink supply port is pointing downwards, and then reinstall the cartridge.
	The wrong Brother model ink cartridge was installed.	Check the model numbers of the ink cartridges and install the correct ink cartridges.
Cannot Detect Ink	If you are using non Brother Original ink, the machine may not detect the ink volume.	Replace the ink cartridge with a Brother Original ink cartridge. If the error message remains, contact Brother customer service or your local Brother dealer.
Cannot Scan XX	The machine has a mechanical problem.	<p>Disconnect the machine from the power for several minutes, and then reconnect it.</p> <p>If you cannot print documents and received faxes, transfer them to another fax machine or to your computer before disconnecting the machine so you will not lose any important messages. Then, disconnect the machine from the power for several minutes and reconnect it.</p> <p><i>See Related Information: Transfer Your Faxes or Fax Journal Report.</i></p>
Comm. Error	Poor telephone line quality caused a communication error.	Send the fax again or connect the machine to another telephone line. If the problem continues, contact the telephone company and ask them to check your telephone line.
Connection Error	Other devices are trying to connect to the Wi-Fi Direct network at the same time.	Make sure there are no other devices trying to connect to the Wi-Fi Direct network, and then try to configure the Wi-Fi Direct settings again.
Connection Failed	The Brother machine and your mobile device cannot communicate during the Wi-Fi Direct network configuration.	<ul style="list-style-type: none"> Move the mobile device closer to your Brother machine. Move your Brother machine and the mobile device to an obstruction-free area.

Error Message	Cause	Action
		<ul style="list-style-type: none"> If you are using the PIN Method of WPS, make sure you have entered the correct PIN.
Cover is Open.	The scanner cover is not locked in the closed position.	Lift the scanner cover and then close it again. Make sure the interface cable (if used) has been guided correctly through the cable channel and out the back of the machine.
	The ink cartridge cover is not locked in the closed position.	Firmly close the ink cartridge cover until it locks into place.
Data Remaining	Print data is left in the machine's memory.	Press Stop/Exit . The machine will cancel the job and clear it from the memory. Try to print again.
Disconnected	The other person or other person's fax machine stopped the call.	Try to send or receive again. If calls are stopped repeatedly and you are using a VoIP (Voice over IP) system, try changing the Compatibility to Basic (for VoIP). <i>See Related Information: Telephone Line Interference/VoIP.</i>
Document Jam	The document was not inserted or fed correctly, or the document scanned from the ADF was too long.	Remove the jammed document, and then press Stop/Exit . Set the document in the ADF correctly. <i>See Related Information: Load Documents in the Automatic Document Feeder (ADF).</i> <i>See Related Information: Document Jams.</i>
High Temperature	The room temperature is too high.	After cooling the room, allow the machine to cool down to room temperature. Try again when the machine has cooled down.
Ink Absorber Full	The ink absorber box is full. These components are periodic maintenance items that may require replacement after a period of time to ensure optimum performance from your Brother machine. Because these components are periodic maintenance items, the replacement is not covered under the warranty. The need to replace these items and the time period before replacement is dependent on the number of purges and flushes required to clean the ink system. These boxes acquire amounts of ink during the different purging and flushing operations. The number of times a machine purges and flushes for cleaning varies depending on different situations. For example, frequently powering the machine on and off will cause numerous cleaning cycles since the machine automatically cleans upon power up. The use of non-Brother ink may cause frequent cleanings because non-Brother ink could cause poor print quality which is resolved by cleaning. The more cleaning the machine requires, the faster these boxes will fill up.	The ink absorber box must be replaced. Contact Brother customer service or your local Brother Authorised Service Centre to have your machine serviced.

Error Message	Cause	Action
	Repairs resulting from the use of non-Brother supplies may not be covered under the stated product warranty.	
Ink Low	The ink level is low. If the sending machine has the ability to convert it, the colour fax will be printed at your machine as a monochrome fax.	Prepare a new ink cartridge. You can continue printing until the LCD displays <i>Replace Ink</i> . See <i>Related Information: Replace the Ink Cartridges</i> . <ul style="list-style-type: none"> You can still scan even if the ink is low or needs to be replaced.
Jam Front Repeat Jam Front	The paper is jammed in the machine.	Gently remove the jammed paper. See <i>Related Information: Paper is Jammed in the Front of the Machine (Jam Front)</i> . Make sure the paper guides are set to the correct paper size.
Jam Inside/Front Repeat Jam	The paper is jammed in the machine.	Gently remove the jammed paper. See <i>Related Information: Paper is Jammed Inside and in the Front of the Machine (Jam Inside/Front)</i> . Make sure the paper guides are set to the correct paper size.
Jam Rear	The paper is jammed in the machine.	Gently remove the jammed paper. See <i>Related Information: Paper is Jammed in the Back of the Machine (Jam Rear)</i> . Make sure the paper guides are set to the correct paper size.
	Paper dust has accumulated on the surface of the paper pick-up rollers.	Clean the paper pick-up rollers. See <i>Related Information: Clean the Paper Pick-up Rollers</i> .
Low Temperature	The room temperature is too low.	After warming the room, allow the machine to warm up to room temperature. Try again when the machine has warmed up.
No Caller ID	There is no incoming call history. You did not receive calls or you have not subscribed to the Caller ID service from your telephone company.	To use the Caller ID feature, contact your telephone company. See <i>Related Information: Caller ID</i> .
No Device	When configuring the Wi-Fi Direct network, the Brother machine cannot find your mobile device.	<ul style="list-style-type: none"> Make sure your machine and mobile device are in the Wi-Fi Direct mode. Move the mobile device closer to your Brother machine. Move your Brother machine and the mobile device to an obstruction-free area. If you are manually configuring the Wi-Fi Direct network, make sure you have entered the correct password. If your mobile device has a configuration page for how to obtain an IP address, make sure the IP address of your mobile device has been configured via DHCP.



Error Message	Cause	Action
No Ink Cartridge	An ink cartridge is not installed correctly.	Remove the ink cartridge and re-install it slowly and firmly until it locks into place. <i>See Related Information: Replace the Ink Cartridges.</i>
No Paper Fed	The machine is out of paper or paper is not correctly loaded in the paper tray.	Do one of the following: <ul style="list-style-type: none"> • Refill the paper tray, and then press ►. • Remove and reload the paper, and then press ►. <i>See Related Information: Load Paper.</i>
	The Jam Clear Cover is not closed correctly.	Make sure the Jam Clear Cover is closed evenly at both ends. <i>See Related Information: Printer Jam or Paper Jam.</i>
	Paper dust has accumulated on the surface of the paper pick-up rollers.	Clean the paper pick-up rollers. <i>See Related Information: Clean the Paper Pick-up Rollers.</i>
No Paper Fed Again	Paper dust has accumulated on the surface of the paper pick-up rollers.	Clean the paper pick-up rollers. <i>See Related Information: Clean the Paper Pick-up Rollers.</i>
No Response/Busy	The number you dialed does not answer or is busy.	Verify the number and try again.
Not Registered	You tried to access a Speed Dial number that has not been stored in the machine.	Set up the Speed Dial number.
Out of Fax Memory	The fax memory is full.	Print the faxes that are in the memory. <i>See Related Information: Print a Fax Stored in the Machine's Memory.</i>
Out of Memory	The machine's memory is full.	If a fax-sending or copy operation is in progress: <ul style="list-style-type: none"> • Press Stop/Exit and wait until the other operations that are in progress finish, and then try again. • Press ► to select Partial Print to copy the pages scanned so far. • Print the faxes that are in the memory. <i>See Related Information: Print a Fax Stored in the Machine's Memory.</i>
Paper Size Mismatch	The paper size setting does not match the size of paper in the tray. -OR- You did not set the paper guides in the tray to the indicators for the paper size you are using.	1. Check that the paper size you chose on the machine's display matches the size of the paper in the tray. <i>See Related Information: Change the Paper Size and Paper Type.</i> 2. Make sure you loaded the paper in a Portrait position, by setting the paper guides at the indicators for your paper size. <i>See Related Information: Load Paper.</i> 3. After you have checked the paper size and the paper position, press ►.
		If you are printing from your computer, make sure the paper size you selected in the printer driver or in the application you use to print matches the size of paper in the tray.

Error Message	Cause	Action
Paper Size Mismatch	The paper size setting does not match the size of paper in the tray. -OR- You did not set the paper guides in the tray to the indicators for the paper size you are using.	See <i>Related Information: Print Settings (Windows)</i> .
Replace Ink	One or more of the ink cartridges have reached the end of their lives. The machine will stop all print operations. While memory is available, monochrome faxes will be stored in the memory. If the sending machine has the ability to convert it, the colour fax will be stored in the memory as a monochrome fax.	Replace the ink cartridges. See <i>Related Information: Replace the Ink Cartridges</i> . <ul style="list-style-type: none"> You can still scan even if the ink is low or needs to be replaced.
The maximum number of devices are already connected using Wi-Fi Direct.	The maximum number of mobile devices are already connected to the Wi-Fi Direct network when the Brother machine is the Group Owner.	After the current connection between your Brother machine and another mobile device has shut down, try to configure the Wi-Fi Direct settings again. You can confirm the connection status by printing the Network Configuration Report. See <i>Related Information: Print the Network Configuration Report</i> .
Tray not detected	The paper tray is not completely inserted.	Slowly push the paper tray completely into the machine.
	Paper or a foreign object has prevented the paper tray from being inserted correctly.	Pull the paper tray out of the machine, and remove the jammed paper or foreign object. If you cannot find or remove the jammed paper, see <i>Related Information: Printer Jam or Paper Jam</i> .
Tray Settings	This message is displayed when the setting to confirm the paper type and size is enabled.	To not display this confirmation message, change the setting to Off. See <i>Related Information: Change the Check Paper Setting</i> .
Wrong Ink Cartridge	The ink cartridge model number is not compatible with your machine.	Verify whether the cartridge model number will work with your machine.
Wrong Ink Colour	An ink cartridge has been installed in the wrong position.	Check which ink cartridges are not matched by colour to their ink cartridge positions and move them to their correct positions.

DCP-J1140DW

Error Message	Cause	Action
B&W Print Only	One or more of the colour ink cartridges have reached the end of their lives. You can use the machine in monochrome mode for approximately four weeks depending on the number of pages you print. While this message appears on the LCD, each operation works in the following way: <ul style="list-style-type: none"> Printing If the media type is set to Plain Paper and you selected Greyscale in the printer driver, you can use the machine as a monochrome printer. 	Replace the ink cartridges. See <i>Related Information: Replace the Ink Cartridges</i> . Although the Cause column lists options for using the machine after this error appears, you may not be able to use the machine until you replace one or more of the ink cartridges under the following condition: <ul style="list-style-type: none"> If you unplug the machine or remove the ink cartridge.

Error Message	Cause	Action
	<ul style="list-style-type: none"> Copying <p>If the paper type is set to Plain Paper, you can make copies in monochrome.</p>	
Cannot Clean XX Cannot Initialise XX Cannot Print XX	<p>The machine has a mechanical problem.</p> <p>-OR-</p> <p>A foreign object, such as a paper clip or a piece of ripped paper, is in the machine.</p>	<p>Open the scanner cover and remove any foreign objects and paper scraps from inside the machine. If the error message continues, disconnect the machine from the power for several minutes, and then reconnect it.</p> <p><i>See Related Information: Paper is Jammed Inside and in the Front of the Machine (Jam Inside/Front).</i></p> <p><i>See Related Information: Transfer Your Faxes or Fax Journal Report.</i></p>
Cannot Detect	You installed a new ink cartridge too quickly and the machine did not detect it.	Take out the new ink cartridge and reinstall it slowly and firmly until it locks into place.
	An ink cartridge is not installed correctly.	<i>See Related Information: Replace the Ink Cartridges.</i>
	If you are using non Brother Original ink, the machine may not detect the ink cartridge.	Replace the ink cartridge with a Brother Original ink cartridge. If the error message remains, contact Brother customer service or your local Brother dealer.
	The new ink cartridge has an air bubble.	Slowly turn the ink cartridge so that the ink supply port is pointing downwards, and then reinstall the cartridge.
	The wrong Brother model ink cartridge was installed.	Check the model numbers of the ink cartridges and install the correct ink cartridges.
Cannot Detect Ink Volume	If you are using non Brother Original ink, the machine may not detect the ink volume.	Replace the ink cartridge with a Brother Original ink cartridge. If the error message remains, contact Brother customer service or your local Brother dealer.
Cannot Scan XX	The machine has a mechanical problem.	Disconnect the machine from the power for several minutes, and then reconnect it. <i>See Related Information: Transfer Your Faxes or Fax Journal Report.</i>
Connection Error	Other devices are trying to connect to the Wi-Fi Direct network at the same time.	Make sure there are no other devices trying to connect to the Wi-Fi Direct network, and then try to configure the Wi-Fi Direct settings again.
Connection Failed	The Brother machine and your mobile device cannot communicate during the Wi-Fi Direct network configuration.	<ul style="list-style-type: none"> Move the mobile device closer to your Brother machine. Move your Brother machine and the mobile device to an obstruction-free area. If you are using the PIN Method of WPS, make sure you have entered the correct PIN.
Cover is Open.	The scanner cover is not locked in the closed position.	Lift the scanner cover and then close it again.
		Make sure the interface cable (if used) has been guided correctly through the cable channel and out the back of the machine.

Error Message	Cause	Action
Cover is Open.	The ink cartridge cover is not locked in the closed position.	Firmly close the ink cartridge cover until it locks into place.
Data Remaining in Memory	Print data is left in the machine's memory.	Press  . The machine will cancel the job and clear it from the memory. Try to print again.
Document Jam/too Long	The document was not inserted or fed correctly, or the document scanned from the ADF was too long.	Remove the jammed document, and then press  . Set the document in the ADF correctly. <i>See Related Information: Load Documents in the Automatic Document Feeder (ADF).</i> <i>See Related Information: Document Jams.</i>
High Temperature	The room temperature is too high.	After cooling the room, allow the machine to cool down to room temperature. Try again when the machine has cooled down.
Ink Absorber NearFull	The ink absorber box is nearly full.	The ink absorber box must be replaced soon. Contact Brother customer service or your local Brother dealer. <ul style="list-style-type: none"> The ink absorber box absorbs the small amount of ink emitted during print head cleaning.
Ink Absorber Pad Full	The ink absorber box is full. These components are periodic maintenance items that may require replacement after a period of time to ensure optimum performance from your Brother machine. Because these components are periodic maintenance items, the replacement is not covered under the warranty. The need to replace these items and the time period before replacement is dependent on the number of purges and flushes required to clean the ink system. These boxes acquire amounts of ink during the different purging and flushing operations. The number of times a machine purges and flushes for cleaning varies depending on different situations. For example, frequently powering the machine on and off will cause numerous cleaning cycles since the machine automatically cleans upon power up. The use of non-Brother ink may cause frequent cleanings because non-Brother ink could cause poor print quality which is resolved by cleaning. The more cleaning the machine requires, the faster these boxes will fill up. Repairs resulting from the use of non-Brother supplies may not be covered under the stated product warranty.	The ink absorber box must be replaced. Contact Brother customer service or your local Brother Authorised Service Centre to have your machine serviced.
Ink Low	The ink level is low. If the sending machine has the ability to convert it, the colour fax will be printed at your machine as a monochrome fax.	Prepare a new ink cartridge. You can continue printing until the touchscreen displays <code>Replace Ink</code> . <i>See Related Information: Replace the Ink Cartridges.</i>

Error Message	Cause	Action
		<ul style="list-style-type: none"> You can still scan even if the ink is low or needs to be replaced.
Jam Front Repeat Jam Front	The paper is jammed in the machine.	<p>Gently remove the jammed paper.</p> <p>See <i>Related Information: Paper is Jammed in the Front of the Machine (Jam Front)</i>.</p> <p>Make sure the paper guides are set to the correct paper size.</p>
Jam Inside/Front Repeat Jam Inside/Front	The paper is jammed in the machine.	<p>Gently remove the jammed paper.</p> <p>See <i>Related Information: Paper is Jammed Inside and in the Front of the Machine (Jam Inside/Front)</i>.</p> <p>Make sure the paper guides are set to the correct paper size.</p>
Jam Rear	The paper is jammed in the machine.	<p>Gently remove the jammed paper.</p> <p>See <i>Related Information: Paper is Jammed in the Back of the Machine (Jam Rear)</i>.</p> <p>Make sure the paper guides are set to the correct paper size.</p>
	Paper dust has accumulated on the surface of the paper pick-up rollers.	<p>Clean the paper pick-up rollers.</p> <p>See <i>Related Information: Clean the Paper Pick-up Rollers</i>.</p>
Low Temperature	The room temperature is too low.	After warming the room, allow the machine to warm up to room temperature. Try again when the machine has warmed up.
No Device No device found.	When configuring the Wi-Fi Direct network, the Brother machine cannot find your mobile device.	<ul style="list-style-type: none"> Make sure your machine and mobile device are in the Wi-Fi Direct mode. Move the mobile device closer to your Brother machine. Move your Brother machine and the mobile device to an obstruction-free area. If you are manually configuring the Wi-Fi Direct network, make sure you have entered the correct password. If your mobile device has a configuration page for how to obtain an IP address, make sure the IP address of your mobile device has been configured via DHCP.
No Ink Cartridge	An ink cartridge is not installed correctly.	<p>Remove the ink cartridge and re-install it slowly and firmly until it locks into place.</p> <p>See <i>Related Information: Replace the Ink Cartridges</i>.</p>
No Paper Fed	The machine is out of paper or paper is not correctly loaded in the paper tray.	<p>Do one of the following:</p> <ul style="list-style-type: none"> Refill the paper tray, and then follow the LCD instructions. Remove and reload the paper, and then follow the LCD instructions. <p>See <i>Related Information: Load Paper</i>.</p>
	The Jam Clear Cover is not closed correctly.	Make sure the Jam Clear Cover is closed evenly at both ends.

Error Message	Cause	Action
No Paper Fed		See <i>Related Information: Printer Jam or Paper Jam</i> .
	Paper dust has accumulated on the surface of the paper pick-up rollers.	Clean the paper pick-up rollers. See <i>Related Information: Clean the Paper Pick-up Rollers</i> .
Paper Size Mismatch	The paper size setting does not match the size of paper in the tray. -OR- You did not set the paper guides in the tray to the indicators for the paper size you are using.	<ol style="list-style-type: none"> 1. Check that the paper size you selected on the machine's display matches the size of the paper in the tray. See <i>Related Information: Change the Paper Size and Paper Type</i>. 2. Make sure you loaded the paper in the correct orientation and set the paper guides at the indicators for your paper size. See <i>Related Information: Load Paper</i>. 3. After you have checked the paper size and the paper orientation, follow the LCD instructions.
		If you are printing from your computer, make sure the paper size you selected in the printer driver or in the application you use to print matches the size of paper in the tray. See <i>Related Information: Print Settings (Windows)</i> .
Paper Tray not detected	The paper tray is not completely inserted.	Slowly push the paper tray completely into the machine.
	Paper or a foreign object has prevented the paper tray from being inserted correctly.	Pull the paper tray out of the machine, and remove the jammed paper or foreign object. If you cannot find or remove the jammed paper, see <i>Related Information: Printer Jam or Paper Jam</i> .
Repetitive No Paper Fed	The machine is out of paper or paper is not correctly loaded in the paper tray.	Do one of the following: <ul style="list-style-type: none"> • Refill the paper tray, and then follow the LCD instructions. • Remove and reload the paper, and then follow the LCD instructions. See <i>Related Information: Load Paper</i> .
	Paper dust has accumulated on the surface of the paper pick-up rollers.	Clean the paper pick-up rollers. See <i>Related Information: Clean the Paper Pick-up Rollers</i> .
Replace Ink	One or more of the ink cartridges have reached the end of their lives. The machine will stop all print operations. While memory is available, monochrome faxes will be stored in the memory. If the sending machine has the ability to convert it, the colour fax will be stored in the memory as a monochrome fax.	Replace the ink cartridges. See <i>Related Information: Replace the Ink Cartridges</i> . <ul style="list-style-type: none"> • You can still scan even if the ink is low or needs to be replaced.
The maximum number of devices are already connected using Wi-Fi Direct.	The maximum number of mobile devices are already connected to the Wi-Fi Direct network when the Brother machine is the Group Owner.	After the current connection between your Brother machine and another mobile device has shut down, try to configure the Wi-Fi Direct settings again. You can confirm the connection status by printing the Network Configuration Report.

Error Message	Cause	Action
		See <i>Related Information: Print the Network Configuration Report</i> .
Touchscreen Init. Failed	The touchscreen was pressed before the power on initialisation was completed.	Make sure nothing is touching or resting on the touchscreen, especially when plugging the machine in.
	Debris may be stuck between the lower part of the touchscreen and its frame.	Insert a piece of stiff paper between the lower part of the touchscreen and its frame and slide it back and forth to push out the debris.
Tray Settings	This message is displayed when the setting to confirm the paper type and size is enabled.	To not display this confirmation message, change the setting to Off. See <i>Related Information: Change the Check Paper Setting</i> .
Wrong Ink Cartridge	The ink cartridge model number is not compatible with your machine.	Verify whether the cartridge model number will work with your machine.
Wrong Ink Colour	An ink cartridge has been installed in the wrong position.	Check which ink cartridges are not matched by colour to their ink cartridge positions and move them to their correct positions.



Related Information

- [Troubleshooting](#)
 - [Transfer Your Faxes or Fax Journal Report](#)
 - [Error Messages When Using the Brother Web Connect Feature](#)

Related Topics:

- [Touchscreen LCD Overview](#)
- [Print the Network Configuration Report](#)
- [Replace the Ink Cartridges](#)
- [Change the Check Paper Setting](#)
- [Telephone Line Interference/VoIP](#)
- [Load Documents in the Automatic Document Feeder \(ADF\)](#)
- [Document Jams](#)
- [Enable the Machine to Work with BT Call Sign \(with Your External Telephone only\)](#)
- [Caller ID](#)
- [Load Paper](#)
- [Printer Jam or Paper Jam](#)
- [Clean the Paper Pick-up Rollers](#)
- [Print a Fax Stored in the Machine's Memory](#)
- [Change the Paper Size and Paper Type](#)
- [Print Settings \(Windows\)](#)
- [Paper is Jammed Inside and in the Front of the Machine \(Jam Inside/Front\)](#)
- [Paper is Jammed in the Front of the Machine \(Jam Front\)](#)
- [Paper is Jammed in the Back of the Machine \(Jam Rear\)](#)
- [Paper Handling and Printing Problems](#)

Transfer Your Faxes or Fax Journal Report

Related Models: MFC-J1010DW

If the LCD shows:

- [Cannot Clean XX]
- [Cannot Start XX]
- [Cannot Print XX]
- [Cannot Scan XX]

We recommend transferring your faxes to another fax machine or to your computer.

See *Related Information: Transfer Faxes to Another Fax Machine*.

See *Related Information: Transfer Faxes to Your Computer*.

You can also transfer the Fax Journal report to see if there are any faxes you must transfer.

See *Related Information: Transfer the Fax Journal Report to Another Fax Machine*.



Related Information

- [Error and Maintenance Messages](#)
 - [Transfer Faxes to Another Fax Machine](#)
 - [Transfer Faxes to Your Computer](#)
 - [Transfer the Fax Journal Report to Another Fax Machine](#)

Related Topics:

- [Use PC-Fax Receive to Transfer Received Faxes to Your Computer \(Windows only\)](#)
- [Reset the Network Settings to Factory Default](#)
- [Reset Your Machine](#)
- [Reset Functions Overview](#)

Transfer Faxes to Another Fax Machine

Related Models: MFC-J1010DW

If you have not set up your Station ID, you cannot enter Fax Transfer mode.

1. Press **Stop/Exit** to clear the error temporarily.
2. Press **Settings**.
3. Press **▲** or **▼** to make your selections:
 - a. Select [Service]. Press **OK**.
 - b. Select [Data Transfer]. Press **OK**.
 - c. Select [Fax Transfer]. Press **OK**.
4. Do one of the following:
 - If the LCD displays [No Data], there are no faxes left in the machine's memory. Press **▶**, and then press **Stop/Exit**.
 - Enter the fax number where faxes will be forwarded.
5. Press **Mono Start**.



Related Information

- [Transfer Your Faxes or Fax Journal Report](#)

Related Topics:

- [Set Your Station ID](#)

Transfer Faxes to Your Computer

Related Models: MFC-J1010DW

You can transfer the faxes from your machine's memory to your computer.

1. Press **Stop/Exit** to clear the error temporarily.
2. Make sure you have installed the Brother software and drivers on your computer, and then turn on **PC-FAX Receive** on the computer.
3. Launch  (**Brother Utilities**), and then click the drop-down list and select your model name (if not already selected).
4. Click **PC-FAX** in the left navigation bar, and then click **Receive**.
5. Read and confirm the instructions on your computer.

Faxes in the machine's memory will be sent to your computer automatically.



When faxes in the machine's memory are not sent to your computer:

Make sure you have set [PC Fax Receive] on the machine.

Press **▲** or **▼** to select [Backup Print: On] or [Backup Print: Off]. Press **OK**.

If faxes are in the machine's memory when you set up PC-Fax Receive, an LCD message prompts you to transfer the faxes to your computer.

Press **▶** to transfer all faxes in the memory to your computer.



Related Information

- [Transfer Your Faxes or Fax Journal Report](#)

Related Topics:

- [Use PC-Fax Receive to Transfer Received Faxes to Your Computer \(Windows only\)](#)

Transfer the Fax Journal Report to Another Fax Machine

Related Models: MFC-J1010DW

If you have not set up your Station ID, you cannot enter fax transfer mode.

1. Press **Stop/Exit** to clear the error temporarily.
2. Press **Settings**.
3. Press **▲** or **▼** to make your selections:
 - a. Select [Service]. Press **OK**.
 - b. Select [Data Transfer]. Press **OK**.
 - c. Select [Report Transfer]. Press **OK**.
4. Enter the fax number where Fax Journal report will be forwarded.
5. Press **Mono Start**.



Related Information

- [Transfer Your Faxes or Fax Journal Report](#)

Related Topics:

- [Set Your Station ID](#)

Error Messages When Using the Brother Web Connect Feature

Your Brother machine displays an error message if an error occurs. The most common error messages are shown in the chart.

You can correct most errors yourself. If you need more tips, go to your model's **FAQs & Troubleshooting** page at support.brother.com.

Connection Error

Error Messages	Cause	Action
(DCP-J1050DW/MFC-J1010DW) Connection Error 02 (DCP-J1140DW) Connection Error 02	The machine is not connected to a network.	(DCP-J1050DW/MFC-J1010DW) <ul style="list-style-type: none"> Verify that the network connection is good. If WEB was pressed soon after the machine was turned on, the network connection may not have been established yet. Wait and try again. (DCP-J1140DW) <ul style="list-style-type: none"> Verify that the network connection is good. If the Web or Apps option was pressed soon after the machine was turned on, the network connection may not have been established yet. Wait and try again.
(DCP-J1050DW/MFC-J1010DW) Connection Error 03 (DCP-J1140DW) Connection Error 03	<ul style="list-style-type: none"> Network or server settings are incorrect. There is a problem with the network or server. 	(DCP-J1050DW/MFC-J1010DW) <ul style="list-style-type: none"> Confirm that network settings are correct, or wait and try again later. If WEB was pressed soon after the machine was turned on, the network connection may not have been established yet. Wait and try again. (DCP-J1140DW) <ul style="list-style-type: none"> Confirm that network settings are correct, or wait and try again later. If the Web or Apps option was pressed soon after the machine was turned on, the network connection may not have been established yet. Wait and try again.
(DCP-J1050DW/MFC-J1010DW) Connection Error 07 (DCP-J1140DW) Connection Error 07	Date and time settings are incorrect.	Set the date and time correctly. Note that if the machine's power cord is disconnected, the date and time settings may have reset to factory settings.

Authentication Error

Error Messages	Cause	Action
Authentication Error 01	The PIN you entered to access the account is incorrect. The PIN is the four-digit number that was entered when registering the account to the machine.	Enter the correct PIN.
Authentication Error 02	The temporary ID that was entered is incorrect.	Enter the correct temporary ID.
	The temporary ID that was entered has expired. A temporary ID is valid for 24 hours.	Apply for Brother Web Connect access again and receive a new temporary ID, and then use the new ID to register the account to the machine.
Authentication Error 03	The name you entered as the display name has already been registered to another service user.	Enter a different display name.

Server Error

Error Messages	Cause	Action
Server Error 01	The machine's authentication information (needed to access the service) has expired or is invalid.	Apply for Brother Web Connect access again to receive a new temporary ID, and then use the new ID to register the account to the machine.
Server Error 03	The file you are trying to upload may have one of the following problems: <ul style="list-style-type: none">• The file exceeds the service's limit on number of pixels, file size, etc.• The file type is not supported.• The file is corrupted.	The file cannot be used: <ul style="list-style-type: none">• Check the service's size or format restrictions.• Save the file as a different type.• If possible, get a new, uncorrupted version of the file.
Server Error 13	There is a problem with the service and it cannot be used now.	Wait and try again. If you get the message again, access the service from a computer to confirm if it is unavailable.

Shortcut Error

Error Messages	Cause	Action
Shortcut Error 02	The shortcut cannot be used because the account was deleted after the shortcut was registered.	Delete the shortcut, and then register the account and shortcut again.



Related Information

- [Error and Maintenance Messages](#)

Document Jams

Related Models: MFC-J1010DW

- [Document is Jammed in the Top of the ADF Unit](#)
- [Document is Jammed inside the ADF Unit](#)
- [Remove Paper Scraps Jammed in the ADF](#)
- [Error and Maintenance Messages](#)

Document is Jammed in the Top of the ADF Unit

Related Models: MFC-J1010DW

1. Remove any paper from the ADF that is not jammed.
2. Open the ADF cover.
3. Remove the jammed document by pulling it upwards.

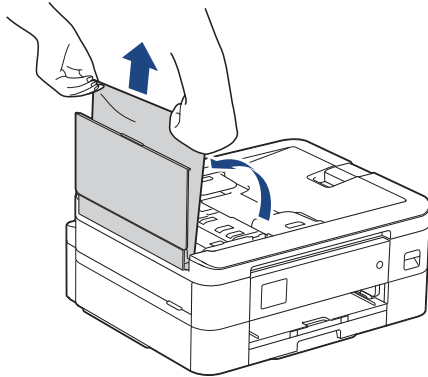

4. Close the ADF cover.
5. Press **Stop/Exit** or .

IMPORTANT

To avoid future document jams, close the ADF cover correctly by pressing it down in the centre.



Related Information

- [Document Jams](#)

Document is Jammed inside the ADF Unit

Related Models: MFC-J1010DW

1. Remove any paper from the ADF that is not jammed.
2. Lift the document cover.
3. Pull the jammed document out to the left.

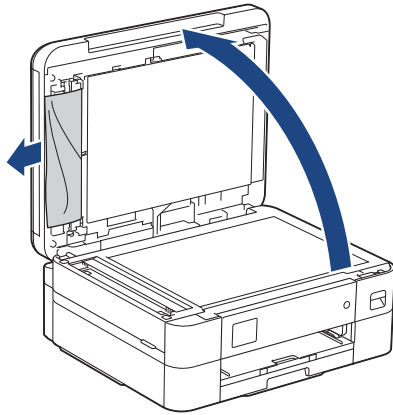

4. Close the document cover.
5. Press **Stop/Exit** or .



Related Information

- [Document Jams](#)

Remove Paper Scraps Jammed in the ADF

Related Models: MFC-J1010DW

1. Lift the document cover.
2. Insert a piece of stiff paper, such as cardstock, into the ADF to push any small paper scraps through.

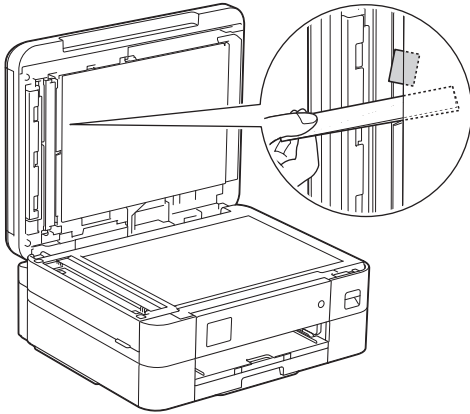

3. Close the document cover.
4. Press **Stop/Exit** or .



Related Information

- [Document Jams](#)

Printer Jam or Paper Jam

Locate and remove the jammed paper.

- [Paper is Jammed Inside and in the Front of the Machine \(Jam Inside/Front\)](#)
- [Paper is Jammed in the Front of the Machine \(Jam Front\)](#)
- [Paper is Jammed in the Back of the Machine \(Jam Rear\)](#)
- [Error and Maintenance Messages](#)
- [Paper Handling and Printing Problems](#)

Paper is Jammed Inside and in the Front of the Machine (Jam Inside/Front)

If the LCD displays [Jam Inside/Front], [Repeat Jam Inside/Front] or [Repeat Jam], follow these steps:

1. Unplug the machine from the electrical socket.

IMPORTANT

(MFC-J1010DW)

Before you unplug the machine from the power source, you can transfer your faxes that are stored in the machine's memory to your computer or another fax machine so you will not lose any important messages.

2. Pull the paper tray (1) completely out of the machine as shown by the arrow.

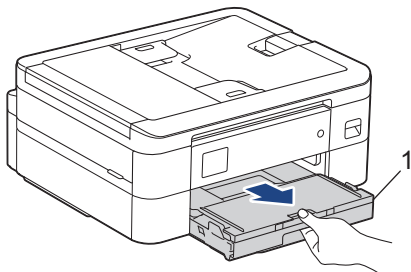

3. Pull the two green levers inside the machine to release the jammed paper.

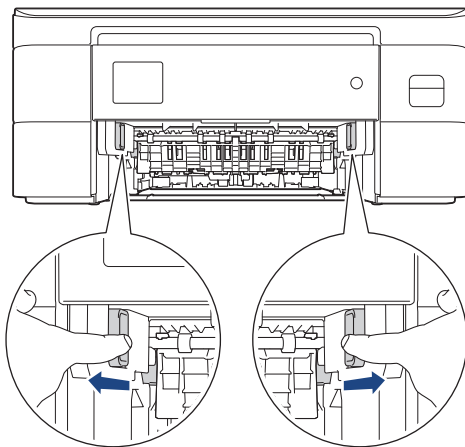

4. Slowly pull the jammed paper (1) out of the machine.

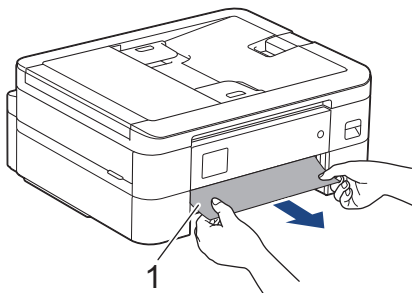

5. Place both hands under the plastic tabs on both sides of the machine to lift the scanner cover (1) into the open position.

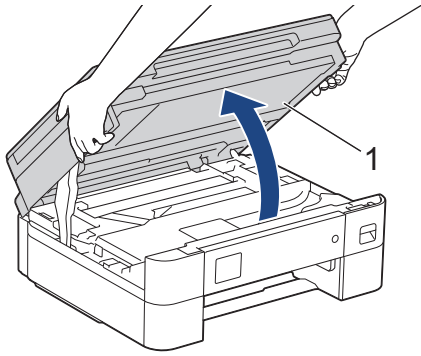

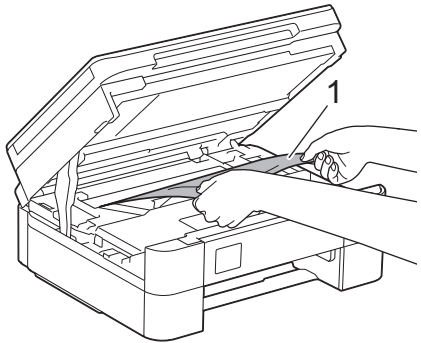

6. Slowly pull the jammed paper (1) out of the machine.

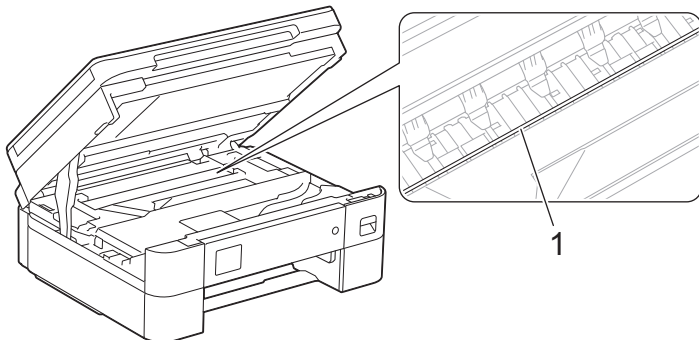

IMPORTANT

- DO NOT touch the encoder strip, a thin strip of plastic that stretches across the width of the machine (1). Doing this may cause damage to the machine.



- If the print head is in the right corner as shown in the illustration (2), you cannot move it. Follow these steps:
 - a. Close the scanner cover, and then reconnect the power cord.
 - b. Open the scanner cover again, and then press and hold **Stop/Exit** or  until the print head moves to the centre.
 - c. Unplug the machine from the power source and gently remove the jammed paper.

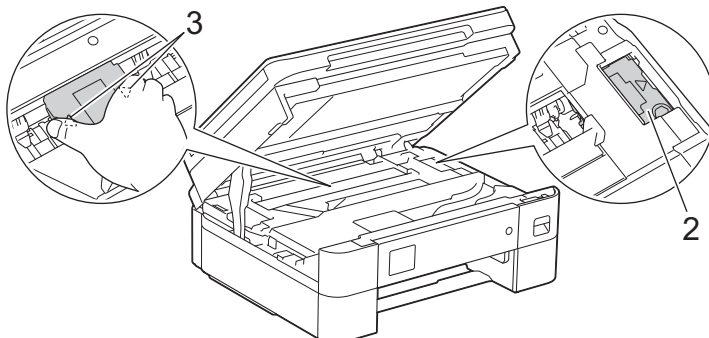

-
- If the paper is jammed under the print head, unplug the machine from the power source, and then move the print head to remove the paper.
Hold the concave areas with the triangle marks as shown in the illustration (3) to move the print head.
 - If ink gets on your skin or clothing, immediately wash it off with soap or detergent.
-



If your LCD error message was [Repeat Jam Inside/Front] or [Repeat Jam], move the print head (if needed) to remove any paper remaining in this area. Make sure scraps of paper are not left in the corners of the machine (1) and (2).

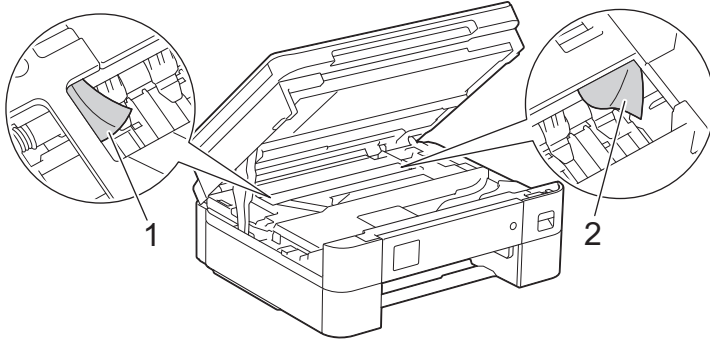

7. Gently close the scanner cover using both hands.

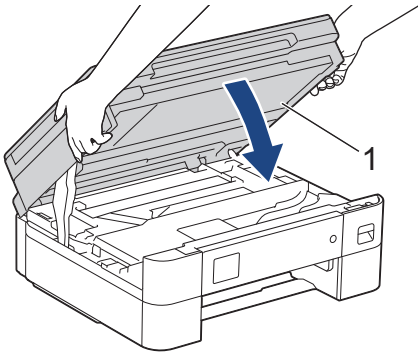



If your LCD error message was [Repeat Jam Inside/Front] or [Repeat Jam], do the following:

- a. Make sure you look carefully inside (1) for any scraps of paper.

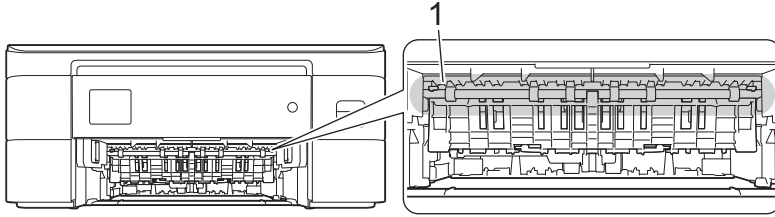

- b. Squeeze both levers (1), and then open the Jam Clear Cover at the back of the machine.

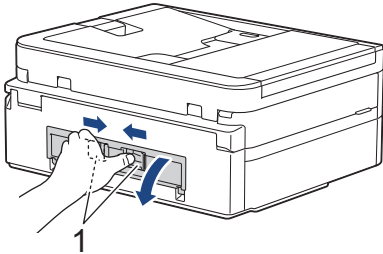

- c. Slowly pull the jammed paper out of the machine.

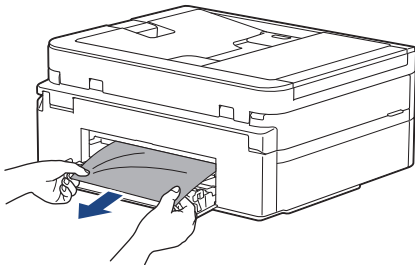

- d. Close the Jam Clear Cover. Make sure the cover is closed completely.

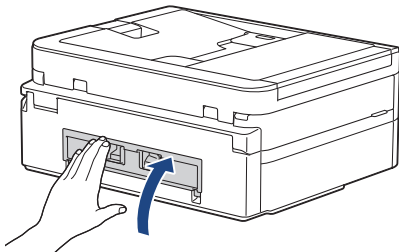

-
8. Slowly push the paper tray completely into the machine.

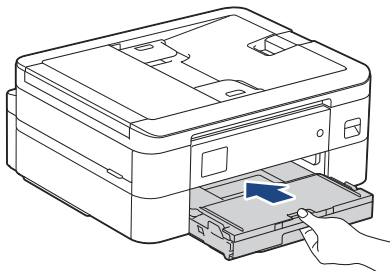

9. Pull out the paper support (1) until it locks into place, and then unfold the paper support flap (2).

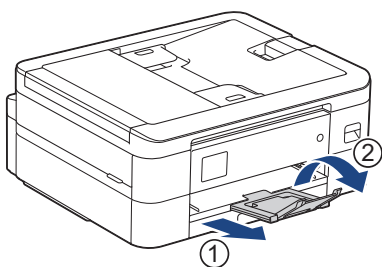

10. Reconnect the power cord.



Related Information

- [Printer Jam or Paper Jam](#)

Related Topics:

- [Error and Maintenance Messages](#)
-

Paper is Jammed in the Front of the Machine (Jam Front)

If the LCD displays [Jam Front] or [Repeat Jam Front], follow these steps:

1. Unplug the machine from the electrical socket.

IMPORTANT

(MFC-J1010DW)

Before you unplug the machine from the power source, you can transfer your faxes that are stored in the machine's memory to your computer or another fax machine so you will not lose any important messages.

2. Pull the paper tray (1) completely out of the machine as shown by the arrow.

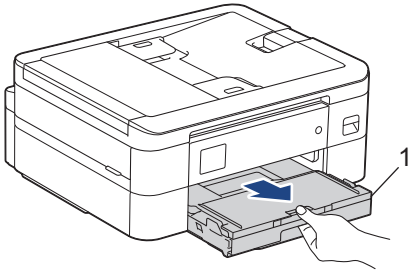

3. Pull the two green levers inside the machine to release the jammed paper.

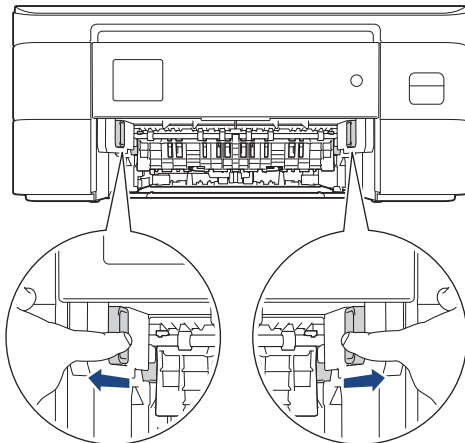

4. Slowly pull out the jammed paper (1).

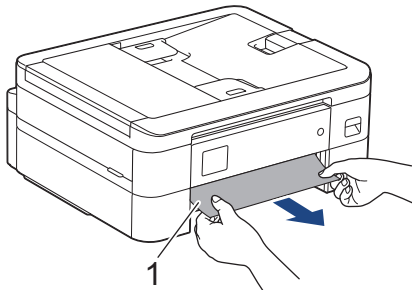



If your LCD error message was [Repeat Jam Front], do the following:

- a. Make sure you look carefully inside (1) for any scraps of paper.

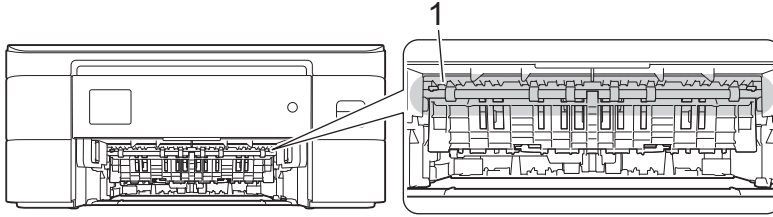

- b. Squeeze both levers (1), and then open the Jam Clear Cover at the back of the machine.

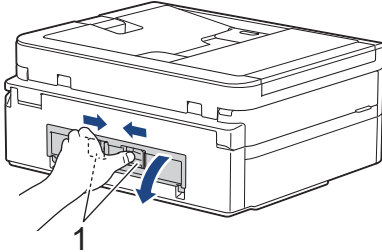

- c. Slowly pull the jammed paper out of the machine.

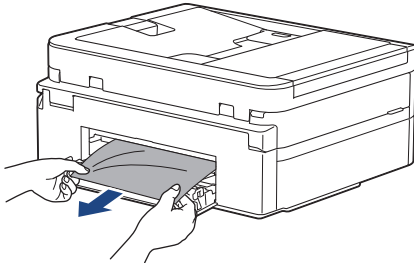

- d. Close the Jam Clear Cover. Make sure the cover is closed completely.

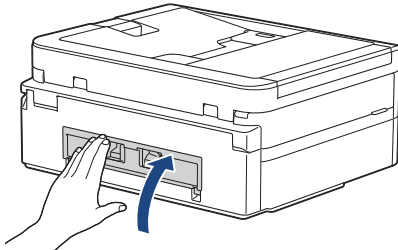

-
5. Slowly push the paper tray completely into the machine.

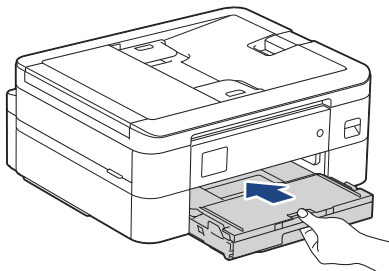

6. Pull out the paper support (1) until it locks into place, and then unfold the paper support flap (2).

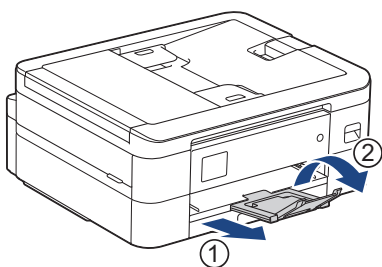

7. Reconnect the power cord.



Related Information

- [Printer Jam or Paper Jam](#)

Related Topics:

- [Error and Maintenance Messages](#)
-

Paper is Jammed in the Back of the Machine (Jam Rear)

If the LCD displays [Jam Rear], follow these steps:

1. Unplug the machine from the electrical socket.

IMPORTANT

(MFC-J1010DW)

Before you unplug the machine from the power source, you can transfer your faxes that are stored in the machine's memory to your computer or another fax machine so you will not lose any important messages.

2. Pull the paper tray (1) completely out of the machine as shown by the arrow.

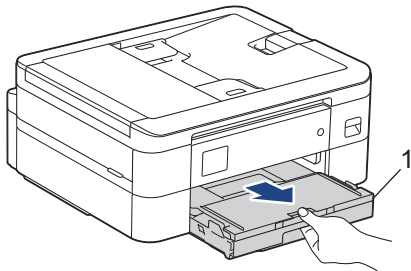

3. Pull the two green levers inside the machine to release the jammed paper.

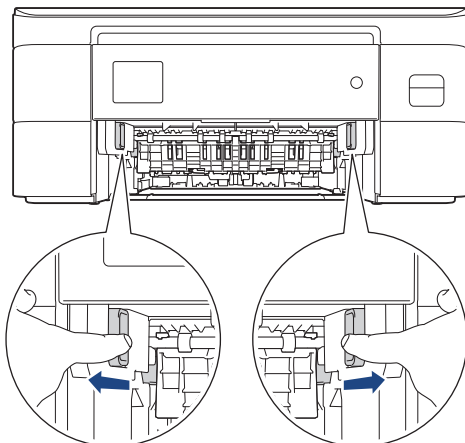

Depending on the paper size, it is easier to remove the jammed paper from the front of the machine rather than from the back of the machine.

4. Squeeze both levers (1), and then open the Jam Clear Cover at the back of the machine.

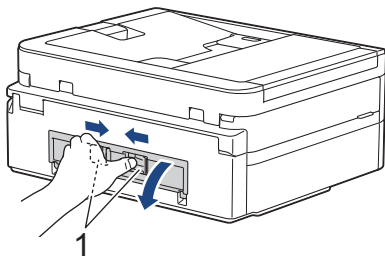

5. Slowly pull the jammed paper out of the machine.

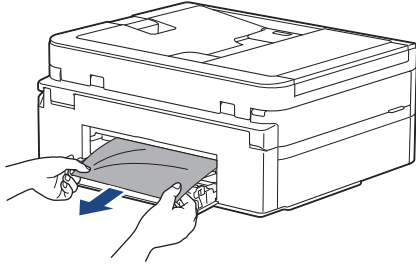

6. Close the Jam Clear Cover. Make sure the cover is closed completely.

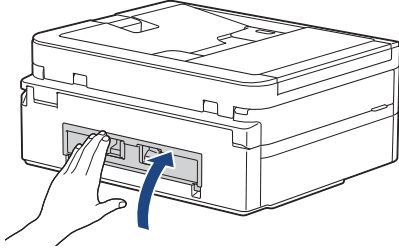

7. Slowly push the paper tray completely into the machine.

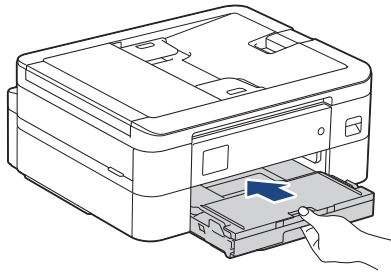

8. Pull out the paper support (1) until it locks into place, and then unfold the paper support flap (2).

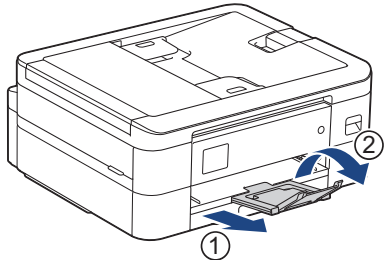

9. Reconnect the power cord.



Related Information

- [Printer Jam or Paper Jam](#)

Related Topics:

- [Error and Maintenance Messages](#)
-

If You Are Having Difficulty with Your Machine



For technical help, you must contact Brother customer support.

If you think there is a problem with your machine, check the following topics. You can correct most problems yourself.

If you need additional help, go to your model's **FAQs & Troubleshooting** page at support.brother.com.

Using non-Brother supplies may affect the print quality, hardware performance, and machine reliability.



- [Paper Handling and Printing Problems](#)
- [Telephone and Fax Problems](#)
- [Other Problems](#)
- [Network Problems](#)
- [AirPrint Problems](#)



Paper Handling and Printing Problems

If, after reading this table, you still need help, see the latest **FAQs & Troubleshooting** tips at support.brother.com.







- >> [Printing Difficulties](#)
- >> [Print Quality Difficulties](#)
- >> [Paper Handling Difficulties](#)
- >> [Printing Received Faxes \(For models with facsimile function\)](#)

Printing Difficulties

Difficulties	Suggestions
No printout	<p>(Windows)</p> <p>Check that the correct printer driver has been installed and selected.</p> <hr/> <p>Check to see if the machine's display is showing an error message. See <i>Related Information: Error and Maintenance Messages</i>.</p> <hr/> <p>Check that the machine is online:</p> <ul style="list-style-type: none"> • Windows 10, Windows Server 2016, and Windows Server 2019 Click  > Windows System > Control Panel. In the Hardware and Sound group, click View devices and printers. Right-click the Brother XXX-XXXX Printer (where XXX-XXXX is the name of your model). Click See what's printing. If printer driver options appear, select your printer driver. Click Printer in the menu bar and make sure Use Printer Offline is not selected. • Windows 8.1 Move your mouse to the lower right corner of your desktop. When the menu bar appears, click Settings > Control Panel. In the Hardware and Sound group, click View devices and printers. Right-click the Brother XXX-XXXX Printer (where XXX-XXXX is the name of your model). Click See what's printing. If printer driver options appear, select your printer driver. Click Printer in the menu bar and make sure Use Printer Offline is not selected. • Windows Server 2012 R2 Click Control Panel on the Start screen. In the Hardware group, click View devices and printers. Right-click the Brother XXX-XXXX Printer (where XXX-XXXX is the name of your model). Click See what's printing. If printer driver options appear, select your printer driver. Click Printer in the menu bar and make sure Use Printer Offline is not selected. • Windows Server 2012 Move your mouse to the lower right corner of your desktop. When the menu bar appears, click Settings > Control Panel. In the Hardware group, click View devices and printers. Right-click the Brother XXX-XXXX Printer (where XXX-XXXX is the name of your model). Click See what's printing. If printer driver options appear, select your printer driver. Click Printer in the menu bar and make sure Use Printer Offline is not selected. • Windows 7 and Windows Server 2008 R2 Click  (Start) > Devices and Printers. Right-click Brother XXX-XXXX Printer (where XXX-XXXX is the name of your model) and click See what's printing. If printer driver options appear, select your printer driver. Click Printer in the menu bar. Make sure Use Printer Offline is not selected. • Windows Server 2008 Click  (Start) > Control Panel > Hardware and Sound > Printers. Right-click Brother XXX-XXXX Printer (where XXX-XXXX is the name of your model). Make sure Use Printer Online is not listed. If it is listed, click this option to set the driver Online.

Difficulties	Suggestions
	<p>One or more ink cartridges have reached the end of their life. See <i>Related Information: Replace the Ink Cartridges.</i></p> <p>If old, unprinted data remains in the printer driver spooler, it will prevent new print jobs from printing. Open the printer icon and delete all data as follows:</p> <ul style="list-style-type: none"> • Windows 10, Windows Server 2016, and Windows Server 2019 Click  > Windows System > Control Panel. In the Hardware and Sound group, click View devices and printers > Printers. • Windows 8.1 Move your mouse to the lower right corner of your desktop. When the menu bar appears, click Settings > Control Panel. In the Hardware and Sound group, click View devices and printers > Printers. • Windows Server 2012 R2 Click Control Panel on the Start screen. In the Hardware group, click View devices and printers > Printers. • Windows Server 2012 Move your mouse to the lower right corner of your desktop. When the menu bar appears, click Settings > Control Panel. In the Hardware group, click View devices and printers > Printers. • Windows 7 and Windows Server 2008 R2 Click /Start > Devices and Printers > Printers and Faxes. • Windows Server 2008 Click  (Start) > Control Panel > Hardware and Sound > Printers. • Mac Click the System Preferences > Printers & Scanners.
The headers or footers appear when the document is displayed on the screen but do not appear when the document is printed.	There is an unprintable area on the top and bottom of the page. Adjust the top and bottom margins in your document to allow for this. See <i>Related Information: Unprintable Area.</i>
Cannot perform 'Page Layout' printing.	(Windows) Check that the paper size setting in the application and in the printer driver are the same. See <i>Related Information: Change the Paper Size and Paper Type .</i>
Print speed is too slow.	<p>(Windows)</p> <p>Try changing the printer driver setting. The highest resolution needs longer data processing, sending, and printing time. Try the other quality settings in the printer driver as follows:</p> <p>In the printer driver, clear the Colour Enhancement check box on the Advanced tab.</p> <p>Turn the Borderless feature off. Borderless printing is slower than normal printing. See <i>Related Information: Print Settings (Windows).</i></p> <p>Turn the Quiet Mode setting off. Print speed is slower in Quiet Mode. See <i>Related Information: Reduce Printing Noise.</i></p> <p>Make sure the Media Type setting in the printer drivers, your application, or the Paper Type setting on the machine matches the type of paper you are using. See <i>Related Information: Change the Paper Size and Paper Type.</i> See <i>Related Information: Print Settings (Windows).</i></p>

Print Quality Difficulties

Difficulties	Suggestions
Poor print quality	<p>Check the print quality. See <i>Related Information: Check the Print Quality.</i></p> <p>Make sure the Media Type setting in the printer drivers, your application, or the Paper Type setting on the machine matches the type of paper you are using. See <i>Related Information: Change the Paper Size and Paper Type.</i> See <i>Related Information: Print Settings (Windows).</i></p> <p>Make sure your ink cartridges are fresh. The following may cause ink to clog:</p> <ul style="list-style-type: none"> • The expiration date written on the cartridge package has passed. • The ink cartridge may not have been stored correctly before use. <p>Make sure you are using Brother Original ink. Brother does not recommend the use of cartridges other than Brother Original cartridges or the refilling of used cartridges with ink from other sources.</p> <p>Make sure you are using one of the recommended types of paper. See <i>Related Information: Acceptable Print Media.</i></p> <p>The recommended environment for your machine is between 20°C to 33°C.</p>
<p>White lines appear in text or graphics.</p> 	<p>Clean the print head. See <i>Related Information: Clean the Print Head from Your Brother Machine.</i> See <i>Related Information: Clean the Print Head Using Web Based Management.</i> See <i>Related Information: Clean the Print Head from Your Computer (Windows).</i></p> <p>Check and adjust the paper feed. See <i>Related Information: Correct the Paper Feed to Clear Vertical Lines.</i></p> <p>Make sure you are using Brother Original ink.</p> <p>Try using the recommended types of paper. See <i>Related Information: Acceptable Print Media.</i></p> <p>To prolong print head life, provide the best ink cartridge economy and maintain print quality, we do not recommend frequently unplugging the machine and/or leaving the machine unplugged for extended periods of time. We recommend using  to power down the machine. Using  allows minimal power to the machine, resulting in periodic, but less frequent, cleaning of the print head.</p>
<p>Dark lines appear at regular intervals.</p> 	<p>Check and adjust the paper feed. See <i>Related Information: Correct the Paper Feed to Clear Vertical Lines.</i></p>
The machine prints blank pages.	<p>Check the print quality. See <i>Related Information: Check the Print Quality.</i></p> <p>Make sure you are using Brother Original ink.</p> <p>To prolong print head life, provide the best ink cartridge economy and maintain print quality, we do not recommend frequently unplugging the machine and/or leaving the machine unplugged for extended periods of time. We recommend using  to power down the machine. Using  allows minimal power to the machine, resulting in periodic, but less frequent, cleaning of the print head.</p>
Characters and lines are blurred.	<p>Check the printing alignment. See <i>Related Information: Check the Print Alignment from Your Brother Machine.</i></p>

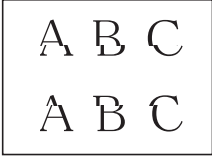
Difficulties	Suggestions
	<p>Change the print options. See <i>Related Information: Change the Print Options to Improve Your Print Results.</i></p>
Printed text or images are skewed.	<p>Make sure the paper is loaded correctly in the paper tray and the paper guides are adjusted correctly. See <i>Related Information: Load Paper.</i></p>
	Make sure the Jam Clear Cover is closed correctly.
There are smudges or stains at the top centre of the printed page.	<p>Make sure the paper is not too thick or curled. See <i>Related Information: Acceptable Print Media.</i></p>
Printing appears dirty or ink seems to run.	<p>Make sure you are using the recommended types of paper. Do not handle the paper until the ink is dry. See <i>Related Information: Acceptable Print Media.</i></p>
	Make sure the printing surface is face down in the paper tray.
	Make sure you are using Brother Original ink.
	If you are using photo paper, make sure the glossy side of the photo paper is face down in the tray and you have set the correct paper type. If you are printing a photo from your computer, set the Media Type in the printer driver or in the application you use to print.
Ink is smudged or wet when using glossy photo paper.	<p>Be sure to check the front and back of the paper. Place the glossy surface (printing surface) face down. See <i>Related Information: Change the Paper Size and Paper Type.</i></p>
	If you use glossy photo paper, make sure the paper type setting is correct.
Stains appear on the reverse side or at the bottom of the page.	<p>Make sure the printer platen is not dirty with ink. See <i>Related Information: Clean the Machine's Printer Platen.</i></p>
	Make sure you are using Brother Original ink.
	Make sure you are using the paper support flap. See <i>Related Information: Load Paper.</i>
	Make sure the paper feed rollers are not dirty with ink. See <i>Related Information: Clean the Paper Feed Rollers.</i>
The printouts are wrinkled.	<p>(Windows) In the printer driver, select the Advanced tab, click Other Print Options, and then click Advanced Colour Settings. Clear the Bi-Directional Printing check box.</p>
	Make sure you are using Brother Original ink.
Smudge or stain on the reverse side of the page when using the automatic 2-sided printing feature.	<p>(Windows) Change the Reduce Smudge option in your printer driver properties or preferences. See <i>Related Information: Prevent Smudged Printouts and Paper Jams (Windows).</i></p>

Paper Handling Difficulties

Difficulties	Suggestions
The machine does not feed paper.	<p>Make sure the paper tray is pushed in all the way until it locks into place.</p>
	Make sure the Jam Clear Cover at the back of the machine is closed.
	If the machine's LCD displays a Paper Jam message and you still have a problem, see <i>Related Information: Error and Maintenance Messages.</i>

Difficulties	Suggestions
	<p>If the paper tray is empty, load a new stack of paper into the paper tray.</p> <p>If there is paper in the paper tray, make sure it is straight. If the paper is curled, straighten it. Sometimes it is helpful to remove the paper, turn the stack over and put it back in the paper tray.</p> <p>Reduce the amount of paper in the paper tray, and then try again.</p> <p>Clean the paper pick-up rollers. See <i>Related Information: Clean the Paper Pick-up Rollers.</i></p> <p>Make sure that the paper is within specifications for the machine. See <i>Related Information: Paper Capacity of the Paper Tray.</i></p>
Photo paper does not feed correctly.	When you print on photo paper, load one extra sheet of the same photo paper in the paper tray.
Machine feeds multiple pages.	<ul style="list-style-type: none"> • Make sure the paper is loaded correctly in the paper tray. • Remove all the paper from the tray and fan the stack of paper well, then put it back in the tray. • Make sure you do not push the paper in too far. <p>See <i>Related Information: Load Paper.</i></p> <p>Make sure the Jam Clear Cover is closed correctly. See <i>Related Information: Printer Jam or Paper Jam.</i></p> <p>Make sure the Base Pad in the paper tray is not dirty. See <i>Related Information: Clean the Base Pad.</i></p>
There is a paper jam.	<p>See <i>Related Information: Printer Jam or Paper Jam.</i></p> <p>Make sure the paper guides are set to the correct paper size.</p> <p>Use the jam prevention settings.</p> <p>For copying: See <i>Related Information: Change the Print Options to Improve Your Print Results.</i></p> <p>For printing: See <i>Related Information: Change the Print Options to Improve Your Print Results.</i></p> <p>See <i>Related Information: Prevent Smudged Printouts and Paper Jams (Windows).</i></p>
The paper jams when you use 2-sided print.	<p>If paper jams occur frequently during 2-sided printing, the paper feed rollers may be stained with ink. Clean the paper feed rollers.</p> <p>See <i>Related Information: Clean the Paper Feed Rollers.</i></p>

Printing Received Faxes (For models with facsimile function)

Difficulties	Suggestions
<ul style="list-style-type: none"> • Condensed print • Horizontal streaks • Top and bottom sentences are cut off • Missing lines 	This is usually caused by a poor telephone connection. Make a copy; if your copy looks good, you probably had a bad connection, with static or interference on the telephone line. Ask the other party to send the fax again.
Black lines when receiving.	The sender's scanner may be dirty. Ask the sender to make a copy to see if the problem is with the sending machine. Try receiving from another fax machine.
Left and right margins are cut off or a single page is printed on two pages.	<p>If the received faxes are divided and printed on two pages or if you get an extra blank page, your paper size setting may not be correct for the paper you are using. See <i>Related Information: Change the Paper Size and Paper Type.</i></p> <p>Turn on Auto Reduction.</p>

Difficulties	Suggestions
	See <i>Related Information: Shrink Page Size of an Oversized Incoming Fax.</i>
Received colour fax prints only in monochrome.	Replace the colour ink cartridges that have reached the end of their life, and then ask the other person to send the colour fax again. See <i>Related Information: Replace the Ink Cartridges.</i>



Related Information

- [If You Are Having Difficulty with Your Machine](#)

Related Topics:

- [Troubleshooting](#)
- [Error and Maintenance Messages](#)
- [Replace the Ink Cartridges](#)
- [Unprintable Area](#)
- [Check the Print Quality](#)
- [Change the Paper Size and Paper Type](#)
- [Acceptable Print Media](#)
- [Clean the Print Head from Your Brother Machine](#)
- [Clean the Print Head from Your Computer \(Windows\)](#)
- [Check the Print Alignment from Your Brother Machine](#)
- [Load Paper](#)
- [Clean the Machine's Printer Platen](#)
- [Clean the Paper Feed Rollers](#)
- [Clean the Paper Pick-up Rollers](#)
- [Printer Jam or Paper Jam](#)
- [Shrink Page Size of an Oversized Incoming Fax](#)
- [Print Settings \(Windows\)](#)
- [Prevent Smudged Printouts and Paper Jams \(Windows\)](#)
- [Clean the Base Pad](#)
- [Change the Print Options to Improve Your Print Results](#)
- [Reduce Printing Noise](#)
- [Correct the Paper Feed to Clear Vertical Lines](#)
- [Clean the Print Head Using Web Based Management](#)
- [Paper Capacity of the Paper Tray](#)

Telephone and Fax Problems

Related Models: MFC-J1010DW

- >> [Telephone Line or Connections](#)
- >> [Handling Incoming Calls](#)
- >> [Receiving Faxes](#)
- >> [Sending Faxes](#)

Telephone Line or Connections

Difficulties	Suggestions
Dialling does not work. (No dial tone)	<p>Check all line cord connections. Make sure the telephone line cord is plugged into the telephone wall socket and the LINE socket of the machine. If you subscribe to DSL or VoIP services, contact your service provider for connection instructions.</p> <p>If you are using a VoIP system, try changing the VoIP setting to <i>Basic (for VoIP)</i>. This will lower modem speed and turn off Error Correction Mode (ECM). See <i>Related Information: Telephone Line Interference/VoIP</i>.</p>
	<p>(Available only for some countries.)</p> <p>Change the Tone/Pulse setting. See <i>Related Information: Set Tone or Pulse Dialling Mode</i>.</p>
	<p>If there is no dial tone, connect a known working telephone and telephone line cord to the socket. Then lift the external telephone's handset and listen for a dial tone. If there is still no dial tone, ask your telephone company to check the line and/or wall socket.</p>
The machine does not answer when called.	<p>Make sure the machine is in the correct receive mode for your setup. See <i>Related Information: Choose the Correct Receive Mode</i>.</p> <p>Check for a dial tone. If possible, call your machine to hear it answer. If there is still no answer, check that the telephone line cord is plugged into the telephone wall socket and the LINE socket of the machine. If there is no ringing when you call your machine, ask your telephone company to check the line.</p>

Handling Incoming Calls

Difficulties	Suggestions
The machine 'Hears' a voice as a CNG Tone.	<p>If Fax Detect is set to On, your machine is more sensitive to sounds. It may mistakenly interpret certain voices or music on the line as a fax machine calling and respond with fax receiving tones. Deactivate the machine by pressing Stop/Exit or . Try avoiding this problem by turning Fax Detect Off. See <i>Related Information: Set Fax Detect</i>.</p>
Sending a Fax Call to the machine.	<p>If you answered on an extension or external telephone, press your Remote Activation Code (the factory setting is *51). If you answered on the external telephone, press the Start button to receive the fax.</p> <p>When your machine answers, hang up.</p>
Custom features on a single line.	<p>If you have Call Waiting, Call Waiting/Caller ID, Caller ID, Voice Mail, an answering machine, an alarm system or other custom feature on a single telephone line with your machine, it may create a problem sending or receiving faxes.</p> <p>For Example: If you subscribe to Call Waiting or some other custom service and its signal comes through the line while your machine is sending or receiving a fax, the signal can temporarily interrupt or disrupt the faxes. Brother's ECM (Error Correction Mode) feature should help overcome this problem. This condition is</p>

Difficulties	Suggestions
	related to the telephone system industry and is common to all devices that send and receive information on a single, shared line with custom features. If avoiding a slight interruption is crucial to your business, we recommend using a separate telephone line with no custom features.

Receiving Faxes

Difficulties	Suggestions
Cannot receive a fax.	<p>Check all line cord connections. Make sure the telephone line cord is plugged into the telephone wall socket and the LINE socket of the machine. If you subscribe to DSL or VoIP services, contact your service provider for connection instructions. If you are using a VoIP system, try changing the VoIP setting to <i>Basic (for VoIP)</i>. This will lower modem speed and turn off Error Correction Mode (ECM).</p> <p>See <i>Related Information: Telephone Line Interference/VoIP</i>.</p> <p>Make sure the machine is in the correct Receive Mode. This is determined by the external devices and telephone subscriber services you have on the same line as the Brother machine.</p> <p>See <i>Related Information: Choose the Correct Receive Mode</i>.</p> <ul style="list-style-type: none"> • If you have a dedicated fax line and want your Brother machine to automatically answer all incoming faxes, you should select Fax only mode. • If your Brother machine shares a line with an external answering machine, you should select the External TAD mode. In External TAD mode, your Brother machine will receive incoming faxes automatically and voice callers will be able to leave a message on your answering machine. • If your Brother machine shares a line with other telephones and you want it to automatically answer all incoming faxes, you should select the Fax/Tel mode. In Fax/Tel mode, your Brother machine will receive faxes automatically and produce a pseudo/double-ring to alert you to answer voice calls. • If you do not want your Brother machine to answer any incoming faxes automatically, you should select the Manual mode. In Manual mode, you must answer every incoming call and activate the machine to receive faxes. <p>Another device or service at your location may be answering the call before your Brother machine answers. To test this, lower the Ring Delay setting:</p> <ul style="list-style-type: none"> • If the Receive Mode is set to Fax Only or Fax/Tel, reduce the Ring Delay to the lowest ring greater than 0. <p>See <i>Related Information: Set the Number of Rings Before the Machine Answers (Ring Delay)</i>.</p> <ul style="list-style-type: none"> • If the Receive Mode is set to External TAD, reduce the number of rings programmed on your answering machine to two. • If the Receive Mode is set to Manual, DO NOT adjust the Ring Delay setting. <p>Have someone send you a test fax:</p> <ul style="list-style-type: none"> • If you received the test fax successfully, your machine is operating correctly. Remember to reset your Ring Delay or answering machine setting back to your original setting. If receiving problems recur after resetting the Ring Delay, then a person, device, or subscriber service is answering the fax call before the machine has a chance to answer. • If you were not able to receive the fax, then another device or subscriber service may be interfering with your fax reception or there may be a problem with your fax line. <p>If you are using a telephone answering machine (External TAD mode) on the same line as the Brother machine, make sure your answering machine is set up correctly.</p> <p>See <i>Related Information: Connect an External TAD</i>.</p> <ol style="list-style-type: none"> 1. Connect the external TAD as shown in the following topic: <p>See <i>Related Information: External TAD (Telephone Answering Device)</i>.</p>

Difficulties	Suggestions
	<p>2. Set your answering machine to answer in one or two rings.</p> <p>3. Record the outgoing message on your answering machine.</p> <ul style="list-style-type: none"> • Record five seconds of silence at the beginning of your outgoing message. • Limit your speaking to 20 seconds. • End your outgoing message with your Remote Activation Code for people sending manual faxes. For example: "After the beep, leave a message or press *51 and Start to send a fax." <p>4. Set your answering machine to answer calls.</p> <p>5. Set your Brother machine's Receive Mode to External TAD. See <i>Related Information: Choose the Correct Receive Mode.</i></p>
	<p>Make sure your Brother machine's Fax Detect feature is turned On. Fax Detect is a feature that allows you to receive a fax even if you answered the call on an external or extension telephone. See <i>Related Information: Set Fax Detect.</i></p>
	<p>If you often get transmission errors due to possible interference on the telephone line or if you are using a VoIP system, try changing the Compatibility setting to <i>Basic (for VoIP)</i>. See <i>Related Information: Telephone Line Interference/VoIP.</i></p>
	<p>If you connect your machine to a PBX or ISDN line, set the menu setting of Telephone Line Type to your telephone line type. See <i>Related Information: Set the Telephone Line Type.</i></p>

Sending Faxes

Difficulties	Suggestions
Cannot send a fax.	<p>Check all line cord connections. Make sure the telephone line cord is plugged into the telephone wall socket and the LINE socket of the machine. If you subscribe to DSL or VoIP services, contact your service provider for connection instructions.</p> <p>If you are using a VoIP system, try changing the VoIP setting to <i>Basic (for VoIP)</i>. This will lower modem speed and turn off Error Correction Mode (ECM). See <i>Related Information: Telephone Line Interference/VoIP.</i></p>
	<p>Print the Transmission Verification Report and check for an error. See <i>Related Information: Print Reports.</i></p>
	<p>Ask the other party to check that the receiving machine has paper.</p>
Poor sending quality.	<p>Try changing your resolution to Fine or S.Fine. Make a copy to check your machine's scanner operation. If the copy quality is poor, clean the scanner. See <i>Related Information: Clean the Scanner.</i></p>
Transmission Verification Report says RESULT:NG.	<p>There is probably temporary noise or static on the line. Try sending the fax again. If you are sending a PC-Fax message and get RESULT:NG on the Transmission Verification Report, your machine may be out of memory.</p> <p>If the problem continues, ask the telephone company to check your telephone line. See <i>Related Information: Print a Fax Stored in the Machine's Memory.</i> See <i>Related Information: Cancel a Fax in Progress.</i> See <i>Related Information: Check and Cancel a Pending Fax.</i></p>
	<p>If you connect your machine to a PBX or ISDN line, set the menu setting of Telephone Line Type to your telephone line type. See <i>Related Information: Set the Telephone Line Type.</i></p>
	<p>If you often get transmission errors due to possible interference on the telephone line or if you are using a VoIP system, try changing the Compatibility setting to <i>Basic (for VoIP)</i>.</p>

Difficulties	Suggestions
	See <i>Related Information: Telephone Line Interference/VoIP</i> .
Sent faxes are blank.	Make sure you are loading the document correctly. See <i>Related Information: Load Documents in the Automatic Document Feeder (ADF)</i> . See <i>Related Information: Load Documents on the Scanner Glass</i> .
Vertical black lines when sending.	Black vertical lines on faxes you send are typically caused by dirt or correction fluid on the glass strip. Clean the glass strip. See <i>Related Information: Clean the Scanner</i> .



Related Information

- [If You Are Having Difficulty with Your Machine](#)
 - [Set Dial Tone Detection](#)
 - [Telephone Line Interference/VoIP](#)

Related Topics:

- [Troubleshooting](#)
- [Set Tone or Pulse Dialling Mode](#)
- [Choose the Correct Receive Mode](#)
- [Set Fax Detect](#)
- [Set the Number of Rings Before the Machine Answers \(Ring Delay\)](#)
- [Connect an External TAD](#)
- [External TAD \(Telephone Answering Device\)](#)
- [Set the Telephone Line Type](#)
- [Print Reports](#)
- [Clean the Scanner](#)
- [Print a Fax Stored in the Machine's Memory](#)
- [Cancel a Fax in Progress](#)
- [Check and Cancel a Pending Fax](#)
- [Load Documents in the Automatic Document Feeder \(ADF\)](#)
- [Load Documents on the Scanner Glass](#)

Set Dial Tone Detection

Related Models: MFC-J1010DW

Setting the Dial Tone to [Detection] will shorten the Dial Tone detect pause.

1. Press **Settings**.
2. Press **▲** or **▼** to make your selections:
 - a. Select [Initial Setup]. Press **OK**.
 - b. Select [Dial Tone]. Press **OK**.
 - c. Select [Detection] or [No Detection]. Press **OK**.
3. Press **Stop/Exit**.



Related Information

- [Telephone and Fax Problems](#)

Telephone Line Interference/VoIP

Related Models: MFC-J1010DW

If you are having problems sending or receiving a fax due to possible interference on the telephone line or if you are using a VoIP system, we recommend changing the modem speed to minimise errors in fax operations.

1. Press **Settings**.
2. Press **▲** or **▼** to make your selections:
 - a. Select [Initial Setup]. Press **OK**.
 - b. Select [Compatibility]. Press **OK**.
 - c. Select [Normal] or [Basic (for VoIP)]. Press **OK**.
 - [Basic (for VoIP)] reduces the modem speed to 9,600 bps and turns off colour fax receiving and Error Correction Mode (ECM), except for colour fax-sending. Unless interference is a recurring problem on your telephone line, you may prefer to use it only when needed.
To improve compatibility with most VoIP services, Brother recommends changing the compatibility setting to [Basic (for VoIP)].
 - [Normal] sets the modem speed at 14,400 bps.
3. Press **Stop/Exit**.



-
- VoIP (Voice over IP) is a type of phone system that uses an Internet connection, rather than a traditional phone line.
-



Related Information

- [Telephone and Fax Problems](#)

Related Topics:

- [Voice Over Internet Protocol \(VoIP/Telephone Line Interference\)](#)
 - [Error and Maintenance Messages](#)
-

Other Problems

- >> Copying Difficulties
- >> Scanning Difficulties
- >> Software Difficulties

Copying Difficulties

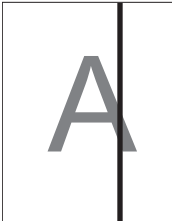
Difficulties	Suggestions
Black lines or streaks appear in copies. 	Black lines on copies are typically caused by dirt or correction fluid on the glass strip. Clean the glass strip, scanner glass, and the white bar and white plastic above them. See <i>Related Information: Clean the Scanner.</i>
Black marks or spots appear in copies.	Black marks or spots on copies are typically caused by dirt or correction fluid on the scanner glass. Clean the scanner glass and white plastic above it. See <i>Related Information: Clean the Scanner.</i>
Copies are blank.	Make sure you are loading the document correctly. See <i>Related Information: Load Documents in the Automatic Document Feeder (ADF).</i> See <i>Related Information: Load Documents on the Scanner Glass.</i>
Poor copy results when using the ADF. (ADF models)	Try using the scanner glass. See <i>Related Information: Load Documents on the Scanner Glass.</i>
Fit to Page does not work correctly.	Make sure the document is not skewed on the scanner glass. Reposition the document and try again.
Smudge or stain on the reverse side of the page when using the 2-sided copy feature.	Change the print options. See <i>Related Information: Change the Print Options to Improve Your Print Results.</i>

Scanning Difficulties

Difficulties	Suggestions
TWAIN or WIA errors appear when starting to scan. (Windows)	Make sure the Brother TWAIN or WIA driver is selected as the primary source in your scanning application. For example, in Nuance™ PaperPort™ 14SE, click Desktop > Scan Settings > Select to choose the Brother TWAIN/WIA driver.
OCR does not work.	Try increasing the scanning resolution.
Poor scanning results when using the ADF. (Black lines appear in the scanned data.) (ADF models)	Clean the white bar and the glass strip underneath it. See <i>Related Information: Clean the Scanner.</i>
	Try using the scanner glass. See <i>Related Information: Load Documents on the Scanner Glass.</i>

Software Difficulties

Difficulties	Suggestions
Cannot print.	Uninstall the drivers (Windows) and the Brother software and reinstall the latest version of both.

Difficulties	Suggestions
"The device is busy." appears on the computer screen.	Make sure there is no error message on the machine's display.



Related Information

- [If You Are Having Difficulty with Your Machine](#)

Related Topics:

- [Troubleshooting](#)
 - [Clean the Scanner](#)
 - [Correct the Paper Feed to Clear Vertical Lines](#)
 - [Load Documents in the Automatic Document Feeder \(ADF\)](#)
 - [Load Documents on the Scanner Glass](#)
 - [Change the Print Options to Improve Your Print Results](#)
-

Network Problems

- [Use the Network Connection Repair Tool \(Windows\)](#)
- [Check Your Machine's Network Settings](#)
- [If You Are Having Difficulty with Your Machine's Network](#)
- [Troubleshooting](#)

Use the Network Connection Repair Tool (Windows)

Use the Network Connection Repair Tool to fix the Brother machine's network settings. It will assign the correct IP address and Subnet Mask.

Make sure your machine is turned on and is connected to the same network as your computer.

1. Launch  (**Brother Utilities**), and then click the drop-down list and select your model name (if not already selected).
2. Click **Tools** in the left navigation bar, and then click **Network Connection Repair Tool**.
3. Follow the on-screen instructions.
4. Check the diagnosis by printing the Network Configuration Report.



The Network Connection Repair Tool will start automatically if you select the **Enable Connection Repair Tool** option in the Status Monitor. Right-click the Status Monitor screen, and then click **Other Settings > Enable Connection Repair Tool**. This is not recommended when your network administrator has set the IP address to Static, since it will automatically change the IP address.

If the correct IP address and the Subnet Mask are still not assigned even after using the Network Connection Repair Tool, ask your network administrator for this information.



Related Information

- [Network Problems](#)

Related Topics:

- [If You Are Having Difficulty with Your Machine's Network](#)
- [Print the Network Configuration Report](#)

Check Your Machine's Network Settings

- [Print the Network Configuration Report](#)
- [Change Machine Settings Using Web Based Management](#)

If You Are Having Difficulty with Your Machine's Network



For technical help, you must contact Brother customer support.

If you think there is a problem with your machine, check the following topics. You can correct most problems yourself.

If you need additional help, go to your model's **FAQs & Troubleshooting** page at support.brother.com.

>> [I Cannot Complete the Wireless Network Setup Configuration](#)

>> [My Brother Machine Cannot Print, Scan, or PC-FAX Receive over the Network](#)

>> [I Want to Check that My Network Devices are Working Correctly](#)

I Cannot Complete the Wireless Network Setup Configuration

Turn your wireless router off and back on. Then, try to configure the wireless settings again. If you are unable to resolve the problem, follow the instructions below:

Investigate the problem using the WLAN Report.



Cause	Action	Interface
Your security settings (SSID/ Network Key) are not correct.	<ul style="list-style-type: none"> • Confirm the security settings using Wireless Setup Helper. For more information and to download the utility, go to your model's Downloads page at support.brother.com. • Select and confirm that you are using the correct security settings. <ul style="list-style-type: none"> - See the instructions supplied with your wireless LAN access point/router for information on how to find the security settings. - The manufacturer's name or model number of the wireless LAN access point/router may be used as the default security settings. - Consult with the access point/router manufacturer, your Internet provider, or network administrator. 	Wireless
Your Brother machine's MAC address is not allowed.	Confirm that the Brother machine's MAC Address is allowed in the filter. You can find the MAC Address on your Brother machine's control panel.	Wireless
Your wireless LAN access point/router is in stealth mode (not broadcasting the SSID).	<ul style="list-style-type: none"> • Enter the correct SSID name or Network Key manually. • Check the SSID name or the Network Key in the instructions supplied with your wireless LAN access point/router and reconfigure the wireless network setup. 	Wireless
Your security settings (SSID/ password) are not correct.	<ul style="list-style-type: none"> • Confirm the SSID and password. <ul style="list-style-type: none"> - When you are configuring the network manually, the SSID and password are displayed on your Brother machine. If your mobile device supports the manual configuration, the SSID and password will be displayed on your mobile device's screen. 	Wi-Fi Direct
You are using Android™ 4.0.	If your mobile device disconnects (approximately six minutes after using Wi-Fi Direct), try the one-push configuration using WPS (recommended) and set the Brother machine as a Group Owner.	Wi-Fi Direct
Your Brother machine is placed too far from your mobile device.	Move your Brother machine within about 3.3 feet (1 metre) of the mobile device when you configure the Wi-Fi Direct network settings.	Wi-Fi Direct
There are some obstructions (walls or furniture, for example) between your	Move your Brother machine to an obstruction-free area.	Wi-Fi Direct



Cause	Action	Interface
machine and the mobile device.		
There is a wireless computer, Bluetooth®-supported device, microwave oven, or digital cordless phone near the Brother machine or the mobile device.	Move other devices away from the Brother machine or the mobile device.	Wi-Fi Direct
You have checked and tried all of the above, but your Brother machine still cannot complete the Wi-Fi Direct configuration.	<ul style="list-style-type: none"> • Turn your Brother machine off and back on. Then, try to configure the Wi-Fi Direct settings again. • If you are using your Brother machine as a client, confirm how many devices are allowed in the current Wi-Fi Direct network, and then check how many devices are connected. 	Wi-Fi Direct

For Windows

If your wireless connection has been interrupted, and you have checked and tried all of the above, we recommend using the Network Connection Repair Tool.

My Brother Machine Cannot Print, Scan, or PC-FAX Receive over the Network

Cause	Action	Interface
(Your Brother machine suddenly stopped printing or scanning.)	<ul style="list-style-type: none"> • DCP-J1050DW/MFC-J1010DW <ol style="list-style-type: none"> 1. Press  or WiFi on the control panel. 2. Press ▶. 3. Press ▲ or ▼ to select the Recover WLAN option, and then press OK. 4. When your wireless device connects successfully, the machine displays Connected. Press ▶. • DCP-J1140DW <p>Press  > Recover WLAN.</p> <p>When your wireless device connects successfully, the machine displays Connected. Press OK.</p> 	Wireless
Your security software blocks your machine's access to the network. (The Network scanning feature does not work.)	<ul style="list-style-type: none"> • Windows <p>Configure the third-party Security/Firewall Software to allow Network scanning. To add port 54925 for Network scanning, type the information below:</p> <ul style="list-style-type: none"> - In Name: Type any description, for example Brother NetScan. - In Port number: Type 54925. Type 137. Type 161. - In Protocol: UDP is selected. <p>See the instruction manual that came with your third-party Security/Firewall Software or contact the software manufacturer.</p> • Mac (Brother iPrint&Scan) <p>In the Finder menu bar, click Go > Applications, and then double-click the Brother iPrint&Scan icon. The Brother iPrint&Scan window appears. Click the Select your Machine button, and then follow the on-screen instructions to reselect your network machine.</p> 	Wireless

Cause	Action	Interface
<p>Your security software blocks your machine's access to the network. (The network PC-Fax Receive feature does not work.) (Windows)</p>	<p>Set the third-party Security/Firewall Software to allow PC-FAX Rx. To add port 54926 for Network PC-FAX Rx, type the information below:</p> <ul style="list-style-type: none"> • In Name: Type any description, for example Brother PC-FAX Rx. • In Port number: Type 54926. • In Protocol: UDP is selected. <p>See the instruction manual that came with your third-party Security/Firewall Software or contact the software manufacturer.</p>	Wireless
<p>Your security software blocks your machine's access to the network.</p>	<p>Some security software might block access without showing a security alert dialog box even after successful installation. To allow access, see the instructions for your security software or ask the software manufacturer.</p>	Wireless
<p>Your Brother machine was not assigned an available IP address.</p>	<ul style="list-style-type: none"> • Confirm the IP address and the Subnet Mask. Verify that both the IP addresses and Subnet Masks of your computer and the Brother machine are correct and located on the same network. For more information about how to verify the IP address and the Subnet Mask, ask your network administrator. • Windows Confirm the IP address and the Subnet Mask using the Network Connection Repair Tool. • Mac Check your network devices using the ping command. For more information on how to confirm your network settings, see <i>Related Information: Check Network Devices Using the Ping Command</i>. 	Wireless
<p>The failed print job is still in your computer's print queue.</p>	<ul style="list-style-type: none"> • If the failed print job is still in your computer's print queue, delete it. • Otherwise, double-click the printer icon in the following folder and cancel all documents: <ul style="list-style-type: none"> - Windows 10, Windows Server 2016, and Windows Server 2019 Click  > Windows System > Control Panel. In the Hardware and Sound group, click View devices and printers. - Windows 8.1 Move your mouse to the lower right corner of your desktop. When the menu bar appears, click Settings > Control Panel. In the Hardware and Sound group, click View devices and printers. - Windows Server 2012 R2 Click Control Panel on the Start screen. In the Hardware group, click View devices and printers. - Windows Server 2012 Move your mouse to the lower right corner of your desktop. When the menu bar appears, click Settings > Control Panel. In the Hardware group, click View devices and printers > Printers. - Windows 7 Click  (Start) > Devices and Printers. - Windows Server 2008 Click Start > Control Panel > Printers. - Mac Click System Preferences > Printers & Scanners. 	Wireless

Cause	Action	Interface
Your Brother machine is not connected to the wireless network.	Print the WLAN Report to check the error code on the printed report.	Wireless

If you have checked and tried all of the above, but your Brother machine still cannot print and scan, uninstall the drivers (Windows) and the Brother software and reinstall the latest version of both.

I Want to Check that My Network Devices are Working Correctly

Check	Action	Interface
Check that your Brother machine, access point/router, or network hub is turned on.	<p>Check the following:</p> <ul style="list-style-type: none"> The power cord is connected correctly and the Brother machine is turned on. The access point/router or hub is turned on and its link indicator is blinking. All protective packaging has been removed from the machine. The ink cartridges are installed correctly. The Scanner Cover and the Jam Clear Cover are fully closed. Paper is inserted correctly in the paper tray. 	Wireless
Check that you can "ping" the Brother machine from your computer.	<p>Ping the Brother machine from your computer using the IP address or the node name in the Windows command prompt or Mac Terminal application:</p> <p>ping <ipaddress> or <nodename>.</p> <ul style="list-style-type: none"> Successful: Your Brother machine is working correctly and connected to the same network as your computer. Unsuccessful: Your Brother machine is not connected to the same network as your computer. <p>Windows: Ask your administrator about the IP address and the subnet mask, and then use the Network Connection Repair Tool.</p> <p>Mac: Confirm that the IP address and the Subnet Mask are set correctly.</p>	Wireless
Check that your Brother machine is connected to the wireless network.	Print the WLAN Report to check the error code on the printed report.	Wireless

If you have checked and tried all of the above but you are still having problems, see the instructions supplied with your wireless LAN access point/router to find the SSID (Network Name) and the Network Key (Password) information and set them correctly.

Related Information

- [Network Problems](#)
 - [Check Network Devices Using the Ping Command](#)

Related Topics:



- [Print the WLAN Report](#)
- [Use the Network Connection Repair Tool \(Windows\)](#)
- [Wireless LAN Report Error Codes](#)
- [Configure Your Machine for a Wireless Network When the SSID is Not Broadcast](#)
- [Use Wi-Fi Direct®](#)
- [Print the Network Configuration Report](#)

Check Network Devices Using the Ping Command

Check the IP addresses of both your computer and your Brother machine, and then confirm whether the network is operating correctly.

- >> [Configure the IP Address on your computer \(Windows\)](#)
- >> [Configure the IP Address on your computer \(Mac\)](#)
- >> [Configure the IP Address on your Brother machine](#)

Configure the IP Address on your computer (Windows)

- Do one of the following:
 - Windows 10
Click  > **Windows System** > **Command Prompt**.
 - Windows 8.1
Move your mouse to the lower right corner of your desktop. When the menu bar appears, click **Search** > **Command Prompt**.
 - Windows7
Click  (**Start**) > **All Programs** > **Accessories** > **Command Prompt**.
- Type "ipconfig" and then press the Enter key on your keyboard.
- Confirm the values for the IPv4 address and subnet mask.
- Type "exit" and then press the Enter key on your keyboard.

Configure the IP Address on your computer (Mac)

- Select **System Preferences** from the Apple menu.
- Click **Network** > **Advanced** > **TCP/IP**.
- Confirm the values for the IPv4 address and subnet mask.

Configure the IP Address on your Brother machine

Print the Network Configuration Report, and confirm the values for the IP address and subnet mask.

Check the IP addresses for both your computer and your Brother machine. Confirm that the network address portions are the same. For example, if the subnet mask is "255.255.255.0", it is normal for only the host address portions to be different.

	Network Address	Host Address	
IP Address	192.168.100.	250	Set the final number, which corresponds to "0" in the subnet mask, to 1–254.
Subnet Mask	255.255.255.	0	Usually, there are no problems when the subnet mask is "255.255.255.0". Use the same value for all of your computers.

Related Information

- [If You Are Having Difficulty with Your Machine's Network](#)

AirPrint Problems

Difficulty	Suggestions
My machine is not displayed in the printer list.	Make sure your machine is turned on.
	Confirm the network settings.
	Move the mobile device closer to the wireless access point/router, or to your machine.
I cannot print.	Make sure your machine is turned on.
	Confirm the network settings.
I am trying to print a multiple-page document from an iOS device, but ONLY the first page is printing.	Make sure you are running the latest OS version.



Related Information

- [If You Are Having Difficulty with Your Machine](#)

Related Topics:

- [Troubleshooting](#)

Check the Machine Information

Follow these instructions to check your machine's serial number, firmware version, and firmware update.

>> [DCP-J1050DW/MFC-J1010DW](#)

>> [DCP-J1140DW](#)

DCP-J1050DW/MFC-J1010DW

1. Press **Settings**.
2. Press **▲** or **▼** to select [Machine Info.]. Press **OK**.
3. Press **▲** or **▼** to select one of the following options:

Option	Description
Serial No.	Check your machine's serial number.
Firmware Version	Check your machine's firmware version.
Firmware Update	Update your machine to the latest firmware.
Firmware Auto Check	View firmware information on the Home screen.
Page Counter	Check the number of total pages the machine has printed.

4. Press **OK**.
5. Press **Stop/Exit**.

DCP-J1140DW

1. Press  [Settings] > [All Settings] > [Machine Info.].
2. Press one of the following options:

Option	Description
Serial No.	Check your machine's serial number.
Firmware Version	Check your machine's firmware version.
Firmware Update	Update your machine to the latest firmware.
Firmware Auto Check	View firmware information on the Home screen.
Page Counter	Check the number of total pages the machine has printed.

3. Press .

✓ Related Information

- [Troubleshooting](#)

Reset Your Machine

IMPORTANT

(MFC-J1010DW)

When you reset the machine, your faxes that are stored in the machine's memory may be deleted. Before you reset the machine, you can transfer your faxes to your computer or another fax machine so you will not lose any important messages.

>> [DCP-J1050DW/MFC-J1010DW](#)

>> [DCP-J1140DW](#)

DCP-J1050DW/MFC-J1010DW

1. Press **Settings**.
2. Press **▲** or **▼** to make your selections:
 - a. Select [Initial Setup]. Press **OK**.
 - b. Select [Reset]. Press **OK**.
 - c. Select the reset option you want to use. Press **OK**.
3. Press **▶** for two seconds to confirm.
The machine restarts.

DCP-J1140DW

1. Press  [Settings] > [All Settings] > [Initial Setup] > [Reset].
2. Press the reset option you want to use.
3. Press [OK] for two seconds to reboot the machine.



Related Information

- [Troubleshooting](#)
 - [Reset Functions Overview](#)

Related Topics:

- [Transfer Your Faxes or Fax Journal Report](#)

Reset Functions Overview

IMPORTANT

(MFC-J1010DW)

When you reset the machine, your faxes that are stored in the machine's memory may be deleted. Before you reset the machine, you can transfer your faxes to your computer or another fax machine so you will not lose any important messages.

The following reset functions are available:

1. [Machine Reset]

You can reset all the machine's settings that you have changed.

The Address Book, Fax Reports, and Call History will remain. (For models with facsimile function)

2. [Network]

Reset the print server back to its default factory settings (includes Password and IP Address information).

3. [Address Book & Fax] (For models with facsimile function)

Address Book & Fax resets the following settings:

- Address Book and Setup Groups
- Station ID
Name and Number
- Report
Transmission Verification Report, Address Book and Fax Journal
- History
Caller ID History and Outgoing Call
- Faxes in memory

4. [All Settings]

Use this reset function to reset all of the machine's settings to the settings originally set at the factory.

We strongly recommend you perform this operation when you dispose of the machine.

Related Information

- [Reset Your Machine](#)

Related Topics:

- [Transfer Your Faxes or Fax Journal Report](#)

Routine Maintenance

- [Replace the Ink Cartridges](#)
- [Clean Your Brother Machine](#)
- [Check Your Brother Machine](#)
- [Correct the Paper Feed to Clear Vertical Lines](#)
- [Change the Print Options to Improve Your Print Results](#)
- [Pack and Ship Your Machine](#)

Replace the Ink Cartridges

Your Brother machine is equipped with an ink dot counter. The ink dot counter automatically monitors the level of ink in each of the four ink cartridges. When the machine detects that an ink cartridge is running out of ink, the machine will display a message.

The LCD displays which ink cartridge needs replacing. Be sure to follow the LCD prompts to replace the ink cartridges in the correct order.

Even though the machine tells you to replace an ink cartridge, there will be a small amount of ink left in the ink cartridge. It is necessary to keep some ink in the ink cartridge to prevent air from drying out and damaging the print head assembly.

CAUTION

If the ink gets into your eye, rinse it with water immediately. If left as is, it may cause redness or mild inflammation of the eye. In case of any abnormality, consult with your doctor.

IMPORTANT

Brother strongly recommends that you do not refill the ink cartridges provided with your machine. We also strongly recommend that you continue to use only Brother Original replacement ink cartridges. Use or attempted use of potentially incompatible ink and/or cartridges in the Brother machine may cause damage to the machine and/or may result in unsatisfactory print quality. Our warranty coverage does not apply to any problem that is caused by the use of unauthorised third-party ink and/or cartridges. To protect your investment and obtain premium performance from the Brother machine, we strongly recommend the use of Brother Original ink cartridges.

1. Open the ink cartridge cover (1).

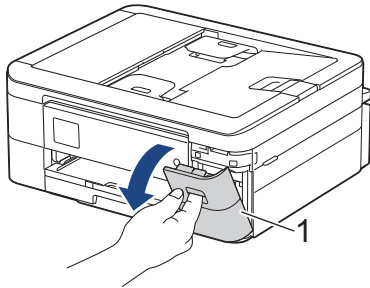

2. Press the lock release lever to release the ink cartridge colour indicated on the LCD and remove the ink cartridge from the machine, as shown in the illustration.

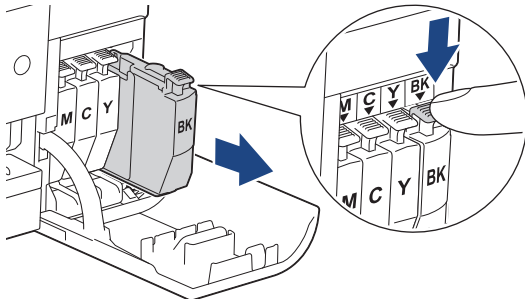

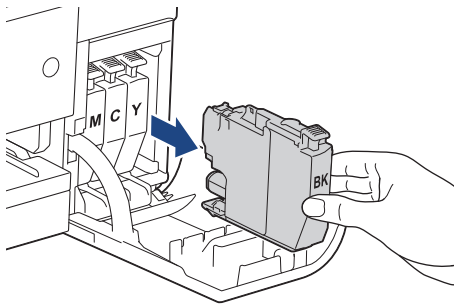

3. Open the new ink cartridge bag for the colour indicated on the LCD, and take out the ink cartridge.

IMPORTANT

- DO NOT touch the ink cartridge in the area indicated (1); this can prevent the machine from detecting the cartridge.

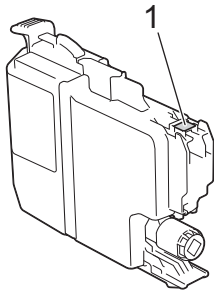

4. Insert the ink cartridge in the direction of the arrow on the label.
Each colour has its own correct position.

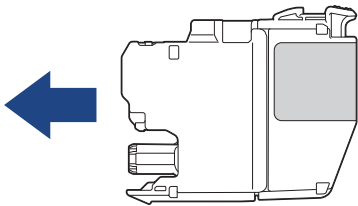

5. Gently push the area marked "PUSH" until the ink cartridge locks into place, and then close the ink cartridge cover.

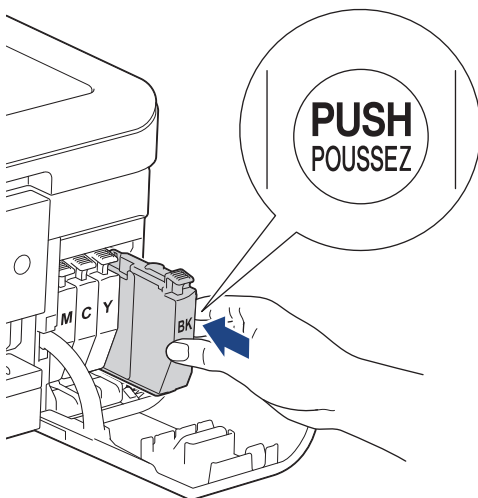

The machine resets the ink dot counter.



If the machine does not detect the ink cartridge after you install it, check that the ink cartridge is installed correctly. Remove the ink cartridge and reinstall it slowly until it locks into place.

IMPORTANT

- DO NOT shake the ink cartridges. If ink stains your skin or clothing, wash with soap or detergent at once.
- DO NOT remove ink cartridges if you do not need to replace them; otherwise, the machine will not know the ink quantity left in the cartridge.
- DO NOT touch the ink cartridge insertion slots; the ink may stain your skin.
- If you mix the colours by installing an ink cartridge in the wrong position, the LCD shows [Wrong Ink Colour].
Check which ink cartridges are not matched by colour to their ink cartridge positions and move them to their correct positions.
- Use unopened ink cartridges by the expiration date written on the ink cartridge package.
- DO NOT dismantle or tamper with the ink cartridge; this can cause the ink to leak out of the ink cartridge.



Related Information

- [Routine Maintenance](#)

Related Topics:

- [Error and Maintenance Messages](#)
 - [Paper Handling and Printing Problems](#)
 - [Pack and Ship Your Machine](#)
-

Clean Your Brother Machine

- [Clean the Scanner](#)
- [Clean the Print Head from Your Brother Machine](#)
- [Clean the Print Head Using Web Based Management](#)
- [Clean the Print Head from Your Computer \(Windows\)](#)
- [Clean the Machine's LCD](#)
- [Clean the Outside of the Machine](#)
- [Clean the Machine's Printer Platen](#)
- [Clean the Paper Feed Rollers](#)
- [Clean the Base Pad](#)
- [Clean the Paper Pick-up Rollers](#)

Clean the Scanner

1. Unplug the machine from the electrical socket.
2. Lift the document cover (1). Clean the scanner glass (2) and the white plastic (3) with a soft lint-free cloth moistened with water.

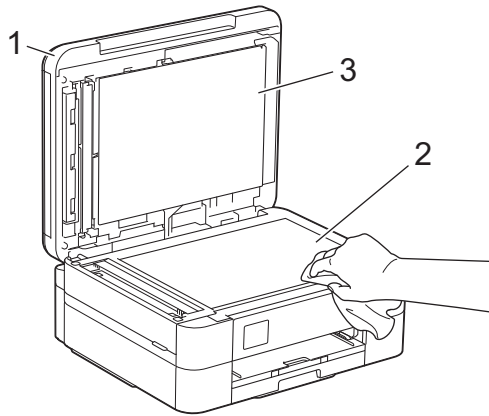

3. In the ADF unit, clean the white bar (1) and the glass strip (2) with a lint-free cloth moistened with water. (ADF models only)

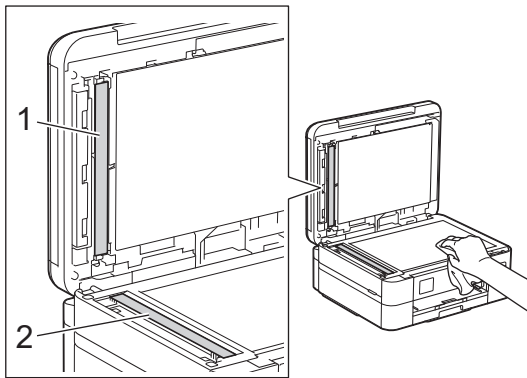

(ADF models only)

If you feel dirt or debris, clean the glass again. You may need to repeat the cleaning process three or four times. To test, make a copy after each cleaning attempt.



When there is a spot of dirt or correction fluid on the glass strip, the printed sample shows a vertical line.



After the glass strip is cleaned, the vertical line is gone.



Related Information

- [Clean Your Brother Machine](#)

Related Topics:

- [Telephone and Fax Problems](#)
 - [Other Problems](#)
-

Clean the Print Head from Your Brother Machine

To maintain good print quality, the machine automatically cleans the print head when needed. If there is a print quality problem, start the cleaning process manually.

- Clean the print head if there is a horizontal line or a blank space in the text or graphics on printed pages. Depending on the problem colour, select to clean Black only, three colours at a time (Yellow/Cyan/Magenta), or all four colours at once.
- Cleaning the print head consumes ink.
- Cleaning too often uses ink unnecessarily.





IMPORTANT

DO NOT touch the print head. Touching the print head may cause permanent damage and may void the print head's warranty.

>> [DCP-J1050DW/MFC-J1010DW](#)

>> [DCP-J1140DW](#)

DCP-J1050DW/MFC-J1010DW

1. Press  (Ink) or **INK** on the control panel.
 2. Press  or  to make your selections:
 - a. Select [Print Head Cleaning]. Press **OK**.
 - b. Select [Black only], [Colour only], or [All]. Press **OK**.
 - c. Select [Normal], [Strong], or [Strongest]. Press **OK**.
 3. Press .
- The machine cleans the print head.



- If you clean the print head and the print has not improved, try installing a new Genuine Brother Brand replacement ink cartridge for each problem colour. Try cleaning the print head again. If the print has not improved, contact Brother customer service or your local Brother dealer.
- You can also clean the print head from your computer.

DCP-J1140DW

1. Press  [Ink] > [Print Head Cleaning].
 2. Press [Black only], [Colour only], or [All].
 3. Press [Normal], [Strong], or [Strongest].
 4. Press [Start].
- The machine cleans the print head.



- If you clean the print head and the print has not improved, try installing a new Genuine Brother Brand replacement ink cartridge for each problem colour. Try cleaning the print head again. If the print has not improved, contact Brother customer service or your local Brother dealer.
- You can also clean the print head from your computer.

✓ Related Information

- [Clean Your Brother Machine](#)

Related Topics:

- [Paper Handling and Printing Problems](#)
 - [Clean the Print Head from Your Computer \(Windows\)](#)
 - [Clean the Print Head Using Web Based Management](#)
-

Clean the Print Head Using Web Based Management

To maintain good print quality, the machine automatically cleans the print head when needed. If there is a print quality problem, start the cleaning process manually.

1. Start your web browser.
2. Type "https://machine's IP address" in your browser's address bar (where "machine's IP address" is the machine's IP address).

For example:

https://192.168.1.2

3. If required, type the password in the **Login** field, and then click **Login**.



The default password to manage this machine's settings is located on the back of the machine and marked "Pwd".

4. Go to the navigation menu, and then click **General > Print Head Cleaning**.



Start from ☰, if the navigation menu is not shown on the left side of the screen.

5. Select the **Normal**, **Strong**, or **Strongest** option for the cleaning strength you want.
6. Click **Start**.
7. Click **Yes**.

The machine starts cleaning.



(Windows) You can also clean the print head using the printer driver.



Related Information

- [Clean Your Brother Machine](#)

Related Topics:

- [Clean the Print Head from Your Brother Machine](#)
 - [Clean the Print Head from Your Computer \(Windows\)](#)
 - [Access Web Based Management](#)
-

Clean the Print Head from Your Computer (Windows)

To maintain good print quality, the machine automatically cleans the print head when needed. If there is a print quality problem, start the cleaning process manually.

1. Do one of the following:

- For Windows 10, Windows Server 2016, and Windows Server 2019

Click  > **Windows System** > **Control Panel**. In the **Hardware and Sound** group, click **View devices and printers**.

- For Windows 8.1

Move your mouse to the lower right corner of your desktop. When the menu bar appears, click **Settings**, and then click **Control Panel**. In the **Hardware and Sound** group, click **View devices and printers**.

- For Windows Server 2012 R2

Click **Control Panel** on the **Start** screen. In the **Hardware** group, click **View devices and printers**.

- For Windows Server 2012

Move your mouse to the lower right corner of your desktop. When the menu bar appears, click **Settings**, and then click **Control Panel**. In the **Hardware** group, click **View devices and printers**.

- For Windows 7 and Windows Server 2008 R2

Click  (**Start**) > **Devices and Printers**.

- For Windows Server 2008

Click  (**Start**) > **Control Panel** > **Hardware and Sound** > **Printers**.

2. Right-click the **Brother XXX-XXXX Printer** icon (where XXX-XXXX is the name of your model), and then select **Printing preferences**. If printer driver options appear, select your printer driver.

The printer driver dialog box appears.

3. Click the **Maintenance** tab.

4. Select one of the following options:

Option	Description
Check Print Quality...	Use to print the test page and check the print quality.
Print Head Cleaning...	Use to start the cleaning process manually. Select if a line or blank spaces appear in text or graphics on the test page.

5. Do one of the following:

- If you selected the **Check Print Quality...** option, click **Start**.

The machine prints the test page.

- If you selected the **Print Head Cleaning...** option, select the **Black only**, **Colour only**, or **All** option for the cleaning type, and then click **Next**.

6. Select the **Normal**, **Strong**, or **Strongest** option for the cleaning strength, and then click **Next**.

7. Click **Start**.

The machine starts cleaning.

Related Information

- [Clean Your Brother Machine](#)

Related Topics:

- [Paper Handling and Printing Problems](#)
- [Clean the Print Head from Your Brother Machine](#)

-
- Clean the Print Head Using Web Based Management
-

Clean the Machine's LCD

IMPORTANT

DO NOT use liquid cleaners (including ethanol).

1. Press and hold down  to turn off the machine. The LCD displays [Shutting Down] for a few seconds before the power goes off.
2. Clean the LCD with a dry, soft lint-free cloth.

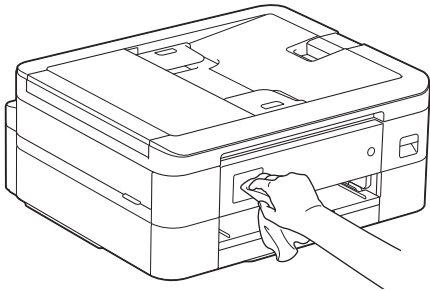

Related Information

- [Clean Your Brother Machine](#)

Clean the Outside of the Machine

IMPORTANT

- Cleaning with volatile liquids such as thinner or benzine will damage the outside surface of the machine.
- DO NOT use cleaning materials that contain ammonia.
- DO NOT use isopropyl alcohol to remove dirt from the control panel. It may crack the panel.

1. If the paper support flap is open, close it, and then close the paper support.
2. Pull the paper tray (1) completely out of the machine.

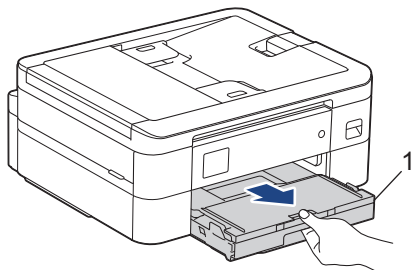

3. Wipe the outside of the machine with a dry, lint-free cloth to remove dust.

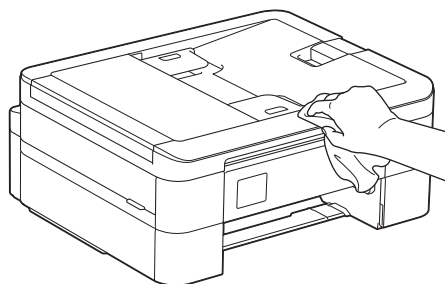

4. Lift the output paper tray cover and remove anything that is stuck inside the paper tray.

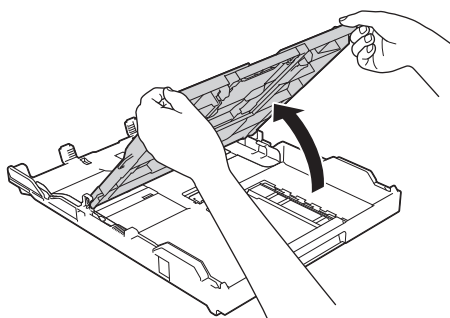

5. Wipe the inside and the outside of the paper tray with a dry, lint-free cloth to remove dust.

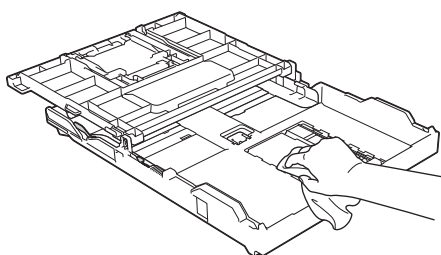

6. Close the output paper tray cover and slowly push the paper tray completely into the machine.

✓ Related Information

- [Clean Your Brother Machine](#)

Clean the Machine's Printer Platen

WARNING

 Be sure to unplug the machine from the electrical socket before cleaning the printer platen to avoid an electrical shock.

1. Using both hands, use the finger holds on each side of the machine to lift the scanner cover into the open position.
2. Clean the machine's printer platen (1) and the area around it, wiping off scattered ink with a dry, soft lint-free cloth.

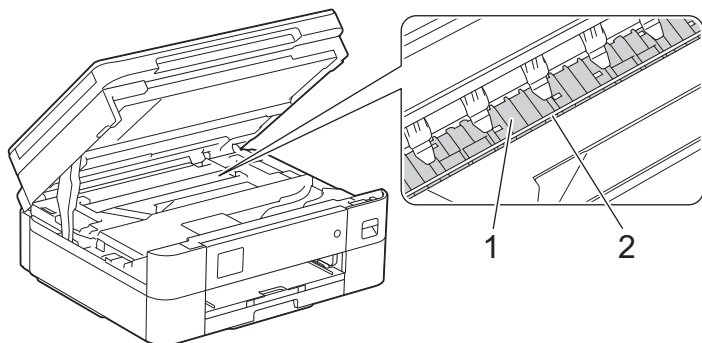

IMPORTANT

DO NOT touch the encoder strip, the thin strip of plastic that stretches across the width of the machine (2). Doing this may cause damage to the machine.

3. Gently close the scanner cover using both hands.

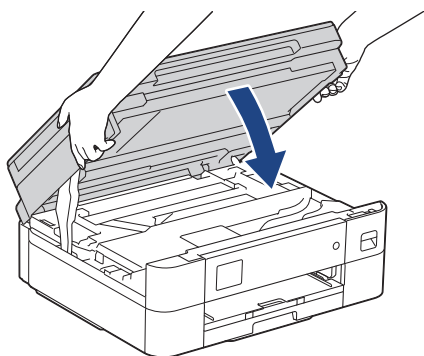

4. Reconnect the power cord.

Related Information

- [Clean Your Brother Machine](#)

Related Topics:

- [Paper Handling and Printing Problems](#)

Clean the Paper Feed Rollers

If the paper feed rollers are stained with ink or have a buildup of paper dust, it may cause paper feed problems.

1. Unplug the machine from the electrical socket.
2. If the paper support flap is open, close it, and then close the paper support.
3. Pull the paper tray (1) completely out of the machine.

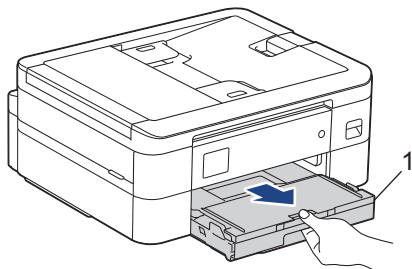

4. Clean the front side of the Paper Feed Rollers (1) with a soft lint-free cloth moistened with water, using a side-to-side motion. After cleaning, wipe the rollers with a dry, soft lint-free cloth to remove all moisture.

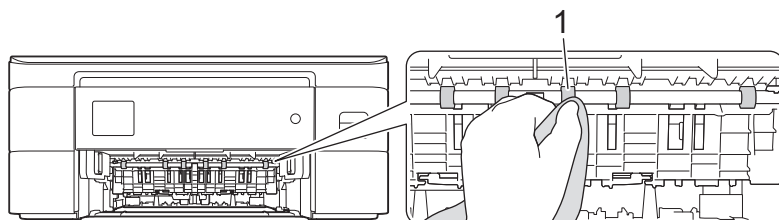

5. Lift the flap (2), and then clean the back side of the Paper Feed Rollers (1) with a soft lint-free cloth moistened with water. After cleaning, wipe the rollers with a dry, soft lint-free cloth to remove all moisture.

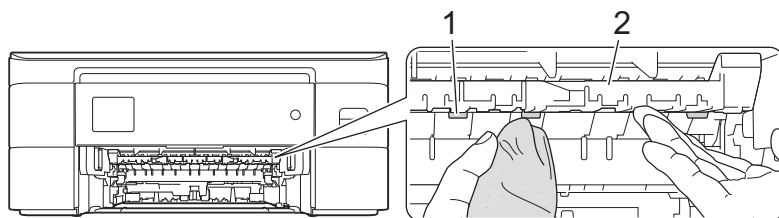

6. Slowly push the paper tray completely into the machine.
7. Reconnect the power cord.



Do not use the machine again until the rollers are dry. Using the machine before the rollers are dry may cause paper feed problems.



Related Information

- [Clean Your Brother Machine](#)

Related Topics:

- [Paper Handling and Printing Problems](#)

Clean the Base Pad

Cleaning the Base Pad periodically may prevent the machine from feeding multiple sheets of paper when there are only a few sheets of paper left in the tray.

1. If the paper support flap is open, close it, and then close the paper support.
2. Pull the paper tray (1) completely out of the machine.

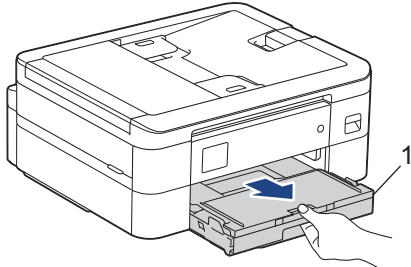

3. Clean the Base Pad (1) with a soft lint-free cloth moistened with water. After cleaning, wipe the pad with a dry, soft lint-free cloth to remove all moisture.

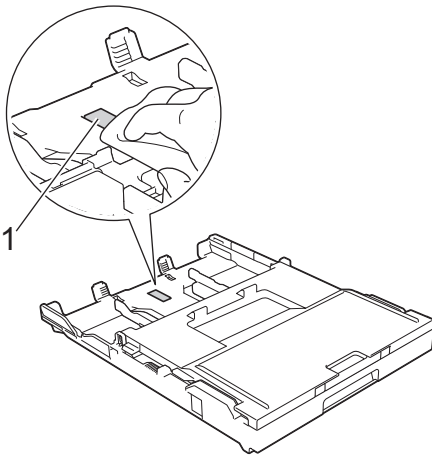

4. Slowly push the paper tray completely into the machine.

✓ Related Information

- [Clean Your Brother Machine](#)

Related Topics:

- [Paper Handling and Printing Problems](#)

Clean the Paper Pick-up Rollers

Cleaning the paper pick-up rollers periodically may prevent paper jams by ensuring that paper feeds correctly.

1. Unplug the machine from the electrical socket.
2. If the paper support flap is open, close it, and then close the paper support.
3. Pull the paper tray (1) completely out of the machine as shown by the arrow.

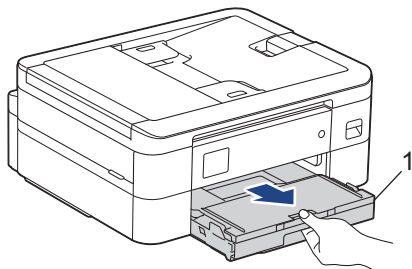

4. Clean the Paper Pick-up Rollers (1) with a soft lint-free cloth moistened with water. Slowly turn the rollers so that the whole surface is cleaned. After cleaning, wipe the rollers with a dry, soft lint-free cloth to remove all moisture.

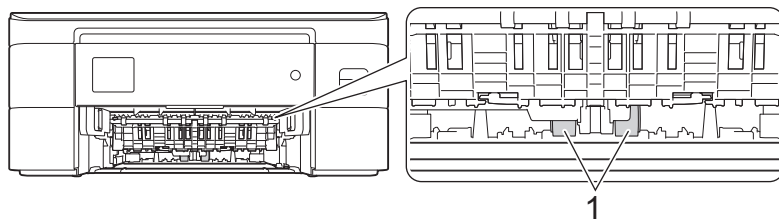

5. Slowly push the paper tray completely into the machine.
6. Reconnect the power cord.

✓ Related Information

- [Clean Your Brother Machine](#)

Related Topics:

- [Error and Maintenance Messages](#)
- [Paper Handling and Printing Problems](#)

Check Your Brother Machine

- [Check the Print Quality](#)
- [Check the Print Alignment from Your Brother Machine](#)
- [Check the Ink Volume \(Page Gauge\)](#)
- [Monitor Machine Status from Your Computer \(Windows\)](#)
- [Monitor Machine Status Using Brother iPrint&Scan \(Windows/Mac\)](#)







Check the Print Quality

If faded or streaked colours and text appear or if text is missing on your printouts, the print head nozzles may be clogged. Print the check sheet and look at the nozzle check pattern.

>> [DCP-J1050DW/MFC-J1010DW](#)

>> [DCP-J1140DW](#)

DCP-J1050DW/MFC-J1010DW



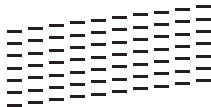

1. Press  (Ink) or **INK** on the control panel.
2. Press  or  to make your selections:
 - a. Select [Impr. PrintQuality]. Press **OK**.
 - b. Select [Impr. PrintQuality] again. Press **OK**.
3. Press .
- The machine prints the check sheet.
4. Check the quality of the four colour blocks on the sheet.
5. When an LCD message prompts you to check the print quality, do one of the following:
 - If all lines are clear and visible, press  to select [No].
The Print Quality check finishes.
 - If lines are missing (see **Poor**, below), press  to select [Yes].

OK

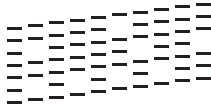

Poor



6. When the LCD message prompts you to check the print quality of each colour, press  or  to select the pattern (1–4) that most closely matches the printing result. Press **OK**.
7. Do one of the following:
 - If print head cleaning is needed, press  to start the cleaning procedure.
 - If print head cleaning is not needed, the menu screen reappears on the LCD.
8. After the cleaning procedure is finished, the LCD message prompts you to check the print quality again.
Press  [Yes] to start the print quality check.
9. Press  again.
The machine prints the check sheet again. Check the quality of the four colour blocks on the sheet again.

IMPORTANT

DO NOT touch the print head. Touching the print head may cause permanent damage and may void the print head's warranty.





When a print head nozzle is clogged, the printed sample looks like this:



After the print head nozzle is cleaned, the horizontal lines are gone:



DCP-J1140DW

1. Press  [Ink] > [Improve Print Quality] > [Check Print Quality].
2. Press [Start].
The machine prints the check sheet.
3. Check the quality of the four colour blocks on the sheet.
4. When an LCD message prompts you to check the print quality, do one of the following:
 - If all lines are clear and visible, press [No], and then press  to finish the Print Quality check.
 - If lines are missing (see **Poor**, as follows), press [Yes].

OK

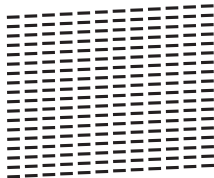

Poor

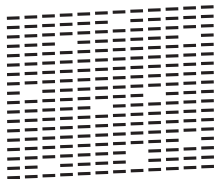

5. When the LCD message prompts you to check the print quality of each colour, press the number of the pattern (1–4) that most closely matches the printing result.
6. Do one of the following:
 - If print head cleaning is needed, press [Start] to start the cleaning procedure.
 - If print head cleaning is not needed, the menu screen reappears on the touchscreen. Press .
7. After the cleaning procedure is finished, the LCD message prompts you to print the check sheet again. Press [Yes], and then press [Start].

The machine prints the check sheet again. Check the quality of the four colour blocks on the sheet again.

IMPORTANT

DO NOT touch the print head. Touching the print head may cause permanent damage and may void the print head's warranty.



When a print head nozzle is clogged, the printed sample looks like this:



After the print head nozzle is cleaned, the lines are gone:



Related Information

- [Check Your Brother Machine](#)

Related Topics:

- [Paper Handling and Printing Problems](#)
 - [Clean the Print Head from Your Brother Machine](#)
-



Check the Print Alignment from Your Brother Machine





If your printed text becomes blurred or images become faded after transporting the machine, adjust the print alignment.

>> [DCP-J1050DW/MFC-J1010DW](#)

>> [DCP-J1140DW](#)

DCP-J1050DW/MFC-J1010DW

Before adjusting the print alignment, complete a print quality check first by pressing  (Ink) or **INK** on the control panel,  or  to select [Impr. PrintQuality] > [Impr. PrintQuality] again, and then **OK**.

1. Press  (Ink) or **INK** on the control panel.
2. Press  or  to make your selections:
 - a. Select [Impr. PrintQuality]. Press **OK**.
 - b. Select [Alignment]. Press **OK**.
3. Press  after a confirmation message if a print quality check has been completed appears on the LCD.
4. Select [Auto] or [Manual].
 - If you select the [Auto] mode, the print alignment is automatically adjusted by scanning the check sheet.
 - If you select the [Manual] mode, you need to input information printed on the check sheet manually.
5. If you selected the [Auto] mode, select the paper size to print the check sheet on.
6. Load specified size paper in the tray, and then press .
The machine prints the check sheet.
7. Follow the instructions on the LCD.



When the print alignment is not adjusted correctly, text looks blurry or crooked, like this:

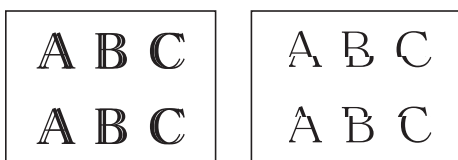

After the print alignment is adjusted correctly, text looks like this:

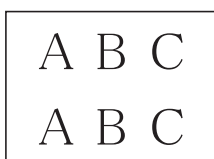

DCP-J1140DW

Before adjusting the print alignment, complete a print quality check first by pressing  [Ink] > [Improve Print Quality] > [Check Print Quality].

1. Press  [Ink] > [Improve Print Quality] > [Alignment].
2. Press [Next].
3. Press [Yes] after a confirmation message if a print quality check has been completed appears on the LCD.
4. Press [Auto] or [Manual].
 - If you select the [Auto] mode, the print alignment is automatically adjusted by scanning the check sheet.

-
- If you select the [Manual] mode, you need to input information printed on the check sheet manually.
5. If you selected the [Auto] mode, select the paper size to print the check sheet on.
 6. Load specified size paper in the tray, and then press [Start].
The machine prints the check sheet.
 7. Follow the instructions on the LCD.



When the print alignment is not adjusted correctly, text looks blurry or crooked, like this:

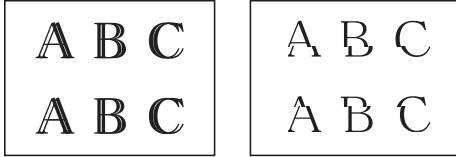

After the print alignment is adjusted correctly, text looks like this:



Related Information

- [Check Your Brother Machine](#)

Related Topics:

- [Paper Handling and Printing Problems](#)
-

Check the Ink Volume (Page Gauge)

Although an ink volume icon appears on the machine's LCD, you can view a larger graph that displays the approximate ink remaining in each cartridge.

>> [DCP-J1050DW/MFC-J1010DW](#)

>> [DCP-J1140DW](#)

DCP-J1050DW/MFC-J1010DW

1. Press  (Ink) or **INK** on the control panel.
2. Press **▲** or **▼** to select [Ink Volume]. Press **OK**.

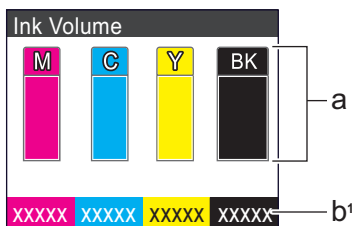

The LCD displays the ink volume. ¹



- a. Displays the cartridge ink level.
- b. The page gauge ¹ shows the approximate number of remaining pages that can be printed with the cartridges.



- When the ink cartridge is near the end of its life or having a problem, one of the following icons appears:

	The ink level is low.
	The ink cartridge needs to be replaced.
	There is a problem with the ink cartridge.

- To change the display settings for the approximate page yield, press **Stop/Exit** to return to the Home screen, press **Settings**, select [Ink], and then select [Remaining Pages].

Press **OK** and follow the instructions on the LCD.

- To check or print the model numbers of the ink cartridges, press **Clear/Back** to go back to the [Ink] menu screen, and then select [Ink Cartridge Model].

Press **OK** and follow the instructions on the LCD.

3. Press **Stop/Exit**.



- You can also check the ink volume from your computer.
- For detailed information about the measuring methods used for the approximate yields, visit support.brother.com/yield.

DCP-J1140DW

1. Press  [Ink] > [Ink Volume].

The touchscreen displays the ink volume and the page gauge. ²

¹ Page Gauge is an estimate for informational purposes only and does not display the actual remaining page yield. For actual cartridge yield information, visit support.brother.com/yield.

² Page Gauge is an estimate for informational purposes only and does not display the actual remaining page yield. For actual cartridge yield information, visit support.brother.com/yield.



- a. Displays the cartridge ink level.
- b. Press to change the display settings for the approximate page yield.
- c. The page gauge ² shows the approximate number of remaining pages that can be printed with the cartridges.



- When the ink cartridge is near the end of its life or having a problem, one of the following icons appears:

	The ink level is low.
	The ink cartridge needs to be replaced.
	There is a problem with the ink cartridge.

- To check or print the model numbers of the ink cartridges, press (Back) to go back to the [Ink] menu screen.
Press [Ink Cartridge Model], and follow the instruction on the touchscreen.

2. Press .



- You can also check the ink volume from your computer.
- For detailed information about the measuring methods used for the approximate yields, visit support.brother.com/yield.



Related Information



- [Check Your Brother Machine](#)

Related Topics:

- [Touchscreen LCD Overview](#)
- [Settings Screen Overview](#)
- [Print a Document \(Windows\)](#)
- [Monitor Machine Status from Your Computer \(Windows\)](#)
- [Monitor Machine Status Using Brother iPrint&Scan \(Windows/Mac\)](#)

Monitor Machine Status from Your Computer (Windows)

The Status Monitor utility is a configurable software tool for monitoring the status of one or more machines; it allows you to get immediate notification of errors.

- Do one of the following:
 - Double-click the  icon in the task tray.
 - Launch  (**Brother Utilities**), and then click the drop-down list and select your model name (if not already selected). Click **Tools** in the left navigation bar, and then click **Status Monitor**.

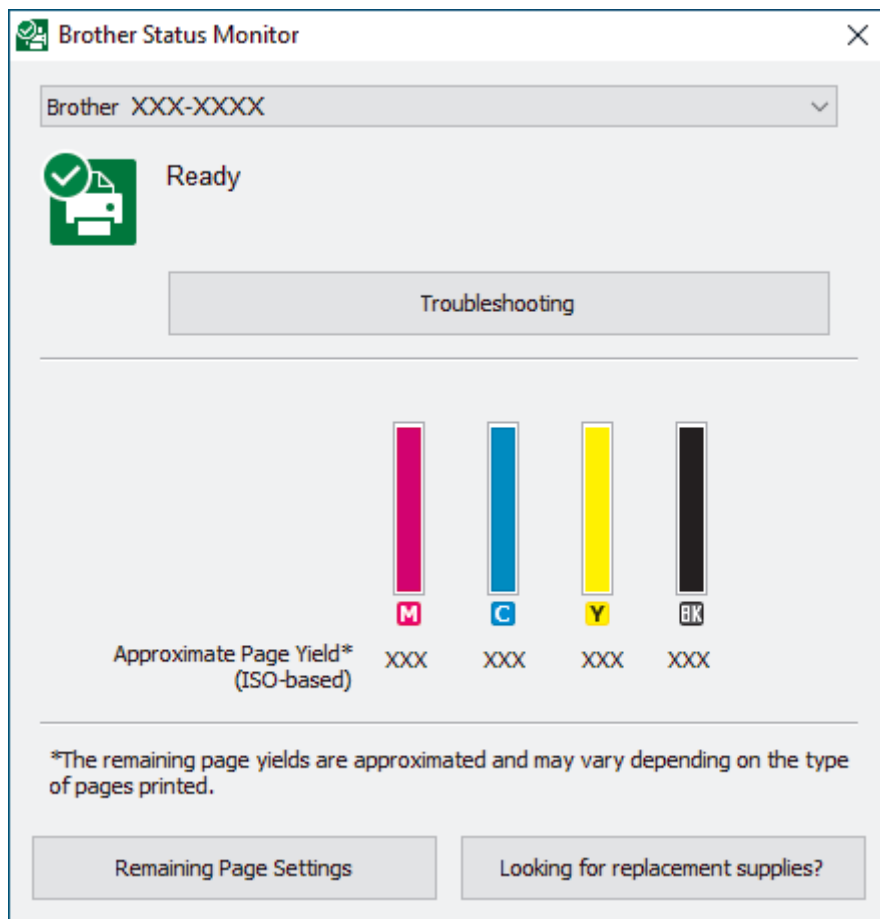

Troubleshooting

Click the **Troubleshooting** button to access the troubleshooting website.



Remaining Page Settings

Click the **Remaining Page Settings** button to change the display settings for the approximate page yield.

Looking for replacement supplies?

Click the **Looking for replacement supplies?** button for more information on Brother original supplies.

Error icons

Icon	Description
	The ink level is low.
	The ink cartridge needs to be replaced.
	There is a problem with the ink cartridge.



- You can also check the ink amount using Web Based Management.



Related Information

- [Check Your Brother Machine](#)
 - [Status Monitor Indicators and What They Mean \(Windows\)](#)
 - [Turn Off the Show Status Monitor Feature \(Windows\)](#)
 - [Turn Off the Status Monitor \(Windows\)](#)

Related Topics:

- [Cancel a Print Job \(Windows\)](#)
 - [Check the Ink Volume \(Page Gauge\)](#)
-

Status Monitor Indicators and What They Mean (Windows)

When you start up your computer, the **Brother Status Monitor** icon appears on the task tray.

- A green icon indicates the normal stand-by condition.



- A yellow icon indicates a warning.



- A red icon indicates an error has occurred.



- A grey icon indicates the machine is offline.



Related Information

- [Monitor Machine Status from Your Computer \(Windows\)](#)

Turn Off the Show Status Monitor Feature (Windows)

The Show Status Monitor feature lets you know if there is a problem with a device that your computer is monitoring. The default setting is **Only when printing from this PC**. To turn it off, follow these steps:

1. Right-click the  (**Brother Status Monitor**) icon or window, select the **Status Monitor Settings** option, and then click **Options**.

The **Options** window appears.

2. Click the **Show Status Monitor** tab, and then select **Off** for **Status Monitor Display Options**.
3. Click **OK**.



Even if the Show Status Monitor feature is turned off, you can check the machine's status at any time by displaying the Status Monitor.



Related Information

- [Monitor Machine Status from Your Computer \(Windows\)](#)

Turn Off the Status Monitor (Windows)

1. Right-click the  (**Brother Status Monitor**) icon or window, and then select **Exit**.
2. Click **OK**.

Related Information

- [Monitor Machine Status from Your Computer \(Windows\)](#)
-

Monitor Machine Status Using Brother iPrint&Scan (Windows/Mac)

Brother iPrint&Scan allows you to monitor your Brother machine's status.

1. Start Brother iPrint&Scan.

- Windows

Launch  (Brother iPrint&Scan).

- Mac



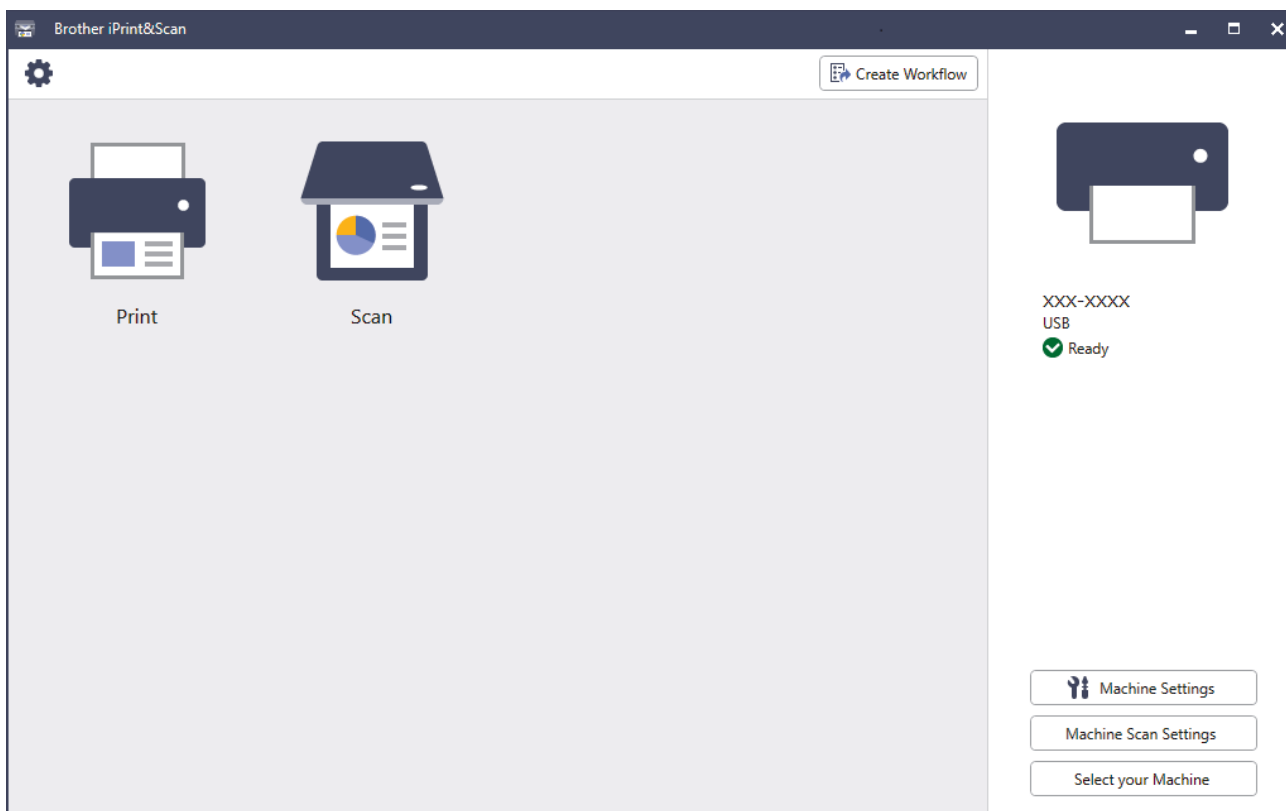

In the **Finder** menu bar, click **Go > Applications**, and then double-click the iPrint&Scan icon.

The Brother iPrint&Scan screen appears.



2. If your Brother machine is not selected, click the **Select your Machine** button, and then select your model name from the list. Click **OK**.



Status icons

Icon	Description
	A green icon indicates the normal stand-by condition.
	A yellow icon indicates a warning.
	A red icon indicates an error has occurred.
	A grey icon indicates the machine is offline.

Error icons

Icon	Description
	The ink level is low.
	The ink cartridge needs to be replaced.
	There is a problem with the ink cartridge.



- The actual screen may differ depending on the version of the application.
 - The remaining ink amount is approximate and may differ from the actual amount of remaining ink.
 - You can also check the remaining ink amount using Web Based Management.
-



Related Information

- [Check Your Brother Machine](#)

Related Topics:

- [Check the Ink Volume \(Page Gauge\)](#)
-



Correct the Paper Feed to Clear Vertical Lines





Adjust the paper feed to reduce vertical lines.

>> [DCP-J1050DW/MFC-J1010DW](#)

>> [DCP-J1140DW](#)

DCP-J1050DW/MFC-J1010DW

Before adjusting the print alignment, complete a print quality check first by pressing  (Ink) or **INK** on the control panel,  or  to select [Impr. PrintQuality] > [Impr. PrintQuality] again, and then **OK**.

1. Press  (Ink) or **INK** on the control panel.
2. Press  or  to make your selections:
 - a. Select [Impr. PrintQuality]. Press **OK**.
 - b. Select [Correct Paper Feed]. Press **OK**.
3. Press  after a confirmation message if a print quality check has been completed appears on the LCD.
4. Select [Auto] or [Manual].
 - If you select the [Auto] mode, the paper feed is automatically adjusted by scanning the check sheet.
 - If you select the [Manual] mode, you need to input information printed on the check sheet manually.
5. If you selected the [Auto] mode, select the paper size to print the check sheet on.
6. Load specified size paper in the tray, and then press .
The machine prints the check sheet.
7. Follow the instructions on the LCD.

DCP-J1140DW

Before adjusting the paper feed, make a print quality check first by pressing  [Ink] > [Improve Print Quality] > [Check Print Quality].

1. Press  [Ink] > [Improve Print Quality] > [Correct Paper Feed].
2. Press [Next].
3. Press [Yes] after a confirmation message if a print quality check has been completed appears on the LCD.
4. Press [Auto] or [Manual].
 - If you select the [Auto] mode, the paper feed is automatically adjusted by scanning the check sheet.
 - If you select the [Manual] mode, you need to input information printed on the check sheet manually.
5. If you selected the [Auto] mode, select the paper size to print the check sheet on.
6. Load specified size paper in the tray, and then press [Start].
The machine prints the check sheet.
7. Follow the instructions on the LCD.

Related Information

- [Routine Maintenance](#)

Related Topics:

- [Paper Handling and Printing Problems](#)
- [Other Problems](#)

Change the Print Options to Improve Your Print Results

If your printouts do not look the way you expect, change the print settings on your Brother machine to improve printout quality. Print speed may be slower when using these settings.



- These instructions allow you to improve your print results when you are using your machine for copying or printing from a mobile device.
- If you are experiencing poor print quality when printing from your computer, change your printer driver settings.

>> [DCP-J1050DW/MFC-J1010DW](#)

>> [DCP-J1140DW](#)

DCP-J1050DW/MFC-J1010DW

1. Press  (Ink) or **INK** on the control panel.
2. Press **▲** or **▼** to select [Print Options]. Press **OK**.
3. Press **▲** or **▼** to select one of the following options:

Option	Description
Reduce Smudging	Select this option if you have problems with smudged printouts or paper jams.
Enhance Print	Select this option if you have problems with blurred printouts.

4. Press **OK**.
5. Press **▲** or **▼** to select the option you want. Press **OK**.
6. Press **Stop/Exit**.

DCP-J1140DW

1. Press  [Ink] > [Print Options].
2. Press one of the following options:

Option	Description
Reduce Smudging	Select this option if you have problems with smudged printouts or paper jams.
Enhance Print	Select this option if you have problems with blurred printouts.

3. Follow the LCD menus.
4. Press .

✓ Related Information

- [Routine Maintenance](#)

Related Topics:

- [Copy on Both Sides of the Paper \(2-sided Copy\)](#)
- [Paper Handling and Printing Problems](#)
- [Other Problems](#)
- [Prevent Smudged Printouts and Paper Jams \(Windows\)](#)
- [Print Settings \(Windows\)](#)

Pack and Ship Your Machine

- When you transport the machine, use the packing materials that came with your machine. Do not tip or turn the product upside down. If you do not pack the machine correctly, any damage that may occur in transit may not be covered by your warranty.
- The machine should be adequately insured with the carrier.

IMPORTANT

It is important to allow the machine to “park” the print head after a print job. Listen carefully to the machine before unplugging it to make sure that all mechanical noises have stopped. Not allowing the machine to finish this parking process may lead to print problems and possible damage to the print head.

1. Unplug the machine from the electrical socket.
2. (MFC-J1010DW) Unplug the machine from the telephone wall socket and take the telephone line cord out of the machine.
3. Using both hands, use the finger holds on each side of the machine to lift the scanner cover into the open position.
4. Unplug the interface cable from the machine, if it is connected.
5. Gently close the scanner cover using the finger holds on each side.

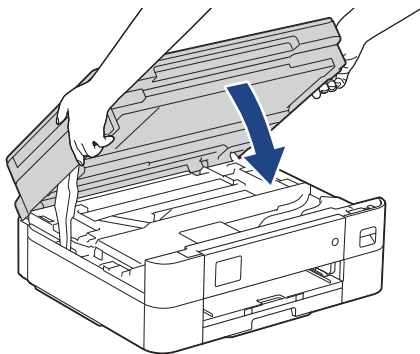

6. Open the ink cartridge cover.
7. Press the ink release levers to release the ink cartridges and then take out the ink cartridges.
8. Install the orange protective part and then close the ink cartridge cover.

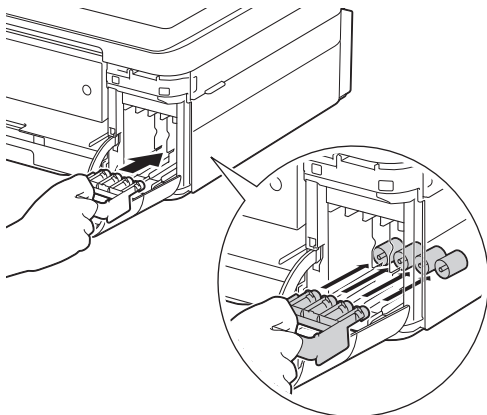

IMPORTANT

- Make sure the plastic tab on the left side of the orange protective part (1) locks securely into place (2).

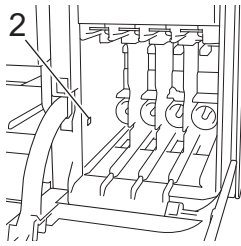
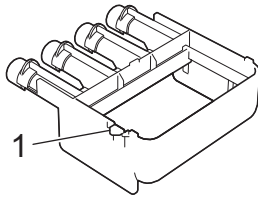

- If you are not able to find the orange protective part, ship the machine without it. DO NOT leave the ink cartridges in the machine during shipping.

9. Wrap the machine in the bag.

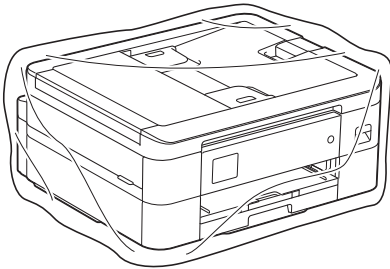

10. Pack the machine in the original carton with the original packing material as shown below.
Do not pack the used ink cartridge in the carton.

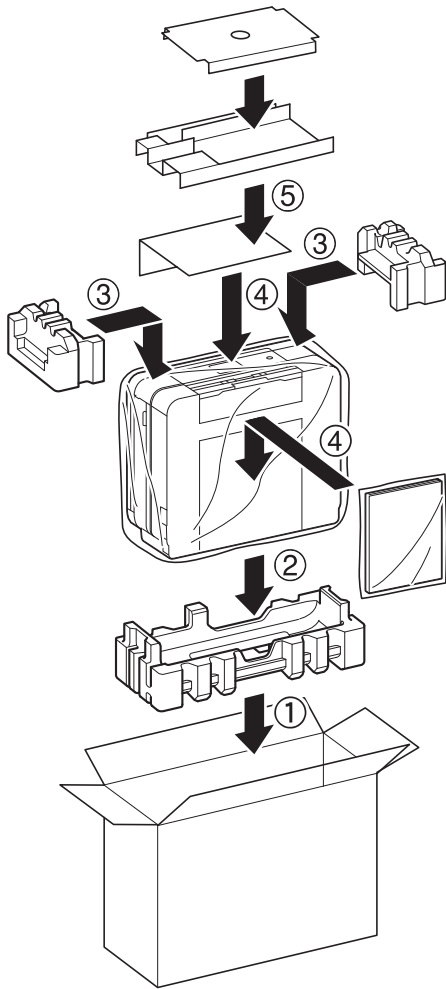

11. Close the carton and tape it shut.



Related Information

- [Routine Maintenance](#)

Related Topics:

- [Replace the Ink Cartridges](#)

Machine Settings

Customise settings and features to make your machine a more efficient work tool.

- [Change Machine Settings from the Control Panel](#)
- [Change Machine Settings Using Web Based Management](#)

Change Machine Settings from the Control Panel

- [In the Event of Power Failure \(Memory Storage\)](#)
- [General Settings](#)
- [Save Your Favourite Settings as a Shortcut](#)
- [Print Reports](#)
- [Settings and Features Tables](#)

In the Event of Power Failure (Memory Storage)

- Your menu settings are stored permanently and will not be lost.
- Temporary settings (for example: Contrast and Overseas Mode) are lost.
- (MFC-J1010DW) The date and time is retained for approximately 24 hours.



Related Information

- [Change Machine Settings from the Control Panel](#)
-

General Settings

- [Adjust the Machine Volume](#)
- [Change for Daylight Saving Time Automatically](#)
- [Set Sleep Mode Countdown](#)
- [Set the Machine to Power Off Automatically](#)
- [Set the Date and Time](#)
- [Set the Time Zone](#)
- [Adjust the LCD Backlight Brightness](#)
- [Change How Long the LCD Backlight Stays On](#)
- [Set Your Station ID](#)
- [Set Tone or Pulse Dialling Mode](#)
- [Reduce Printing Noise](#)
- [Change the Language Displayed on the LCD](#)
- [Change the Keyboard Setting](#)

Adjust the Machine Volume

Related Models: MFC-J1010DW

1. Press **Settings**.
2. Press ▲ or ▼ to make your selections:
 - a. Select [General Setup]. Press **OK**.
 - b. Select [Volume]. Press **OK**.
3. Press ▲ or ▼ to select one of the following options:

Option	Description
Ring	Adjust the ring volume.
Beep	Adjust the volume when you press a button, make a mistake, or after you send or receive a fax.
Speaker	Adjust the speaker volume.

4. Press **OK**.
5. Press ▲ or ▼ to select the [Off], [Low], [Med], or [High] option. Press **OK**.
6. Press **Stop/Exit**.



Related Information

- [General Settings](#)

Change for Daylight Saving Time Automatically

Related Models: MFC-J1010DW

You can program the machine to change automatically for Daylight Saving Time.

It will reset itself forward one hour in the spring, and backward one hour in the autumn. Make sure you have set the correct date and time in the [Date & Time] setting.

1. Press **Settings**.
2. Press **▲** or **▼** to make your selections:
 - a. Select [Initial Setup]. Press **OK**.
 - b. Select [Date & Time]. Press **OK**.
 - c. Select [Auto Daylight]. Press **OK**.
 - d. Select [On] or [Off]. Press **OK**.
3. Press **Stop/Exit**.



Related Information

- [General Settings](#)

Set Sleep Mode Countdown

The Sleep Mode (or Power Save Mode) setting can reduce power consumption. When the machine is in Sleep Mode, it acts as though it is turned off. The machine will wake up and start printing when it receives a print job or a fax. Use these instructions to set a time delay (countdown) before the machine enters Sleep Mode.

- The timer will restart if any operation is carried out on the machine, such as receiving a fax or a print job.
- The factory setting is five minutes.

>> [DCP-J1050DW/MFC-J1010DW](#)

>> [DCP-J1140DW](#)



DCP-J1050DW/MFC-J1010DW

1. Press **Settings**.
2. Press **▲** or **▼** to make your selections:
 - a. Select [General Setup]. Press **OK**.
 - b. Select [Sleep Time]. Press **OK**.
 - c. Select the number of minutes (1-60) you want to set. Press **OK**.
3. Press **Stop/Exit**.



When the machine goes into Sleep Mode, the LCD backlight turns off.

DCP-J1140DW

1. Press  [Settings] > [All Settings] > [General Setup] > [Sleep Time].
2. Enter the number of minutes (1-60) you want to set on the touchscreen, and then press [OK].
3. Press .



When the machine goes into Sleep Mode, the LCD backlight turns off.

✓ Related Information

- [General Settings](#)

Related Topics:

- [Set the Machine to Power Off Automatically](#)

Set the Machine to Power Off Automatically

The Auto Power Off feature can reduce power consumption. Set the amount of time that the machine must be in Sleep Mode before it automatically powers off. When this feature is set to [Off], you must power off the machine manually.

To turn on the machine after the Auto Power Off feature has turned it Off, press .



The machine does not power off automatically when:

- Fax jobs are stored in the machine's memory. (MFC-J1010DW)
- An error prevents the Fax Journal report from printing. (MFC-J1010DW)
- The machine is connected to a telephone line. (MFC-J1010DW)
- The machine is connected to a wireless network.
- [WLAN Enable] is set to [On].



>> [DCP-J1050DW/MFC-J1010DW](#)

>> [DCP-J1140DW](#)

DCP-J1050DW/MFC-J1010DW

1. Press **Settings**.
2. Press **▲** or **▼** to make your selections:
 - a. Select [General Setup]. Press **OK**.
 - b. Select [Auto Power Off]. Press **OK**.
 - c. Select [Off], [1 hour], [2 hours], [4 hours], or [8 hours]. Press **OK**.
3. Press **Stop/Exit**.

DCP-J1140DW

1. Press  [Settings] > [All Settings] > [General Setup] > [Auto Power Off].
2. Press **▲** or **▼** to display the [Off], [1 hour], [2 hours], [4 hours], or [8 hours] option, and then press the option you want.
3. Press .

Related Information

- [General Settings](#)

Related Topics:

- [Set the Fax Journal's Interval Period](#)
- [Set Sleep Mode Countdown](#)
- [Fax Reports](#)

Set the Date and Time

(MFC models)

The LCD displays the date and time. If they are not current, re-enter them. You can add the date and time to each fax you send by setting your Station ID.

(DCP models)

If the machine's power has been off, the machine's date and time may not be current. Re-enter them.

>> [DCP-J1050DW](#)

>> [MFC-J1010DW](#)

>> [DCP-J1140DW](#)

DCP-J1050DW

1. Press **Settings**.
2. Press **▲** or **▼** to make your selections:
 - a. Select [Initial Setup]. Press **OK**.
 - b. Select [Date & Time]. Press **OK**.
 - c. Select [Date]. Press **OK**.
3. Press **▲**, **▼**, **◀** or **▶** to select the following:
 - a. To enter the last two digits of the year, select the numbers and then press **OK**. To save the year, select [OK] and then press **OK**.
 - b. To enter the two digits for the month, select the numbers and then press **OK**. To save the month, select [OK] and then press **OK**.
 - c. To enter the two digits for the day, select the numbers and then press **OK**. To save the day, select [OK] and then press **OK**.
4. Press **▲** or **▼** to select [Time], and then press **OK**.
5. To enter the four digits of the time (in 24-hour format), press **▲**, **▼**, **◀** or **▶** to select the numbers, and then select [OK]. Press **OK**.
6. Press **Stop/Exit**.

MFC-J1010DW

1. Press **Settings**.
2. Press **▲** or **▼** to make your selections:
 - a. Select [Initial Setup]. Press **OK**.
 - b. Select [Date & Time]. Press **OK**.
 - c. Select [Date]. Press **OK**.
3. Enter the last two digits of the year using the dial pad, and then press **OK**.
4. Enter the two digits for the month using the dial pad, and then press **OK**.
5. Enter the two digits for the day using the dial pad, and then press **OK**.
6. Press **▲** or **▼** to select [Time], and then press **OK**.
7. Enter the time (in 24-hour format) using the dial pad, and then press **OK**.
8. Press **Stop/Exit**.

DCP-J1140DW

1. Press  [Settings].
2. Press  [Date & Time].

-
3. Press [Date].
 4. Enter the last two digits of the year on the touchscreen, and then press [OK].
 5. Enter two digits for the month on the touchscreen, and then press [OK].
 6. Enter two digits for the day on the touchscreen, and then press [OK].
 7. Press [Time].
 8. Enter the time (in 24-hour format) using the touchscreen.
Press [OK].
(For example, enter 19:45 for 7:45 PM.)
 9. Press .



Related Information

- [General Settings](#)

Related Topics:

- [Set Your Station ID](#)
-

Set the Time Zone

Set the time zone for your location on the machine.



>> [DCP-J1050DW/MFC-J1010DW](#)

>> [DCP-J1140DW](#)

DCP-J1050DW/MFC-J1010DW

1. Press **Settings**.
2. Press **▲** or **▼** to make your selections:
 - a. Select [Initial Setup]. Press **OK**.
 - b. Select [Date & Time]. Press **OK**.
 - c. Select [Time Zone]. Press **OK**.
3. Enter your time zone, and then select [OK].
4. Press **Stop/Exit**.

DCP-J1140DW

1. Press  [Settings].
2. Press  [Date & Time] > [Time Zone].
3. Enter your time zone.
4. Press [OK].
5. Press .

Related Information

- [General Settings](#)

Adjust the LCD Backlight Brightness

If you are having difficulty reading the LCD, changing the brightness setting may help.



>> [DCP-J1050DW/MFC-J1010DW](#)

>> [DCP-J1140DW](#)

DCP-J1050DW/MFC-J1010DW

1. Press **Settings**.
2. Press **▲** or **▼** to make your selections:
 - a. Select [General Setup]. Press **OK**.
 - b. Select [LCD Settings]. Press **OK**.
 - c. Select [Backlight]. Press **OK**.
 - d. Select [Light], [Med], or [Dark]. Press **OK**.
3. Press **Stop/Exit**.

DCP-J1140DW

1. Press  [Settings] > [All Settings] > [General Setup] > [LCD Settings] > [Backlight].
2. Press the [Light], [Med], or [Dark] option.
3. Press .

Related Information

- [General Settings](#)

Change How Long the LCD Backlight Stays On

Set how long the LCD backlight stays on.



>> [DCP-J1050DW/MFC-J1010DW](#)

>> [DCP-J1140DW](#)

DCP-J1050DW/MFC-J1010DW

1. Press **Settings**.
2. Press **▲** or **▼** to make your selections:
 - a. Select [General Setup]. Press **OK**.
 - b. Select [LCD Settings]. Press **OK**.
 - c. Select [Dim Timer]. Press **OK**.
 - d. Select [10 Secs], [30 Secs], [1 Min], [2 Mins], [3 Mins], or [5 Mins]. Press **OK**.
3. Press **Stop/Exit**.

DCP-J1140DW

1. Press  [Settings] > [All Settings] > [General Setup] > [LCD Settings] > [Dim Timer].
2. Press **▲** or **▼** to display the [10 Secs], [30 Secs], [1 Min], [2 Mins], [3 Mins], or [5 Mins] option, and then press the option you want.
3. Press .

Related Information

- [General Settings](#)

Set Your Station ID

Related Models: MFC-J1010DW

Set the machine's Station ID if you want the date and time to appear on each fax you send.

1. Press **Settings**.
2. Press **▲** or **▼** to make your selections:
 - a. Select [Initial Setup]. Press **OK**.
 - b. Select [Station ID]. Press **OK**.
3. Press **▲** or **▼** to select [Fax], and then press **OK**.
4. Enter your fax number (up to 20 digits) using the dial pad, and then press **OK**.
5. Press **▲** or **▼** to select [Name], and then press **OK**.
6. Enter your name (up to 20 characters) using the dial pad, and then press **OK**.



For more information about how to enter text, see *Related Information*.

7. Press **Stop/Exit**.



Related Information

- [General Settings](#)

Related Topics:

- [Transfer Faxes to Another Fax Machine](#)
- [Transfer the Fax Journal Report to Another Fax Machine](#)
- [Enter Text on Your Brother Machine](#)
- [Set the Date and Time](#)

Set Tone or Pulse Dialling Mode

Related Models: MFC-J1010DW

Your machine is set for a Tone dialling service. If you have a Pulse dialling (rotary) service, you must change the dialling mode.

This feature is not available in some countries.

1. Press **Settings**.
2. Press ▲ or ▼ to make your selections:
 - a. Select [Initial Setup]. Press **OK**.
 - b. Select [Tone/Pulse]. Press **OK**.
 - c. Select [Tone] or [Pulse]. Press **OK**.
3. Press **Stop/Exit**.

Related Information

- [General Settings](#)

Related Topics:

- [Telephone and Fax Problems](#)

Reduce Printing Noise

The Quiet Mode setting can reduce printing noise. When Quiet Mode is turned on, the print speed becomes slower.

The factory setting is [Off].



- When the Quiet Mode setting is turned on,  appears on the Home screen.



>> [DCP-J1050DW/MFC-J1010DW](#)

>> [DCP-J1140DW](#)

DCP-J1050DW/MFC-J1010DW

1. Press **Settings**.
2. Press **▲** or **▼** to make your selections:
 - a. Select [General Setup]. Press **OK**.
 - b. Select [Quiet Mode]. Press **OK**.
 - c. Select [On] or [Off]. Press **OK**.
3. Press **Stop/Exit**.

DCP-J1140DW

1. Press  [Settings] > [All Settings] > [General Setup] > [Quiet Mode].
2. Press [On] or [Off].
3. Press .

Related Information

- [General Settings](#)

Related Topics:

- [Touchscreen LCD Overview](#)
- [Paper Handling and Printing Problems](#)

Change the Language Displayed on the LCD

Change the LCD language if needed.

This feature is not available in some countries.



>> [DCP-J1050DW/MFC-J1010DW](#)

>> [DCP-J1140DW](#)

DCP-J1050DW/MFC-J1010DW

1. Press **Settings**.
2. Press **▲** or **▼** to make your selections:
 - a. Select [Initial Setup]. Press **OK**.
 - b. Select [Local Language]. Press **OK**.
 - c. Select your language. Press **OK**.
3. Press **Stop/Exit**.

DCP-J1140DW

1. Press  [Settings] > [All Settings] > [Initial Setup] > [Local Language].
2. Press your language.
3. Press .



Related Information

- [General Settings](#)

Change the Keyboard Setting

Related Models: DCP-J1140DW

You can choose the type of keyboard for the LCD.

1. Press  [Settings] > [All Settings] > [General Setup] > [Keyboard Settings].
2. Press [QWERTY] or [ABC].
3. Press .

Related Information

- [General Settings](#)

Save Your Favourite Settings as a Shortcut

Related Models: DCP-J1140DW

- [Add Shortcuts](#)
- [Change or Delete Shortcuts](#)

Add Shortcuts

Related Models: DCP-J1140DW

You can add the Fax, Copy, Scan, Web Connect and Apps settings you use most frequently by saving them as your Shortcuts. Later you can press the Shortcut to apply these settings instead of manually re-entering them.



Some Shortcut menus are not available depending on your model.

These instructions describe how to add a Copy Shortcut. The steps for adding a Fax, Scan, Web Connect or Apps Shortcut are very similar.

1. If the Home screen 1 or screen 2 appears, press **+** [Shortcuts].
2. Press a tab from [1] to [3].
3. Press **+** where you have not added a Shortcut.
4. Press **▲** or **▼** to display [Copy].
5. Press [Copy].
6. Press  [Options].
7. Press **▲** or **▼** to display the available settings, and then press the setting you want to change.
8. Press **▲** or **▼** to display the available options for the setting, and then press the option you want.
Repeat the previous and this steps until you have selected all the settings for this Shortcut. When finished, press [OK].
9. Press [OK].
10. Read and confirm the displayed list of settings you have selected, and then press [OK].
11. Enter a name for the Shortcut using the LCD, and then press [OK].



When adding Fax or Scan to Shortcuts, you will be asked if you want to make this a One Touch Shortcut. Follow the LCD instructions.



Related Information

- [Save Your Favourite Settings as a Shortcut](#)

Change or Delete Shortcuts

Related Models: DCP-J1140DW

You can change the settings in a Shortcut.

You cannot change a Web Connect Shortcut or Apps Shortcut. If you need to change them, delete them, and then add a new Shortcut.

1. If the Home screen 1 or screen 2 appears, press **+** [Shortcuts].
2. Press a tab from [1] to [3] to display the Shortcut you want to change.
3. Press and hold the Shortcut you want to change.
4. Press [Edit].



To delete the Shortcut, press [Delete]. To edit the name of the Shortcut, press [Rename] and follow the LCD menus.

5. Press  [Options].
6. Press **▲** or **▼** to display the available settings, and then press the setting you want to change.
7. Change the settings for the Shortcut you selected. Press [OK].
8. Press [OK] when you have finished changing the settings.
9. Press [OK] to confirm.



When changing Fax or Scan Shortcuts, you will be asked if you want to make this a One Touch Shortcut. Follow the LCD instructions.



Related Information

- [Save Your Favourite Settings as a Shortcut](#)

Related Topics:

- [Enter Text on Your Brother Machine](#)

Print Reports

- [Reports](#)
- [Print a Report](#)
- [Fax Reports](#)
- [Telephone and Fax Problems](#)

Reports

The following reports are available:

Transmission Verify (For models with facsimile function)

The Transmission Verify prints a Transmission Verification Report for your last transmission.

Address Book (For models with facsimile function)

The Address Book report prints a list of names and numbers stored in the Address Book memory.

Fax Journal (For models with facsimile function)

The Fax Journal prints a list of information about your last 200 incoming and outgoing faxes. (TX means Transmit, RX means Receive.)

User Settings

The User Settings report prints a list of your current settings.

Network Configuration (network models)

The Network Configuration report prints a list of your current network settings.

WLAN Report (wireless models)

The WLAN Report prints the wireless LAN connectivity diagnosis.

Caller ID History (For models with facsimile function)

(MFC-J1010DW) The Caller ID History report prints a list of the available Caller ID information for the last 20 received faxes and telephone calls.



Related Information

- [Print Reports](#)



Print a Report

- >> [DCP-J1050DW/MFC-J1010DW](#)
- >> [DCP-J1140DW](#)

DCP-J1050DW/MFC-J1010DW

1. Press **Settings**.
2. Press **▲** or **▼** to make your selections:
 - a. Select [Print Reports]. Press **OK**.
 - b. Select the report you want to print. Press **OK**.
3. Press **▶**.
4. Press **Stop/Exit**.

DCP-J1140DW

1. Press  [Settings] > [All Settings] > [Print Reports].
2. Press **▲** or **▼** to display the report options, and then press the option you want.
3. Press [Yes].
4. Press .

Related Information

- [Print Reports](#)

Related Topics:

- [Caller ID](#)

Settings and Features Tables

- Settings Tables (1.8"(44.9 mm) Colour LCD)
- Features Tables (1.8"(44.9 mm) Colour LCD)
- Settings Tables (2.7"(67.5 mm) Touchscreen models)
- Features Tables (2.7"(67.5 mm) Touchscreen models)

Settings Tables (1.8"(44.9 mm) Colour LCD)

Related Models: DCP-J1050DW/MFC-J1010DW

These tables will help you understand your machine's menu selections and options.

Settings > [General Setup]

Level 3	Level 4	Level 5	Descriptions
Maintenance	Impr. PrintQuality	Impr. PrintQuality	Check and correct the print quality, alignment and paper feeding according to the LCD instructions.
		Alignment	
		Correct Paper Feed	
	Print Head Cleaning	Black only	Clean the print head according to the LCD instructions.
		Colour only	
		All	
	Ink Volume	-	Check the available ink volume.
	Ink Cartridge Model	-	Check your ink cartridge numbers.
Print Options	Reduce Smudging	Reduce smudging on the paper or paper jams during printing.	
	Enhance Print	Improve print quality and reduce blurriness.	
Ink Cartridge Check	-	View your ink cartridge information.	
Paper Type	-	-	Set the type of paper in the paper tray.
Paper Size	-	-	Set the size of paper in the paper tray.
Check Paper	-	-	Check the paper type and paper size when you pull the tray out of the machine.
Quiet Mode	-	-	Decrease printing noise.
Volume (MFC-J1010DW)	Ring	-	Adjust the ring volume.
	Beep (MFC-J1010DW)	-	Adjust the beeper volume.
	Speaker (MFC-J1010DW)	-	Adjust the speaker volume.
LCD Settings	Backlight	-	Adjust the brightness of the LCD backlight.
	Dim Timer	-	Set how long the LCD backlight stays on after you go back to your Home screen.
Sleep Time	-	-	Select how long the machine must be idle before it goes into Sleep Mode.
Auto Power Off	-	-	Select how long the machine must wait before it automatically turns itself off after entering Sleep Mode. When set to Off, the machine does not power off automatically.

Settings > [Ink]

Level 3	Level 4	Descriptions
Ink Volume	-	Check the available ink volume.
Remaining Pages	-	Check the approximate number of remaining pages that can be printed with the currently installed cartridges.
Ink Cartridge Model	-	Check your ink cartridge numbers.
Ink Cartridge Check	-	View your ink cartridge information.

Settings > [Fax] (For models with facsimile function)

Level 3	Level 4	Level 5	Descriptions	
Setup Receive	Ring Delay	-	Set the number of rings before the machine answers in Fax Only or Fax/Tel mode.	
	Receive Mode	-	Select the Receive Mode that best suits your needs.	
	F/T Ring Time	-	Set the length of the pseudo/double-ring time in Fax/Tel mode.	
	Fax Detect	-	Receive fax messages automatically when you answer a call and hear fax tones.	
	Remote Codes	Remote Codes	-	Answer calls at an extension or external telephone and use codes to turn the Remote Codes on or off. You can personalise the codes.
		Act.Code		
		Deact.Code		
	Auto Reduction	-	Reduce the size of incoming faxes.	
PC Fax Receive	-	Set the machine to send faxes to your computer. You can turn on the Backup Print safety feature.		
Fax Rx Stamp	-	Print the received time and date on the top of incoming faxes.		
Report Setting	XMIT Report	-	Select the initial setup for the Transmission Verification Report.	
	Journal Period	Journal Period	Set the interval for automatic printing of the Fax Journal. If you select an option other than Off and Every 50 Faxes, you can set the time for the option.	
		Time	If you select Every 7 Days, you can set the day of the week.	
	Day			
Print Document	-	-	Print incoming faxes stored in the machine's memory.	
Remaining Jobs	-	-	Check which scheduled jobs are in the machine's memory and cancel selected jobs.	
Miscellaneous	TX Lock	-	Prohibit most functions except receiving faxes.	
	BT Call Sign (U.K. only)	-	Use with BT Call Sign.	
	Caller ID (U.K. and Ireland only)	-	View or print a list of the last 20 Caller IDs stored in the memory.	

Settings > [Network]

Level 3	Level 4	Level 5	Descriptions
WLAN (Wi-Fi)	Find Wi-Fi Network	-	Configure your wireless network settings manually.

Level 3	Level 4	Level 5	Descriptions
WLAN (Wi-Fi)	TCP/IP	BOOT Method	Select the Boot method that best suits your needs.
		IP Address	Enter the IP address.
		Subnet Mask	Enter the Subnet mask.
		Gateway	Enter the Gateway address.
		Node Name	Enter the Node name.
		WINS Configuration	Select the WINS configuration mode.
		WINS Server	Specify the IP address of the primary or secondary WINS server.
		DNS Server	Specify the IP address of the primary or secondary DNS server.
		APIPA	Set the machine to allocate the IP address from the link-local address range automatically.
	IPv6	Turn the IPv6 protocol on or off.	
	WPS/Push Button	-	Configure your wireless network settings using the one-button push method.
	WPS/PIN Code	-	Configure your wireless network settings using WPS with a PIN.
	Recover WLAN	-	Reset and restart your wireless network.
	WLAN Status	Status	View the current wireless network status.
		Signal	View the current wireless network signal strength.
		SSID	View the current SSID.
		Comm. Mode	View the current Communication mode.
MAC Address	-	View the machine's MAC address.	
WLAN Enable	-	Turn the wireless network connection On or Off.	
Wi-Fi Direct	Manual	-	Configure your Wi-Fi Direct network settings manually.
	Group Owner	-	Set your machine as the Group Owner.
	Push Button	-	Configure your Wi-Fi Direct network settings using the one-button push method.
	PIN Code	-	Configure your Wi-Fi Direct network settings using WPS with a PIN code.
	Device Information	Device Name	View your machine's device name.
		SSID	View the Group Owner's SSID. When the machine is not connected, the LCD displays Not Connected.
		IP Address	View your machine's current IP Address.
	Status Information	Status	View the current Wi-Fi Direct network status.
		Signal	View the current Wi-Fi Direct network signal strength. When your machine acts as Group Owner, the LCD always indicates a strong signal.
	I/F Enable	-	Turn the Wi-Fi Direct connection on or off.

Level 3	Level 4	Level 5	Descriptions
Web Connect Settings	Proxy Settings	Proxy Connection	Change the Web connection settings.
		Address	
		Port	
		User Name	
		Password	
Network Reset	-	-	Restore all network settings back to the factory settings.

Settings > [Print Reports]

Level 3	Descriptions
XMIT Verify (MFC-J1010DW)	Print a Transmission Verification Report for your last transmission.
Address Book (MFC-J1010DW)	Print a list of names and numbers stored in the Address Book.
Fax Journal (MFC-J1010DW)	Print a list of information about your last 200 incoming and outgoing faxes. (TX means Transmit. RX means Receive.)
User Settings	Print a list of your settings.
Network Config	Print a list of your Network settings.
WLAN Report	Print the wireless LAN connection results.
Caller ID History (MFC-J1010DW)	Print a list of the available Caller ID information about the last 20 received faxes and telephone calls.

Settings > [Machine Info.]

Level 3	Descriptions
Serial No.	Check your machine's serial number.
Firmware Version	Check your machine's firmware version.
Firmware Update	Update your machine to the latest firmware.
Firmware Auto Check	View firmware information on the Home screen.
Page Counter	Check the total number of pages the machine has printed.

Settings > [Initial Setup]

Level 3	Level 4	Descriptions
Date & Time	Date	(MFC-J1010DW) Add the date and time on the screen and in the headings of the faxes you send.
	Time	
	Auto Daylight (MFC-J1010DW)	Set the machine to change automatically for Daylight Saving Time.
	Time Zone	Set your time zone.
Station ID (MFC-J1010DW)	Fax	Enter your name and fax number so it appears on each page you fax.
	Name	
Tone/Pulse (MFC-J1010DW)	-	Select the dialling mode.

Level 3	Level 4	Descriptions
(Available only for some countries.)		
Fax Auto Redial (MFC-J1010DW)	-	Set the machine to redial the last fax number if the fax did not go through because the line was busy.
Dial Tone (MFC-J1010DW)	-	Shorten the dial tone detect pause.
Phone Line Set (MFC-J1010DW)	-	Select the telephone line type.
Compatibility (MFC-J1010DW)	-	Adjust the equalisation for transmission difficulties. VoIP service providers offer fax support using various standards. If you regularly experience fax transmission errors, select Basic (for VoIP).
Reset	Machine Reset	Restore all the machine's settings that you have changed, such as Date and Time.
	Network	Restore all network settings back to the factory settings.
	Address Book & Fax (MFC-J1010DW)	Erase all stored phone numbers and fax settings.
	All Settings	Restore all the machine's settings back to the factory settings.
Local Language (Available only for some countries.)	-	Change your LCD language.



Related Information

- [Settings and Features Tables](#)

Features Tables (1.8"(44.9 mm) Colour LCD)

Related Models: DCP-J1050DW/MFC-J1010DW



FAX (For models with facsimile function)

Level 3	Level 4	Descriptions
Fax Resolution	-	Set the resolution for outgoing faxes.
Contrast	-	Adjust the contrast.
Glass Scan Size	-	Adjust the scan area of the scanner glass to the size of the document.
Broadcasting	-	Send the same fax message to more than one fax number.
Real Time TX	-	Send a fax without using the memory.
Overseas Mode	-	Set to On if you have difficulty sending faxes overseas.
Call History	Redial	Send a fax to the last number you called.
	Outgoing Call	Select a number from the Outgoing Call history and then send a fax to it, add it to the Address Book, or delete it.
	Caller ID History	Select a number from the Caller ID History and then send a fax to it, add it to the Address Book, or delete it.
Address Book	Search	Dial by pressing only a few buttons.
	Set Speed Dial	Store Speed Dial numbers, so you can dial by pressing only a few buttons.
	Setup Groups	Set up Group numbers for broadcasting.
	Change	Change Address Book numbers.
	Delete	Delete Address Book numbers.
Set New Default	-	Save your settings as the default.
Factory Reset	-	Restore all settings back to the factory settings.



SCAN

Level 3	Level 4	Descriptions
to PC	to File	Scan documents and save them to a folder on your computer.
	to OCR (MFC-J1010DW)	Convert your scanned document to an editable text file.
	to Image	Scan photos or graphics into your graphics applications.
	to E-mail	Send a scanned document as an email attachment.
to Web	-	Upload the scanned data to an Internet service.
WS Scan (Appears when you install a Web Services Scanner.)	Scan	Scan data using the Web Service protocol.
	Scan for E-mail	
	Scan for Fax	
	Scan for Print	



COPY

Level 3	Level 4	Descriptions
Quality	-	Select the Copy resolution for your document type.
Paper Type	-	Select the paper type that matches the paper in the tray.
Paper Size	-	Select the paper size that matches the paper in the tray.
Enlarge/Reduce	100%	-
	Enlarge	Select an enlargement ratio for the next copy.
	Reduce	Select a reduction ratio for the next copy.
	Fit to Page	Adjust the copy size to fit on the paper size you have set.
	Custom (25-400%)	Enter an enlargement or reduction ratio.
Density	-	Adjust the density.
Remove Background	Black Copy Settings	Change the amount of background colour that is removed.
	Colour Copy Settings	
2-sided Copy	-	Turn off or turn on 2-sided copying and select flip on long edge or flip on short edge.
Stack/Sort	-	Select to stack or sort multiple copies.
Page Layout	-	Make N in 1, 2 in 1 ID, or Poster copies.
Auto Deskew	-	Correct a skewed copy.
Set New Default	-	Save your settings as the default.
Factory Reset	-	Restore all settings back to the factory settings.



WEB

Level 1	Level 2	Level 3	Descriptions
Web	-	-	Connect the Brother machine to an Internet service.



(Ink) / INK

Level 2	Level 3	Descriptions
Ink Volume	-	Check the available ink volume.
Ink Cartridge Model	-	Check your ink cartridge numbers.
Impr. PrintQuality	Impr. PrintQuality	Check and correct the print quality, alignment and paper feeding according to the LCD instructions.
	Alignment	
	Correct Paper Feed	
Print Head Cleaning	Black only	Clean the print head according to the LCD instructions.
	Colour only	
	All	
Print Options	Reduce Smudging	Reduce smudging on the paper or paper jams during printing.
	Enhance Print	Improve print quality and reduce blurriness.
Ink Cartridge Check	-	View your ink cartridge information.

► (Address Book) (For models with facsimile function)

Level 2	Descriptions
Search	Dial by pressing only a few buttons.
Set Speed Dial	Store Speed Dial numbers, so you can dial by pressing only a few buttons.
Setup Groups	Set up Group numbers for broadcasting.
Change	Change Address Book numbers.
Delete	Delete Address Book numbers.

Redial/Pause (For models with facsimile function)

Level 2	Descriptions
Redial	Send a fax to the last number you called.
Outgoing Call	Select a number from the Outgoing Call history and then send a fax to it, add it to the Address Book, or delete it.
Caller ID History	Select a number from the Caller ID History and then send a fax to it, add it to the Address Book, or delete it.



WiFi



You can configure the wireless settings by pressing  or **WiFi** on the control panel.

Level 2	Descriptions
Find Wi-Fi Network	Configure your wireless network settings manually.
WPS/Push Button	Configure your wireless network settings using the one-button push method.
Recover WLAN	Reset and restart your wireless network.



Related Information

- [Settings and Features Tables](#)

Settings Tables (2.7"(67.5 mm) Touchscreen models)

Related Models: DCP-J1140DW

These tables will help you understand your machine's menu selections and options.

>> [Settings]
 >> [General Setup]
 >> [Shortcut Settings]
 >> [Network]
 >> [Print Reports]
 >> [Machine Info.]
 >> [Initial Setup]

[Settings]



[Settings]

Level 1	Level 2	Level 3	Descriptions
 (Date & Time)	-	-	Set the date and time on your machine.
Maintenance	-	-	Access the Maintenance settings menus.
Network	WLAN (Wi-Fi)	-	Access the WLAN setting menus.
	Wi-Fi Direct	-	Access the Wi-Fi Direct setting menus.
Tray Setting	-	-	Access the tray setting menus.
Wi-Fi Direct	-	-	Access the Wi-Fi Direct setting menus.
Quiet Mode	-	-	Decrease printing noise.
All Settings	-	-	Configure the detailed settings.

[General Setup]



[All Settings] > [General Setup]

Level 3	Level 4	Level 5	Descriptions
Maintenance	Improve Print Quality	Check Print Quality	Check and correct the print quality, alignment and paper feeding according to the LCD instructions.
		Alignment	
		Correct Paper Feed	
	Print Head Cleaning	Black only	Clean the print head according to the LCD instructions.
		Colour only	
		All	
Ink Volume	-	Check the available ink volume.	
Ink Cartridge Model	-	Check your ink cartridge numbers.	
Print Options	Reduce Smudging	Reduce smudging on the paper or paper jams during printing.	

Level 3	Level 4	Level 5	Descriptions
Maintenance	Print Options	Enhance Print	Improve print quality and reduce blurriness.
	Ink Cartridge Check	-	View your ink cartridge information.
Paper Type	-	-	Set the type of paper in the paper tray.
Paper Size	-	-	Set the size of paper in the paper tray.
Check Paper	-	-	Check the paper type and paper size when you pull the tray out of the machine.
Quiet Mode	-	-	Decrease printing noise.
Beep	-	-	Adjust the beeper volume.
LCD Settings	Backlight	-	Adjust the brightness of the LCD backlight.
	Dim Timer	-	Set how long the LCD backlight stays on after the last finger press.
Screen Settings	Home Screen	-	Set the screen that is displayed when you press  .
	Scan Screen	-	Set the default Scan screen settings.
Keyboard Settings	-	-	Select the type of keyboard for the LCD.
Sleep Time	-	-	Select how long the machine must be idle before it goes into Sleep Mode.
Auto Power Off	-	-	Select how long the machine must wait before it automatically turns itself off after entering Sleep Mode. When set to Off, the machine does not power off automatically.

[Shortcut Settings]



[All Settings] > [Shortcut Settings]

Level 3	Level 4	Descriptions
(Select a shortcut button.)	Rename	Change the shortcut name.
	Edit	Change the shortcut settings.
	Delete	Delete the shortcut.

[Network]



[All Settings] > [Network]

Level 3	Level 4	Level 5	Level 6	Descriptions
WLAN (Wi-Fi)	Find Wi-Fi Network	-	-	Configure your wireless network settings manually.
	TCP/IP	BOOT Method	-	Select the Boot method that best suits your needs.
		IP Address	-	Enter the IP address.
		Subnet Mask	-	Enter the Subnet mask.
		Gateway	-	Enter the Gateway address.
		Node Name	-	Enter the Node name.

Level 3	Level 4	Level 5	Level 6	Descriptions
WLAN (Wi-Fi)	TCP/IP	WINS Configuration	-	Select the WINS configuration mode.
		WINS Server	-	Specify the IP address of the primary or secondary WINS server.
		DNS Server	-	Specify the IP address of the primary or secondary DNS server.
		APIPA	-	Set the machine to allocate the IP address from the link-local address range automatically.
		IPv6	-	Turn the IPv6 protocol on or off.
	WPS/Push Button	-	-	Configure your wireless network settings using the one-button push method.
	WPS/PIN Code	-	-	Configure your wireless network settings using WPS with a PIN.
	Recover WLAN	-	-	Reset and restart your wireless network.
	WLAN Status	Status	-	View the current wireless network status.
		Signal	-	View the current wireless network signal strength.
		SSID	-	View the current SSID.
		Comm. Mode	-	View the current Communication mode.
	MAC Address	-	-	View the machine's MAC address.
WLAN Enable	-	-	Turn the wireless network connection On or Off.	
Wi-Fi Direct	Manual	-	-	Configure your Wi-Fi Direct network settings manually.
	Group Owner	-	-	Set your machine as the Group Owner.
	Push Button	-	-	Configure your Wi-Fi Direct network settings using the one-button push method.
	PIN Code	-	-	Configure your Wi-Fi Direct network settings using WPS with a PIN code.
	Device Information	Device Name	-	View your machine's device name.
		SSID	-	View the Group Owner's SSID. When the machine is not connected, the LCD displays Not Connected.
		IP Address	-	View your machine's current IP Address.
	Status Information	Status	-	View the current Wi-Fi Direct network status.
		Signal	-	View the current Wi-Fi Direct network signal strength. When your machine acts as Group Owner, the LCD always indicates a strong signal.
	I/F Enable	-	-	Turn the Wi-Fi Direct connection on or off.
Message from Brother	Message from Brother	-	-	Display messages and notifications from Brother.
	Status	-	-	

Level 3	Level 4	Level 5	Level 6	Descriptions
Web Connect Settings	Proxy Settings	Proxy Connection	-	Change the Web connection settings.
		Address	-	
		Port	-	
		User Name	-	
		Password	-	
Network Reset	-	-	-	Restore all network settings back to the factory settings.

[Print Reports]



[All Settings] > [Print Reports]

Level 3	Descriptions
User Settings	Print a list of your settings.
Network Configuration	Print a list of your Network settings.
WLAN Report	Print the wireless LAN connection results.

[Machine Info.]



[All Settings] > [Machine Info.]

Level 3	Level 4	Descriptions
Serial No.	-	Check your machine's serial number.
Firmware Version	Main Version	Check your machine's firmware version.
Firmware Update	-	Update your machine to the latest firmware.
Firmware Auto Check	-	View firmware information on the Home screen.
Page Counter	-	Check the total number of pages the machine has printed.

[Initial Setup]



[All Settings] > [Initial Setup]

Level 3	Level 4	Descriptions
Date & Time	Date	Set the date and time on your machine.
	Time	
	Time Zone	Set your time zone.
Reset	Machine Reset	Restore all the machine's settings that you have changed, such as Date and Time.
	Network	Restore all network settings back to the factory settings.
	All Settings	Restore all the machine's settings back to the factory settings.
Local Language (Available only for some countries.)	-	Change your LCD language.











Related Information

- [Settings and Features Tables](#)

Features Tables (2.7"(67.5 mm) Touchscreen models)

Related Models: DCP-J1140DW

- >>  [Copy]
- >>  [Scan]
- >>  [Web]
- >>  [Apps]
- >>  [Download Software]
- >>  [Print Head Cleaning]
- >>  [Shortcuts]
- >>  [Ink]
- >>  Wi-Fi Setup





[Copy]

Level 3	Level 4	Level 5	Descriptions	
Save as Shortcut	-	-	Save the current settings as a shortcut.	
 (Options)	Quality	-	Select the Copy resolution for your document type.	
	Paper Type	-	Select the paper type that matches the paper in the tray.	
	Paper Size	-	Select the paper size that matches the paper in the tray.	
	Enlarge/Reduce	100%	-	
		Enlarge		Select an enlargement ratio for the next copy.
		Reduce		Select a reduction ratio for the next copy.
		Fit to Page		Adjust the copy size to fit on the paper size you have set.
	Custom (25-400%)		Enter an enlargement or reduction ratio.	
	Density	-		Adjust the density.
	Remove Background Colour	Black Copy Settings		Change the amount of background colour that is removed.
		Colour Copy Settings		
	2-sided Copy	-		Turn off or turn on 2-sided copying and select flip on long edge or flip on short edge.
	Stack/Sort	-		Select to stack or sort multiple copies.
Page Layout	-		Make N in 1, 2 in 1 ID, or Poster copies.	
Auto Deskew	-		Correct a skewed copy.	
Advanced Settings	-		Select advanced copy settings.	

Level 3	Level 4	Level 5	Descriptions
 (Options)	Set New Default	-	Save your settings as the default.
	Factory Reset	-	Restore all settings back to the factory settings.



[Scan]

Level 3	Level 4	Level 5	Level 6	Descriptions
to PC	to File	(Select USB or PC)	 (Options)	Scan documents and save them to a folder on your computer.
			Save as Shortcut	
	to OCR	(Select USB or PC)	 (Options)	Convert your scanned document to an editable text file.
			Save as Shortcut	
to Image	(Select USB or PC)	 (Options)	Scan photos or graphics into your graphics applications.	
		Save as Shortcut		
to E-mail	(Select USB or PC)	 (Options)	Send a scanned document as an email attachment.	
		Save as Shortcut		
to Web	-	-	-	Upload the scanned data to an Internet service.
WS Scan (Appears when you install a Web Services Scanner, which is displayed in your computer's Network explorer.)	Other Scan to Actions	-	-	Scan data using the Web Service protocol.
	Scan	-	-	
	Scan for E-mail	-	-	
	Scan for Fax	-	-	
	Scan for Print	-	-	



[Web]

Level 1	Descriptions
Web	Connect the Brother machine to an Internet service.



[Apps]

Level 1	Descriptions
Apps	Connect the Brother machine to the Brother Apps service.



[Download Software]

Level 1	Descriptions
Download Software	Displays information about downloading and installing software for mobile devices and computers.



[Print Head Cleaning]

Level 1	Descriptions
Print Head Cleaning	Clean the print head according to the LCD instructions.



[Shortcuts]

Level 2	Level 3	Level 4	Descriptions
+ (Add Shortcut)	Copy	-	Change the settings in the Copy Options.
	Scan	to PC (File)	Scan documents and save them to a folder on your computer.
		to PC (OCR)	Convert your scanned document to an editable text file.
		to PC (Image)	Scan photos or graphics into your graphics applications.
		to PC (E-mail)	Send a scanned document as an email attachment.
	Web	-	Connect the Brother machine to an Internet service.
	Apps	-	Connect the Brother machine to the Brother Apps service.
This list appears when each Shortcut icon is pressed for 2 seconds.	Rename	-	Change the shortcut name.
	Edit	-	Change the shortcut settings.
	Delete	-	Delete the shortcut.
 (Edit/Delete)	(Select a shortcut button.)	Rename	Change the shortcut name.
		Edit	Change the shortcut settings.
		Delete	Delete the shortcut.



[Ink]

Level 2	Level 3	Descriptions
Ink Volume	-	Check the available ink volume.
Ink Cartridge Model	-	Check your ink cartridge numbers.
Improve Print Quality	Check Print Quality	Check and correct the print quality, alignment and paper feeding according to the LCD instructions.
	Alignment	
	Correct Paper Feed	
Print Head Cleaning	Black only	Clean the print head according to the LCD instructions.
	Colour only	
	All	

Level 2	Level 3	Descriptions
Print Options	Reduce Smudging	Reduce smudging on the paper or paper jams during printing.
	Enhance Print	Improve print quality and reduce blurriness.
Ink Cartridge Check	-	View your ink cartridge information.



Wi-Fi Setup

Level 2	Descriptions
Find Wi-Fi Network	Configure your wireless network settings manually.
WPS/Push Button	Configure your wireless network settings using the one-button push method.
Recover WLAN	Reset and restart your wireless network.



Related Information

- [Settings and Features Tables](#)

Change Machine Settings Using Web Based Management

Web Based Management is a utility that uses a standard web browser to manage your machine using the Hyper Text Transfer Protocol (HTTP) or Hyper Text Transfer Protocol over Secure Socket Layer (HTTPS).

- [What is Web Based Management?](#)
- [Access Web Based Management](#)
- [Set or Change a Login Password for Web Based Management](#)
- [Set Up Your Machine's Address Book Using Web Based Management](#)

What is Web Based Management?

Web Based Management is a utility that uses a standard web browser to manage your machine using the Hyper Text Transfer Protocol (HTTP) or Hyper Text Transfer Protocol over Secure Socket Layer (HTTPS).



- We recommend Microsoft Internet Explorer 11/Microsoft Edge for Windows, Safari 10/11 for Mac, Google Chrome™ for Android (4.x or later), and Google Chrome™/Safari for iOS (10.x or later). Make sure that JavaScript and Cookies are always enabled in whichever browser you use.
- You must use the TCP/IP protocol on your network and have a valid IP address programmed into the print server and your computer.

XXX-XXXX brother

Status

Device Status

Ready

Automatic Refresh

Off
 On

Estimated Ink Level

M C Y BK

Remaining Page Yield

Approximate Page Yield (ISO-based)

XXX XXX XXX XXX
M C Y BK

*The remaining page yields are approximated and may vary depending on the type of pages printed.

Web Language

Auto

Device Location

Contact :
Location :

- The actual screen may differ from the screen shown above.



Related Information

- [Change Machine Settings Using Web Based Management](#)

Access Web Based Management

- We recommend Microsoft Internet Explorer 11/Microsoft Edge for Windows, Safari 10/11 for Mac, Google Chrome™ for Android (4.x or later), and Google Chrome™/Safari for iOS (10.x or later). Make sure that JavaScript and Cookies are always enabled in whichever browser you use.
- The default password to manage this machine's settings is located on the back of the machine and marked "Pwd". We recommend immediately changing the default password to protect your machine from unauthorised access. You can also find the default password in the Network Configuration Report.
- If the password is entered incorrectly several times, you will not be able to log in for a while. The lockout settings can be changed in Web Based Management.
- Up to eight computers or mobile devices can be logged in to Web Based Management at the same time. If you log in a ninth device, the first device will be logged out.
- We recommend using the HTTPS security protocol when configuring settings using Web Based Management. If you use HTTP when configuring settings using Web Based Management, follow the screen prompts to switch to a secure HTTPS connection.
- When you use HTTPS for Web Based Management configuration, your browser will display a warning dialog box. To avoid displaying the warning dialog box, you can install a self-signed certificate to use SSL/TLS communication. For more detailed information, see *Related Information*.

>> [Start from Your Web Browser](#)

>> [Start from Brother iPrint&Scan \(Windows/Mac\)](#)

>> [Start from Brother Utilities \(Windows\)](#)

>> [Start from Brother Mobile Connect](#)

Start from Your Web Browser

1. Start your web browser.
2. Type "https://machine's IP address" in your browser's address bar (where "machine's IP address" is the machine's IP address).

For example:

https://192.168.1.2



- If you are using a Domain Name System or enable a NetBIOS name, you can type another name, such as "SharedPrinter" instead of the IP address.

- For example:

https://SharedPrinter

If you enable a NetBIOS name, you can also use the node name.

- For example:

https://brnxxxxxxxxxxxx

The NetBIOS name can be found in the Network Configuration Report.

3. If required, type the password in the **Login** field, and then click **Login**.
4. If you want to pin the navigation menu on the left side of the screen, click ☰ and then click .



You can now change the machine settings.

Start from Brother iPrint&Scan (Windows/Mac)

1. Start Brother iPrint&Scan.
 - Windows
Launch  (Brother iPrint&Scan).
 - Mac



In the **Finder** menu bar, click **Go > Applications**, and then double-click the iPrint&Scan icon.

The Brother iPrint&Scan screen appears.

2. If your Brother machine is not selected, click the **Select your Machine** button, and then select your model name from the list. Click **OK**.
3. Click  (**Machine Settings**).
4. Click **All Settings**.
Web Based Management appears.
5. If required, type the password in the **Login** field, and then click **Login**.
6. If you want to pin the navigation menu on the left side of the screen, click  and then click .

You can now change the machine settings.



Start from Brother Utilities (Windows)

1. Launch  (**Brother Utilities**), and then click the drop-down list and select your model name (if not already selected).
2. Click **Tools** in the left navigation bar, and then click **Machine Settings**.
Web Based Management appears.
3. If required, type the password in the **Login** field, and then click **Login**.
4. If you want to pin the navigation menu on the left side of the screen, click  and then click .

You can now change the machine settings.

Start from Brother Mobile Connect

You need to install and set up Brother Mobile Connect on your mobile device.

1. Start Brother Mobile Connect on your mobile device.
2. Tap your model name on the top of the screen.
3. Tap **All Machine Settings**.
Web Based Management appears.
4. If required, type the password in the **Login** field, and then tap **Login**.
5. If you want to pin the navigation menu on the left side of the screen, tap  and then tap .

You can now change the machine settings.

If you change the protocol settings, you must restart the machine after clicking **Submit** to activate the configuration.

After configuring the settings, click **Logout**.

Related Information

- [Change Machine Settings Using Web Based Management](#)

Related Topics:

- [Print the Network Configuration Report](#)
- [Create a Self-signed Certificate](#)
- [Install the Self-signed Certificate for Windows users with Administrator Rights](#)

Set or Change a Login Password for Web Based Management

The default password to manage this machine's settings is located on the back of the machine and marked "Pwd". We recommend immediately changing the default password to protect your machine from unauthorised access.

1. Start your web browser.
2. Type "https://machine's IP address" in your browser's address bar (where "machine's IP address" is the machine's IP address).

For example:

https://192.168.1.2



- If you are using a Domain Name System or enable a NetBIOS name, you can type another name, such as "SharedPrinter" instead of the IP address.

- For example:

https://SharedPrinter

If you enable a NetBIOS name, you can also use the node name.

- For example:

https://brnxxxxxxxxxxxx

The NetBIOS name can be found in the Network Configuration Report.

3. Do one of the following:
 - If you have previously set your own password, type it, and then click **Login**.
 - If you have not previously set your own password, type the default login password, and then click **Login**.
4. Go to the navigation menu, and then click **Administrator > Login Password**.



Start from , if the navigation menu is not shown on the left side of the screen.

5. Following the on-screen **Login Password** guidelines, type your password in the **Enter New Password** field.
6. Retype the password in the **Confirm New Password** field.
7. Click **Submit**.



You can also change the lockout settings in the **Login Password** menu.



Related Information

- [Change Machine Settings Using Web Based Management](#)

Related Topics:

- [Access Web Based Management](#)

Set Up Your Machine's Address Book Using Web Based Management

Related Models: MFC-J1010DW

- We recommend using the HTTPS security protocol when configuring settings using Web Based Management.
- When you use HTTPS for Web Based Management configuration, your browser will display a warning dialog box.

1. Start your web browser.
2. Type "https://machine's IP address" in your browser's address bar (where "machine's IP address" is the machine's IP address).

For example:

https://192.168.1.2



- If you are using a Domain Name System or enable a NetBIOS name, you can type another name, such as "SharedPrinter" instead of the IP address.

- For example:

https://SharedPrinter

If you enable a NetBIOS name, you can also use the node name.

- For example:

https://brnxxxxxxxxxxxx

The NetBIOS name can be found in the Network Configuration Report.

3. If required, type the password in the **Login** field, and then click **Login**.



The default password to manage this machine's settings is located on the back of the machine and marked "Pwd".

4. Go to the navigation menu, and then click **Address Book > Address XX-XX**.



Start from ☰, if the navigation menu is not shown on the left side of the screen.

5. Add or update the Address Book information as needed.
6. Click **Submit**.



Related Information

- [Change Machine Settings Using Web Based Management](#)

Related Topics:

- [Access Web Based Management](#)

Appendix

- [Specifications](#)
- [Supply Specifications](#)
- [Information Regarding Recycled Paper](#)
- [Brother Help and Customer Support](#)

Specifications

- >> General Specifications
- >> Document Size Specifications
- >> Print Media Specifications
- >> Fax Specifications
- >> Copy Specifications
- >> Scanner Specifications
- >> Printer Specifications
- >> Interface Specifications
- >> Network Specifications
- >> Computer Requirements Specifications

General Specifications

Printer Type	Inkjet	
Print Head	Mono	Piezo with 210 nozzles x 1
	Colour	Piezo with 70 nozzles x 3 (DCP-J1050DW/MFC-J1010DW) Piezo with 210 nozzles x 3 (DCP-J1140DW)
Memory Capacity	128 MB	
Liquid Crystal Display (LCD)	<ul style="list-style-type: none"> • DCP-J1050DW/MFC-J1010DW ¹ 1.8 in. (44.9 mm) TFT Colour LCD • DCP-J1140DW ¹ 2.7 in. (67.5 mm) TFT Colour Touchscreen LCD 	
Power Source	AC 220 to 240 V 50/60 Hz	
Power Consumption ²	<ul style="list-style-type: none"> • DCP-J1050DW Copying ³: Approx. 13 W Ready ⁵: Approx. 3 W Sleep ⁵: Approx. 0.7 W Power Off ^{5 6}: Approx. 0.2 W • MFC-J1010DW Copying ⁴: Approx. 17 W Ready ⁵: Approx. 3 W Sleep ⁵: Approx. 1 W Power Off ^{5 6}: Approx. 0.2 W • DCP-J1140DW Copying ³: Approx. 14 W Ready ⁵: Approx. 3 W Sleep ⁵: Approx. 0.8 W Power Off ^{5 6}: Approx. 0.2 W 	

Dimensions

- DCP-J1050DW

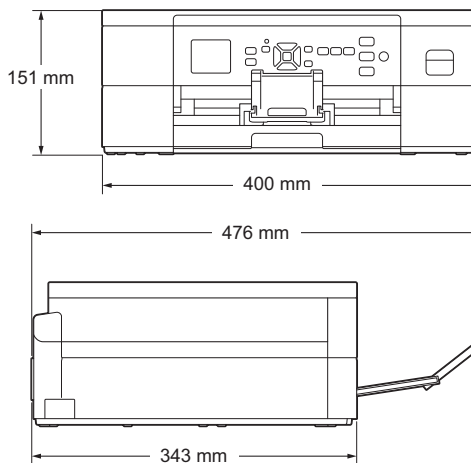

- MFC-J1010DW

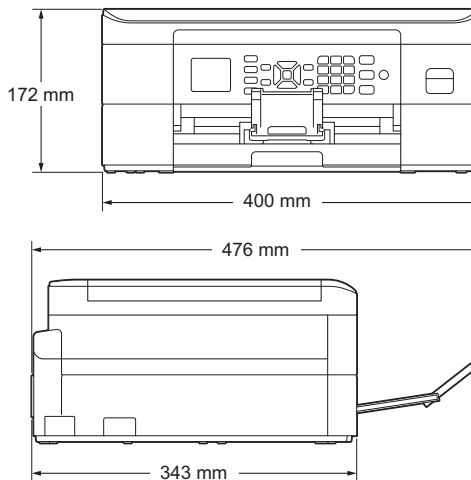

- DCP-J1140DW

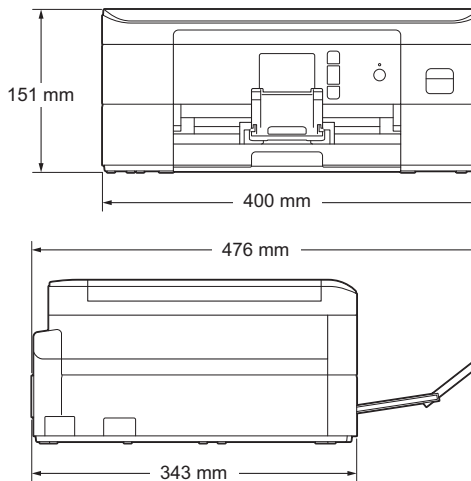

Weights

- DCP-J1050DW
6.9 kg
- MFC-J1010DW
8.1 kg
- DCP-J1140DW
6.9 kg

Noise Level

Sound Pressure

Printing

- DCP-J1050DW/MFC-J1010DW
53.5 dB (A) (Approx.)⁷
- DCP-J1140DW

Noise Level			53.0 dB (A) (Approx.) ⁷
	Sound Power ⁸	Printing ⁹	<ul style="list-style-type: none"> • DCP-J1050DW LWAd =6.64 B(A) (Mono) • MFC-J1010DW LWAd =6.64 B(A) (Mono) • DCP-J1140DW LWAd =6.64 B(A) (Mono)
			<ul style="list-style-type: none"> • DCP-J1050DW LWAd =6.25 B(A) (Colour) • MFC-J1010DW LWAd =6.25 B(A) (Colour) • DCP-J1140DW LWAd =6.60 B(A) (Colour)
Temperature	Operating		10 to 35°C
	Best Print Quality		20 to 33°C
Humidity	Operating		20 to 80% (without condensation)
	Best Print Quality		20 to 80% (without condensation)
Automatic Document Feeder (ADF) (MFC-J1010DW)			Up to 20 pages Paper: 80 g/m ²

1 Measured diagonally

2 Measured when the machine is connected to the USB interface. Power consumption varies slightly depending on the usage environment or part wear.

3 When single-sided printing, resolution: standard / document: ISO/IEC 24712 printed pattern.

4 When using ADF, single-sided printing, resolution: standard / document: ISO/IEC 24712 printed pattern.

5 Measured according to IEC 62301 Edition 2.0.

6 Even when the machine is turned off, it will automatically turn itself on periodically for print head maintenance, and then turn itself off.

7 Noise depends on printing conditions.

8 Measured in accordance with the method described in DE-UZ 205.

9 <Print speed>

DCP-J1050DW: 17.0 ipm (Mono) / 9.5 ipm (Colour)

MFC-J1010DW: 17.0 ipm (Mono) / 9.5 ipm (Colour)

DCP-J1140DW: 17.0 ipm (Mono) / 16.5 ipm (Colour)

These print speeds were measured in accordance with ISO/IEC 24734.

Document Size Specifications

Document Size	ADF Width (MFC-J1010DW)	148 to 215.9 mm
	ADF Length ¹ (MFC-J1010DW)	148 to 355.6 mm
	Scanner Glass Width	Max. 215.9 mm
	Scanner Glass Length	Max. 297 mm

1 Documents that are longer than 297 mm must be fed one page at a time.

Print Media Specifications

Paper Input	Paper Tray	Paper Type ¹	Plain Paper, Inkjet Paper (coated paper), Glossy Paper, Recycled Paper
--------------------	-------------------	--------------------------------	--

Paper Input	Paper Tray	Paper Size	Letter, A4, Executive, A5, A6, Envelopes (C5, Com-10, DL, Monarch), Photo (10 x 15 cm), Photo 2L (13 x 18 cm), Index card (13 x 20 cm)]
		Maximum Paper Capacity	Up to 150 sheets of 80 g/m ² plain paper
Paper Output ¹			Up to 50 sheets of 80 g/m ² Plain Paper (face up print delivery to the output paper tray)

¹ For glossy paper, remove any printed pages from the output paper tray immediately to avoid smudging.

Fax Specifications



This feature is available for MFC models.

Compatibility	ITU-T Group 3
Modem Speed	Automatic Fallback: 14,400 bps
Scanning Width (Single-sided document)	ADF: 208 mm (A4) Scanner Glass: 204 mm (A4)
Printing Width	204 mm (A4)
Greyscale	Monochrome: 8 bit (256 levels) Colour: 24 bit (8 bit per colour/256 levels)
Resolution (Horizontal)	203 dpi
Resolution (Vertical)	Standard: 98 dpi (Mono) 196 dpi (Colour)
	Fine: 196 dpi (Mono) 196 dpi (Colour)
	Superfine: 392 dpi (Mono)
	Photo: 196 dpi (Mono)
Address Book	40 numbers
Groups	Up to 6
Broadcasting	90 (40 Address Book/50 Manual Dial)
Automatic Redial	3 times at 5 minute intervals
Memory Transmission	Up to 170 pages ¹
Out of Paper Reception	Up to 170 pages ¹

¹ 'Pages' refers to the 'ITU-T Test Chart #1' (a typical business letter, Standard resolution, MMR code).

Copy Specifications

Colour/Monochrome	Yes/Yes
Copy Width	204 mm ¹
Multiple Copies	Stacks/Sorts up to 99 pages
Enlarge/Reduce	25% to 400% (in increments of 1%)

Resolution	Prints up to 1200 × 1800 dpi (DCP-J1050DW/MFC-J1010DW) Prints up to 1200 × 2400 dpi (DCP-J1140DW)
-------------------	--

¹ When copying on A4 size paper.

Scanner Specifications

Colour/Monochrome	Yes/Yes
TWAIN Compliant	Yes (Windows 7 SP1 / Windows 8.1 / Windows 10)
WIA Compliant	Yes (Windows 7 SP1 / Windows 8.1 / Windows 10)
Colour Depth	30 bit colour processing (Input) 24 bit colour processing (Output)
Greyscale	10 bit colour processing (Input) 8 bit colour processing (Output)
Resolution	Up to 19200 × 19200 dpi (interpolated) ^{1 2} (from Scanner Glass) Up to 1200 × 2400 dpi (optical) (from ADF) ³ Up to 1200 × 600 dpi (optical)
Scanning Width and Length (Single-sided document)	(Scanner Glass) Width: Up to 213.9 mm Length: Up to 295 mm (ADF) ³ Width: Up to 213.9 mm Length: Up to 353.6 mm

¹ Maximum 1200 × 1200 dpi scanning with the WIA driver in Windows 7 SP1, Windows 8.1 and Windows 10 (resolution up to 19200 × 19200 dpi can be selected using the scanner utility).

² The scanning range may decrease as the scanning resolution increases.

³ ADF models only

Printer Specifications

Resolution	<ul style="list-style-type: none"> (DCP-J1050DW/MFC-J1010DW) Up to 1200 × 6000 dpi (Windows only) (DCP-J1140DW) Up to 1200 × 6000 dpi
Printing Width ¹	204 mm Borderless ² : 210 mm
Borderless	A4, Letter, A6, Photo (10 x 15 cm), Photo 2L (13 x 18 cm), Index card (13 x 20 cm)
Automatic 2-sided	Paper Type Plain Paper, Recycled Paper
	Paper Size A4, Letter, Executive, A5
Print Speed	See your model's page on your local Brother website.

¹ When printing on A4 size paper.

² When the Borderless feature is set to On.

Interface Specifications

USB ^{1 2}	Use a USB 2.0 interface cable that is no longer than 2 m.
Wireless LAN	IEEE 802.11b/g/n (Infrastructure) IEEE 802.11g/n (Wi-Fi Direct)

¹ Your machine has a USB 2.0 Hi-Speed interface. The machine can also be connected to a computer that has a USB 1.1 interface.

² Third party USB ports are not supported.

Network Specifications



- (DCP-J1050DW/DCP-J1140DW)
You can connect your machine to a network for Network Printing and Network Scanning.
- (MFC-J1010DW)
You can connect your machine to a network for Network Printing, Network Scanning, PC-Fax Send, and PC-Fax Receive (Windows only).

Network Security (Wireless)		SSL/TLS (IPPS, HTTPS), 802.1x (EAP-FAST, PEAP, EAP-TLS, EAP-TTLS)
Wireless Network Security		SSID (32 characters), WEP 64/128 bit, WPA-PSK (TKIP/AES), WPA2-PSK (TKIP/AES)
Wireless Setup Support Utility	WPS	Yes

Computer Requirements Specifications

Supported Operating Systems And Software Functions

Computer Platform & Operating System Version		PC Interface		Processor	Hard Disk Space to Install	
		USB ¹	Wireless 802.11b/g/n		For Drivers	For Applications (Including Drivers)
Windows Operating System	Windows 7 SP1 ^{2 3} Windows 8.1 ^{2 3}	Printing Scanning		32 bit (x86) or 64 bit (x64) processor	650 MB	1.3 GB
	Windows 10 Home ^{2 3} Windows 10 Pro ^{2 3} Windows 10 Education ^{2 3} Windows 10 Enterprise ^{2 3}					
	Windows Server 2008	N/A	Printing	64 bit (x64) processor	50 MB	N/A
	Windows Server 2008 R2					
	Windows Server 2012					
	Windows Server 2012 R2					
	Windows Server 2016					

	Windows Server 2019				
Mac Operating System	macOS v10.14.6 macOS v10.15.x macOS v11	Printing Scanning	64 bit (x64) processor	N/A	550 MB

¹ Third party USB ports are not supported.

² For WIA, 1200 x 1200 resolution. Brother Scanner Utility enables enhancing up to 19200 x 19200 dpi.

³ Nuance™ PaperPort™ 14SE supports Windows 7 SP1, Windows 8.1, Windows 10 Home, Windows 10 Pro, Windows 10 Education and Windows 10 Enterprise.

For the latest driver updates, go to your model's **Downloads** page at support.brother.com.

All trademarks, brand and product names are the property of their respective companies.



Related Information

- [Appendix](#)

Supply Specifications

Ink	The machine uses individual Black, Yellow, Cyan and Magenta ink cartridges that are separate from the print head assembly.
Service Life of Ink Cartridge	The first time you install a set of ink cartridges the machine will use an amount of ink to fill the ink delivery tubes for high quality printouts. This process will only happen once. After this process is complete the page yield for the cartridges provided with your machine is approximately the same as that of standard cartridges.
Replacement Supplies	<Black> LC421XLBK <Yellow> LC421XLY <Cyan> LC421XLC <Magenta> LC421XLM Black, Yellow, Cyan and Magenta - Approximately 500 pages ¹
	<Black> LC421BK <Yellow> LC421Y <Cyan> LC421C <Magenta> LC421M Black, Yellow, Cyan and Magenta - Approximately 200 pages ¹
What is Innobella? 	Innobella is a range of genuine supplies offered by Brother. The name "Innobella" derives from the words "Innovation" and "Bella" (meaning "Beautiful" in Italian) and is a representation of the "innovative" technology providing you with "beautiful" and "long lasting" print results. When you print photo images, Brother recommends Innobella glossy photo paper (BP71 series) for high quality. Brilliant prints are made easier with Innobella Ink and paper.

¹ All replacement cartridges will provide an approximate page yield stated in accordance with ISO/IEC 24711. For more page yield information, see www.brother.com/pageyield.

✓ Related Information

- [Appendix](#)

Information Regarding Recycled Paper

- Recycled paper is of the same quality as paper made from original forest sources. Standards governing modern recycled paper ensure that it meets the highest quality requirements for different printing processes. The imaging equipment supplied by Brother is suitable for using with recycled paper meeting the EN 12281:2002 standard.
- Purchasing recycled paper saves natural resources and promotes the circular economy. Paper is made using cellulose fibres from wood. Collecting and recycling paper extends the life of fibres over multiple life cycles, making the best use of the resources.
- The recycled paper production process is shorter. The fibres have already been processed, so less water and energy, and fewer chemicals are used.
- Paper recycling has the benefit of saving carbon by diverting paper products from alternative disposal routes such as landfill and incineration. Landfill waste emits methane gas, which has a powerful greenhouse effect.



Related Information

- [Appendix](#)
-

Brother Help and Customer Support

If you need help with using your Brother product, visit support.brother.com for FAQs and troubleshooting tips. You can also download the latest software, drivers and firmware, to improve the performance of your machine, and user documentation, to learn how to get the most from your Brother product.

Further product and support information is available from your local Brother office website. Visit <https://global.brother/en/gateway> to find the contact details for your local Brother office and to register your new product.



Related Information

- [Appendix](#)
-

brother



UK
Version 0

Free Manuals Download Website

<http://myh66.com>

<http://usermanuals.us>

<http://www.somanuals.com>

<http://www.4manuals.cc>

<http://www.manual-lib.com>

<http://www.404manual.com>

<http://www.luxmanual.com>

<http://aubethermostatmanual.com>

Golf course search by state

<http://golfingnear.com>

Email search by domain

<http://emailbydomain.com>

Auto manuals search

<http://auto.somanuals.com>

TV manuals search

<http://tv.somanuals.com>