

# MFC-5200C

---

**brother**

Version B

## **If you need to call customer service**

**Please complete the following information for future reference:**

**Model Number: MFC-5200C**

**Serial Number:\*** \_\_\_\_\_

**Date of Purchase:** \_\_\_\_\_

**Place of Purchase:** \_\_\_\_\_

**\* The serial number is on the back of the unit. Retain this User's Guide with your sales receipt as a permanent record of your purchase, in the event of theft, fire or warranty service.**

**Register your product on-line at**

**[www.registermybrother.com](http://www.registermybrother.com)**

By registering your product with Brother International Corporation, you will be recorded as the original owner of the product. Your registration with Brother:

- may serve as confirmation of the purchase date of your product should you lose your receipt;
- may support an insurance claim by you in the event of product loss covered by insurance; and,
- will help us notify you of enhancements to your product and special offers.

The most convenient and efficient way to register your new product is on-line at [www.registermybrother.com](http://www.registermybrother.com)

# Brother numbers

## IMPORTANT

For technical help, you must call the country where you bought the MFC. Calls must be made **from within** that country.

## Register Your Product

By registering your product with Brother International Corporation, you will be recorded as the original owner of the product. Your registration with Brother:

- may serve as confirmation of the purchase date of your product should you lose your receipt;
- may support an insurance claim by you in the event of product loss covered by insurance; and,
- will help us notify you of enhancements to your product and special offers.

Please complete and fax the Brother Warranty Registration And Test Sheet or, for your convenience and most efficient way to register your new product, register on-line at

[www.registermybrother.com](http://www.registermybrother.com)

## Frequently Asked Questions (FAQs)

The Brother Solutions Center is our one-stop resource for all your Fax Machine/Multi-Function Center needs. You can download the latest software and utilities, read FAQs and troubleshooting tips, and go to the “Solutions” section to learn how to get the most from your Brother product.

<http://solutions.brother.com>



You can check here for Brother driver updates.

## For Customer Service

- In USA:** 1-800-284-4329 (voice)  
1-901-379-1215 (fax)  
1-800-284-3238 (TTY service for the hearing-impaired)
- In Canada:** 1-877-BROTHER (voice)  
(514) 685-4898 (fax)  
(514) 685-6464 (voice) **In Montreal**

### Service Center Locator (USA only)

For the location of a Brother authorized service center, call 1-800-284-4357.

### Service Center Locations (Canada only)

For the location of a Brother authorized service center, call 1-877-BROTHER.

## Brother fax back system (USA only)

Brother has installed an easy-to-use fax back system, so you can get instant answers to common technical questions and product information for all Brother products. This system is available 24 hours a day, 7 days a week. You can use and an Index of fax back subjects.

**In USA only:** 1-800-521-2846

The Brother fax back system number has been preprogrammed on Speed Dial # 01.

## Ordering accessories and supplies

For best quality results use only genuine Brother accessories, which are available at most Brother retailers. If you cannot find the accessory you need and you have a Visa, MasterCard, Discover, or American Express credit card, you can order accessories directly from Brother. (In the USA, you can visit us online for a complete selection of the Brother accessories and supplies that are available for purchase.)

**In USA:** 1-888-879-3232 (voice)  
1-800-947-1445 (fax)

<http://www.brothermall.com>

**In Canada:** 1-877-BROTHER (voice)

Description	Item
Ink Cartridge <black>	LC21BK
Ink Cartridge <cyan>(blue)	LC21C
Ink Cartridge <magenta>(red)	LC21M
Ink Cartridge <yellow>	LC21Y
Power Protector	QPD120
Telephone Line Cord	LG3077001
Paper Support	LE6522001
Output Paper Support	LE6398001
Network (LAN) Board (Option) Brother Print/Fax Server (10/100 BaseTX Ethernet Network)	NC-8100h
User's Guide	LE9205001 (English for USA and Canada) LE9296001 (French For Canada)
Quick Setup Guide	LE9207001 (English for USA and Canada) LE9297001 (French For Canada)
MFL Pro software on CD-ROM	LE9363001 (For CD-ROM Drive)

## **Notice - Disclaimer of Warranties (USA and Canada)**

BROTHER'S LICENSOR(S), AND THEIR DIRECTORS, OFFICERS, EMPLOYEES OR AGENTS (COLLECTIVELY BROTHER'S LICENSOR) MAKE NO WARRANTIES, EXPRESS OR IMPLIED, INCLUDING WITHOUT LIMITATION THE IMPLIED WARRANTIES OF MERCHANTABILITY AND FITNESS FOR A PARTICULAR PURPOSE, REGARDING THE SOFTWARE. BROTHER'S LICENSOR(S) DOES NOT WARRANT, GUARANTEE OR MAKE ANY REPRESENTATIONS REGARDING THE USE OR THE RESULTS OF THE USE OF THE SOFTWARE IN TERMS OF ITS CORRECTNESS, ACCURACY, RELIABILITY, CURRENTNESS OR OTHERWISE. THE ENTIRE RISK AS TO THE RESULTS AND PERFORMANCE OF THE SOFTWARE IS ASSUMED BY YOU. THE EXCLUSION OF IMPLIED WARRANTIES IS NOT PERMITTED BY SOME STATES IN THE USA AND SOME PROVINCES IN CANADA. THE ABOVE EXCLUSION MAY NOT APPLY TO YOU.

IN NO EVENT WILL BROTHER'S LICENSOR(S) BE LIABLE TO YOU FOR ANY CONSEQUENTIAL, INCIDENTAL OR INDIRECT DAMAGES (INCLUDING DAMAGES FOR LOSS OF BUSINESS PROFITS, BUSINESS INTERRUPTION, LOSS OF BUSINESS INFORMATION, AND THE LIKE) ARISING OUT OF THE USE OR INABILITY TO USE THE SOFTWARE EVEN IF BROTHER'S LICENSOR HAS BEEN ADVISED OF THE POSSIBILITY OF SUCH DAMAGES. BECAUSE SOME STATES IN THE USA AND SOME PROVINCES IN CANADA DO NOT ALLOW THE EXCLUSION OR LIMITATION OF LIABILITY FOR CONSEQUENTIAL OR INCIDENTAL DAMAGES, THE ABOVE LIMITATIONS MAY NOT APPLY TO YOU. IN ANY EVENT BROTHER'S LICENSOR'S LIABILITY TO YOU FOR ACTUAL DAMAGES FROM ANY CAUSE WHATSOEVER, AND REGARDLESS OF THE FORM OF THE ACTION (WHETHER IN CONTRACT, TORT (INCLUDING NEGLIGENCE), PRODUCT LIABILITY OR OTHERWISE), WILL BE LIMITED TO \$50.

## **Compilation and Publication Notice**

Under the supervision of Brother Industries Ltd., this manual has been compiled and published, covering the latest product descriptions and specifications.

The contents of this manual and the specifications of this product are subject to change without notice.

Brother reserves the right to make changes without notice in the specifications and materials contained herein and shall not be responsible for any damages (including consequential) caused by reliance on the materials presented, including but not limited to typographical and other errors relating to the publication.

# Brother® One Year Limited Warranty and Replacement Service (USA only)

## Who is covered:

- This limited warranty ("warranty") is given only to the original end-use/retail purchaser (referred to in this warranty as "Original Purchaser") of the accompanying product, consumables and accessories (collectively referred to in this warranty as "this Product").
- If you purchased a product from someone other than an authorized Brother reseller in the United States or if the product was used (including but not limited to floor models or refurbished product), prior to your purchase you are not the Original Purchaser and the product that you purchased is not covered by this warranty.

## What is covered:

- This Product includes a Machine and Consumable and Accessory Items. Consumable and Accessory Items include but are not limited to print heads, toner, drums, ink cartridges, print cartridges, refill ribbons, therma PLUS paper and thermal paper.
- Except as otherwise provided herein, Brother warrants that the Machine and the accompanying Consumable and Accessory Items will be free from defects in materials and workmanship, when used under normal conditions.
- This warranty applies only to products purchased and used in the United States. For products purchased in, but used outside, the United States, this warranty covers only warranty service within the United States (and does not include shipping outside the United States).

## What is the length of the Warranty Periods:

- Machines: one year from the original purchase date.
- Accompanying Consumable and Accessory Items: 90 days from the original purchase date or the rated life of consumable, whichever comes first.

## What is NOT covered:

This warranty does not cover:

- (1) Physical damage to this Product;
- (2) Damage caused by improper installation, improper or abnormal use, misuse, neglect or accident (including but not limited to transporting this Product without the proper preparation and/or packaging);
- (3) Damage caused by another device or software used with this Product (including

but not limited to damage resulting from use of non Brother®-brand parts and Consumable and Accessory Items);

- (4) Consumable and Accessory Items that expired in accordance with a rated life; and,
- (5) Problems arising from other than defects in materials or workmanship.

This limited warranty is VOID if this Product has been altered or modified in any way (including but not limited to attempted warranty repair without authorization from Brother and/or alteration/removal of the serial number).

## What to do if you think your Product is eligible for warranty service:

Report your issue to either our Customer Service Hotline at 1-800-284-4329 or a Brother Authorized Service Center **within the applicable warranty period**. Supply Brother or the Brother Authorized Service Center with a copy of your dated bill of sale showing that this Product was purchased within the U.S. For the name of local Brother Authorized Service Center(s), call 1-800-521-2846.

## What Brother will ask you to do:

After contacting Brother or a Brother Authorized Service Center, you may be required to deliver (by hand if you prefer) or send the Product properly packaged, freight prepaid, to the Authorized Service Center together with a photocopy of your bill of sale. **You are responsible for the cost of shipping, packing product, and insurance (if you desire). You are also responsible for loss or damage to this Product in shipping.**

## What Brother will do:

If the problem reported concerning your Machine and/or accompanying Consumable and Accessory Items is covered by this warranty and if you first reported the problem to Brother or an Authorized Service Center within the applicable warranty period, Brother or its Authorized Service Center will repair or replace the Machine and/or accompanying Consumable and Accessory Items at no charge to you for parts or labor. The decision as to whether to repair or replace the Machine and/or accompanying Consumable and Accessory Items is made by Brother in its sole discretion. Brother reserves the right to supply a refurbished or remanufactured replacement Machine and/or accompanying Consumable and Accessory Items and use refurbished parts provided such replacement products

## Brother® One Year Limited Warranty and Replacement Service (USA only)

conform to the manufacturer's specifications for new product/parts. The repaired or replacement Machine and/or accompanying Consumable and Accessory Items will be returned to you freight prepaid or made available for you to pick up at a conveniently located Authorized Service Center.

If the Machine and/or accompanying Consumable and Accessory Items are not covered by this warranty (either stage), you will be charged for shipping the Machine and/or accompanying Consumable and Accessory Items back to you.

**The foregoing are your sole (i.e., only) and exclusive remedies under this warranty.**

**What happens when Brother elects to replace your Machine:**

When a replacement Machine is authorized by Brother, and you have delivered the Machine to an Authorized Service Center, the Authorized Service Center will provide you with a replacement Machine after receiving one from Brother. If you are dealing directly with Brother, Brother will send to you a replacement Machine with the understanding that you will, after receipt of the replacement Machine, supply the required proof of purchase information, together with the Machine that Brother agreed to replace. You are then expected to pack the Machine that Brother agreed to replace in the package from the replacement Machine and return it to Brother using the pre-paid freight bill supplied by Brother in accordance with the instructions provided by Brother. Since you will be in possession of two machines, Brother will require that you provide a valid major credit card number. Brother will issue a hold against the credit card account number that you provide until Brother receives your original Product and determines that your original Product is entitled to warranty coverage. Your credit card will be charged up to the cost of a new Product only if: (i) you do not return your original Product to Brother within five (5) business days; (ii) the problems with your original Product are not covered by the limited warranty; (iii) the proper packaging instructions are not followed and has caused damage to the product; or (iv) the warranty period on your original Product has expired or has not been sufficiently validated with a copy of the proof of purchase (bill of sale). The replacement Machine you receive (even if refurbished or

remanufactured) will be covered by the balance of the limited warranty period remaining on the original Product, plus an additional thirty (30) days. You will keep the replacement Machine that is sent to you and your original Machine shall become the property of Brother. **Retain your original Accessory Items and a copy of the return freight bill, signed by the courier.**

### Limitations:

Brother is not responsible for damage to or loss of any equipment, media, programs or data related to the use of this Product. Except for that repair or replacement as described above, Brother shall not be liable for any direct, indirect, incidental or consequential damages or specific relief. Because some states do not allow the exclusion or limitation of consequential or incidental damages, the above limitation may not apply to you.

THIS WARRANTY IS GIVEN IN LIEU OF ALL OTHER WARRANTIES, WRITTEN OR ORAL, WHETHER EXPRESSED BY AFFIRMATION, PROMISE, DESCRIPTION, DRAWING, MODEL OR SAMPLE. ANY AND ALL WARRANTIES OTHER THAN THIS ONE, WHETHER EXPRESS OR IMPLIED, INCLUDING IMPLIED WARRANTIES OF MERCHANTABILITY AND FITNESS FOR A PARTICULAR PURPOSE, ARE HEREBY DISCLAIMED.

- This Limited Warranty is the only warranty that Brother is giving for this Product. It is the *final expression and the exclusive and only statement* of Brother's obligations to you. It replaces all other agreements and understandings that you may have with Brother or its representatives.
- This warranty gives you certain rights and you may also have other rights that may vary from state to state.
- This Limited Warranty (and Brother's obligation to you) may not be changed in any way unless you and Brother sign the same piece of paper in which we (1) refer to this Product and your bill of sale date, (2) describe the change to this warranty and (3) agree to make that change.

**Important:** *We recommend that you keep all original packing materials, in the event that you ship this product.*

**BROTHER MULTIFUNCTION CENTER/FACSIMILE MACHINE  
LIMITED WARRANTY  
(Canada only)**

Pursuant to this limited warranty of 1 year from the date of purchase for labour and parts, Brother International Corporation (Canada) Ltd. ("Brother"), or its Authorized Service Centers, will repair this MFC/Facsimile machine free of charge if defective in material or workmanship. This Limited Warranty does not include cleaning, consumables (including, without limitation, print cartridges, print head, toner and drum) or damage caused by accident, neglect, misuse or improper installation or operation, any damage caused from service, maintenance, modifications, or tampering by anyone other than a Brother Authorized Service Representative, or from the use of supplies or consumable items that are non-Brother products. Operation of the MFC/Facsimile machine in excess of the specifications or with the Serial Number or Rating Label removed shall be deemed abuse and all repairs thereafter shall be the sole liability of the end-user/purchaser. In order to obtain warranty service, the MFC/Facsimile machine must be delivered or shipped freight prepaid by the end user/purchaser to a "Brother" Authorized Service Center, together with your Proof of Purchase in the form of a Sales Receipt.

For laser products: Failure to remove the Toner Cartridge (and Toner Drum Unit on applicable models) during shipping will cause severe damage to the MFC/Facsimile and will VOID the Warranty. (Refer to your Operation Manual for proper packaging.)

For ink-jet products: Do not remove the ink cartridges during shipping. Damage to your print head resulting from packing without the ink cartridges will VOID your warranty. (Refer to your Operation Manual for proper packaging.)

BROTHER DISCLAIMS ALL OTHER WARRANTIES EXPRESSED OR IMPLIED INCLUDING, WITHOUT LIMITATION, ANY IMPLIED WARRANTIES OF MERCHANTABILITY OR FITNESS FOR A PARTICULAR PURPOSE, EXCEPT TO THE EXTENT THAT ANY WARRANTIES IMPLIED BY LAW CANNOT BE VALIDLY WAIVED.

No oral or written information, advice or representation provided by Brother, its Authorized Service Centers, Distributors, Dealers, Agents or employees, shall create another warranty or modify this warranty. This warranty states Brother's entire liability and your exclusive remedy against Brother for any failure of the MFC/Facsimile machine to operate properly.

Neither Brother nor anyone else involved in the development, production, or delivery of this MFC/Facsimile machine shall be liable for any indirect, incidental, special, consequential, exemplary, or punitive damages, including lost profits, arising from the use of or inability to use the product, even if advised by the end user/purchaser of the possibility of such damages. Since some Provinces do not allow the above limitation of liability, such limitation may not apply to you.

This Limited Warranty gives you specific legal rights and you may also have other rights which vary from Province to Province.

**Warranty Service is available at Brother Authorized Service Centers throughout Canada. For Technical Support or for the name and location of your nearest Authorized Service Center call 1-877-BROTHER. Within Montreal, please call (514) 685-6464.**

**Internet support: [support@brother.ca](mailto:support@brother.ca) or browse**

**Brother's Web Site: [www.brother.com](http://www.brother.com)**

Brother International Corporation (Canada) Ltd.  
1 Rue Hôtel de Ville  
Dollard-Des-Ormeaux, QC H9B 3H6











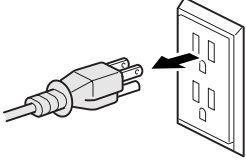

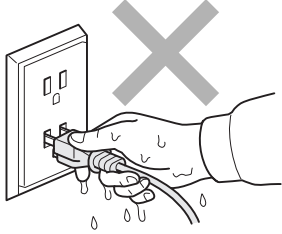
At your side.  
**brother**®

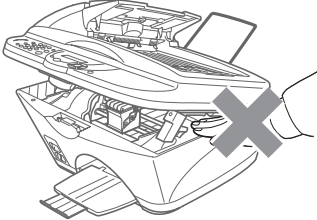

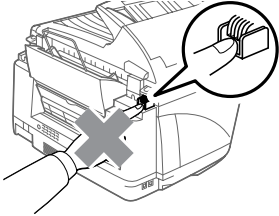
# Safety Precautions

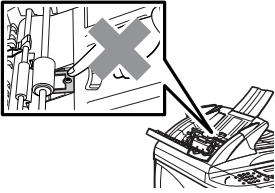
## To Use the MFC Safely

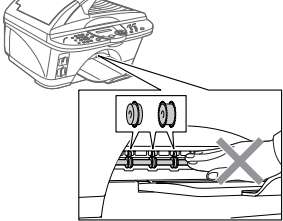
### WARNING

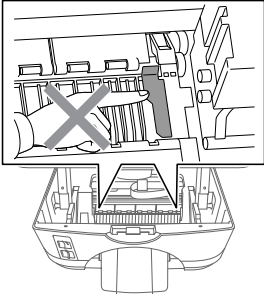
	<p>There are high voltage electrodes inside the MFC. Before you replace internal parts, clean the MFC or clear a paper jam, make sure you have unplugged the power cord from the power outlet.</p> 		<p>Do not handle the plug with wet hands. Doing this might cause an electrical shock.</p> 
	<p>To prevent injuries, be careful not to put your hands on the edge of the MFC under the scanner cover.</p> 		<p>To prevent injuries, be careful not to put your fingers in the area shown in the illustration.</p> 
	<p>To prevent injuries, be careful not to touch the edge of metallic part shown in the illustration.</p> 		<p>To prevent injuries, be careful not to touch the area shaded in the illustration.</p> 
	<p>To prevent injuries, be careful not to touch the edge of the metallic part shown in the illustration.</p> 		

## **WARNING**

- Use caution when installing or modifying telephone lines. Never touch telephone wires or terminals that are not insulated unless the telephone line has been disconnected at the wall jack. Never install telephone wiring during a lightning storm. Never install a telephone jack in a wet location unless the jack is specifically designed for a wet location.
- For PLUG CABLE EQUIPMENT, the socket-outlet should be installed near the equipment and should be easily accessible.
- To reduce the risk of shock or fire, use only a No. 26 AWG or larger telecommunication line cord.

## **Caution**

- Lightning and power surges can damage this product! We recommend that you use a quality surge protection device on the AC power line and on the telephone line, or unplug the lines during a lightning storm.
- Do not use this product near appliances that use water, in a wet basement or near a swimming pool.
- Avoid using a telephone other than a cordless type during an electrical storm. There may be a remote risk of electric shock from lightning.

# Choosing a Location

Place your MFC on a flat, stable surface that is free of vibration and shocks, such as a desk. Locate the MFC near a telephone jack and a standard, grounded power outlet. Choose a location where the temperature remains between 50°F and 95°F (10°-35°C).

## **Caution**

- Avoid placing your MFC in a high-traffic area.
- Do not place near heaters, air conditioners, water, chemicals, or refrigerators.
- Do not expose the MFC to direct sunlight, excessive heat, moisture, or dust.
- Do not connect your MFC to electrical outlets controlled by wall switches or automatic timers.
- Disruption of power can wipe out information in the MFC's memory.
- Do not connect your MFC to electrical outlets on the same circuit as large appliances or other Equipment that might disrupt the power supply.
- Avoid interference sources, such as speakers or the base units of cordless phones.

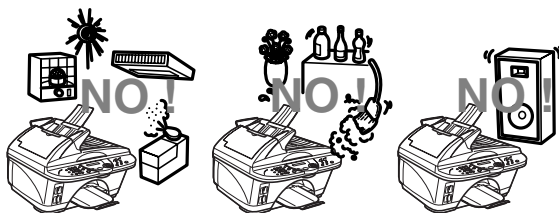





# Quick Reference Guide

## Sending Black & White Faxes

### Automatic Transmission





- 1 Place the original face up in the ADF (Automatic Document Feeder), or face down on the scanner glass.
- 2 Enter the fax number using the dial pad, Speed Dial or Search.
- 3 Press **Fax Start**.

### Sending a Cover Page<sup>\*1</sup>

- 1 Place the original face up in the ADF, or face down on the scanner glass.
- 2 Press **Menu/Set, 2, 2, 7**.
- 3 When **NEXT FAX ONLY** appears, press **Menu/Set**.
- 4 Press  or  to select **ON**, and then press **Menu/Set**.
- 5 Press  or  to select a comment, and then press **Menu/Set**.
- 6 Enter two digits for the number of pages being sent, and then press **Menu/Set**.
- 7 Press **1** to select additional settings—**OR**—Press **2** if you are ready to fax.
- 8 Enter the fax number.
- 9 Press **Fax Start**.

## Real Time Transmission

You can send faxes in real time.

- 1 Place the original face up in the ADF, or face down on the scanner glass.
- 2 Press **Menu/Set, 2, 2, 5**.
- 3 Press  or  to select **ON**, and then press **Menu/Set—OR—**For the next fax only, press  or  to select **NEXT FAX ONLY**, and then press **Menu/Set**.
- 4 For the next fax only, press to select **ON**, and then press **Menu/Set**.
- 5 Press **1** to select additional settings—**OR**—Press **2** to fax.
- 6 Enter the fax number.
- 7 Press **Fax Start**.

## Receiving Faxes

### Select Receive Mode

Press **Receive Mode** to select **FAX ONLY**, **FAX/TEL**, **EXTERNAL TAD** or **MANUAL**. If you select **FAX/TEL**, make sure you set **Ring Delay** and **F/T Ring Time**.

<sup>\*1</sup> You must have set up the **Station ID** before you can program the **Cover Page**.

## Storing Numbers

Storing Speed Dial Numbers



- 1 Press **Menu/Set**, **2**, **3**, **1**.
- 2 Enter a two-digit Speed Dial number, and then press **Menu/Set**.
- 3 Enter a number (up to 20 digits), and then press **Menu/Set**.
- 4 Enter a name (or leave it blank), and then press **Menu/Set**.
- 5 Press **Stop/Exit**.

## Dialing Operations

### Speed Dialing

- 1 Place the original face up in the ADF, or face down on the scanner glass.
- 2 Press **Search/Speed Dial**, press **#**, and then press the two-digit Speed Dial number.
- 3 Press **Fax Start**.

### Search/Speed Dial





- 1 Place the original face up in the ADF, or face down on the scanner glass.
- 2 Press **Search/Speed Dial**, and then enter the first letter of the name you're looking for.
- 3 Press  or  to search the memory.
- 4 Press **Fax Start**, when the LCD shows the name you want to call.

## Making Copies

Making a Single Copy

- 1 Place the original face up in the ADF, or face down on the scanner glass.
- 2 Press **Black Copy** or **Color Copy**.

Sorting Multiple Copies (Using the ADF)

- 1 Place the original face up in the ADF.
- 2 Use the dial pad to enter the number of copies you want (up to 99).
- 3 Press **Options**.
- 4 Press  or  to select **STACK/SORT**, and then press **Menu/Set**.
- 5 Press  or  to select **SORT**, and then press **Menu/Set**. Press **Black Copy** or **Color Copy**.

Brother fax back system:

In USA: 1-800-521-2846

Brother Global Web Site:

<http://www.brother.com>

Frequently Asked Questions (FAQs) and Product Support

<http://solutions.brother.com>

Brother Accessories & Supplies:

In USA: 1-888-879-3232 (voice)

1-800-947-1445 (fax)

<http://www.brothermall.com>

In Canada: 1-877-BROTHER (voice)

# Table of Contents

## 1

<b>Introduction .....</b>	<b>1-1</b>
Using this Guide .....	1-1
Finding information .....	1-1
Symbols used in this Guide .....	1-1
Fax Test Sheet procedure and registering your product (USA only) .....	1-2
On-Line Registration (USA and Canada) .....	1-2
MFC-5200C control panel overview .....	1-3
Turning the MFC on and off.....	1-5
Turning the MFC off .....	1-5
Turning the MFC on .....	1-5
About fax machines .....	1-6
Custom features .....	1-6
Do you have Voice Mail on the phone line? .....	1-6
Why should there be problems?.....	1-6
How can you avoid possible problems? .....	1-6
Fax tones and handshake .....	1-7
ECM (Error Correction Mode).....	1-8
Connecting the MFC.....	1-8
Connecting an External Telephone .....	1-8
Connecting an External Telephone Answering Device (TAD) .....	1-8
Sequence .....	1-8
Connections .....	1-10
Recording Outgoing Message (OGM).....	1-10
Special Line Considerations .....	1-11
Roll Over Phone Lines .....	1-11
Two-Line Phone System .....	1-11
Converting Telephone Wall Outlets.....	1-11
Installing MFC, External Two-Line TAD and Two-Line Telephone.....	1-12
Multi-Line Connections (PBX) .....	1-13
If you are Installing the MFC to Work with a PBX	1-13
Custom Features on Your Phone Line .....	1-13

## 2

<b>Paper .....</b>	<b>2-1</b>
About paper .....	2-1
Handling and using special paper .....	2-1
Recommended paper.....	2-2
Paper capacity of the Paper Tray .....	2-2
Paper specifications for the Paper Tray .....	2-3

Paper specifications for the manual feed slot.....	2-3
Printable area .....	2-5

### 3

<b>On-Screen Programming .....</b>	<b>3-1</b>
User-friendly programming .....	3-1
Menu table .....	3-1
Navigation keys .....	3-2

### 4

<b>Initial setup .....</b>	<b>4-1</b>
Getting started .....	4-1
Setting the Paper Type .....	4-1
Setting the Paper Size .....	4-2
Setting the Date and Time .....	4-2
Setting the Station ID.....	4-3
Entering text .....	4-4
Inserting spaces .....	4-4
Making corrections .....	4-4
Repeating letters .....	4-4
Special characters and symbols .....	4-4
Setting the Ring Volume .....	4-5
Setting the Beeper Volume.....	4-6
Setting the Speaker Volume.....	4-6
Turning on Automatic Daylight Savings Time.....	4-7
Setting Tone or Pulse dialing mode .....	4-7
Memory Storage .....	4-7

### 5

<b>Setup Receive .....</b>	<b>5-1</b>
Basic receiving operations.....	5-1
Choosing the Receive Mode.....	5-1
To select or change your Receive Mode .....	5-2
Setting the Ring Delay .....	5-2
Setting the F/T Ring Time (FAX/TEL mode only) .....	5-3
Easy Receive .....	5-4
Printing a reduced incoming fax (Auto Reduction) .....	5-4
Advanced receiving operations.....	5-5
Operation from extension telephones.....	5-5
For FAX/TEL mode only .....	5-5
Using a cordless external handset.....	5-5
Changing the remote codes .....	5-6
Printing a fax from the memory.....	5-6
Polling.....	5-7
Setting up Polling Receive.....	5-7
Setting up Sequential Polling Receive.....	5-7
Canceling a scheduled job.....	5-8

Telephone services .....	5-9
Distinctive Ring.....	5-9
What does your telephone company's 'Distinctive Ring' do? .....	5-9
What does Brother's 'Distinctive Ring' do? .....	5-9
Do you have Voice Mail?.....	5-10
Before you choose the ring pattern to register .....	5-10
Very important .....	5-11
Registering the Distinctive Ring pattern .....	5-11
Turning off the Distinctive Ring .....	5-11

## 6

<b>Setup Send .....</b>	<b>6-1</b>
Before you begin .....	6-1
Sending faxes using multiple settings .....	6-1
Faxing from the automatic document feeder (ADF) ...	6-1
Recommended environment .....	6-1
Setting the special media lever.....	6-3
Faxing from the scanner glass .....	6-4
Basic sending operations .....	6-5
Contrast .....	6-5
Fax resolution .....	6-6
Manual transmission.....	6-7
Automatic transmission .....	6-7
This is the easiest way to send a fax. ....	6-7
Color fax transmission .....	6-7
Manual and automatic fax redial.....	6-8
Dual Access (Not available for color faxes).....	6-8
Real Time Transmission.....	6-9
Checking job status .....	6-10
Canceling a job in the memory .....	6-10
Advanced sending operations .....	6-11
Composing the electronic Cover Page .....	6-11
Composing your own comments .....	6-12
Cover page for the next fax only .....	6-13
Send a cover page for all faxes.....	6-14
Using a printed cover page.....	6-14
Overseas Mode .....	6-15
Delayed Fax (Not available for color faxes).....	6-15
Delayed Batch Transmission (Not available for color faxes).....	6-16
Setting up Polled Transmission (Not available for color faxes).....	6-16

# 7

<b>Auto Dial numbers and Dialing options</b> .....	<b>7-1</b>
Storing numbers for easy dialing .....	7-1
Storing Speed Dial numbers.....	7-1
Changing Speed Dial numbers.....	7-2
Setting up Groups for Broadcasting.....	7-3
Dialing options .....	7-4
Manual dialing with an external telephone.....	7-4
Search .....	7-4
Speed dialing .....	7-5
Access codes and credit card numbers.....	7-5
Broadcasting (Not available for color faxes) .....	7-6
Pause .....	7-7
Fax Redial.....	7-7
Tone or Pulse .....	7-7

# 8

<b>Remote fax options (Not available for color faxes)</b> .....	<b>8-1</b>
Fax Forwarding/Paging .....	8-1
Programming a Fax Forwarding number .....	8-1
Programming your pager number .....	8-2
Setting Fax Storage .....	8-3
Backup Print .....	8-3
Changing your remote access code .....	8-4
Remote retrieval .....	8-4
Using your remote access code .....	8-4
Remote commands.....	8-5
Retrieving fax messages .....	8-6
Changing your Fax Forwarding number .....	8-6

# 9

<b>Printing Reports</b> .....	<b>9-1</b>
MFC settings and activity.....	9-1
Customizing the Transmission Verification Report .....	9-1
Setting the Fax Activity Report Interval.....	9-2
Printing reports .....	9-3
To Print a Report .....	9-3

# 10

<b>Making copies</b> .....	<b>10-1</b>
Using the MFC as a copier .....	10-1
Making a single copy .....	10-2
Making more than one copy (Using the ADF).....	10-2
Single or multiple copies (Using the scanner glass) .....	10-3
Out of memory message .....	10-3
Using more than one temporary copy setting .....	10-4
Using the Quality key .....	10-6
Using the Enlarge/Reduce key .....	10-7



Selecting the fixed reduction ratio .....	10-8
Using the Options key .....	10-8
Paper Type .....	10-9
Paper Size .....	10-10
Near Edge .....	10-10
Brightness .....	10-11
Contrast .....	10-11
Sorting copies using the ADF .....	10-12
Page Layout using the ADF .....	10-12
Page Layout using the scanner glass .....	10-12
Turning on Manual Feed .....	10-14
Changing the default copy settings .....	10-15
Copy Quality .....	10-16
Near Edge .....	10-16
Brightness .....	10-16
Contrast .....	10-16
Color Adjustment .....	10-17
Legal limitations .....	10-18

# 11

<b>Walk-Up PhotoCapture Center™ .....</b>	<b>11-1</b>
Introduction .....	11-1
Basic flow .....	11-1
Getting started .....	11-2
Printing the Index (Thumbnails) .....	11-4
Printing images .....	11-5
Changing the settings for printing images .....	11-6
Menu selections .....	11-8
Number of Copies .....	11-8
Paper Type .....	11-8
Paper and Print Size .....	11-9
Print Quality .....	11-10
Brightness .....	11-10
Color enhancement (True2Life®) .....	11-11
Turning on Manual Feed .....	11-12
DPOF printing .....	11-13
Changing the default settings .....	11-14
Print Quality .....	11-15
Print Size .....	11-15
Brightness .....	11-15
Contrast .....	11-15
Color enhancement (True2Life®) .....	11-16
Understanding the Error Messages .....	11-17
PhotoCapture Center™ Requirements .....	11-17
Using PhotoCapture Center™ from your PC .....	11-18

Using PhotoCapture Center™ for scanning originals..... 11-18

## 12

<b>Using the MFC as a printer .....</b>	<b>12-1</b>
Using the Brother MFC-5200C printer driver .....	12-1
Features.....	12-1
Choosing the right type of paper.....	12-2
How to print your document.....	12-2
Using the manual feed slot .....	12-3
Simultaneous printing and faxing.....	12-4
Clearing data from the memory .....	12-4
Checking the Print Quality .....	12-4

## 13

<b>Printer driver settings (Windows® Only) .....</b>	<b>13-1</b>
Printer driver settings.....	13-1
How to access the printer driver settings.....	13-1
Basic tab .....	13-2
Media Type.....	13-3
Quality .....	13-3
Bi-Directional Printing .....	13-4
Paper Size .....	13-5
Page Layout .....	13-5
Border Line .....	13-5
Orientation .....	13-6
Copies .....	13-6
Collate .....	13-6
Reverse Order .....	13-6
Near Edge Print .....	13-6
Paper Feed.....	13-7
Advanced tab.....	13-8
Color .....	13-9
Color/Grayscale.....	13-9
Image Type.....	13-9
Custom Image Type .....	13-10
Halftone Pattern.....	13-10
Color enhancement (True2Life®).....	13-11
Scaling .....	13-13
Watermark .....	13-14
In background.....	13-14
In Outline Text (Windows® 2000 Professional/XP /Windows NT® 4.0 Only).....	13-14
Print Watermark.....	13-14
Watermark Style .....	13-15
Device Options .....	13-16
Print Date & Time .....	13-16

Quick Print Setup .....	13-17
Support tab .....	13-18
Brother Solutions Center .....	13-18
Web Update .....	13-18
Check Setting .....	13-18
<b>Using the Brother Control Center for Windows® 95/98/98SE/ Me/2000 Professional and Windows NT® WS 4.0 .....</b>	<b>14-1</b>
Brother MFL-Pro Control Center .....	14-1
AutoLoad the Brother Control Center .....	14-2
How to turn off AutoLoad .....	14-2
Brother Control Center Features .....	14-3
Auto Configuration .....	14-3
Scanning operations .....	14-4
Copy operations .....	14-4
PC-Fax operation .....	14-4
Scanner settings for Scan, Copy and PC-Fax buttons .....	14-5
Global settings .....	14-5
Setting up the scanner configurations .....	14-6
To access the scanner Configurations screen .....	14-7
Perform an operation from the Control Center screen .....	14-7
Scan to File .....	14-8
Scanner settings .....	14-8
Destination folder .....	14-9
Scan to E-mail .....	14-10
Scanner settings .....	14-10
E-mail application .....	14-11
Send to Options .....	14-11
Scan to Word Processor .....	14-12
Scanner settings .....	14-12
Word Processor .....	14-13
User-defined button .....	14-14
Scanner Settings .....	14-14
Target Application .....	14-14
Copy .....	14-15
Scanner settings .....	14-15
Number of copies .....	14-15
Send a fax .....	14-16
Scanner settings .....	14-16
FAX Settings .....	14-17

<b>How to scan using Windows®</b> .....	<b>15-1</b>
Scanning a document .....	15-1
TWAIN compliant.....	15-1
How to Access the Scanner.....	15-2
Scanning a document into the PC .....	15-3
Scanning a whole page .....	15-3
PreScanning to crop a portion you want to scan ..	15-4
Settings in the Scanner window.....	15-6
Image Type.....	15-6
Resolution.....	15-6
Scan Type .....	15-7
Brightness.....	15-7
Contrast .....	15-7
Document Size .....	15-8
Scanning a document (For Windows® XP only).....	15-10
WIA compliant.....	15-10
How to access the scanner.....	15-10
Scanning a document into the PC .....	15-10
Scanning a document using the ADF .....	15-11
PreScanning to crop a portion you want to scan	
using the Scanner Glass .....	15-12
Brother Scanner Utility.....	15-14
Using the color scan key.....	15-15
Scan to E-mail .....	15-16
Scan Image .....	15-16
Scan/OCR.....	15-16
Scan to Card.....	15-17
Changing the default color file format.....	15-18
Using ScanSoft™ PaperPort® and TextBridge® OCR....	15-19
Viewing items.....	15-20
Organizing your items in folders .....	15-21
Quick links to other applications .....	15-21
ScanSoft™ TextBridge® OCR lets you convert	
image text in to text you can edit.....	15-22
You can Import items from other applications .....	15-22
You can Export items in other formats.....	15-23
Exporting an image file .....	15-23

<b>Using Remote Setup (For Windows®)</b> .....	<b>16-1</b>
MFC Remote Setup .....	16-1

<b>Using PC-FAX (For Windows®)</b> .....	<b>17-1</b>
PC-FAX sending .....	17-1
Setting up user information.....	17-1
Sending setup.....	17-2
Outside line access .....	17-2
Include header.....	17-2
Address Book file.....	17-2
User interface .....	17-3
Simple style .....	17-3
Facsimile style.....	17-3
Speed Dial setup .....	17-4
The Address Book.....	17-5
Setting up a Member in the Address Book.....	17-6
Setting up a Group for Broadcasting .....	17-7
Editing Member information.....	17-8
Deleting a Member or Group.....	17-8
Exporting the Address Book.....	17-9
Importing to the Address Book .....	17-11
Setting up a Cover Page .....	17-12
You can enter information in each field. ....	17-12
Sending a file as a PC-FAX using the	
Facsimile style.....	17-13
Redial .....	17-14
Sending a file as a PC-FAX using the Simple style	17-15
Setting up PC-FAX receiving	
(Windows®95/98/98SE/Me/2000 Professional and	
Windows NT® WS 4.0 only).....	17-17
Running PC-FAX Receiving .....	17-17
Setting up your PC .....	17-17
Viewing new PC-FAX messages.....	17-18
Receiving a Fax into the PC (Windows® XP only) .....	17-19
How to receive a Fax automatically.....	17-19
How to view the received faxes .....	17-24

<b>Using the PhotoCapture Center™ from your PC</b> <b>(For Windows®)</b> .....	<b>18-1</b>
Introduction.....	18-1

<b>Using your MFC with a Macintosh®</b> .....	<b>19-1</b>
Setting up your USB-equipped Apple® Macintosh® G3, G4 or iMac™ or iBook™ with Mac OS 8.5 - 9.2 or Mac OS X 10.1, 10.2.1 or greater .....	19-1
Using the Brother printer driver with your Apple® Macintosh® (OS 8.5-9.2).....	19-2

Using the Brother Printer Driver with Your Apple® Macintosh® (OS X 10.1, 10.2.1 or greater) .....	19-4
Choosing page setup options .....	19-4
Printing a document.....	19-4
Choosing printing options .....	19-5
Sending a fax from your Macintosh® application (OS 8.5 - 9.2).....	19-6
Setting up your Address Book .....	19-8
Adding a new Member.....	19-8
Adding a new Group.....	19-9
Using the Brother TWAIN scanner driver with your Macintosh® (For Mac® OS 8.6-9.2 and OS X 10.2.1 or greater) ...	19-10
Accessing the scanner.....	19-10
Scanning an image into your Macintosh® .....	19-11
Scanning a whole page .....	19-11
PreScanning an image .....	19-12
Settings in the Scanner window.....	19-13
Image.....	19-13
Scanning Area .....	19-14
Business Card Size .....	19-14
Adjusting the Image.....	19-15
Color Sync Dialog.....	19-15
Scanner Profile .....	19-16
MFC Remote Setup (Mac OS X 10.1, 10.2.1 or greater) .....	19-17
Using the PhotoCapture Center™ from Macintosh® .....	19-18

## 20

<b>Important information .....</b>	<b>20-1</b>
Standard telephone and FCC Notices .....	20-1
These notices are in effect on models sold and used in the United States only .....	20-1
Federal Communications Commission (FCC) Declaration of Conformity (USA only).....	20-3
Important .....	20-3
Industry Canada Compliance Statement (Canada only).....	20-3
Important safety instructions.....	20-4
Trademarks.....	20-6

## 21

<b>Troubleshooting and routine maintenance .....</b>	<b>21-1</b>
Troubleshooting .....	21-1
Error Messages .....	21-1
Original jams.....	21-3
Printer Jam or Paper Jam.....	21-4

If you are having difficulty with your MFC .....	21-7
How to improve print quality .....	21-10
Cleaning the print head .....	21-10
Print Quality Check.....	21-10
Checking the ink volume .....	21-13
Packing and shipping the MFC.....	21-13
Routine maintenance.....	21-16
Cleaning the Scanner .....	21-16
Cleaning the MFC printer platen.....	21-17
Replacing the ink cartridge .....	21-17

## S

<b>Specifications .....</b>	<b>S-1</b>
Product description.....	S-1
General.....	S-1
Print media .....	S-2
Copy .....	S-2
Fax .....	S-3
Scanner .....	S-4
Printer .....	S-4
Interface.....	S-4
Photo Capture Center.....	S-5
Computer Requirements .....	S-5
Consumable Items.....	S-6
Network (LAN) Board (Option) .....	S-6

## G

<b>Glossary .....</b>	<b>G-1</b>
<b>INDEX .....</b>	<b>I-1</b>
<b>Remote Retrieval Access Card .....</b>	<b>R-1</b>





# 1 Introduction

## Using this Guide

Thank you for buying a Brother multi-function center (MFC). This MFC is simple to use, with LCD screen instructions to guide you through programming your MFC. You can make the most of your MFC by taking a few minutes to read this Guide.

## Finding information

---

All the chapter headings and subheadings are listed in the Table of Contents. You will be able to find information about a specific feature or operation by checking the Index at the back of this Guide.

## Symbols used in this Guide

---

Throughout this Guide you'll see special symbols alerting you to important warnings, notes and actions. To make things clearer and to help you press the correct keys, we've added some of the messages that will appear in the LCD.

**Bold**                      Bold typeface identifies specific keys on the MFC control panel.

*Italics*                      Italicized typeface emphasizes an important point or refers you to a related topic.

 Warnings inform you what to do to avoid possible personal injury or damage to the machine.

 Notes tell you how you should respond to a situation that may arise or give tips about how the current operation works with other features.

 Improper Setup alerts you to devices and operations that are not compatible with the MFC.

## **Fax Test Sheet procedure and registering your product (USA only)**

---

After setting your Station ID, please fill in the Test Sheet included with your MFC and fax it to Brother's Automated Fax Response System as your first transmission. This will check that your MFC is working properly.

To get a response, you must have set your Station ID.

(See *Setting the Station ID* on page 4-3.)

**In USA Only:** 1-877-268-9575

When your Test Sheet is received, a Confirmation Sheet and Product Registration form will be sent back to your MFC.

Please fill in the form and return it to complete your registration.

## **On-Line Registration (USA and Canada)**

---

- 1** Insert the MFL Pro Suite CD-ROM into your CD-ROM drive.
- 2** Click **Online Registration** to register your product.

# MFC-5200C control panel overview

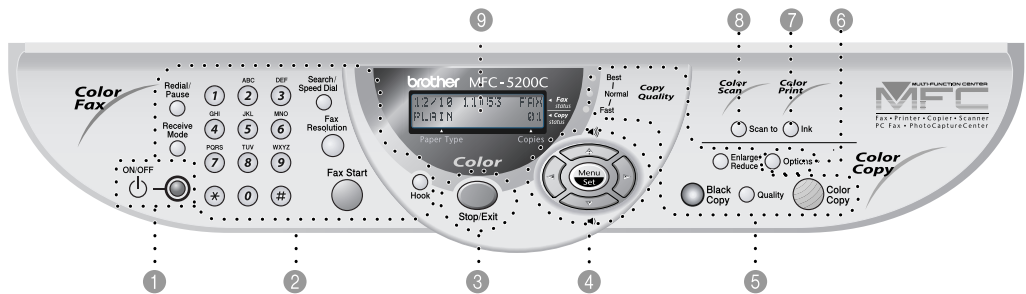

## 1 ON/OFF

You can turn the MFC on or off.

## 2 Fax and telephone keys:

### Redial/Pause

Redials the last number you called. It also inserts a pause in auto dial numbers.

### Receive Mode

Use to select how the MFC will handle incoming calls.

### Dial Pad

Use this to dial telephone and fax numbers and as a keyboard for entering information into the MFC.

The # key lets you switch the dialing type during a telephone call from Tone to Pulse

### Search/Speed Dial

Lets you look up numbers that are stored in the dialing memory. It also lets you dial stored numbers by pressing # and a two-digit number.

## Fax Resolution

Sets the resolution when you send a fax.

## Fax Start

Starts an operation, such as sending a fax.

## Hook

Lets you dial numbers without picking up the handset.

## 3 Stop/Exit

Stops a fax, cancels an operation or exits from the Menu.

#### 4 **Navigation keys:**

##### **Menu/Set**

Lets you access the Menu to program and store your settings in the MFC.

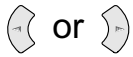

Press to scroll forward or backward to a menu selection.

Also, you can use these keys to do an alphabetical search for the names of stored numbers.



##### **Volume**

Press to scroll through the menus and options.

When using the speaker or ring, you can press these keys to adjust the volume.

#### 5 **Copy keys (Temporary settings):**

##### **Quality**

Use this key to temporarily change the quality for Copying.

##### **Quality indicator lights**

These lights show the copy quality you selected with the Quality key.

##### **Enlarge/Reduce**

Lets you enlarge or reduce copies depending on the ratio you select.

#### **Black Copy**

Makes a black-and-white copy.

#### **Color Copy**

Makes a full-color copy.

#### 6 **Options**

You can quickly and easily select temporary settings for copying or PhotoCapture Center™.

#### 7 **Color Print key:**

##### **Ink**

Lets you clean the print heads, replace an ink cartridge and check the available ink volume.

#### 8 **Scan key:**

##### **Scan to**

Lets you scan the next original and select the destination in your computer. (Such as a Word processing, graphics or E-mail application, Media card or on a Network.)

#### 9 **Liquid Crystal Display (LCD)**

Displays messages on the screen to help you set up and use your MFC.

## Turning the MFC on and off

---

When the MFC is idle, you can turn it on and off by pressing the **ON/OFF** key. In OFF mode, the MFC will send delayed faxes that have been set up and can still receive faxes in **FAX ONLY** mode. You can even retrieve faxes using remote retrieval if you are away from your MFC. If you want to do other operations, you must turn the machine back on.

### Turning the MFC off

Press and hold down the **ON/OFF** key until the LCD shows:

The LCD and scanner light will go off.

SHUTTING DOWN
PLAIN 01

### Turning the MFC on

Press and hold down the **ON/OFF** key until the LCD shows:

The LCD will show the date and time (standby mode).

PLEASE WAIT
-------------



Even if you turned the MFC off, it will periodically clean the print head to preserve print quality.

If you unplug the AC power cord, no MFC operations will be available.

# About fax machines

If you've never used an MFC before, it might seem a little mysterious. But you'll soon recognize the unusual fax tones on your phone line, and be able to send and receive faxes easily.

## Custom features

---

### Do you have Voice Mail on the phone line?

If you have Voice Mail on the phone line where you will install your new MFC, *there is a strong possibility that Voice Mail and the MFC may conflict with each other while receiving incoming calls.*

### Why should there be problems?

Since both the MFC and Voice Mail will pick up the call, after the number of rings you have set, each of them has the ability to keep the other from receiving calls.

For example, if your Voice Mail is set to answer after two rings and your MFC is set to answer after four, your Voice Mail will stop your MFC from receiving faxes.

If you set Voice Mail and the Brother MFC to answer at the same number of rings, there is no way of knowing which one will answer first. It is important to remember that neither Voice Mail nor the MFC can pass the call back to the other after the call has been answered.

### How can you avoid possible problems?

A very good way to avoid problems like the one mentioned, *is to get a second phone number on your present phone line.*

Many people with Voice Mail choose this service, which is called "Distinctive Ring", and they are very satisfied with it. *For details about this type of custom service, please see Distinctive Ring on page 5-9.*

Another way to avoid possible problems is to replace your Voice Mail with an answering machine. Your Brother MFC is designed to work with an answering machine or TAD (telephone answering device).

*(See Connecting an External Telephone Answering Device (TAD) on page 1-8.)*

## Fax tones and handshake

---

When someone is sending a fax, the MFC sends fax calling tones (CNG tones). These are quiet, intermittent beeps every 4-seconds. You'll hear them after you dial and press **Fax Start**, and they will continue for about 60 seconds after dialing. During that time, the sending machine must begin the "handshake" with the receiving machine.

Each time you use automatic procedures to send a fax, you are sending CNG tones over the phone line. You'll soon learn to listen for these quiet beeps each time you answer a phone on your fax line, so you will know if you are receiving a fax message.

The receiving fax responds with fax receiving tones, which are loud, chirping sounds. A receiving fax chirps for about 40 seconds over the phone line, and the LCD shows `RECEIVING`.

If your MFC is set to the FAX mode, it will answer every call automatically with fax receiving tones. If the other person hangs up, your MFC will continue to send the "chirps" for about 40 seconds, and the LCD continues to show `RECEIVING`. To cancel the receiving mode. Press **Stop/Exit**.

The fax 'handshake' is the time in which the sending machine's CNG tones and the receiving machines "chirps" overlap. This must be for at least 2 to 4 seconds, so the machines can understand how each is sending and receiving the fax. The handshake cannot begin until the call is answered, and the CNG tones only last for about 60 seconds after the number is dialed. So it is important for the receiving machine to answer the call in as few rings as possible.



When you have an external Telephone Answering Device (TAD) on your fax line, your TAD will decide the number of rings before the call is answered.

Pay special attention to the directions for connecting a TAD in this chapter. (See *Connecting an External Telephone Answering Device (TAD)* on page 1-8.)

## ECM (Error Correction Mode)

---

The Error Correction Mode (ECM) is a way for the MFC to check a fax transmission while it is in progress. ECM transmissions are only possible between machines that both have this feature. If they do, you may send and receive fax messages that are continuously being checked by the machine.

Your MFC must have enough memory for this feature to work.

## Connecting the MFC

### Connecting an External Telephone

---

Although your MFC does not have a handset, you can connect a separate telephone (or telephone answering device) directly to your MFC.

Connect the modular plug on the telephone's line cord to the jack labeled EXT. on the left side of the MFC.

Whenever this phone (or TAD) is in use, the LCD shows **TELEPHONE**.

### Connecting an External Telephone Answering Device (TAD)

---

#### Sequence

You may choose to connect an answering system. However, when you have an **external** TAD on the same telephone line as the MFC, the TAD answers all calls and the MFC "listens" for fax calling (CNG) tones. If it hears them, the MFC takes over the call and receives the fax. If it doesn't hear CNG tones, the MFC lets the TAD continue playing your outgoing message so your caller can leave you a voice message.

The TAD must answer within five rings (the recommended setting is two rings). The MFC cannot hear CNG tones until the TAD has answered the call, and with five rings there are only 8 to 10 seconds of CNG tones left for the fax "handshake". Make sure you carefully follow the instructions in this manual for recording your outgoing message. We do not recommend using the toll saver feature on your external answering machine if it exceeds five rings.



 If you do not receive all your faxes, you must reset the setting on your external TAD to four rings.

 *If You Subscribe to your Telephone Company's Distinctive Ring Service:*

You may connect an external TAD to a separate wall jack only if you subscribe to your telephone company's Distinctive Ring service, have registered the distinctive ring pattern on your MFC, use that number as a fax number and set your machine's Receive mode to MANUAL. The recommended setting is three or four rings on the external TAD when you have the telephone company's Distinctive Ring Service.

 *If You Do Not Subscribe to Distinctive Ring Service:*

You must plug your TAD into the EXT. jack of your MFC. If your TAD is plugged into a wall jack, both your machine and the TAD will try to control the phone line. (See illustration below.)

 **Do not connect a TAD elsewhere on the same phone line** (unless you have the Distinctive Ring service).

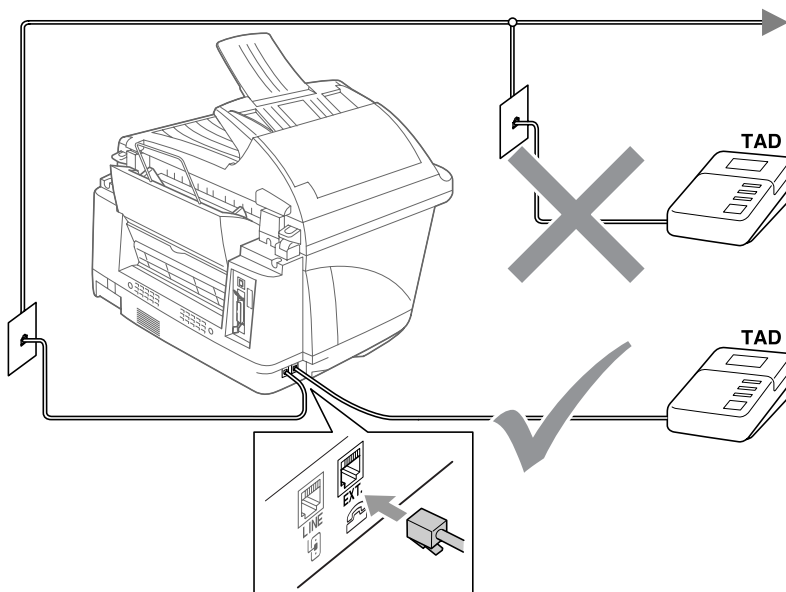

## Connections

The external TAD must be plugged into the back side of the MFC, into the jack labeled EXT. Your MFC cannot work properly if you plug the TAD into a wall jack (unless you are using Distinctive Ring).

- 1** Plug the telephone line cord from the wall jack into the back side of the MFC, in the jack labeled LINE.
- 2** Plug the telephone line cord from your external TAD into the back side of the MFC, in the jack labeled EXT. (Make sure this cord is connected to the TAD at the TAD's telephone line jack, and not its telephone set jack.)
- 3** Set your external TAD to four rings or less. (The MFC's Ring Delay setting does not apply.)
- 4** Record the outgoing message on your external TAD.
- 5** Set the TAD to answer calls.
- 6** Set the Receive Mode to `EXTERNAL TAD`.  
(See *Choosing the Receive Mode* on page 5-1.)

## Recording Outgoing Message (OGM)

Timing is important in recording this message. The message sets up the ways to handle both manual and automatic fax reception.

- 1** Record 5 seconds of silence at the beginning of your message. (This allows your MFC time to listen for the fax CNG tones of automatic transmissions before they stop.)
- 2** Limit your speaking to 20 seconds.
- 3** End your 20-second message by giving your Fax Receive Code for people sending manual faxes. For example:  
*"After the beep, leave a message or send a fax by pressing \* 51 and Start."*



We recommend beginning your OGM with an initial 5-second silence because the MFC cannot hear fax tones over a resonant or loud voice. You may try omitting this pause, but if your MFC has trouble receiving, then you must rerecord the OGM to include it.

# Special Line Considerations

---

## Roll Over Phone Lines

A roll over phone system is a group of two or more separate telephone lines that pass incoming calls to each other if they are busy. The calls are usually passed down or “rolled over” to the next available phone line in a preset order. Your MFC can work in a roll over system as long as it is the last number in the sequence, so the call cannot roll away. Do not put the MFC on any of the other numbers; when the other lines are busy and a second fax call is received, the fax call would be transferred to a line that does not have a fax machine. **Your MFC will work best on a dedicated line.**

## Two-Line Phone System

A two-line phone system is nothing more than two separate phone numbers on the same wall outlet. The two phone numbers can be on separate jacks (RJ11) or combined into one jack (RJ14). Your MFC must be plugged into an RJ11 jack. RJ11 and RJ14 jacks may be equal in size and appearance and both may contain four wires (black, red, green, yellow). To test the type of jack, plug in a two-line phone and see if it can access both lines. If it can, you must separate the line for your MFC. (See *Easy Receive* on page 5-4.)

## Converting Telephone Wall Outlets

There are three ways to convert to an RJ11 jack. The first two ways may require assistance from the telephone company. You can change the wall outlets from one RJ14 jack to two RJ11 jacks. Or, you can have an RJ11 wall outlet installed and slave or jump one of the phone numbers to it.

The third way is the easiest: Buy a triplex adapter. You can plug a triplex adapter into an RJ14 outlet. It separates the wires into two separate RJ11 jacks (Line 1, Line 2) and a third RJ14 jack (Lines 1 and 2). If your MFC is on Line 1, plug the MFC into L1 of the triplex adapter. If your MFC is on Line 2, plug it into L2 of the triple adapter.

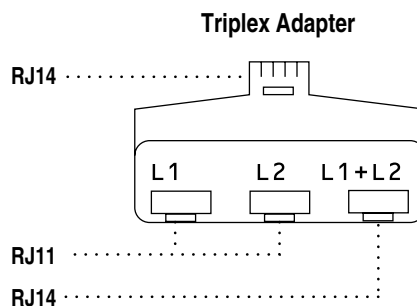

## Installing MFC, External Two-Line TAD and Two-Line Telephone

When you are installing an external two-line telephone answering device (TAD) and a two-line telephone, your MFC must be isolated on one line at both the wall jack and at the TAD. The most common connection is to put the MFC on Line 2, which is explained in the following steps. The back of the two-line TAD must have two telephone jacks: one labeled L1 or L1/L2, and the other labeled L2. You will need at least three telephone line cords, the one that came with your MFC and two for your external two-line TAD. You will need a fourth line cord if you add a two-line telephone.

- 1** Place the two-line TAD and the two-line telephone next to your MFC.
- 2** Plug one end of the telephone line cord for your MFC into the L2 jack of the triplex adapter. Plug the other end into the LINE jack on the left side of the MFC.
- 3** Plug one end of the first telephone line cord for your TAD into the L1 jack of the triplex adapter. Plug the other end into the L1 or L1/L2 jack of the two-line TAD.
- 4** Plug one end of the second telephone line cord for your TAD into the L2 jack of the two-line TAD. Plug the other end into the EXT. jack on the left side of the MFC.

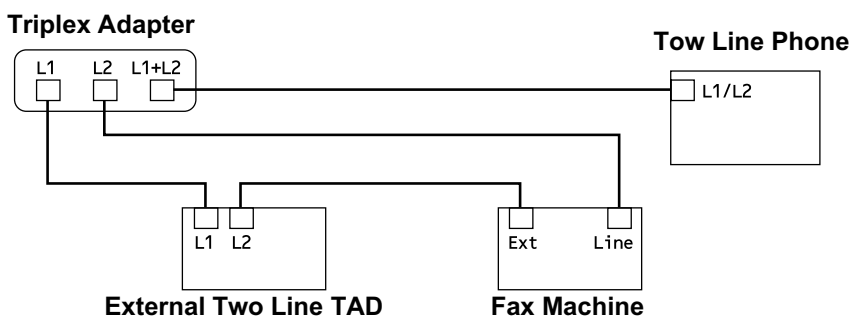

You can keep two-line telephones on other wall outlets as always. There are two ways to add a two-line telephone to the MFC's wall outlet. You can plug the telephone line cord from the two-line telephone into the L1+L2 jack of the triplex adapter. Or, you can plug the two-line telephone into the TEL jack of the two-line TAD.

## Multi-Line Connections (PBX)

---

Most offices use a central telephone system. While it is often relatively simple to connect the machine to a key system or a PBX (Private Branch Exchange), we suggest that you contact the company that installed your telephone system and ask them to connect the MFC for you. It is advisable to have a separate line for the MFC. You can then leave the MFC in FAX mode to receive faxes any time of day or night.

If the MFC is to be connected to a multi-line system, ask your installer to connect the unit to the last line on the system. This prevents the unit from being activated each time a telephone call is received.

- ⊘ As with all fax units, this machine must be connected to a two wire system. If your line has more than two wires, proper connection of the MFC cannot be made.

### If you are Installing the MFC to Work with a PBX

- 1 It is not guaranteed that the unit will operate correctly under all circumstances with a PBX. Any cases of difficulty should be reported first to the company that handles your PBX.
- 2 If all incoming calls will be answered by a switchboard operator, it is recommended that the Receive Mode be set to MANUAL. All incoming calls should initially be regarded as telephone calls.
- 3 The MFC may be used with either pulse or tone dialing telephone service.

## Custom Features on Your Phone Line

---

If you have Voice Mail, Call Waiting, Caller ID, Caller Waiting/Caller ID, RingMaster, an answering service, an alarm system or other custom feature on one phone line it may create a problem with the operation of your MFC. (See *Custom features on a single line*, page 21-8.)

# 2 Paper

## About paper

The print quality of your document can be affected by the kind of paper you use in the machine.

To ensure the best print quality for the settings you've chosen, always set the Paper Type to match the type of paper you load.

You can use plain paper, inkjet paper (coated paper), glossy paper, transparencies and envelopes.

We recommend testing various paper types before purchasing large quantities.

For best results, use the recommended paper.



When you print on inkjet paper (coated paper), transparencies and glossy paper, be sure to select the proper media in the “Basic” tab in the printer driver.

Also avoid stacking by removing each page after it exits the machine to avoid smudging.

## Handling and using special paper

---

- Store paper in its original packaging, and keep it sealed. Keep the paper flat and away from moisture, direct sunlight and heat.
- The coated side of glossy paper is shiny. Avoid touching the shiny (coated) side. Load glossy paper with the shiny side facing up toward you.
- Avoid touching either side of transparencies, because they absorb water and perspiration easily, and this may cause decreased output quality. Transparencies designed for laser printers/copiers may stain your next document. Use only recommended transparencies.

## Recommended paper

Plain Paper:	Xerox 4200
Inkjet Paper:	KODAK® Premium Inkjet Paper (Matte)
Glossy Paper:	JETPRINT PHOTO® Graphic image paper - Gloss Finish
Transparencies:	3M Transparency Film (CG3410)



The output quality depends on the paper type and paper brand. Visit us at <http://solutions.brother.com> and check the latest recommendations for paper that can be used with the MFC-5200C.

## Paper capacity of the Paper Tray

Paper Type	Paper Size	Number of sheets
Plain Paper (Cut Sheet)	Letter, Executive	100 of 20 lb (80 g/m <sup>2</sup> )
	Legal	50 of 20 lb (80 g/m <sup>2</sup> )
Inkjet Paper	Letter	20
Glossy Paper	Letter	20
Transparencies	Letter	10
Envelopes	DL, COM-10, C5, Monarch	10
Postcard	4" × 6"	30
Index Card	5" × 8"	30

## Paper specifications for the Paper Tray

Cut Sheet Paper Weight	Plain Paper / Inkjet Paper: 17 to 32 lb (64 to 120 g/m <sup>2</sup> ) Glossy Paper: Up to 40 lb (150 g/m <sup>2</sup> ) Post card: Up to 45 lb (170 g/m <sup>2</sup> ) Index card: Up to 32 lb (120 g/m <sup>2</sup> )
Thickness	Plain Paper / Inkjet Paper: 0.003 to 0.006 in. (0.08 to 0.15 mm) Glossy Paper: Up to 0.007 in. (0.18 mm) Envelopes: Up to 0.02 in. (0.52mm) Post card: Up to 0.009 in. (0.23 mm) Index card: Up to 0.006 in. (0.15 mm)
Paper Tray	Up to 0.39 in. (10 mm) Up to 100 sheets of 20 lb (80 g/m <sup>2</sup> )
Output Paper Support	Up to 50 sheets of 20 lb (80 g/m <sup>2</sup> ) (Transparencies and glossy paper must be picked up from the output paper support one page at a time to avoid smudging.)

## Paper specifications for the manual feed slot

Paper Width	3.5 to 8.5 in. (89 to 216 mm)
Paper Length	4 to 14 in. (101 to 356 mm)
Paper Thickness	0.005 to 0.01 in. (0.12 to 0.25 mm) Post card: 0.009 to 0.018 in. (0.23 to 0.45 mm)



You have to remove paper from the paper tray and load one sheet at a time.



⊘ Do not use paper or envelopes:

- that are damaged, curled, wrinkled, or irregularly shaped
- that are extremely shiny or highly textured
- that were previously printed by a laser printer
- that cannot be arranged uniformly when stacked
- that are made with a short grain

⊘ Do not use envelopes:

- that are of a baggy construction
- that are embossed (have raised writing on them)
- that have clasps on them
- that are not sharply creased
- that are preprinted on the inside

# Printable area

The printable area depends on the settings in the application you are using. The figures below show the unprintable areas on cut sheet paper and envelopes.

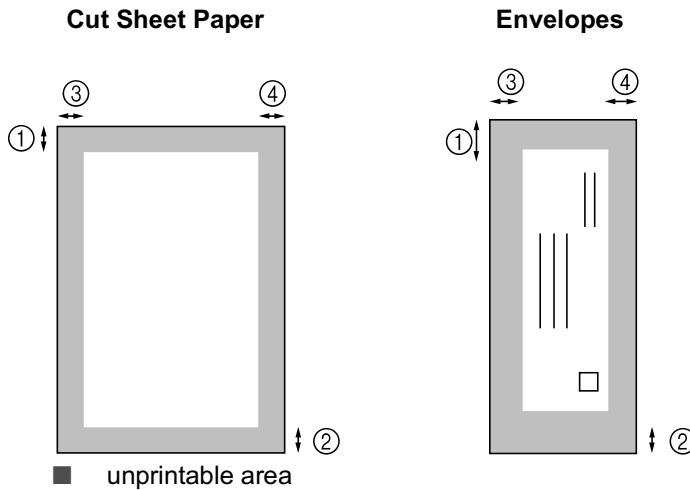

Paper	Paper Size		①Top	②Bottom	③Left	④Right
Cut Sheet	Letter, Legal	Fax	0.12	0.47	0.25	0.25
		Printer	0.12	0.47 (0.12)* <sup>1</sup>	0.23	0.23
		Copy	0.12	0.47 (0.12)* <sup>1</sup>	0.23 (0.12)* <sup>1</sup>	0.23 (0.12)* <sup>1</sup>
	Executive	Printer	0.12	0.47 (0.12)* <sup>1</sup>	0.12	0.12
Post Card	4" × 6"	Printer	0.12	0.47 (0.12)* <sup>1</sup>	0.12	0.12
Envelopes	DL, C5, COM10, Monarch	Printer	0.39	0.79	0.12	0.12



Printer depends on the Printer driver.

The figures above are approximate and the printable area may vary depending on the type of cut sheet paper you are using.

\*1 When you set the Near Edge feature to ON.

# 3

## On-Screen Programming

### User-friendly programming

Your MFC is designed to be easy to use with LCD on-screen programming using the navigation keys. User-friendly programming helps you take full advantage of all the menu selections your MFC has to offer.

Since your programming is done on the LCD, we have created step-by-step on-screen instructions to help you program your MFC. All you need to do is follow the instructions as they guide you through the menu selections and programming options.

### Menu table

---

You can probably program your machine without the User's Guide. But to help you understand the menu selections, and options that are found in the MFC programs, use the Menu table on page 3-3.



You can program your MFC by pressing **Menu/Set** followed by the menu numbers.

For example to set FAX RESOLUTION to FINE:

Press **Menu/Set**, **2**, **2**, **2** and  or  to select FINE.

Press **Menu/Set**.

# Navigation keys

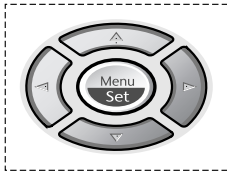

- \* Access the menu
- \* Go to the next menu level
- \* Accept an option



- \* Scroll through the current menu level



- \* Go back to the previous menu level



- \* Go forward to the next menu level



- \* Exit the menu

You can access the menu mode by pressing **Menu/Set**. When you enter the menu, the LCD scrolls.

Press **1** for General Setup menu

—OR—

Press **2** for Fax menu

—OR—

Press **3** for Copy menu

—OR—

Press **4** for PhotoCapture menu

—OR—

Press **5** for Test Print menu

—OR—

Press **6** for Print Reports menu

—OR—

SELECT ↑ ↓ & SET  
1 . GENERAL SETUP



SELECT ↑ ↓ & SET  
2 . FAX

SELECT ↑ ↓ & SET  
3 . COPY



SELECT ↑ ↓ & SET  
4 . PHOTOCAPTURE

SELECT ↑ ↓ & SET  
5 . TEST PRINT

SELECT ↑ ↓ & SET  
6 . PRINT REPORTS

You can scroll more quickly through each menu level by pressing  or , and then set an option by pressing **Menu/Set** when that option appears on the LCD.

Then the LCD shows the next menu level.

Press  or  to scroll to your next menu selection.

Press **Menu/Set**.

When you finish setting an option, the LCD shows ACCEPTED.



Use  to scroll backward if you passed your choices or want to save keystrokes.

The current setting is always the option without a “?”.

To access the menu, press  **Menu/Set**.

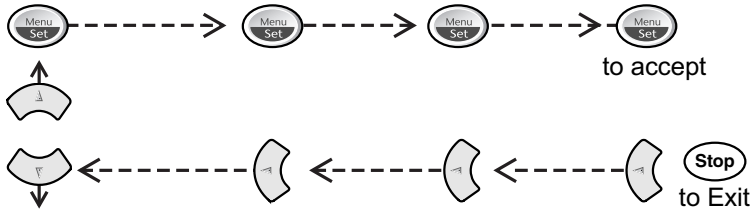

Main Menu	Submenu	Menu Selections	Options	Descriptions	Page	
<b>1.GENERAL SETUP</b>	<b>1.PAPER TYPE</b>	—	<b>PLAIN</b> INKJET GLOSSY (4-COLOR or 3-COLOR) TRANSPARENCY	Sets the type of paper in the paper tray.	4-1	
	<b>2.PAPER SIZE</b>	—	<b>LETTER</b> LEGAL	Sets the size of paper in the paper.	4-2	
	<b>3.DATE/TIME</b>	—	—	Puts the date and time on the LCD and in headings of faxes you send.	4-2	
	<b>4.STATION ID</b>	—	—	Program your name, fax and telephone number to appear on each page sent.	4-3	
	<b>5.VOLUME</b>	<b>1.RING</b>		HIGH MED <b>LOW</b> OFF	Adjusts the ring volume.	4-5
		<b>2.BEEPER</b>		HIGH MED <b>LOW</b> OFF	Adjusts the volume level of the beeper.	4-6
		<b>3.SPEAKER</b>		HIGH MED <b>LOW</b> OFF	Adjusts the speaker volume.	4-6
	<b>6.AUTO DAYLIGHT</b>	—		ON  <b>OFF</b>	Changes for Daylight Savings Time automatically.	4-7
	<b>7.TONE/PULSE</b>	—		<b>TONE</b> PULSE	Selects the dialing mode.	4-7



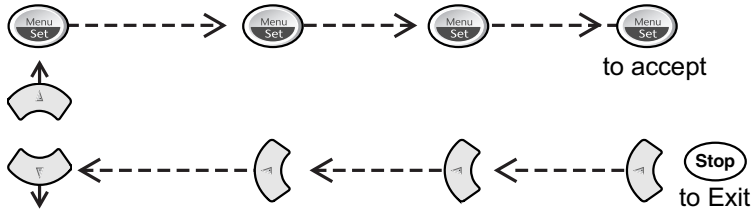

The factory settings are shown in **Bold**.

To access the menu, press  **Menu/Set**.



Main Menu	Submenu	Menu Selections	Options	Descriptions	Page
<b>1.GENERAL SETUP (Continued)</b>	<b>8.LOCAL LANGUAGE (Canada Only)</b>	—	<b>ENGLISH</b> FRENCH	Allows you to change the LCD Language for your country.	See French User's Guide
<b>2.FAX</b>	<b>1.SETUP RECEIVE</b>	<b>1.RING DELAY</b>	<b>04</b> 03 02 01 00	Sets the number of rings before the MFC answers in FAX or FAX/TEL mode.	5-2
		<b>2.F/T RING TIME</b>	70 40 30 <b>20</b>	Sets the pseudo/double-ring time in FAX/TEL mode.	5-3
		<b>3.EASY RECEIVE</b>	<b>ON</b> OFF	Receives fax messages without pressing the Fax Start key.	5-4
		<b>4.REMOTE CODE</b>	<b>ON</b> (* 51, #51)  OFF	You can answer all calls at an extension or external phone and use codes to turn the MFC on or off. You can personalize these codes.	5-6
		<b>5.AUTO REDUCTION</b>	<b>ON</b>  OFF	Reduces the size of the incoming faxes.	5-4
		<b>6.POLLING RX</b>	<b>ON</b>  <b>OFF</b>	Sets up your MFC to poll another fax machine.	5-7
	<b>2.SETUP SEND</b>	<b>1.CONTRAST</b>	<b>AUTO</b>  S.LIGHT  S.DARK	Changes the lightness or darkness of a fax you are sending.	6-5

 The factory settings are shown in Bold.

To access the menu, press  **Menu/Set**.

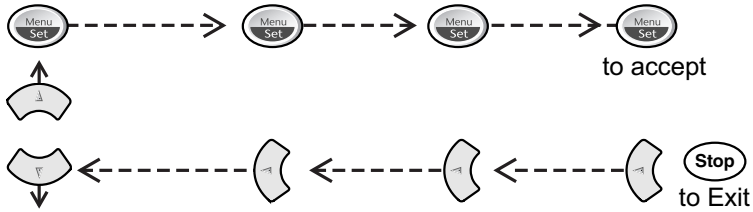

Main Menu	Submenu	Menu Selections	Options	Descriptions	Page
<b>2.FAX</b> (Continued)	<b>2.SETUP SEND</b> (Continued)	<b>2.FAX RESOLUTION</b>	<b>STANDARD</b> FINE S. FINE PHOTO COLOR STD COLOR FINE	Sets the default resolution for outgoing faxes.	6-6
		<b>3.DELAYED FAX</b>	—	Sets the time of day that the delayed faxes will be sent.	6-15
		<b>4.BATCH TX</b>	ON  OFF	Sends all delayed faxes that are to the same fax number at the same time of day as one transmission.	6-16
		<b>5.REAL TIME TX</b>	OFF ON NEXT FAX ONLY	You can send a fax without using the memory.	6-9
		<b>6.POLLED TX</b>	ON  OFF	Sets up your MFC with a document to be retrieved by another fax machine.	6-16
		<b>7.COVERPG SETUP</b>	NEXT FAX ONLY ON OFF PRINT SAMPLE	Automatically sends a Cover Page you have programmed.	6-14
		<b>8.COVERPAGE MSG</b>	—	You can set up your own comments for fax Cover Page.	6-12
		<b>9.OVERSEAS MODE</b>	ON  OFF	Adjusts for overseas transmissions, which can sometimes cause problems.	6-15

 The factory settings are shown in Bold.

To access the menu, press  **Menu/Set**.

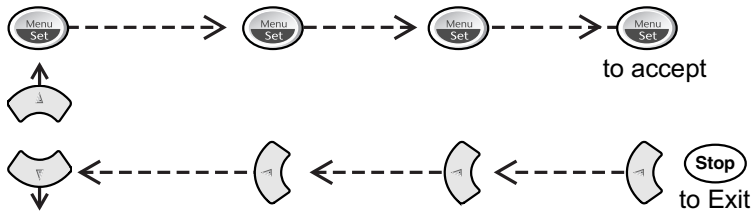

Main Menu	Submenu	Menu Selections	Options	Descriptions	Page
<b>2.FAX (Continued)</b>	<b>3.SET AUTO DIAL</b>	<b>1.SPEED-DIAL</b>	—	Stores Speed Dial numbers, so you can dial by pressing only a few keys.	7-1
		<b>2.SETUP GROUPS</b>	—	Sets up a Group number for Broadcasting.	7-3
	<b>4.SETUP REPORTS</b>	<b>1.TRANSMIS SION</b>	<b>ON</b> <b>ON+IMAGE</b> <b>OFF</b> <b>OFF+IMAGE</b>	Initial setup for Transmission Verification Report and Activity Report.	9-1
		<b>2.ACT. INTERVAL</b>	<b>EVERY 7 DAYS</b> <b>EVERY 2 DAYS</b> <b>EVERY 24 HOURS</b> <b>EVERY 12 HOURS</b> <b>EVERY 6 HOURS</b> <b>EVERY 50 FAXES</b> <b>OFF</b>		9-1
	<b>5.REMOTE FAX OPT</b>	<b>1.FAX FWD/PAGING</b>	<b>OFF</b> <b>FAX FORWARD</b> <b>PAGING</b>	Sets the MFC to forward fax messages or to call your pager.	8-1
		<b>2.FAX STORAGE</b>	<b>ON</b>  <b>OFF</b>	Stores incoming faxes in the memory so you can retrieve them while you are away from your machine.	8-3
		<b>3.REMOTE ACCESS</b>	<b>159 *</b>	You can set your own code for remote retrieval.	8-4
		<b>4.PRINT FAX (Backup Print)</b>	—	Prints incoming faxes stored in the memory.	5-6
	<b>6.REMAINING JOBS</b>	—	—	Checks which jobs are in the memory or cancels a delayed fax or polling job.	5-8 6-10

 The factory settings are shown in **Bold**.



To access the menu, press  **Menu/Set**.

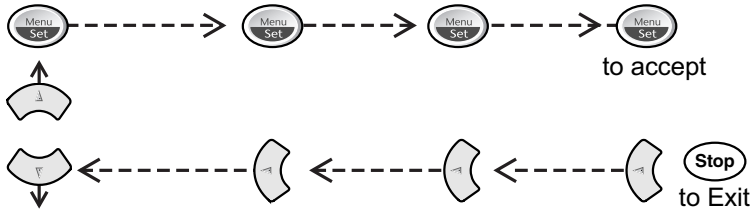

Main Menu	Submenu	Menu Selections	Options	Descriptions	Page
<b>2.FAX (Continued)</b>	<b>0.TEL SERVICE (DISTINCTIVE)</b>		<b>OFF</b>  SET (ON)	Uses the Telephone Company's Distinctive Ring subscriber service to register the ring pattern with the MFC.	5-11
<b>3.COPY</b>	<b>1.QUALITY</b>	—	<b>NORMAL</b>  BEST  FAST	Selects the copy quality.	10-16
	<b>2.NEAR EDGE</b>	—	<b>ON</b>  OFF	Expands the printable area on the left, right and bottom edges of the paper up to 0.12 in. (3 mm).	10-16
	<b>3.BRIGHTNESS</b>	—	- ■■■■ + - ■■■■ + - ■■■■ + - ■■■■ + - ■■■■ +	Adjusts the brightness	10-16
	<b>4.CONTRAST</b>	—	- ■■■■ + - ■■■■ + - ■■■■ + - ■■■■ + - ■■■■ +	Adjusts the contrast.	10-16
	<b>5.COLOR ADJUST</b>	<b>1.RED</b>	R: - ■■■■ + R: - ■■■■ + R: - ■■■■ + R: - ■■■■ + R: - ■■■■ +	Adjusts the amount of Red in copies.	10-17
	<b>2.GREEN</b>	G: - ■■■■ + G: - ■■■■ + G: - ■■■■ + G: - ■■■■ + G: - ■■■■ +	Adjusts the amount of Green in copies.		
	<b>3.BLUE</b>	B: - ■■■■ + B: - ■■■■ + B: - ■■■■ + B: - ■■■■ + B: - ■■■■ +	Adjusts the amount of Blue in copies.		

 The factory settings are shown in Bold.

To access the menu, press  **Menu/Set**.

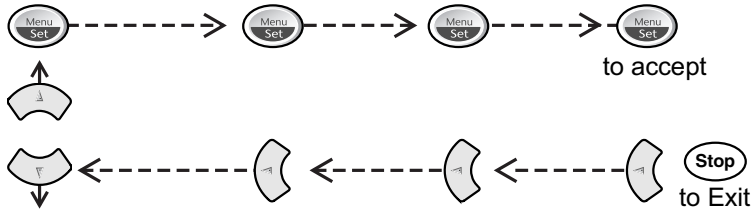

Main Menu	Submenu	Menu Selections	Options	Descriptions	Page
4. PHOTOCAPTURE	1. <b>PRINT QUALITY</b>	—	NORMAL <b>FINE</b> PHOTO	Selects the print quality.	11-15
	2. <b>PRINT SIZE</b>	—	5" × 3.5" <b>6" × 4"</b> 7" × 5" 8" × 10"	Selects the print size	11-15
	3. <b>BRIGHTNESS</b>	—	- ■■■■ + - ■■■□ + - ■■□□ + - ■□□□ + - □□□□ +	Adjusts the brightness.	11-15
	4. <b>CONTRAST</b>	—	- ■■■■ + - ■■■□ + - ■■□□ + - ■□□□ + - □□□□ +	Adjusts the contrast.	11-15
	5. <b>TRUE2LIFE</b>	ON  OFF	1. <b>WHITE BALANCE</b> - ■■■■ + - ■■■□ + - ■■□□ + - ■□□□ + - □□□□ +	Adjusts the hue of the white areas.	11-16
				2. <b>SHARPNESS</b> - ■■■■ + - ■■■□ + - ■■□□ + - ■□□□ + - □□□□ +	
3. <b>COLOR DENSITY</b> - ■■■■ + - ■■■□ + - ■■□□ + - ■□□□ + - □□□□ +				Adjusts the total amount of color in the image.	
6. <b>SCAN TO CARD</b>	—	<b>PDF</b> JPEG	Selects the default file format for color scanning.	15-17	

 The factory settings are shown in Bold.

To access the menu, press  **Menu/Set**.

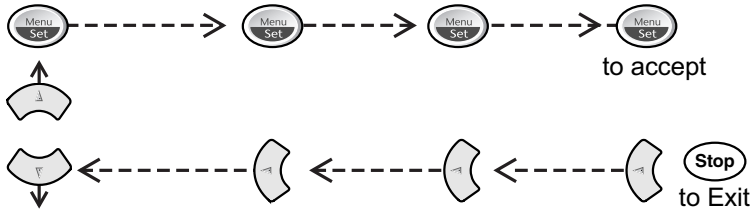

Main Menu	Submenu	Menu Selections	Options	Descriptions	Page
<b>5.TEST PRINT</b>	—	—	—	You can print a test sample page to check the print quality and adjust the Vertical Alignment.	21-10
<b>6.PRINT REPORTS</b>	<b>1.HELP LIST</b>	—	—	You can print lists & reports.	9-3
	<b>2.AUTO DIAL</b>	—	—		
	<b>3.FAX ACTIVITY</b>	—	—		
	<b>4.TRANSMISSION</b>	—	—		
	<b>5.USER SETTINGS</b>	—	—		



The factory settings are shown in Bold.

# 4 Initial setup



## Getting started

### Setting the Paper Type

---

Set the MFC for the type of paper you are using.

**1** Press **Menu/Set, 1, 1**.

**2** Press  or  to select PLAIN, INK JET, GLOSSY or TRANSPARENCY. Press **Menu/Set**.

GENERAL SETUP 1 . PAPER TYPE
---------------------------------

**3** If you selected GLOSSY,  or  press to select GLOSSY : 4-COLOR or GLOSSY : 3-COLOR. Press **Menu/Set**.



The print quality of black ink varies depending on the kind of glossy paper you are using. Black ink is used when you select GLOSSY : 4-COLOR. If the glossy paper you are using repels the black ink, select GLOSSY : 3-COLOR, which simulates black ink by combining the three ink colors.

**4** Press **Stop/Exit**.





The MFC ejects paper with printed surfaces face up onto the paper tray in the front of the MFC. When you use transparencies, remove each sheet immediately to prevent smudging or paper jams.

## Setting the Paper Size

---

You can use two sizes of paper for printing your faxes and copies—letter and legal. When you change the type of paper you load in the MFC, you will need to change the setting for Paper Size at the same time so your MFC can fit an incoming fax on the page.

- 1 Press **Menu/Set**, **1**, **2**.
- 2 Press  or  to select LETTER or LEGAL.  
Press **Menu/Set**.
- 3 Press **Stop/Exit**.

GENERAL SETUP 2 . PAPER SIZE
---------------------------------



For the next copy and PhotoCapture Center™ only, you can change the paper size to post card size (4" × 6").

See *Paper Size* on page 10-10 and see *Paper and Print Size* on page 11-9.

## Setting the Date and Time

---

Your MFC displays the date and time, and prints it on every fax you send. If there is a power failure, you may have to reset the date and time. All other settings will not be affected.

- 1 Press **Menu/Set**, **1**, **3**.
- 2 Enter the last two digits of the year.  
Press **Menu/Set**.
- 3 Enter two digits for the month.  
Press **Menu/Set**.  
(For example, enter 09 for September, or 10 for October.)
- 4 Enter two digits for the day.  
Press **Menu/Set**.  
(For example, enter 06).
- 5 Enter the time in 24-Hour format.  
Press **Menu/Set**.  
(For example, enter 15:25 for 3:25 P.M.)
- 6 Press **Stop/Exit**.

GENERAL SETUP 3 . DATE/TIME
--------------------------------

DATE/TIME YEAR : XX
------------------------

DATE/TIME MONTH : XX
-------------------------

DATE/TIME DAY : XX
-----------------------

DATE/TIME TIME : XX : XX
-----------------------------

The LCD now shows the date and time you set whenever the MFC is in Standby mode.

## Setting the Station ID

---

You should store your name or company name and fax and telephone number to be printed on all fax pages that you send.

**1** Press **Menu/Set**, **1**, **4**.

GENERAL SETUP  
4. STATION ID

**2** Enter your fax number (up to 20 digits).  
Press **Menu/Set**.

STATION ID  
FAX:

You must enter a fax number to continue (up to 20 digits).

**3** Enter your telephone number (up to 20 digits).  
Press **Menu/Set**.

STATION ID  
TEL:

(If your telephone number and fax number are the same, enter the same number again.)



The telephone number you enter is only used for Cover Page features.

(See *Composing the electronic Cover Page* on page 6-11.)

**4** Use the dial pad to enter your name (up to 20 characters).  
Press **Menu/Set**.

STATION ID  
NAME:

(See *Entering text* on page 4-4.)

**5** Press **Stop/Exit**.

The LCD will show the date and time.



If the Station ID has already been programmed, the LCD will ask you to press **1** to make a change or **2** to exit without changing.

## Entering text

When you are setting certain functions, such as the Station ID, you may need to type text into the MFC. Most number keys have three or four letters printed above them. The keys for 0, # and \* do not have printed letters because they are used for special characters.

By pressing the appropriate number key repeatedly, you can access the character you want.

Press Key	one time	two times	three times	four times
2	A	B	C	2
3	D	E	F	3
4	G	H	I	4
5	J	K	L	5
6	M	N	O	6
7	P	Q	R	S
8	T	U	V	8
9	W	X	Y	Z

## Inserting spaces

To enter a space, press  once between numbers and twice between characters.



## Making corrections

If you entered a letter incorrectly and want to change it, press  to move the cursor after the last correct letter. Then press **Stop/Exit**. All the letters above and to the right of the cursor will be deleted. Re-enter the correct characters. You can also back up and type over incorrect letters.

## Repeating letters

If you need to enter a character that is on the same key as the previous character, press  to move the cursor to the right.

## Special characters and symbols

Press \*, # or 0, and then press  or  to move the cursor under the special character or symbol you want. Then press **Menu/Set** to select it.

Press *	for	(space) ! " # \$ % & ' ( ) * + , - . /
Press #	for	: ; < = > ? @ [ ] ^ _
Press 0	for	É À È Ê Î Ç Ë Ò Ó

## NOTICE



The Telephone Consumer Protection Act of 1991 makes it unlawful for any person to use a computer or electronic device to send any message via a telephone fax machine unless such messages clearly contain, in a margin at the top or bottom of each transmitted page, or on the first page of the transmission, the date and time it is sent and an identification of the business or other entity or other individual sending the message and the telephone number of the sending machines or such business, other entity or individual.

In order to program this information into your fax machine, complete the steps described on page 4-3.



If you do not enter a fax number, you cannot enter any more information.



## Setting the Ring Volume

- 1 Press **Menu/Set**, **1**, **5**, **1**.
- 2 Press  or  to select (OFF, LOW, MED, or HIGH). Press **Menu/Set**.
- 3 Press **Stop/Exit**.

VOLUME  
1 . RING

—OR—

You can adjust the ring volume when your MFC is idle (not being used). You can turn the ring **OFF** or you can select the ring volume level.



Press  or  to adjust the volume level. Every time you press a key, the MFC will ring so you can hear the active setting as the LCD shows it. The volume changes with each key press. The new setting will stay until you change it again.



## Setting the Beeper Volume

---

You can set the beeper volume to LOW, MED, HIGH or OFF. The default (original) setting is LOW. When the beeper is on, the MFC beeps every time you press a key or make a mistake and when a fax is being sent or received.



- 1 Press **Menu/Set**, **1**, **5**, **2**.
- 2 Press  or  to select your option.
- 3 When the LCD shows the option you want.  
Press **Menu/Set**.
- 4 Press **Stop/Exit**.

VOLUME  
2 .BEEPER

## Setting the Speaker Volume

---

You can set the volume of the MFC's one-way speaker.

- 1 Press **Menu/Set**, **1**, **5**, **3**.
- 2 Press  or  to select  
(OFF, LOW, MED, or HIGH).  
Press **Menu/Set**.
- 3 Press **Stop/Exit**.

VOLUME  
3 .SPEAKER

—OR—

If you are using **Hook**, you can adjust the speaker volume while you are dialing. The default setting is the lowest volume.



Press  or  to adjust the volume level.

(Every time you press a key, the volume changes as the LCD shows the active setting. The new setting will stay until you change it again.)

## Turning on Automatic Daylight Savings Time

---

You can set the MFC to change automatically for Daylight Savings Time. It will reset itself forward one hour in the Spring and backward one hour in the Fall.



- 1** Press **Menu/Set, 1, 6.**
- 2** Press  or  to select ON (or OFF).  
Press **Menu/Set.**
- 3** Press **Stop/Exit.**

GENERAL SETUP 6 . AUTO DAYLIGHT
------------------------------------

## Setting Tone or Pulse dialing mode

---

Your MFC comes set for Tone dialing service (multi-frequency). If you have Pulse dialing service (rotary), you need to change the dialing mode.

- 1** Press **Menu/Set, 1, 7.**
- 2** Press  or  to select PULSE (or TONE).  
Press **Menu/Set.**
- 3** Press **Stop/Exit.**

GENERAL SETUP 7 . TONE/PULSE
---------------------------------

## Memory Storage

---

If there is a power failure, you will not lose your menu settings because they are stored permanently. Temporary settings (such as Contrast, Overseas Mode, and so on) will be lost. You may also have to reset the date and time.

# 5 Setup Receive

## Basic receiving operations

### Choosing the Receive Mode

---

There are four different Receive Modes for your MFC. You can choose the mode that best suits your needs by pressing **Receive Mode** repeatedly.

LCD	How it works	When to use it
FAX ONLY (automatic receive)	The MFC automatically answers every call as a fax.	For dedicated fax lines.
FAX/TEL* (fax and telephone)  (with an External or Extension Telephone)	The MFC controls the line and automatically answers every call. If the call is a fax it will receive the fax. If the call is not a fax it will ring (pseudo/double ring) for you to pick up the call.	Use this mode if you expect to receive lots of fax messages and few telephone calls. You cannot have an answering machine on the same line, even if it is on a separate wall jack (phone socket) on the same line. You cannot use the telephone company's Voice Mail in this mode.
EXTERNAL TAD (with an External Answering Machine)	The external answering machine (TAD) automatically answers every call. Voice messages are stored on the external TAD. Fax messages are printed.	Use this mode if you have an external answering machine on your phone line. The TAD setting works only with an external answering machine. Ring Delay and F/T Ring Time do not work in this setting.
MANUAL (manual receive)  (with an External or Extension Telephone)	You control the phone line and must answer every call yourself.	Use this mode when you are using a computer modem on the same line or if you don't receive many [BP1] fax messages. If you hear fax tones, wait until the machine takes over the call, then hang up. (See <i>Easy Receive</i> on page 5-4.)

\* In FAX/TEL mode you must set the Ring Delay and F/T Ring Time. If you have extension phones on the line, keep the Ring Delay set to 4 rings.

## To select or change your Receive Mode

Press **Receive Mode** repeatedly until your new selection appears. After three seconds the LCD shows the date and time, along with your new Receive Mode.

RECEIVE MODE  
FAX/TEL?



If you are changing the Receive Mode while in another operation, the LCD will return to that operation.

**Current Receive Mode**





FAX : FAX ONLY  
F/T : FAX/TEL  
TAD : EXTERNAL TAD  
MNL : MANUAL

## Setting the Ring Delay

The Ring Delay sets the number of times the MFC rings before it answers. If you have extension phones on the same line as the MFC or subscribe to the telephone company's Distinctive Ring service, keep the Ring Delay setting of 4.

(See *Easy Receive* on page 5-4 and *Operation from extension telephones* on page 5-5.)

- 1 Press **Menu/Set**, **2**, **1**, **1**.
- 2 Press  or  to select how many times the line rings before the MFC answers (00-04).  
Press **Menu/Set**.  
(If you select 00, the line won't ring at all.)
- 3 Press **Stop/Exit**.



SETUP RECEIVE  
1.RING DELAY

## Setting the F/T Ring Time (FAX/TEL mode only)

---

If you set the Receive Mode to FAX/TEL, you'll need to decide how long the MFC will signal you with its special pseudo/double-ring when you have a voice call. (If it's a fax call, the machine prints the fax.) This ringing happens after the initial ringing from the phone company. Only the fax machine rings (for 20, 30, 40 or 70 seconds) and no other phones on the same line will ring with the special pseudo/double-ring. However, you can answer the call on any extension phone (in a separate wall jack/phone socket) on the same line as the MFC. (See *Operation from extension telephones* on page 5-5.)

**1** Press **Menu/Set**, **2**, **1**, **2**.

**2** Press  or  to select how long the MFC will ring to alert you that you have a voice call.

Press **Menu/Set**.

**3** Press **Stop/Exit**.

SETUP RECEIVE 2.F/T RING TIME
----------------------------------



Even if the caller hangs up during the pseudo/double-ringing, the machine will continue to ring for the set time.

## Easy Receive



---

When you use this feature, you don't have to press **Fax Start** when you answer a fax call. Selecting **ON** allows the MFC to receive fax calls automatically, even if you lift the handset of an extension or external phone. When you see **RECEIVING** on the LCD or when you hear "chirps" through the handset of an extension phone connected to another wall jack (phone socket), just replace the handset and your MFC will do the rest. Selecting **OFF** means you'll have to activate the MFC yourself by lifting the handset of an external or extension phone, and then press **Fax Start** on the MFC—**OR**—by pressing \* **5 1** if you are not at your MFC. (See *Operation from extension telephones* on page 5-5.)



If this feature is set to **ON**, but your MFC doesn't connect a fax call when you lift a phone handset, press the Fax Receive code \* **5 1**.

If you send faxes from a computer on the same phone line and the MFC intercepts them, set Easy Receive to **OFF**.



- 1** Press **Menu/Set**, **2**, **1**, **3**.
- 2** Use  or  to select **ON** (or **OFF**). Press **Menu/Set**.
- 3** Press **Stop/Exit**.

SETUP RECEIVE 3.EASY RECEIVE
---------------------------------

## Printing a reduced incoming fax (Auto Reduction)

---

You can reduce the size of all incoming faxes to a fixed percentage, regardless of the size of the paper in your MFC. **ON** lets your MFC choose the level of reduction for you.

- 1** Press **Menu/Set**, **2**, **1**, **5**.
- 2** Use  or  to select **ON** (or **OFF**). Press **Menu/Set**.
- 3** Press **Stop/Exit**.

SETUP RECEIVE 5.AUTO REDUCTION
-----------------------------------



If incoming faxes show that the left and right margins have been cut off, make sure this Auto Reduction feature is **ON**.

# Advanced receiving operations

## Operation from extension telephones

---

If you answer a fax call on an extension or external telephone in the EXT. jack, you can make your MFC take the call by using the Fax Receive Code. When you press the Fax Receive Code \* 5 1, the MFC starts to receive a fax.

(See *Easy Receive* on page 5-4.)

If the MFC answers a voice call and pseudo/double-rings for you to take over, use the Telephone Answer Code # 5 1 to take the call at an extension phone. (See *Setting the F/T Ring Time (FAX/TEL mode only)* on page 5-3.)

If you answer a call at an extension or external phone and no one is on the line, you should assume that you're receiving a fax. At an extension phone, press \* 5 1, wait for fax-receiving tones (chirps), and then hang up. At an external phone, press \* 5 1 and wait for the phone to be disconnected before you hang up (the LCD shows RECEIVING). Your caller will have to press Fax Start to send the fax.

## For FAX/TEL mode only

---

When the MFC is in FAX/TEL mode, it will use the F/T Ring Time (pseudo/double-ringing) to alert you to pick up a voice call. If you're at the machine, you can lift the handset to answer.

If you're at an extension phone, you'll need to lift the handset during the F/T Ring Time and then press # 5 1 between the double rings. If no one is on the line, or if someone wants to send you a fax, send the call back to the machine by pressing \* 5 1.

## Using a cordless external handset

---

If your cordless telephone is connected to the EXT. jack of the fax machine and you typically carry the cordless handset elsewhere, it is easier to answer calls during the Ring Delay. If you let the fax machine answer first, you will have to answer using the cordless and then go to the fax machine so you can press **Hook** to transfer the call to the cordless handset.



## Changing the remote codes

---

Remote Codes might not work with some telephone systems. The preset Fax Receive Code is \* 51. The preset Telephone Answer Code is # 51.



If you are always disconnected when accessing your external TAD remotely, try changing the Fax Receive Code and Telephone Answer Code to another three-digit code (such as # # #).

- 1 Press **Menu/Set**, **2**, **1**, **4**.
- 2 Press  or  to select ON (or OFF).  
Press **Menu/Set**.
- 3 If you want to, enter a new Fax Receive Code.  
Press **Menu/Set**.
- 4 If you want to, enter a new Telephone Answer Code.  
Press **Menu/Set**.
- 5 Press **Stop/Exit**.

SETUP RECEIVE  
4 . REMOTE CODE

## Printing a fax from the memory

---

If you set Fax Storage to ON for Remote Retrieval, you can still print a fax from the memory when you are at your MFC. (See *Setting Fax Storage* on page 8-3.)

- 1 Press **Menu/Set**, **2**, **5**, **4**.
- 2 Press **Fax Start**.
- 3 After printing has finished.  
Press **Stop/Exit**.

REMOTE FAX OPT  
4 . PRINT FAX



# Polling

---

Polling is the process of retrieving faxes from another fax machine. You can use your MFC to 'poll' other machines, or you can have someone poll your MFC.



Everyone who is involved in Polling needs to set up their fax machines for Polling. When someone polls your MFC to receive a fax, they pay for the call. If you poll someone's fax machine to receive a fax, you pay for the call.



Some fax machines do not respond to the Polling feature.

## Setting up Polling Receive

Polling Receive is when you call another fax machine to receive a fax from it.



- 1 Press **Menu/Set**, **2**, **1**, **6**.
- 2 Press  or  to select ON (or OFF).  
Press **Menu/Set**.

SETUP RECEIVE  
6.POLLING RX

- 3 Enter the fax number you are polling.
- 4 Press **Fax Start**.  
The LCD shows DIALING.

## Setting up Sequential Polling Receive

Your MFC can ask for faxes from several fax units in a single operation (Sequential Polling Receive). Afterwards, a Sequential Polling Report will be printed.

- 1 Press **Menu/Set**, **2**, **1**, **6**.
- 2 Press  or  to select ON.  
Press **Menu/Set**.

SETUP RECEIVE  
6.POLLING RX

- 3 Enter the fax machines you want to poll using Speed Dial, a Group or the dial pad. You must press **Menu/Set** between each fax number.
- 4 Press **Fax Start**.  
Your MFC will poll each number or Group number in turn to receive a fax.



## Canceling a scheduled job

---

You can cancel tasks you've scheduled, such as a Delayed Fax or Polling Transmit. (See *Canceling a job in the memory* on page 6-10.)

**1** Press **Menu/Set**, **2**, **6**.

Any jobs that are waiting will appear on the LCD. If no job is waiting, the LCD shows NO JOB WAITING.

**2** If you have more than two jobs waiting, press  or  to select the job you want to cancel. Press **Menu/Set**.

FAX 6.REMAINING JOBS
-------------------------

—OR—

If you have only one job waiting, go to Step 3.

**3** Press **1** to cancel.

—OR—

Press **2** to exit without canceling.

To cancel another job, go to Step 2.

**4** Press **Stop/Exit**.

# Telephone services

Your MFC supports the Distinctive Ring telephone service that some telephone companies offer.



If you have Voice Mail, Call Waiting, Caller ID, Call Waiting/Caller ID, RingMaster, an answering service, an alarm system or other custom features on your telephone line, it may affect the way your MFC works. (See *Custom features on a single line* on page 21-8.)

If you have Voice Mail on your phone line, please read the following carefully.

## Distinctive Ring

---

Brother uses the term 'Distinctive Ring' but different telephone companies have other names for this service such as SmartRing, RingMaster, Teen-Ring, Indent-a-Call or Indent-a-Ring.

### **What does your telephone company's 'Distinctive Ring' do?**

Your telephone company's Distinctive Ring service allows you to have more than one number on the same phone line. **If you need more than one phone number, it is a cheaper way of paying for an extra line.** Each phone number has its own distinctive ring pattern, so you will know which phone number is ringing. This is one way you can have a separate phone number for your MFC.



Please call your telephone company for availability and rates.

### **What does Brother's 'Distinctive Ring' do?**

The Brother machine has a Distinctive Ring feature that allows you to use your MFC to take full advantage of the telephone company's Distinctive Ring service. The new phone number on your line can just receive faxes.



You must pay for your telephone company's Distinctive Ring service before you program the MFC to work with it.

## Do you have Voice Mail?

If you have Voice Mail on the phone line you will install your new MFC on, *there is a strong possibility that Voice Mail and the MFC will conflict with each other while receiving incoming calls.* **However, this Distinctive Ring feature allows you to use more than one number on your line, so both Voice Mail and the MFC can work together without any problems.** If each one has a separate phone number, neither will interfere with the other's operations.





If you decide to get the Distinctive Ring service from the telephone company, you will need to follow the directions below to 'register' the new Distinctive Ring pattern they give you. This is so your MFC can recognize its incoming calls.



You can change or cancel the Distinctive Ring pattern at any time. You can switch it off temporarily, and turn it back on later. When you get a new fax number, make sure you reset this feature.

## Before you choose the ring pattern to register

You can only register one Distinctive Ring pattern with the MFC. Some ring patterns cannot be registered. The ring patterns below are supported by your Brother MFC. Register the one your telephone company gives you.

Ring Pattern	Rings	
1	long-long	
2	short-long-short	
3	short-short-long	
4	very long (normal pattern)	



If the ring pattern you received is not on this chart, **please call your telephone company and ask for one that is shown.**





- The MFC will only answer calls to its registered number.
- The first two rings are silent on the fax machine. This is because the fax must «listen» to the ring pattern (to compare it to the pattern that was 'registered'). (Other telephones on the same line will ring.)
- If you program the MFC properly, it will recognize the registered ring pattern of the 'fax number' within 2 ring patterns and then answer with a fax tone. When the 'voice number' is called, the MFC will not answer.

## Very important



---

When you set the Distinctive Ring feature to ON, the receive mode is set to **MANUAL** automatically. **MANUAL** mode will never pick up a call by itself since it is <<Neutral>>. You can not change the receive mode to the other mode while the Distinctive Ring is set to on.

### Registering the Distinctive Ring pattern

- 1** Set the MFC to **MANUAL** mode.
- 2** Press **Menu/Set, 2, 0**.
- 3** Press  or  to select **SET?**.  
Press **Menu/Set**.
- 4** Press  or  to select the stored ring pattern you want to use.  
Press **Menu/Set**.  
(You will hear each pattern as you scroll through the four patterns. Make sure you choose the pattern that the telephone company gave you.)
- 5** Press **Stop/Exit**.  
Distinctive Ring is now set to on.

### Turning off the Distinctive Ring

- 1** Press **Menu/Set, 2, 0**.
- 2** Press  or  to select **OFF**.  
Press **Menu/Set**.
- 3** Press **Stop/Exit**.

# 6 Setup Send

## Before you begin

Before you can begin sending faxes, make sure you read all the instructions and cautions listed for putting originals in the Automatic Document Feeder (ADF).

## Sending faxes using multiple settings

---

When you send a fax you can choose any combination of these settings: contrast, resolution, overseas mode, delayed fax timer, polling transmission or real time transmission. After each setting is accepted, the LCD will ask if you want to enter more settings:

Press **1** to select more settings. The LCD will return to the `SETUP SEND` menu.

OTHER SETTINGS? 1 . YES 2 . NO
-----------------------------------

—**OR**—

Press **2** if you have finished choosing settings and go to the next step.

## Faxing from the automatic document feeder (ADF)

---

The ADF can hold up to 30 pages and feeds each sheet individually. Use standard (20 lb or 75 g/m<sup>2</sup>) paper and always fan the pages before putting them in the ADF.

### Recommended environment

Temperature: 68° F - 86° F (20° C - 30° C)

Humidity: 50% - 70%

Paper: Xerox 4200 (20 lb LTR)

 DO NOT use paper that is curled, wrinkled, folded, ripped, stapled, paper clipped, pasted or taped.

DO NOT use cardboard, newspaper or fabric. (To fax this kind of original, see *Faxing from the scanner glass* on page 6-4.)

- Make sure documents written with ink are completely dry.
- Originals to be faxed must be from 5.8 to 8.5 inches wide and 5.8 to 14 inches long.

- 1 Unfold the ADF Document Support.
- 2 Unfold the ADF Document Output Support Extension.
- 3 Fan the pages well and stagger them at an angle. Make sure you put the originals **face up, top edge first** in the ADF until you feel them touch the feed roller.

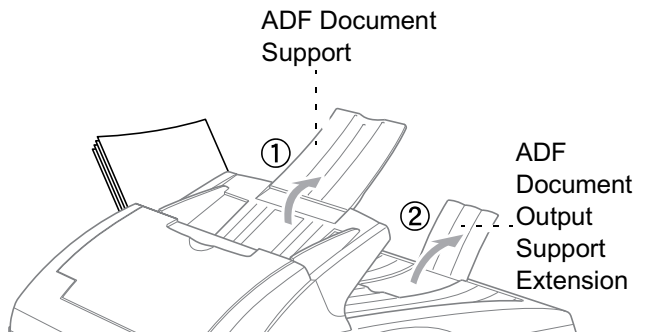

- 4 Adjust the paper guides to fit the width of your originals.

**Originals are Face Up in the ADF**

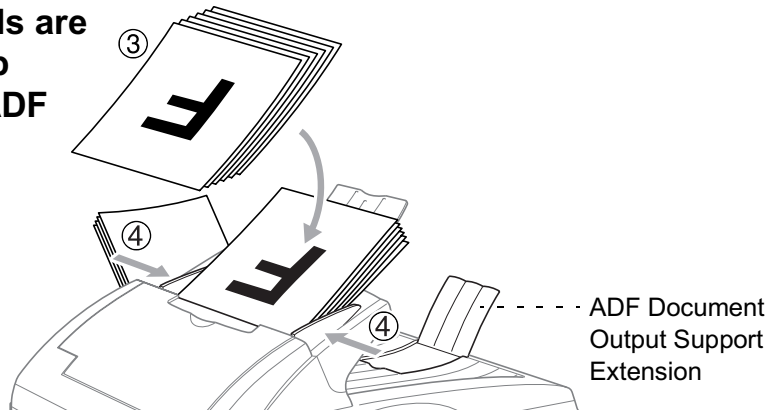

- 5 Dial the fax number. Press **Fax Start**. The MFC starts scanning the first page.

## Setting the special media lever

---

This is to feed special types of originals (such as thin paper, thick paper, coated paper or glossy paper). It will allow the originals to feed through the ADF without slipping or jamming.

Use the special media lever to select the Special position. (📄)

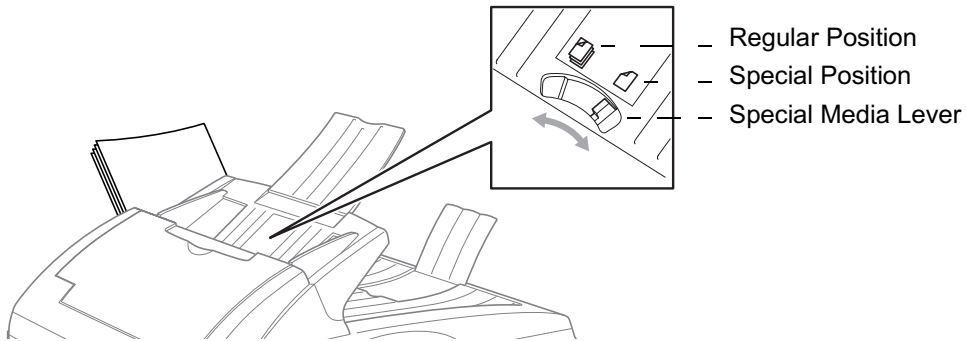

If the originals 'double-feed,' try again by inserting only one page at a time in the ADF or use the Scanner Glass.



## Faxing from the scanner glass

You can use the scanner glass to fax pages of a book or one page at a time. Originals can be letter or A4 size (8.5 inches to 11.7 inches).

 To use the scanner glass, the ADF must be empty.

- 1 Lift the document cover.
- 2 Using the document guidelines on the left, center the original face down on the scanner glass.



Originals are  
Face Down on the  
Scanner Glass

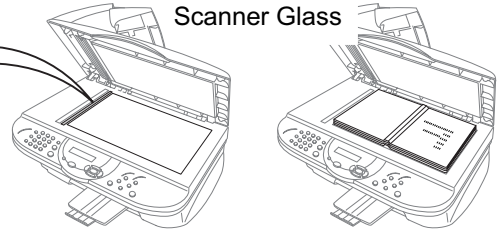

- 3 Close the document cover.

 If the original is a book or is thick, do not slam the cover or press on it.

- 4 Dial the fax number,  
Press **Fax Start**.  
The MFC starts scanning the first page.

MEMORY #001 97%
PLAIN 01

- 5 To send a single page, go to Step 7  
—OR—  
To send more than one page, go to  
Step 6.

NEXT: PRESS SET
DIAL: PRESS START

- 6 Place the next page on the scanner glass.  
Press **Menu/Set**.  
The MFC starts scanning. (Repeat this step for each additional page.)
- 7 Press Fax Start to begin dialing  
Press **Stop/Exit** to cancel.

 If the memory is full and you are faxing a single page, it will be sent in real time.

# Basic sending operations

## Contrast

---

If your original is very light or very dark, you may want to set the contrast.

Use **S.LIGHT** to send a very light document.

Use **S.DARK** to send a very dark document.

**1** Place the original face up in the ADF, or face down on the scanner glass.

SETUP SEND 1.CONTRAST
--------------------------

Press **Menu/Set, 2, 2, 1**.

**2** Press  or  to select **AUTO, S.LIGHT** or **S.DARK**.  
Press **Menu/Set**.

**3** Press **1** if you want to choose more settings and the LCD will return to the **SETUP SEND** menu

—OR—

Press **2** if you have finished choosing settings, and then go to Step 4.

**4** Enter a fax number.

**5** Press **Fax Start** to send a fax.



## Fax resolution

---

When you have an original in the ADF or on the scanner glass you can use the **Fax Resolution** key to change the setting temporarily (for this fax only). Press **Fax Resolution** repeatedly until the LCD shows the setting you want.

—OR—

You can change the default setting.

- 1** Press **Menu/Set**, **2**, **2**, **2**.
- 2** Press  or  to select the resolution you want, Press **Menu/Set**.
- 3** Press **Stop/Exit**.

SETUP SEND 2.FAX RESOLUTION
--------------------------------

- STANDARD \_\_\_\_\_ Suitable for most typed documents.
- FINE \_\_\_\_\_ Good for small print and transmits a little slower than Standard resolution.
- S. FINE \_\_\_\_\_ Good for small print or artwork and transmits slower than Fine resolution.
- PHOTO \_\_\_\_\_ Use when the original has varying shades of gray. This has the slowest transmission time.
- COLOR STD \_\_\_\_\_ Use to send the original in color.
- COLOR FINE \_\_\_\_\_ Better quality than COLOR STD. Use to send the original as Art-work or photographs in color.

## Manual transmission

---

Manual transmission lets you hear the dialing, ringing and fax-receiving tones while sending a fax.

- 1 Place the original face up in the ADF, or face down on the scanner glass.
- 2 Pick up the handset of the external phone and listen for a dial tone  
—OR—  
Press **Hook** and listen for a dial tone.
- 3 On the external phone, dial the fax number you want to call. If you pressed **Hook**, dial using the MFC dial pad.
- 4 When you hear the fax tone,  
Press **Fax Start**.
- 5 If you picked up the handset of the external phone, replace the handset.

## Automatic transmission

---

**This is the easiest way to send a fax.**

- ⊘ You must not pick up the handset of the external phone or press **Hook** to listen for a dial tone.
- 1 Place the original face up in the ADF, or face down on the scanner glass.
  - 2 Enter the fax number using the dial pad, Speed Dial or Search. (See *Speed dialing* on page 7-5.)
  - 3 Press **Fax Start**.

## Color fax transmission

---

Your MFC allows you to send a color fax.

- 1 Place the original face up in the ADF, or face down on the scanner glass.
- 2 Press **Fax Resolution** to select the **COLOR STD** or **COLOR FINE**.
- 3 Enter the fax number using the dial pad, Speed Dial or Search.
- 4 Press **Fax Start**.



When you send a color fax, the MFC will send it in real time.

## Manual and automatic fax redial

---

If you're sending a fax manually and the line is busy, press **Redial/Pause** and then press **Fax Start** to try again. If you want to make a second call to the last number you dialed, press **Redial/Pause** and then press **Fax Start** to save time.

**Redial/Pause** only works when you dial using the control panel.

*If you're sending a fax automatically* and the line is busy, the MFC will automatically redial one time five minutes after the transmission.

## Dual Access (Not available for color faxes)

---

You can place an original in the ADF and set temporary settings, dial a number, and begin scanning the fax into memory—even when the MFC is receiving, sending or printing a fax from memory. The LCD shows the new job number and available memory.



If you get a **OUT OF MEMORY** message while scanning the first page of a fax, press **Stop/Exit** to cancel scanning. If you get a **OUT OF MEMORY** message while scanning a subsequent page, you can press **Fax Start** to send the pages scanned so far, or press **Stop/Exit** to cancel the operation.

- 1** Place the original face up in the ADF, or face down on the scanner glass.
- 2** Enter the fax number.
- 3** Press **Fax Start**.

The MFC scans the original and the LCD shows the job number (#XXX) of the fax and how much memory is available. Then the MFC starts dialing. You can repeat Steps 1 to 3 for the next fax.



Your machine normally uses Dual Access. However, to send a color fax, you must use Real Time Transmission.

The Number of pages you can scan into the memory will vary depending on the data that is printed on them.

## Real Time Transmission

---

When you are sending a fax, the MFC will scan the originals into the memory before sending. Then, as soon as the phone line is free, the MFC will start dialing and sending.

If the memory becomes full, the MFC will send the original in real time (even if `REAL TIME TX` is set to `OFF`).

Sometimes, you may want to send an important original immediately, without waiting for memory transmission.

You can set `REAL TIME TX` to `ON`.

**1** Place the original face up in the ADF, or face down on the scanner glass.

**2** Press **Menu/Set**, **2**, **2**, **5**.



**3** To change the default setting, press

 or  to select `ON` (or `OFF`).

Press **Menu/Set**.

Go to Step 5

—OR—

For the next fax transmission only, press  or  to select `NEXT FAX ONLY`.

Press **Menu/Set**.

**4** Press  or  to select `ON` (or `OFF`).

Press **Menu/Set**

**5** Press **1** if you want to choose more settings and the LCD will return to the `SETUP SEND` menu

—OR—

Press **2** if you have finished choosing settings, and then go to Step 6.

**6** Enter the fax number.

Press **Fax Start**.

SETUP SEND 5.REAL TIME TX
------------------------------





If you are sending a color Fax, the MFC will send it in real time even if `REAL TIME TX` is set to `OFF`.

## Checking job status

---

Check which jobs are still waiting in the memory to be sent. (If there are no jobs, the LCD shows NO JOB WAITING.)

(See *Canceling a job in the memory* below.)



- 1 Press **Menu/Set**, **2**, **6**.
- 2 If you have more than one job waiting, press  or  to scroll through the list.
- 3 Press **Stop/Exit**.

FAX 6.REMAINING JOBS
-------------------------

## Canceling a job in the memory

---

You can cancel tasks you've scheduled, such as Polling Transmit or fax jobs waiting in the Memory to be sent. (See *Checking job status* above.)

- 1 Press **Menu/Set**, **2**, **6**.  
Any jobs that are waiting will appear on the LCD.
- 2 If you have more than two jobs waiting, press  or  to select the job you want to cancel. Press **Menu/Set**.  
—OR—  
If you only have one job waiting, go to Step 3.
- 3 Press **1** to cancel  
—OR—  
Press **2** to exit without canceling.  
To cancel another job go to Step 2.
- 4 Press **Stop/Exit**.

FAX 6.REMAINING JOBS
-------------------------

# Advanced sending operations

## Composing the electronic Cover Page

---

The Cover Page is created at the receiving machine. Your Cover Page includes the name stored in the Speed Dial memory. If you're dialing manually, the name is left blank.

The Cover Page shows your Station ID and the number of pages you're sending. (See *Setting the Station ID* on page 4-3.) If you have Cover Page set to ON (**Menu/Set, 2, 2, 7**), the number of pages is left blank.

You can select a comment to include on your Cover Page.

Instead of using one of the preset comments, you can enter two personal messages of your own, up to 27 characters long. Use the chart on page 4-4 for help entering characters. (See *Composing your own comments* on page 6-12.)

Most of the **SETUP SEND** settings are temporary to allow you to make changes for each fax you send.

However, so you can set up your Cover Page and Cover Page comments in advance, the Cover Page Setup and Cover Page Message features will change the default settings.

COVERPG SETUP  
1.COMMENT OFF

COVERPG SETUP  
2.PLEASE CALL

COVERPG SETUP  
3.URGENT

COVERPG SETUP  
4.CONFIDENTIAL

COVERPG SETUP  
5.(USER DEFIND)

COVERPG SETUP  
6.(USER DEFIND)



## Composing your own comments

You can set up two comments of your own.

**1** Press **Menu/Set**, **2**, **2**, **8**.

**2** Press  or  to choose 5 or 6 for your own comment.

SETUP SEND 8 .COVERPAGE MSG
--------------------------------

Press **Menu/Set**.

**3** Use the dial pad to enter your customized comment.

Press **Menu/Set**.

(See *Entering text* on page 4-4.)

**4** Press **1** if you want to choose more settings and the LCD will return to the SETUP SEND menu

—**OR**—

Press **2** to exit.

## Cover page for the next fax only

This feature does not work without the Station ID. So make sure it has been set. (See *Setting the Station ID* on page 4-3.)



If you only want to send a Cover Page with a particular fax, this Cover Page will include the number of pages in your document.



**1** Place the original face up in the ADF, or on the scanner glass.

SETUP SEND 7 .COVERPG SETUP
--------------------------------

**2** Press **Menu/Set, 2, 2, 7.**

**3** When LCD shows NEXT FAX ONLY.  
Press **Menu/Set.**

**4** Press  or  to select ON (or OFF).  
Press **Menu/Set.**

**5** Press  or  to select one of the standard or your own comments.  
Press **Menu/Set.**

**6** Enter two digits to show the number of pages you are sending.  
Press **Menu/Set.**

(For example, press **0, 2** for 2 pages or enter **0 0** to leave the number of pages blank. If you make a mistake, press  to back up and re-enter the number of pages.)

**7** Press **1** if you want to choose more settings and the LCD will return to the SETUP SEND menu

—OR—

Press **2** if you have finished choosing settings.

**8** Enter the fax number you're calling.



**9** Press **Fax Start.**

## Send a cover page for all faxes



This feature does not work without the Station ID. So make sure it has been set. (See *Setting the Station ID* on page 4-3.)

You can set the fax machine to send a cover page whenever you send a fax. The number of pages in your fax is not included when you use this setting.

**1** Press **Menu/Set, 2, 2, 7.**

**2** Press  or  to select ON.  
Press **Menu/Set.**

SETUP SEND  
7.COVERPG SETUP

**3** If you selected ON, Press  or  to select one of the standard or your own comments.  
Press **Menu/Set.**

**4** Press **1** if you want to choose more settings and the LCD will return to the SETUP SEND menu

—OR—

Press **2** to exit if you have finished choosing settings.

## Using a printed cover page

If you prefer to use a printed cover page that you can write on, you can print the sample page and attach it to your fax.

**1** Press **Menu/Set, 2, 2, 7.**

**2** Press  or  to select PRINT  
SAMPLE.

Press **Menu/Set.**

SETUP SEND  
7.COVERPG SETUP

**3** Press **Fax Start.** Your fax machine prints a copy of your cover page.

**4** Press **Stop/Exit.**

```
=== COVER PAGE ===  
  
TO: _____  
  
FROM: _____  
FAX: _____  
TEL: _____  
  
PAGE(S) TO FOLLOW  
  
COMMENT:
```

## Overseas Mode

---

After you send a fax using this feature, the feature will turn itself off.

- 1 Place the original face up in the ADF, or face down on the scanner glass.

SETUP SEND  
9.OVERSEAS MODE

- 2 Press **Menu/Set**, **2**, **2**, **9**.

- 3 Press  or  to select ON (or OFF). Press **Menu/Set**.

- 4 Press **1** if you want to choose more settings and the LCD will return to the SETUP SEND menu

—OR—

Press **2** if you have finished choosing settings, and then go to Step 5

- 5 Enter the fax number you're calling.

- 6 Press **Fax Start**.

## Delayed Fax (Not available for color faxes)

---

During the day you can store up to 50 faxes in the memory to be sent later on. These faxes will be sent at the time of day you enter in Step 3. Press **Menu/Set** to accept it, or enter another time for the faxes to be sent.

- 1 Place the original face up in the ADF, or face down on the scanner glass.

SETUP SEND  
3.DELAYED FAX

- 2 Press **Menu/Set**, **2**, **2**, **3**.

- 3 Enter the time you want the fax to be sent (in 24-hour format). Press **Menu/Set**.  
(For example, enter 19:45 for 7:45 PM.)

- 4 Press **1** if you want to choose more settings and the LCD will return to the SETUP SEND menu

—OR—

Press **2** if you have finished choosing settings, and then go to Step 5.

- 5 Enter the fax number.

- 6 Press **Fax Start**. The MFC will wait to send the fax at the time you set.





*The number of pages you can scan into the memory depends on the amount of data that is printed on each page.*

## Delayed Batch Transmission (Not available for color faxes)

---

Before sending the delayed faxes, your MFC will economize by sorting all the documents in the memory by destination and scheduled time. All delayed faxes that are scheduled to be sent at the same time to the same fax number will be sent as one fax.



- 1 Press **Menu/Set**, **2**, **2**, **4**.
- 2 Press  or  to select ON (or OFF).  
Press **Menu/Set**.
- 3 Press **Stop/Exit**.

SETUP SEND  
4 . BATCH TX

## Setting up Polled Transmission (Not available for color faxes)

---

Polled Transmission is when you set up your MFC to wait with an original so another fax machine can retrieve it.

- 1 Place the original that is going to be retrieved face up in the ADF, or face down on the scanner glass.
- 2 Press **Menu/Set**, **2**, **2**, **6**.
- 3 Press  or  to choose ON (or OFF).  
Press **Menu/Set**.
- 4 Press **1** if you want to choose more settings and the LCD will return to the SETUP SEND menu  
—OR—  
Press **2** if you have finished choosing settings, and go to step 5.
- 5 Press **Fax Start**.

SETUP SEND  
6 . POLLED TX

# 7 Auto Dial numbers and Dialing options

## Storing numbers for easy dialing

You can set up your MFC to do two types of easy dialing: Speed Dial and Groups for Broadcasting faxes.



*If you lose electrical power, the auto dial numbers that are in the memory will not be lost.*

## Storing Speed Dial numbers

You can store Speed Dial numbers, so that when you dial you will only have to press a few keys (**Search/Speed Dial**, **#**, the two-digit number, and **Fax Start**). The MFC can store 100 Speed Dial numbers.



(USA Only) Speed Dial number 01 has been programmed for the Brother fax back system. You can change it if you want to.

**1** Press **Menu/Set**, **2**, **3**, **1**.

```
SET AUTO DIAL
1 . SPEED-DIAL
```

**2** Use the dial pad to enter a two-digit Speed Dial number (00-99).

```
SPEED-DIAL
SPEED-DIAL? #_
```

(For example, press **0 5**.)

Press **Menu/Set**.

**3** Enter the number (up to 20 digits).

```
SPEED-DIAL
#05 : _
```

Press **Menu/Set**.

**4** Use the dial pad to enter the name (up to 15 characters).

```
SPEED-DIAL
NAME : _
```

Press **Menu/Set**.

(You can use the chart on page 4-4 to help you enter letters.)

—OR—

Press **Menu/Set** to store the number without a name.

**5** Go to Step 2 to store another Speed Dial number.

—OR—

Press **Stop/Exit**.

## Changing Speed Dial numbers

---

If you try to store a Speed Dial number where a number is already stored, the LCD will show the current name stored there and will ask you to do one of the following:



- 1 Press **1** to change the stored number  
—OR—

#05 : XXXXXXXXX
1 . CHANGE    2 . EXIT

Press **2** to exit without making a change.

- 2 Enter a new number.

Press **Menu/Set**.

- If you want to erase the whole number or whole name, press **Stop/Exit** when the cursor is to the left of the digits or letters. The characters above and to the right of the cursor will be deleted.
- If you want to change a character, use  or  to position the cursor under the character you want to change, and then type over it.

- 3 Follow the directions beginning at Step 4 in Storing Speed Dial numbers on the previous page.

## Setting up Groups for Broadcasting

Groups allow you to send the same fax message to many fax numbers by pressing only a few keys (**Search/Speed Dial**, **#**, the two-digit number, and **Fax Start**). First, you'll need to store each fax number as a Speed Dial number.

Then, you can combine them into a Group. Each Group uses up a Speed Dial number. You can have up to six Groups, or you can assign up to 99 numbers to one large Group.

(See *Storing Speed Dial numbers* on page 7-1 and *Broadcasting (Not available for color faxes)* on page 7-6.)

**1** Press **Menu/Set**, **2**, **3**, **2**.

```
SET AUTO DIAL
2.SETUP GROUPS
```

**2** Press **Search/Speed Dial**, use the dial pad to enter the two-digit Speed Dial number where you want to store the Group.

```
SETUP GROUPS
PRESS SPEED DIAL
```

```
SETUP GROUPS
SPEED-DIAL? #07
```

Press **Menu/Set**.

(For example, press **Search/Speed Dial**, **07** and **Menu/Set**.)

**3** Use the dial pad to enter the Group number.

```
SETUP GROUPS
SETUP GROUP:G01
```

Press **Menu/Set**.

(For example, press **1** for Group 1.)



The Group number must be between 1 and 6.

**4** To include Speed Dial numbers in the Group, enter them as if you were dialing.

```
SETUP GROUPS
G01:#05#09
```

(For example, for Speed Dial numbers 05 and 09. Press **Search/Speed Dial**, **05**, **Search/Speed Dial**, **09**. The LCD shows: #05#09.)

**5** Press **Menu/Set** to accept the Speed Dial numbers for this Group.

**6** Use the dial pad and the chart on page 4-3 to enter a name for the Group.

```
SETUP GROUPS
NAME:
```

Press **Menu/Set**.

(For example, type NEW CLIENTS).

**7** Press **Stop/Exit**.



 You can print a list of all the Speed Dial numbers.  
(See Chapter 9 *Printing Reports*.)

## Dialing options

 When you dial using an auto dial number, the LCD shows the name you've stored, or if you haven't stored a name, the fax number you've stored.

## Manual dialing with an external telephone

---





Manual dialing means pressing all of the digits of the phone number.

- 1 Pick up the external telephone's handset  
—OR—  
Press **Hook**.
- 2 When you hear a dial tone, dial the number using the dial pad.
- 3 If you pressed **Hook** to dial the number, pick up the handset when the other person answers.  
(The speaker only works one way so the other person won't be able to hear you unless you pick up the handset.)
- 4 To hang up, replace the external telephone's handset.

## Search

---

You can search for names you have stored in the Speed Dial memory.  
(See *Storing Speed Dial numbers* on page 7-1.)

- 1 Place the original face up in the ADF, or face down on the scanner glass.
- 2 Press **Search/Speed Dial**.
- 3 To search through the names that are stored alphabetically, enter the first letter of the name you're looking for and press  or  .  
—OR—  
To search for numbers numerically, press  or  .
- 4 When the LCD shows the name you want to call,  
Press **Fax Start**.

## Speed dialing

---

- 1** Place the original face up in the ADF, or face down on the scanner glass.
- 2** Press **Search/Speed Dial**, #, and then the two-digit Speed Dial number. (See *Storing Speed Dial numbers* on page 7-1.)
- 3** Press **Fax Start**.

## Access codes and credit card numbers

---

Sometimes you may want to choose from several long distance carriers when you make a call. Rates may vary depending on the time and destination. To take advantage of low rates, you can store the access codes or long-distance carriers and credit card numbers as Speed-Dial numbers. You can store these long dialing sequences by dividing them and setting them up on separate keys in any combination. You can even include manual dialing using the dial pad. The combined number will be dialed in the order that you entered it as soon as you press **Fax Start**.

(See *Storing Speed Dial numbers* on page 7-1.)

For example, you can store '555' on Speed Dial #03 and '7000' on Speed Dial #02. If you press **Search/Speed Dial**, **#03**, **Search/Speed Dial**, **#02**, and **Fax Start**, you will dial '555-7000'.

To temporarily change a number, you can substitute part of the number with manual dialing using the dial pad.

For example, to change the number to 555-7001 you could press **Search/Speed Dial**, **#03** and then press **7001** using the dialing pad.



If you must wait for another dial tone or signal at any point in the dialing sequence, store a pause there in the number by pressing **Redial/Pause**. Each key press adds a 3.5-second delay.

## Broadcasting (Not available for color faxes)

---

Broadcasting is when the same fax message is automatically sent to more than one fax number. Using the **Menu/Set** key, you can include Groups, Speed Dial numbers and up to 50 manually dialed numbers. If you did not use up all the numbers for Groups, access codes or credit card numbers, you can 'broadcast' faxes to up to 150 different numbers. However, the available memory will vary depending on the types of jobs in the memory and the number of locations used for broadcasting. If you broadcast to more than the maximum numbers available, you will not be able to use Dual Access and the Timer.

To include Speed Dial numbers and manually dialed numbers in the same broadcast, you must press **Menu/Set** between each of the numbers. Use **Search/Speed Dial** to help you choose the numbers easily.

(See *Setting up Groups for Broadcasting* on page 7-3.)

After the broadcast is finished, a Broadcast Report will be printed to let you know the results.

- Enter the long dialing sequence numbers as you would normally, but remember that each Speed Dial number counts as one number, so the number of locations you can store becomes limited.
- If the line is busy a connection cannot be made so the MFC will redial the number.
- If the memory is full, press **Stop/Exit** to stop the job or if more than one page has been scanned, press **Fax Start** to send the portion that is in the memory.

**1** Place the original face up in the ADF, or face down on the scanner glass.

**2** Enter a number using Speed Dial, a Group number, Search or the dial pad.

(Example: Group number)

**3** Press **Menu/Set**. You will be asked to press the next number.

**4** Enter the next number.

(Example: Speed Dial number)

**5** Press **Menu/Set**.

**6** Enter another fax number.

(Example: Manual dialing using the dial pad.)

**7** Press **Fax Start**.

Your MFC will read the original into the memory and then start sending faxes to the numbers you entered.

## Pause

---

Press **Redial/Pause** to insert a 3.5-second pause between numbers. If you are dialing overseas, you can press **Redial/Pause** as many times as needed to increase the length of the pause.

## Fax Redial

---

If you're sending a fax manually and the line is busy, press **Redial/Pause** to try again. Anytime you want to make a second call to the last number you dialed, press **Redial/Pause** to save time.

If you're sending a fax automatically and the line is busy, the MFC will automatically redial one time five minutes after the transmission.

## Tone or Pulse

---

If you have a Pulse dialing service, but need to send Tone signals (for example, for telephone banking), follow the instructions below. If you have Touch Tone service, you will not need this feature to send tone signals.

- 1** Lift the handset of an external phone.
- 2** Press #. Any digits dialed after this will send tone signals.
- 3** When you hang up, the MFC will return to the Pulse dialing service.

## 8

# Remote fax options (Not available for color faxes)

## Fax Forwarding/Paging





*You cannot use Paging and Fax Forwarding at the same time.  
You cannot use Paging and Fax Forwarding when Fax Storage is set to OFF.*

## Programming a Fax Forwarding number

When Fax Forwarding is set to ON, your MFC stores the received fax in the memory. Then it dials the fax number you've programmed and forwards the fax message.

**1** Press **Menu/Set**, **2**, **5**, **1**.

REMOTE FAX OPT  
 1.FAX FWD/PAGING

**2** Press  or  until the LCD shows FAX FORWARD?.

FAX FWD/PAGING  
 FAX FORWARD?

Press **Menu/Set**.

The LCD will ask you to enter the fax number to which faxes will be forwarded.

**3** Enter the forwarding number (up to 20 digits).

FAX FORWARD  
 #: \_

Press **Menu/Set**.



**4** Press **Stop/Exit**.

## Programming your pager number

When Paging is selected, your MFC dials the pager number you've programmed, and then dials your Personal Identification Number (PIN). This activates your pager so you will know that you have a fax message in the memory.

**1** Press **Menu/Set**, **2**, **5**, **1**.

REMOTE FAX OPT  
1.FAX FWD/PAGING

**2** Press  or  until the LCD shows PAGING?.  
Press **Menu/Set**.

FAX FWD/PAGING  
PAGING?

**3** Enter your pager phone number (up to 20 digits)  
Followed by # #.  
Press **Menu/Set**.

PAGING  
# : \_

Do not include the area code if it is the same as that of your MFC.  
For example, press **1 8 0 0 5 5 5 1 2 3 4 # #**.

**4** If your pager needs a PIN, enter the PIN, press #, press **Redial/Pause**, enter your MFC telephone number followed by # #.  
Press **Menu/Set**.

PIN  
# : \_

(For example, press **1 2 3 4 5 # Redial/Pause 1 8 0 0 5 2 1 2 8 4 6 # #**)

—OR—

If you do not need a PIN, press **Redial/Pause**, enter the fax number of your MFC followed by # #.

Press **Menu/Set**.

(For example, press **Redial/Pause 1 8 0 0 5 2 1 2 8 4 6 # #**)

**5** Press **Stop/Exit**.



You cannot change a Paging number or PIN remotely.



# Setting Fax Storage

If you set Fax Storage to ON, you will be able to retrieve fax messages from another location using Fax Forwarding, Paging, or Remote Retrieval operations. The LCD will show when you have a fax stored in memory.

**1** Press **Menu/Set**, **2**, **5**, **2**.

The LCD will ask you to choose a fax setting.

REMOTE FAX OPT  
2.FAX STORAGE

**2** Press  or  to select ON (or OFF).  
Press **Menu/Set**.

**3** Press **Stop/Exit**.



If there are faxes in the memory when you turn Fax Storage OFF, the LCD will ask if you want to erase the faxes in the memory.

ERASE ALL FAX?  
1.YES 2.NO

If you press **1**, all fax data is erased and Fax Storage is turned off.

If you press **2**, faxes are not erased and Fax Storage stays on.

(See *Printing a fax from the memory* on page 5-6.)

## Backup Print

---

If you've set FAX STORAGE to ON, your MFC automatically prints faxes as they are received into the memory.

This is a safety feature in case the power goes off so you won't lose your messages.

# Changing your remote access code

Enter your Remote Access Code when the MFC picks up your call, so you can access features while you are away from your MFC. The access code is preset to 1 5 9 \* , but you can change it.

**1** Press **Menu/Set**, **2**, **5**, **3**.

**2** Enter a three-digit number from 000 to 999.

Press **Menu/Set**. (The “\*” cannot be changed).

REMOTE FAX OPT 3 . REMOTE ACCESS
-------------------------------------



Do not use the same digits that appear in your Fax Receive Code or Telephone Answer Code. See *Operation from extension telephones* on page 5-5.)

**3** Press **Stop/Exit**.

## Remote retrieval

You can call your MFC from any fax machine using touch tone, then use the Remote Access Code and other key presses to retrieve fax messages. Cut out the Remote Retrieval Access Card on the last page and keep it in your wallet to help you.

## Using your remote access code

---

**1** Dial your fax number from a telephone or another fax machine using touch tone.

**2** When your MFC answers, immediately enter your Remote Access Code (159 \* ).

**3** The MFC signals the kinds of messages it has received:

**1 long beep — Fax message(s)**

**No beeps — No messages**

**4** The MFC gives you two short beeps, which tells you to enter a command. The MFC will hang up if you wait longer than 30 seconds to enter a command. The MFC will beep three times, if you enter an invalid command.

**5** Press **90** to reset the MFC when you've finished.

**6** Hang up.



If your MFC is set to **MANUAL** mode and you want to use the remote retrieval features, you can access your machine by waiting about 2 minutes after it starts ringing, and then entering the Remote Access Code within 30 seconds.



## Remote commands

Follow the commands below to access features when you are away from the machine. When you call the MFC and enter your Remote Access Code (159 \* ), the system will give you two short beeps and you must enter a remote command.

Remote commands	Operation details
<b>95 Change the Fax Forwarding or Paging settings</b>	
1 OFF	If you hear one long beep, the change has been accepted. If you hear three short beeps, you cannot change it because the conditions have not been met. You can register your Fax Forwarding number by entering 4. Fax Forwarding number (see page 8-6). Once you have registered the number, the MFC will change to FAX FWD:ON mode.
2 Fax Forwarding	
3 Paging	
4 Fax Forwarding number	
6 Fax Storage ON	You can turn FAX STORAGE to ON or OFF.
7 Fax Storage OFF	
<b>96 Retrieve a fax</b>	
2 Retrieve all faxes	Enter the number of a remote fax machine to receive stored fax message(s). (See page 8-6.)
3 Erase faxes from the memory	If you hear one long beep, you can erase fax messages from the memory.
<b>97 Check the Receiving Status</b>	
1 Fax	You can check whether your MFC has received any faxes. If it has, you will hear one long beep. If it hasn't, you will hear three short beeps.
<b>98 Change the Receive Mode</b>	
1 EXTERNAL TAD	If you hear one long beep, you can change the Receive Mode. If you hear three short beeps, you cannot change it.
2 FAX/TEL	
3 FAX ONLY	
<b>90 Exit</b>	After a long beep, you can exit Remote Retrieval.

## Retrieving fax messages

---

- 1** Dial your fax number.
- 2** When your machine answers, immediately enter your Remote Retrieval Access Code (**159 \*** ).
- 3** As soon as you hear two short beeps, use the dial pad to press **962**.
- 4** Using the dial pad, enter the number of the remote fax machine that you want your fax messages sent to (up to 20 digits) followed by **##**.



You cannot use **\*** and **#** as dial numbers. However, press **#** if you want to store a pause.

- 5** Hang up after you hear your MFC beep. Your MFC will call the other fax machine, which will then print your fax messages.

## Changing your Fax Forwarding number

---

You can change the default setting of your fax forwarding number from another telephone or fax machine using Touch Tone.

- 1** Dial your fax number.
- 2** When your machine answers, immediately enter your Remote Access Code (**159 \*** ).
- 3** When you hear two short beeps, use the dial pad to press **954**.
- 4** Enter the new number of the fax machine where you want your fax messages sent to followed by **##** (up to 20 digits).



You cannot use **\*** and **#** as dial numbers. However, press **#** if you want to store a pause.

- 5** Hang up after you hear your MFC beep.

# 9 Printing Reports

## MFC settings and activity

You need to set up the Transmission Verification Report and Activity Report Interval in the menu table.

Press **Menu/Set, 2, 4, 1.**

—OR—

Press **Menu/Set, 2, 4, 2.**

SETUP REPORTS  
1 . TRANSMISSION

SETUP REPORTS  
2 . ACT . INTERVAL

## Customizing the Transmission Verification Report



You can use the Transmission Report as proof that you sent a fax. This report lists the time and date of transmission and whether the transmission was successful (OK). If you select ON or ON+IMAGE, the report will print for every fax you send.



When the feature is OFF, the Report will only print if there is a transmission error. (NG).

If you send a lot of faxes to the same place, you may need more than the job numbers to know which faxes you must send again.

Selecting OFF+IMAGE will print a section of the fax's first page on the report to help you remember.

- 1 Press **Menu/Set, 2, 4, 1.**
- 2 Press  or  to select OFF, OFF+IMAGE, ON or ON+IMAGE.  
Press **Menu/Set.**
- 3 Press **Stop/Exit.**

ACT . INTERVAL  
EVERY 50 FAXES

# Setting the Fax Activity Report Interval



---

You can set the MFC to print activity reports at specific intervals (every 50 faxes, 6, 12 or 24 hours, 2 or 7 days). If you set the interval to OFF, you can print the report by following the Steps on the next page.

The default setting is EVERY 50 FAXES.

**1** Press **Menu/Set**, **2**, **4**, **2**.

SETUP REPORTS  
2 .ACT .INTERVAL

**2** Press  or  to choose an interval. Press **Menu/Set**.

ACT .INTERVAL  
EVERY 50 FAXES

(If you choose 7 days, the LCD will ask you to choose a day on which to begin the 7-day countdown.)

**3** Enter the time to begin printing in 24-hour format. Press **Menu/Set**. (For example: enter 19:45 for 7:45 PM.)

**4** Press **Stop/Exit**.



If you select 6, 12, 24 hours, 2 or 7 days, the machine will print the Activity Report when the MFC has stored 200 jobs. Even if the time you selected has not passed yet, the MFC will print the report because the memory is full then all the reported jobs will be erased from the machine's memory.

When the MFC prints the activity report at any of the intervals you selected, all the reported jobs will be erased from the machine's memory.

# Printing reports

---

Five reports are available:

PRINT REPORTS  
1.HELP LIST

Prints the Help List so you can see at-a-glance how to quickly program your MFC.

PRINT REPORTS  
2.AUTO DIAL

Lists names and numbers stored in the Speed Dial memory, in numerical order.

PRINT REPORTS  
3.FAX ACTIVITY

Lists information about the last incoming and outgoing faxes.

(TX means Transmit.) (RX means Receive.)

PRINT REPORTS  
4.TRANSMISSION



Prints a Transmission Verification Report for your last transmission.

PRINT REPORTS  
5.USER SETTINGS

Lists settings for GENERAL SETUP, SETUP RECEIVE, SETUP SEND, SETUP REPORTS, TEL SERVICE and REMOTE FAX OPT.

## To Print a Report

**1** Press **Menu/Set**, **6**.

**2** Press  or  to select the report you want.

Press **Menu/Set**.

—**OR**—

Enter the number of the report you want to print.

For example, press **1** to print the Help List.

SELECT ↑ ↓ & SET  
6.PRINT REPORTS

# 10 Making copies

## Using the MFC as a copier

Your MFC allows you to make high-quality photocopies and transparencies. Copies can be in black and white or full color. Always make sure you have paper in the paper tray before making copies. Do not pull on the paper while copying is in progress.

### Copy Keys

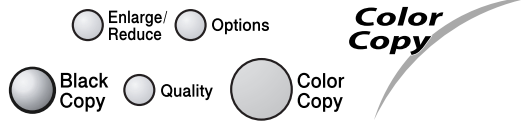

Incoming faxes cannot be received on paper or into the memory while the MFC is copying.



If the original is a post card, place it on the scanner glass. Post cards can NOT be put through the ADF.

Originals are *face up* in the ADF

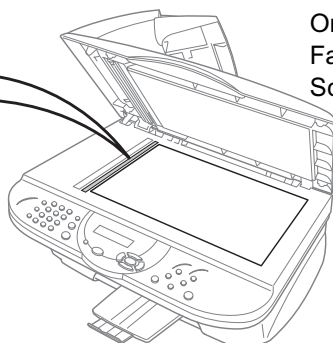
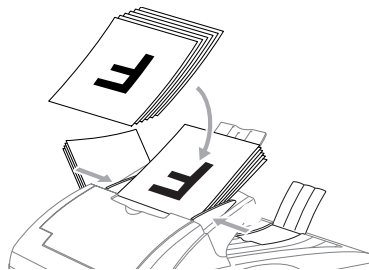

Originals are Face Down on the Scanner Glass

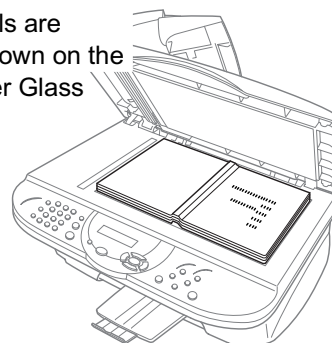

## Making a single copy

---

- 1** Place the original face up in the ADF, or face down on the scanner glass.
- 2** As needed, use **Options** and **Enlarge/ Reduce** to change the settings.
- 3** Press **Black Copy** or **Color Copy**.



To stop copying and release the original, press Stop/Exit.

## Making more than one copy (Using the ADF)

---

You can make multiple copies using the ADF. Multiple copies will be stacked or sorted. Use the **Options** key to select SORT.

(See *Using the Options key* on page 10-8.)

- 1** Place the original face up in the ADF.
- 2** Using the dial pad, enter the number of copies you want (up to 99).  
(For example, press **3 8** for 38 copies.)
- 3** Press **Black Copy** or **Color Copy**.



To sort the copies, use the Options key.

(See *Sorting copies using the ADF* on page 10-12.)

## Single or multiple copies (Using the scanner glass)

You can make multiple copies using the scanner glass. Multiple copies will be stacked (all copies of page 1, then all copies of page 2, and so on). Use the **Options** key to choose more settings. For details about using the **Options** key, please see *Using the Options key* on page 10-8.

### 1 Lift the Document Cover.

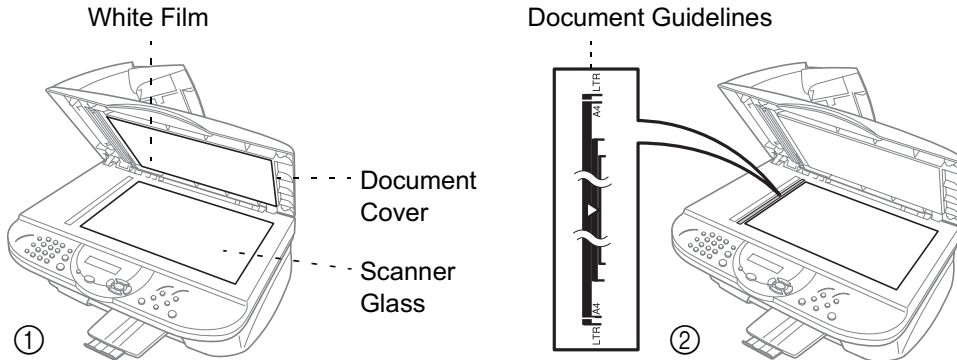

### 2 Using the document guidelines on the left, center the original face down on the scanner glass and close the document cover.

### 3 Using the dial pad, enter the number of copies you want (up to 99). For example, press **3 8** for 38 copies. The MFC will start scanning the original.

### 4 Press **Black Copy** or **Color Copy**.

## Out of memory message

If the memory becomes full while you are making copies, the LCD will show this message:

OUT OF MEMORY
PLAIN 01

If the **OUT OF MEMORY** message appears while you are scanning the first page of your original, press **Stop/Exit** to cancel. You will need to clear some jobs from the memory before you can continue.

If you were scanning a subsequent page, press **Black Copy** or **Color Copy** to print the scanned pages or press **Stop/Exit** to cancel.



To gain extra memory, you can turn off Fax Storage (See *Setting Fax Storage* on page 8-3.).

—OR—

Print the faxes that are in the memory (See *Printing a fax from the memory* on page 5-6.).

When you get an **OUT OF MEMORY** message, you may be able to make copies if you first print incoming faxes in memory and restore the memory to 100%.



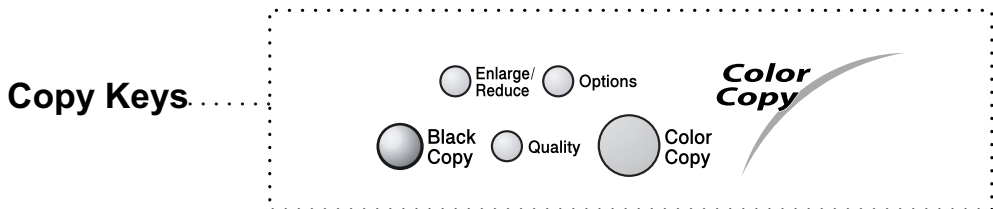

# Using more than one temporary copy setting

When you want to change the settings only for the next copy, use the **Enlarge/Reduce**, **Quality** and **Options** keys.



You can use different combinations. For example, if you want to copy a photograph on glossy paper with best print quality, press the **Quality** key to select **BEST** and then press the **Options** key to select **GLOSSY** in the Paper Type setting.

- Improve Quality (See *Using the Quality key* on page 10-6.)
- Enlarge and Reduce (See *Using the Enlarge/Reduce key* on page 10-7.)
- Paper Type (See *Paper Type* on page 10-9.)
- Paper Size (See *Paper Size* on page 10-10.)
- Near Edge Copy (See *Near Edge* on page 10-10.)
- Brightness (See *Brightness* on page 10-11.)
- Contrast (See *Contrast* on page 10-11.)
- Sort Copies (See *Sorting copies using the ADF* on page 10-12.)
- Page Layout (See *Page Layout using the ADF* on page 10-12 and *Page Layout using the scanner glass* on page 10-12.)
- Manual Feed Copy (See *Turning on Manual Feed* on page 10-14.)

Press  or  to select more settings.  
—OR—

Press **Black Copy** or **Color Copy** if you're finished choosing settings.

PRESS COPY OR  
↑ ↓ FOR NEXT OPT.



These settings are temporary and if you set the document on the scanner glass, the MFC returns to its original settings 30 seconds after it finishes copying. If you want to reuse these temporary settings, put the next original on the scanner glass before the 30 seconds expire.



## Using the Quality key

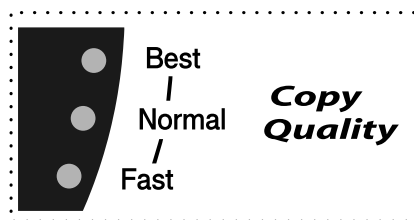

The **Quality** key temporarily changes the copy quality to NORMAL, BEST or FAST.



Press Quality key repeatedly to light the indicator for your setting.

—OR—

Press Quality and  or  until the LCD shows the setting you want as shown.



Press <b>Quality</b> and  or 	NORMAL	Recommended mode for ordinary printouts. Good copy quality with adequate copy speed.
	FAST	Fast copy speed and lowest ink consumption. Use FAST to save time (documents to be proof-read, large documents or many copies).
	BEST	Use this mode to copy precise images such as photographs. BEST uses the highest resolution and slowest speed.

**1** Place the original face up in the ADF, or face down on the scanner glass.

**2** Press **Quality** repeatedly for your setting,

SELECT ↑ ↓ & SET  
NORMAL

—OR—

Press **Quality** and  or  to select the quality on the LED. Press **Menu/Set**.



**3** To start copying now, press **Black Copy** or **Color Copy**



—OR—

Press  or  for more settings.

## Using the Enlarge/Reduce key

You can select the following enlargement or reduction ratios.  
ZOOM allows you to enter a ratio from 25% to 400%.

Press <b>Enlarge/Reduce</b> and  or 	100%
	94% A4 → LTR
	78% LGL → LTR
	50%
	25%
	ZOOM
	400%
	200%
	150%
	104% EXE → LTR

- 1 Place the original face up in the ADF, or face down on the scanner glass.
- 2 Use the dial pad to enter the number of copies you want (up to 99).
- 3 Press **Enlarge/Reduce**.
- 4 Press  or  to select the enlargement or reduction ratio you want.

SELECT ↑ ↓ & SET 100%
--------------------------

Press **Menu/Set**.

—OR—

You can select ZOOM and press **Menu/Set**.

Use the dial pad to enter an enlargement or reduction ratio from 25% to 400%.

Press **Menu/Set**.

(For example, press **5 3** to enter 53%.)

- 5 Press **Black Copy** or **Color Copy**

—OR—

Press  or  for more settings.



Special Copy Options (2in1, 4in1 or Poster) are not available with **Enlarge/Reduce**.

## Selecting the fixed reduction ratio

To select a reduction ratio, you will need to know the size of the paper you registered in **Menu/Set, 1, 2**.

—OR—

See *Using the Options key* on page 10-8.



If you want to make a copy the same size as the original, you should choose a reduction of 94%. (For example, if you copy from letter to letter, you should choose a reduction of 94%.)

Original the size of...	Paper size is...	Recommended reduction ratio is...
LETTER	LETTER	94%
	LEGAL	100%
A4	LETTER	94%
LEGAL	LETTER	78%
	LEGAL	94%

## Using the Options key







Use the **Options** key to set the number of copies, paper type, paper size, near edge, brightness, contrast, sort and page layout settings **only for the next copy**.

Press Options	Menu Selections	Options	Factory Setting
	NO. OF COPIES:01	NO. OF COPIES:01 (01-99)	01
	PAPER TYPE	PLAIN/INK JET/GLOSSY (4-COLOR or 3-COLOR) / TRANSPARENCY	PLAIN
	PAPER SIZE	LETTER/LEGAL/4 " (W)×6 " (H)	LETTER
	NEAR EDGE	ON/OFF	ON
	BRIGHTNESS	- ■■■■ +	- ■■■□ +
	CONTRAST	- ■■■■ +	- ■■■□ +
	STACK/SORT	STACK/SORT	STACK
	PAGE LAYOUT	OFF (1 IN 1) / 2 IN 1 / 4 IN 1 / POSTER	OFF (1 IN 1)
MANUAL FEED	ON/OFF	OFF	

## Paper Type

You can change the paper type only for the next copy. Select the type of media that you are using to get the best print quality.

### To get the best color photograph copy quality

- 1** Place the original face up in the ADF, or face down on the scanner glass.
- 2** Use the dial pad to enter the number of copies you want (up to 99).
- 3** Press **Options** and  or  to select PAPER TYPE.  
Press **Menu/Set**.
- 4** Press  or  to select the type of paper you are using (PLAIN, INKJET, GLOSSY or TRANSPARENCY).  
Press **Menu/Set**.
- 5** If you selected GLOSSY, press  or  to select GLOSSY-4COLOR or GLOSSY-3COLOR.  
Press **Menu/Set**.



The print quality of black ink depends on the type of glossy paper you are using. Black ink is used when you select GLOSSY-4COLOR. If the glossy paper you are using repels the black ink, select GLOSSY-3COLOR, which simulates black ink by combining the three ink colors.





- 6** Press **Black Copy** or **Color Copy**  
—OR—  
Press  or  for more settings.

## Paper Size

You can change the paper size setting only for the next copy.









You can copy only on Letter, Legal and Post Card size paper.

- 1** Place the original face up in the ADF, or face down on the scanner glass.
- 2** Use the dial pad to enter the number of copies you want (up to 99).
- 3** Press **Options** and select PAPER SIZE.  
Press **Menu/Set**.
- 4** Press  or  to select the size of paper you are using (LETTER, LEGAL, or 4 " (W) × 6 " (H)).  
Press **Menu/Set**.
- 5** Press **Black Copy** or **Color Copy**.  
—OR—  
Press  or  for more settings.

## Near Edge







The Near Edge feature expands the printable area closer to the left, right and bottom edges of the paper up to 0.12 in. (3mm).

Copy time will be slightly slower.

- 1** Place the original face up in the ADF, or face down on the scanner glass.
- 2** Use the dial pad to enter the number of copies you want (up to 99).
- 3** Press **Options** and  or  to select NEAR EDGE.  
Press **Menu/Set**.
- 4** Press  or  to select ON (or OFF).  
Press **Menu/Set**.
- 5** Press **Black Copy** or **Color Copy**.  
—OR—  
Press  or  for more settings.

## Brightness







You can adjust the copy brightness to make copies darker or lighter.

- 1 Place the original face up in the ADF, or face down on the scanner glass.
- 2 Use the dial pad to enter the number of copies you want (up to 99).
- 3 Press **Options** and  or  to select  
BRIGHTNESS.  
Press **Menu/Set**.
- 4 Press  to make a lighter copy  
—OR—  
Press  to make a darker copy.  
Press **Menu/Set**.
- 5 Press **Black Copy** or **Color Copy**.  
—OR—  
Press  or  for more settings.



## Contrast

You can change the contrast to help an image look sharper and more vivid.







- 1 Place the original Face up in the ADF, or face down on the scanner glass.
- 2 Use the dial pad to enter the number of copies you want (up to 99).
- 3 Press **Options** and press  or  to select  
CONTRAST.  
Press **Menu/Set**.
- 4 Press  to increase the contrast  
—OR—  
Press  to decrease the contrast.  
Press **Menu/Set**.
- 5 Press **Black Copy** or **Color Copy**.  
—OR—  
Press  or  for more settings.





## Sorting copies using the ADF

If you want to sort multiple copies, use the ADF.







- 1 Place the originals face up in the ADF.
- 2 Use the dial pad to enter the number of copies you want (up to 99).
- 3 Press **Options** and  or  to select **STACK/SORT**.  
Press **Menu/Set**.
- 4 Press  or  to select **SORT** (or **STACK**).  
Press **Menu/Set**.
- 5 Press **Black Copy** or **Color Copy**  
—OR—  
Press  or  for more settings.



Sorting color copies uses more memory. How much memory is used depends on the data.



## Page Layout using the ADF



You can save paper by copying either two or four pages onto one page. If you want to print a poster, use the scanner glass.

- 1 Place the originals face up in the ADF.
- 2 Use the dial pad to enter the number of copies you want (up to 99).
- 3 Press **Options** and  or  to select **PAGE LAYOUT**.  
Press **Menu/Set**.
- 4 Press  or  to select **2 IN 1**, **4 IN 1**  
(or **OFF(1 IN 1)**).  
Press **Menu/Set**.
- 5 Press **Black Copy** or **Color Copy**.  
—OR—  
Press  or  for more settings.

## Page Layout using the scanner glass

You can save paper by copying either two or four pages onto one page, or you can make poster size copy.

- 1 Place the original face down on the scanner glass.
- 2 Use the dial pad to enter the number of copies you want (up to 99).
- 3 Press **Options** and  or  to select **PAGE LAYOUT**.  
Press **Menu/Set**.

**4** Press  or  to select 2 IN 1, 4 IN 1, POSTER (or OFF (1 IN 1)).

Press **Menu/Set**.

**5** Press **Black Copy** or **Color Copy**.



If you selected 2 IN 1 or 4 IN 1 in Step 4, put the next original on the scanner glass. Press **Menu/Set**.

NEXT:PRESS SET  
END:PRESS COPY

### 2 in 1



### 4 in 1

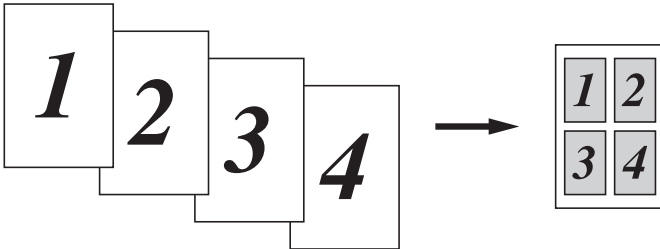

### Poster

You can make a poster size copy of a photograph.

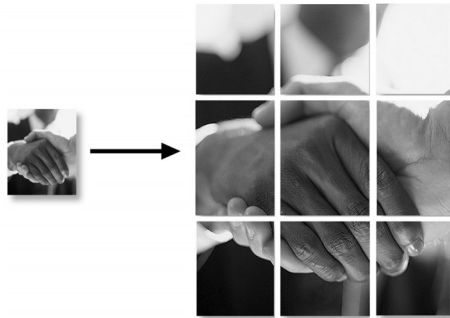

For 2 in 1 or 4 in 1 copies, you cannot use the **Enlarge/Reduce** key, print glossy paper, or Near Edge feature.





For color 2 in 1 or 4 in 1 copies, you can only use letter paper. You cannot make more than one copy.

For POSTER copies, you cannot make more than one copy, use the **Enlarge/Reduce** key, Near Edge feature, or the ADF (Automatic Document Feeder).

## Turning on Manual Feed

Your MFC has a manual feed slot at the back of machine.  
Use the manual feed slot when you want to copy on thicker paper.

 If there is paper in the paper tray you will have to take it out, and then load one sheet of paper at a time in the manual feed slot.

- 1 Place the original face up in the ADF, or face down on the scanner glass.
- 2 Press **Options** and  or  to select **MANUAL FEED**. Press **Menu/Set**.
- 3 Press  or  to select **ON** (or **OFF**). Press **Menu/Set**.
- 4 Take the paper out of the paper tray.
- 5 Open the manual feed slot cover.

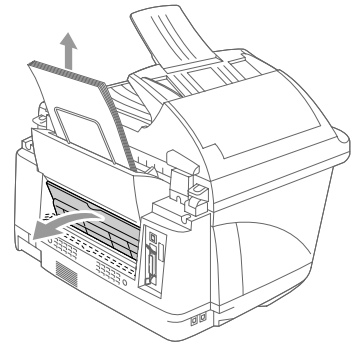

- 6 In the manual feed slot, insert one sheet of paper with the side you wish to print on face up.
- 7 Align the paper at the center of the manual feed slot and insert it all the way in. Adjust the paper guides to the width of the paper.
- 8 Press **Black Copy** or **Color Copy**.

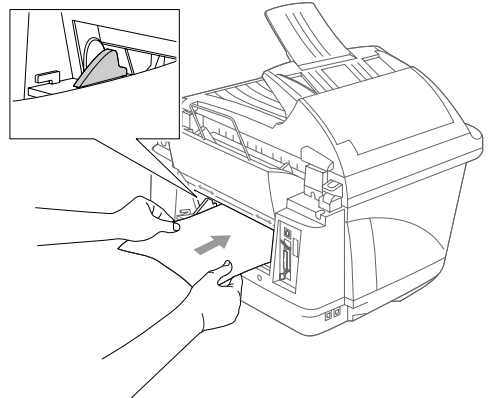

- 9 The LCD shows:  
Press **Fax Start**.

MANUAL FEED  
PRESS FAX START



# Changing the default copy settings

You can adjust copy settings that are shown in the chart. These settings will stay until you change them again.

Submenu	Menu Selections	Options	Factory Settings
1.QUALITY	—	NORMAL	NORMAL
		BEST	
		FAST	
2.NEAR EDGE	—	ON	ON
		OFF	
3.BRIGHTNESS	—	- ■■■■ + - ■■■■ + - ■■■■ + - ■■■■ + - ■■■■ +	- ■■■■ +
4.CONTRAST	—	- ■■■■ + - ■■■■ + - ■■■■ + - ■■■■ + - ■■■■ +	- ■■■■ +
5.COLOR ADJUST	1.RED	R:- ■■■■ + R:- ■■■■ + R:- ■■■■ + R:- ■■■■ + R:- ■■■■ +	R:- ■■■■ +
	2.GREEN	G:- ■■■■ + G:- ■■■■ + G:- ■■■■ + G:- ■■■■ + G:- ■■■■ +	G:- ■■■■ +
	3.BLUE	B:- ■■■■ + B:- ■■■■ + B:- ■■■■ + B:- ■■■■ + B:- ■■■■ +	B:- ■■■■ +

## Copy Quality



---

- 1 Press **Menu/Set**, **3**, **1**.
- 2 Press  or  to select NORMAL, BEST or FAST.  
Press **Menu/Set**.
- 3 Press **Stop/Exit**.

COPY  
1.QUALITY

## Near Edge



---

- 1 Press **Menu/Set**, **3**, **2**.
- 2 Press  or  to select ON (or OFF).  
Press **Menu/Set**.
- 3 Press **Stop/Exit**.

COPY  
2.NEAR EDGE

## Brightness

---



- 1 Press **Menu/Set**, **3**, **3**.
- 2 Press  to make a lighter copy  
—OR—  
Press  to make a darker copy.  
Press **Menu/Set**.
- 3 Press **Stop/Exit**.

COPY  
3.BRIGHTNESS

## Contrast

---

You can change the contrast to help an image look sharper and more vivid.



- 1 Press **Menu/Set**, **3**, **4**.
- 2 Press  to increase the contrast,  
—OR—  
Press  to decrease the contrast.  
Press **Menu/Set**.
- 3 Press **Stop/Exit**.



COPY  
4.CONTRAST

# Color Adjustment

---

**1** Press **Menu/Set, 3, 5.**

**2** Press  or  to select RED, GREEN or BLUE.  
Press **Menu/Set.**

**3** Press  to make a darker copy.  
—OR—  
Press  to make a lighter copy.  
Press **Menu/Set.**

**4** Return to Step 2 to select the next color  
—OR—  
Press **Stop/Exit.**

COPY 5 . COLOR ADJUST
--------------------------

# Legal limitations

Color reproductions of certain documents are illegal and may result in either criminal or civil liability. This memorandum is intended to be a guide rather than a complete listing of every possible prohibition. In case of doubt, we suggest that you check with counsel as to any particular questionable documents.

The following documents issued by the United States/Canadian Government or any of its Agencies may not be copied:

- Paper money
- Bonds or other certificates of indebtedness
- Certificates of Deposit
- Internal Revenue Stamps (canceled or uncanceled)
- Selective Service or draft papers
- Passports
- United States/Canadian Postage Stamps (canceled or uncanceled)
- Food Stamps
- Immigration Papers
- Checks or drafts drawn by Governmental agencies
- Identifying badges or insignias

Copyrighted works cannot be copied. Sections of a copyrighted work can be copied for 'fair use.' Multiple copies would indicate improper use.

Works of art should be considered the equivalent of copyrighted works.

Licenses and Certificates of Title to motor vehicles may not be copied under certain state/provincial laws.

# **11** Walk-Up PhotoCapture Center™

## **Introduction**

Your Brother MFC includes three media drives (slots) to use with popular digital camera media: CompactFlash™, SmartMedia™ and Memory Stick™.

The PhotoCapture Center™ feature lets you print digital photos from your digital camera at high resolution to get photo quality printing.

## **Basic flow**

- 1** Insert the media card firmly into the media drive (slot).  
(See *Getting started* on page 11-2.)
- 2** Print the index (Thumbnails) of all the images on your media card by selecting PRINT INDEX. The images will be numbered.  
(See *Printing the Index (Thumbnails)* on page 11-4.)
- 3** To print the images, select PRINT IMAGES.  
(See *Printing images* on page 11-5.)
- 4** You can change the settings for printing images, such as the number of Copies, Paper Type, Paper & Print Size, Print Quality, Brightness, True2Life® and Manual Feed by selecting CHANGE SETTINGS.  
(See *Changing the settings for printing images* on page 11-6.)



# Getting started

- There are separate slots on your MFC, for a CompactFlash™ card, a SmartMedia™ card and a Memory Stick™. Use only media cards with 3.3 voltage in your MFC.

The top left slot is for a SmartMedia™ Card, the top right slot is for a Memory Stick™ and the bottom is for a CompactFlash™ Card. Firmly insert the card into the appropriate slot.

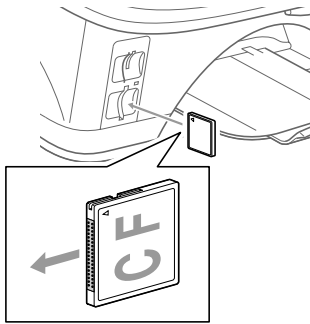

CompactFlash™

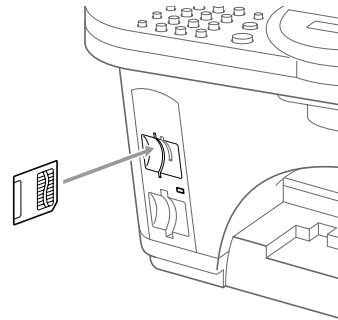

SmartMedia™

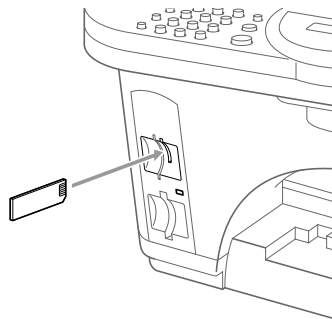

Memory Stick™

## Media Card Indicator Lights:

- **LED** light is ON, the media card is inserted properly.
- **LED** is OFF, the media card is not properly inserted.
- **LED** is BLINKING, the media card is being read or written to.

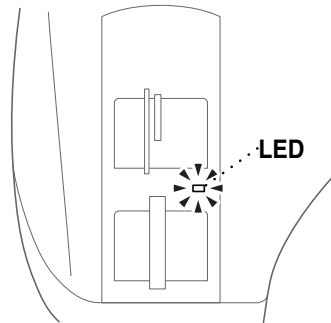

**⚠** Do NOT turn off or unplug the power cord or remove the media card from the PhotoCapture Center™ while the MFC is reading or writing to the card (LED is blinking). **You will loose your data or damage the card.**



The MFC can only read one Media card at a time so do not insert more than one card. The settings that you want to use with the card will be kept until you take out the media card from the drive (slot), print images or press **Stop/Exit**.

**1** Insert the media card firmly into the media drive (slot).

**2** When you insert your media card into the proper slot, the LCD shows.

C.FLASH ACTIVE  
Press Options key -----

**3** Press **Options**.

**4** Press  or  to select PHOTOCAPTURE.  
Press **Menu/Set**.

SELECT ↑ ↓ & SET  
PHOTOCAPTURE



Do not select COPY because you will enter the copy operations and not the PhotoCapture Center™.

**5** The LCD scrolls:

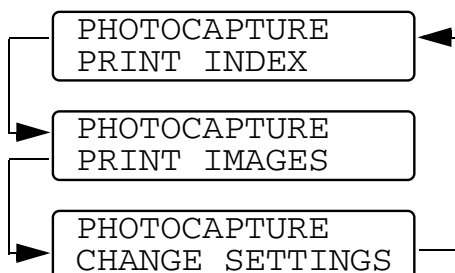

(See *Printing the Index (Thumbnails)* on page 11-4.)

(See *Printing images* on page 11-5.)

(See *Changing the settings for printing images* on page 11-6.)

# Printing the Index (Thumbnails)

The PhotoCapture Center™ assigns numbers for images (such as No.1, No.2, No.3, and so on).



→ No. 1      01. 01. 2003  
DEI.JPG      100KB

It does not recognize any other numbers or file names that your digital camera or PC have used to identify the pictures. You can print a thumbnail page (Index page with 6 or 4 images per line). This will show all the pictures on the media card.





Make sure you have done Steps 1 to 4 on page 11-3.

**5** Press  or  to select  
PRINT INDEX.

PHOTOCAPTURE  
PRINT INDEX

Press **Menu/Set**.

**6** Press  or  to select  
6 IMAGES/LINE or 4  
IMAGES/LINE.

PRINT INDEX  
6 IMAGES/LINE

Press **Menu/Set**.

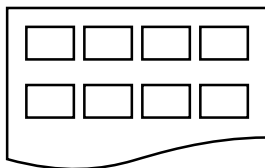

4 Images/line

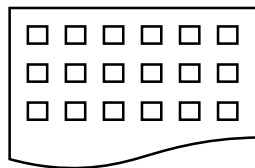

6 Images/line

**7** Press **Color Copy** to start printing.



Print time for 4 Images/line will be slower than 6 Images/line, but the quality is better. To print an image, see the next page.



# Printing images

Before you can print an individual image, you have to know the image number.



Print the Index first. See *Printing the Index (Thumbnails)* on page 11-4.

Make sure you have done steps 1 to 4 on page 11-3.

- 5** Press  or  to choose PRINT IMAGES.

PHOTOCAPTURE  
PRINT IMAGES

Press **Menu/Set**.

- 6** Use the dial pad to enter the image number that you want to be printed from the Index page (Thumbnails).

ENTER & SET KEY  
IMG: 1, 3, 6

Press **Menu/Set**.

Repeat this step until you have entered all the image numbers that you want to print.



You can enter all the numbers at one time by using the \* key for a comma or the # key for hyphen.

(For example, Enter **1\*3\*6** - to print images No.1, No.3 and No.6. Enter **1#5** to print images No.1 to No.5).

- 7** After you have selected all the image numbers.



Press **Menu/Set**.

The LCD shows:

- 8** To print, press **Color Copy**.  
—OR—

PRESS COLOR COPY  
OR ↑ ↓ FOR OPTION

To change settings, press  or

 the LCD scrolls through the settings again. You can select these options by pressing  or  and **Menu/Set**.

(See *Changing the settings for printing images* on page 11-6.)

After you select all the options you want.

Press **Color Copy**.



# Changing the settings for printing images

You can use the **Options** key to change the settings for the number of Copies, Paper Type, Paper & Print Size, Print Quality, Brightness, True2Life<sup>®</sup> and Manual Feed only for the next printed image.



Make sure you have done Steps 1 to 7 on pages 11-3 to 11-5.



8

Press  or  to change the settings.

The LCD scrolls through the options again.

Menu Selections	Options (1)	Options (2)	Factory Setting	Page
NO. OF COPIES XX	—	—	01	11-8
PAPER TYPE	PLAIN	—	PLAIN	11-8
	INK JET			
	GLOSSY	GLOSSY:4-COLOR GLOSSY:3-COLOR		
	TRANSPARENCY	—		
PAPER&PRINT SIZE	LETTER LEGAL	PRINT SIZE 5" × 3.5", 6" × 4", 7" × 5", 8" × 10"	6" × 4"	11-9
	6"(W) × 4"(H) 4"(W) × 6"(H)	PRINT SIZE FULL PAGE or HALF PAGE	FULL PAGE	
PRINT QUALITY	NORMAL	—	FINE	11-10
	FINE			
	PHOTO			
BRIGHTNESS	- ■■■■■ +	—	- ■■■■■ +	11-10
	- ■■■■ □ +			
	- ■■■ □ □ +			
	- ■■ □ □ □ +			
	- ■ □ □ □ □ +			
TRUE2LIFE	ON	—	OFF	11-11
	OFF			
MANUAL FEED	ON	—	OFF	11-12
	OFF			



9

Press  or  to scroll through the menu selections. Press **Menu/Set** when the LCD shows the menu you want to change. For details about each menu selection, see *Menu selections* on page 11-8.

**10** After you have selected all your settings, the LCD shows.  
Press **Color Copy** to print the image.

PRESS COPY OR  
↑ ↓ FOR NEXT OPT.



If you did not select any image numbers to print, the LCD shows:  
Press **Menu/Set** and  or  to select PRINT IMAGES, and enter the image numbers. (See *Printing images* on page 11-5.)

PRESS SET KEY OR  
↑ ↓ FOR NEXT OPT.





## Menu selections

---









Make sure you have done Steps 1 to 8 on pages 11-3 to 11-6.

### Number of Copies

- 9** Press  or  to select NO. OF COPIES:01.  
Press **Menu/Set**.
- 10** Use the dial pad to enter the number of copies you want.  
Press **Menu/Set**.
- 11** Press **Color Copy** to print  
—OR—  
Press  or  for more settings.



### Paper Type

- 9** Press  or  to select PAPER TYPE.  
Press **Menu/Set**.
- 10** Press  or  to select the type of paper you are using,  
(PLAIN, INK JET, GLOSSY or TRANSPARENCY).  
Press **Menu/Set**.
- 11** If you selected GLOSSY, press  or  to select  
GLOSSY:4-COLOR or GLOSSY:3-COLOR.  
Press **Menu/Set**.



The print quality of black ink depends on the type of glossy paper you are using. Black ink is used when you select 4-COLOR.

If the glossy paper you are using repels the black ink, select 3-COLOR, which simulates black ink by combining the three ink colors.



- 12** Press **Color Copy** to print  
—OR—  
Press  or  for more settings.

## Paper and Print Size





Make sure you have done Steps 1 to 8 on pages 11-3 to 11-6.



**9**

Press  or  to select PAPER & PRINT SIZE.  
Press **Menu/Set**.



**10**

Press  or  to select the size of the paper you are using (LETTER, LEGAL, 6" (W) X4" (H) or 4" (W) X6" (H)).  
Press **Menu/Set**.

**11**

If you select LETTER or LEGAL,  
press  or  to select the print size (5" X 3.5", 6" X 4", 7" X 5" or 8" X 10").  
Press **Menu/Set**.

—OR—

If you selected 6" (W) X4" (H) or 4" (W) X6" (H).  
press  or  to select FULL PAGE or HALF PAGE.  
Press **Menu/Set**.

**12**





Press **Color Copy** to print

—OR—

Press  or  for more settings.

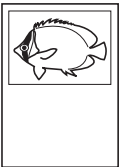



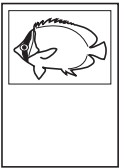
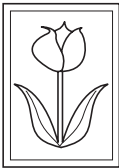
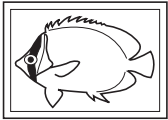
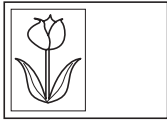

- Load the paper (post card) top down and print side is towards you.
- You can print an image on the post card as below.

	4" (W) × 6" (H)	6" (W) × 4" (H)
Half Page	 	 
Full Page	 	 





## Print Quality

**9** Press  or  to select PRINT QUALITY.  
Press **Menu/Set**.



**10** Press  or  to select NORMAL, FINE or PHOTO.  
Press **Menu/Set**.



NORMAL	Recommended mode for ordinary printouts. Good print quality with adequate print speed.
FINE	Better print quality than normal and faster copy speed than PHOTO.
PHOTO	Use this mode to print precise images such as photographs. PHOTO uses the highest resolution and slowest speed.



**11** Press **Color Copy** to print  
—OR—  
Press  or  for more settings.

## Brightness

 Make sure you have done Steps 1 to 8 on pages 11-3 to 11-6.

**9** Press  or  to select BRIGHTNESS.  
Press **Menu/Set**.



**10** Press  to make a lighter print  
—OR—  
Press  to make a darker print.  
Press **Menu/Set**.



**11** Press **Color Copy** to print  
—OR—  
Press  or  for more settings.

## Color enhancement (True2Life®)

You can turn on the color enhancement (True2Life®) feature to print more vivid images.

If you want to customize the White Balance, Sharpness or Color Density, press **Menu/Set, 4, 5**. (See *Color enhancement (True2Life®)* on page 11-16.)

**9** Press  or  to select TRUE2LIFE.  
Press **Menu/Set**.

**10** Press  or  to select ON (or OFF).  
Press **Menu/Set**.

**11** Press **Color Copy** to print  
—OR—

Press  or  for more settings.







- The PhotoCapture Center™ prints only in color. Black & White printing and Enlargement/Reduction is not available when using this feature.
- The PhotoCapture Center™ returns to its default setting when you take out the media card, print images or press **Stop/Exit**.

## Turning on Manual Feed

Use the manual feed slot when you want to print on thick paper.

 If there is paper in the paper tray you will have to take it out, and then load one sheet of paper at a time in the manual feed slot.

**9** Press  or  to select **MANUAL FEED**.  
Press **Menu/Set**.

**10** Press  or  to select **ON** (or **OFF**).  
Press **Menu/Set**.

**11** Take the paper out of the paper tray.

**12** Open the manual feed slot cover.

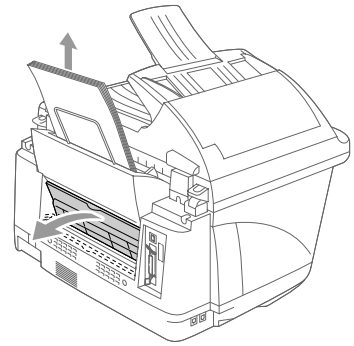

**13** In the manual feed slot, insert one sheet of paper with the side you wish to print on face up.

**14** Align the paper at the center of the manual feed slot and insert it all the way in.

Adjust the paper guides to the width of the paper.

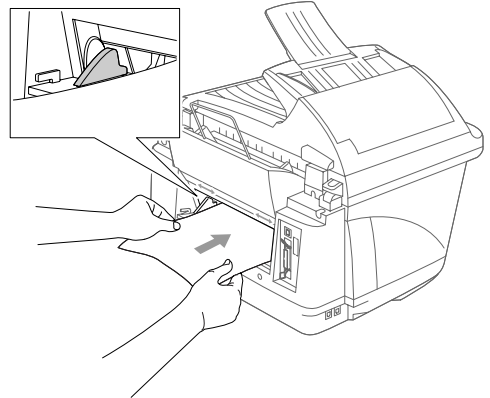

**15** Press **Color Copy** to print.

Press **Fax Start**.

—OR—

Press  or  for more settings.

MANUAL FEED  
PRESS FAX START

# DPOF printing

---

DPOF stands for Digital Print Order Format.

Major Digital Camera manufacturers (Canon Inc., E Eastman Kodak Company, Fuji Photo Film Co., Ltd. and Matsushita Electric Industrial Co., Ltd. and Sony Corporation.) created this standard to make it easier to print images from a digital camera.



If your digital camera supports DPOF printing, you will be able to select on the Digital Camera display the images and number of copies you want to print.



When the memory card (CompactFlash™, SmartMedia™ or Memory Stick™) with DPOF information is put into your MFC, the images you selected will be printed.

**1** Insert your media card into the proper drive (slot).

C.FLASH ACTIVE  
Press Options key -----

**2** Press **Options**.

**3** Press  or  to select PHOTOCAPTURE.  
Press **Menu/Set**.

**4** Press  or  to select PRINT IMAGES to select individual images.  
Press **Menu/Set**.

**5** If there is a DPOF file on the card, the LCD shows:

DPOF PRINT  
1.YES 2.NO

**6** Press **1** to select 1 . YES.



PRESS COLOR COPY  
OR ↑ ↓ FOR OPTION



If you want to print an Index (thumbnails) or choose the images and their print options now, select 2 . NO.

**7** Press **Color Copy** to print.

—OR—

Press  or  to change the settings for the number of Copies, Paper Type, Paper & Print Size, Print Quality, Brightness, True2Life® or Manual Feed.

(See *Changing the settings for printing images* on page 11-6.)

# Changing the default settings



You can adjust the Print Quality, Print Size, Brightness, Contrast, True2Life® and Scan to Card settings, that are shown in the chart. These settings will remain set until you change them again.

Press **Menu/Set, 4**, followed by the number of the setting you want to change. (See details on the following pages.)

Submenu	Menu Selections	Options (1)	Options (2)	Factory Settings	
1.PRINT QUALITY	—	NORMAL	—	FINE	
		FINE			
		PHOTO			
2.PRINT SIZE	—	5" × 3.5"	—	6" × 4"	
		6" × 4"			
		7" × 5"			
		8" × 10"			
3.BRIGHTNESS	—	- ■■■■■ +	—	- ■■■■ +	
		- ■■■■ □ +			
		- ■■■ □ □ +			
		- ■■ □ □ □ +			
		- ■ □ □ □ □ +			
4.CONTRAST	—	- ■■■■■ +	—	- ■■■■ □ +	
		- ■■■■ □ +			
		- ■■■ □ □ +			
		- ■■ □ □ □ +			
		- ■ □ □ □ □ +			
5.TRUE2LIFE	ON	1.WHITE BALANCE	- ■■■■■ + - ■■■■ □ + - ■■■ □ □ + - ■■ □ □ □ + - ■ □ □ □ □ +	(- ■■■ □ □ +)	
		2.SHARPNESS	- ■■■■■ + - ■■■■ □ + - ■■■ □ □ + - ■■ □ □ □ + - ■ □ □ □ □ +	(- ■■■ □ □ +)	
		3.COLOR DENSITY	- ■■■■■ + - ■■■■ □ + - ■■■ □ □ + - ■■ □ □ □ + - ■ □ □ □ □ +	(- ■■■ □ □ +)	
		—	—	—	
		OFF	—	—	OFF
		6.SCAN TO CARD (See Chapter 15)	—	PDF	—
	JPEG				

## Print Quality



---

- 1 Press **Menu/Set**, **4**, **1**.
- 2 Press  or  to select NORMAL, FINE or PHOTO.  
Press **Menu/Set**.
- 3 Press **Stop/Exit**.

PHOTOCAPTURE  
1.PRINT QUALITY

## Print Size





---

- 1 Press **Menu/Set**, **4**, **2**.
- 2 Press  or  to select 5"X 3.5", 6"X 4", 7"X 5" or 8"X 10".  
Press **Menu/Set**.
- 3 Press **Stop/Exit**.

PHOTOCAPTURE  
2.PRINT SIZE

## Brightness

---





- 1 Press **Menu/Set**, **4**, **3**.
- 2 Press  or  to select BRIGHTNESS.  
Press **Menu/Set**.
- 3 Press  to make a lighter print  
—OR—  
Press  to make a darker print.  
Press **Menu/Set**.
- 4 Press **Stop/Exit**.

PHOTOCAPTURE  
3.BRIGHTNESS

## Contrast

---

You can choose the contrast setting. More Contrast will make an image look sharper and more vivid.

- 1 Press **Menu/Set**, **4**, **4**.
- 2 Press  or  to select CONTRAST.  
Press **Menu/Set**.
- 3 Press  to increase the contrast  
—OR—  
Press  to decrease the contrast.  
Press **Menu/Set**.



PHOTOCAPTURE  
4.CONTRAST

## 4 Press **Stop/Exit**.

### Color enhancement (True2Life®)



---

1 Press **Menu/Set**, 4, 5.



2 Press  or  to select TRUE2LIFE.

PHOTOCAPTURE  
5.TRUE2LIFE



Press **Menu/Set**.



3 Press  or  to select ON (or OFF).  
Press **Menu/Set**.

 If you select ON, you can customize the White Balance, Sharpness or Color Density.

4 If you selected ON,  
Press  or  to select the WHITE BALANCE.  
Press **Menu/Set**.

To skip the White Balance.

Press  or  to select the SHARPNESS or the COLOR DENSITY.

5 Press  or  to adjust the degree of White Balance.  
Press **Menu/Set**.

6 Repeat Step 4 and Step 5 to adjust the degree of Sharpness and Color Density

—OR—

Press **Stop/Exit**.

#### ■ **White Balance**

This setting adjusts the hue of the white areas of an image. Lighting, Camera settings and other influences will effect the appearance of white. The white areas of a picture may be slightly pink, yellow or some other color. By using this adjustment you can correct this effect and bring the white areas back to pure white.

#### ■ **Sharpness**

This setting enhances the detail of an image. It is similar to adjusting the fine focus on a camera. If the image is not in true focus and you cannot see the fine details of the picture, then adjust the sharpness.

#### ■ **Color Density**

This setting adjusts the total amount of color in the image. You can increase or decrease the amount of color in an image to improve a washed out or weak picture.

## Understanding the Error Messages

---

Once you are familiar with the types of errors that can occur while you're using the PhotoCapture Center™, you can easily identify and troubleshoot any difficulties.

When an error message appears on the LCD, the MFC will beep to get your attention.

**MEDIA ERROR**—This message will appear if you insert a media card that is either bad or not formatted, or when there is a problem with the media drive, or if the DPOF print file on the media card tried to select a .JPG image that is not there. To clear this error, take out the media card.

**NO FILE**—This message will appear if you select PHOTOCAPTURE and the media card in the drive (slot) does not contain a .JPG file.

**OUT OF MEMORY**—This message will appear if you are working with images that are too large for the MFC's memory.

### PhotoCapture Center™ Requirements

To avoid error conditions, please remember:

- The DPOF file on the media card must be in a valid format.
- The image file extension must be .JPG (Other image file extensions .JPEG, .TIF, .GIF and so on will not be recognized).
- Walk-up PhotoCaputure Center™ printing must be performed separately from PhotoCapture Center™ operations using the PC. (Simultaneous operation is not available.)



When printing the INDEX or IMAGE, the PhotoCapture Center™ will print all the valid images, even if one or more images has been corrupted. A portion of the corrupted image may be printed.



## **Using PhotoCapture Center™ from your PC**

You can access the media card that is in the media drive (slot) of the MFC from your PC.

See Using PhotoCapture Center™ from your PC (For Windows®, see *Using the PhotoCapture Center™ from your PC (For Windows®)* on page 18-1. For Macintosh, see *Using the PhotoCapture Center™ from Macintosh®* on page 19-18.)

## **Using PhotoCapture Center™ for scanning originals**

You can scan the originals into a media card. See *Scan to Card* on page 15-17.

# 12 Using the MFC as a printer

## Using the Brother MFC-5200C printer driver

A Printer Driver is software that translates data from the format used by a computer into the format required by a particular printer, using a printer command language or page description language.

The printer drivers are on the CD-ROM we have supplied. Install the drivers first by following the Quick Setup Guide. Also, the latest printer driver can be downloaded from the Brother Solutions Center at:

<http://solutions.brother.com>

## Features

This MFC offers many features you'll find in a high quality ink jet printer.

**Fast Printing Speed**—Using Fast mode, you can print up to 16 pages per minute in full color, and up to 20 pages per minute in black.

**Brilliant High Quality Output**—Printing at 2400 × 1200 dpi resolution on glossy paper gives you highest resolution output.

**Beautiful Elaborate Output**—You can use 2 in 1, Watermark printing, True2Life® technology and other features to get high quality printouts.

**Low Running Cost**—Whenever you run out of a particular color ink, you will only have to replace the cartridge that's empty.

**Bi-directional Parallel Interface**—The parallel interface allows bi-directional (IEEE 1284 compliant) communication with your computer.

**USB**—Universal Serial Bus Interface provides fast communication with your computer.

**Straight Paper Path**—The MFC can print on many types of paper. Plain paper, inkjet paper, glossy paper, transparencies and envelopes. Use the appropriate type of paper to avoid paper jams.

For complete information about what kinds of paper to use with the MFC, please read Chapter 2 'Paper' in this guide.

# Choosing the right type of paper

To get high quality printing using your MFC, it's very important to select the right type of paper. Be sure to read Chapter 2 Paper in this guide before you select and purchase paper for the MFC.

## How to print your document

When the MFC receives data from your computer, it begins printing by picking up paper from the paper tray. The paper tray can feed many types of paper and envelopes.

- 1** From your computer select the Print command.  
If your computer is also connected to any other printers, select **Brother MFC5200C (USB) Printer** as your printer driver from the Print or Print Settings menu in your software application, and then click on OK to begin printing.
- 2** Your computer sends a print command and data to the MFC.  
The LCD shows RECEIVING DATA.
- 3** When the MFC finishes printing all the data, the LCD show the date and time.



You can select the paper source, paper size, and orientation in your application software.

If your application software does not support your custom paper size, select the next larger paper size.

Then adjust the print area by changing the right and left margins in your application software.

Use the manual feed slot for thicker paper.

See *Paper specifications for the manual feed slot* on page 2-3.

# Using the manual feed slot

Your MFC has a manual feed slot at the back of the machine. Use the manual feed slot when you want to print on thicker paper.

 If there is paper in the paper tray you will have to take it out, and then load one sheet of paper at a time in the manual feed slot.

- 1** Take the paper out of the paper tray.
- 2** Open the manual feed slot cover.
- 3** In the manual feed slot, insert one sheet of paper with the side you wish to print on face up.

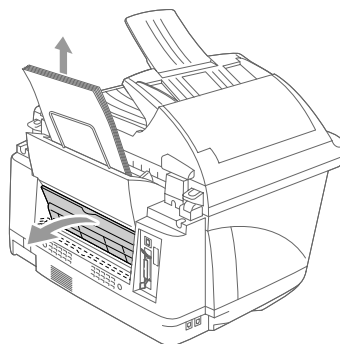

- 4** Align the paper at the center of the manual feed slot and insert it all the way in. Adjust the paper guides to the width of the paper.

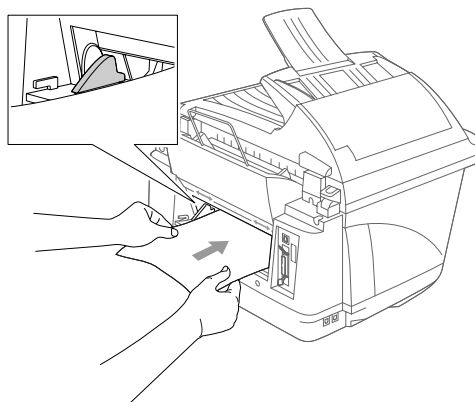

- 5** Open the Setup dialog box of the Windows® printer driver and select Manual Feed in the Paper Feed section. (See *Paper Feed* on page 13-7.)
- 6** Click **OK**.
- 7** The MFC's LCD shows:
- 8** Press **Fax Start** to print.

MANUAL FEED PRESS FAX START
--------------------------------

- 9** Insert the next sheet of paper to continue printing.  
Press **Fax Start**.
- 10** Repeat Step 9 until you have finished printing.
- 11** Close the manual feed slot cover when you finished.



To stop or clear the manual feed, stop it with a PC command and take the MFC offline by pressing the **Stop/Exit** key.

## Simultaneous printing and faxing

Your MFC can print from your computer while sending or receiving a fax, or while scanning a document into the computer. Fax sending will not be stopped during PC printing. However, when the MFC is copying or receiving a fax on paper, it pauses the PC printing operation, and then continues printing when copying or fax receiving has finished.

## Clearing data from the memory

If the LCD shows `DATA REMAINS`, you can clear the data that is left in the printer memory by pressing **Stop/Exit**.

## Checking the Print Quality

If you want to check the print quality and find out how to improve it, See *How to improve print quality* on page 21-10.

# 13 Printer driver settings (Windows<sup>®</sup> Only)

## Printer driver settings

You can change the following printer settings when you print from your computer:

- Media Type/Quality (Speed)
- Page Layout
- Near Edge Print
- Color Matching/Halftone
- Color Enhancement (True2Life<sup>®</sup>)
- Scaling
- Watermark
- Print Date & Time
- Quick Print Setup

## How to access the printer driver settings

- 1 Select **Print** from the **File** menu in your application software.
- 2 Select **Brother MFC5200C (USB) Printer** as your printer and click **Properties**. The **Brother MFC5200C (USB) Printer** dialog box will appear.



The way you access the printer driver settings depends on your operating system and software applications.



The screens shown in this section are from Windows<sup>®</sup> 98 Second Edition. The screens on your Computer may vary depending on your Windows Operating System.

# Basic tab

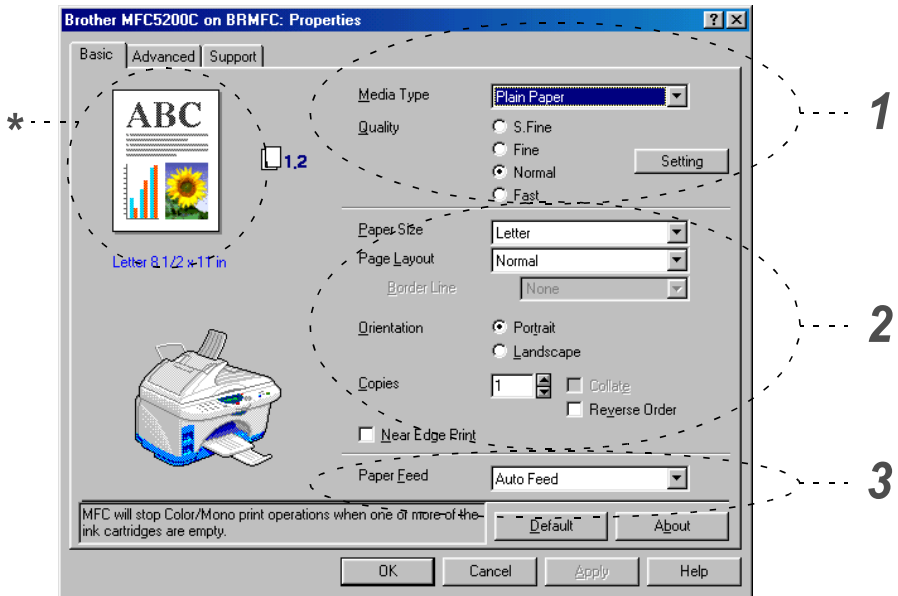

- 1 Select the Media Type and Quality.
- 2 Select the Paper Size, Page Layout, Border Line (if any), Orientation, number of Copies, the page order and Near Edge Print.
- 3 Select the Paper Feed.
- 4 Click the **Apply** button to apply your selected settings. To return to the default settings, click the **Default** button, then click the **Apply** button.

 \* This area shows the current settings of Quality, Paper Size, Page Layout, Orientation, Collate/Reverse Order, Near Edge Print and Color/Grayscale.

## Media Type

---

To achieve the best print results, the media being printed on should be selected in the driver. The MFC changes the way it prints, depending on the selected media type.

**Plain Paper**

**Inkjet Paper**

**Glossy Paper (4 color)**

**Glossy Paper (3 color)**

**Transparencies**



The print quality of black ink depends on the type of glossy paper you are using. Black ink is used when you select **Glossy Paper (4 color)**. If the glossy paper you are using repels the black ink, select **Glossy Paper (3 color)**, which simulates black ink by combining the three ink colors.

## Quality

---

The quality selection allows you to choose the print resolution you want for your document. Print quality and speed are related. The higher the quality the longer it will take to print the document. The quality selections that are available will vary depending on the media type you select.

- **Photo:** 2400 × 1200 dpi. Use this mode to print precise images such as photographs. This is the highest resolution and slowest speed.
- **S.Fine (Super Fine):** 1200 × 1200 dpi. Use this mode to print precise text and photographs. Since the print data is much larger than normal mode, the processing time, data transfer time and print time will be longer.
- **Fine:** 600 × 600 dpi. Better print quality than normal mode and faster print speed than Super Fine.
- **Normal:** 600 × 300 dpi. Good print quality with typical print speed.
- **Fast:** 450 × 150 dpi. The fastest print mode and the lowest ink consumption. Use this mode to print large volume documents or a document for proofing.



Media Type	Color/Mono	Print Quality Selection
Plain Paper	Color/Mono	Fast, <b>Normal</b> , Fine, S.Fine
Inkjet Paper	Color	<b>Fine</b> , S.Fine, Photo
Inkjet Paper	Mono	Fine, <b>S.Fine</b> , Photo
Glossy Paper (4 or 3 color)	Color	S.Fine, <b>Photo</b>
Glossy Paper (4 or 3 color)	Mono	<b>S.Fine</b> , Photo
Transparencies	Color/Mono	<b>Fine</b> , S.Fine



The factory settings are shown in bold.

## Bi-Directional Printing

When **Bi-Directional Printing** is selected, the print heads print in both directions and offer faster print speeds. When not selected, the print heads will only print in one direction to provide higher quality printouts.

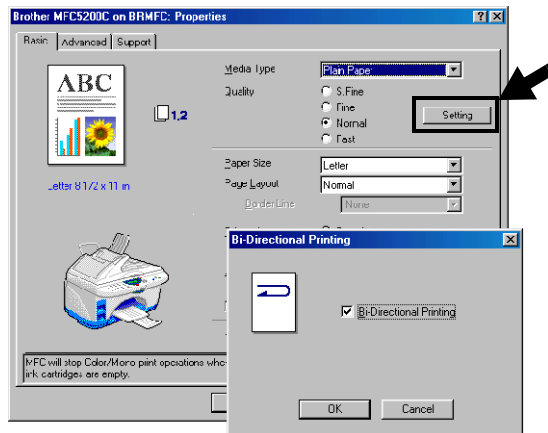

## Paper Size

---

The paper size selection provides a large selection of standard paper sizes. If you wish, you can create a custom size ranging from 3.5" × 4" (88.9 × 101.6 mm) to 8.5" × 14" (216.0 × 355.6 mm). From the drop-down box, select the **Paper Size** you are using.



You can enter custom size by selecting **User Defined**. Select the proper paper thickness to improve the quality of your output.

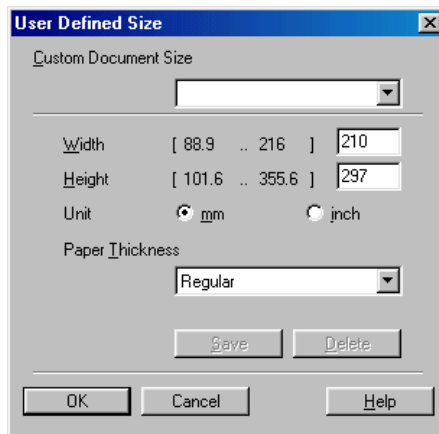

## Page Layout

---

The **Page Layout** selection can reduce the image size of a page allowing multiple pages to be printed on one sheet of paper or enlarging the image size for printing one page on multiple sheets of paper. If you are using Windows® 95/98/98SE, the 4 in 1 layout is not available.

### Border Line

When printing multiple pages on one sheet with the Page Layout feature, you can choose to have a solid border, dashed border or no border around each page on the sheet.

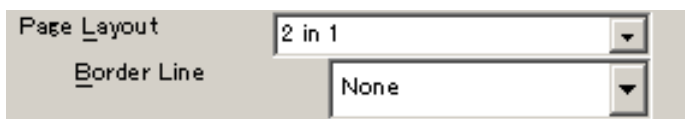

## Orientation

---

Orientation selects the position of how your document will be printed (Portrait or Landscape).

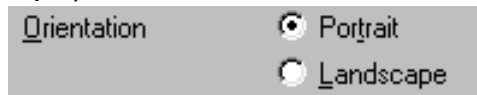

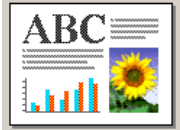
Portrait (Vertical)	Landscape (Horizontal)
	

## Copies

---

The **Copies** selection sets the number of copies that will be printed (1 to 999).

### Collate

With the collate check box selected, one complete copy of your document will be printed and then repeated for the number of copies you selected. If the collate check box is not selected, then each page will be printed for all the copies selected before the next page of the document is printed.

### Reverse Order

**Reverse Order** prints the pages of your document in the opposite order.

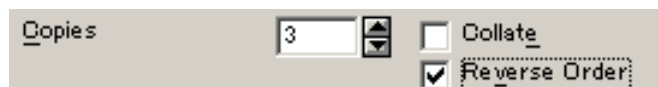

## Near Edge Print

---

Near Edge Print feature expands the printable area at the bottom edge of the paper up to 0.12 inch (3 mm). Print time will be slightly slower.



## Paper Feed

---

The Paper Feed pull-down box allows you to choose how the machine feeds paper.



- **Auto Feed:** The machine feeds subsequent pages automatically.
- **Manual Feed:** The machine feeds one sheet at a time. After the first page is printed, the machine's LCD instructs you to insert a sheet of paper. Use this mode if you are using the Manual Feed Slot for thicker paper. (See *Using the manual feed slot* on page 12-3.)

# Advanced tab

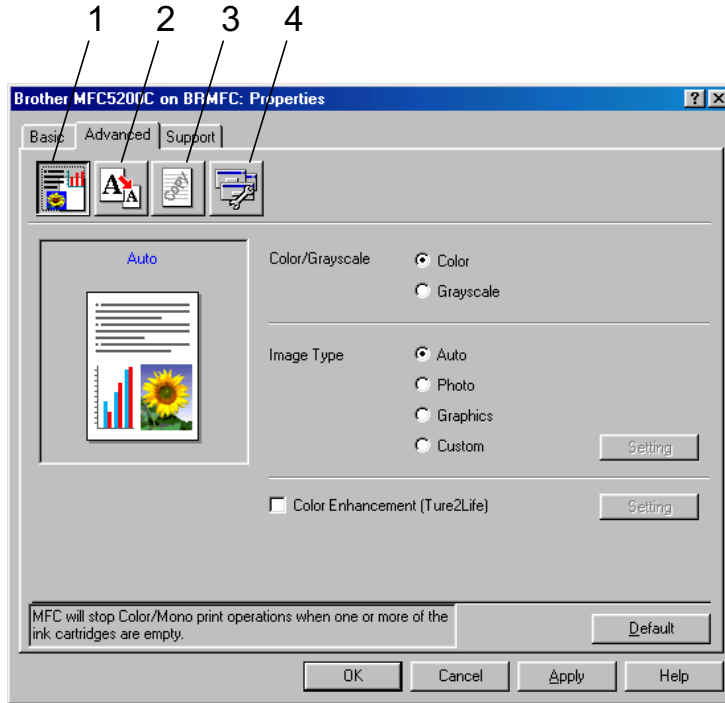

To return to the default settings, click the **Default** button.

Change the tab settings by selecting one of the following icons:

**1.Color**

**2.Scaling**

**3.Watermark**

**4.Device Options**

# Color

---

## Color/Grayscale

This selection allows a color document to be printed in black and white using gray scale.

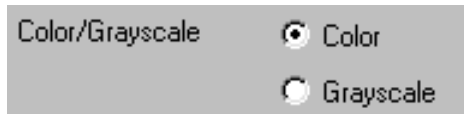

## Image Type

The printer driver will select the most suitable color matching and half tone method, depending on your image type. Generally, text and business graphics are printed vividly and photographic images are printed softly.

- **Auto:** The printer driver automatically selects the image type.
- **Photo:** Select this mode for photographic images.
- **Graphics:** Select this mode for documents that contain text or business graphics (charts or clip art).
- **Custom:** If you want to select the color matching and halftone method, manually select this mode.

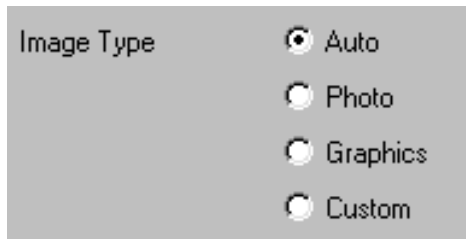

## Custom Image Type

You can select the color matching method manually. Select the best one for your document.

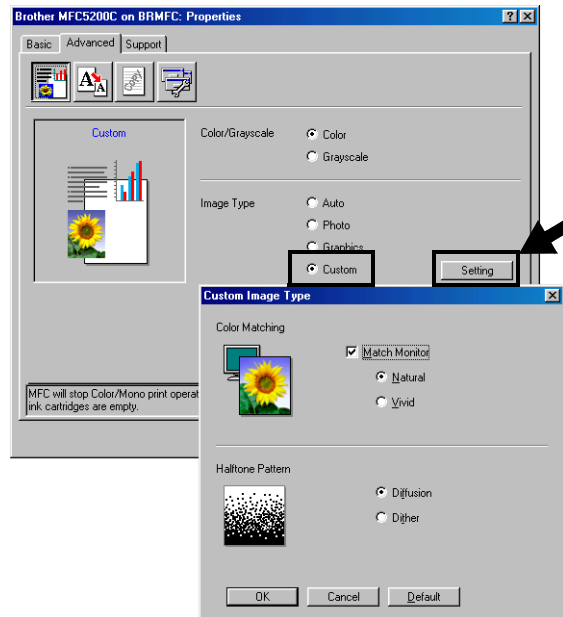

### Match Monitor

Color is adjusted to get the closest color match to the PC monitor.

- **Natural:** Suitable for photographic images. This color is adjusted to set the natural color.
- **Vivid:** Suitable for business graphics such as charts, graphics and text. The color is adjusted to give more vivid color.

### Halftone Pattern

The MFC can use two methods (**Diffusion** or **Dither**) to arrange where to place dots to express halftones. There are some predefined patterns set for this and you can select which one to use for your document. Select the appropriate method.

- **Diffusion:** Dots are placed at random to create the halftones. This method of printing is more suitable for printing photographs that have delicate shades and graphics.
- **Dither:** Dots are arranged in a pre-defined pattern to make halftones. This type of printing is more suitable to printing graphics that have definite color boundaries or for printing charts such as business charts.



Some halftone settings cannot be selected with certain combinations of Media Type and Quality selections.

## Color enhancement (True2Life®)

Selecting Color Enhancement (True2Life®) enables the True2Life® feature. This feature analyzes your image to improve quality sharpness, white balance and color density. This process may take several minutes depending on the size of the image and the specifications of your computer.

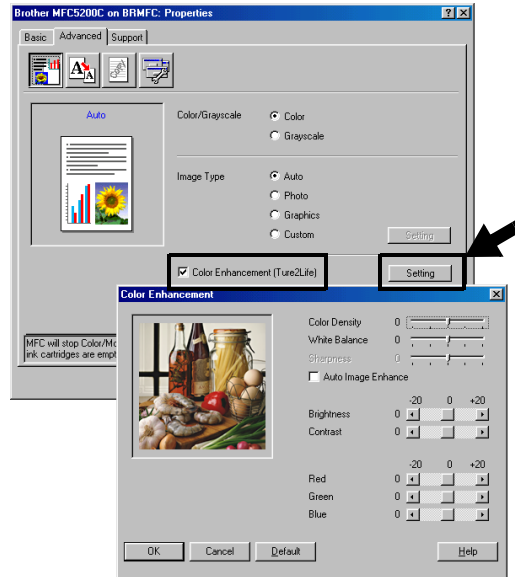

### ■ Color Density

This setting adjusts the total amount of color in the image. You can increase or decrease the amount of color in an image to improve a washed out or weak picture.

### ■ White Balance

This setting adjusts the hue of the white areas of an image. Lighting, camera settings and other influences will effect the appearance of white. The white areas of a picture may be slightly pink, yellow or some other color. By using this adjustment you can correct this effect and bring the white areas back to pure white.

### ■ Sharpness

This setting enhances the detail of an image. It is similar to adjusting the fine focus on a camera. If the image is not in true focus cannot see the fine details of the picture, then adjust the sharpness.

### ■ Auto Image Enhance

Auto Image Enhance allows individual adjustment of picture settings to improve the printed image and analyzes data from surrounding or neighboring pixels in the original.



■ **Brightness**

This setting adjusts the brightness of the whole image. To lighten or darken the image move the scroll bar to the left or right.

■ **Contrast**

This setting adjusts the contrast of an image. This will make darker areas darker and lighter areas lighter. Increase the contrast when you want an image to be clearer. Decrease the contrast when you want an image to be more subdued.

■ **Red**

Increases the intensity of the Red color to make the image redder.

■ **Green**

Increase the intensity of the Green color to make the image greener.

■ **Blue**

Increase the intensity of the Blue color to make the image bluer.

# Scaling

You can change the print size of your document with the **Scaling** feature.

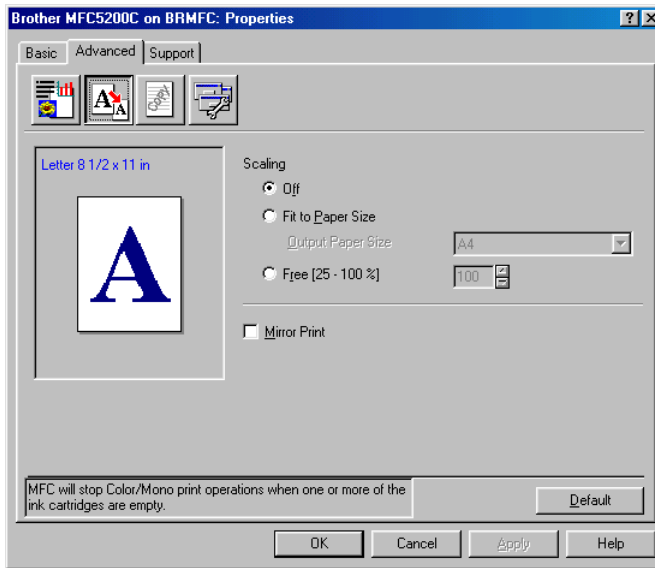

- Check Off if you want to print the document as it appears on your screen.
- Check Fit to Paper Size, if your document has an unusual size, or if you have only the standard size paper.
- Check Free if you want to reduce the size.
- Check Mirror Print to reverse the data from left to right.

## Watermark

You can place a logo or text into your document as a Watermark. You can select one of the preset Watermarks, or you can use a bitmap file or text file that you have created.

Check **Use Watermark**, and then select the watermark you want to use.

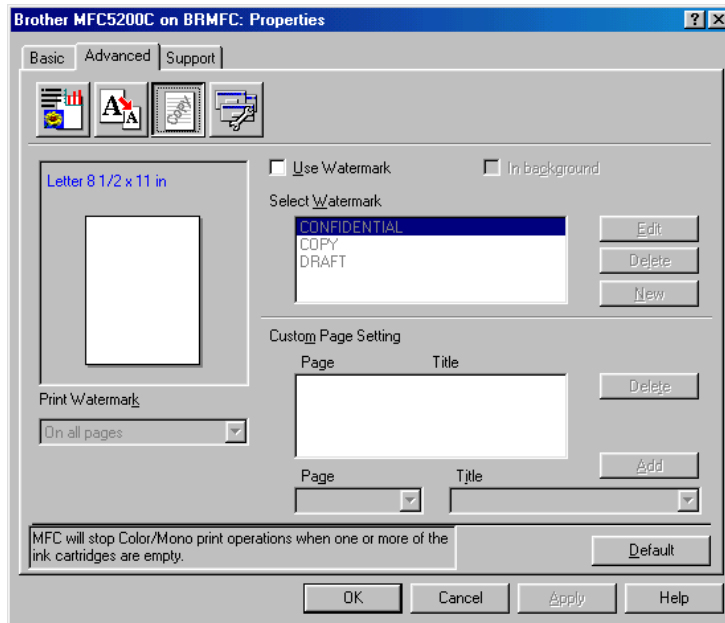

### In background

Check **In background** with the Watermark to print the watermark image in the background of your document. If this feature is not checked then the Watermark will be printed on top of your document.

### In Outline Text (Windows® 2000 Professional/XP/Windows NT® 4.0 Only)

Check **In Outline Text** if you only want to print an outline of the watermark.

### Print Watermark

The **Print Watermark** feature offers the following print choices:

- On all pages
- On first page only
- From second page
- Custom

## Watermark Style

You can change the Watermark's size and position on the page by selecting the Watermark, and clicking the **Edit** button. If you want to add a new Watermark, click the **New** button, and then select Text or Bitmap in the Watermark Style.

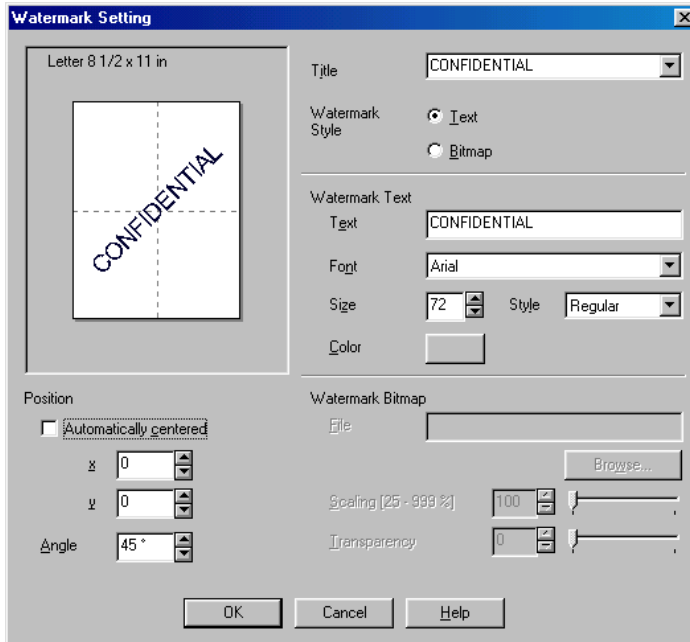

### ■ Watermark Text

Enter your Watermark text into the Text Box, and then select the Font, Size, Color and Style.

### ■ Watermark Bitmap

Enter the file name and location of your bitmap image in the File box, or Browse for the file location. You can also set the scaling size of the image.

### ■ Position

This setting offers you the control for where the Watermark is to be positioned on the page.

# Device Options

Lets you set the following Printer Functions:

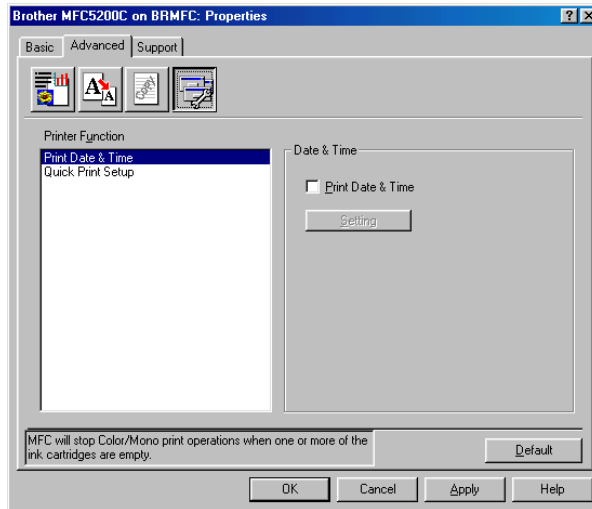

## Print Date & Time

When enabled the Print Date and Time feature will print the date and time on your document from your computer's system clock.

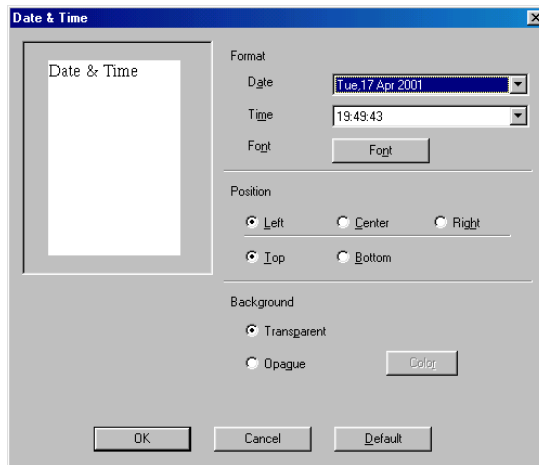

Click the Setting button to change the Date and Time format, and the Position and Font. To include a background with the Date and Time, select Opaque. When Opaque is selected, you can click on the Color button to change the color of the Date and Time background.



The Date and Time in the selection box shows the format that will be printed. The actual Date and Time printed on your document is automatically retrieved from the settings of your computer.

# Quick Print Setup

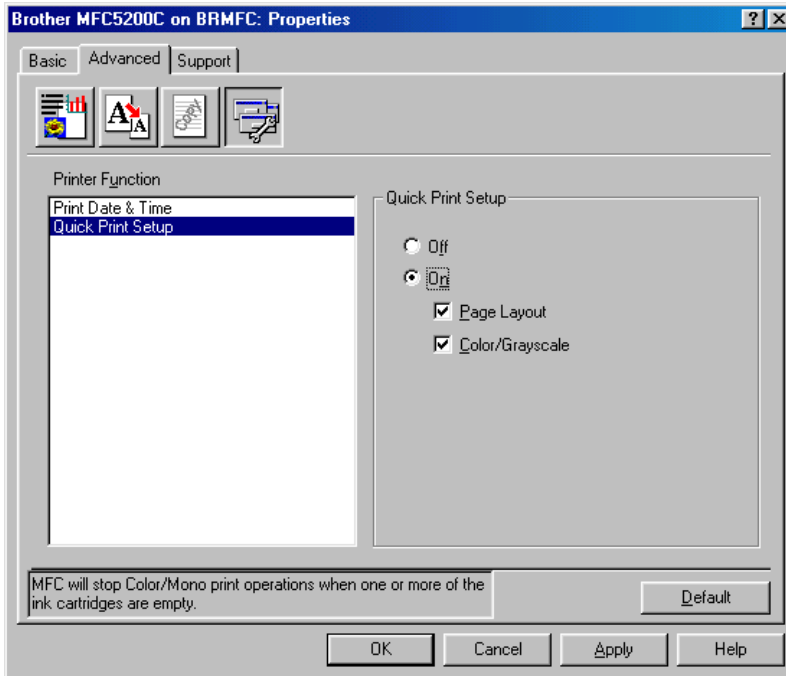

The **Quick Print Setup** feature allows you to quickly select driver settings. To view settings, simply click your mouse button on the task tray icon. This feature can be set to **ON** or **OFF** from the **Device Options**.

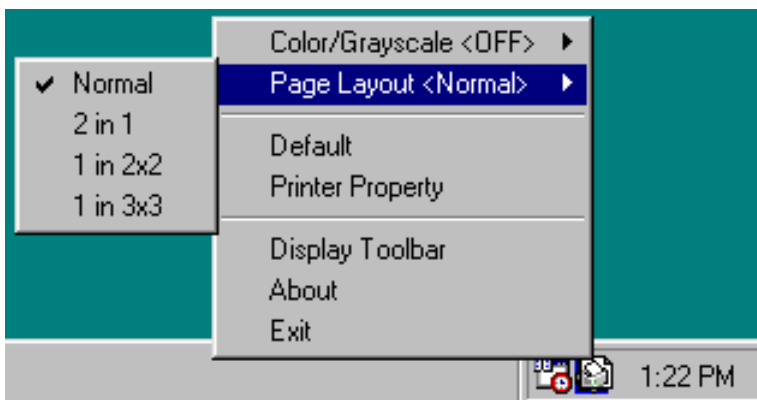

## Support tab

The Support Tab provides driver version and setting information. In addition there are links to the Brother Solutions Center and the Driver Update Web sites.

Click the Support tab to display the following screen:



### Brother Solutions Center

The Brother Solutions Center is a Web site offering information about your Brother product including FAQs (Frequently Asked Questions), User Guides, Driver Updates and Tips for using your machine.

### Web Update

Web Update checks the Brother web site for updated drivers, and automatically downloads and updates the printer driver on your computer.

### Check Setting

The Check Setting selection displays a list of your current driver settings.

# 14 Using the Brother Control Center for Windows® 95/98/98SE/Me/2000 Professional and Windows NT® WS 4.0



- For Windows® XP, please see the smartUI User's Guide, which is in the PaperPort® Program Group on your PC. (The MFL Pro Software Suite must be installed.)
- If you are using Windows® 2000 Professional, we recommend that you are logged on as an administrator.

## Brother MFL-Pro Control Center

The Brother Control Center is a software utility that pops up on the PC screen whenever paper is put in the ADF of the MFC. This allows you to quickly and with very few mouse clicks, to access the most frequently used scanning applications. Using the Control Center stops the need to manually startup any specific applications.

The Brother Control Center provides three operations (Scan, Copy and PC-Fax):

- Scan directly to a file, E-mail, word processor or graphic application of your choice
- Copy
- PC Fxing using the Brother MFL Pro PC-FAX software







# AutoLoad the Brother Control Center

---

The Control Center is loaded every time Windows® is started.

When the Control Center is loaded, the Control Center  icon will appear on the task bar.



If you don't want the Control Center to load automatically, you can turn off AutoLoad.

 If the Control Center  icon does not appear on your task bar, you will have to launch the software.

From the **Start** menu, select **Programs, ScanSoft PaperPort 8.0**, and then click **Brother SmartUI POPUP**.

## How to turn off AutoLoad

---

- 1 Left-click the Control Center  icon and click Show.
- 2 When the Control Center window appears, left click the Smart Click  Control Center button.

A dialogue box will appear:

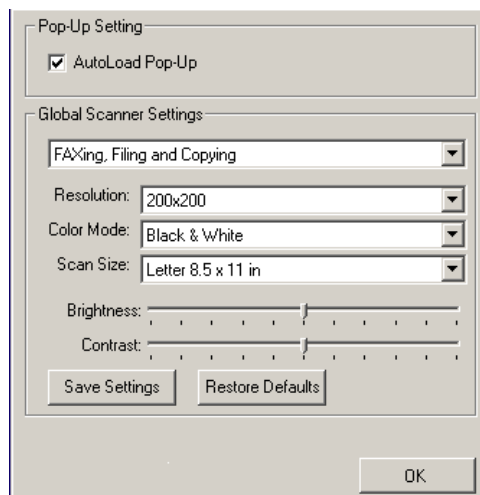

- 3 Unchecked the 'AutoLoad' Pop-Up check box.

# Brother Control Center Features

## Auto Configuration

---

During installation the Control Center will check your system to set up the default applications for E-mail, word processing and the graphics viewer/editor.

For example, if you are using Outlook as your default E-mail application, the Control Center will create a link and a scanning application button for Outlook.

You can change a default application. Right-click the appropriate Control Center button to display *Configurations* and then click it. Select a different application.

For example, you can change a scan button from MS Word Pad



to MS Word



by changing the application that is listed for the Word Processor.



## Scanning operations

---

*Scan to File*—Lets you to scan directly to a file with two mouse clicks. You can change the file type and directory.

*Scan to E-mail*—Lets you, with just two mouse clicks, scan a picture or text document directly into an E-mail application as a standard attachment. You can choose the file type and resolution for the attachment.

*Scan to Word Processor*—Lets you to scan a text document, run ScanSoft TextBridge OCR and insert the text original (not graphic image) into a word processing file with just two mouse clicks. You can choose word processing application, such as Word Pad, MS Word, Word Perfect, and so on.

*Scan to Graphic Application*—Lets you to scan an image directly into any graphic viewer/editor application. You can choose the graphics application, such as Microsoft Paint or Corel PhotoPaint.

## Copy operations

---

*Copy*—Lets you use the PC and any Windows® printer driver for enhanced copy operations.

You can scan the page on the Brother MFC and print the copies using any of the features of the Brother MFC printer driver.

—OR—

You can send the copy output to any standard Windows® printer driver that is on your PC.

## PC-Fax operation

---

*Send a Fax*—Lets you scan a picture or text original and send the image as a fax from the PC using the Brother PC-FAX software.

## Scanner settings for Scan, Copy and PC-Fax buttons

---

When the Pop-Up screen appears, you can access the Scanner Settings window.

Click the Smart Click  icon at the top right of the Brother Control Center screen

—OR—

Click the **Modify Settings** button on any of the Configuration screens.

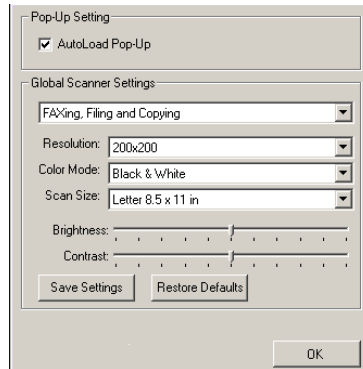

## Global settings

---

*AutoLoad Pop-Up*—Select this checkbox if you want Brother MFL Control Center to load when you turn on your computer.

## Setting up the scanner configurations

---

The Pop-Up application stores eight different scanning modes. Each time you scan an original, you can choose the most appropriate scanning mode from the following:

*Faxing, Filing and Copying*  
*Text for OCR*  
*Photos*  
*Photos (High Quality)*  
*Photos (Quick Scan)*  
*Custom*  
*Draft Copy*  
*Fine Copy*

Each mode has its own set of stored settings. You can keep the factory default settings or change them at any time:

*Resolution*—From the pull-down list, select the scanning resolution you most often use.

*Color Mode*—From the pull-down list, select the color settings you most often use.

*Scan Size*—From the pull-down list, select the scan size you most often use.

*Brightness*—Slide the adjuster from 0% to 100%

*Contrast*—Slide the adjuster from 0% to 100%

Click **OK** to save your changes. If you make a mistake or want the original default setting, just click the **Restore Defaults** button when the scanning mode is displayed.

## To access the scanner Configurations screen

---

- 1 Place the original face up in the ADF. The Brother Control Center screen will pop up.
- 2 Right-click the appropriate Control Center button to display *Configurations* and then click on it. Click the **Modify Settings** button. The configuration screen for the **Control Center** button will appear.
- 3 To save your settings, click the **OK** button  
—OR—  
To go back to the factory default settings, click the **Restore Defaults** button.

## Perform an operation from the Control Center screen

---

If you see this screen it means you left-clicked a button in the Control Center window without first placing an original in the ADF.

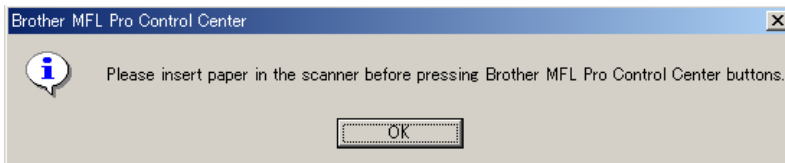

Place the original in the MFC ADF and then click **OK** to go to the Control Center screen.



If you want to scan the original from the scanner glass, please use the **Scan to** key on the control panel of the machine.

# Scan to File

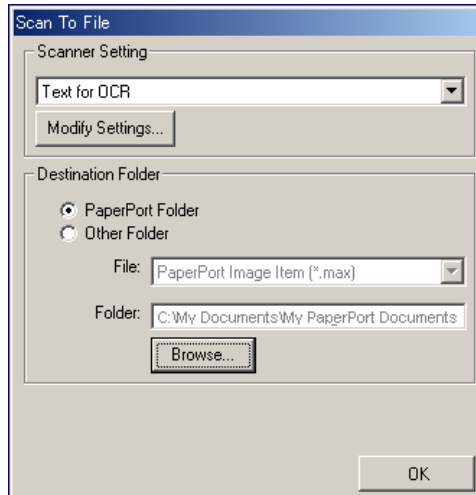

## Scanner settings

---

From the pull-down list, select the scanning mode that is appropriate for the type of file: Faxing, Filing and Copying; Text for OCR; Photos; Photos (High Quality); Photos (Quick Scan); Custom; Draft Copy or Fine Copy.

To change any of the settings for the mode, click **Modify Settings**.

## Destination folder

---

*PaperPort Folder*—Select this checkbox to scan the original into your PaperPort folder.

*Other Folder*—Select this checkbox, to scan the original as another file type or to store it in another directory/folder.

*File*—If you selected Other folder from the pull-down list, select the type of file:

- PaperPort Image Item (\*.max)
- PaperPort Self-Viewing (\*.exe)
- PaperPort Browser-Viewable (\*.htm)
- PaperPort 5.0 Image Item (\*.max)
- PaperPort 4.0 Image Item (\*.max)
- PaperPort 3.0 Image Item (\*.max)
- Windows Bitmap (\*.bmp)
- PC Paintbrush (\*.pcx)
- PCX Multi-page (\*.dcx)
- JPEG (\*.jpg)
- TIFF-Uncompressed (\*.tif)
- TIFF-Group 4 (\*.tif)
- TIFF-Class F (\*.tif)
- TIFF Multi-page - Uncompressed (\*.tif)
- TIFF Multi-page - Group 4 (\*.tif)
- TIFF Multi-page - Class F (\*.tif)
- Portable Network Graphics (\*.png)
- FlashPix (\*.fpx)

To Search your system for the directory and folder you want, click the **Browse** button. Click **OK** to save your settings.



# Scan to E-mail

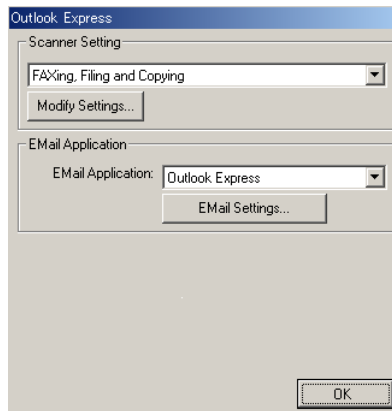

## Scanner settings

---

From the pull-down list, select the scanning mode that is appropriate for the type of file: Faxing, Filing and Copying; Text for OCR; Photos; Photos (High Quality); Photos (Quick Scan); Custom; Draft Copy or Fine Copy.

To change any of the settings for this mode, click **Modify Settings**.

## E-mail application

---

*E-mail Application*—From the pull-down list, select your E-mail application.

*E-mail Settings*—Click the **E-Mail Settings** button to set up links. The **Send To Options** window will appear:

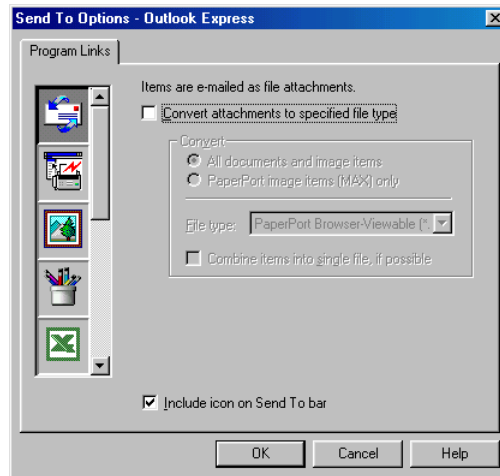

## Send to Options

---

*Convert attachments to specified file type*—Converts items to the type in the **File Type** box. Clear this check box to keep files in their source format; for example, to keep Word documents in the .doc format and JPEG images in the .jpg format.

*All documents and image items*—Converts all items regardless of the program in which the item was created; for example, converts all Word (doc) files and JPEG (.jpg) files to the file type.

*PaperPort image items (max) only*—Converts only PaperPort image items (.max) files. PaperPort does not convert other file types, such as JPEG images and Word documents.

*File type*—Identifies the format in which to convert items; for example, JPEG or TIFF.

*Combine items into a single file attachment*—Combines all selected items into a single file that contains multiple pages. This option is available only when the file type supports multiple pages, such as multi-page TIFF.

# Scan to Word Processor

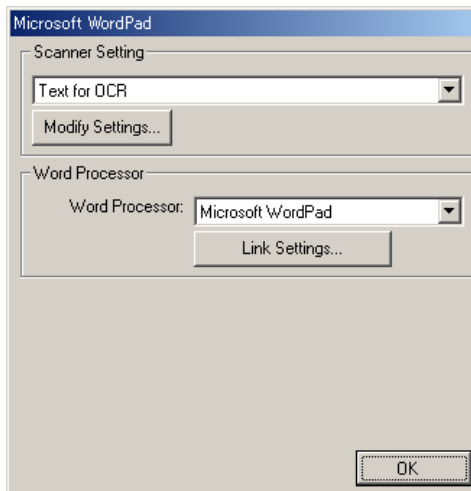

## Scanner settings

---

From the pull-down list, select the scanning mode that is appropriate for the type of file: Faxing, Filing and Copying; Text for OCR; Photos; Photos (High Quality); Photos (Quick Scan); Custom; Draft Copy or Fine Copy.

To change any of the settings for this mode, click **Modify Settings**.

# Word Processor

*Word Processor*—From the pull-down list, select the word processor you want to use.

Click the **Link Settings** button to display the screen to set up the document format you want to use and identify the OCR program:

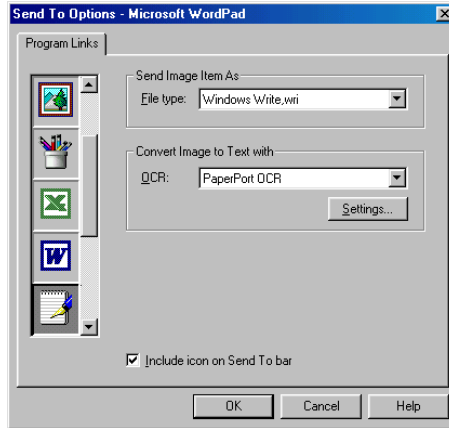

*File Type*—From the pull-down list, select the file type you want to use for your word processor or text documents.

*OCR*—Identify the OCR program to use to convert scanned document images to editable documents. This option is available only when you have an OCR program other than the one provided with PaperPort. (PaperPort 8.0 uses the same OCR engine that is in ScanSoft's TextBridge Pro Millennium product.)

Click the **Settings** button to choose how the OCR application will read the pages that you scan into your word processor application.

The OCR Settings window will appear:

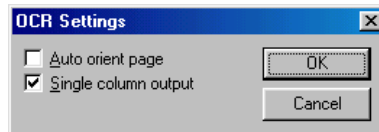

Select your setting and click **OK**.

- *Auto orient page*—Click this checkbox to automatically rotate pages so that the text is upright.
- *Single column output*—Click this checkbox if you want to remove columns from multi-column documents so that converted text appears in a one-column format.

# User-defined button

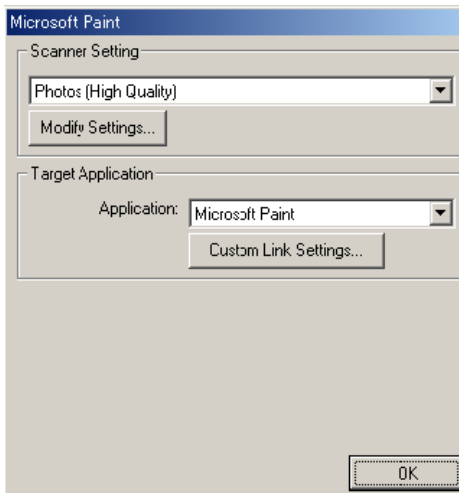

## Scanner Settings

---

From the pull-down list, select the scanning mode that is appropriate for the type of file: Faxing, Filing and Copying; Text for OCR; Photos; Photos (High Quality); Photos (Quick Scan); Custom; Draft Copy or Fine Copy.

To change any of the settings for this mode, click **Modify Settings**.

## Target Application

---

*Application*—From the pull-down list, select the application you want to add to this Pop-Up screen.

Click the **Custom Link Settings** button to set up links for your user-defined application.

# Copy

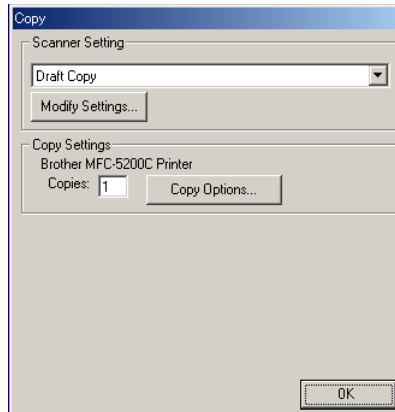

## Scanner settings

---

From the pull-down list, select the scanning mode that is appropriate for the type of file: Draft Copy or Fine Copy.

To change any of the settings for this mode, click **Modify Settings**.

## Number of copies

---

*Copies*—Enter the number of copies you want to print.

To change the copy options, click the **Copy Options** button.

Click **OK** to save your Copy settings.

# Send a fax

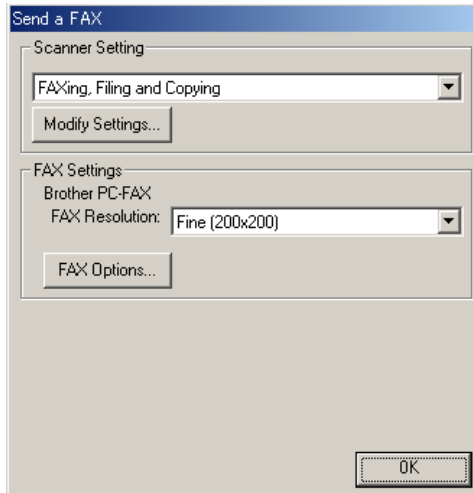

## Scanner settings

---

From the pull-down list, select the scanning mode that is appropriate for the type of file: Faxing, Filing and Copying; Text for OCR; Photos; Photos (High Quality); Photos (Quick Scan); Custom; Draft Copy or Fine Copy.

To change any of the settings for this mode, click **Modify Settings**.

# FAX Settings

## Brother PC-Fax

### FAX Resolution—Fine (200 × 200)

- 1 To change the fax options, click the **FAX Options** button. The Brother PC-FAX Properties screen appears:  
(For Windows® 95/98/98SE/Me and Windows NT® WS 4.0)

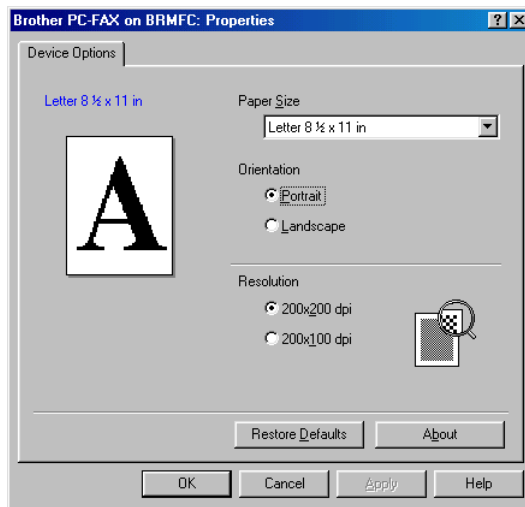

(For Windows® 2000 Professional)

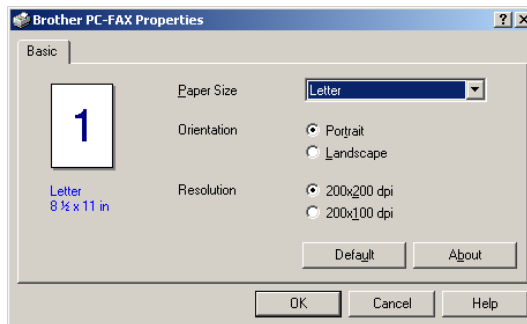

- 2 Select the Paper Size and Orientation (Portrait or Landscape) and click **OK**.



To go back to the factory default settings, click the **Restore Defaults** or **Default** button.



# 15 How to scan using Windows®



The scanning operations and drivers will be different depending on your operating system.

## **For Windows® 95/98/98SE/Me/2000 Professional and Windows NT® Workstation 4.0**

The MFC uses a TWAIN Compliant driver for scanning documents from your applications. See *Scanning a document, TWAIN compliant* on page 15-1.

## **For Windows® XP**

Use Windows® Imaging Acquisition (WIA) for scanning documents. (See *Scanning a document (For Windows® XP only)* on page 15-10.)



## **For ScanSoft™, PaperPort® and TextBridge® OCR**

Go to *Using ScanSoft™ PaperPort® and TextBridge® OCR* on page 15-19.

## **Scanning a document**

### **TWAIN compliant**

---

The Brother Multi-Function Link® Pro software includes a TWAIN compliant scanner driver. TWAIN drivers meet the standard universal protocol for communicating between scanners and software applications. This means that not only can you scan images directly into the PaperPort® viewer that Brother included with your MFC, but you can also scan images directly into hundreds of other software applications that support TWAIN scanning. These applications include popular programs like Adobe® Photoshop®, Adobe® PageMaker®, CorelDraw® and many more.

# How to Access the Scanner

- 1 Open the software application (ScanSoft™ PaperPort®) to scan a document.



The instructions for scanning in this guide are for when you use ScanSoft™ PaperPort® Ver. 8.0.

- 2 Select **Scan** from the File drop-down menu or select the **Scan** button. The **Scan** pane appears in the left panel.
- 3 Select **TWAIN\_32 Brother MFL Pro Scanner** from the **Scanner** drop-down list box.

The **TWAIN\_32 Brother MFL-Pro Scanner Setup** dialog box will appear:

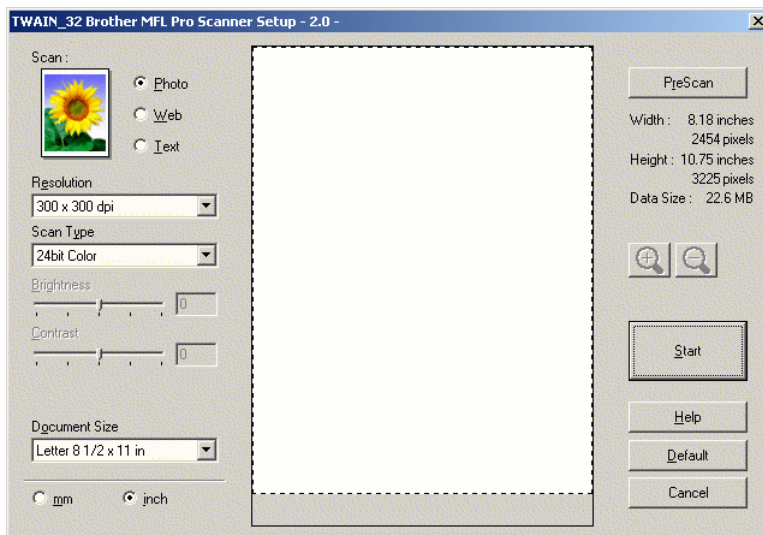

# Scanning a document into the PC

---

You can scan a whole page

—OR—

scan a portion of the page after pre-scanning the document.

## Scanning a whole page

- 1 Place the original face up in the ADF (automatic document feeder), or face down on the scanner glass.
- 2 Adjust the following settings, if required, in the Scanner window:
  - Image Type
  - Resolution
  - Scan Type
  - Brightness
  - Contrast
  - Document Size



After you select a document size, you can adjust the scanning area further by clicking the left mouse button and dragging it. This is required when you want to crop an image when scanning.

For details, see *Settings in the Scanner window* on pages 15-6.

- 3 Click the **Start** button in the scanner window. When scanning is completed, click **Cancel** to return to the PaperPort® window.

## PreScanning to crop a portion you want to scan

The **Pre-Scan** button is used to preview an image for cropping any unwanted areas from the image. When you are satisfied with the preview, click the **Start** button in the scanner window to scan the image.

- 1 Place the original face up in the ADF, or face down on the scanner glass.

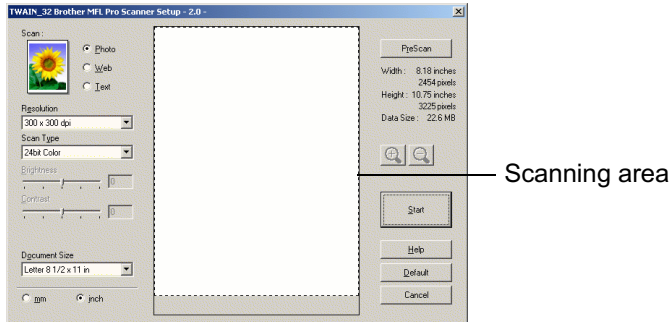

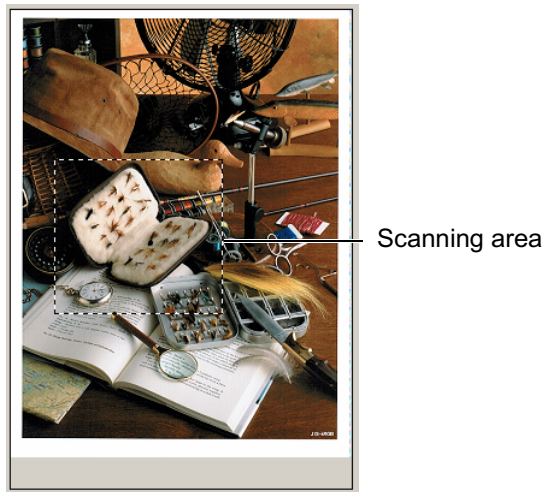

- 2 Select the settings for **Image Type**, **Resolution**, **Scan Type**, **Brightness** and **Contrast**, as needed.
- 3 In the **Twain\_32 Brother MFL Pro Scanner Setup** dialog box, click the **PreScan** button.  
The entire original will be scanned into the PC and will appear in the Scanning Area.



- 4 Select the portion you want to scan by clicking the left mouse button and dragging it.



You can enlarge the portion you selected by pressing  to check it. If you want to select the different portion, use  to undo the image.

- 5** Place the original face up in the ADF again, if you used the ADF in step 1.
- 6** Click **Start**.  
This time only the selected area of the original will appear in the PaperPort<sup>®</sup> window (or your software application window).
- 7** In the PaperPort<sup>®</sup> window, use the options available to refine the image.

# Settings in the Scanner window

---

## Image Type

Select the image type of output from Photo, Web or Text. Resolution and Scan Type will be altered for each default setting.

The default settings are:

Image Type		Resolution	Scan Type
<b>Photo</b>	Select for scanning photo images.	300 x 300 dpi	24-bit color
<b>Web</b>	Select for attaching the scanned image to web pages.	100 x 100 dpi	24-bit color
<b>Text</b>	Select for scanning text documents.	200 x 200 dpi	Black & White

## Resolution

You can change the scanning resolution from the **Resolution** drop down list. Higher resolutions take more memory and transfer time, but can achieve a finer scanned image. The following table shows the resolution you can choose and the available colors.

Resolution	Black & White / Gray (Error Diffusion)	256 color	True Gray / 24 bit color
100 × 100 dpi	Yes	Yes	Yes
150 × 150 dpi	Yes	Yes	Yes
200 × 200 dpi	Yes	Yes	Yes
300 × 300 dpi	Yes	Yes	Yes
400 × 400 dpi	Yes	Yes	Yes
600 × 600 dpi	Yes	Yes	Yes
1200 × 1200 dpi	Yes	No	Yes
2400 × 2400 dpi	Yes	No	Yes
4800 × 4800 dpi	Yes	No	Yes
9600 × 9600 dpi	Yes	No	Yes

## Scan Type

**Black & White:** Set the Scan Type to Black & White for text or line art.

**Gray Scale:** Set the Scan Type to Gray or True Gray for photographic images.

**Colors:** Set either:

256 Color, which scans up to 256 colors, or 24-bit color which scans up to 16.8 million colors.

Although using 24-bit color creates an image with the most accurate colors, the image file will be approximately three times larger than a file created with 256 Color.

## Brightness

Adjust this settings (-50 to 50) to obtain the best image. The default value is 0, representing an 'average'.

You can set the level by dragging the slide bar to the right or left to lighten or darken the image. You can also type a value in the box for the setting.

If the scanned image is too light, set a lower brightness value and scan the document again. If the image is too dark, set a higher brightness value and scan the document again.

## Contrast

This setting is adjustable only when you have selected one of the gray scale settings. It is not available when Black & White and color settings are selected as the Scan Type.

You can increase or decrease the contrast level by moving the slide bar to the left or right. An increase emphasizes dark and light areas of the Image, while a decrease reveals more detail in gray areas. You can also type a value in the box for the setting.

## Document Size

Set the Size to one of the following:

- Letter (8 1/2 × 11 in.)
- A4 (210 × 297 mm)
- Legal (8 1/2 × 14 in.)
- A5 (148 × 210 mm)
- B5 (182 × 257 mm)
- Executive (7 1/4 × 10 1/2 in.)
- Business Card (90 × 60 mm)
- Photo 3.5 × 5 in. (9 × 13cm)
- Photo 5 × 7 in. (13 × 18cm)
- APS C 4 × 6 in. (10 × 15cm)
- Custom (User adjustable from 0.35 × 0.35 in. to 8.5 × 14 in.)

To scan photographs or business cards, select the document size, and then place the document face down at the center of scanner glass.

When scanning photographs or other images for use in a word processor or other graphics application. You should try different settings for the contrast and resolution modes to see which best suits your needs.

If you selected **Custom** as the size, The **Custom Document Size** dialog box will appear.

Type the **Name**, **Width** and **Height** for the document.

You can choose “mm” or “inch” as the unit for Width and Height.

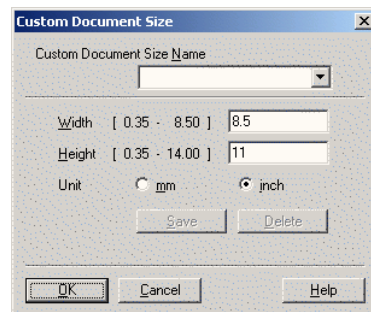





You can see the actual paper size you selected on the screen.

- **Width:** shows the width of scanning area
- **Height:** shows the height of scanning area
- **Data Size:** shows the approximate data size calculated in a Bitmap format. The size will be different for other file formats such as JPEG.

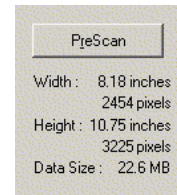

# Scanning a document (For Windows® XP only)

## WIA compliant

---

Windows® XP uses Windows Image Acquisition (WIA) for scanning images from the MFC. You can scan images directly into the PaperPort® viewer that Brother included with your MFC or you can scan images directly into any other software application that supports WIA or TWAIN scanning.

## How to access the scanner

---

- 1 Open your software application to scan a document.  
 The instructions for scanning in this guide are for when you use ScanSoft™ PaperPort® ver.8.0. The steps for scanning from another application may vary.
- 2 Select **Scan** from the **File** drop-down menu or select the Scan button.  
The **Scan** pane appears in the left panel.
- 3 Select the scanner you are using from the **Scanner** drop-down list box.  
The Scan dialog box will appear:

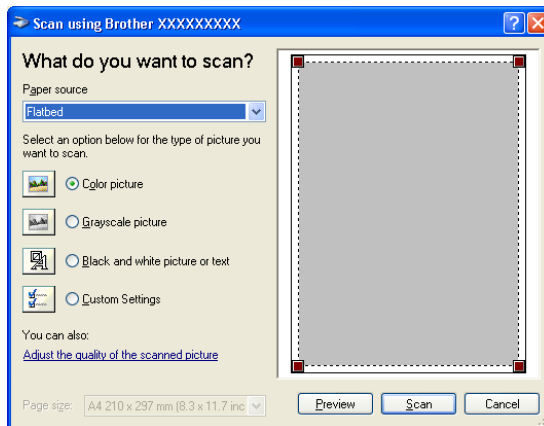

## Scanning a document into the PC

---

If you want to scan a whole page, use the ADF (automatic document feeder).

—OR—

If you want to scan a portion of the page after pre-scanning the document, use the scanner glass (Flatbed).

## Scanning a document using the ADF

- 1 Place the original face up in the ADF (automatic document feeder).

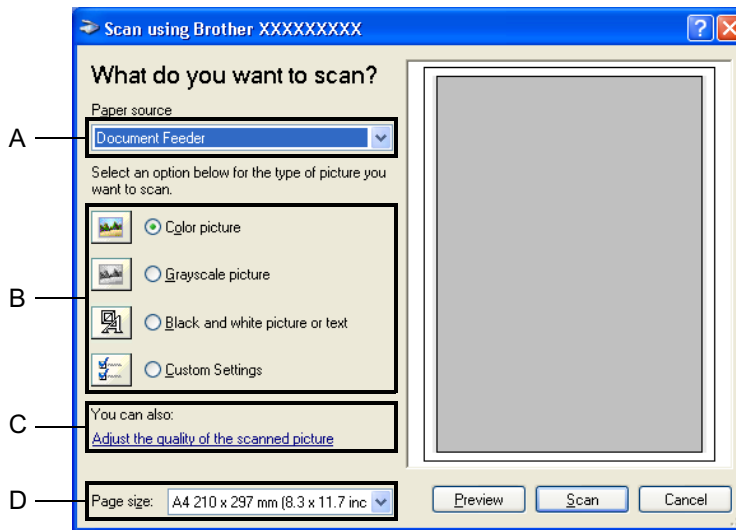

- 2 Select the **Document Feeder** from the **Paper source** drop-down list box (A).
- 3 Select the picture type (B).
- 4 Select the **Paper size** from the drop-down list box (D).
- 5 If you require advanced settings, click **Adjust the quality of the scanned picture** (C). You can select **Brightness**, **Contrast**, **Resolution** and **Picture Type** from the **Advanced Properties**. Click the **OK** button after you choose your settings.

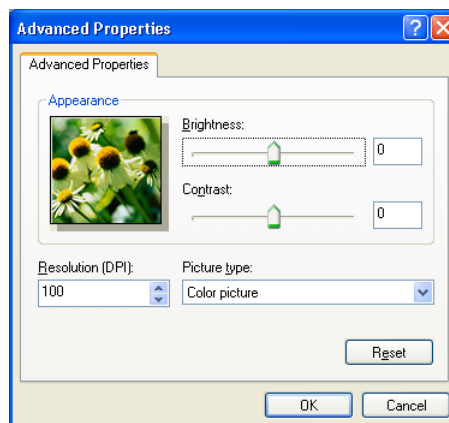



The scanner resolution you can select is up to 1200 × 1200 dpi.

- 6 To start scanning your document, click the **Scan** button in the Scan dialog box.

## PreScanning to crop a portion you want to scan using the Scanner Glass

The **Preview** button is used to preview an image for cropping any unwanted portions from the image. When you are satisfied with the preview, click the Scan button from the scanner window to scan the image.

- 1 Place the original face down on the scanner glass.
- 2 Make sure you selected Flatbed in the Paper source pull-down box (A).

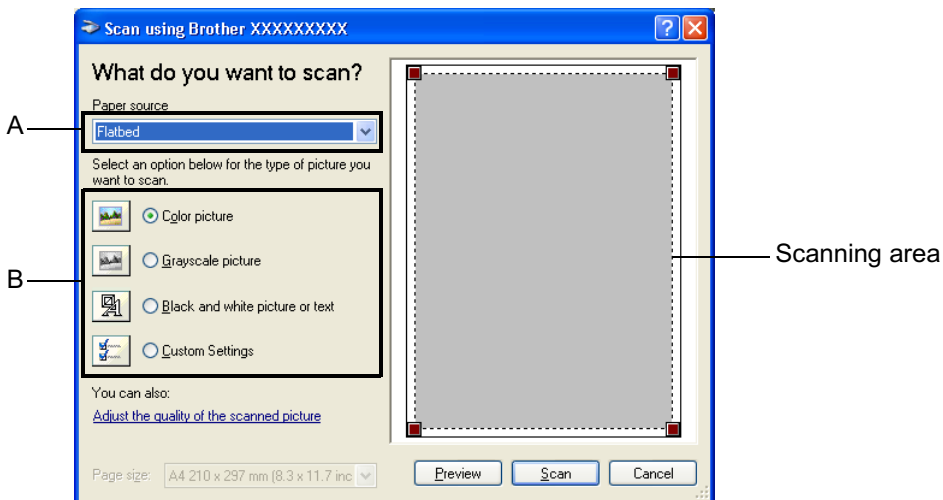

- 3 Select the picture type (B).
- 4 In the Scan dialog box, click the **Preview** button. The entire original will be scanned into the PC and will appear in the scanning area.

- 5 Select the portion you want to scan by clicking the left mouse button and dragging it over the area.

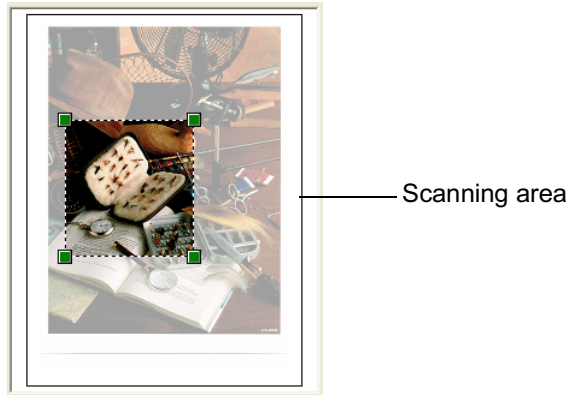

- 6 If you require advanced settings, click **Picture Type** from the **Adjust the quality of the scanned picture (C)**. You can select **Brightness, Contrast, Resolution** and **Advanced Properties**. Click the **OK** button after you choose your settings.

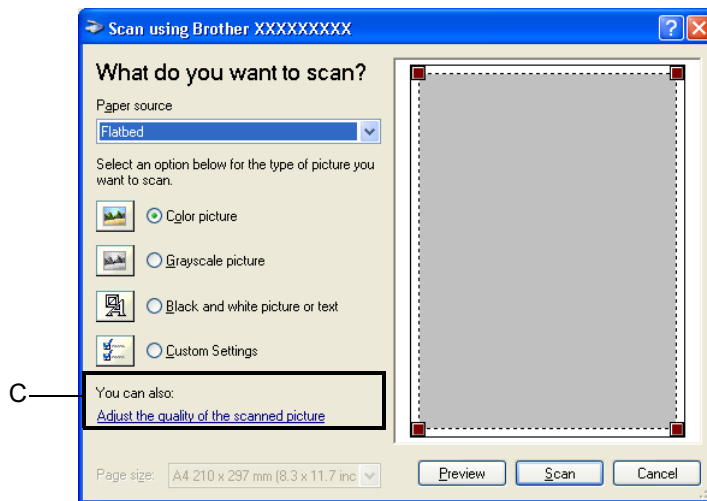

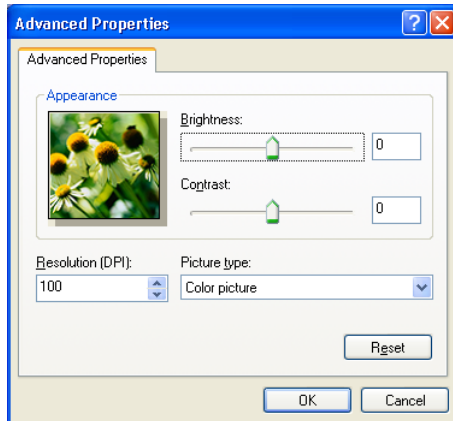

**7** To start scanning your document, click the **Scan** button in the Scan dialog box.

This time only the selected area of the original will appear in the PaperPort® window (or your software application window).

## Brother Scanner Utility

The Brother Scanner Utility is used for configuring the scanner driver for resolutions greater than 1200dpi and scanning Legal size paper from the ADF when using Windows® XP.

### To run the utility:

You can run the utility by selecting the **Scanner Utility** located in the **Start/Programs/Brother/Brother MFL Pro Suite** menu.



- Scanning at resolutions greater than 1200dpi may cause problems with some scanning applications.
- If your machine is a flatbed model you can only scan legal size pages from the ADF.

# Using the color scan key

You can use the **Scan to** key on the control panel to scan originals into your word processing, graphics or E-mail applications. The advantage of using the **Scan to** key is that you avoid the mouse clicks required to scan from your computer.

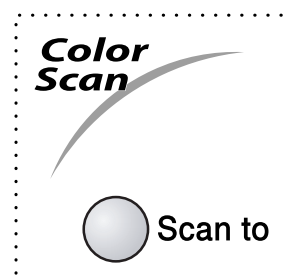

⊘ The **Scan to** key will work only for Scan to Card if you are using a Macintosh<sup>®</sup> computer.

## **For Scan to E-mail, Scan Image and Scan/OCR only**

Before you can use the **Scan to** key on the control panel, you must have connected the MFC to your Windows<sup>®</sup> based computer and loaded the appropriate Brother Drivers for your version of Windows<sup>®</sup>.



When you are ready to use the **Scan to** key, make sure the Brother Control Center application is running on your computer. (For Windows<sup>®</sup> 95/98/98SE/Me/2000 Professional and Windows NT<sup>®</sup> 4.0 only) For details about how to configure the Brother Control Center buttons to launch the application of your choice using the **Scan to** key, see *Brother MFL-Pro Control Center* on pages 14-1 to 14-2.

## Scan to E-mail

---

You can either scan a black and white or color original into your E-mail application as a file attachment. Although the Brother Control Center can be configured to send only black and white or color file attachments at one time, you can easily change this setting.



(For details see *Scan to E-mail* on pages 14-10 to 14-11.)

- 1** Place the original face up in the ADF, or face down on the scanner glass.
- 2** Press the **Scan to** key.
- 3** Press  or  to select SCAN TO E-MAIL.  
Press **Menu/Set**.  
The MFC will scan the original, create a file attachment, and launch your E-mail application, displaying the new message waiting to be addressed.

## Scan Image

---



You can scan a color picture into your graphics application for viewing and editing.

- 1** Place the original face up in the ADF, or face down on the scanner glass.
- 2** Press the **Scan to** key.
- 3** Press  or  to select SCAN IMAGE.  
Press **Menu/Set**.

## Scan/OCR

---

If your original is text, you can have it converted by ScanSoft™ TextBridge® to an editable text file and then have the result displayed in your word processing application for viewing and editing.

- 1** Place the original face up in the ADF, or face down on the scanner glass.
- 2** Press the **Scan to** key.
- 3** Press  or  to select SCAN/OCR.  
Press **Menu/Set**.  
The MFC start the scanning process.



## Scan to Card

You can scan black and white and color originals into a media card. Black and white originals will be stored in TIFF file format (\*.TIF). Color originals may be stored in PDF (\*.PDF) or JPEG (\*.JPG) file format. The default setting is **COLOR STD** and the default file format is PDF. File names default to the current date. For example, the fifth image scanned on July 1, 2002 would be named 07010205.PDF. You can change the color, quality and file name as you want.

Quality	Selectable File Format	Default File Format
B&W STD (STANDARD)	TIFF	TIFF
B&W FINE	TIFF	TIFF
COLOR STD (STANDARD)	JPEG / PDF	PDF*
COLOR FINE	JPEG / PDF	PDF*
COLOR S.FINE	JPEG / PDF	PDF*



 You can choose the default file format in the **Menu, 4, 6** for color files. (See *Changing the default color file format* on page 15-18.)



**1** Insert a SmartMedia™, CompactFlash™ or Memory Stick™ card into your MFC.

 Do not take out the media card while the LED on the MFC is blinking to keep from damaging it.



**2** Place the original face up in the ADF, or face down on the scanner glass.

**3** Press **Scan to**.

**4** Press  or  to select **SCAN TO CARD**. Press **Menu/Set**.

**5** Press  or  to select **START SCANNING**. Press **Menu/Set**. The MFC will start scanning.

—OR—

Press  or  to select **CHANGE QUALITY** to change the quality.

Press **Menu/Set**. Go to Step 6.

—OR—

Select **CHANGE FILE NAME** to change the file name.

Press **Menu/Set**. Go to Step 7.

**6** Press  or  to select the quality you want.

Press **Menu/Set**.

If you selected COLOR STD, COLOR FINE or COLOR S.FINE, press  or  to select the file format (PDF or JPEG).

Press **Menu/Set**.

—OR—

To start scanning, press  or  to select START SCANNING.

Press **Menu/Set**.

—OR—

To change the file name, go to Step 7.

**7** If you selected CHANGE FILE NAME, press **1** to select 1.CHANGE.

Use the dial pad to enter the file name.

Press **Menu/Set**. (You can only change the first 6 digits.)

Press  or  to select START SCANNING.

Press **Menu/Set**.



If you placed the original on the scanner glass, when the MFC has finished scanning the page, the LCD shows:

NEXT:PRESS SET  
END:PRESS SCAN

Place the next page to be scanned, and then press **Menu/Set**.

—OR—

Press **Scan to** to exit.

## Changing the default color file format

**1** Press **Menu/Set**, **4**, **6**.

**2** Press  or  to select PDF or JPEG.

Press **Menu/Set**.

**3** Press **Stop/EXIT**.

PHOTOCAPTURE  
6.SCAN TO CARD

# Using ScanSoft™ PaperPort® and TextBridge® OCR

ScanSoft™ PaperPort® for Brother is a document management application. You will use PaperPort® to view scanned documents.

PaperPort® has a sophisticated, yet easy-to-use, filing system that will help you organize your graphics and text documents. It allows you to combine or “stack” documents of different formats for printing, faxing or filing.

ScanSoft™ PaperPort® can be accessed through the ScanSoft™ PaperPort® program group.

*See On-Line Documentation for Multi-Function Link® Pro on the CD-ROM.*

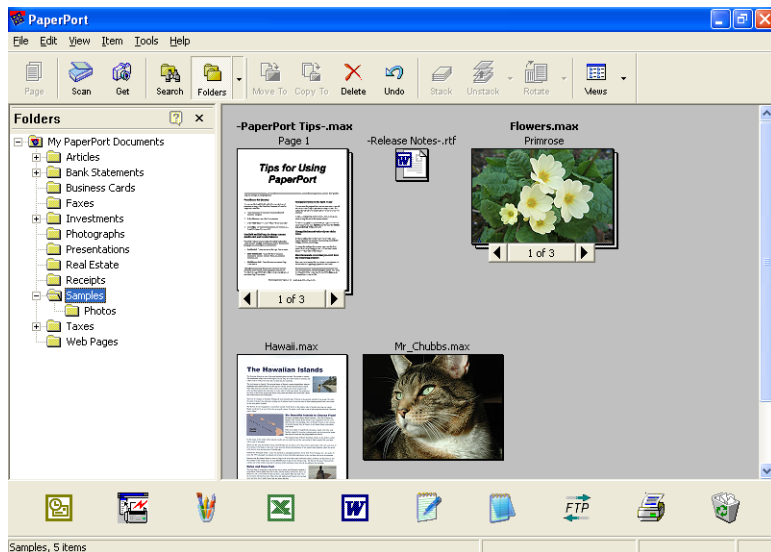

The complete ScanSoft™ PaperPort® Users Guide, including ScanSoft™ TextBridge® OCR, is in the On-Line documentation on the CD-ROM.

This chapter is only an introduction to the basic operations.

When you install Multi-Function Link® Pro, ScanSoft™ PaperPort® for Brother and ScanSoft™ TextBridge® OCR are installed with it automatically.

 If you are using Windows® XP or Windows® 2000 Professional, we recommend that you are logged on as an administrator.

# Viewing items

ScanSoft™ PaperPort® provides several ways to view items:

**Desktop View** displays a thumbnail (a small graphic that represents each item in a Desktop or folder).

Items in the selected folder appear on the PaperPort® Desktop. You can see PaperPort® items (MAX files) and non-PaperPort® items (files created using other applications).

Non-PaperPort® items include an icon that indicates the application that was used to create the item; a non-PaperPort® item is represented by a small rectangular thumbnail and not an actual image.

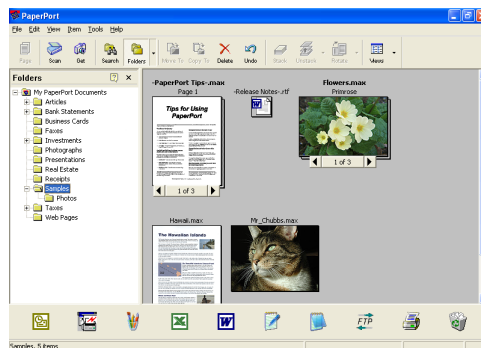

Desktop View displays items as thumbnails

**Page View** displays a close-up of a single page and you can open a PaperPort® item by double-clicking on it.

As long as you have the appropriate application on your computer to display it, you can also double-click a non-PaperPort® item to open it.

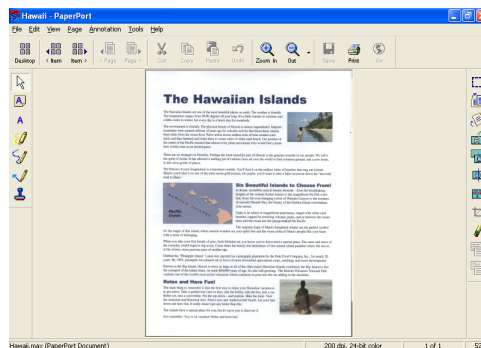

Page View displays each item as a full page

## Organizing your items in folders

---

PaperPort® has an easy-to-use filing system for organizing your items. The filing system consists of folders and items that you select to view in Desktop View. An item can be a PaperPort® item or a non-PaperPort® item:

- Folders are arranged in a “tree” structure in the Folder View. You use this section to select folders and view their items in Desktop View.
- You can simply drag and drop an item onto a folder. When the folder is highlighted, release the mouse button and the item is stored in that folder.
- Folders can be “nested”—that is, stored in other folders.
- When you double-click a folder, its items (both PaperPort® MAX files and non paperport® files) appear on the Desktop.
- **You can also use Windows® Explorer to manage the folders and items shown in Desktop View.**

## Quick links to other applications

---

ScanSoft™ PaperPort® automatically recognizes many other applications on your computer and creates a “working link” to them. The Send To Bar at the bottom of the Desktop view shows icons of those linked applications.

To use a link, drag an item onto one of the icons to start the application represented by the icon. A typical use of the Send To Bar is to select an item and then fax it.

This sample Send To Bar shows several applications with links to PaperPort®.



If PaperPort® does not automatically recognize one of the applications on your computer, you can manually create a link using the **Add to Send To Bar...** command.

(See PaperPort® in the On-Line-Documentation on the CD-ROM for more information about creating new links.)

# ScanSoft™ TextBridge® OCR lets you convert image text in to text you can edit

---

Software by:



ScanSoft™ TextBridge® OCR is installed automatically with PaperPort® when you install Multi-Function Link® Pro on your computer.

ScanSoft™ PaperPort® can quickly convert the text on a ScanSoft™ PaperPort® item (which is really just a picture of the text) into text that you can edit with a word processing application.

PaperPort® uses the optical character recognition application ScanSoft™ TextBridge®, which comes with PaperPort®

—OR—

PaperPort® uses your application if it is already on your computer. You can convert the entire item, or by using the **Copy Text** command, you can select only a portion of the text to convert.

Dragging an item onto a word-processing link icon starts PaperPort®'s built-in OCR application, or you can use your own OCR application.



## You can Import items from other applications

---

In addition to scanning items, you can bring items into PaperPort® in a variety of ways and convert them to PaperPort® (MAX) files in several different ways:

- Print to the Desktop View from another application, such as Microsoft Excel.
- Import files saved in other file formats, such as Windows® Bitmap (BMP) or Tag Image File Format (TIFF).

## You can Export items in other formats

---

You can export or save PaperPort® items in several popular file formats, such as BMP, JPEG, TIFF, or self-viewing.

For example, to create a file for an Internet Web site, export it as a JPEG file. Web pages often use JPEG files for displaying images.

### Exporting an image file

- 1 Select the Save As command from the File pull-down menu in the PaperPort® window. The Save 'XXXXX' As dialog box will be displayed.
- 2 Select the drive and directory where you want to store the file.
- 3 Enter the new file name and choose the file type or select a name from the File Name text box. (You can scroll through the Directories and File Name listing for prompting.)
- 4 Select the OK button to save your file, or Cancel to return to the PaperPort® without saving it.



To Uninstall PaperPort® and ScanSoft™ TextBridge

*For Windows® 95/98/98SE, and Windows NT® Workstation 4.0 and Windows® Me:*

Select **Start, Settings, Control Panel, Add/Remove Programs** and the **Install/Uninstall** tab.

Select **PaperPort® 8.0 SE** from the list and click the **Add/Remove** button.

Select **Brother Extensions for Paperport** and click the **Add/Remove** button.

*For Windows® 2000 Professional:*

Select **Start, Settings, Control Panel** and **Add/Remove Programs**.

Select **PaperPort® 8.0 SE** from the list and click the **Remove** button.

Select **Brother Extensions for Paperport** and click the **Change/Remove** button.

Select **Brother Extensions for Paperport** and click the **Add/Remove** button.

*For Windows® XP:*

Select **Start, Control Panel, Add or Remove Programs** and the **Change or Remove Programs** icon.

Select **PaperPort® 8.0 SE** from the list and click the **Change** button.

# 16 Using Remote Setup (For Windows®)

## MFC Remote Setup

The MFC Remote Setup application lets you to set up your MFC by using the ease and speed of programming on your PC. When you access this application, the settings on your MFC will be downloaded to your PC and displayed on your computer screen. If you change the settings, you can upload them directly to the MFC.

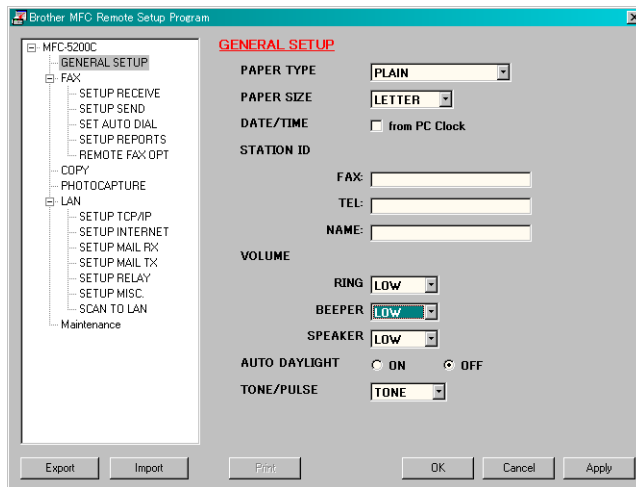

### OK button

When you click **OK**, the process of uploading the data to the MFC begins. The Remote Setup program is closed if an error message is displayed, enter the correct data again and then click **OK**.

### Cancel button

The Cancel button clears your changes and exits the Remote Setup application without uploading any data to the MFC.

### Apply button

The Apply button uploads the data to the MFC, but stays in the Remote Setup application so you can make more changes.

### Print button

The Print button prints the selected items on the MFC. You cannot print the Remote Setup changes until you click the **Apply button** to upload the new data to the MFC. Then you can click the **Print button** to get an up-to-date printout.



## **Export button**

Click the Export button to save your current settings to a file.

## **Import button**

Click the Import button to read the settings from your saved file into the Remote Setup screen.



You can use the Export and Import buttons to save and use several sets of settings for your MFC.

# 17 Using PC-FAX (For Windows®)

## PC-FAX sending

The Brother PC-FAX feature lets you send a file from your PC.

You can create a file in any application on your PC, and then send it as a PC FAX. You can even attach a cover page note.

All you have to do is set up the receiving parties as Members or Groups in your PC FAX Address Book. Then you can use the Address Book Search feature to quickly find them to address your fax.



- PC FAX is available in Black & White only.
- If you are using Windows® XP or Windows® 2000 Professional, we recommend that you are logged on as an administrator.

## Setting up user information



You can access the User Information from the FAX Sending dialog box by clicking .

(See *Sending a file as a PC-FAX using the Facsimile style* on page 17-13.)

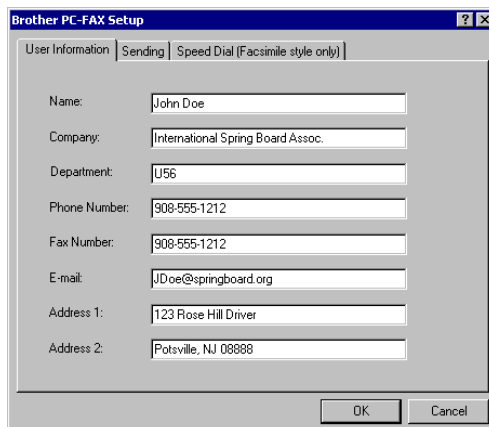

The screenshot shows the 'Brother PC-FAX Setup' dialog box with the 'User Information' tab selected. The fields are filled with the following information:

Field	Value
Name	John Doe
Company	International Spring Board Assoc.
Department	U56
Phone Number	908-555-1212
Fax Number	908-555-1212
E-mail	JDoe@springboard.org
Address 1	123 Rose Hill Drive
Address 2	Potsville, NJ 08888

Buttons: OK, Cancel

- 1 From the **Start** menu, select **Programs, Brother, Brother MFL Pro Suite**, and then select **PC-FAX Setup**.  
The Brother PC-FAX Setup dialog box will appear:
- 2 You must enter this information create the Fax Header and Cover Page.
- 3 Click **OK** to save the User Information

## Sending setup

---

From the Brother PC-FAX Setup dialog box, click the **Sending** tab to display the screen below.

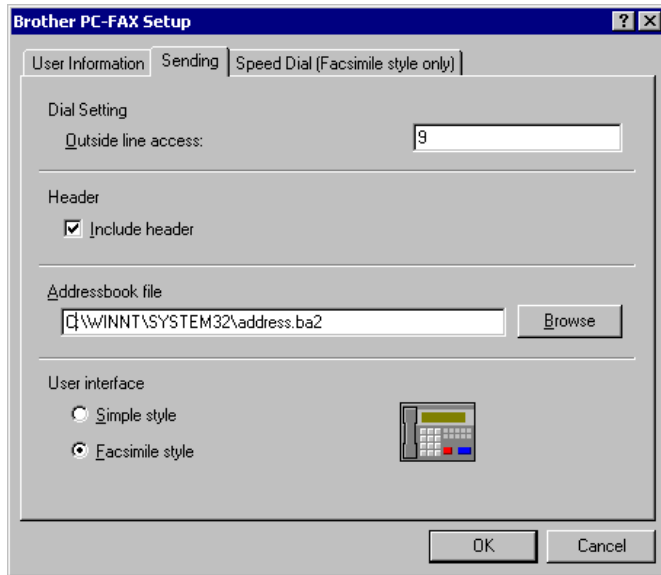

### Outside line access

---

If you need to enter a number to access an outside line, enter it here. This is sometimes required by a local PBX telephone system (for example, if you must dial 9, to get an outside line in your office).

### Include header

---

To add header information to the top of the fax pages you send, check the Include header box.

### Address Book file

---

You can select more than one database file to use with the Address Book. To select you must enter the path and file name of the database file

—OR—

Use the Browse button to find the database to select.

# User interface

---

In the Sending tab select user interface.

You can choose the Simple Style or the Facsimile Style.

## Simple style

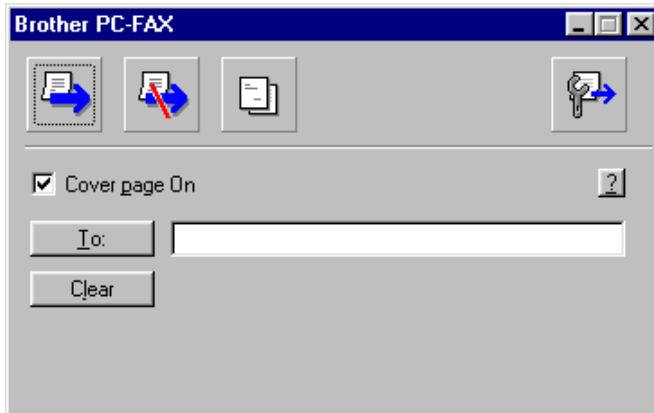

## Facsimile style



# Speed Dial setup

From the Brother PC-FAX Setup dialog box, click the **Speed Dial** tab. (To use this feature you must select the Facsimile Style user interface.)

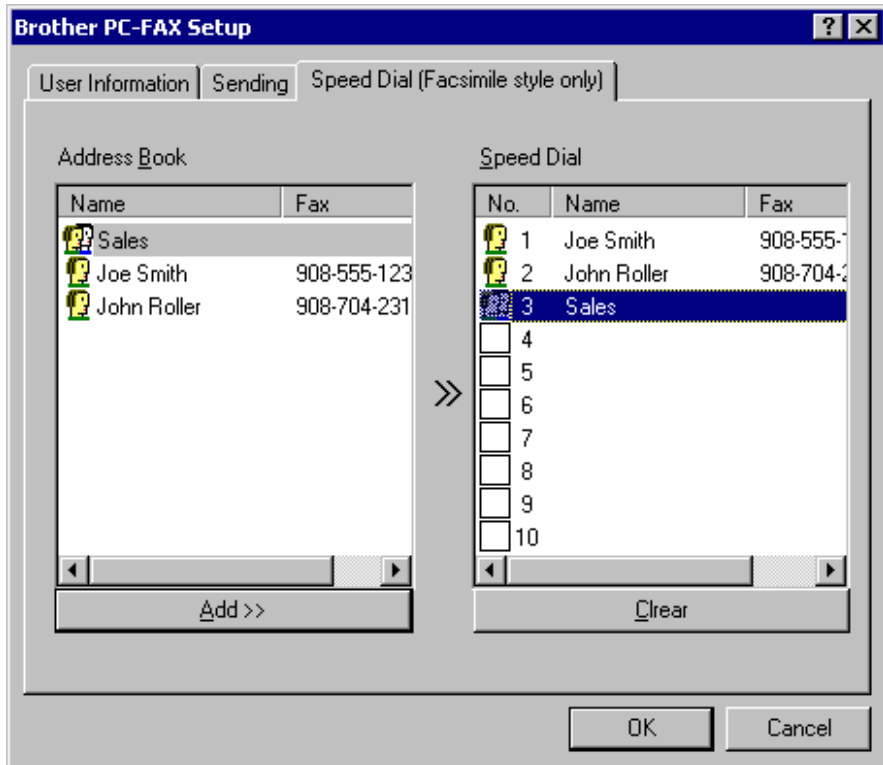

You can register any Member or Group on each of the ten Speed Dial buttons.

## To register an address in a Speed Dial button:

- 1 Click the Speed Dial button you want to program.
- 2 Click the Member or Group you want to store on the Speed Dial button.
- 3 Click **Add >>** to save it.

## To clear a Speed Dial button:

- 1 Click the Speed Dial button you want to clear.
- 2 Click **Clear** to erase it.

# The Address Book

---

From the **Start** menu, select **Programs, Brother, Brother MFL Pro Suite**, and then click **Address Book**.

The Brother Address Book dialog box will appear:

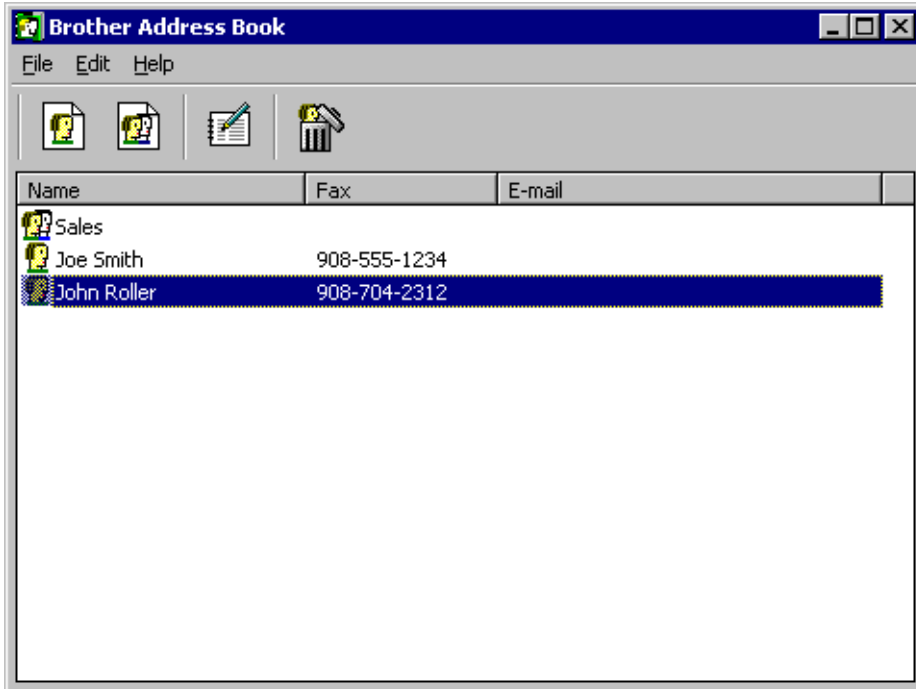

## Setting up a Member in the Address Book

In the Brother Address Book dialog box you can add, edit and delete stored information of Members and Groups.

- 1 In the Address Book dialog box, click the  icon to add a Member.

The Brother Address Book Member Setup dialog box will appear:

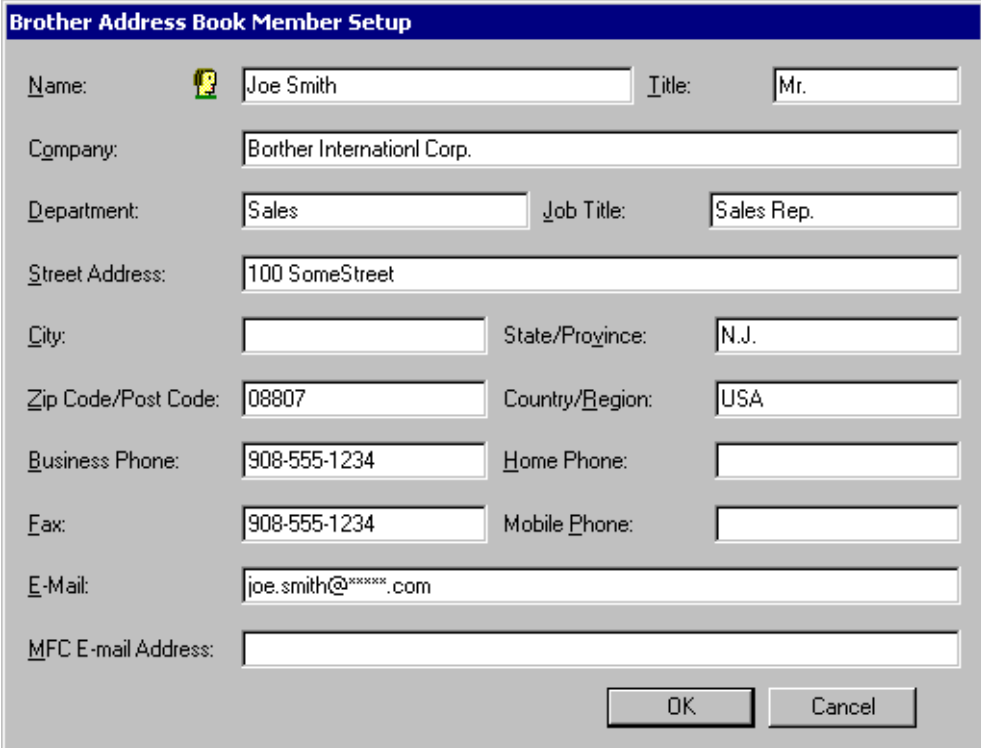

**Brother Address Book Member Setup**

Name:  Joe Smith Title: Mr.

Company: Borther International Corp.

Department: Sales Job Title: Sales Rep.

Street Address: 100 SomeStreet

City: State/Province: N.J.

Zip Code/Post Code: 08807 Country/Region: USA

Business Phone: 908-555-1234 Home Phone:

Fax: 908-555-1234 Mobile Phone:

E-Mail: joe.smith@\*\*\*\*\*.com

MFC E-mail Address:

OK Cancel

- 2 In the Member Setup dialog box, type the Member's information. **Name** and **Fax** are required fields. Click **OK** to save the information.

# Setting up a Group for Broadcasting

If you often send the same PC-FAX to several Members, you can combine them in a Group.

- 1 In the Brother Address Book dialog box, click the  icon to create a Group.

The Group Setup dialog box appears:

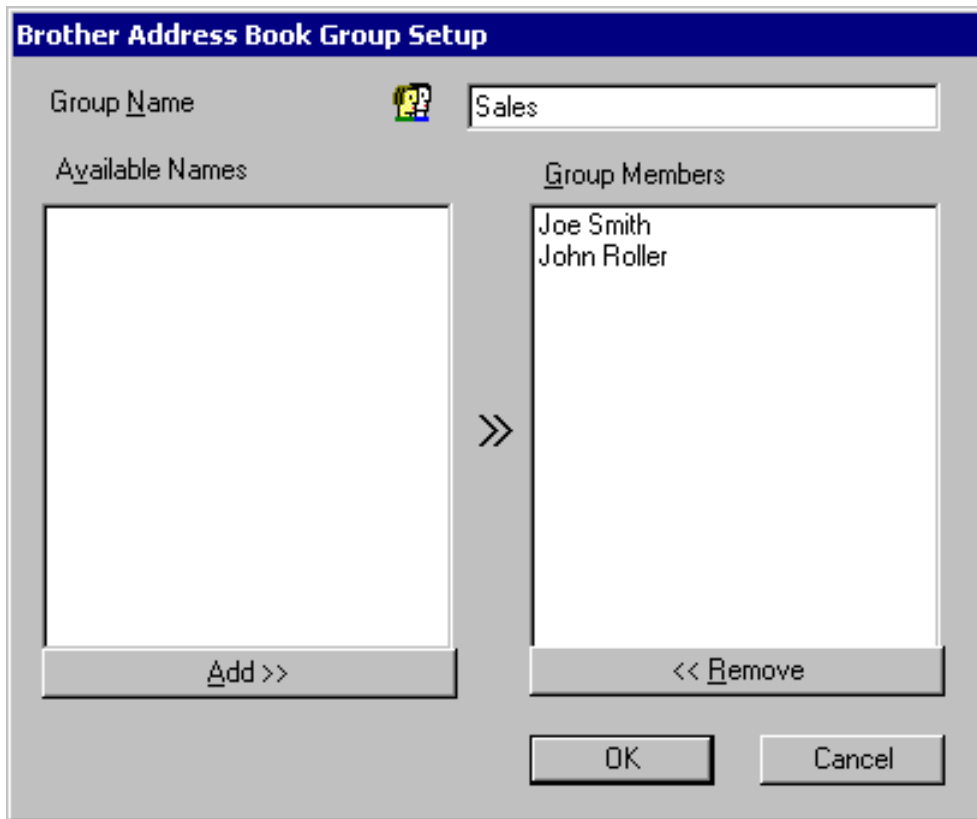

- 2 Type the name of the new Group in the **Group Name** field.
- 3 In the **Available Names** box, select each Member to be included in the Group, and then click **Add >>**.  
Members you add to the Group will be added to the Group Members box.
- 4 After all the members you want have been added, click **OK**.



## Editing Member information

---

- 1 Select the Member or Group you want to edit.
- 2 Click the edit  icon.
- 3 Change the Member or Group information.
- 4 Click **OK** to save your changes.

## Deleting a Member or Group

---

- 1 Select the Member or Group you want to delete.
- 2 Click the delete  icon.
- 3 When the Delete OK? dialog box appears, click **OK**.

# Exporting the Address Book

You can export the whole Address Book to an ASCII text file (\*.csv). Or if you wish, you can select and create a Vcard that will be attached to that Member's outgoing e-mail. (A Vcard is an electronic business card that contains the sender's contact information.)

## To export the whole current Address book:



If you are creating a Vcard, you must first select the member. If you select Vcard in Step 1, **Save as type:** will be **Vcard (\*.vcf)**.

**1** From the Address Book select **File**, point to **Export**, and then click **Text**

—OR—

Click **Vcard** and go to Step 5.

**2** From the **Available Items** column, select the data fields you wish to Export and then click **Add >>**.



Select the items in the order you want them listed.

**3** If you are exporting to an ASCII file, select the Divide Character - **Tab** or **Comma**. This selects between a Tab or Comma to separate the data fields.

**4** Select **OK** to save the data.

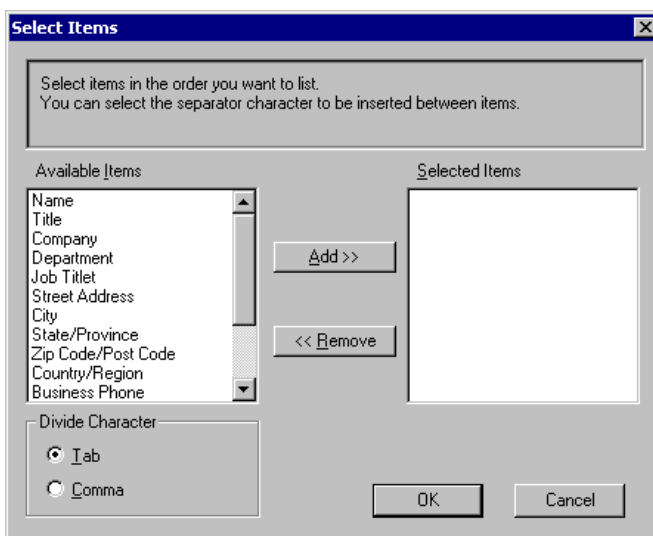

**5** Type the name of the file, and then select **Save**.

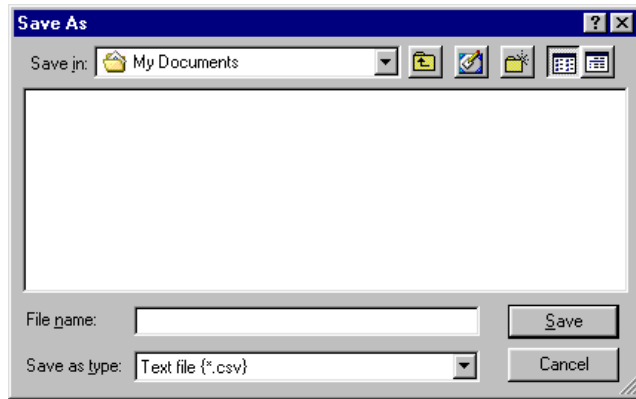

# Importing to the Address Book

You can import ASCII text files (\*.csv) or Vcards (electronic business cards) into your Address Book.

## To import an ASCII text file:

- 1 From the Address Book select **File**, point to **Import**, and then click **Text**  
—OR—  
Click **Vcard** and go to Step 5.

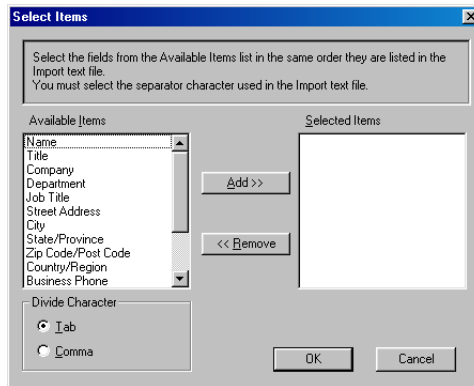

- 2 From the **Available Items** column select the data fields you want to Import, and click **Add >>**.



From the Available Items list select the fields in the same order they are listed in the Import text file.

- 3 Select the Divide Character - **Tab** or **Comma** based on the file format you are importing.
- 4 To import the data click **OK**.
- 5 Type the name of the file, and then select **Open**.

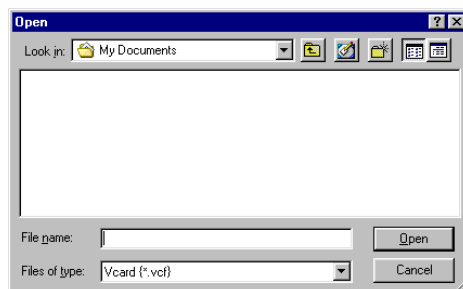

If you selected a text file in Step 1, the **Files of type:** will be **Text file (\*.csv)**.

# Setting up a Cover Page

---

From the PC-FAX dialog box click . To access the PC-Fax Cover page setup screen. (See *Sending a file as a PC-FAX using the Facsimile style* on page 17-13.)

The Brother PC-FAX Cover Page Setup dialog box will appear:

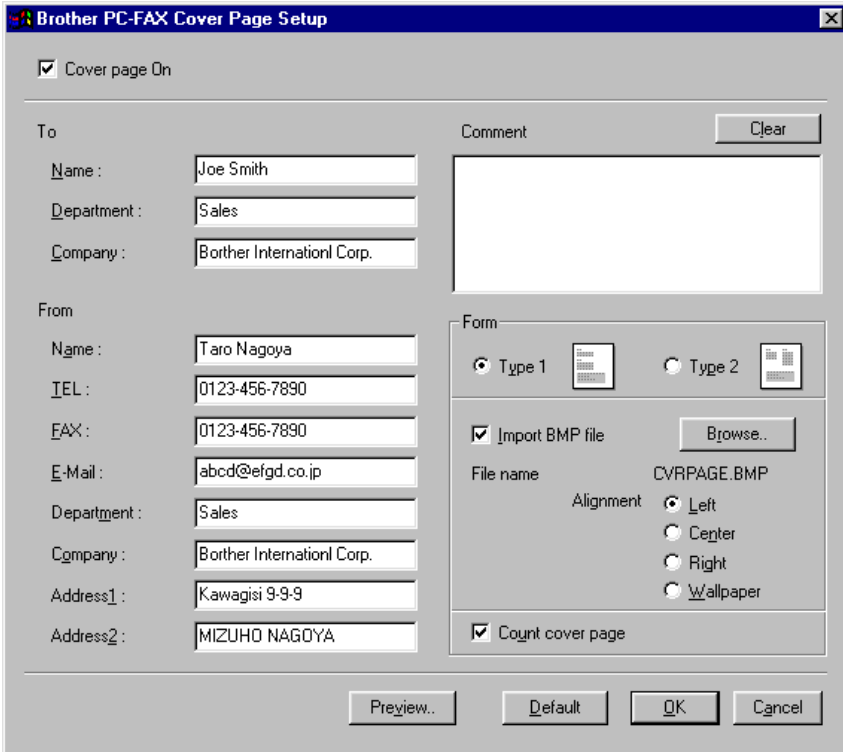

## You can enter information in each field.

---

 If you are sending a fax to more than one recipient, the recipient information will not be printed on the Cover Page.

**To**  
**From**  
**Comment**

Type the comment you want to add to the cover page.

### Select Cover Page Form

Select the cover page format you want to use.

## Import BMP file

You can insert a bitmap file, such as your company logo, in the cover page.

Use the browse button to select the BMP file, and then select the alignment style.

## Count Cover Page

When the Count Cover Page box is checked, the Cover Page will be included in the page numbering. When this box is not checked, the Cover Page will not be included.

## Sending a file as a PC-FAX using the Facsimile style

---

- 1 Create a file in Word, Excel, Paint, Draw or any other application on your PC.
- 2 From the **File** menu, select **Print**.  
The Print dialog box will appear:

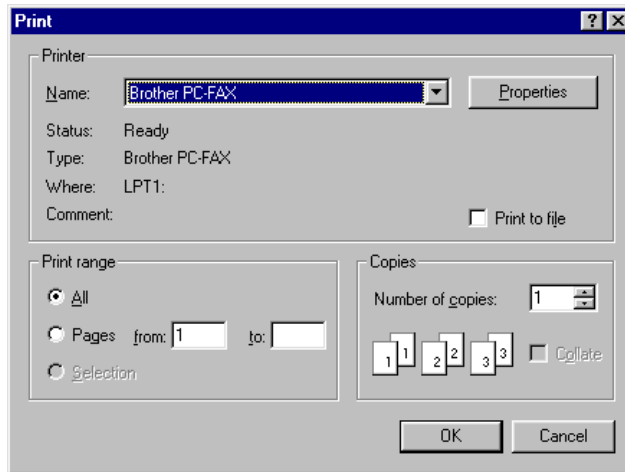



- 3 Select **Brother PC-FAX** as your printer, and then click **OK**. The Fax Sending dialog box will appear.



- 4 Enter the fax number using any of the following methods:
- Using the dial pad enter the number.
  - Click any of the 10 **Speed Dial** buttons.
  - Click the **Address Book** button, and then select a Member or Group from the Address Book.

 If you make a mistake you can click **Clear** to delete all the entries.

- 5 To include a Cover Page, click  **Cover Page On**, and then click the Cover Page  icon to enter or edit the Cover Page information.

- 6 Click **Start** to send the fax.

 If you want to cancel the fax, click **Stop**.

## Redial

If you want to redial a number, click **Redial** to scroll through the last five fax numbers, and then click **Start**.

# Sending a file as a PC-FAX using the Simple style

- 1 Create a file in Word, Excel, Paint, Draw or any other application on your PC.
- 2 From the **File** menu, select **Print**.  
The Print dialog box will appear:

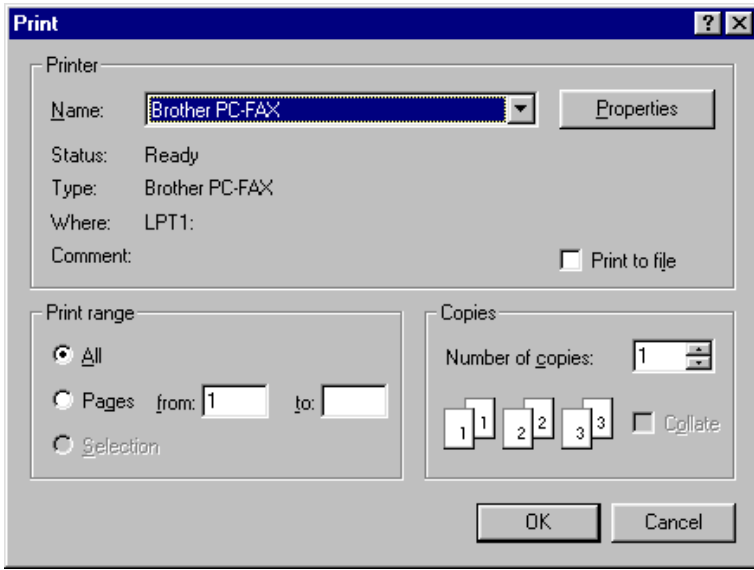

- 3 Select **Brother PC-FAX** as your printer, and then click **OK**.  
The FAX Sending dialog box will appear:

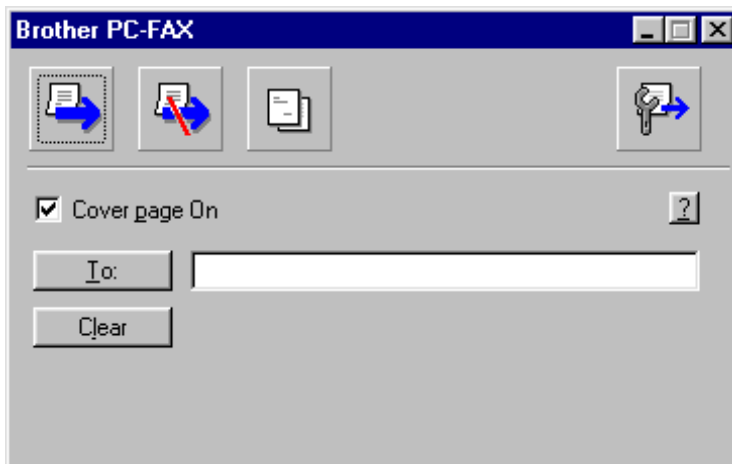

- 4 In the **To:** field, type the fax number of the recipient. You can also use the Address Book to select destination fax numbers by clicking the **To:** button. If you made a mistake entering a number, click the **Clear** button to delete all the entries.
- 5 To send a Cover Page and note, click the **Cover Page On** check box.



 You can also click the  icon to create or edit a cover page.

**6** When you are ready to send your fax, click the Send  icon.

**7** If you wish to cancel the fax, click the Cancel  icon.

# Setting up PC-FAX receiving (Windows® 95/98/98SE/Me/2000 Professional and Windows NT® WS 4.0 only)

## Running PC-FAX Receiving

---

From the Start menu, select Program File, Brother, Brother MFL Pro Suite and then select 'PC-FAX Receiving'.

The PC-FAX  icon will appear on your PC Task bar for this Windows® session.

## Setting up your PC

---

- 1 Right-click the PC-FAX  icon on your PC Task Bar, and then click **PC-Fax RX Setup**.
- 2 The PC-Fax RX Setup dialog box will appear:

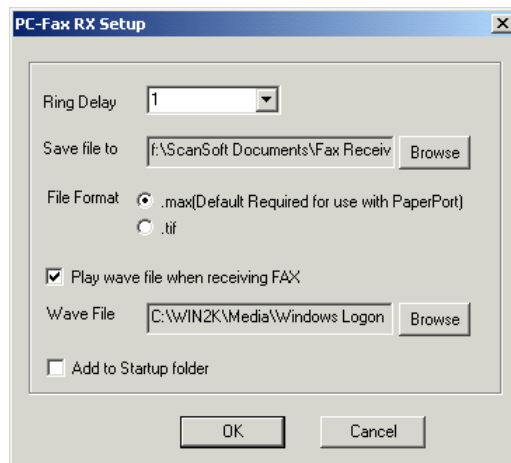

- 3 In **Ring Delay**, select the number of rings before you want your PC to answer Incoming calls.
- 4 In **Save file to**, use the Browse button if you want to change the path where PC-FAX files will be saved.

- 5 Make sure **File Format** is checked for .max (Default Required to use with PaperPort).
- 6 If you want to, you can check the **Play wave file when receiving FAX** check box, and then enter the path.
- 7 To load PC FAX receiving automatically when you start up Windows®, select the **Add to Startup folder** check box.

## Viewing new PC-FAX messages

---

Each time you start to receive a PC-FAX, the Blue and Red  icons will blink on the PC Task Bar. The Red icon will remain.

- 1 Run PaperPort.
- 2 Open the Fax Received folder.
- 3 Double-click any of the new faxes to open and view them.

 The title of your unread PC message will be the date and time until you assign a file name.  
For example “Fax 2-20-2002 16:40:21 max”

# Receiving a Fax into the PC (Windows® XP only)

## How to receive a Fax automatically

Before you can start receiving faxes, please install the appropriate Windows XP driver (Windows XP In-box driver or Brother Windows XP driver). After the driver is installed, refer to the following information to configure your Windows XP PC for Fax receiving.

- 1 To activate Faxing receiving, click **Set up faxing** in the **Printer Tasks** menu.

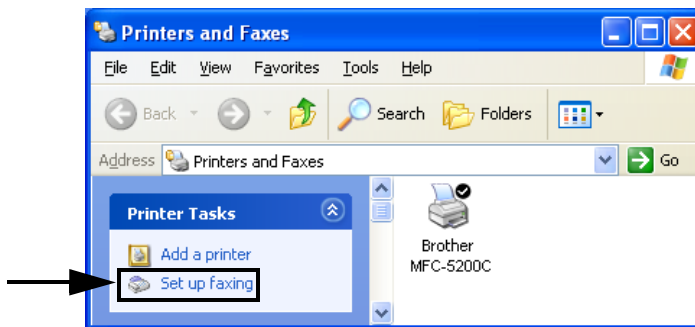

- 2 The FAX services will be installed on your PC.

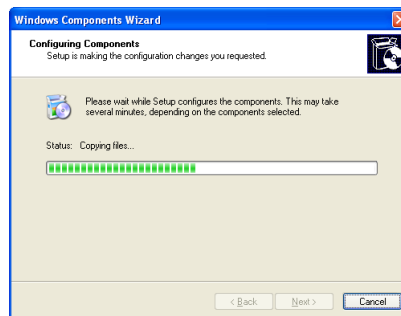

- 3 A Fax icon will then appear in the **Printers and Faxes** folder. If Fax icon does not appear, click **Install a local fax printer** in the **Printer tasks** menu.



#### 4 Select the **Start, All Programs, Accessories, Communications, Fax, Fax Console.**



If you have not configured your fax connection, the following screen will be displayed.

Enter your details, ensuring you specify the outside line access number if necessary and click **OK**.

Location Information

Before you can make any phone or modem connections, Windows needs the following information about your current location:

What country/region are you in now?  
United Kingdom

What area code (or city code) are you in now?  
0161

If you need to specify a carrier code, what is it?

If you dial a number to access an outside line, what is it?  
9

The phone system at this location uses:  
 One dialing  Pulse dialing

OK Cancel

Select the **My location** radio button if it is not selected and then click **OK**.

Phone and Modem Options

Dialing Rules

The list below displays the locations you have specified. Select the location from which you are dialing.

Locations:

Location	Area Code
<input checked="" type="radio"/> My Location	0161

New... Edit... Delete

OK Cancel Apply

**5** The **Fax Configuration Wizard** starts. Click **Next**.

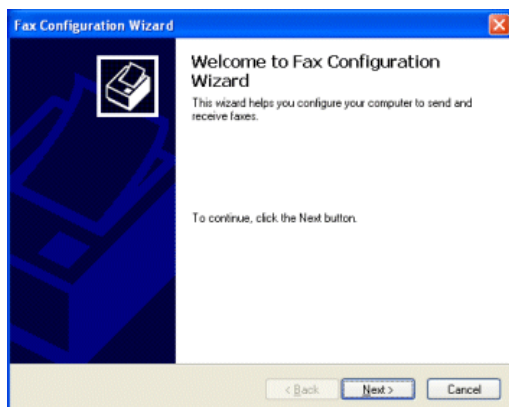

**6** Enter the sender information, and then click **Next**.

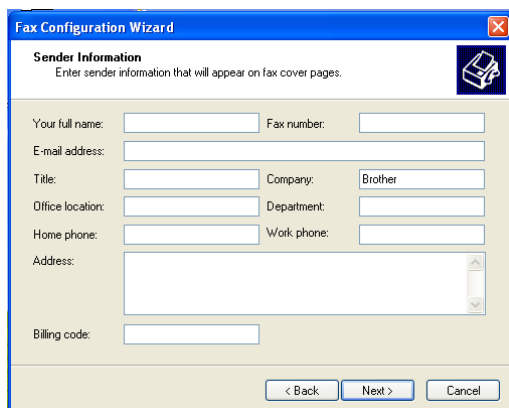

**7** Select **Brother MFC-5200C** in the **Please select the fax device** pull-down list. Click to select the **Enable Receive** check box. Specify the number of rings before your MFC will attempt to answer the fax. Click **Next**.

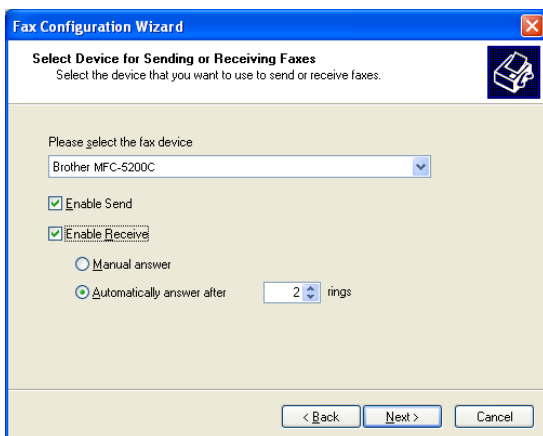

- 8 Enter the **Transmitting Subscriber Identification (TSID)**, and then click **Next**.

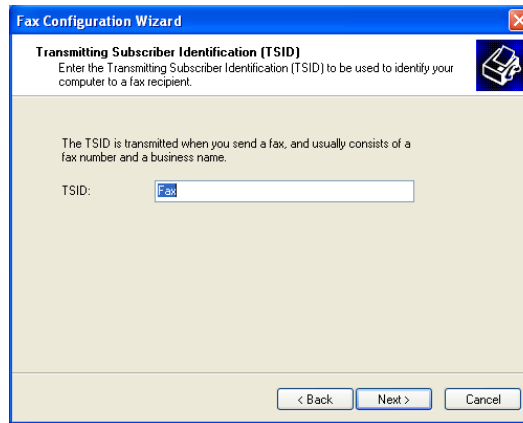

The screenshot shows the 'Fax Configuration Wizard' window. The title bar reads 'Fax Configuration Wizard'. The main heading is 'Transmitting Subscriber Identification (TSID)'. Below the heading, it says 'Enter the Transmitting Subscriber Identification (TSID) to be used to identify your computer to a fax recipient.' There is a printer icon in the top right corner. The main text explains: 'The TSID is transmitted when you send a fax, and usually consists of a fax number and a business name.' Below this, there is a label 'TSID:' followed by a text input field containing the word 'Fax'. At the bottom, there are three buttons: '< Back', 'Next >', and 'Cancel'.

- 9 Enter the **Called Subscriber Identification (CSID)**, and then click **Next**.

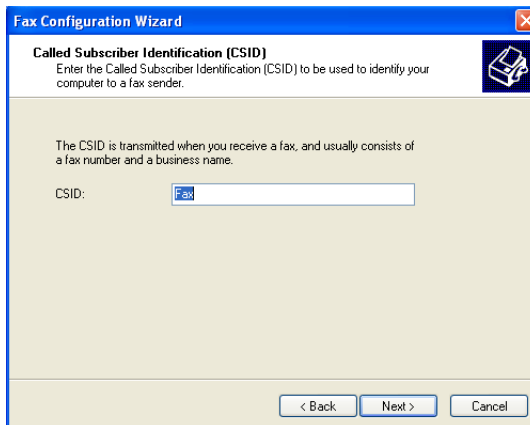

The screenshot shows the 'Fax Configuration Wizard' window. The title bar reads 'Fax Configuration Wizard'. The main heading is 'Called Subscriber Identification (CSID)'. Below the heading, it says 'Enter the Called Subscriber Identification (CSID) to be used to identify your computer to a fax sender.' There is a printer icon in the top right corner. The main text explains: 'The CSID is transmitted when you receive a fax, and usually consists of a fax number and a business name.' Below this, there is a label 'CSID:' followed by a text input field containing the word 'Fax'. At the bottom, there are three buttons: '< Back', 'Next >', and 'Cancel'.

- 10 Select if you print a received fax or save it in a folder, and then click **Next**.

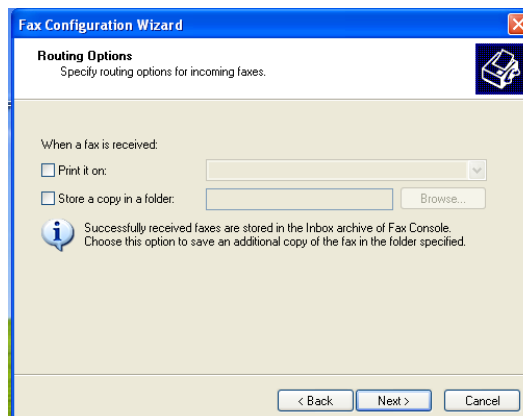

The screenshot shows the 'Fax Configuration Wizard' window. The title bar reads 'Fax Configuration Wizard'. The main heading is 'Routing Options'. Below the heading, it says 'Specify routing options for incoming faxes.' There is a printer icon in the top right corner. The main text asks: 'When a fax is received:'. There are two options: 'Print it on:' with a dropdown menu, and 'Store a copy in a folder:' with a text input field and a 'Browse...' button. Below this, there is an information icon and text: 'Successfully received faxes are stored in the Inbox archive of Fax Console. Choose this option to save an additional copy of the fax in the folder specified.' At the bottom, there are three buttons: '< Back', 'Next >', and 'Cancel'.

## 11 Click **Finish**.



When PC-FAX Receiving is active, you cannot run the Remote Setup utility. To use Remote Setup, check off **Enable Receive** in step 7.

For information on how to use PC-FAX Sending and Receiving, please refer to Help in the **Fax Console**.

The PC-FAX installation is now complete.



## How to view the received faxes

---

Faxes that are received into the PC will appear in the Fax Console. Click **Start**, point to **All Programs, Accessories, Communications, Fax**, and then click **Fax Console** to open the **Fax Console**. In the left pane, expand the Fax folder (if it is not already expanded).

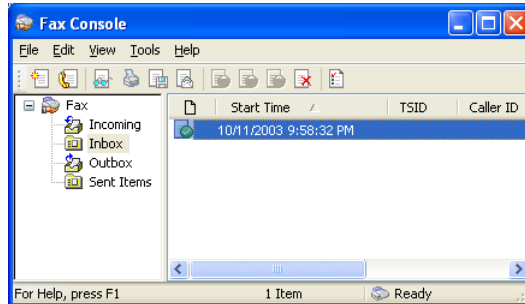

The Fax folder contains the following folders:

- The Incoming folder contains faxes that are currently being received.
  - The Inbox folder contains faxes that have been received.
  - The Outbox folder contains faxes that are scheduled to be sent.
- The Sent Items folder contains faxes that have been successfully sent.

# 18 Using the PhotoCapture Center™ from your PC (For Windows®)

## Introduction

- The PhotoCapture Center™ feature requires a USB cable connection to your PC and will work only with Windows® 98/98SE, Me, 2000 Professional and XP.
- For Windows® 2000 users, to access the PhotoCapture Center™ features from your PC you must first install a Windows® 2000 update. Please see the Quick Setup Guide for installation instructions.

**1** Insert a SmartMedia™, CompactFlash™ or Memory Stick™ card into your MFC.

- If two or three media cards are inserted at the same time, the PhotoCapture Center™ will read only the card that was put in first. To have access to another card, you must first take out all the cards, and then put in the media card you wish to access.

**2** In Windows® Explorer on your PC, double-click the Removable Disk icon. The files and folders that are on the media card will appear on your PC screen.

- If you are using Windows® XP and you create a name for the volume label of the media card, the name will appear instead of 'Removal Disk'.

**3** You can edit the file and save it to another drive on your PC.

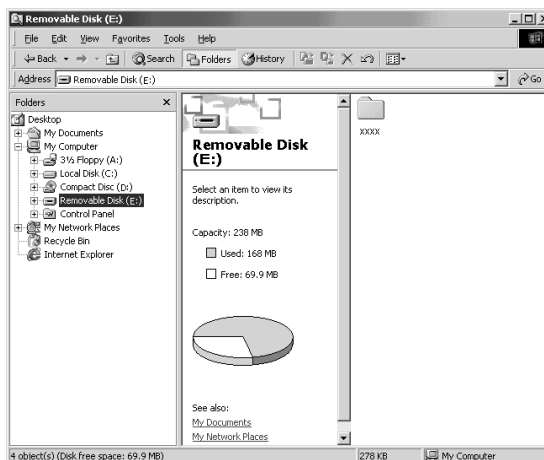

When you take out a media card, do the following to keep from damaging it:

- 1** In the My Computer window, right-click the removable disk icon and select “Eject” from the Context menu.
- 2** Wait until the LED on the MFC stops blinking before taking out the media card.

 Do **NOT** unplug the power cord, USB cable or remove a SmartMedia™, CompactFlash™ or Memory Stick™ card from the MFC while the MFC is reading the card (LED is flashing). You will lose your data or damage the card.

If you took out the media card while the LED was flashing, you must immediately restart your PC before putting the media card back in. If you put in another media card before the PC is rebooted, the data on it may be destroyed.

 While the MFC is printing from the PhotoCapture Center™, the PC cannot access the PhotoCapture Center™ for any other operation.

# 19 Using your MFC with a Macintosh®

## Setting up your USB-equipped Apple® Macintosh® G3, G4 or iMac™ or iBook™ with Mac OS 8.5 - 9.2 or Mac OS X 10.1, 10.2.1 or greater



Before you can connect the MFC to your Macintosh®, you must buy a USB cable that is not longer than 6 feet (1.8 metres).

Do not connect the MFC to a USB port on a key board or a non-powered USB hub.

The features supported by the MFC will depend on the operating system you are using. The chart below shows which features are supported.

Feature	MAC OS			MAC OS X	
	8.5	8.6	9.X	10.1	10.2.1 or greater *2
Printing	Yes	Yes	Yes	Yes	Yes
Scanning (TWAIN)	No	Yes	Yes	No	Yes
PC-FAX sending	Yes	Yes	Yes	No	No
Remote Setup	No	No	No	Yes	Yes
PhotoCapture Center	No	*1	Yes	Yes	Yes

\* 1 You need to download USB Mass Storage Support 1.3.5 from Apple® Web site ([www.apple.com](http://www.apple.com)).

\* 2 For Mac OS X 10.2 user, please upgrade to Mac OS X 10.2.1 or greater. (The latest information for Mac OS X, please visit at: <http://solutions.brother.com>.)

# Using the Brother printer driver with your Apple® Macintosh® (OS 8.5-9.2)

To select a Printer:

- 1 Open the **Chooser** from the Apple menu.

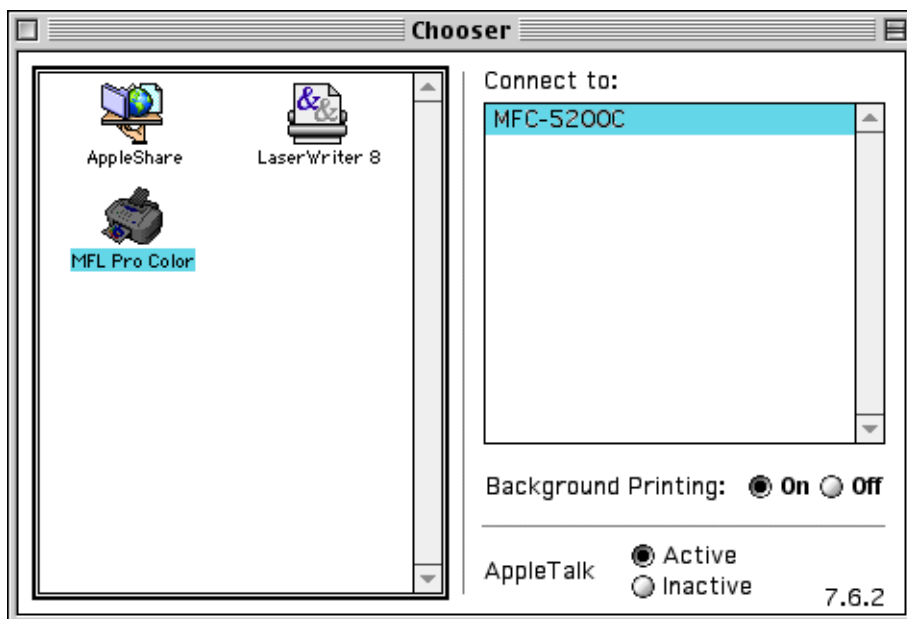

- 2 Click the **MFL Pro Color** icon. On the right side of the Chooser window, click the printer you want to print to. Close the **Chooser**.

**To print a document:**

- From the application software such as PaperPort®, click *File menu* and select *Page Setup*. You can change the settings for **Paper Size**, **Paper Thickness**, **Paper Source**, **Orientation**, and **Scaling** and then click **OK**.

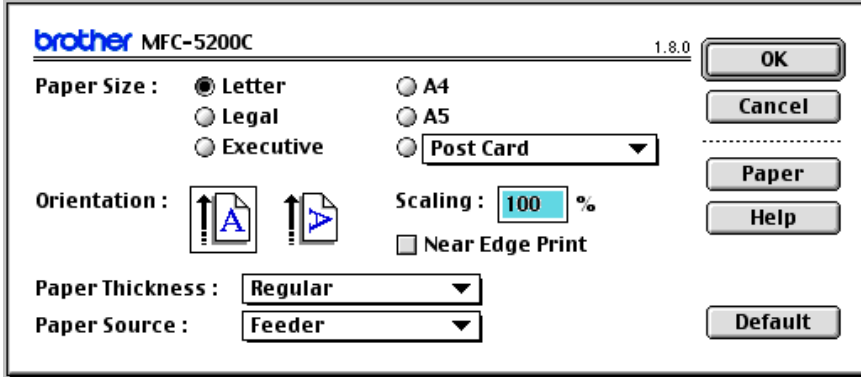

- From application software such as PaperPort, click *File menu* and select **Print**. Click **Print** to start printing.

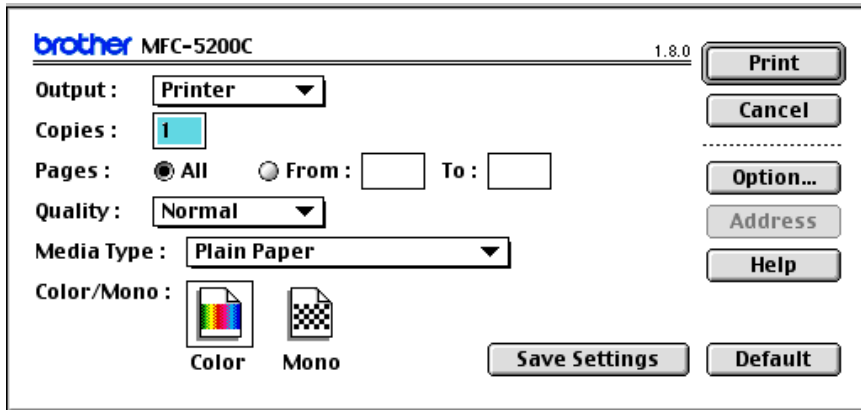

If you want to change **Copies**, **Pages**, **Quality**, **Media Type** and **Color/Mono**, select your settings before clicking **Print**.  
Click the **Option** button to change **Document** and **Printing Options**.

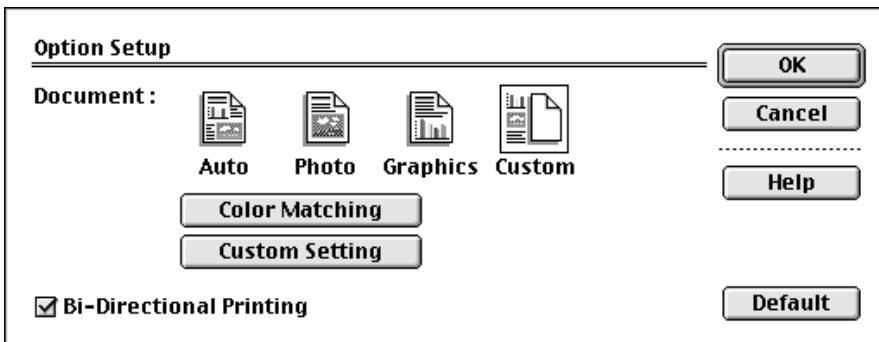

# Using the Brother Printer Driver with Your Apple® Macintosh® (OS X 10.1, 10.2.1 or greater)

## Choosing page setup options

---

From application software such as TextEdit, click the **File** menu and select **Page Setup**. Make sure **MFC-5200C** is selected in the **Format for** pop-up menu. You can change the settings for **Paper Size**, **Orientation** and **Scaling**, then click **OK**.

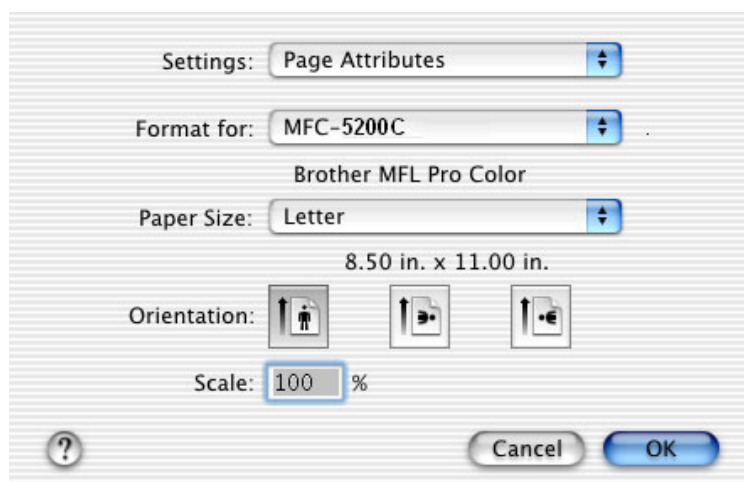

## Printing a document

---

From application software such as TextEdit, click the **File** menu and select **Print**. The print dialog box appears, click **Print**.

Make sure **MFC-5200C** is selected in the **Printer** pop-up menu.

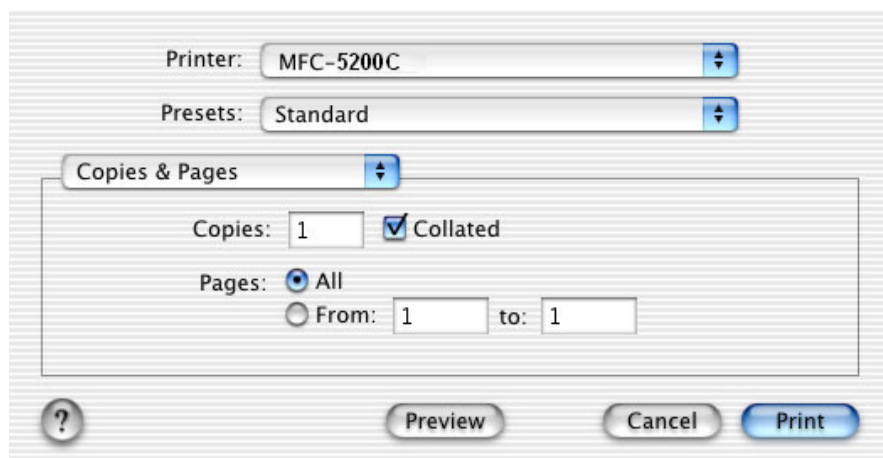

## Choosing printing options

If you want to print multiple copies, a specific range of pages, or multiple pages on a single sheet of paper, or want to control the special printing features of a printer or application, choose options in the Print dialog.

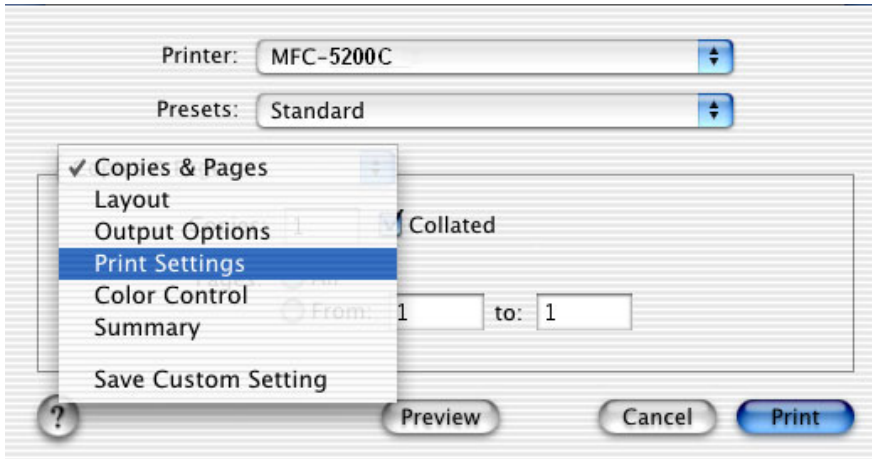



# Sending a fax from your Macintosh® application (OS 8.5 - 9.2)

You can send a fax directly from a Macintosh® application by doing the following:

- 1 Create a document in a Macintosh application.
- 2 To send a fax, select **Print** from the **File** menu.  
The Printer dialog box will appear:

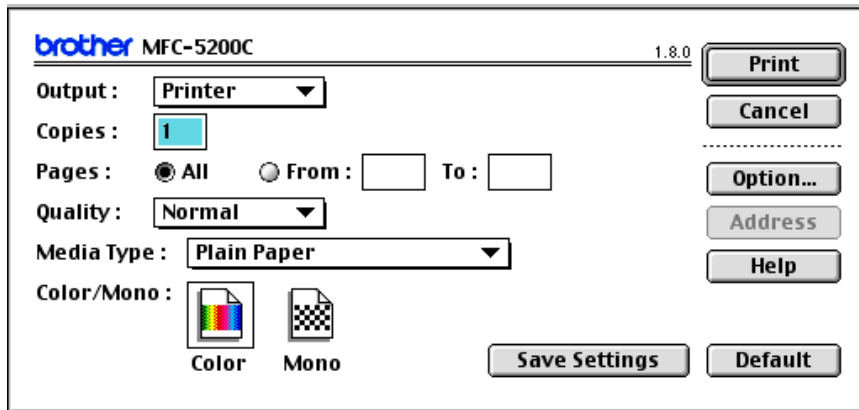

When **Printer** is selected, the top button shows **Print** and the Address button is grayed.

- 3 From the **Output** pull-down menu, select **Facsimile**.

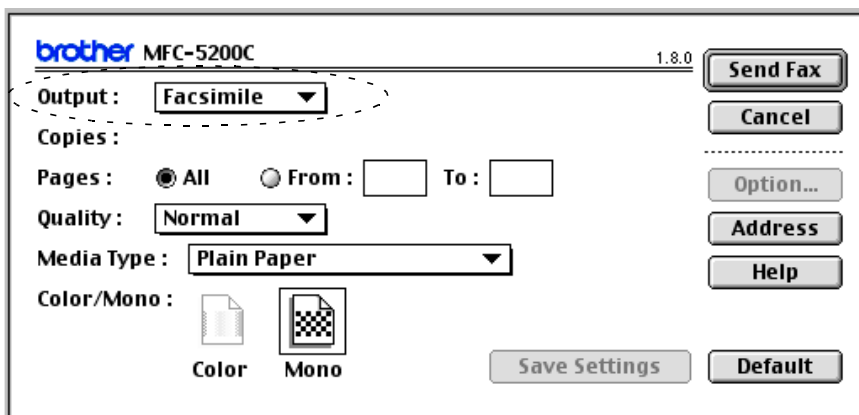

When **Facsimile** is selected, the top button changes to **Send Fax** and the **Address** button will be available.



## Setting up your Address Book

---

You can add new Members and Groups to your Address Book, while you are addressing a fax.

### Adding a new Member

- 1 To add a new Member to the Address Book, in the Facsimile dialog box click **Address**.

The Address Book dialog box will appear:

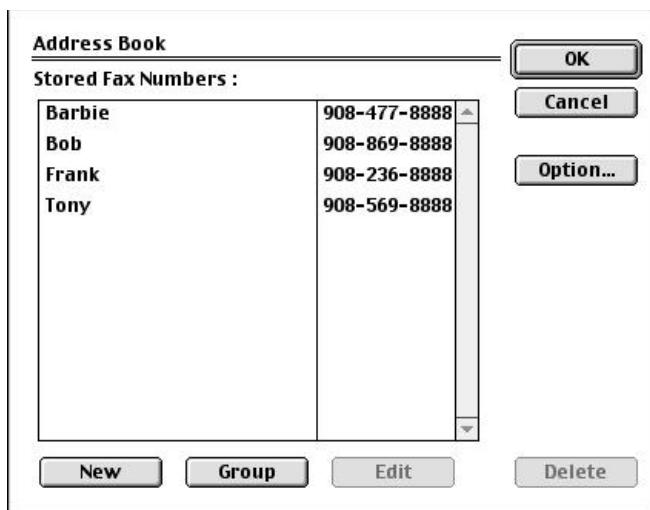

The Address Book dialog box is titled "Address Book". It features a table with the following data:

Stored Fax Numbers :	
Barbie	908-477-8888
Bob	908-869-8888
Frank	908-236-8888
Tony	908-569-8888

Buttons in the dialog box include "OK", "Cancel", "Option...", "New", "Group", "Edit", and "Delete".

- 2 Click **New**. The following dialog box will appear:

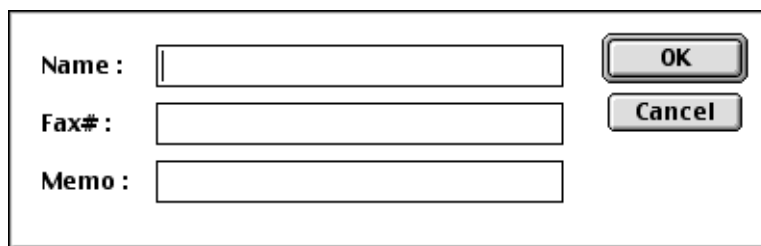

The New Member dialog box contains three input fields and two buttons:

- Name :
- Fax# :
- Memo :
- Buttons: "OK" and "Cancel"

- 3 Type the name and fax number.
- 4 You can store a comment in the Memo field (up to 15 characters).
- 5 Click **OK** to go back to the Address Book dialog box.

## Adding a new Group

You can set up a Group of people that you send the same fax to.

**1** Click **Group**.

The Group Setting dialog box will appear.

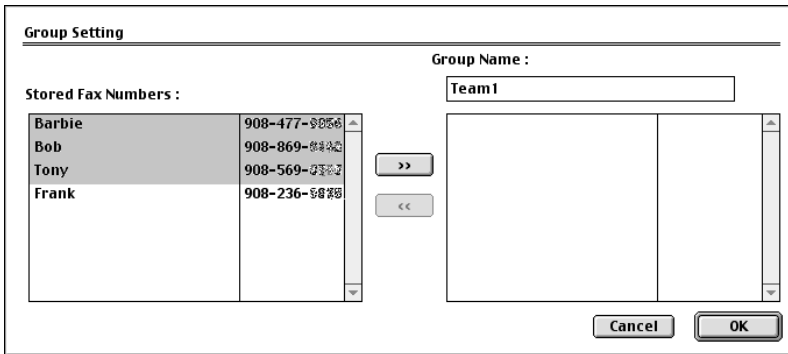

**2** In the Group Name field, type a name for your Group.

**3** In the **Stored Fax Numbers** box select the people for your Group. Click.

The selected people will appear in the box under the **Group Name** field.

**4** Click **OK** to go back to the Address Book dialog box.

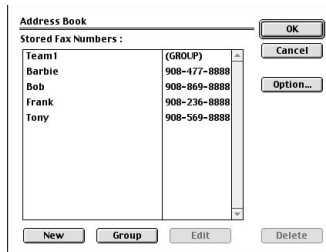

**5** Click **OK** to go back to the Print/Facsimile dialog box.

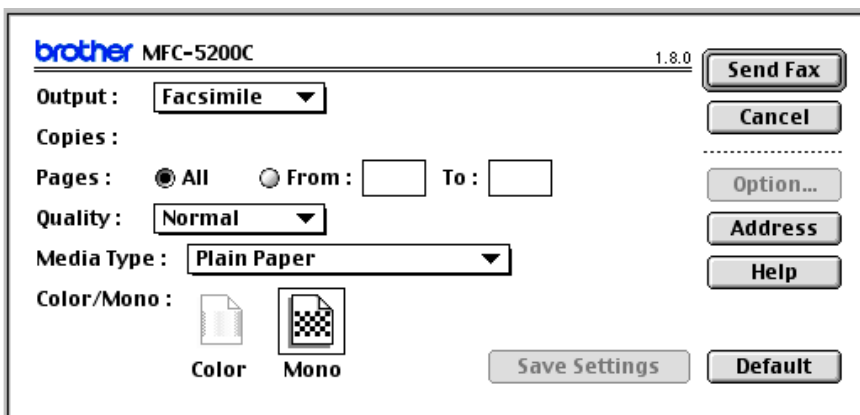

**6** Then if you are ready to send your fax, click **Send Fax**.

# Using the Brother TWAIN scanner driver with your Macintosh® (For Mac® OS 8.6 - 9.2 and OS X 10.2.1 or greater)

The Brother MFC software includes a TWAIN Scanner driver for Macintosh®. You can use this Macintosh® TWAIN Scanner driver with any applications that support the TWAIN specifications.

## Accessing the scanner

Run your Macintosh® TWAIN-compliant application software. The first time you use the Brother TWAIN driver (MFL Pro/P2500), set it as the default by choosing **Select Source** (or the other menu name to select the device). Afterwards, for each document you scan choose **Acquire Image** or **Scan**. The scanner setup dialog box will appear.

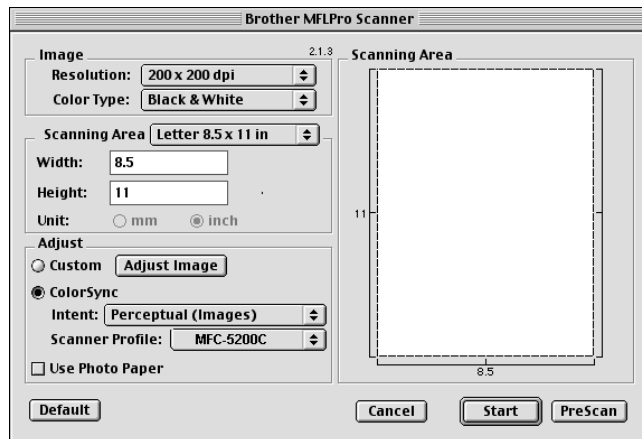

 If you are using PaperPort® 5.5 for Mac, from the ScanSoft menu (located below the ScanSoft icon on the Macintosh desktop menu bar), choose **Acquire Image**. For details about the ScanSoft menu selections, please refer to the PaperPort® Online Documentation located in the PaperPort® 5.5 Folder/User Docs/Splashug.pdf file.

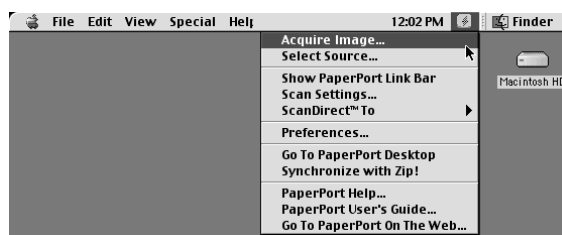

# Scanning an image into your Macintosh®

---

You can scan a whole page

—OR—

scan a portion after prescanning the document.

## Scanning a whole page

- 1** Place the original face up in the ADF, or face down on the scanner glass.
- 2** Adjust the following settings, if needed, in the Scanner Setup dialog box:
  - Resolution*
  - Color Type*
  - Scanning Area*
  - Brightness*
  - Contrast*
  - Color Sync*
- 3** Click **Start**.

When scanning has finished, the image will appear in your graphics application.

## PreScanning an image

---

PreScanning allows you to scan an image quickly at a low resolution. A thumbnail version will appear in the Scanning Area. This is only a preview of the image, so you can see how it will look. The PreScan button will allow you to crop unwanted areas from the images. When you are satisfied with the preview, click **Start** to scan the image.

- 1** Insert the original face up in the ADF, or face down on the scanner glass.
- 2** Click **PreScan**.  
The whole image will be scanned into your Macintosh® and will appear in the Scanning Area of the Scanner dialog box:
- 3** To scan a portion of the prescanned image, click and drag the mouse to crop it.

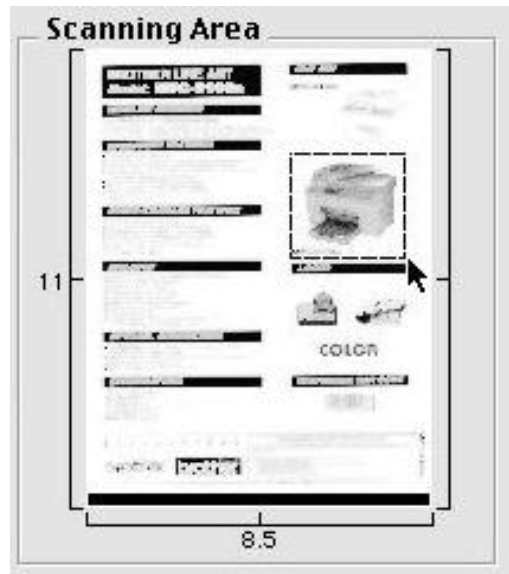

- 4** Insert the original again face up in the ADF, or face down on the scanner glass.
- 5** Make your adjustments to the settings for Resolution, Color Type (Gray Scale), Brightness, Contrast, and Size in the Scanner Setup dialog box.
- 6** Click **Start**.  
This time only the cropped area of the original will appear in the Scanning Area.
- 7** In your editing software, you can refine the image.

# Settings in the Scanner window

## Image

### Resolution

From the Resolution pop-up menu choose the scanning resolution. Higher resolutions use more memory and transfer time, but produce a finer scanned image.

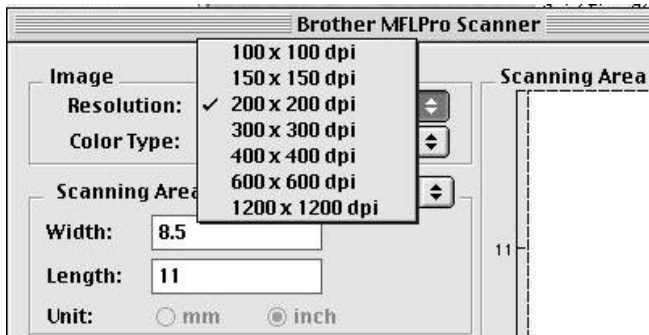

### Color Type

**Black & White**—Set the image Type to Black and White for text or line art. For photographic images, set the image type to Gray (Error diffusion) or True Gray.

**Gray (Error Diffusion)**—is used for documents with photographic images or graphics. (Error Diffusion is a method for creating simulated gray images by placing black dots instead of the true gray dots in a specific matrix instead of true gray dots.)

**True Gray**—is used for documents with photographic images or graphics. This mode is more exact because it uses up to 256 shades of gray. It requires the most memory and takes the longest transfer time.

**Colors**—Choose either 8-bit Color, which scans up to 8-bit Color or 24-bit color which scans up to 16.8 million colors. Although using 24-bit color creates an image with the most accurate colors, the image file will be about three times larger than a file created with 8-bit Color.

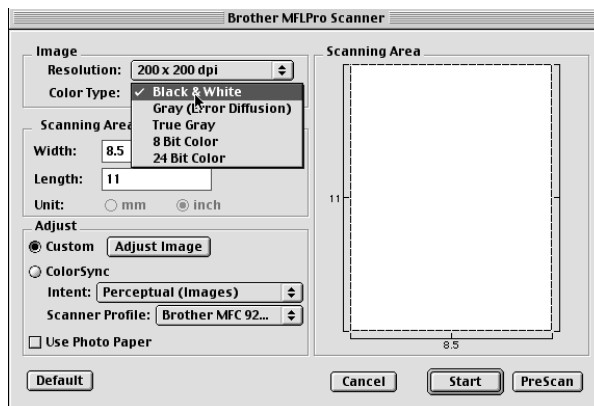



## Scanning Area

Set the **Size** to one of the following:

- *Letter* (8.5 × 11 inches)
- *A4* (210 × 297 mm)
- *Legal* (8.5 × 14 inches)
- *A5* (148 × 210 mm)
- *B5* (182 × 257 mm)
- *Executive* (7.25 × 10.5 inches)
- *Business Card* (90 × 60 mm)
- *Custom* (adjusts it from 0.35 × 0.35 inches to 8.5 × 14 inches)

After you choose a custom size, you can adjust the scanning area. Click and hold the mouse button as you drag the mouse to crop the image.

Width: Enter the width of the custom size.

Length: Enter the length of the custom size.

## Business Card Size

To scan business cards, select the Business Card size (90 × 60 mm) and place the business card at the center of scanner glass.

When you are scanning photographs or other images to use in a word processor or other graphics application, it is a good idea to try different settings for the Contrast, Mode and Resolution to determine which settings look the best.

## Adjusting the Image

### Brightness

Adjust the Brightness setting to get the best image. The Brother TWAIN Scanner driver offers 100 Brightness levels (-50 to 50). The default value is 0, representing an 'average' setting.

You can set the Brightness level by dragging the slide bar to the right to lighten the image or to the left to darken the image. You can also type a value in the box to set the level. Click **OK**.

If the scanned image is too light, set a lower Brightness level and scan the image again.

If the image is too dark, set a higher Brightness level and scan the image again.

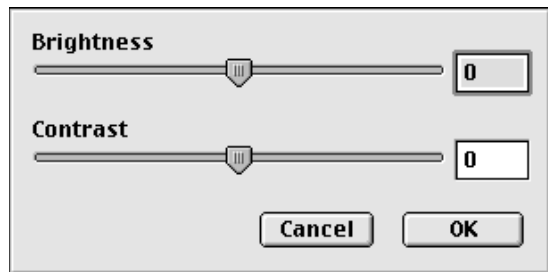

### Contrast

You can only adjust the Contrast level when you have selected one of the Gray Scale settings, it is not available when you have selected Black & White is selected as the Color Type.

Increasing the Contrast level (by dragging the slide bar to the right) emphasizes dark and light areas of the image, while reducing the Contrast level (by dragging the slide bar to the left) reveals more detail in the gray areas. Instead of using the slide bar, you can type a value in the box to set the Contrast. Click **OK**.

## Color Sync Dialog

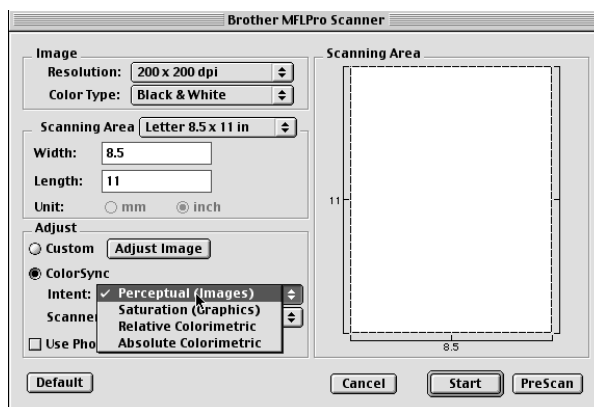

*Perceptual Matching*—All the colors of a given gamut are scaled proportionally to fit within another gamut. The purpose is to keep maintain the balance between the colors of the image. This is the best way to get realistic images, for photographs and other realistic graphics.

*Saturation Matching*—The relative saturation of colors is maintained from gamut to gamut. So basically the colors are shifted to the edge of the gamut to get the most saturated color possible. Rendering the image using this intent gives the strongest colors and is the best choice for bar graphs and pie charts, in which the actual color displayed is less important than its vividness.

*Relative Colorimetric Matching*—The colors that fall within the gamuts of both devices are left unchanged. Some colors in both images will be exactly the same, a useful outcome when colors must match quantitatively. What that means is that if the color is inside the gamut, it will stay the same color. However, if the color is outside the gamut, it will be mapped to the edge of the gamut. This intent is best suited for logos or “spot colors” where color must match.

*Absolute Colorimetric Matching*—A close appearance match may be achieved over most of the tonal range, but if the minimum density of the idealized image is different from that of the output image, the areas of the image that are left blank will be different. Colors that fall within the gamuts of both devices are left unchanged.

## Scanner Profile

Select your Brother MFC.

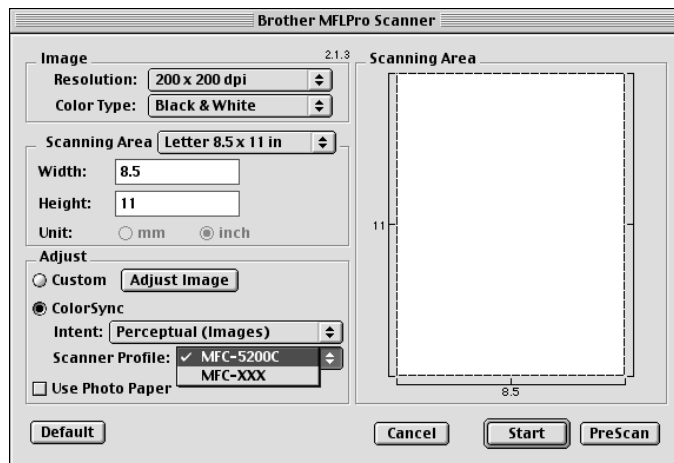

# MFC Remote Setup (Mac OS X 10.1, 10.2.1 or greater)

The MFC Remote Setup application allows you to quickly set up your MFC by taking advantage of the ease and speed of programming on your Macintosh®. When you access this application, the settings on your MFC will be downloaded automatically to your Macintosh® and displayed on your computer screen. If you change the settings, you can upload them directly to the MFC.



The 'Remote Setup' application icon is in Macintosh HD/Library/Printers/Brother/Utility.

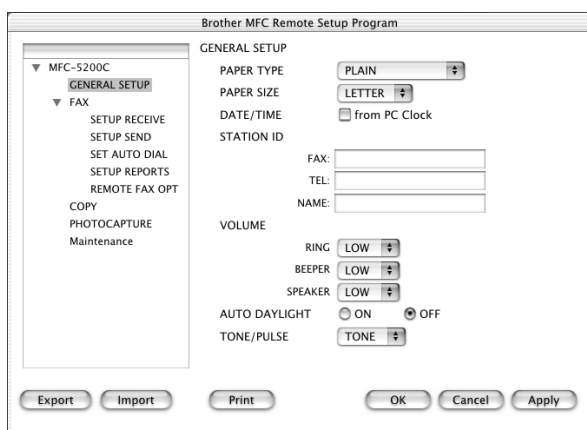

## OK

This starts the process of uploading the data to the MFC and exiting the remote setup program. If an error message is displayed enter the correct data again. Click **OK**.

## Cancel

This exits the remote setup application without uploading the data to the MFC.

## Apply

This uploads the data to the MFC, but does not exit the remote setup application.

## Print

This command prints the selected items on the MFC. You can not print the data until it is uploaded to the MFC. Click **Apply** to upload the new data to the MFC and click **Print**.

## Export

This command saves the current configuration settings to a file.

## Import

This command reads the settings from a file.

# Using the PhotoCapture Center™ from Macintosh®

You can access the Media Card inserted into the MFC from Macintosh®.



## For Mac OS 8.6 only

You have to download “USB Mass Storage Support 1.3.5” software from the web site of Apple® Macintosh®.

- 1 Insert a SmartMedia™, CompactFlash™ or Memory Stick™ card into your MFC. The removal disk icon will appear on the Desktop.
- 2 Double-click the Removable Disk icon. The files and folders that are on the media card will be displayed on your screen.
- 3 You can edit the file and save it to another drive on your Macintosh®.

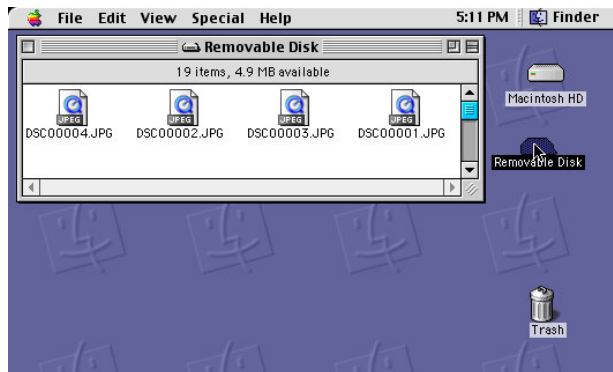

- 4 Quit all running applications that are stored on the media card and drag the removal disk icon onto Trash before you remove the media card from the MFC.



The Photo Capture Center™ will only read one card at a time so do not insert more than one media card at a time.



Do NOT unplug the power cord, USB cable or remove a SmartMedia™ or CompactFlash™ card from the MFC while the MFC is reading the card (LED is flashing). You will lose your data or damage the card.



While the MFC is printing from the PhotoCapture Center™, the Macintosh® cannot access the PhotoCapture Center™ for another operation.

# 20 Important information

## Standard telephone and FCC Notices

### These notices are in effect on models sold and used in the United States only.

#### When programming emergency numbers or making test calls to emergency numbers:

- Remain on the line and briefly explain to the dispatcher the reason for the call before hanging up.
- Perform these activities in the off-peak hours, such as early morning or late evening.

This equipment complies with Part 68 of FCC Rules. On the rear panel of this equipment is a label that contains, among other information, the FCC Registration Number and Ringer Equivalence Number (REN) for this equipment. You must, upon request, provide this information to your telephone company.

You may safely connect this equipment to the telephone line by means of a standard modular jack, USOC RJ11C.

An FCC compliant telephone cord with a modular plug is provided with this equipment. This equipment is designed to be connected to the telephone line or premises wiring using a compatible modular jack that is Part 68 compliant. See the Installation section of this manual for details.

The REN is useful to determine the quantity of devices you may connect to your telephone line and still have those devices ring when your telephone number is called. In most, but not all areas, the sum of the RENs of all devices connected to one line should not exceed five (5). To be certain of the number of devices you may connect to your line, as determined by the REN, you should contact your local telephone company to determine the maximum REN for your calling area. If your MFC-5200C damages the telephone line, the telephone company may discontinue your service temporarily. If possible, they will notify you in advance. But if advanced notice is not practical, you will be notified as soon as possible. You will be informed of your right to file a complaint with the FCC.

Your telephone company may make changes to its facilities, equipment, operations or procedures that could affect the proper functioning of your equipment. If they do, you will be notified in advance to give you an opportunity to maintain uninterrupted telephone service.

If you experience trouble with your MFC-5200C, please contact a Brother Authorized Service Center for information on obtaining service or repair. The telephone company may ask that you disconnect this equipment from the line until the problem has been corrected or until you are sure that the equipment is not malfunctioning.

If you are not able to solve a problem with your MFC, contact Brother Customer Service. (See *Brother numbers*, page i.)

 **WARNING**

For protection against the risk of electrical shock, always disconnect all cables from the wall outlet before servicing, modifying or installing the equipment.

This equipment may not be used on coin service lines provided by the telephone company or connected to party lines.

Brother cannot accept any financial or other responsibilities that may be the result of your use of this information, including direct, special or consequential damages. There are no warranties extended or granted by this document.

 **WARNING**

**Important—About the interface cable**

This machine has been certified to comply with FCC standards, which are applied to the USA only. The filter core supplied with your MFC should be attached to the shielded interface cable according to FCC 15, 27 (a). In addition, a grounded plug should be plugged into a grounded AC outlet after checking the rating of the local power supply for the printer to operate properly and safely.

# **Federal Communications Commission (FCC) Declaration of Conformity (USA only)**

---

Responsible Party: Brother International Corporation  
100 Somerset Corporate Boulevard  
Bridgewater, NJ 08807-0911 USA  
TEL: (908) 704-1700

declares, that the products

Product Name: MFC-5200C

comply with Part 15 of the FCC Rules. Operation is subject to the following two conditions: (1) This device may not cause harmful interference, and (2) this device must accept any interference received, including interference that may cause undesired operation.

This equipment has been tested and found to comply with the limits for a Class B digital device, pursuant to Part 15 of the FCC Rules. These limits are designed to provide reasonable protection against harmful interference in a residential installation. This equipment generates, uses, and can radiate radio frequency energy and, if not installed and used in accordance with the instructions, may cause harmful interference to radio communications. However, there is no guarantee that interference will not occur in a particular installation. If this equipment does cause harmful interference to radio or television reception, which can be determined by turning the equipment off and on, the user is encouraged to try to correct the interference by one or more of the following measures:

- Reorient or relocate the receiving antenna.
- Increase the separation between the equipment and receiver.
- Connect the equipment into an outlet on a circuit different from that to which the receiver is connected.
- Call the dealer or an experienced radio/TV technician for help.

## **Important**

Changes or modifications not expressly approved by Brother Industries, Ltd. could void the user's authority to operate the equipment.

## **Industry Canada Compliance Statement (Canada only)**

This Class B digital apparatus complies with Canadian ICES-003.

Cet appareil numérique de la classe B est conforme la norme NMB-003 du Canada.



## International ENERGY STAR® Compliance Statement

As an ENERGY STAR® Partner, Brother Industries, Ltd. has determined that product meets the ENERGY STAR® guidelines for energy efficiency.



## Important safety instructions

- 1** Read all of these instructions.
- 2** Save them for later reference.
- 3** Follow all warnings and instructions marked on the product.
- 4** Unplug this product from the wall outlet before cleaning. Do not use liquid or aerosol cleaners. Use a damp cloth for cleaning.
- 5** Do not use this product near water.
- 6** Do not place this product on an unstable cart, stand, or table. The product may fall, causing serious damage to the product.
- 7** Slots and openings in the cabinet and the back or bottom are provided for ventilation; to ensure reliable operation of the product and to protect it from overheating, these openings must not be blocked or covered. The openings should never be blocked by placing the product on a bed, sofa, rug, or other similar surface. This product should never be placed near or over a radiator or heater. This product should never be placed in a built-in installation unless proper ventilation is provided.
- 8** This product should be operated from the type of power source indicated on the label. If you are not sure of the type of power available, consult your dealer or local power company.
- 9** This product is equipped with a 3-wire grounding type plug, a plug having a third (grounding) pin. This plug will fit into only a grounding-type power outlet. This is a safety feature. If you are unable to insert the plug into the outlet, call your electrician to replace your obsolete outlet. Do not defeat the purpose of the grounding-type plug.
- 10** Do not allow anything to rest on the power cord. Do not place this product where people can walk on the cord.

- 11** If an extension cord is used with this product, make sure that the total ampere ratings on the products plugged into the extension cord do not exceed the extension cord ampere rating. Also, make sure that the total of all products plugged into the wall outlet does not exceed 15 amperes (USA only).
- 12** Do not place anything in front of the machine that will block received faxes. Do not place anything in the path of received faxes.
- 13** Wait until pages have exited the machine before picking them up.
- 14** Never push objects of any kind into this product through cabinet slots, since they may touch dangerous voltage points or short out parts resulting in the risk of fire or electric shock. Never spill liquid of any kind on the product.
- 15** Do not attempt to service this product yourself, as opening or removing covers may expose you to dangerous voltage points and/or other risks, and may void your warranty. Refer all servicing to Authorized Service Personnel. A list of Authorized Service Centers has been included for your convenience, or you may contact Customer Service for your nearest Brother Authorized Service Center. (See *Brother numbers*, page i.)
- 16** Unplug this product from the wall outlet and refer servicing to Authorized Service Personnel under the following conditions:
  - A** When the power cord is damaged or frayed.
  - B** If liquid has been spilled into the product.
  - C** If the product has been exposed to rain or water.
  - D** If the product does not operate normally when the operating instructions are followed. Adjust only those controls that are covered by the operating instructions. Improper adjustment of other controls may result in damage and will often require extensive work by a qualified technician to restore the product to normal operation.
  - E** If the product has been dropped or the cabinet has been damaged.
  - F** If the product exhibits a distinct change in performance, indicating a need for service.
- 17** To protect your product against power surges, we recommend the use of a power protection device (Surge Protector).

# Trademarks

The Brother logo is a registered trademark of Brother Industries, Ltd.

Brother is a registered trademark of Brother Industries, Ltd.

PhotoCapture Center is a trademark of Brother International Corporation.

Multi-Function Link and True2Life are registered trademarks of Brother International Corporation.

© Copyright 2002 Brother Industries, Ltd. All rights reserved.

Windows and Windows NT, Microsoft, MS-DOS, Excel and Word are registered trademarks of Microsoft in the U.S. and other countries.

Macintosh and QuickDraw are a registered trademarks and iMac and iBook are trademarks of Apple Computer, Inc.

PaperPort and TextBridge are registered trademarks of ScanSoft, Inc.

IBM, IBM PC and Proprinter are registered trademarks of International Business Machines Corporation.

Hammermill and JetPrint PHOTO are registered trademarks of International Paper.

SmartMedia is a trademark of Toshiba Corporation.

CompactFlash is a trademark of SanDisk Corporation.

Memory Stick is a trademark of Sony Corporation.

Each company whose software title is mentioned in this manual has a Software License Agreement specific to its proprietary programs.

**All other brand and product names mentioned in this manual are registered trademarks of their respective companies.**

# 21 Troubleshooting and routine maintenance

## Troubleshooting

### IMPORTANT

For technical and operational help, you must call the country where you bought the MFC. Calls must be made **from within** that country.

## Error Messages

As with any sophisticated office product, errors may occur. If this happens, your MFC identifies the problem and displays an error message. The most common error messages are shown below.

You can correct most problems by yourself. If you need additional help, call the Brother fax back system (USA only).

**In USA only:** 1-800-521-2846

ERROR MESSAGES		
ERROR MESSAGE	CAUSE	ACTION
CHECK CARTRIDGE	An ink cartridge is not properly installed.	Take out the ink cartridge and put it in again seating it properly. See <i>Replacing the ink cartridge</i> on page 21-17.
CHECK ORIGINAL	Original was not inserted or fed properly, or was larger than 40 inches (90cm) when it was scanned through the ADF.	See <i>Original jams</i> on page 21-3.
CHECK PAPER SIZE	Paper is not the correct size.	Reload the correct size of paper, and then press <b>Fax Start</b> .
CHECK PAPER	The MFC is out of paper.	Add paper, and then press <b>Fax Start</b> .
COMM. ERROR	Poor phone line quality caused a communication error.	Try the call again. If the problem continues, call the telephone company and ask them to check your phone line.
CONNECTION FAIL	You tried to poll a fax machine that is not in Polled Waiting mode.	Check the other fax machine's polling setup.
COVER OPEN	The scanner cover is not closed completely.	Pull the Scanner Cover Release Lever and lift the scanner cover and then close it again.
DISCONNECTED	The other person or other person's fax machine stopped the call.	Try to send or receive again.

ERROR MESSAGES		
ERROR MESSAGE	CAUSE	ACTION
DOC. COVER OPEN	The document cover is open.	Remove any paper from the ADF and close the document cover, and then press <b>Stop/Exit</b> .
DR MODE IN USE	The machine is set to Distinctive Ring mode. You can not change the Receive Mode from Manual to another mode.	Set Distinctive Ring to OFF. (See <i>Turning off the Distinctive Ring</i> on page 5-11.)
HIGH TEMPERATURE	The print heads are too warm.	Allow the MFC to cool down.
INK EMPTY	One or more of the ink cartridges is empty. The MFC will stop all print operations. While memory is available, black and white faxes will be received into memory. If a sending machine has a color fax, the MFC's 'handshake' will request that the fax be sent as black and white. If the sending machine has the ability to convert it, the color fax will be received into memory as a black and white fax. Only MFC's that are connected with a USB cable will be able to perform scan operations. MFCs that are connected with a parallel cable, will not scan. To ensure good print quality, the MFC will regularly clean the print heads. You can press <b>Ink</b> to start the cleaning process when needed. (The cleaning process uses up ink and can cause the ink to run out.)	Replace the ink cartridges. See page 21-17.
LOW TEMPERATURE	The print heads are too cold.	Allow the machine to warm up.
MACHINE ERROR XX	The MFC has a mechanical problem.	Call Brother Customer Service. <b>In USA: 1-800-284-4329</b> <b>In Canada: 1-877-BROTHER</b> <b>In Montreal: (514) 685-6464</b>
MEDIA ERROR	The media card is either bad or not formatted.	Reinsert the correct media card.
NEAR EMPTY	One or more of the ink cartridges are running out of ink. See INK EMPTY.	Order a new ink cartridge. See <i>Ordering accessories and supplies</i> on page ii.
NO FILE	The media card in the media drive does not contain a .JPG file.	Reinsert the correct media card.
NO RESPONSE/ BUSY	The number you dialed does not answer or is busy.	Verify the number and try again.
NOT REGISTERED	You tried to access a Speed Dial number that is not programmed.	Set up the Speed Dial number. See <i>Storing Speed Dial numbers</i> on page 7-1.
OUT OF MEMORY	The data is too large for the MFC's memory.	See <i>Out of memory message</i> on page 10-3.
PAPER JAM	The paper is jammed in the MFC.	See <i>Printer Jam or Paper Jam</i> on page 21-4.
UNSUPPORTED CARD	You inserted the media card which can not be used.	Reinsert the correct media card.

## Original jams

---

Based upon where the original or printed sheet is jammed, follow the appropriate set of instructions to remove it.

### Original is jammed in the top of the ADF unit.

- 1 Take out any paper from the ADF that is not jammed.
- 2 Lift the ADF cover
- 3 Pull the jammed original out to the right.
- 4 Close the ADF cover.
- 5 Press **Stop/Exit**.

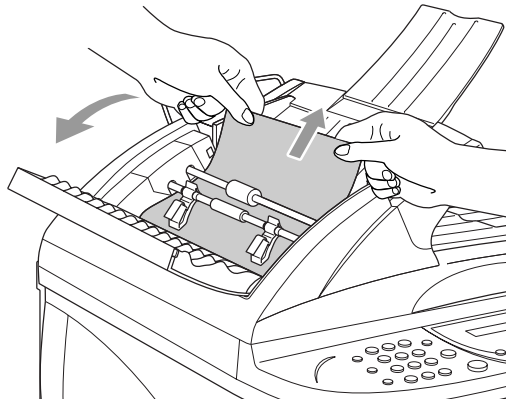

### Original is jammed inside the ADF unit.

- 1 Take out any paper from the ADF that is not jammed.
- 2 Lift the document cover.
- 3 Pull the jammed original out to the right.
- 4 Close the document cover.
- 5 Press **Stop/Exit**.

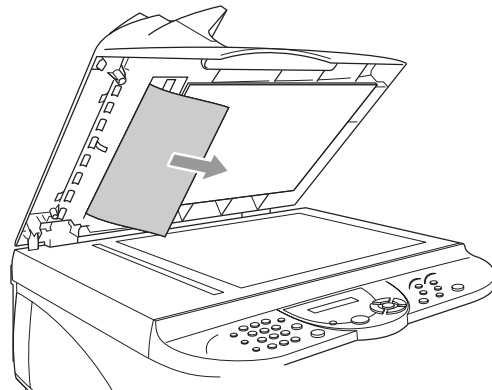

## Printer Jam or Paper Jam

---

Remove the jammed paper depending on where it is jammed in the MFC.

### Paper is jammed in the paper tray.

- 1 Remove any paper from the paper tray that is not jammed.
- 2 Pull up the jammed paper to remove it.

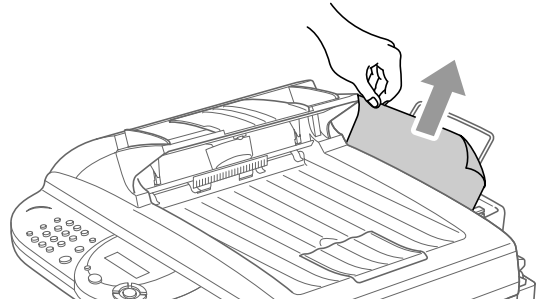

-  If you have difficulty removing the jammed paper, press and hold the paper release lever as you pull out the page.

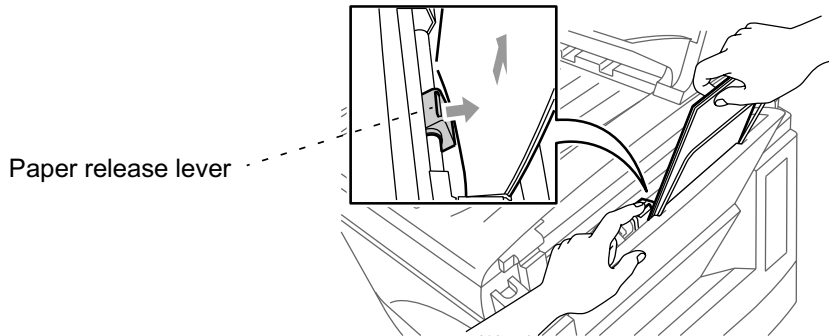

-  To improve the reliability of paper feeding, turn on Secure Feed mode by pressing the **Ink** and **Scan to** keys simultaneously. The MFC will then feed paper more securely, but paper feeding will take a longer time. To turn off the Secure Feed mode, simultaneously press **Ink** and **Scan to** again.

## Paper is jammed inside the MFC.

**1** Open the scanner cover by releasing the scanner cover release lever and lifting the scanner cover.

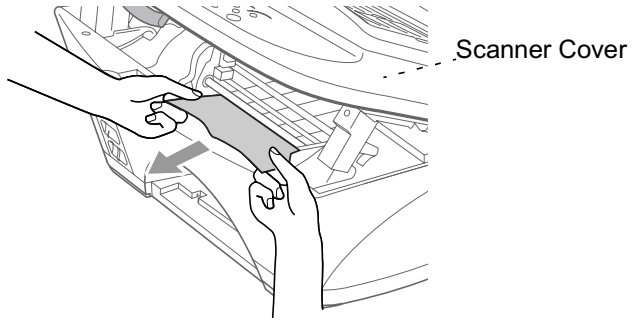

**2** Remove the jammed paper.

 If the jammed paper is under the print heads, unplug the MFC, and then you can move the print heads to take out the paper.

**3** Close the scanner cover.

## Paper is jammed inside the front of the MFC.

Pull the jammed paper toward you.

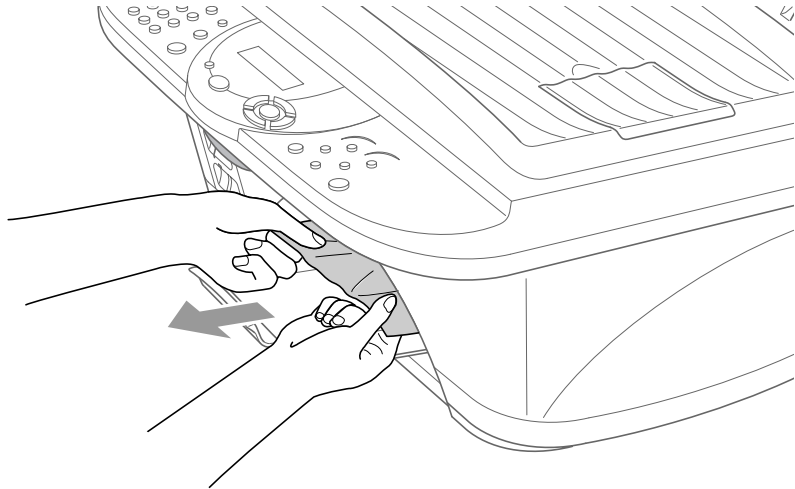



## Paper is jammed inside the back of the MFC.

If the paper rips, the pieces of paper may get stuck inside the back of the machine.

- 1 Remove any paper from the paper tray that is not jammed.
- 2 Open the manual feed cover.

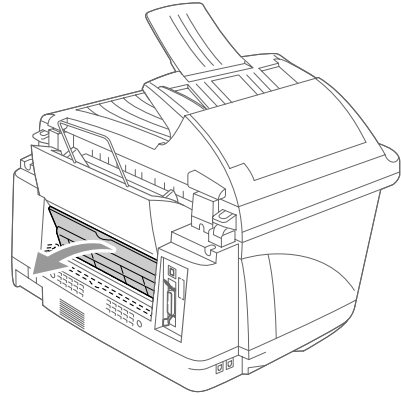

- 3 Use tweezers to pull out the ripped pieces of paper.

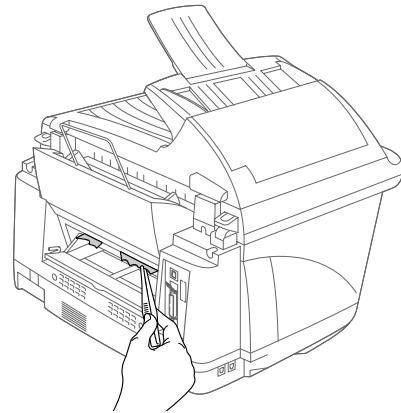

- 4 Close the manual feed cover.

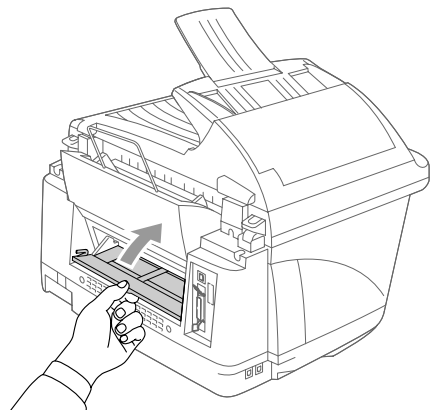

## If you are having difficulty with your MFC

If you think there is a problem with your MFC, *make a copy first*. If the copy looks good, the problem is probably not your MFC. Check the chart below and follow the troubleshooting tips.

DIFFICULTY	SUGGESTIONS
<b>Printing or Receiving Faxes</b>	
Condensed print and white streaks across the page or the top and bottom of sentences are cut off.	This can be caused by static or interference on the telephone line. You can make a copy using the copy function and see if the same problem occurs. If the copy looks bad, call Brother Customer Service at 1-800-284-4329 (in USA), 1-877-BROTHER (in Canada) or (514) 685-6464 (in Montreal).
Poor quality print	Make sure the Printer Driver or Paper Type setting in the function menu matches the type of paper you are using. (See <i>Media Type</i> on page 13-3. See <i>Setting the Paper Type</i> on page 4-1.) If you are using plain paper, try using the types of recommended paper (see Chapter 2). Don't handle the paper until the ink is dry. Adjust the Vertical Alignment (See <i>Print Quality Check</i> on page 21-10.).
Smudged stain at the top center of the printed page	Make sure the paper is not thick. (See <i>Paper</i> on page 2-1.)
Printing is too dark or too light.	Make sure your ink cartridges are fresh. Cartridges are good for up to two years, after that the ink may become clogged. Cartridge expiration dates are printed on the package. Make sure the Printer Driver matches the type of paper you are using (See <i>Media Type</i> on page 13-3.). Try using the recommended types of paper (see Chapter 2). The recommended environment for your MFC is between 68°F to 91°F (20°C to 33°C).
Printing appears dirty or ink seems to run	Make sure you are using the proper types of paper (see Chapter 2). Don't handle the paper until the ink is dry. The recommended environment for your MFC is between 68°F to 91°F (20°C to 33°C).
White lines appear in text or graphics.	Clean the print heads. (See <i>Cleaning the print head</i> on page 21-10.).
Stains appear on the reverse side or at the bottom of the page	Make sure the Printer Platen is not dirty with ink. (See <i>Cleaning the MFC printer platen</i> on page 21-17.).
Vertical black lines when receiving	The sender's scanner may be dirty. Ask the sender to make a copy to see if the problem is on with the sending machine. Try receiving from another fax machine. If the problem continues, call Brother Customer Service at 1-800-284-4329 (in USA), 1-877-BROTHER (in Canada) or (514) 685-6464 (in Montreal).
Received color fax prints only in black and white.	Replace the color ink cartridges that are empty or nearly empty, and then ask the other person to send the color fax again. (See <i>Replacing the ink cartridge</i> on page 21-17.) Check that Fax Storage is set to OFF. (See <i>Setting Fax Storage</i> on page 8-3.)
Left and Right margins are cut off	Turn on Auto Reduction. (See <i>Printing a reduced incoming fax (Auto Reduction)</i> on page 5-4.)
The MFC does not feed the paper in the manual feed slot correctly.	<ol style="list-style-type: none"> <li>1. Make sure the printer platen is not dirty with ink. If it is dirty, clean it. (See <i>Cleaning the MFC printer platen</i> on page 21-17.)</li> <li>2. If the paper is curled, straighten it.</li> <li>3. Re-insert the paper all the way in so that the top touches the internal parts.</li> <li>4. Make sure you set the <b>MANUAL FEED</b> to ON by pressing the <b>Options</b> key on the control panel or select the Manual Feed in your printer driver.</li> </ol>

DIFFICULTY	SUGGESTIONS
<b>Phone Line or Connections</b>	
The MFC does not answer when called	If the Manual mode is selected, the machine cannot answer a call. (See <i>Choosing the Receive Mode</i> on page 5-1.) If the receive mode is set to TAD, please check that the external answering machine is set properly to answer a call. (See <i>Connecting an External Telephone Answering Device (TAD)</i> on page 1-8.) Check for a dial tone. If possible, call your MFC to hear it answer. If there is still no answer, check the telephone line cord connection. If there is no ringing when you call your MFC, ask your telephone company to check the line.
<b>Sending Faxes</b>	
Poor sending quality	Try changing your resolution to <i>FINE</i> or <i>S. FINE</i> . Make a copy to check your MFC's scanner operation.
Transmission Verification Report says 'Result:NG' or 'Result:ERROR'	There is probably temporary noise or static on the line. Try sending the fax again. If you send a PC FAX message and get 'Result:NG' or, on the Transmission Verification Report, your MFC may be out of memory. To gain extra memory, you can turn off Fax Storage (see <i>Setting Fax Storage</i> on page 8-3.), print fax messages in memory (see page 5-6.) or cancel a Delayed Fax or Polling Job (see <i>Canceling a job in the memory</i> on page 6-10.). If the problem continues, ask the telephone company to check your phone line.
Vertical black lines when sending	If the copy you made shows the same problem, your scanner is dirty (See <i>Cleaning the Scanner</i> on page 21-16.).
<b>Handling Incoming Calls</b>	
MFC 'Hear' Voice as CNG Tone	If your MFC is set to Easy Receive ON, it is more sensitive to sounds. Your MFC may mistakenly interpret certain voices or music on the line as a calling fax machine and respond with fax receiving tones. Deactivate the fax by pressing <b>Stop/Exit</b> . Try avoiding this problem by turning Easy Receive to OFF. (See <i>Easy Receive</i> , page 5-4)
Sending a Fax Call to the MFC	If you answered at the MFC, press <b>Fax Start</b> and hang up immediately. If you answered on an extension phone, press your Fax Receive Code (default setting is ( * 51). When your MFC answers, hang up.
Custom features on a single line	If you have Call Waiting, Caller ID, Call Waiting/Caller ID, Ring Master, Voice Mail, an alarm system or any other custom feature on a single phone line with your MFC, it may create a problem sending or receiving fax data. For example: If you are sending or receiving a fax message while a custom feature signal comes through on the line, the signal can temporarily interrupt or disrupt the fax data. Brother's ECM feature should help overcome this problem. This condition is related to the telephone system industry and is common to all devices that send and receive data on a single, shared line with custom features. If avoiding a slight interruption is crucial to your business, we recommend a separate phone line with no custom features.
<b>Printer Difficulties</b>	
Horizontal lines appear in text or graphics.	Clean the print head (see <i>Cleaning the print head</i> on pages 21-10). If you clean the print heads five times and the print has not improved, call Brother Customer Service at 1-800-284-4329 (in USA), 1-877-BROTHER (in Canada) or (514) 685-6464 (in Montreal).
<b>Scanning Difficulties</b>	
TWAIN errors appear while scanning	Make sure the Brother TWAIN driver is selected as the primary source. In PaperPort®, click Scan in the File menu and select the Brother Twain driver.
<b>Software Difficulties</b>	
Cannot perform '2 in 1 or 4 in 1' printing.	Check that the paper size setting in the application and in the printer driver are the same.

DIFFICULTY	SUGGESTIONS
Cannot print when using Paint Brush.	Try setting the Display setting to '256 colors.'
Cannot print when using Adobe Illustrator.	Try to reduce the print resolution.
Thick lines and thin lines appear alternately. (banding)	<ol style="list-style-type: none"> <li>1. Open 'Basic' tab in the printer driver.</li> <li>2. Click 'Setting' in the 'Quality' section.</li> <li>3. Turn OFF 'Bi-Directional Printing' by un-checking it.</li> </ol>
There are some dense lines.	Check 'Reverse Order' in the Basic tab of the printer driver.
When using ATM fonts, some characters are missing or some characters are printed in their place.	If you are using Windows® 95/98/98SE/Me, select 'Printer Settings' from the 'Start' menu. Open 'Brother XXXX' properties. Click 'Spool Setting' on the 'Details' tab. Select 'RAW' from 'Spool Data Format.'
Printing is slow.	In the 'Color' tab from the 'Advanced' tab in the printer driver, select 'Auto' in the Image Type section.
True2Life® is not working correctly.	If the image data is not full color in your application (Such as 256 color), True2Life® will not work. Please use at least 24 bit color data with the True2Life® feature.
'Unable to write to LPT1' or 'LPT1 already in use' Error Message appears.	<ol style="list-style-type: none"> <li>1. Make sure the MFC is on (plugged into the AC outlet) and switched on and that it is connected directly to the computer using the IEEE-1284 bi-directional parallel cable. The cable must not go through another peripheral device (such as a Zip Drive, External CD-ROM Drive, or Switch box) and should not be longer than 6 feet (2m).</li> <li>2. Make sure the MFC is not showing an error message on the LCD.</li> <li>3. Make sure that there are no other device drivers, using the parallel port, or software applications running automatically that start up when you turn on the computer (such as, drivers for Zip Drivers, External CD-ROM Drive, and so on.). Suggested areas to check: (Load=, Run=command lines in the win.ini file or the Startup Group).</li> <li>4. Ask with your computer manufacturer to confirm that the computer's parallel port settings in the BIOS are set to support a bi-directional machine, such as Parallel Port Mode-ECP</li> </ol>
'MFC is Busy' or 'MFC Connect Failure' Error Message appears.	
'MFC Connect Failure'	If the MFC is not connected to your PC and you have loaded the Brother software, the PC will show 'MFC Connect Failure' each time you restart Windows®. You can ignore this message or you can turn it off by deselecting the <b>AutoLoad PopUp</b> check box in the Brother Control Center chapter. (See <i>How to turn off AutoLoad</i> on page 14-2.)
<b>PhotoCapture Center™ Difficulties</b>	
Removable Disk does not work properly.	<ol style="list-style-type: none"> <li>a) Have you installed the Windows® 2000 update? If not, do the following: <ol style="list-style-type: none"> <li>1. Disconnect the USB cable.</li> <li>2. Install the Windows 2000® update. Please see the Quick Setup Guide. After the installation the PC will be automatically restarted.</li> <li>3. Wait about 1 minute after you reboot the PC, and then connect the USB cable.</li> </ol> </li> <li>b) Take out the media card and put it back in again.</li> <li>c) If you have tried "Eject", you must take out the media card before you continue.</li> <li>d) If an error message appears when you try to eject the media card, it means the card is being accessed. Wait a while and then try again.</li> <li>e) If all of the above do not work, please turn off your PC and MFC, and then turn them on again. (You will have to unplug the power cord of the MFC to turn it off.)</li> </ol>

# How to improve print quality



## Cleaning the print head

---

Clean the print head if you get a horizontal line in the text or graphics on your printed pages. You can clean the four color print heads (black, cyan, yellow, magenta) or a single color by using the **Ink** key.

### **WARNING**

**Do NOT clean the print head by touching it with your hand or a cloth.**

- 1 Press **Ink**.
- 2 Press **1** to select 1 .CLEANING.
- 3 Press  or  to select the color you want to clean or select all colors.

Press **Menu/Set**.

The MFC will clean the print head. When cleaning is finished, the LCD shows date and time.





If you clean the print head at least five times and the print has not improved, call Brother Customer Service for help at 1-800-284-4329 (in USA), 1-877-BROTHER (in Canada), or (514) 685-6464 (in Montreal).

## Print Quality Check

---

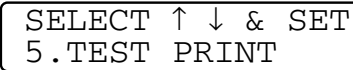
If the print quality is not good, you can print a Print Quality Check Sheet to help you find the settings you may need to change.

- 1 Press **Menu/Set**, **5**.  

- 2 Press **Fax Start**.  
The MFC begins printing the Print Quality Check Sheet.  

- 3 Check the sheet to see if the quality and alignment are OK by following STEPs A and B.

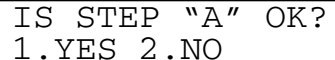
### **STEP A: Color block quality check**

The LCD shows:



IS STEP "A" OK?  
1 .YES 2 .NO

- 4 Check the quality of the four color blocks on the sheet. (BLACK/CYAN/YELLOW/MAGENTA).

**5** If all lines are clear and visible, press **1** (YES) to go to **STEP B**.

—OR—

If you can see missing short lines below, press **2** (NO).

OK

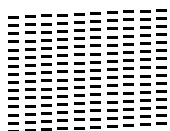

Poor

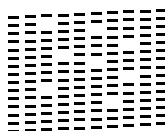

The LCD will ask you if the print quality is OK for each color.

BLACK OK?  
1 . YES 2 . NO

**6** Press **2** (NO) for any color with a problem.

The LCD shows:

Press **1** (YES). the MFC will start cleaning the colors.

START CLEANING?  
1 . YES 2 . NO

**7** After cleaning is finished, press **Fax Start**. The MFC will start printing the Print Quality Check Sheet again and then return to **STEP A**.

**8** If **STEP A** is OK, press **1** to proceed to **STEP B**.

## STEP B: Alignment Check

The LCD shows:

IS STEP "B" OK?  
1 . YES 2 . NO

**9** Check the 600 DPI and 1200 DPI test prints to see if number 5 most closely matches number 0. If the number 5 sample of both the 600 DPI and 1200 DPI are the best matches, press **1** (YES) to finish **STEP B**.

—OR—

If another test print number is a better match for either 600 DPI or 1200 DPI, press **2** (NO) to select it.

**10** For 600 DPI, press the number of the test print that most closely matches the number 0 sample (1-8).

600DPI ADJUST  
SELECT BEST #

**11** For 1200 DPI, press the number of the test print that most closely matches the number 0 sample (1-8).

1200DPI ADJUST  
SELECT BEST #

**12** Repeat Steps 1 and 2 (in *Print Quality Check*) to print another sample Print Quality Check Sheet and then check it.

**13** Press **Stop/Exit**.



When an ink head nozzle is clogged the printed sample looks like this.



After the ink head nozzle is cleaned, the horizontal lines are gone.

If you still see missing ink in this Print Quality Check Sheet, repeat the cleaning and test print procedures at least five times. If ink is still missing after the fifth cleaning and test print, replace the ink cartridge for the clogged color. (Perhaps the ink cartridge was in your MFC over six months or the expiration date written on the cartridge package has passed. Or, the ink may not have been stored properly before use.)



After replacing the ink cartridge, check it by printing another Print Quality Check Sheet. If the problem still exists, repeat the cleaning and test print procedures at least five times for the new ink cartridge. If ink is still missing, call Customer Service at 1-800-284-4329 (**in USA**), 1-877-BROTHER (**in Canada**) or (514) 685-6464 (**in Montreal**).

**! Caution**

Do NOT touch the print head. Touching the print heads may cause permanent damage and may void the print head's warranty.

# Checking the ink volume

You can check the ink that is left in the cartridge.

- 1 Press **Ink**.
- 2 Press **3** to select 3 . INK VOLUME.
- 3 Press  or  to select the color you want to check.  
Press **Menu/Set**.  
The LCD shows the ink volume.

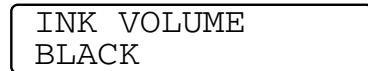

- 4 Press **Stop/Exit**.

# Packing and shipping the MFC

Whenever you transport the MFC, use the packaging that came with it. If you do not pack the MFC properly, you may void your warranty.

## WARNING

Do NOT unplug the MFC after a print job until you hear the final click.

- 1 Remove all the ink cartridges and attach the white shipping cover.  
(See *Replacing the ink cartridge* on page 21-17.)

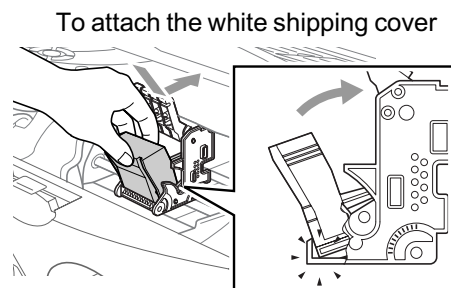

- 2 Attach the protective yellow bar and the wiper stopper.

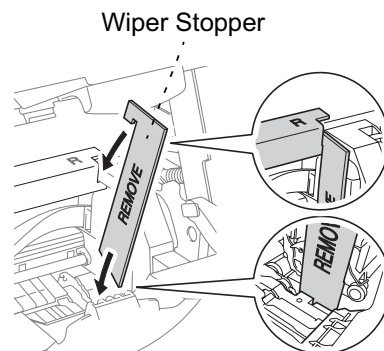
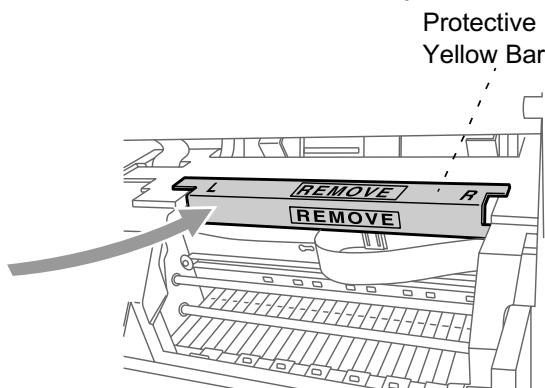



- 3** Unplug the MFC from the telephone wall jack (phone socket).
- 4** Unplug the MFC from the AC power outlet.
- 5** Unplug the Parallel cable or USB cable from the MFC.
- 6** Remove the telephone line cord, and put all the parts in their original packaging or protective wrapping.
- 7** Wrap the MFC in the plastic bag.

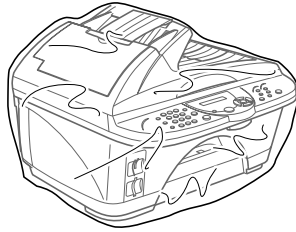

- 8** Place the MFC in the original box with the original packaging material.

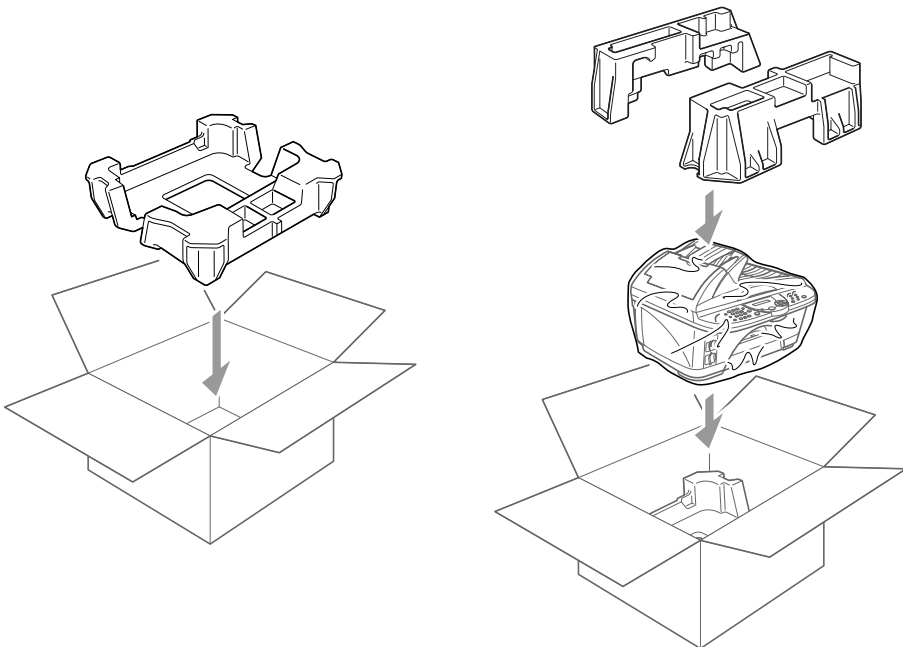

- 9** Pack any extra parts (cord and printed materials) in the box. DO NOT pack the used ink cartridges.

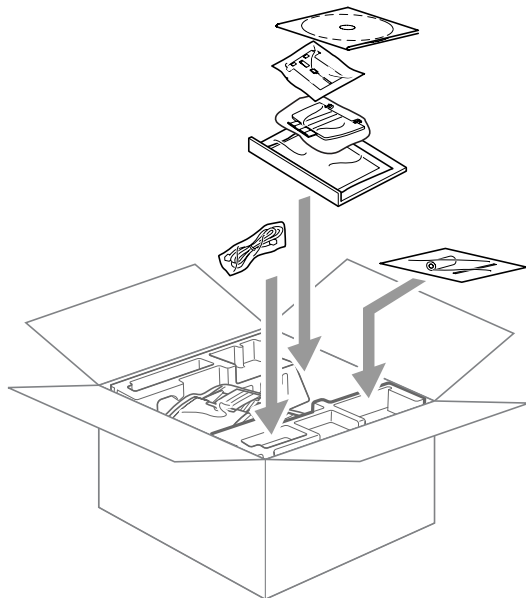

 If you are returning the MFC to Brother as part of the Brother Exchange Service, pack only the MFC. Keep all the separate parts to use with your 'Exchange' machine.

- 10** Close the carton.

# Routine maintenance

## Cleaning the Scanner

---

Unplug the MFC and lift the document cover. Clean the scanner glass and the white film with isopropyl alcohol on a soft lint-free cloth.

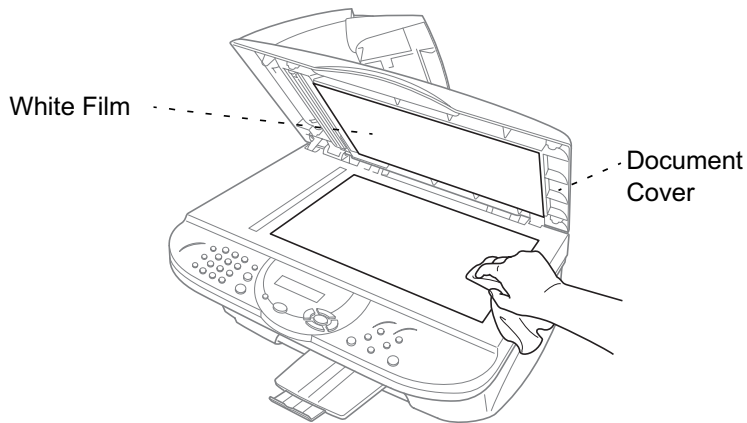

Open the document cover. Clean the white film and the glass strip under the film with isopropyl alcohol on a lint-free cloth.

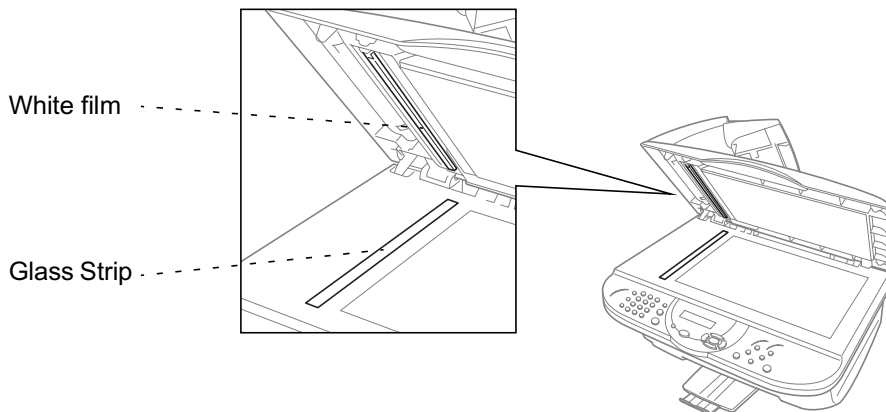

## Cleaning the MFC printer platen

---

### WARNING

- Be careful not to touch the paper feed star wheels and flat cable, and encoding film.
- Be sure to unplug the MFC from the AC power outlet before cleaning the printer platen.  
To clean your MFC printer platen, wipe it with a soft lint free cloth that is dry.

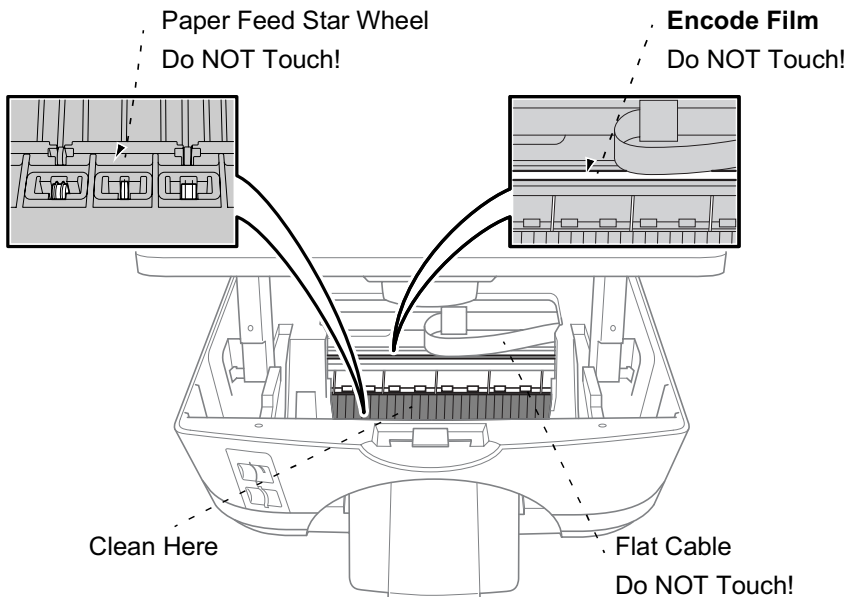



## Replacing the ink cartridge

---

Your MFC is equipped with an optical sensor that automatically monitors the ink level in each color cartridge. When the sensor detects an ink cartridge is running out of ink, the MFC will notify you with a message on the LCD.

The LCD shows you which color cartridges are low or empty. Be sure to follow the LCD prompts so you replace the color cartridges in the appropriate order.

**When the ink cartridges are running low, you must use the Ink key to begin the cartridge replacement (Steps 1 to 3). If the ink is empty, skip to Step 4.**

- 1** Press **Ink**.
- 2** Press  or  to choose **2 .REPLACE INK**.

**3** Press **Menu/Set**.

If one or more ink cartridges are empty, for example Black, the LCD shows INK EMPTY BLACK and PLS OPEN COVER.

**4** Pull the Scanner cover release lever and lift the Scanner cover.

**5** Press the appropriate colored ink cartridge cover to open it, and then remove the ink cartridge.

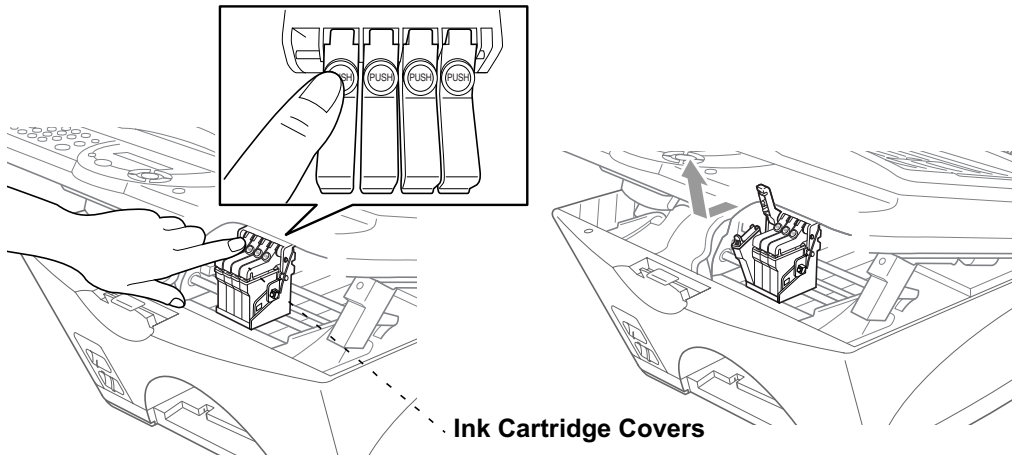

**6** Open the new ink cartridge bag for the color shown on the LCD, and then take out the ink cartridge.

**7** Hold the new ink cartridge as shown in the illustration, and then peel the sealing tape from the side of the ink cartridge. Carefully peel the tape in the direction away from you.

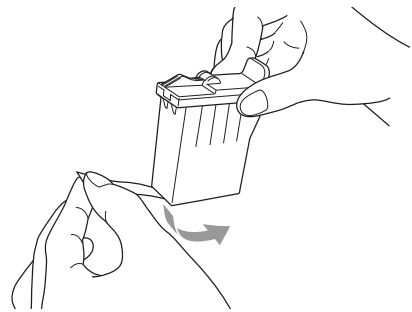

 To prevent spilling ink and staining your hands and clothing, remove the sealing tape gently.

**8** Each color has its own correct position. Insert the new ink cartridge into its carriage, and then close the ink cartridge cover by pressing until it clicks.

**9** After installing the ink cartridges, close the Scanner cover. Your MFC prepares for a “head cleaning” and goes online. The LCD prompts you to verify a new ink cartridge was inserted for each color you removed.

Example: DID YOU CHANGE BLCK? 1.YES 2.NO.

**10** If the ink cartridge you installed is not a brand new one, please make sure to select 2. For each new cartridge, press 1 on the dial pad to reset the ink dot counter for that color automatically.

The MFC will enter a cleaning cycle for approximately 3 minutes for each replaced cartridge. The LCD alternately shows `CLEANING` and `PLEASE WAIT`.

When the MFC completes the cleaning cycle, the LCD returns to Standby mode (date and time).

### **WARNING**

If ink gets in your eyes, irrigate them with water immediately and consult a doctor if you are concerned.

### **Caution**

- DO NOT remove ink cartridges if you do not need to replace them. If you do so, it may reduce the ink quantity and the printer will not know the quantity of ink left in the cartridge.
- DO NOT shake the ink cartridges, because the ink may spill when you take off the sealing tape.
- If ink stains your body or clothing, wash with soap or detergent immediately.
- If you install an ink cartridge in the wrong color position, you must clean the print head several times before you start printing (after correcting the cartridge installation) because the colors were mixed.
- Once you open an ink cartridge, install it in the MFC and use it up within six months of installation. Use unopened ink cartridges by the expiration date written on the cartridge package.
- Brother strongly recommends that you do not refill the ink cartridges provided with your machine. We also strongly recommend that you continue to use only Genuine Brother Brand replacement ink cartridges. Using or attempting to use potentially incompatible inks and/or cartridges in your machine may cause damage to the machine itself and/or it may result in unsatisfactory print quality. Our warranty coverage does not apply to any problem that was caused by the use of unauthorized third party ink and/or cartridges. To protect your investment and guarantee your print quality please continue to replace consumed ink cartridges with only Genuine Brother Branded Supplies.



If the `INK EMPTY` message is on the display after you have installed ink cartridges, check that the ink cartridges are installed correctly.

If you still cannot solve a problem with your MFC, call Brother Customer Service (See *Brother numbers* on page -i).

# **S** Specifications

## **Product description**

The MFC-5200C is a **6in1** Multi-Function Center: Color Printer, Color Copier (multiple copies), Color Scanner, Plain Paper Color Fax, PhotoCapture Center™ and PC Fax (via your PC).

## **General**

<b>Memory Capacity</b>	8MB
<b>Automatic Document Feeder (ADF)</b>	up to 30 sheets (20 lb)
<b>Paper Tray</b>	100 Sheets (20 lb)
<b>Printer Type</b>	Ink Jet
<b>Print Method</b>	Piezo with 150 × 4 nozzles
<b>LCD (Liquid Crystal Display)</b>	16 characters × 2 Lines
<b>Operating Environment</b>	50-95 °F (10-35 °C)
<b>Best Print Quality</b>	68-91 °F (20-33 °C)
<b>Power Source</b>	120V AC 50/60Hz (USA, Canadian Version Only)
<b>Power Consumption</b>	Minimum: under 5 watts * Standby: under 17 watts ** Operating: under 50 watts
<b>Dimensions</b>	19.4 × 18.3 × 14.9 (inches) 492 × 466 × 378 (mm) (without Paper Support and Output Paper Support)
<b>Weight</b>	28.6 lb/13 kg (without Paper Support and Output Paper Support)

\* When Power Switch (ON/OFF) is turned off and Network LAN Board (NC-8100h) is not installed.

\*\* When Network LAN Board (NC-8100h) is not installed.

# Print media

## Paper Input

## Paper Tray

- Paper type:  
Plain paper, inkjet paper (coated paper), glossy paper, transparencies and envelopes
- Paper size:  
Letter, Legal, A5, B5, Executive, envelopes (commercial No. 10, DL, C5), Post card, Index card.  
Width 3.5-8.5" (89-216 mm)  
Height 4.0-14" (101-356 mm)  
Weight 17-32 lb (64-120 g/m<sup>2</sup>)  
For more details, see Paper Specifications for Paper Tray, page 2-2.
- Maximum paper tray capacity: Approx. 100 sheets of 20 lb (80 g/m<sup>2</sup>) plain paper.

## Manual Feed Slot

- Paper size:  
Width 3.5-8.5" (89-216 mm)  
Height 4.0-14" (101-356 mm)  
Paper Thickness 0.005-0.01 in.  
(0.12-0.25 mm)  
Post card: 0.009 to 0.018 in.  
(0.23 to 0.45 mm)

## Paper Output

Up to 50 sheets of plain paper (Face up print delivery to the output paper support)  
To prevent smearing the ink, we recommend removing printed pages from the output paper support immediately after they exit the machine.

# Copy

**Color/Mono**

Color/Mono

**Copy Speed**

Mono  
Up to 15 pages/minute (Letter paper)  
Color  
Up to 12 pages/minute (Letter paper)

**Multiple Copies**

Stacks or Sorts up to 99 pages

**Enlarge/Reduce**

25% to 400% (in increments of 1%)

**Resolution**

Max. 1200 dpi



# Fax

<b>Compatibility</b>	ITU-T Group 3
<b>Coding System</b>	MH/MR/MMR/JPEG
<b>Modem Speed</b>	33600-2400 bps Automatic Fallback
<b>Document Size</b>	ADF Width: 5.8" to 8.5" (148 mm to 216 mm) ADF Height: 5.8" to 14.0" (148 mm to 356 mm) Scanner Width: Max. 8.5" (216 mm) Scanner Height: Max. 11.7" (297 mm)
<b>Scanning Width</b>	8.2 inches (208 mm)
<b>Printing Width</b>	8.03 inches (204 mm)
<b>Gray Scale</b>	256 levels (Error Diffusion)
<b>Polling Types</b>	Standard, Sequential
<b>Contrast Control</b>	Automatic/Super Light/Super Dark (manual setting)
<b>Resolution</b>	<ul style="list-style-type: none"><li>• Horizontal 203 dot/inch (8 dot/mm)</li><li>• Vertical Standard - 98 line/inch (Black) (3.85 line/mm) 196 line/inch (Color) (7.7 line/mm) Fine -196 line/inch (Black/Color) (7.7 line/mm) Photo - 196 line/inch (Black) (7.7 line/mm) Superfine -392 line/inch (Black) (15.4 line/mm)</li></ul>
<b>Speed Dial</b>	100 stations
<b>Broadcasting</b>	Up to 150 locations; Up to 6 Groups
<b>Automatic Redial</b>	one time
<b>Auto Answer</b>	0, 1, 2, 3 or 4 rings
<b>Speaker Type</b>	Monitor
<b>Communication Source</b>	Public switched telephone network
<b>Memory Transmission</b>	Up to 480 pages *
<b>Out of Paper Reception</b>	Up to 480 pages *

\* "Pages" refers to the "Brother Standard Chart No. 1" (a typical business letter, Standard resolution, MMR code). Specifications and printed materials are subject to change without prior notice.

# Scanner

<b>Color/Mono</b>	Color/Mono
<b>TWAIN Compliant</b>	Yes
<b>Resolution</b>	Up to 9,600 × 9,600 dpi (interpolated) Up to 600 × 2,400 dpi (optical)
<b>Document Size</b>	ADF Width: 5.8" to 8.5" (148 mm to 216 mm) ADF Height: 5.8" to 14.0" (148 mm to 356 mm) Scanner Width: Max. 8.5" (216 mm) Scanner Height: Max. 11.7" (297 mm)
<b>Scanning Width</b>	8.2 inches (208 mm)
<b>Gray Scale</b>	256 levels

# Printer

<b>Printer Driver</b>	Windows® 95/98/98SE/Me/2000 Professional/XP and Windows NT® Workstation Version 4.0 driver supporting Brother Native Compression mode and bi-directional capability Apple® Macintosh® QuickDraw® Driver For OS 8.5-9.2/OS X 10.1
<b>Resolution</b>	2400 × 1200 dots per inch (DPI) 1200 × 1200 dots per inch (DPI) 600 × 600 dots per inch (DPI) 600 × 300 dots per inch (DPI) 450 × 150 dots per inch (DPI)
<b>Print Speed</b>	up to 20 pages/minute (Mono) up to 16 pages/minute (Color)
<b>Printing Width</b>	8.03 inches (204 mm)
<b>Disk-Based Fonts</b>	35

# Interface

<b>Parallel</b>	A bi-directional shielded parallel that is IEEE 1284 compliant and not longer than 6 feet (1.8m).
<b>USB</b>	A Standard Universal Serial Bus (1.1) cable that is not longer than 6 feet (1.8m).



To meet FCC emission requirements for the MFC, you must attach the included filter core and cable tie to the parallel interface cable.

# Photo Capture Center

<b>Available Media</b>	CompactFlash™ (Microdrive™ is not compatible) (Compact LAN card and Compact Modem card are not available.) SmartMedia™ (3.3V) (Not available for use with ID) Memory Stick™ (Not available for music data with MagicGate)
<b>File extension</b>	JPEG (Progressive JPEG format is not available)
<b>Number of files</b>	Up to 999 files in the media card
<b>Folder</b>	File must be in the 3rd stratum of the folder of Media Card

## Computer Requirements

Minimum System Requirements					
Computer Platform & Operating System Version		Processor Minimum Speed	Minimum RAM	Recommended RAM	Available Hard Disk Space
Windows® Operating System	95, 98, 98SE	Pentium 75MHz	24 MB	32 MB	110 MB
	Me	Pentium 150 MHz	32 MB	64 MB	
	NT® Workstation 4.0	Pentium 75MHz			
	2000 Professional	Pentium 133MHz	64 MB	128 MB	
	XP	Pentium 233MHz			240 MB
Apple® Macintosh® Operating System	OS 8.5 - 8.51 (Printing & PC-FAX Only)	All base models meet minimum Requirements	32 MB	64 MB	50 MB
	OS 8.6 - 9.2 (Printing, Scanning and PC-FAX Only)				
	OS X 10.1 (Printing and Remote Setup Only)		128 MB	160 MB	
	OS X 10.2.1 or greater (Printing, Scanning and Remote Setup Only)				
<b>NOTE:</b> USB is not supported under Windows® 95 or Windows NT® WS 4.0. All registered trademarks referenced herein are the property of their respective companies.					
For the latest drivers, access the Brother Solutions Center at <a href="http://solutions.brother.com">http://solutions.brother.com</a> .					

# Consumable Items

## Ink

Black and 3 individual color ink cartridges separate from the four print heads.

## Service Life of Ink Cartridge

Approximately 950 page/Black cartridge at 5% coverage with 450 × 150 dpi resolution (Fast).

Approximately 450 page/Color cartridge at 5% coverage with 450 × 150 dpi resolution (Fast).



These numbers are based on consecutive printing; the numbers will vary based on print frequency and number of pages.

The MFC periodically cleans the print head to maintain print quality. This process consumes a small amount of ink.

## Network (LAN) Board (Option)

When you add the optional Network (LAN) Board (NC-8100h), you can connect your MFC into the network to use the Internet FAX, Network Scanner, Network Printer and Network Management operations.

# **G** Glossary

**ADF (Automatic Document Feeder)** Refers to the number of pages that can be placed in the document feeder and fed one at a time automatically.

**Auto Dial List** A listing of names and numbers stored in Speed Dial memory, in numerical order.

**Automatic fax transmission** Sending a fax without picking up the handset of an external phone or pressing **Hook**.

**Automatic Redial** A feature that enables your MFC to redial the last fax number if the original fax did not go through because the line was busy.

**Auto Reduction** Reduces size of incoming faxes.

**Batch Transmission** As a cost savings feature, all delayed faxes to the same fax number will be sent as one transmission.

**Backup Print** Sets your MFC to print a copy of every fax that is received and stored in memory.

This is a safety feature so you will not lose message during a power failure.

**Beeper** The sound the keys make when they are pressed, an error occurs or a document has been received or transmitted.

**Beeper volume** Volume setting for the beep when you press a key or make an error.

**Brightness** Changing the Brightness makes the whole image lighter or darker.

**Broadcasting** The ability to send the same fax message to more than one location.

**Cancel Job** Cancels a programmed job, like Delayed Fax or Polling.

**CNG tones** The special tones (beeps) sent by fax machines during automatic transmission to tell the receiving machine that they are from a fax machine.

- Communication error (or Comm. Error)** An error during fax sending or receiving, usually caused by line noise or static.
- Coding Method** Method of coding the information contained in a document. All fax machines must use a minimum standard of Modified Huffman (MH). Your fax machine is capable of greater compression methods, Modified Read (MR), Modified Modified Read (MMR) and Joint Photographic Experts Group (JPEG), if the receiving machine has the same capability.
- Compatibility Group** The ability of one fax unit to communicate with another. Compatibility is assured between ITU-T Groups.
- Contrast** Setting to compensate for dark or light documents, by lightening dark documents or darkening light documents.
- Cover Page** Prints a page at the other party's machine, that contains the sender and recipient's name and fax number, number of pages and comment. You can generate an electronic cover page at the other end with pre-programmed information from memory or you can print a sample cover page to fax with your document.
- Cover Page Message** The comment that is on the Cover Page. This is a programmable feature.
- Delayed Fax** Sends your fax at a later time that day.
- Distinctive Ring** A service purchased from the Telephone Company that provides another phone number on an existing phone line. The Brother MFC uses the new number to simulate a dedicated fax line.
- Dual Access** Your MFC can scan outgoing faxes or scheduled jobs into memory at the same time it is sending a fax or receiving or printing an incoming fax.
- Easy Receive** Enables your MFC to respond to CNG tones if you interrupt a fax call by answering it.
- ECM (Error Correction Mode)** Detects errors during fax transmission and resends the page(s) of the document that had an error.
- Extension phone** A telephone on the fax number that is plugged into a separate wall jack.

**External phone** A TAD (telephone answering device) or telephone that is plugged into the EXT jack of your MFC.

**F/T Ring Time** The length of time that the Brother machine rings (when the receive mode setting is FAX/TEL) to notify you to pick up a voice call that it answered.

**Fax Activity Report** Lists information about the last 200 incoming and outgoing faxes. TX means Transmit. RX means Receive.

**Fax Forwarding** Sends a fax received in memory to another preprogrammed fax number.

**Fax Receive Code** Press this code (✕ 51) when you answer a fax call from an extension or external phone.

**Fax Storage** You can print stored faxes later, or retrieve them from another location using Fax Forwarding, Paging, or Remote Retrieval functions.

**FAX/TEL** You can receive faxes and telephone calls. Do not use this mode if you are using a telephone answering device (TAD).

**Fax tones** The signals sent by sending and receiving fax machines while communicating information.

**Fine resolution** Resolution is 196 × 203 dpi. It is used for small print and graphs.

**Gray scale** The shades of gray available for copying and faxing photographs.

**Group number** A combination of Speed Dial numbers that are stored on a Speed Dial for Broadcasting.

**Help list** A printout of the complete Menu that you can use to program your machine when you do not have the User's Guide with you.

**Ink button** Cleans the print head, replaces an ink cartridge and/or check the available ink volume.

**Interval** The preprogrammed time period between automatically printed Activity Reports. You can print Activity Reports on demand without interrupting this cycle.

**LCD (liquid crystal display)** The display screen on the MFC that shows interactive messages during On-Screen Programming and shows the date and time when the machine is idle.

**Manual fax** When you lift the handset of your external telephone so you can hear the receiving fax machine answer before you press Start to begin transmission.

**Menu mode** Programming mode for changing your machine's settings.

**Multi-Function Link Pro® Suite** Turns your MFC into a printer and a scanner and enables PC faxing using the MFC.

**Near Edge** Allows you to reduce unprintable areas.

**Next Fax Reservation** Dual Access accepts the next original in the ADF for transmission while the Memory is full.

**OCR (optical character recognition)** The bundled ScanSoft™ TextBridge® software application converts an image of text to text you can edit.

**Out of Paper Reception** Receives faxes into the MFC's memory when the machine is out of paper.

**Overseas Mode** Makes temporary changes to the fax tones to accommodate noise and static on overseas phone lines.

**Paging** Feature enables your fax unit to call your pager when a fax is received into its memory.

**Pause** Allows you to place a 3.5 second delay in the dialing sequence stored on Speed Dial numbers.

**PhotoCapture Center™** Allows you to print digital photos from your digital camera at high resolution for photo quality printing.

**Photo resolution** A resolution setting that uses varying shades of gray for the best representation of photographs.

**Polling** The process of a fax machine calling another fax machine to retrieve waiting fax messages.

**Printer alarm** Audible alarm when the printer is not able to print.

**Pulse** A form of rotary dialing on a telephone line.

**Real Time Transmission** When memory is full, you can send documents in real time.

**Remaining jobs** You can check which jobs are waiting in memory and cancel jobs individually.



**Remote Activation** Allows you to transfer a fax call, answered at an external or extension phone, to the MFC.

**Remote Retrieval Access** The ability to access your MFC remotely from a touch tone phone.

**Remote Retrieval Access Code** The four-digit code (159 \* ) that allows you to call and access your MFC from a remote location.

**Resolution** The number of vertical and horizontal lines per inch. See: Standard, Super Fine and Photo.

**Ring Delay** The number of rings before the MFC answers in FAX mode.

**Ring Volume** Volume setting for the MFC's ring.

**Scanning** The process of sending an electronic image of an original paper document into your computer.

**Scan to Card** You can scan a black and white or color original into a Media Card. Black and white images will be in TIFF file format and color images may be in PDF or JPEG file format.

**Search** An electronic, alphabetical listing of stored Speed Dial and Group numbers.

**Speaker Volume** You can set the volume when your machine is on Hook.

**Speed Dial** A preprogrammed number for easy dialing. You must press the **Search/Speed Dial** button and then #, two digit code to start the dialing process.

**Standard resolution** 97 × 203 dpi. It is used for regular size text and quickest transmission.

**Station ID** The stored information that appears on the top of faxed pages. It includes the sender's name and fax number.

**Super fine resolution** 392 × 203 dpi. Best for very small print and line art.

**TAD (telephone answering device)** You can connect an external TAD to the EXT. jack of the MFC for EXT. TEL/TAD mode.

**Telephone Answer Code (FAX/TEL mode only)** When the machine answers a voice call, it pseudo/double-rings. You can pick up at an extension phone by pressing this code (#51).

**Temporary Settings** You can select certain options for each fax transmission without changing the default settings.

**Tone** A form of dialing on the telephone line used for Touch Tone telephones.

**Transmission** The process of sending documents over the phone lines from your MFC to the receiving fax machine.

**Transmission Verification Report** A listing of each transmission, that shows its date, time and number.

**True2Life<sup>®</sup>** Adjusts the color in the image for better print quality by improving sharpness, white balance and color density.

**User Settings** A printed report that shows the current settings of your MFC.

# INDEX

## A

- access codes, storing and dialing ..... 7-5
- accessories and supplies .....ii
- ADF (Automatic Document Feeder) ..... 6-1
- ADF cover ..... 21-3
- automatic
  - dialing ..... 7-4
  - fax receive ..... 5-1
  - fax redial ..... 6-8
  - transmission ..... 6-7

## B

- Broadcasting ..... 7-6
  - setting up Groups for ..... 7-3
- Brother
  - accessories and supplies .....ii
  - Brother numbers ..... i
  - Customer Service ..... i
  - fax back system .....ii
  - Frequently Asked Questions (FAQs) ..... i
  - product support ..... i
  - test sheet, sending ..... 1-2
  - Warranties .....iii, iv, vi
- Brother Control Center
  - using and configuring ..... 14-1

## C

- canceling
  - fax forwarding ..... 8-5
  - fax jobs in memory .. 5-8, 6-10
  - jobs awaiting redial ..... 6-10
  - paging ..... 8-5
  - scheduled job ..... 5-8

- cleaning
  - print head .....21-10
  - printer platen .....21-17
  - scanner .....21-16
- CNG tones ..... 1-7
- connecting
  - external TAD .....1-8
  - external telephone ..... 1-8
- control panel, overview ..... 1-3
- copy
  - brightness .....10-11
  - color adjustment .....10-17
  - contrast ..... 10-11, 10-16
  - default settings .....10-15
  - enlarging .....10-7
  - keys .....10-4
  - multiple ..... 10-2, 10-3
  - paper .....10-9
  - quality ..... 10-6, 10-16
  - reducing .....10-7
  - scanner glass .....10-3
  - single ..... 10-2, 10-3
  - sorting .....10-12
  - temporary settings .....10-4
- Cover page
  - composing .....6-11
- cover page
  - custom comments .....6-12
  - for all faxes .....6-14
  - for next fax only .....6-13
  - printed form .....6-14
- Credit Card Numbers .....7-5
- custom telephone
  - features ..... 1-13, 21-8

## D

- Date and Time ..... 4-2
- Delayed Batch
  - Transmission ..... 6-16
- Delayed Fax ..... 6-15
- dialing
  - a pause ..... 7-7
  - access codes and credit card numbers ..... 7-5
  - automatic fax redial ..... 6-8
  - Fax Redial ..... 7-7
  - Groups ..... 7-6
  - Search ..... 7-4
  - Speed Dial numbers ..... 7-5
- Distinctive Ring ..... 5-9
- drivers
  - Macintosh ..... 19-1
  - printer ..... 13-1
  - TWAIN Compliant ..... 15-1
- Dual Access ..... 6-8

## E

- Easy Receive ..... 5-4
- ECM
  - (Error Correction Mode) .... 1-8
- entering text ..... 4-4
- envelopes ..... 2-2, 2-5
- error messages on LCD ... 21-1
  - BLCK 1. YES 2. NO .... 21-18
  - CHECK PAPER ..... 21-1
  - CLEANING ..... 21-19
  - COMM. ERROR ..... 21-1
  - DID YOU CHANGE .... 21-18
  - INK EMPTY ..... 21-2
  - MEMORY FULL ..... 21-2
  - NOT REGISTERED ..... 21-2
  - OUT OF MEMORY
    - while scanning a document ..... 6-8, 10-3
- extension telephone, using . 5-5
- external telephone ..... 1-8

## F

- fax codes
  - Fax Receive Code ..... 5-5
  - Remote Access Code ..... 8-4
  - Telephone Answer Code . 5-5
- Fax Forwarding ..... 8-1
  - changing remotely .... 8-5, 8-6
  - programming a number .... 8-1
- Fax Receive Code ..... 5-5, 5-6
- Fax Storage ..... 8-3
  - printing from ..... 5-6
  - turning on ..... 8-3
- fax, stand-alone
  - receiving ..... 5-1
    - difficulty ..... 21-7
    - erasing from the memory ..... 8-5
    - forwarding ..... 8-1, 8-5
    - polling ..... 1-12, 5-7
    - reducing to fit on paper . 5-4
    - retrieving from a remote site ..... 8-6
    - ring delay, setting ..... 5-2
  - sending
    - automatic transmission . 6-7
    - canceling from memory ..... 6-10
    - color fax ..... 6-7
    - contrast ..... 6-5
    - delayed ..... 6-15
    - from memory (dual access) ..... 6-8
    - manual transmission .... 6-7
    - overseas ..... 6-15
    - polling ..... 6-16
    - Real Time Transmission 6-9
    - resolution ..... 6-6

FAX/TEL mode .....	5-1
answering at extension	
phones .....	5-5
double-ringing	
(voice calls) .....	5-3
Easy Receive .....	5-4
FAX Receive Code .....	5-6
receiving faxes .....	5-5
Setting F/T Ring Time .....	5-3
Setting Ring Delay .....	5-2
Telephone Answer Code ..	5-5
FCC notices .....	20-1

## G

gray scale .....	S-3, S-4
Groups for Broadcasting .....	7-3

## H

HELP .....	3-1, 9-3
------------	----------

## I

ink cartridges	
checking ink volume .....	21-13
Ink Management .....	1-3
replacing .....	21-17

## J

jacks	
convert to RJ11 jack .....	1-11
EXT. jack	
external telephone .....	1-8
TAD (answering	
machine) .....	1-8
triplex adapter .....	1-11
jams	
original .....	21-3
paper .....	21-3

## L

LCD (Liquid Crystal	
Display) .....	1-3, 3-1

## M

Macintosh® G3, G4 or iMac™ or	
iBook™ .....	19-1
maintenance, routine .....	21-16
manual	
receive .....	5-1
transmission .....	6-7
Manual Feed	
Copy .....	10-14
Photo CaptureCenter™ ..	11-12
print .....	12-3
Memory Storage .....	4-7
Menu mode .....	3-1
multi-line connections	
(PBX) .....	1-13

## N

Near Edge	
Copy .....	10-10
Print .....	13-6

## O

Options key (copying) .....	10-8
Brightness .....	10-11
Contrast .....	10-11
Manual Feed .....	10-14
Near Edge .....	10-10
Page Layout .....	10-12
Paper Size .....	10-10
Paper Type .....	10-9
sorting .....	10-12

## P

Paging .....	8-1, 8-2
programming your	
pager number .....	8-1

Paper .....	2-1, S-2	print	
capacity .....	2-2	area .....	2-5
jam .....	21-3	difficulty .....	21-7
Size .....	4-2	fax from memory .....	5-6
size of original .....	6-1	Improving quality .....	21-10
Type .....	4-1	jams .....	21-4
PaperPort®		resolution .....	S-4
accessing .....	15-2	specifications .....	S-4
exporting .....	15-23	Pulse (dialing) .....	4-7
importing .....	15-22		
uninstall .....	15-23	<b>Q</b>	
PC FAX (For Windows®) ..	17-1	Quality key	
receiving .....	17-17	(copying) .....	10-4, 10-6
sending			
address book .....	17-5	<b>R</b>	
cover page .....	17-12	Receive mode	
facsimile style .....	17-13	EXTERNAL TAD .....	5-1
group .....	17-7	FAX ONLY .....	5-1
setting up .....	17-12	FAX/TEL .....	5-1
simple style .....	17-15	MANUAL .....	5-1
phone line		Redial/Pause .....	6-8
connections .....	1-10	reducing	
difficulties .....	21-7	copies .....	10-7
multi-line (PBX) .....	1-13	long faxes .....	5-4
roll-over lines .....	1-11	Remote Retrieval .....	8-4
two-line phone system ...	1-11	access code .....	8-4
PhotoCapture Center™		changing settings .....	8-4
Compact Flash™ .....	11-1	commands .....	8-5
DPOF printing .....	11-13	getting your faxes .....	8-6
Memory Stick™ .....	11-1	Reports .....	9-1
Printing images .....	11-5	Transmission Verification .	9-1
Printing Index .....	11-4	resolution	
SmartMedia™ .....	11-1	fax (standard, Fine,	
Polling		superFine, Photo) .....	S-3
receiving .....	5-7	print .....	S-4
sending .....	6-16	Scan .....	15-6
sequential receiving .....	5-7	setting for next fax .....	6-6
power		Ring Delay, setting .....	5-2
failure .....	4-7		

## S

Safety Instructions	vii, 20-4
Scanning into PC	15-3
ScanSoft™	
PaperPort®	15-19
Scansoft™ TextBridge®	
OCR	15-22
Search, for stored numbers	7-4
Setup	
Date and Time	4-2
Station ID (fax header)	4-3
shipping the machine	21-13
software	
Brother Control Center	14-1
ScanSoft™	
Paper Port®	15-19
Speed Dial	1-3
changing	7-2
dialing	7-5
storing	7-1

## T

TAD (Telephone Answering Device), external	1-8, 1-12, 5-1
connecting	1-8
receive mode	5-1
Temporary Copy Settings	10-4
text, entering	4-4
Special Characters	4-4
Tone (dialing)	4-7
Tone Signals on Pulse Line	7-7
troubleshooting	21-1
error messages on LCD	21-1
if you are having	
difficulty	21-7
incoming Calls	21-8
phone line difficulty	21-7
printer difficulties	21-8
printing or receiving	
faxes	21-7

sending faxes	21-7
True2Life®	
PhotoCapture	
Center™	11-16
Print	13-11
two-line phone system	1-11

## V

Volume, setting	4-5
beeper	4-6
ring	4-5
speaker	4-6

## W

Warranties	iii
Canada	vi
Notice-Disclaimer	iii
USA	iv
World Wide Web	i

# Remote Retrieval Access Card

If you plan to receive fax messages while away from your machine, carrying the Remote Retrieval Access Card printed below will serve as a convenient reminder of the retrieval procedures. Simply cut out the card and fold it to fit your wallet or organizer. Keeping it handy will help you derive the full benefit of your machine's forwarding, paging and remote retrieval features.

REMOTE RETRIEVAL ACCESS CARD	
<b>CHECK RECEIVING STATUS</b> Press <b>971</b> 1 long beep — Fax message(s) 3 short beeps — No messages	<b>Using Remote Retrieval Access Code</b> <b>1</b> Dial your fax number from a fax machine using touch tone. <b>2</b> When your MFC answers, immediately enter your Remote Retrieval Access Code (159*). <b>3</b> Your MFC signals the kinds of messages received: 1 long beep — Fax message(s) No beeps — No messages. <b>4</b> After 2 short beeps, enter a command. <b>5</b> Press <b>90</b> to reset your MFC when you finish. <b>6</b> Hang up.
<b>CHANGE ANSWER MODE</b> Press <b>98</b> then for EXTERNAL TAD, press <b>1</b> . FAX/TEL, press <b>2</b> . FAX/ONLY, press <b>3</b> .	
<b>EXIT REMOTE OPERATION</b> Press <b>90</b> .	



<p><b>Changing Remote Retrieval Access Code</b></p> <ol style="list-style-type: none"> <li>1 Press <b>Menu/Set</b>, <b>2</b>, <b>5</b>, <b>3</b>.</li> <li>2 Enter a three-digit number from 000 to 999. The * cannot be changed.</li> <li>3 Press <b>Menu/Set</b>.</li> <li>4 Press <b>Stop/Exit</b>.</li> </ol> <p><b>Remote Commands</b></p> <hr/> <p><b>CHANGE PAGING/FAX FORWARDING SETTING</b> Press <b>95</b> then to Turn feature off, press <b>1</b>. Select Fax Forwarding, press <b>2</b>. Select Paging, press <b>3</b>.</p>	<p><b>Program Fax Forwarding Number</b>, press <b>4</b>. Enter the new fax number where you want your fax messages forwarded followed by <b>##</b>.</p> <p><b>Turn Fax Storage on</b>, press <b>6</b> <b>Turn Fax Storage off</b>, press <b>7</b>.</p> <p><b>RETRIEVE A FAX</b> Press <b>96</b> then to <b>Retrieve all faxes</b>, press <b>2</b>, then enter the number of remote fax machine, followed by <b>##</b>. After the beep, hang up and wait. <b>Erase all fax messages</b>, press <b>3</b>.</p>
--	---

Fold →

## **EQUIPMENT ATTACHMENT LIMITATIONS (Canada only)**

### **NOTICE**

This equipment meets the applicable Industry Canada Terminal Equipment Technical Specifications. This is confirmed by the registration number. The abbreviation, IC, before the registration number signifies that registration was performed based on a Declaration of Conformity indicating that Industry Canada technical specifications were met. It does not imply that Industry Canada approved the equipment.

### **NOTICE**

The Ringer Equivalence Number (REN) for this terminal equipment is 0.4. The REN assigned to each terminal equipment provides an indication of the maximum number of terminals allowed to be connected to a telephone interface. The termination on an interface may consist of any combination of devices subject only to the requirement that the sum of the Ringer Equivalence Numbers of all the devices does not exceed five.

# brother®

Brother International Corporation  
100 Somerset Corporate Boulevard  
P.O. Box 6911  
Bridgewater, NJ 08807-0911 USA

Brother International Corporation (Canada) Ltd.  
1 rue Hôtel de Ville,  
Dollard-des-Ormeaux, QC, CANADA H9B 3H6

**Visit us on the World Wide Web**  
**<http://www.brother.com>**

These machines are made for use in the USA and CANADA only. We cannot recommend using them overseas because it may violate the Telecommunications Regulations of that country and the power requirements of your multi-function center may not be compatible with the power available in foreign countries. **Using USA or CANADA models overseas is at your own risk and may void your warranty.**

## Free Manuals Download Website

<http://myh66.com>

<http://usermanuals.us>

<http://www.somanuals.com>

<http://www.4manuals.cc>

<http://www.manual-lib.com>

<http://www.404manual.com>

<http://www.luxmanual.com>

<http://aubethermostatmanual.com>

Golf course search by state

<http://golfingnear.com>

Email search by domain

<http://emailbydomain.com>

Auto manuals search

<http://auto.somanuals.com>

TV manuals search

<http://tv.somanuals.com>