









Thank you for choosing Brother, your support is important to us and we value your business. Your Brother product is engineered and manufactured to the highest standards to deliver reliable performance, day-in and day-out.

Please read the Product Safety Guide first before you set up your machine. Then, please read this Quick Setup Guide for the correct setup and installation.

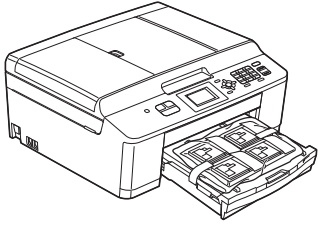
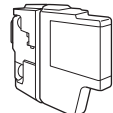
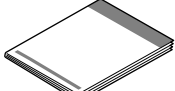
 WARNING	<u>WARNING</u> indicates a potentially hazardous situation which, if not avoided, could result in death or serious injuries.
 CAUTION	<u>CAUTION</u> indicates a potentially hazardous situation which, if not avoided, may result in minor or moderate injuries.

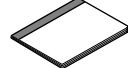
1 Unpack the machine and check the components

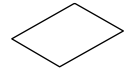
- Most of the illustrations in this Quick Setup Guide show the MFC-J430W.
- The components included in the box may differ depending on your country.

		 Black Yellow Cyan Magenta Starter Ink Cartridges	 Quick Setup Guide
			 CD-ROM
 Basic User's Guide	 Product Safety Guide	 Product Registration Sheet (USA only)	 Telephone Line Cord

WARNING

Plastic bags are used in the packing of your machine. Plastic bags are not toys. To avoid the danger of suffocation, keep these bags away from babies and children and dispose of them correctly.

Note

- Save all packing materials and the box in case for any reason you must ship your machine.
- You need to purchase the correct USB cable.

USB cable

It is recommended to use a USB 2.0 cable (Type A/B) that is no more than 6 feet (2 meters) long (cable not included).

a Remove the protective tape and film covering the machine, and also from the LCD.

b Remove the plastic bag **1** containing the ink cartridges from on top of the paper tray.

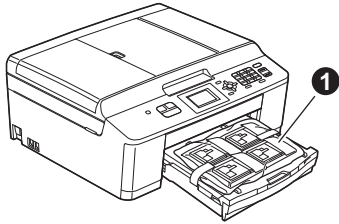

c Make sure you have all the components.

2 Load plain Letter/A4 paper

a Pull the paper tray **1** completely out of the machine.

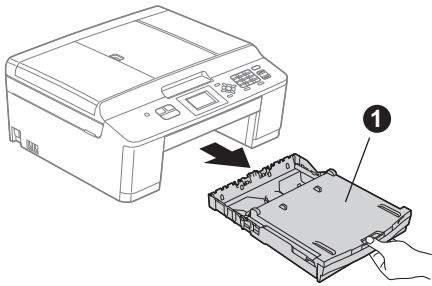

b Open the output paper tray cover **1**.

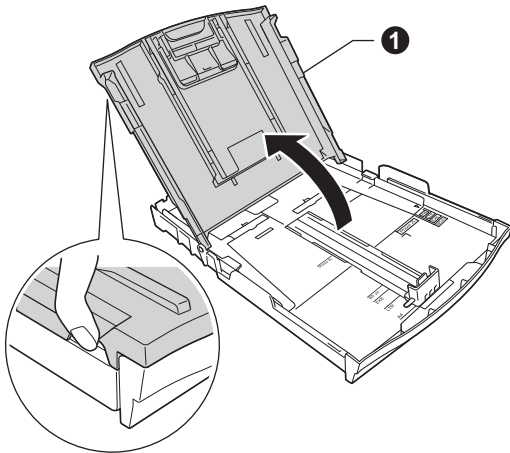

c With both hands, gently press and slide the paper side guides **1** and then the paper length guide **2** to fit the paper size.

Make sure that the triangular marks **3** on the paper side guides **1** and paper length guide **2** line up with the mark for the paper size you are using.

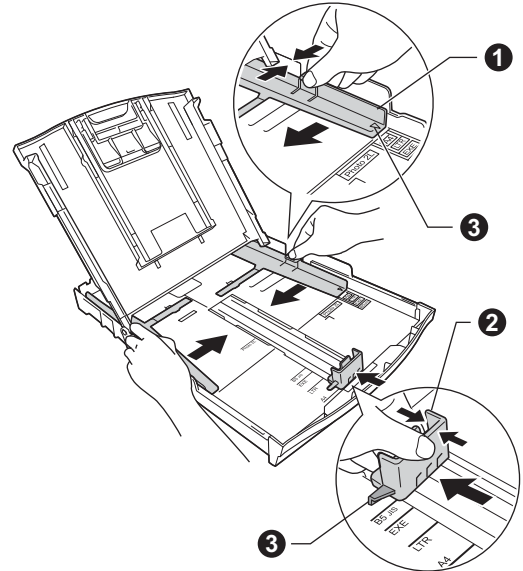

d Fan the stack of paper well to avoid paper jams and misfeeds.



Note

Always make sure that the paper is not curled or wrinkled.

- e Gently put the paper into the paper tray print side down and top edge first. Check that the paper is flat in the tray.

! IMPORTANT

Be careful that you do not push the paper in too far; it may lift at the back of the tray and cause paper feed problems.

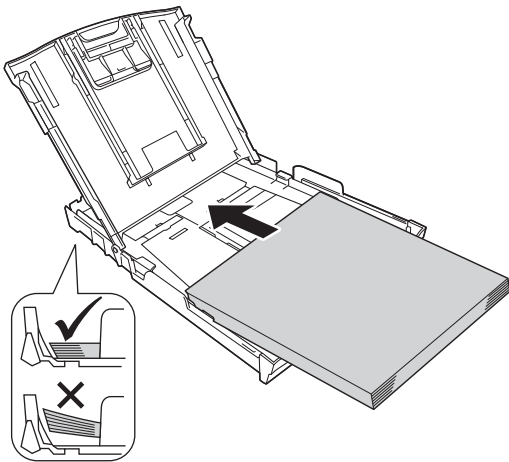

Note

When you use Legal size paper, press and hold the universal guide release button ① as you slide out the front of the paper tray.

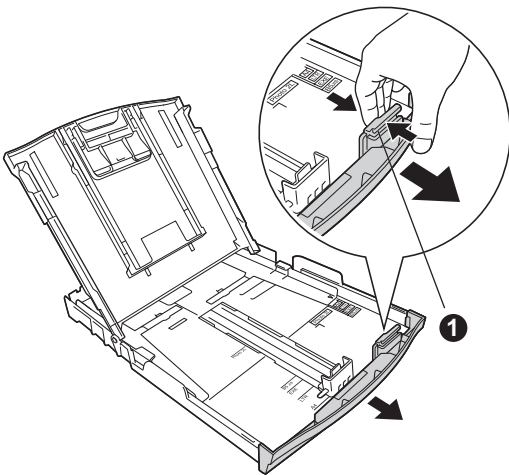

- f Gently adjust the paper side guides to the paper with both hands. Make sure that the paper side guides touch the edges of the paper.

- g Close the output paper tray cover.

- h Slowly push the paper tray completely into the machine.

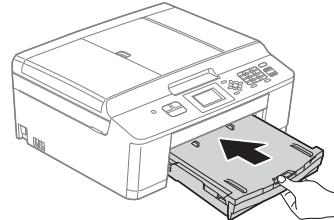

- i While holding the paper tray in place, pull out the paper support ① until it clicks, and then unfold the paper support flap ②.

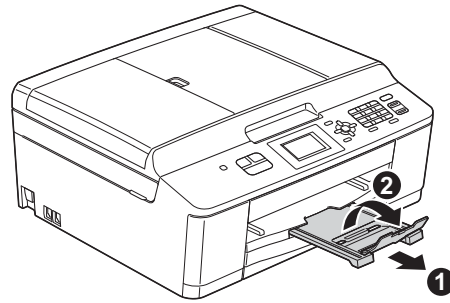

3

Connect the power cord and telephone line

! IMPORTANT

DO NOT connect the USB cable yet (if you are using a USB cable).

a Connect the power cord.

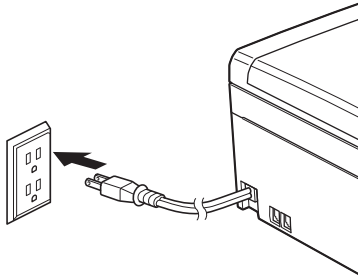

b Connect the telephone line cord. Connect one end of the telephone line cord to the jack on the machine marked **LINE** and the other end to a modular wall jack.

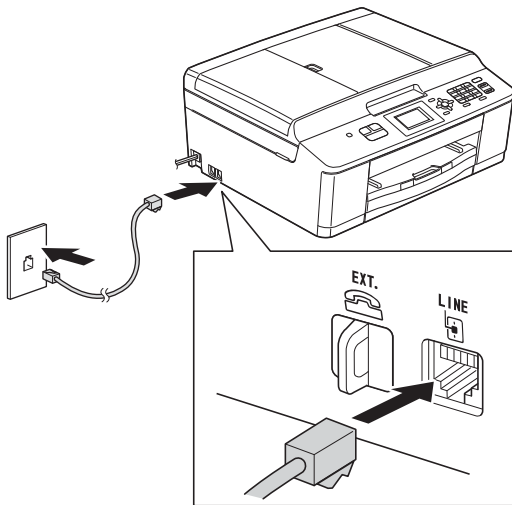

! IMPORTANT

The telephone line cord **MUST** be connected to the jack on the machine marked **LINE**.

Note

If you are sharing one telephone line with an external telephone, connect it as shown below. Before you connect the external telephone, remove the protective cap ❶ from the **EXT.** jack on the machine.

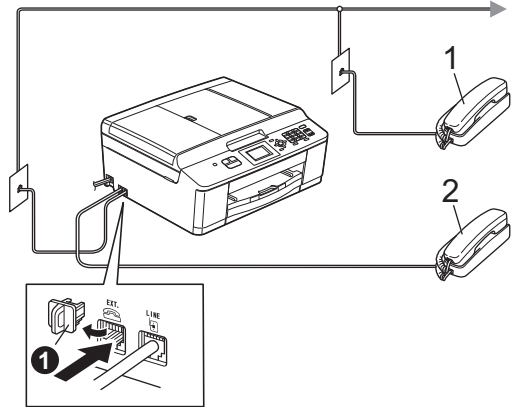

- 1 Extension telephone
- 2 External telephone

Note

If you are sharing one telephone line with an external telephone answering machine, connect it as shown below. Before you connect the external telephone answering machine, remove the protective cap ❶ from the **EXT.** jack on the machine.

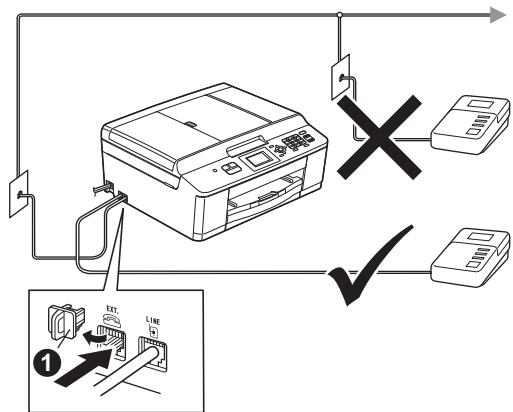

Set the receive mode to *External TAD* if you have an external answering machine. See Choose the correct Receive Mode on page 8. For additional details, see Connecting an external TAD (telephone answering device) in chapter 6 of the Basic User's Guide.

4 Install the ink cartridges

⚠ CAUTION

If ink gets in your eyes, wash it out with water at once and call a doctor if you are concerned.

📝 Note

Make sure you install the Starter Ink Cartridges included with your machine first.

- a Make sure that the power is turned on. The LCD will show No Ink Cartridge.
- b Open the ink cartridge cover ①.

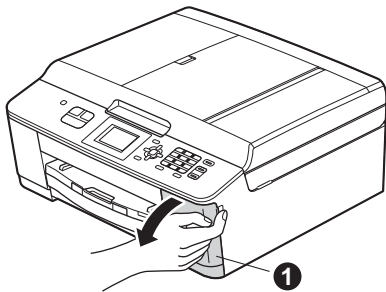

- c Remove the orange protective part ①.

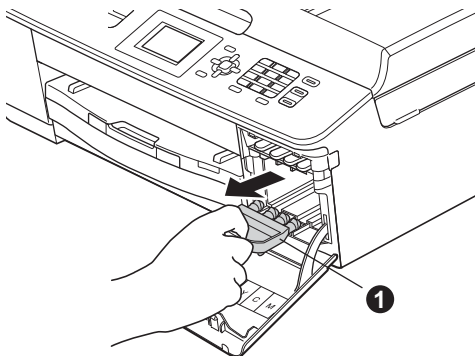

📝 Note

Do not throw away the orange protective part. You will need it if you transport the machine.

- d Unpack the ink cartridge. Turn the green release lever on the orange protective packing ① clockwise until it clicks to release the vacuum seal. Then remove the orange protective packing ① as shown.

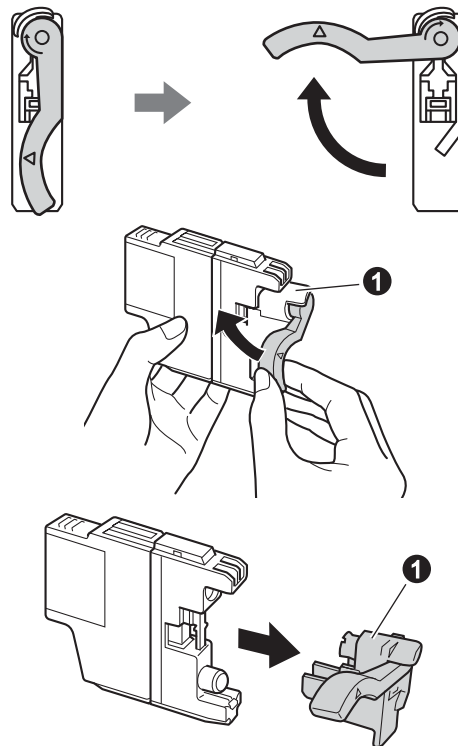

⚠ IMPORTANT

DO NOT shake the ink cartridges. If ink stains your skin or clothing, wash with soap or detergent at once.

- e Take care to match the color of the lever ① with the cartridge color ②, as shown in the diagram below. Install each ink cartridge in the direction of the arrow on the label.

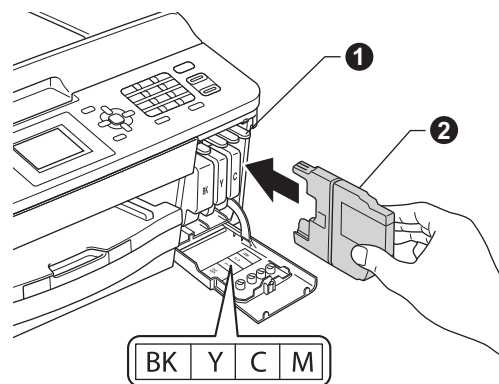

f

Gently push the back of the ink cartridge marked "PUSH" until it clicks. After all the ink cartridges are installed close the ink cartridge cover.

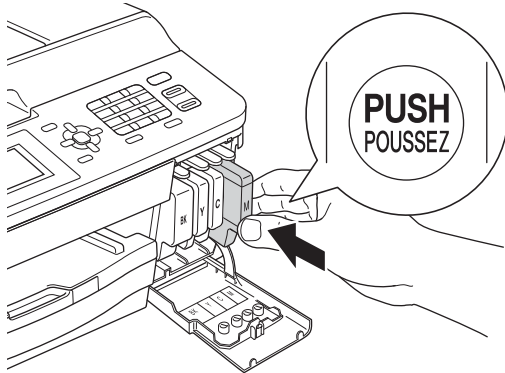
**Note**

The machine will prepare the ink tube system for printing. This process will take approximately four minutes. Do not turn off the machine.

! IMPORTANT

- **DO NOT** take out ink cartridges if you do not need to replace them. If you do so, it may reduce the ink quantity and the machine will not know the quantity of ink left in the cartridge.
- **DO NOT** repeatedly insert and remove the cartridges. If you do so, ink may seep out of the cartridge.
- If you mix the colors by installing an ink cartridge in the wrong position, clean the print head several times after correcting the cartridge installation. (See *Cleaning the print head* in Appendix A of the *Basic User's Guide*.)
- Once you open an ink cartridge, install it in the machine and use it up within six months of installation. Use unopened ink cartridges by the expiration date written on the cartridge package.
- **DO NOT** dismantle or tamper with the ink cartridge, this can cause the ink to leak out of the cartridge.
- Brother strongly recommends that you do not refill the ink cartridges provided with your machine. We also strongly recommend that you continue to use only Genuine Brother Brand replacement ink cartridges. Use or attempted use of potentially incompatible ink and/or cartridges in the Brother machine may cause damage to the machine and/or may result in unsatisfactory print quality. Our warranty coverage does not apply to any problem that is caused by the use of unauthorized third party ink and/or cartridges. To protect your investment and obtain premium performance from the Brother machine, we strongly recommend the use of Genuine Brother Supplies.

5 Check the print quality

- a** When the preparation process has finished, the LCD shows `Set Paper` and `Press Start`. Press **Color Start**.
- b** Check the quality of the four color blocks on the sheet. (black/yellow/cyan/magenta)
- c** If all lines are clear and visible, press **1** (`Yes`) to finish the quality check and go to step **6**.

OK

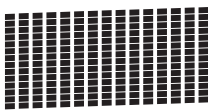

If you can see missing short lines, press **2** (`No`) and follow the steps on the LCD.

Poor



6 Choose your language (if needed)

- a** Press **Menu**.
- b** Press **▲** or **▼** to choose `Initial Setup`. Press **OK**.
- c** Press **▲** or **▼** to choose `Local Language`. Press **OK**.
- d** Press **▲** or **▼** to choose your language. Press **OK**.
- e** Press **Stop/Exit**.

7

Choose the correct Receive Mode

The correct Receive Mode is determined by the external devices and telephone subscriber services (Voice Mail, Distinctive Ring, etc.) you have (or will be using) on the same line as the Brother machine.

For details, see *Using Receive Modes* in chapter 5 of the *Basic User's Guide*.

Will you be using a Distinctive Ring number for receiving faxes?

Brother uses the term “Distinctive Ring” but telephone companies may have other names for this service such as Custom Ringing, RingMaster, Personalized Ring, Teen Ring, Ident-A-Call, and Smart Ring. See *Distinctive Ring* in chapter 6 of the *Basic User's Guide* for instruction on setting up your machine using this feature.

Will you be using Voicemail on the same telephone line as your Brother machine?

If you have Voice Mail on the same telephone line as your Brother machine, there is a strong possibility that Voice Mail and the Brother machine will conflict with each other when receiving incoming calls. See *Voice Mail* in chapter 6 of the *Basic User's Guide* for instructions on setting up your machine using this service.

Will you be using a Telephone Answering Device on the same telephone line as your Brother machine?

Your external telephone answering device (TAD) will automatically answer every call. Voice messages are stored on the external TAD and fax messages are printed. Choose `External TAD` as your receive mode. See the instructions below. For additional details, see *Connecting an external TAD (telephone answering device)* in chapter 6 of the *Basic User's Guide*.

Will you be using your Brother machine on a dedicated fax line?

Your machine automatically answers every call as a fax. Choose `Fax Only` as your receive mode. See the instructions below.

Will you be using your Brother machine on the same line as your telephone?

Do you want to receive voice calls and faxes automatically?

The `Fax/Tel` receive mode is used when sharing the Brother machine and your telephone on the same line. Choose `Fax/Tel` as your receive mode. See the instructions below. For additional information see *Fax/Tel* in chapter 5 of the *Basic User's Guide* for instructions on setting up and using this receive mode.

Important Note: You cannot receive voice messages on either Voice Mail or an answering machine when choosing the `Fax/Tel` mode.

Do you expect to receive very few faxes?

Choose `Manual` as your receive mode. You control the phone line and must answer every call yourself. See the instructions below.

- a** Press `Menu`.
- b** Press `▲` or `▼` to choose `Initial Setup`. Press `OK`.
- c** Press `▲` or `▼` to choose `Receive Mode`. Press `OK`.
- d** Press `▲` or `▼` to choose `Fax Only`, `Fax/Tel`, `External TAD` or `Manual`. Press `OK`.
- e** Press `Stop/Exit`.

Note

If the `Receive Mode` option is not displayed, make sure the *Distinctive Ring* feature is set to `Off`. (See *Turning off Distinctive Ring* in chapter 6 of the *Basic User's Guide*.)

8

Set the LCD contrast (if needed)

If you are having difficulty reading the LCD, try changing the contrast setting.

- a** Press **Menu**.
- b** Press **▲** or **▼** to choose **General Setup**. Press **OK**.
- c** Press **▲** or **▼** to choose **LCD Settings**. Press **OK**.
- d** Press **▲** or **▼** to choose **LCD Contrast**. Press **OK**.
- e** Press **◀** or **▶** to choose the contrast level. Press **OK**.
- f** Press **Stop/Exit**.

9

Set the date and time

The machine displays the date and time, and if you set up the station ID, it will add it to each fax you send.

- a** Press **Menu**.
- b** Press **▲** or **▼** to choose **Initial Setup**. Press **OK**.
- c** Press **▲** or **▼** to choose **Date&Time**. Press **OK**.
- d** Enter the last two digits of the year on the dial pad, and then press **OK**.



(e.g. Enter **1 2** for 2012.)

- e** Enter the two digits for the month on the dial pad, and then press **OK**.
- f** Enter the two digits for the day on the dial pad, and then press **OK**.
- g** Press **▲** or **▼** to choose **12h Clock** or **24h Clock**, and then press **OK**.

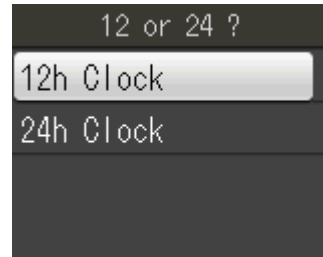

- h** Enter the time on the dial pad, and then press **OK**.
- i** (12h Clock only)
Press **▲** or **▼** to choose **AM** or **PM**, and then press **OK**.

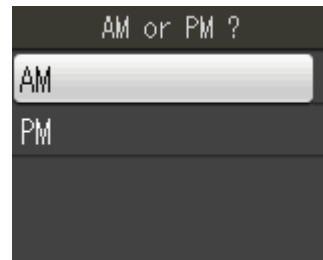

- j** Press **Stop/Exit**.

10 Set your Station ID

You should store your name and fax number to be printed on all fax pages that you send. For details, see *Entering Text* in Appendix C of the *Basic User's Guide*.

- a** Press **Menu**.
- b** Press **▲** or **▼** to choose **Initial Setup**. Press **OK**.
- c** Press **▲** or **▼** to choose **Station ID**. Press **OK**.
- d** Enter your fax number (up to 20 digits) on the dial pad, and then press **OK**.
- e** Enter your name (up to 20 characters) using the dial pad, and then press **OK**.

Note

- See the following chart for entering your name.
- If you need to enter a character that is on the same key as the character before, press **▶** to move the cursor to the right.
- If you entered a character incorrectly and want to change it, press **◀** or **▶** to move the cursor to the incorrect character, and then press **Clear**.

Press key	One time	Two times	Three times	Four times	Five times
2	A	B	C	2	A
3	D	E	F	3	D
4	G	H	I	4	G
5	J	K	L	5	J
6	M	N	O	6	M
7	P	Q	R	S	7
8	T	U	V	8	T
9	W	X	Y	Z	9

- f** Press **Stop/Exit**.

Note

If you make a mistake and want to start again, press **Stop/Exit** and go back to **a**.

Note

(USA only)

The Telephone Consumer Protection Act of 1991 makes it unlawful for any person to use a computer or electronic device to send any message via a telephone fax machine unless such messages clearly contain, in a margin at the top or bottom of each transmitted page, or on the first page of the transmission, the date and time it is sent and an identification of the business or other entity or other individual sending the message and the telephone number of the sending machines or such business, other entity or individual.

11 Fax Transmission Report

Your Brother machine is equipped with a Transmission Verification Report that can be used as confirmation that you sent a fax. This report lists the name or fax number of the receiving party, the date, time, and duration of the transmission, the number of pages transmitted, and whether or not the transmission was successful. If you want to use the Fax Transmission Report feature, see *Transmission Verification Report* in chapter 4 of the *Basic User's Guide*.

12 Set Tone or Pulse dialing mode (Canada only)

Your machine comes set for Tone dialing service. If you have Pulse dialing service (rotary), you need to change the dialing mode.

- a** Press **Menu**.
- b** Press **▲** or **▼** to choose `Initial Setup`. Press **OK**.
- c** Press **▲** or **▼** to choose `Tone/Pulse`. Press **OK**.
- d** Press **▲** or **▼** to choose `Pulse (or Tone)`. Press **OK**.
- e** Press **Stop/Exit**.

13 Set the telephone line compatibility (VoIP)

If you are connecting the machine to a VoIP service (over the Internet) you need to change the compatibility setting.



Note

If you are using an analog telephone line you can skip this step.

- a** Press **Menu**.
- b** Press **▲** or **▼** to choose `Initial Setup`. Press **OK**.
- c** Press **▲** or **▼** to choose `Compatibility`. Press **OK**.
- d** Press **▲** or **▼** to choose `Basic (for VoIP)`. Press **OK**.
- e** Press **Stop/Exit**.

14 Automatic Daylight Savings Time

You can set the machine to change automatically for daylight savings time. It will reset itself forward one hour in the spring and backward one hour in the fall.

- a** Press **Menu**.
- b** Press **▲** or **▼** to choose `General Setup`. Press **OK**.
- c** Press **▲** or **▼** to choose `Auto Daylight`. Press **OK**.
- d** Press **▲** or **▼** to choose `On (or Off)`. Press **OK**.
- e** Press **Stop/Exit**.

15 Send in the Product Registration Sheet (USA only)

You can also register your product online using the On-Line Registration link from the CD-ROM or visit <http://www.brother.com/registration/>.

a Fill out the Product Registration Sheet.

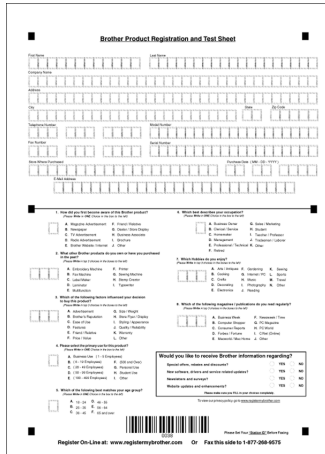

The form is titled "Brother Product Registration and Test Sheet". It contains several sections for user information and product details, each with checkboxes for selection. At the bottom, there is a barcode and contact information for online registration and a toll-free fax number.

b Put the sheet face down in the ADF (Automatic Document Feeder) or face down on the scanner glass.

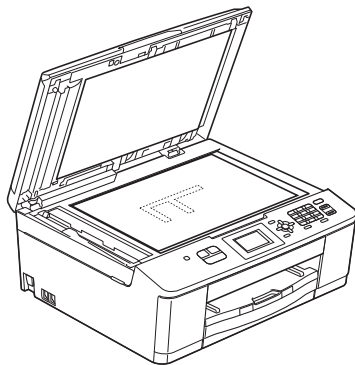
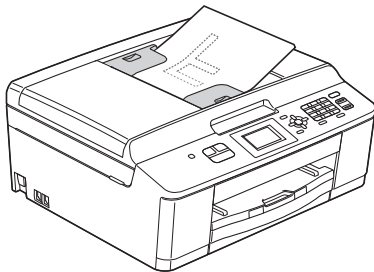

- c** Make sure  (FAX) is illuminated in Blue.
- d** Enter the toll-free fax number: 1-877-268-9575.
- e** Press **Black Start**.

Note

You will receive a confirmation fax of your Product Registration.

16

Choose your connection type

These installation instructions are for Windows® XP/XP Professional x64 Edition, Windows Vista®, Windows® 7, and Mac OS X (versions 10.4.11, 10.5.x and 10.6.x).

Note

- For Windows Server® 2003/2008/2008 R2, the drivers can be found from your model's download page at <http://solutions.brother.com/>.
- If your computer does not have a CD-ROM drive you can download the latest drivers, manuals and utilities for your model from the Brother Solutions Center at <http://solutions.brother.com/>. Some software applications included on the CD-ROM may not be available as a download.

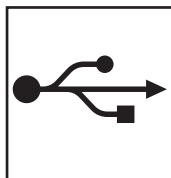
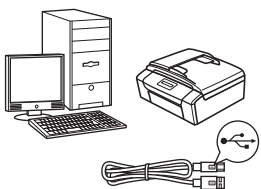

For USB interface cable

Windows®, go to page 14
Macintosh, go to page 17

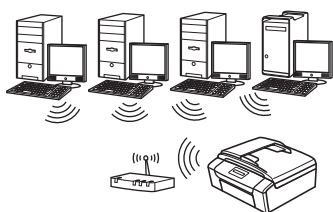

For Wireless Network

Windows® and Macintosh,
go to page 19



For USB interface users

(Windows® XP Home/XP Professional/Windows Vista®/Windows® 7)

17 Before you install

Make sure that your computer is ON and you are logged on with Administrator rights.

! IMPORTANT

- **DO NOT** connect the USB cable yet.
- If there are any programs running, close them.

Note

- The screens may differ depending on your operating system.
- The CD-ROM includes ScanSoft™ PaperPort™ 12SE. This software supports Windows® XP Home (SP3 or greater), XP Professional (SP3 or greater), XP Professional x64 Edition (SP2 or greater), Windows Vista® (SP2 or greater) and Windows® 7. Update to the latest Windows® Service Pack before installing MFL-Pro Suite.

18 Install MFL-Pro Suite

a Put the supplied installer CD-ROM into your CD-ROM drive. If the model name screen appears, choose your machine. If the language screen appears, choose your language.

Note

If the Brother screen does not appear automatically, go to **My Computer (Computer)**, double-click the CD-ROM icon, and then double-click **start.exe**.

b The CD-ROM Top Menu will appear. Click **Install MFL-Pro Suite** and click **Yes** if you accept the license agreements. Follow the on-screen instructions.

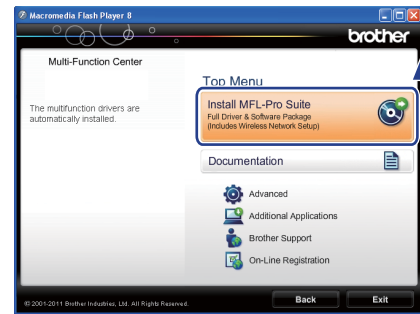

Note

For Windows Vista® and Windows® 7, when the User Account Control screen appears, click **Allow** or **Yes**.

c Choose **Local Connection (USB)**, and then click **Next**. The installation continues.

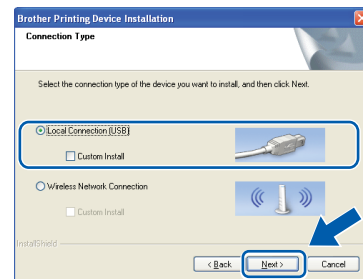

d When this screen appears, go to the next step.

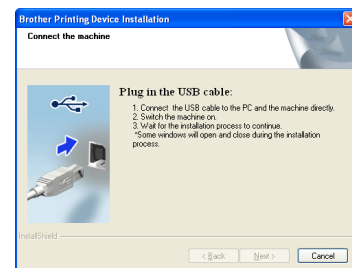



19 Connect the USB cable

a Using both hands, use the plastic tabs on both sides of the machine to lift the scanner cover until it locks securely into the open position.

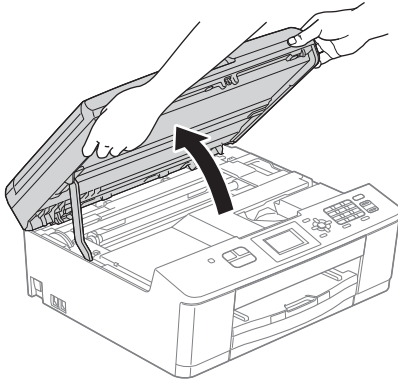

b Connect the USB cable to the USB port marked with a  symbol. You will find the USB port inside the machine as shown below.

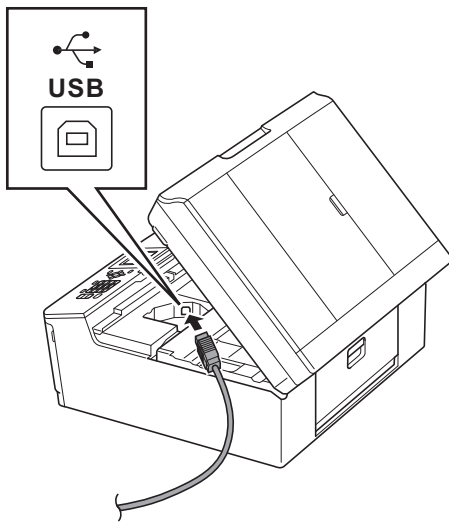

c Carefully guide the USB cable into the cable channel and out the back of the machine. Connect the cable to your computer.

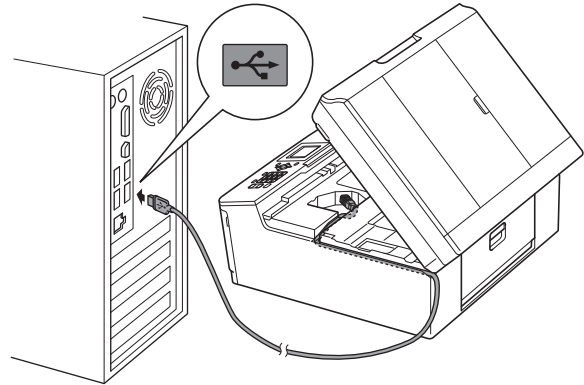

! IMPORTANT

Make sure that the cable does not restrict the cover from closing, or an error may occur.

d Using both hands, grasp the plastic tabs on both sides of the machine and gently close the scanner cover.

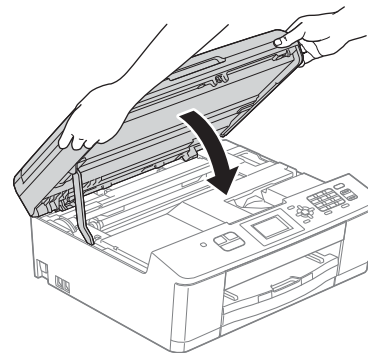

e The installation will continue automatically. The installation screens appear one after another.

! IMPORTANT

DO NOT cancel any of the screens during the installation. It may take a few seconds for all screens to appear.

Note

*For Windows Vista® and Windows® 7, when the Windows® Security screen appears, click the check box and click **Install** to complete the installation correctly.*



f When the **On-Line Registration** screen is displayed, make your selection and follow the on-screen instructions.

g If you do not want to set your machine as the Default printer, uncheck **Set as Default Printer** and then click **Next**.

20 Finish and restart

a Click **Finish** to restart your computer. After restarting the computer, you must be logged on with Administrator rights.

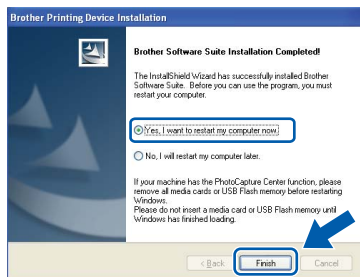

Note

- If an error message appears during the software installation, run the **Installation Diagnostics** located in **Start/All Programs/Brother/MFC-JXXX** (where MFC-JXXX is your model name).
- Depending on your security settings, a Windows® Security or antivirus software window may appear when using the machine or its software. Please allow or permit the window to continue.

b The following screens will appear.

- When the **Check for Firmware Updates** screen appears, choose the firmware update setting you want and click **OK**.
- When the **Brother Product Research & Support Program** starts up, follow the on-screen instructions.

Note

Internet access is required for the firmware update and the **Brother Product Research & Support Program**.

Finish The installation is now complete.

Now go to

Proceed to Install Optional Applications on page 34.

Note

XML Paper Specification Printer Driver
The XML Paper Specification Printer Driver is the most suitable driver for Windows Vista® and Windows® 7 when printing from applications that use the XML Paper Specification documents. Please download the latest driver by accessing the Brother Solutions Center at <http://solutions.brother.com/>.



For USB interface users (Mac OS X 10.4.11, 10.5.x, 10.6.x)

17 Before you install

Make sure your machine is connected to the power and your Macintosh is ON. You must be logged on with Administrator rights.

Note

For Mac OS X 10.4.0 to 10.4.10 users, upgrade to Mac OS X 10.4.11 - 10.6.x.

18 Connect the USB cable

! IMPORTANT

- **DO NOT** connect the machine to a USB port on a keyboard or a non-powered USB hub.
- **Connect the machine directly to your Macintosh.**

a Using both hands, use the plastic tabs on both sides of the machine to lift the scanner cover until it locks securely into the open position.

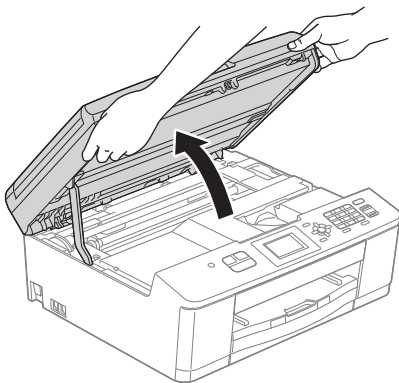

b Connect the USB cable to the USB port marked with a  symbol. You will find the USB port inside the machine as shown below.

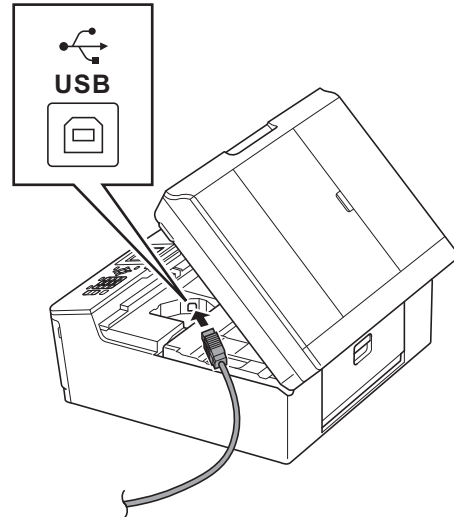

c Carefully guide the USB cable into the cable channel and out the back of the machine. Connect the cable to your Macintosh.

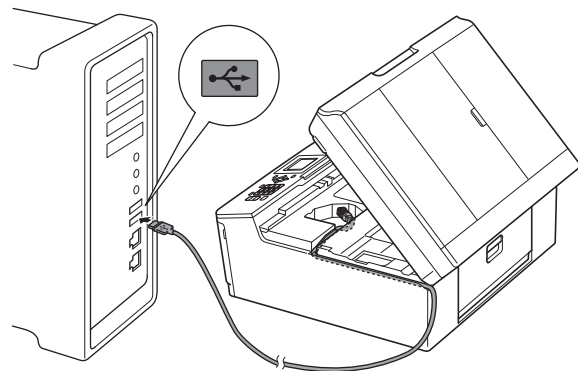

! IMPORTANT

Make sure that the cable does not restrict the cover from closing, or an error may occur.



- d** Using both hands, grasp the plastic tabs on both sides of the machine and gently close the scanner cover.

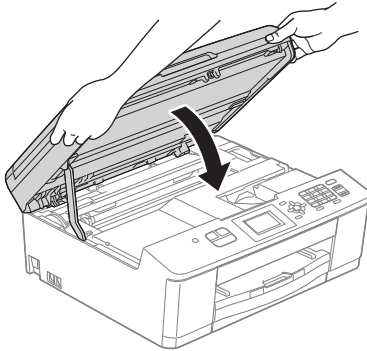

19 Install MFL-Pro Suite

- a** Put the supplied installer CD-ROM into your CD-ROM drive.
- b** Double-click the **Start Here OSX** icon to install.



- c** Choose **Local Connection (USB)**, and then click **Next**. Follow the on-screen instructions.

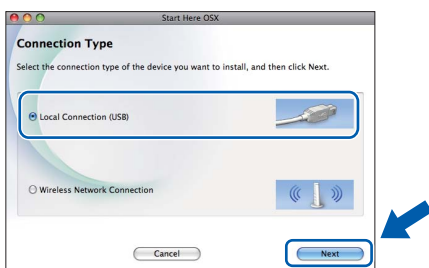

- d** Please wait for the software to install. After the installation, the Brother software will search for the Brother device. This will take a few moments to complete.

- e** Choose the machine from the list, and then click **OK**.

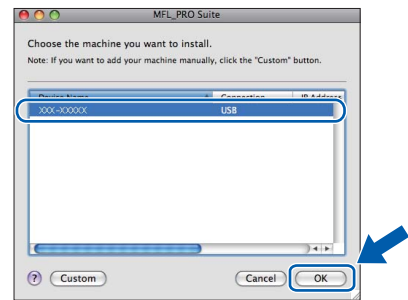

- f** When this screen appears, click **Next**.

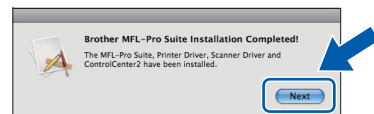

- OK!** The installation of MFL-Pro Suite is now complete. Go to step 20.

20 Download and install Presto! PageManager

When Presto! PageManager is installed OCR capability is added to Brother ControlCenter2. You can easily scan, share and organize photos and documents using Presto! PageManager.

- a** On the **Brother Support** screen, click the **Presto! PageManager** icon to go to the Presto! PageManager download site, and follow the on-screen instructions.

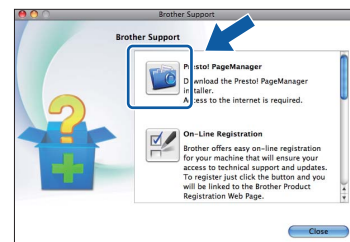

- Finish** The installation is now complete.

Note

To use Image Capture for scanning on Mac OS X 10.6.x, please install the CUPS Printer Driver, which can be downloaded from your model page on the Brother Solutions Center at <http://solutions.brother.com/>.



For wireless network interface users

17

Before you begin

First you must configure the wireless network settings of your machine to communicate with your network access point/router. After the machine is configured to communicate with your access point/router, computers on your network will have access to the machine. To use the machine from these computers, you will need to install the drivers and software. The following steps will guide you through the configuration and installation process.

To achieve optimum results with normal everyday document printing, place the Brother machine as close to the network access point/router as possible with minimal obstructions. Large objects and walls between the two devices as well as interference from other electronic devices can affect the data transfer speed of your documents.

Due to these factors, wireless may not be the best method of connection for all types of documents and applications. If you are printing large files, such as multi-page documents with mixed text and large graphics, you may want to consider choosing USB for the fastest throughput speed.



Note

If you have previously configured the wireless settings of the machine you must reset the network (LAN) settings before you can configure the wireless settings again.

*On your machine, press **Menu**. Press **▲** or **▼** to choose **Network** and press **OK**.*

*Press **▲** or **▼** to choose **Network Reset**, and then press **OK**.*

*Press **1** twice for **Yes** to accept the change.*

The following instructions are for infrastructure mode (connected to a computer through an access point/router).

Infrastructure Mode

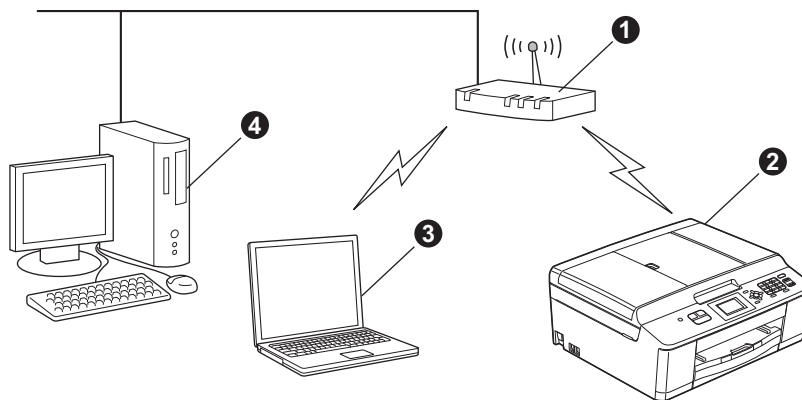

- ① Access point/router
- ② Wireless Network machine (your machine)
- ③ Wireless capable computer connected to the access point/router
- ④ Wired computer connected to the access point/router

Please make sure the wireless network settings of the machine match the access point/router.



Note

To set up your machine in Ad-hoc mode (connected to a wireless capable computer without an access point/router) you can find instructions in the Network User's Guide on the CD-ROM.

You can view the Network User's Guide by following the instructions below.

1 Turn on your computer. Insert the CD-ROM into your CD-ROM drive.

For Windows®:

2 Choose your model and the language. The CD-ROM top menu will appear.

*3 Click **Documentation**, and then click **PDF documents**. The top page will appear.*

4 Click Network User's Guide.

For Macintosh:

*2 Double-click **Documentation**, and then double-click your language folder.*

*3 Double-click **top.pdf**, and then click Network User's Guide.*



18 Choose your wireless install method

The following instructions will offer three methods for installing your Brother machine in a wireless network environment. Choose the method you prefer for your environment.

a Configuration using the CD-ROM installer and a USB cable (Windows® only)

- You need to temporarily use a USB cable during configuration (cable not included).

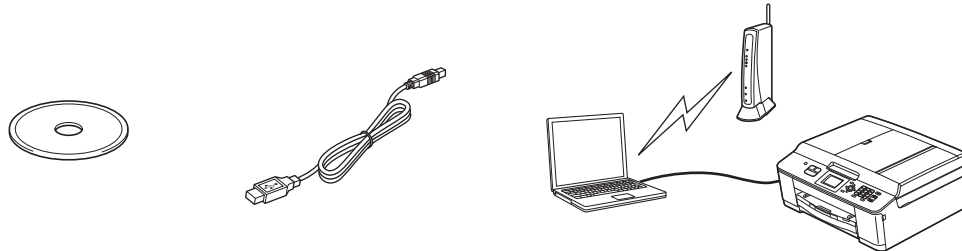

It is recommended that you use a PC wirelessly connected to your network for this method.

- If you are using Windows® XP, or currently using a computer connected to an access point/router by network cable, you need to know your wireless settings. Please write down your wireless network settings in the area below.
- Please do not contact Brother Customer Service for assistance without the wireless security information. We cannot assist you in locating your network security settings.

Item	Record the current wireless network settings
SSID (Network Name)	
Network Key	

* The Network Key may also be described as the Password, Security Key or Encryption Key.

Note

If you do not know this information (SSID and Network Key), you cannot continue the wireless setup.

How can I find this information?

- 1) You should see the documentation provided with your wireless access point/router.
- 2) The initial network name could be the manufacturer's name or the model name.
- 3) If you do not know the security information, please consult the router manufacturer, your system administrator, or internet provider.

Now go to

page 22



b Manual configuration from the control panel (Windows® and Macintosh)

If your wireless access point/router does not support WPS (Wi-Fi Protected Setup) or AOSS™, **write down the wireless network settings** of your wireless access point/router in the area below.

Please do not contact Brother Customer Service for assistance without the wireless security information. We cannot assist you in locating your network security settings.

Item	Record the current wireless network settings
SSID (Network Name)	
Network Key	

* The Network Key may also be described as the Password, Security Key or Encryption Key.

Note

If you do not know this information (SSID and Network Key), you cannot continue the wireless setup.

How can I find this information?

- 1) You should see the documentation provided with your wireless access point/router.
- 2) The initial SSID could be the manufacturer's name or the model name.
- 3) If you do not know the security information, please consult the router manufacturer, your system administrator, or internet provider.

Now go to

page 25

c One-push configuration using WPS or AOSS™ (Windows® and Macintosh)

If your wireless access point/router supports automatic wireless (one-push) setup (WPS or AOSS™)

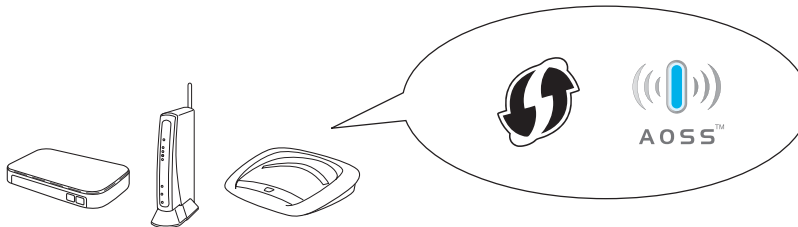

Now go to

page 26



19 Configuration using the CD-ROM installer and a USB cable (Windows® only)

You need to temporarily use a USB cable during configuration (cable not included).

- a** Put the supplied installer CD-ROM into your CD-ROM drive. If the model name screen appears, choose your machine. If the language screen appears, choose your language.

Note

If the Brother screen does not appear automatically, go to **My Computer (Computer)**, double-click the CD-ROM icon, and then double-click **start.exe**.

- b** The CD-ROM Top Menu will appear. Click **Install MFL-Pro Suite** and click **Yes** if you accept the license agreements. Follow the on-screen instructions.



Note

For Windows Vista® and Windows® 7, when the User Account Control screen appears, click **Allow** or **Yes**.

- c** Choose **Wireless Network Connection**, and then click **Next**.

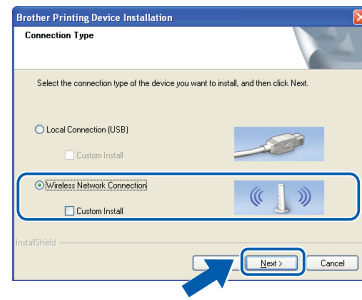

- d** When this screen appears, choose **Change the Firewall port settings to enable network connection and continue with the installation. (Recommended)** and click **Next**.

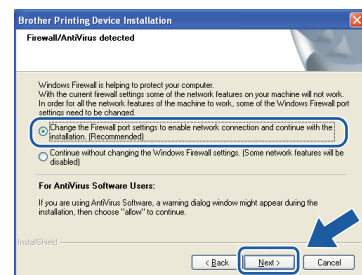

If you are using a firewall other than the Windows® Firewall or the Windows® Firewall is off, this screen may appear.

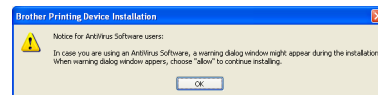

See the instructions provided with your firewall software for information on how to add the following network ports.

- For network scanning, add UDP port 54925.
- For network PC-Fax receiving, add UDP port 54926.
- If you still have trouble with your network connection, add UDP port 137 and 161.

- e** Choose **Use your computer or the control panel directly**, and then click **Next**.

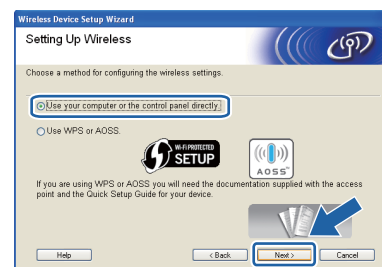



For Wireless Network Users

f Choose **Temporarily use a USB cable (Recommended)** and then click **Next**.

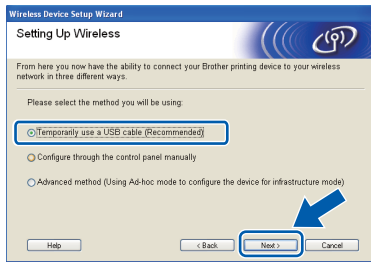

Note

If this screen appears, read the **Important Notice**. Check the box after you confirm the SSID and Network Key, and then click **Next**.

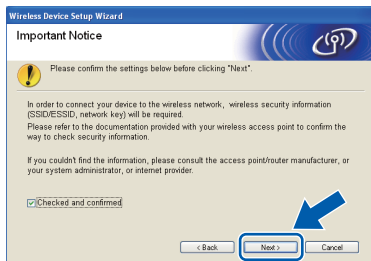

g Temporarily connect the USB cable (not included) directly to the computer and the machine.



If the confirmation screen appears, check the box and click **Next**, go to **h**. Otherwise, go to **i**.

h When the following screen appears, check **Yes** if you want to connect to the listed SSID. Click **Next** and go to **k**.

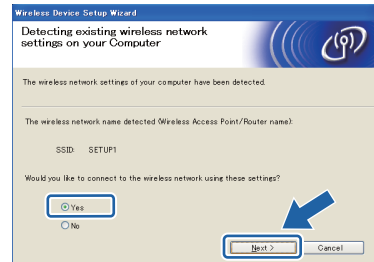

When the following screen appears, the wizard will search for wireless networks available to your machine. Choose the SSID that you wrote down for your network in step **18-a** on page 20, and then click **Next**.

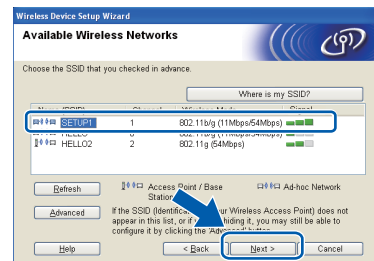

Note

- If the list is blank, check that the access point has power and is broadcasting the SSID, and then see if the machine and the access point are within range for wireless communication. Then click **Refresh**.
- If your access point is set to not broadcast the SSID you can manually add it by clicking the **Advanced** button. Follow the on-screen instructions for entering the **Name (SSID)**, and then click **Next**.

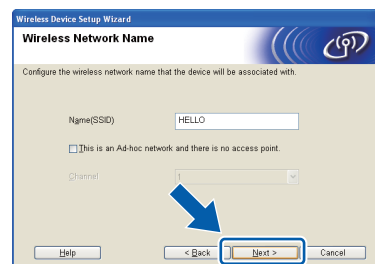



j Enter the **Network Key** you wrote down in step **18-a** on page 20 and then enter the key again in **Confirm Network Key**, then click **Next**.



Note

*If your network is not configured for Authentication and Encryption, the following screen will appear. To continue configuration, click **OK** and go to **k**.*



k Click **Next**. The settings will be sent to your machine.

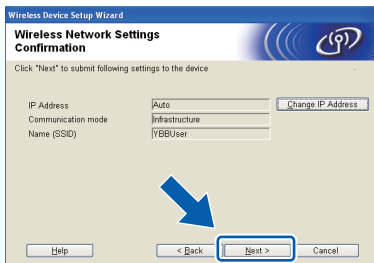

Note

- *The settings will remain unchanged if you click **Cancel**.*
- *If you want to manually enter the IP address settings of your machine, click **Change IP Address** and enter the necessary IP address settings for your network.*
- *If the wireless setup failure screen appears, click **Retry**.*

l Disconnect the USB cable between the computer and the machine.



m Click **Next** to continue to install MFL-Pro Suite.

Wireless setup is now complete. A four level indicator at the upper right of your machine's LCD will show the wireless signal strength of your access point/router.

To install MFL-Pro Suite, continue to step 21-e on page 30.

Now go to

Page 30



19 Manual configuration from the control panel (Windows® and Macintosh)

You must have the wireless settings you wrote down for your network in step 18-b on page 21 before you proceed.

a On your machine, press **Menu**. Press **▲** or **▼** to choose **Network** and press **OK**. Press **▲** or **▼** to choose **Setup Wizard** and press **OK**. When **Enable WLAN?** is displayed, press **OK** to accept. This will start the wireless setup wizard. To cancel, press **Stop/Exit**.

b The machine will search for available SSIDs. It will take several seconds to display a list of available SSIDs. If a list of SSIDs is displayed, press **▲** or **▼** to choose the SSID you wrote down in step 18-b on page 21, then press **OK**.

If the wireless access point/router of the selected SSID supports WPS and the machine asks to use WPS, go to **c**. If the machine asks you to enter a Network Key, go to **d**. Otherwise, go to **e**.

Note

- If a list of SSIDs is not displayed, make sure your access point is on. Move your machine closer to the access point and try starting from **a** again.
- If your access point is set to not broadcast the SSID, you will have to manually add the SSID name. For details, see the Network User's Guide.

c Press **1 (Yes)** to connect your machine using WPS. (If you choose **2 (No)** to continue manual setting, go to **d** to enter a Network Key.) When the LCD shows **Start WPS**, press the WPS button on your wireless access point/router, and then press **1 (Next)** to proceed. Go to **e**.

d Enter the Network Key you wrote down in step 18-b on page 21 using the dial pad to choose each letter or number. The letters appear in this order: lower case, upper case and then numbers. To move the cursor left or right, press **◀** or **▶**. (For more information, see *Entering Text for Wireless Settings* on page 35.)

Press **OK** when you have entered all the characters, then press **1 (Yes)** to apply your settings.

e Your machine will now try to connect to your wireless network. It may take a few minutes.

f A connection result message appears for 60 seconds on the LCD and a wireless LAN report will automatically be printed. If the connection failed, check the error code on the printed report and refer to *Troubleshooting* on page 27.

Wireless setup is now complete. A four level indicator at the upper right of your machine's LCD will show the wireless signal strength of your access point/router.

To install MFL-Pro Suite, continue to step 20.

For Windows® Users:

Now go to
Page 29

For Macintosh Users:

Now go to
Page 32



19 One-push configuration using WPS or AOSS™ (Windows® and Macintosh)

- a** Confirm your wireless access point/router has the WPS or AOSS™ symbol as shown below.



- b** Place the Brother machine within range of your WPS or AOSS™ access point/router. The range may differ depending on your environment. Refer to the instructions provided with your access point/router.

- c** On your machine, press **Menu**. Press **▲** or **▼** to choose **Network** and press **OK**. Press **▲** or **▼** to choose **WPS/AOSS** and press **OK**. When **Enable WLAN?** is displayed, press **OK** to accept. This will start the wireless setup wizard.

Note

If your wireless access point/router supports WPS (PIN Method) and you want to configure your machine using the PIN (Personal Identification Number) Method, see Configuration using the PIN Method of Wi-Fi Protected Setup in the Network User's Guide.

- d** When the LCD shows **Start WPS** or **AOSS**, press the WPS or AOSS™ button on your wireless access point/router. See the user's guide of your wireless access point/router for instructions.

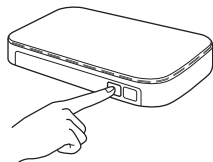

Then press **OK** and your machine will now automatically detect which mode (WPS or AOSS™) your wireless access point/router uses and try to connect to your wireless network.

- e** A connection result message appears for 60 seconds on the LCD and a wireless LAN report will automatically be printed. If the connection failed, check the error code on the printed report and refer to *Troubleshooting* on page 27.

OK! Wireless setup is now complete. A four level indicator at the upper right of your machine's LCD will show the wireless signal strength of your access point/router.

To install MFL-Pro Suite, continue to step 20.

For Windows® Users:

Now go to

Page 29

For Macintosh Users:

Now go to

Page 32



Troubleshooting

Please do not contact Brother Customer Service for assistance without the wireless security information. We cannot assist you in locating your network security settings.

How can I find the wireless security information (SSID and Network Key)

- 1) You should see the documentation provided with your wireless access point/router.
- 2) The initial SSID could be the manufacturer's name or the model name.
- 3) If you do not know the security information, please consult the router manufacturer, your system administrator, or internet provider.

* The Network Key may also be described as the Password, Security Key or Encryption Key.

Wireless LAN report

If the wireless LAN report that printed shows that the connection failed, check the error code on the printed report and refer to the following instructions.

Error code	Recommended Solutions
TS-01	<p>The wireless setting is not activated, turn the wireless setting to ON.</p> <p>On your machine, press Menu. Press ▲ or ▼ to choose <i>Network</i> and press OK. Press ▲ or ▼ to choose <i>WLAN Enable</i> and press OK. Press ▲ or ▼ to choose <i>On</i> and press OK. Press Stop/Exit.</p>
TS-02	<p>The wireless access point/router cannot be detected.</p> <p>1. Check the following 4 points.</p> <ul style="list-style-type: none"> - Make sure that the wireless access point/router is powered on. - Move your machine to an obstruction-free area, or closer to the wireless access point/router. - Temporarily place your machine within about 3.3 feet (one meter) from the wireless access point when you are configuring the wireless settings. - If your wireless access point/router is using MAC address filtering, confirm the MAC address of the Brother machine is allowed in the filter. <p>2. If you manually entered the SSID and security information (SSID/authentication method/encryption method/Network Key), the information may be incorrect. Reconfirm the SSID and security information and re-enter the correct information as necessary.</p> <p>See <i>How can I find the wireless security information (SSID and Network Key)</i> on page 27 to confirm.</p>

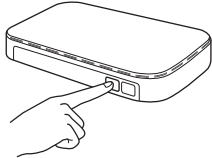

<p>TS-04</p>	<p>The Authentication/Encryption methods used by the selected wireless access point/router are not supported by your machine.</p> <p>For infrastructure mode, change the authentication and encryption methods of the wireless access point/router. Your machine supports the following authentication methods:</p> <table border="1" data-bbox="416 394 1177 658"> <thead> <tr> <th>authentication method</th> <th>encryption method</th> </tr> </thead> <tbody> <tr> <td rowspan="2">WPA-Personal</td> <td>TKIP</td> </tr> <tr> <td>AES</td> </tr> <tr> <td>WPA2-Personal</td> <td>AES</td> </tr> <tr> <td rowspan="2">Open</td> <td>WEP</td> </tr> <tr> <td>None (without encryption)</td> </tr> <tr> <td>Shared key</td> <td>WEP</td> </tr> </tbody> </table> <p>If your problem is not solved, the SSID or network settings you entered may be incorrect. Reconfirm the wireless network settings.</p> <p>See <i>How can I find the wireless security information (SSID and Network Key)</i> on page 27 to confirm.</p> <p>For ad-hoc mode, change the authentication and encryption methods of your computer for the wireless setting. Your machine supports Open authentication method only, with optional WEP encryption.</p>	authentication method	encryption method	WPA-Personal	TKIP	AES	WPA2-Personal	AES	Open	WEP	None (without encryption)	Shared key	WEP
authentication method	encryption method												
WPA-Personal	TKIP												
	AES												
WPA2-Personal	AES												
Open	WEP												
	None (without encryption)												
Shared key	WEP												
<p>TS-05</p>	<p>The security information (SSID/Network Key) is incorrect. Reconfirm the SSID and security information (Network Key). If your router uses WEP encryption, enter the key used as the first WEP key. Your Brother machine supports the use of the first WEP key only.</p> <p>See <i>How can I find the wireless security information (SSID and Network Key)</i> on page 27 to confirm.</p>												
<p>TS-06</p>	<p>The wireless security information (Authentication method/Encryption method/Network Key) is incorrect. Reconfirm the wireless security information (Authentication method/Encryption method/Network Key) in the table of TS-04. If your router uses WEP encryption, enter the key used as the first WEP key. Your Brother machine supports the use of the first WEP key only.</p> <p>See <i>How can I find the wireless security information (SSID and Network Key)</i> on page 27 to confirm.</p>												
<p>TS-07</p>	<p>The machine cannot detect a wireless access point/router that has WPS or AOSS™ enabled.</p> <p>If you would like to configure your wireless settings using WPS or AOSS™, you must operate both your machine and the wireless access point/router. Confirm your wireless access point/router supports WPS or AOSS™ and try starting again.</p> <p>If you do not know how to operate your wireless access point/router using WPS or AOSS™ see the documentation provided with your wireless access point/router, ask the manufacturer of your wireless access point/router or ask your network administrator.</p> 												
<p>TS-08</p>	<p>Two or more wireless access points that have WPS or AOSS™ enabled are detected.</p> <ul style="list-style-type: none"> - Confirm that only one wireless access point/router within range has the WPS or AOSS™ method active and try again. - Try starting again after a few minutes in order to avoid interference from other access points. 												



Install the drivers & software

(Windows® XP Home/XP Professional/Windows Vista®/Windows® 7)

20 Before you install

Make sure that your computer is ON and you are logged on with Administrator rights.

IMPORTANT

If there are any programs running, close them.

Note

- The screens may differ depending on your operating system.
- The CD-ROM includes ScanSoft™ PaperPort™ 12SE. This software supports Windows® XP Home (SP3 or greater), XP Professional (SP3 or greater), XP Professional x64 Edition (SP2 or greater), Windows Vista® (SP2 or greater) and Windows® 7. Update to the latest Windows® Service Pack before installing MFL-Pro Suite.

21 Install MFL-Pro Suite

a Put the supplied installer CD-ROM into your CD-ROM drive. If the model name screen appears, choose your machine. If the language screen appears, choose your language.

Note

If the Brother screen does not appear automatically, go to **My Computer (Computer)**, double-click the CD-ROM icon, and then double-click **start.exe**.

b The CD-ROM Top Menu will appear. Click **Install MFL-Pro Suite** and click **Yes** if you accept the license agreements. Follow the on-screen instructions.



Note

For Windows Vista® and Windows® 7, when the User Account Control screen appears, click **Allow** or **Yes**.

c Choose **Wireless Network Connection**, and then click **Next**.

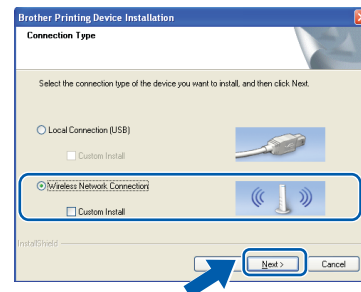



- d** When this screen appears, choose **Change the Firewall port settings to enable network connection and continue with the installation. (Recommended)** and click **Next**.

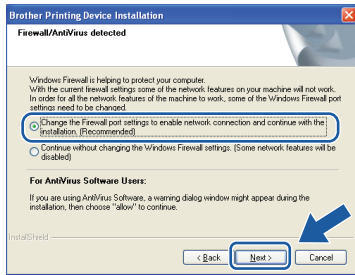

If you are using a firewall other than the Windows® Firewall or the Windows® Firewall is off, this screen may appear.

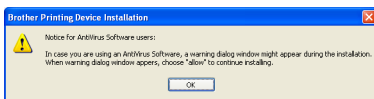

See the instructions provided with your firewall software for information on how to add the following network ports.

- For network scanning, add UDP port 54925.
- For network PC-Fax receiving, add UDP port 54926.
- If you still have trouble with your network connection, add UDP port 137 and 161.

- e** Choose your machine from the list, and then click **Next**.

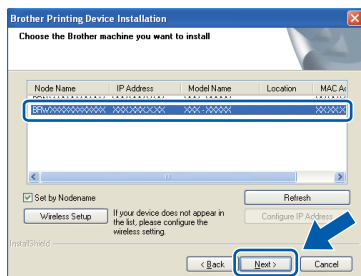

Note

*If you are using WEP and the LCD displayed **Connected** but your machine is not found on the network, make sure you entered the WEP key correctly. The WEP key is case sensitive.*

- f** The installation of the Brother drivers will automatically start. The installation screens appear one after another.

! IMPORTANT

DO NOT cancel any of the screens during the installation. It may take a few seconds for all screens to appear.

Note

*For Windows Vista® and Windows® 7, when the Windows® Security screen appears, click the check box and click **Install** to complete the installation correctly.*

- g** When the **On-Line Registration** screen is displayed, make your selection and follow the on-screen instructions.

- h** If you do not want to set your machine as the Default printer, uncheck **Set as Default Printer** and then click **Next**.



22 Finish and restart

- a Click **Finish** to restart your computer. After restarting the computer, you must be logged on with Administrator rights.



Note

- If an error message appears during the software installation, run the **Installation Diagnostics** located in **Start/All Programs/Brother/MFC-JXXX** (where MFC-JXXX is your model name).
- Depending on your security settings, a Windows® Security or antivirus software window may appear when using the machine or its software. Please allow or permit the window to continue.

- b The following screens will appear.
 - When the **Check for Firmware Updates** screen appears, choose the firmware update setting you want and click **OK**.
 - When the **Brother Product Research & Support Program** starts up, follow the on-screen instructions.

Note

Internet access is required for the firmware update and the **Brother Product Research & Support Program**.

23 Install MFL-Pro Suite on additional computers (if needed)

If you want to use your machine with multiple computers on the network, install MFL-Pro Suite on each computer. Go to step **20** on page 29.

Note

Network license (Windows®)

This product includes a PC license for up to 2 Users. This license supports the installation of the MFL-Pro Suite including ScanSoft™ PaperPort™ 12SE on up to 2 PCs on the network. If you want to use more than 2 PCs with ScanSoft™ PaperPort™ 12SE installed, please purchase the Brother NL-5 pack which is a multiple PC license agreement pack for up to 5 additional users. To purchase the NL-5 pack, contact your authorized Brother dealer or contact Brother customer service.

Finish

The installation is now complete.

Now go to

Proceed to Install Optional Applications on page 34.

Note

XML Paper Specification Printer Driver

The XML Paper Specification Printer Driver is the most suitable driver for Windows Vista® and Windows® 7 when printing from applications that use the XML Paper Specification documents. Please download the latest driver by accessing the Brother Solutions Center at <http://solutions.brother.com/>.



Install the drivers & software (Mac OS X 10.4.11, 10.5.x, 10.6.x)

20 Before you install

Make sure your machine is connected to the power and your Macintosh is ON. You must be logged on with Administrator rights.

Note

For Mac OS X 10.4.0 to 10.4.10 users, upgrade to Mac OS X 10.4.11 - 10.6.x.

21 Install MFL-Pro Suite

- a Put the supplied installer CD-ROM into your CD-ROM drive.
- b Double-click the **Start Here OSX** icon to install.



- c Choose **Wireless Network Connection**, and then click **Next**.



- d The Brother software will search for the Brother device in your wireless network. If the machine is configured for your network, choose the device you want to install, and then click **Next**.

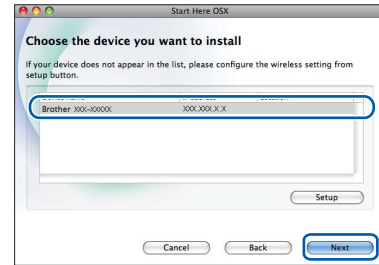

Note

If your wireless settings fail, the **Wireless Device Setup Wizard** screen appears. Follow the on-screen instructions to complete the wireless configuration.

- e Please wait for the software to install. After the installation, this window will appear. Choose your machine from the list, and then click **OK**.

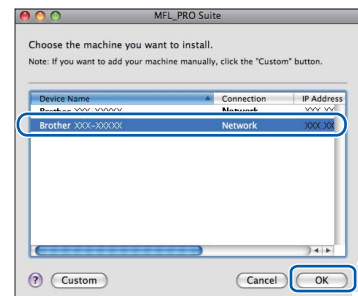



Note

- You can find your machine's MAC Address (Ethernet Address) and IP Address by printing out the Network Configuration Report. See Printing the Network Configuration Report in the Network User's Guide.
- If this screen appears click **OK**.



Enter a name for your Macintosh in **Display Name** up to 15 characters long.

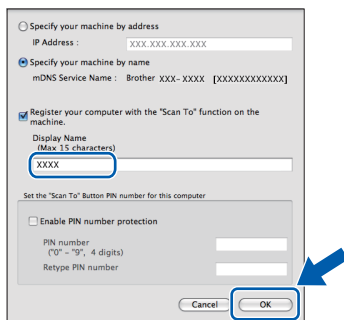

If you want to use the machine's **SCAN** key to scan over the network, you must check the **Register your computer with the "Scan To" function on the machine box**. Click **OK**. Go to **f**.

The name you enter will appear on the machine's LCD when you press the **SCAN** key and choose a scan option. (For more information, see Network Scanning in the Software User's Guide.)

- f** When this screen appears, click **Next**.

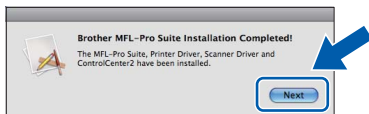

- OK!** The installation of MFL-Pro Suite is now complete. Go to step **22**.

22 Download and install Presto! PageManager

When Presto! PageManager is installed OCR capability is added to Brother ControlCenter2. You can easily scan, share and organize photos and documents using Presto! PageManager.

- a** On the **Brother Support** screen, click the **Presto! PageManager** icon to go to the Presto! PageManager download site, and follow the on-screen instructions.

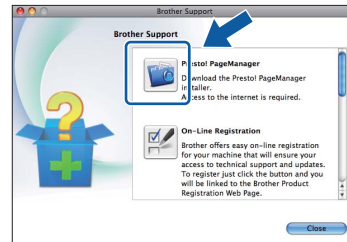

23 Install MFL-Pro Suite on additional computers (if needed)

If you want to use your machine with multiple computers on the network, install MFL-Pro Suite on each computer. Go to step **20** on page 32.

Finish

The installation is now complete.

Note

To use Image Capture for scanning on Mac OS X 10.6.x, please install the CUPS Printer Driver, which can be downloaded from your model page on the Brother Solutions Center at <http://solutions.brother.com/>.

1 Install optional applications

FaceFilter Studio/BookScan & Whiteboard Suite supported by Reallusion, Inc

FaceFilter Studio is an easy-to-use borderless photo printing application.

The **BookScan Enhancer** software can correct your scanned book images automatically.

The **Whiteboard Enhancer** software cleans up and enhances text and images from photos taken of your whiteboard.

Homepage Print 2 supported by Corpus¹

Homepage Print 2 is an application that helps you capture and edit web pages so that you can print out only the information you need.

¹ See the *Software User's Guide* for details.

Note

- The machine must be ON and connected to the computer.
- Some applications require Internet access.
- Make sure you are logged on with Administrator rights.
- This application is not available for Windows Server® 2003/2008 series.

a Open the top menu again by ejecting and then reinserting the CD-ROM or by double-clicking the **start.exe** program from the root folder.

b The CD-ROM Top Menu will appear. Choose your language and then click **Additional Applications**.

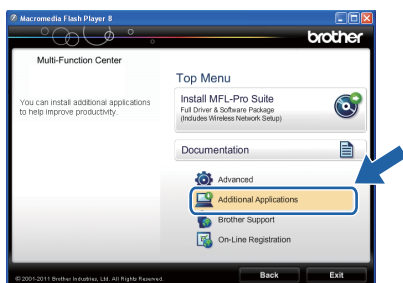

c Click the button for the application you want to install.

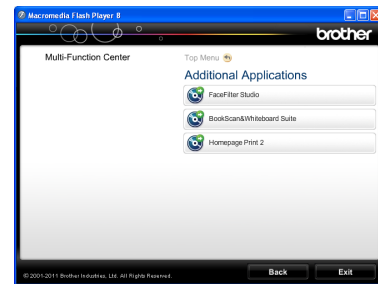

d Go back to the **Additional Applications** screen to install more applications.

2 Install FaceFilter Studio Help

To get instructions on how to use FaceFilter Studio, download and install FaceFilter Studio Help.

a To run FaceFilter Studio, go to **Start/All Programs/Reallusion/FaceFilter Studio** on your computer.

b Click **Check for updates** on the screen or click the **?** button on the upper right corner of the screen to go to the Reallusion update web page.



c Click the **Download** button and choose a folder to save the file in.

d Close FaceFilter Studio before you start the installer for FaceFilter Studio Help. Double-click the downloaded file from the folder you specified and follow the on-screen instructions for installation.

Note

To view the complete FaceFilter Studio Help, choose **Start/All Programs/Reallusion/FaceFilter Studio/FaceFilter Studio Help** on your computer.

Reset the network settings to factory default

To restore all network settings of the internal Print/Scan server to factory default, please follow the steps below.

- a** Make sure the machine is not operating.
- b** Press **Menu**.
- c** Press **▲** or **▼** to choose **Network**.
Press **OK**.
- d** Press **▲** or **▼** to choose **Network Reset**.
Press **OK**.
- e** Press **1** to choose **Yes**.
- f** Press **1** to choose **Yes**.
- g** The machine will restart, and the reset is complete.

Entering Text for Wireless Settings

Most number keys have three or four letters printed on them. The keys for **0**, **#** and ***** do not have printed letters because they are used for special characters.

By pressing the correct number key repeatedly, you can access the character you want.

For configuring wireless network settings

Press Key	One time	Two times	Three times	Four times	Five times	Six times	Seven times	Eight times	Nine times
2	a	b	c	A	B	C	2	a	b
3	d	e	f	D	E	F	3	d	e
4	g	h	i	G	H	I	4	g	h
5	j	k	l	J	K	L	5	j	k
6	m	n	o	M	N	O	6	m	n
7	p	q	r	s	P	Q	R	S	7
8	t	u	v	T	U	V	8	t	u
9	w	x	y	z	W	X	Y	Z	9

Inserting spaces

To enter a space in a name, press **▶** twice.

Making corrections

If you entered a character incorrectly and want to change it, press **◀** or **▶** to move the cursor to the incorrect character, press **Clear**. Re-enter the correct character. You can also back up and insert a character.

Repeating characters

If you need to enter a character that is on the same key as the character before, press **▶** to move the cursor to the right before you press the key again.

Special characters and symbols

Press *****, **#** or **0** repeatedly until you see the special character or symbol you want.

Press ***** for (space)! " # \$ % & ' () * + , - . /





Press **#** for ; < = > ? @ [] ^ _

Press **0** for 0 \ { | } ~

Replacement consumables

When the time comes to replace ink cartridges, an error message will be indicated on the LCD. For more information about the ink cartridges for your machine, visit <http://www.brother.com/original/> or contact your local Brother re-seller.

Ink cartridge

Black	Yellow	Cyan	Magenta
LC71BK (Standard) LC75BK (High Yield)	LC71Y (Standard) LC75Y (High Yield)	LC71C (Standard) LC75C (High Yield)	LC71M (Standard) LC75M (High Yield)
			

What is Innobella™?

Innobella™ is a range of genuine consumables offered by Brother. The name “Innobella™” derives from the words “Innovation” and “Bella” (meaning “Beautiful” in Italian) and is a representation of the “innovative” technology providing you with “beautiful” and “long lasting” print results.



Trademarks

The Brother logo is a registered trademark of Brother Industries, Ltd.
Brother is a registered trademark of Brother Industries, Ltd.
Windows Vista is either a registered trademark or trademark of Microsoft Corporation in the United States and/or other countries.
Windows and Windows Server are registered trademarks of Microsoft Corporation in the United States and/or other countries.
Macintosh and Mac OS are trademarks of Apple Inc., registered in the United States and other countries.
Nuance, the Nuance logo, PaperPort and ScanSoft are trademarks or registered trademarks of Nuance Communications, Inc. or its affiliates in the United States and/or other countries.
FaceFilter Studio is a trademark of Reallusion, Inc.
AOSS is a trademark of Buffalo Inc.
WPA, WPA2 and Wi-Fi Protected Setup are either trademarks or registered trademarks of Wi-Fi Alliance in the United States and/or other countries.
Each company whose software title is mentioned in this manual has a Software License Agreement specific to its proprietary programs.

Any trade names and product names of companies appearing on Brother products, related documents and any other materials are all trademarks or registered trademarks of those respective companies.

Compilation and Publication

Under the supervision of Brother Industries, Ltd., this manual has been compiled and published, covering the latest product descriptions and specifications.

The contents of this manual and the specifications of this product are subject to change without notice.

Brother reserves the right to make changes without notice in the specifications and materials contained herein and shall not be responsible for any damages (including consequential) caused by reliance on the materials presented, including but not limited to typographical and other errors relating to the publication.

Copyright and License

©2011 Brother Industries, Ltd. All rights reserved.

This product includes software developed by the following vendors:

©1983-1998 PACIFIC SOFTWARES, INC.

©2008 Devicescape Software, Inc.

This product includes the “KASAGO TCP/IP” software developed by ZUKEN ELMIC, Inc.



 Get inspired. If you're using Windows®, double-click the Brother CreativeCenter icon on your desktop to access our FREE web site with many ideas and resources for personal and professional use.

Mac users can access Brother CreativeCenter at this web address: <http://www.brother.com/creativecenter/>

Free Manuals Download Website

<http://myh66.com>

<http://usermanuals.us>

<http://www.somanuals.com>

<http://www.4manuals.cc>

<http://www.manual-lib.com>

<http://www.404manual.com>

<http://www.luxmanual.com>

<http://aubethermostatmanual.com>

Golf course search by state

<http://golfingnear.com>

Email search by domain

<http://emailbydomain.com>

Auto manuals search

<http://auto.somanuals.com>

TV manuals search

<http://tv.somanuals.com>