

Portable Air-conditioner
GLA-08C
Use and Care Manual

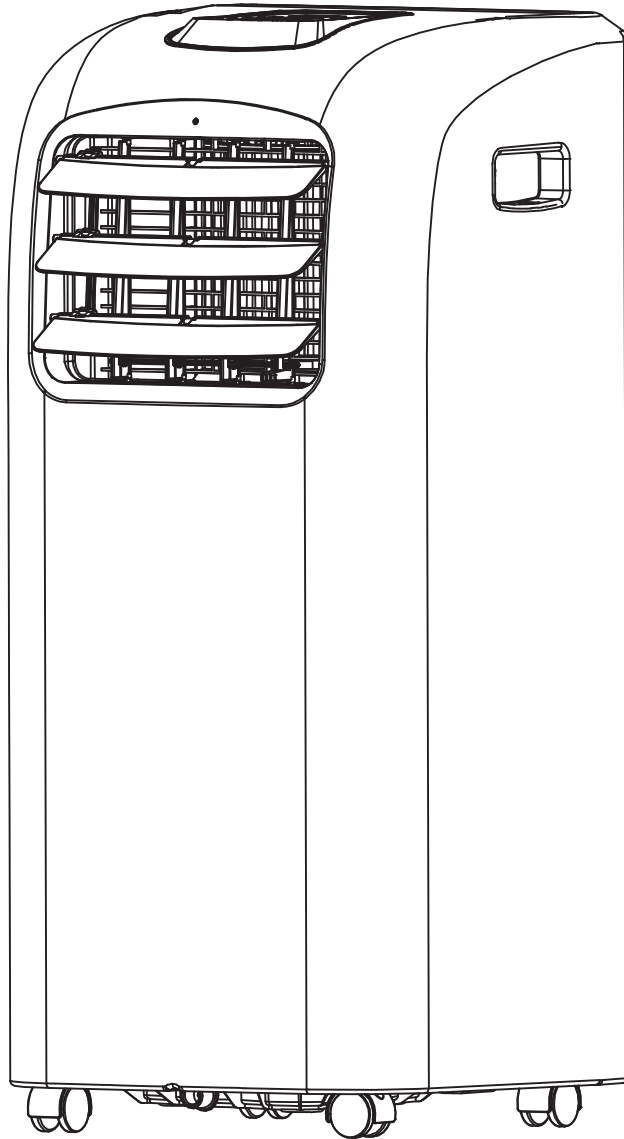

Thank you very much for selecting this new model of Portable Air Conditioner, please read this Use and Care Manual carefully before installing and using this appliance. Please keep this Use and Care Manual properly for future reference.

Contents

Safety Instructions.....	1
Function and Technical Specification.....	3
Identification of Parts.....	3
Operation and Settings.....	4
Protection.....	9
Handling and Transportation.....	9
Installation and Adjustment	9
Drainage Instruction.....	12
Maintenance and Service.....	13
End of Season Storage.....	14
Troubleshooting.....	15
Appendix.....	16

Safety Instructions

1. Electrical Specifications

1. All wiring must comply with local and national electrical codes and be installed by a qualified electrician. If you have any questions regarding to the following instructions, please contact a qualified electrician.
2. The unit must be installed in accordance with national wiring regulations. Check available power supply and resolve any wiring problems before installation and operation of this unit.
3. For your safety and protection, this unit will be grounded through the power cord plug when plugging into a matching wall outlet. If you are not sure whether the wall outlet at your home are properly grounded, please consult an electrician. If supply cord is damaged, it must be replaced by the manufacturer, its service agent or similarly qualified person in order to avoid any hazards.
4. This appliance is not intended for people (including children) with reduced physical, sensory or mental capabilities, or lack of experience and knowledge, unless they have been given supervision or instruction concerning use of the appliance by a person responsible for their safety. Young children should be supervised to ensure that they do not play with the appliance.

2. WARNING

To reduce the risk of fire, electrical shock or injury when using your air conditioner, follow up these basic precautions:

- ※ Indoor use only, it is prohibited to use this unit outdoors or in humid environment such as bathroom etc.
- ※ Do not remove ground prong.
- ※ Do not use an adapter.
- ※ Do not use an extension code.
- ※ Never share the power outlet with other appliances.
- ※ Never connect or disconnect the power plug with wet hands to avoid electric shocks.
- ※ Never turn off the unit by unplugging.
- ※ Unplug air conditioner before servicing.
- ※ Never dismantle, repair or modify the unit without authorization to avoid body injury or property damage, be sure it repaired by manufacturer or professionals.
- ※ Never put any objects into the unit.
- ※ Never cover or obstruct air inlet or outlet to prevent overheating.
- ※ Never hit or shake the unit to prevent damage.
- ※ Never spray water or place the unit near water to prevent electric shocks.
- ※ Never place the unit near gas appliances, fire or flammable liquids.
- ※ Move and install the unit by two or more people.
- ※ Keep children away from the unit.
- ※ This appliance can be used by children aged from 8 years and above and persons with reduced physical, sensory or mental capabilities or lack of experience and knowledge if they have been given supervision or instruction concerning use of the appliance in a safe way and understand the hazards involved. Children shall not play with the appliance. Cleaning and user maintenance shall not be made by children without supervision.

3. Cautions

- ※ Keep the unit at least 1 meter away from TV or radios to avoid electromagnetic interference.
- ※ Do not expose the unit under direct sun light to avoid surface color fading.
- ※ Do not tilt the unit for more than 35 degrees or upside-down while transporting.
- ※ Place the unit on a flat surface and upright with less than 5 degrees inclination.
- ※ The unit operates more efficiently in certain room locations (see Installation and Adjustment)
- ※ Keep the drain hose in good condition without flexure then connect with unit.
- ※ Manually adjust the vertical and horizontal louvers slightly to protect louvers from any damage.
- ※ Empty the condensed drainage pan before putting the unit in storage to prolong the unit lifetime end of the season.
- ※ Do not use chemical solvents (e.g. Benzene, alcohol-glazer) to clean the unit surface, do not scratch or damage the unit.
- ※ Make sure to cut off the power before disassembling or installing the filter.
- ※ Risk of Electric Shock. Disconnect Power Before Servicing Unit.
- ※ A damaged power supply cord must be replaced with a new power supply cord obtained from the product manufacturer and not repaired.
- ※ Use on Single Outlet Circuit Only.

Remark: Do not use this unit in cooling mode if the ambient temperature is higher than 95°F(35°C)

Function and Technical Specification

- ※ This unit offers cooling, dry, fan and sleep modes, ideal for home and office use.
- ※ This unit is with two fan-speed level accessible by panel control and remote control.
- ※ Temperature setting range of this unit is 62.6-86°F(17-30°C) ..
- ※ This unit is designed with various protection functions such as 24-hour programmable timer, auto condensate circle, super intelligent temperature sensor and water-full control and warning etc.

Technical Specification:

Model		Unit	GLA-08C
Power Supply		V~, Hz, Ph	110~120,60,1
Cooling Capacity		kW	2.35
Refrigerant/Charge		Oz	R410A/14.1
Rated input	Cooling	W	1160
Rated Current	Cooling	A	10.0
Moisture Removal		L/h	1.1
Air Circulation		m³/h	280
Noise	High	dB(A)	55
	Low	dB(A)	50
Body Size	W×H×D	inch	12.0×28.1×13.3
Package Size	W×H×D	inch	14.0×35.0×14.8
Net Weight/Gross Weight		lbs	52 /57.3
Application Area		m²	9~12

Remark: The above cooling capacity is measured at standard working condition of ambient temperature dry-bulb 95°F(35°C), wet-bulb 75.2°F(24°C) (Indoor and outdoor, the same conditions).

Identification of Parts

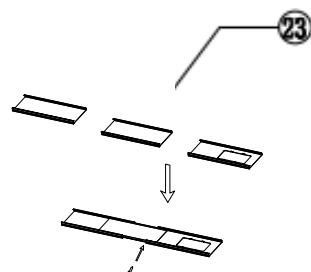
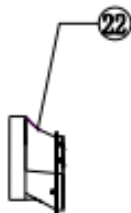
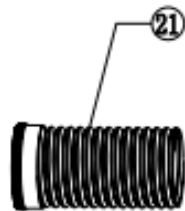
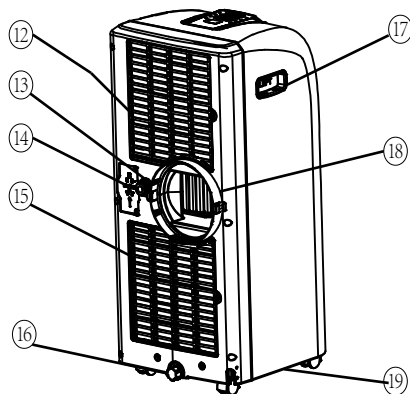
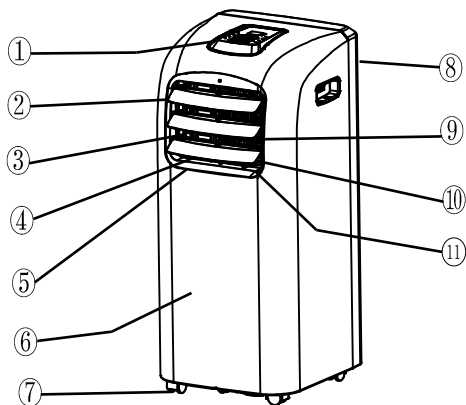

- | | |
|----------------------------------------------------------------------------------------------------------------------------------------------------------------------------------------------------------------------------------------------------------------------------------------------------------------------------------------------------------------------------------------------------------------------------------|-------------------------------------------------------------------------------------------------------------------------------------------------------------------------------------------------------------------------------------------------------------------------------------------------------------------------------------------------------------------------------------------------------------------|
| <ul style="list-style-type: none"> 1. Control panel 2. Vertical louvers 3. Horizontal louvers 4. Horizontal louvers connecting rod 5. Air outlet frame 6. Front shell 7. Universal wheel 8. Back shell 9. Central connecting rod 10. Vertical louvers connecting rod 11. Main vertical louver 12. Upper filter | <ul style="list-style-type: none"> 13. Upper drain hole and plug 14. Power cord storage 15. Lower filter 16. Lower drain hole and plug 17. Handle 18. Air discharge and protective vent 19. Chassis 20. Remote control 21. Exhaust hose assembly 22. Exhaust hose adapter 23. Window seal-plate assembly |
|----------------------------------------------------------------------------------------------------------------------------------------------------------------------------------------------------------------------------------------------------------------------------------------------------------------------------------------------------------------------------------------------------------------------------------|-------------------------------------------------------------------------------------------------------------------------------------------------------------------------------------------------------------------------------------------------------------------------------------------------------------------------------------------------------------------------------------------------------------------|

Operation and Settings

This section explains proper mobile air conditioner operation.

1. Control Panel

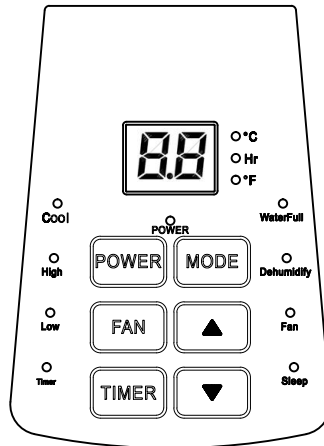

POWER	On/Off button	MODE	Mode button	▲	Up button
TIMER	Timer button	FAN	Fan speed button	▼	Down button
○ Timer	Timer indicator	○ High ○ Low	Fan speed indicator	○ WaterFull	Water-full indicator
○ Cool	Cool mode	○ Fan	Fan mode indicator	○ Dehumidify	Dehumidify mode indicator
○ Sleep	Sleep mode indicator	○ POWER	Power indicator	Grid icon	Remote control signal receiving window
88	LED display window	○ Hr	Timer indicator	○°C ○°F	Celsius/Fahrenheit temperature indicator

2. Control Panel Operation

This unit is with Cool, Dehumidifying, Fan and Sleep modes operations.

1) Turn on the unit.

A. Plug in and all indicators will light up on control panel and reminding music will be on, display window will show ambient temperature ranging from 50-95°F(10- 35°C), **POWER** will in red color, unit is standby for operation.

B. Press the **POWER** button, the unit is on with reminding music sounded, **POWER** will in green color, and operate in Cool Mode automatically, temperature set 75.2°F(24°C), fan runs at high speed, and **High** in green color.

2) Select operating mode

Press the **MODE** button to select a desired mode shown below, and its corresponding indicator will light up.



Under cooling mode, press “Timer” + “ ▼ ” buttons together, the unit auto enter into “Sleep” Mode.

3) Adjust temperature

The temperature can be set within a range of 62.6-86°F(17-30°C) under cooling mode.

Press ▲ or ▼ buttons to increase or decrease the temperature 1.8°F(1°C) by pressing once.



Press ▲ and ▼ buttons together to convert Celsius degrees and Fahrenheit degrees and corresponding indicator will light up.

4) Adjust fan speed

Press the  button to select a desired fan speed shown below



5) Stand-by

Press the  button again, the unit will stop working with reminding music sounded,  will be in red color.

Notice: Working principle for each mode and function

1. Cool mode:

- When room temperature is 1.8°F(1°C) higher than setting temperature, the compressor and fan will start working.
- When room temperature is 1.8°F(1°C) lower than setting temperature, the compressor will stop working and fan keep working at original speed.
- Room temperature can be set within a range of 62.6-86°F(17-30°C) and fan speed can be adjusted to high or low level.

2. Fan mode:

- Fan runs at set speed and can be adjusted to high or low, compressor do not work.
- Room temperature will automatically show on LED display with range 50-95°F (10-35°C) .
- Room temperature can't be adjusted.

3. Dehumidify mode:

- Fan runs at low speed automatically, fan speed and room temperature can't be adjusted.
- Room temperature will automatically show on LED display with range 50-95°F (10-35°C)

4. Sleep mode:

- Under cooling mode, press “Timer” + “ ▼ ” buttons together, the unit auto enter into “Sleep” mode.
- Fan will turn to low speed automatically and can't be adjusted.
- Set temperature will increase 1°C when unit running in 2 hours, increase 1.8°F(1°C) again in another 2-hour working, then keep set temperature unchanged further.
- Room temperature will automatically show in LED display with range 50-95°F (10-35°C) .

5. Timer Operation

- Press “Timer” button to set automatic OFF time while unit is running.
- Press “Timer” button to set automatic ON time while unit is off.
- The time can be adjusted within a range of 1-24 hours, press ▲ or ▼ buttons to increase or decrease 1 hour by pressing once.

3. Remote Control Operation

The Remote control transmits the signal to system.

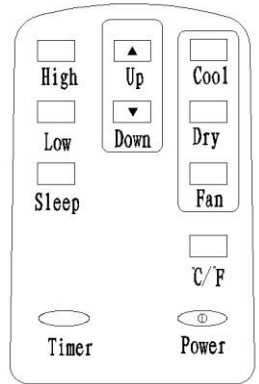



 **Power** Button: press this button to start unit when it is energized or stop the unit when it is in operation.

 **Timer** Button: press this button to set unit automatic on and off time

 **High** Button: press this button to select high speed of fan running (except dry and sleep modes)

 **Low** Button: press this button to select low speed of fan running.

 **Up** Button: press this button to increase temperature or timer setting.

 **Down** Button: press this button decrease temperature or timer setting.

 **C F** Button: press this button to make Celsius degrees and Fahrenheit degrees interchange.

 **Cool** Button: press this button to select “Cool” mode.

 **Fan** Button: press this button to select “Fan” mode

 **Dry** Button: press this button to select “Dry” or “dehumidifying” mode

 **Sleep** Button: press this button to select “Sleep” function under cooling mode.

Before using your remote, install the AAA batteries into remote control.

1. Press and glide the battery cover on the back of the remote control, then you can remove the cover.
2. Insert two new alkaline AAA batteries into the battery compartment. Be sure to note the proper polarity.
3. Reattach the battery cover and make sure the locking tab clicks into place.

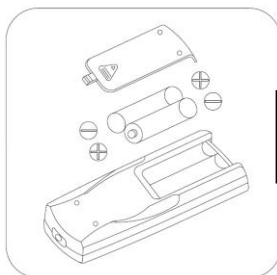

Be sure to note proper polarity of batteries

Notes:

- Use alkaline batteries only. Do not use rechargeable batteries.
- When replace batteries, always replace both batteries with new batteries, do not mix old and new batteries.
- If the air conditioner will not be used for an extended period of time, remove the batteries from the remote control.

CAUTION

If the liquid from the batteries gets onto your skin or clothes, wash it well with clean water, do not use the remote

control if the batteries have any leakage.

If you eat the liquid from the batteries, brush your teeth and see doctor. The chemicals in batteries could cause burns or other health hazards.

Multiple Protection Functions

1. Anti-freeze protection function

Compressor, water spraying motor will turn off when compressors running over 10 minutes and tube temperature (Tp) is continuously $\cong 35.6^{\circ}\text{F}$ (2°C) for 20 seconds under cooling mode, E4 will show on LED display window, the unit initiates the anti-frost protection and all buttons on control panel (except for power button) are inactive.

Once the tube temperature $\cong 46.4^{\circ}\text{F}$ (8°C), the protection is relieved to recover into original status, and compressor apply to 3-minute delay protection.

2. Water-full safety alarm and shut -off protection function:

Warning sounds when the water volume reached its alarm level in water tank, and unit is automatically stop working, both water-full indicator and "FL" on LED window is flashing. You need to drain the condensate for unit to automatically recover operation. (For more information about how to drain, refer to the "Drainage Instruction" please).

3. Delay protection function of compressor

This unit offers restart protection to compressor. Except that the compressor may start immediately when the unit is energized at first time, there is 3-minute start delay after compressor is shut down.

Handling and Transportation

1. Handle and move the unit

Hold handles on side panels to move the unit in upright position (As shown in Photo below).

Note:

- Make the unit in the upright position whatever handling or moving it.
- Drain the water in the unit completely to prevent water leakage and wet the floor or carpet before handling or moving the unit.

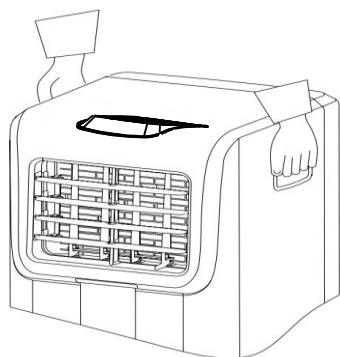

Installation & Adjustment

1. Installation

Warning:

- Keep this mobile air-conditioner in upright position at least 2 hours before first installation.

- This air-conditioner may be moved indoors conveniently; keep the unit in upright position while moving it. The air-conditioner shall be placed on flat surface.
- Do not install or operate this air-conditioner in bathroom or other wet environments.

1.1 Installation of exhaust hose assembly and its adapter



- 1) Take out the exhaust hose assembly and its adapter from plastic bag.
- 2) Extend the exhaust hose at one end, screw the round end of adapter into exhaust hose at anticlockwise direction (as Photo)).

Note: Screw adapter into right position, at least 3 laps, to keep good connection of exhaust hose assembly and its adapter (as Photo).

1.2 Installation of the exhaust hose assembly into unit

- 1) Determine window seal-plate position, vertical or horizontal direction.
- 2) If window seal-plate will be in horizontal position, the slant panel A of adapter should be upwards.
- 3) If window seal-plate will be in vertical position, and will be at left side of window, the slant panel A of adapter should be at right direction.
- 4) If window seal-plate will be in vertical position, and will be at right side of window, the slant panel A of adapter should be at left direction.

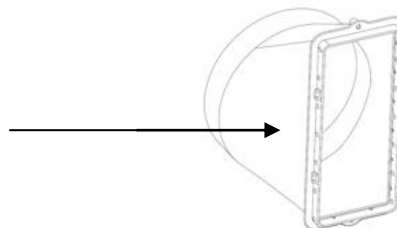

1. Take two ends of exhaust hose and its adapter assembly (as Photo).
2. Put front end of exhaust hose assembly onto jugged position of exhaust outlet of back panel (as Photo).

Remark: Keep the right direction of slant side A of adapter, for ease installation of window seal-plate.

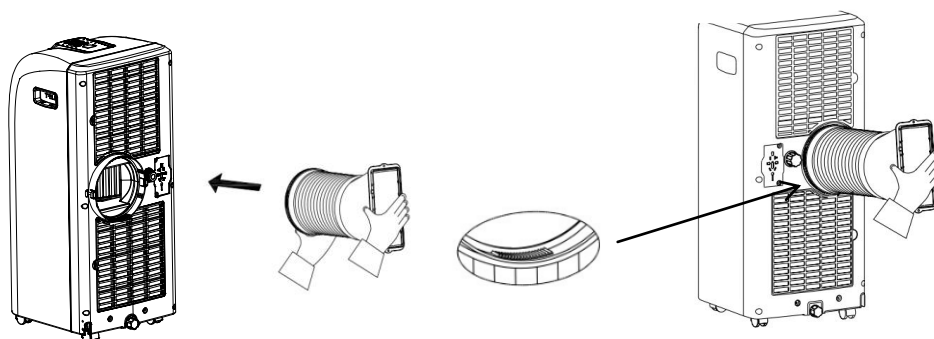

3. Hold the unit by one hand, carry the exhaust hose assembly with another hand and push it into unit gently, for good lock of two parts. (as Photo)

Remarks:

- Keep the right direction of slant side A of adapter, for ease installation of window seal-plate.
- Keep exhaust hose assembly be strongly locked by fasteners in exhaust outlet to avoid its fall off

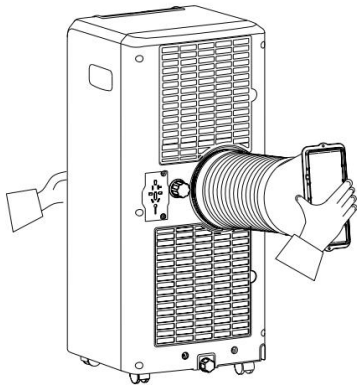

1.3 Installation of window seal-plate

- 1) Open the window in half, put the seal-plate into window, determine in vertical or horizontal position according to window open direction. (As Photo)
- 2) Extend seal plate parts, adjust it to the length of window and fix it with screws then.

Remarks:

1 Installation of window seal-plate

- Open the window in half, put the seal-plate into window,
- Extend seal plate parts and adjust it to the length of window, fix it with screws then.

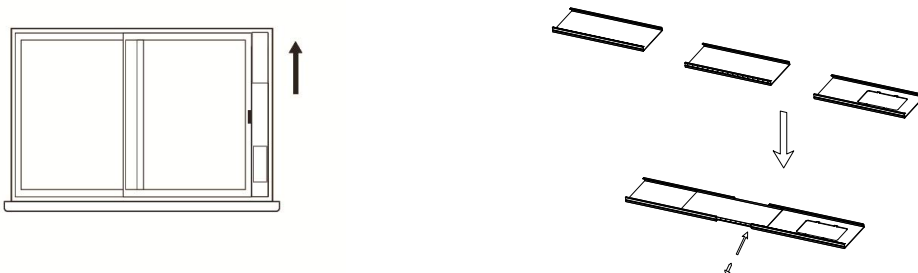

1.4 Installation of the unit

1. Move the unit together with its exhaust hose assembly in front of the window and keep the unit at least 50cm away from the walls or other objects. (As Photo).

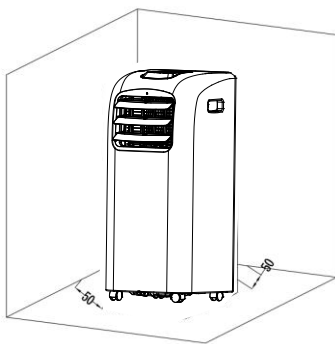

2. Install the rectangle end of exhaust hose adapter into the corresponding rectangle hole in window seal-plate assembly, fix it with screw and close the window (as Photo).
 - A. Align the 4 openings on window seal-plate with corresponding 4 openings on exhaust hose adapter and set them together, then slide adapter downwards, to make 2 set of openings locked for 2 parts good connection.

B. Lock self-tapping screw $\varphi 4$ mm into adapter hole.

Remarks:

- Slide the adapter downwards and assure the adapter installed in good position.
- Lock the screw tightly to avoid fall off.
- Exhaust hose can't be bent or with flexure higher than 45 degrees, in order to keep good ventilation of exhaust hose.

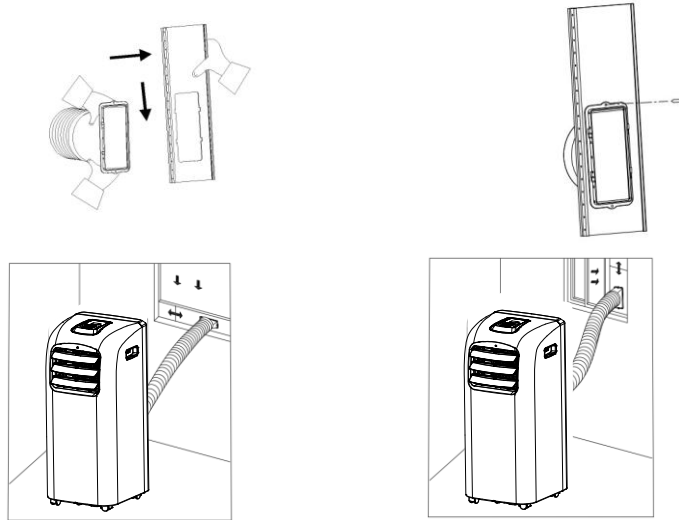

Important notes:

The exhaust hose is 280mm-1500mm long and which is determined by the specification of the air-conditioner (s). Do not use prolonged the hose or replace it with other different hoses as this may affect the functions of the air-conditioner. The exhaust hose must be smooth or it may lead air-conditioner overheat and trip because exhaust hose is obstructed.

Drainage Instruction

1. Manual drain:

When the water volume reached its alarm level in water tank, warning sounds and unit is automatically stop working, both water-full indicator and "FL" is flashing on LED display window.

- 1) Put the tray below the water outlet at the back of the unit.
- 2) Screw off the drain cover, unplug the water stopper for water flow into the tray.
- 3) Plug in stopper and screw the water cover tightly onto water outlet after drainage.

Notes:

- Protect the drain cover and water stopper properly.
- Move the unit carefully to avoid the leakage if it is necessary.
- Tilt the unit slightly backwards when draining.
- Block the drain hole as soon as possible before the tray is full if it can't hold all water in the unit to prevent the water leakage and wet the floor or carpet.
- Water stopper and drain cover must be tightly installed, to avoid new condensate to wet the floor or carpet when the unit re-starts working.

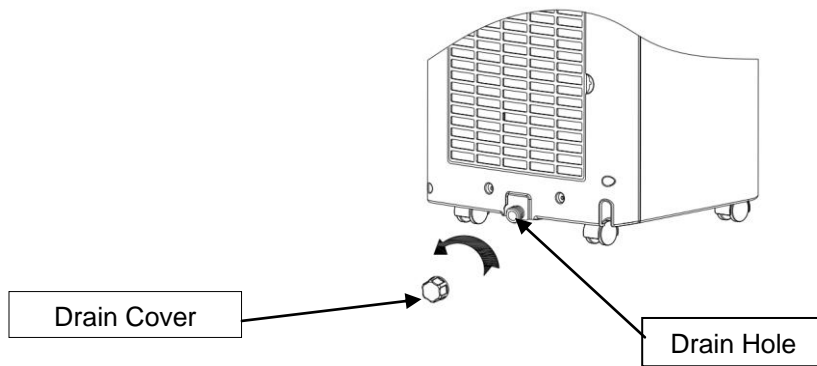

2. Continuous drain:

- 1) Screw off the drain cover and unplug the water stopper (as Photo).
- 2) Connect drain-hole with $\phi 13\text{mm}$ PVC drain hose, as deep as possible to avoid leakage (as Photo).
- 3) Pull the drain hose to bathroom or outdoor.

Notes:

- Drain hose must be installed before unit starts working.
- It is suggested to use manual drainage when unit in cooling mode, to ensure enough water to recycle in the unit to cool condenser and enhance cooling performance.
- Put the drain hose in an inaccessible place, not higher than drainage hole and keep drain hose straight without any flexure.
- Keep the drain cover and its stopper properly installed when continuous drainage is adopted.

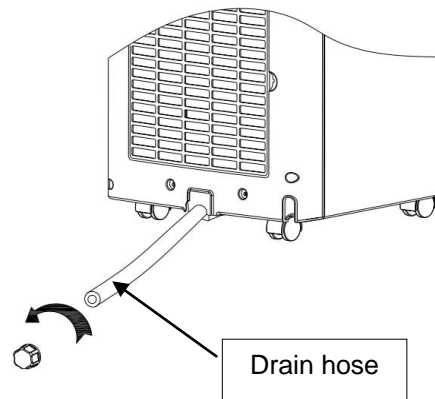
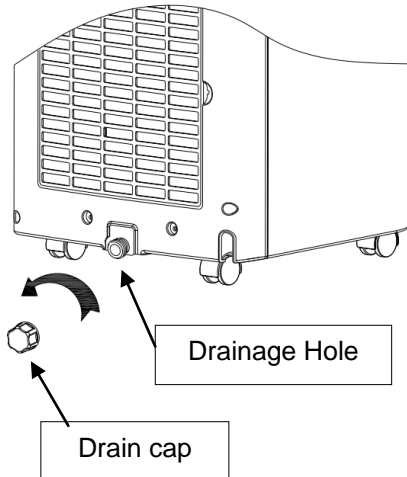

Maintenance and Service

Remark: Turn off the unit and pull out the plug before maintain or send the unit to service center.

1. Surface cleaning

Clean the unit surface with wet and soft cloth, but do not use chemical solvents such as alcohol and gasoline to avoid any damage to unit.

2. Filter cleaning

Clean the filter every two weeks, otherwise it would influence the unit performance if filter clogged with dust.

- Grip the filter handle and take it out gently in correct direction (as Photo).

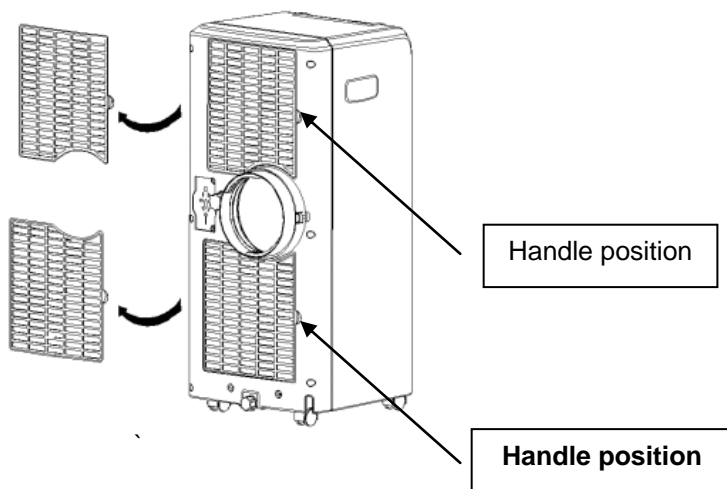

- Clean the filters gently in warm water (about **104°F (40°C)**) mixed with detergent, and dry in the shade (as Photo).

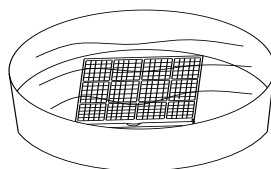

- push filter in even force gently into correct place to avoid any damage.

Notes:

- Do not squash the mesh.
- Do not hit the mesh with sharp objects or brush.

End of Season Storage

1. Screw off the drain cover, and then pull out the stopper to drain water completely.

Note: the tilt angle of the unit must be ≤ 30 degrees.

2. Keep the unit running in fan mode half day to dry inside of unit completely to prevent from going mouldy.
3. Turn off the unit, pull out plug then wrap the power cord around the wire-winding pillar, insert the plug into the universal fixing hole at the back panel of the unit, install the water plug and drain cap.
4. Remove the heat exhaust hose assembly, clean and keep it properly.

Notes:

- Hold the exhaust hose assembly with both hands when removal.
 - Push the fasteners aside on exhaust air outlet using your thumbs, then pull out exhaust hose assembly.
5. Pack the air-conditioner properly with soft plastic bag and put it in dry place with appropriate dust-proof measures and keep the unit away from children.
 6. Take out the batteries from the remote control and keep unit in a dry place, including all accessories well.

Troubleshooting

Please check the unit and suggestions below before asking for professional service, but never dismantle or repair the unit by yourself, it may cause harm to you and your property.

Trouble	Cause	Remedy
The unit fails to start up	Power supply failure	Connect the unit to a live socket and turn it on.
	Water-full and its indicator lighting up	Drain the water stored in the unit.
	Ambient temperature too low or too high	It is recommended to use this unit between 50-95°F (10-35°C)
	The room temperature is lower than the set temperature in cooling mode.	Change the set temperature
Bad cooling effects	There is direct sunlight	Close the curtain
	The doors and windows are open, the room is crowded or there are other heat sources	Close the door and window, remove other heat sources, and add new air-conditioners
	Dirty filter	Clean or replace the filter.
	Air inlet or air outlet clogged	Remove the obstruction
High noise level	The unit is being placed at uneven surface.	Put the unit at a flat and firm place (may reduce noise)
The compressor does not work	Initiation of overheat protection.	Wait until the temperature decrease, the unit will re-start automatically
The remote control does not work	Too long distance	Bring the remote control close to the air-conditioner and ensure aims at signal receptor on unit.
	The remote control didn't aim at signal receptor on unit.	
	The batteries have no electricity	Replace the batteries
LED displays error code "E1"	Tube temperature sensor failure	Check the tube temperature sensor and related circuits
LED displays error code "E2"	Room temperature sensor failure	Check the room temperature sensor and related circuits
LED displays error code "E4"	Anti-freeze protection	Restore the functions automatically once anti-freeze protection is over.
Water-full indicator lights	The water in chassis is full	Drain the water and re-start the unit

Appendix

Fuse parameters

Model: FSD or 50F

Voltage: 250V

Current: 3.15A

Schematic diagram of the air conditioner

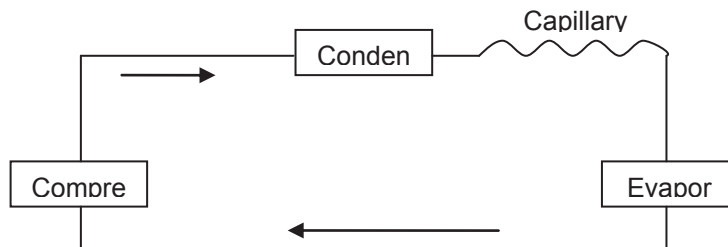

For specific technical parameters of the model, refer to rating label on the product.



Correct Disposal of this product

This marking indicates that the product should not be disposed with other household wastes throughout the world. To prevent possible harm to the environment or human health from uncontrolled waste disposal, recycle it responsibly to promote the sustainable reuse of material resources. To return your used device, please use the return and collection systems or contact the retailer where the product was purchased. They can take this product for environmental safe recycling.

WARRANTY PERIOD:

Labor: 1 Year from the Date of Purchase.

Parts: 1 Year from the Date of Purchase.

GLOBAL AIR SERVICE CENTER

1941 S.Vineyard Ave.Ste.6
Ontario.CA 91761
Tel : 909-391-7300

Hours: 8:30AM-5:00PM PST

TO OBTAIN WARRANTY SERVICE
Contact Global air Technical Support

Email:TechSupport@cchpliance.com
Phone: 888.470.7342

From 8:30AM to 5:00PM Monday through Friday Pacific Time.

Free Manuals Download Website

<http://myh66.com>

<http://usermanuals.us>

<http://www.somanuals.com>

<http://www.4manuals.cc>

<http://www.manual-lib.com>

<http://www.404manual.com>

<http://www.luxmanual.com>

<http://aubethermostatmanual.com>

Golf course search by state

<http://golfingnear.com>

Email search by domain

<http://emailbydomain.com>

Auto manuals search

<http://auto.somanuals.com>

TV manuals search

<http://tv.somanuals.com>