



- Copyright
- Safety information
- About this user's guide
- Features of your new product
- Introduction
- Getting started
- Network setup (Dell 1130n only)
- Basic setup
- Media and tray
- Printing
- Management tools
- Maintenance
- Troubleshooting
- Supplies
- Specifications
- Appendix
- Glossary

Dell 1130
Dell 1130n

User's Guide

www.dell.com | www.support.dell.com





- adjusting
- tray size
- booklet printing
- booklets
- change percentage of your document
- cleaning
 - inside
 - outside
 - cleaning a machine
- control panel
- convention
- duplex printing (manual)
- printer driver
 - Embedded Web Service
- general information
- favorites settings, for printing
- features
 - features
 - machine features
 - power saving feature
 - print media feature
- printer driver
 - supplied software
- font setting
- front view
- glossary
- jam
 - clearing paper
 - tips for avoiding paper jams
- Linux
 - common Linux problems
 - driver installation for network connected
 - driver installation for USB cable connected
- printer properties
- printing
 - supplied softwares
 - system requirements
 - unified driver configurator
- loading
 - paper in manual tray
 - paper in the tray1
- special media



Copyright

Information in this document is subject to change without notice.

©2010 Dell Inc. All rights reserved.

Reproduction of these materials in any manner whatsoever without the written permission of Dell Inc. is strictly forbidden.

Trademarks used in this text: *Dell*, the *DELL* logo, and *Dell Toner Management System* are trademarks of Dell Inc.; *Microsoft*, *Windows*, *Windows Vista*, and *Windows Server* are registered trademarks of Microsoft Corporation in the United States and/or other countries. *Adobe* and *Acrobat Reader* are either registered trademarks or trademarks of Adobe Systems Incorporated in the United States and/or other countries.

Other trademarks and trade names may be used in this document to refer to the entities claiming the marks and names of their products.

Dell Inc. disclaims any proprietary interest in trademarks and trade names other than its own.

Refer to the '**LICENSE.txt**' file in the provided CD-ROM for the open source license information.

REV. 1.00









Safety information

These warnings and precautions are included in order to prevent injury to you and others, as well as preventing any potential damage to your machine. Be sure to read and understand all of these instructions before using the machine. Use common sense for operating any electrical appliance and whenever using your machine. Also, follow all warnings and instructions marked on the machine and in the accompanying literature. After reading this section, keep it in a safe place for future reference.

Important safety symbols

This section explains the meanings of all icons and signs in the user's guide. These safety symbols are in order, according to the degree of danger.

Explanation of all icons and signs used in the user's guide:

	Warning	Hazards or unsafe practices that may result in severe personal injury or death.
	Caution	Hazards or unsafe practices that may result in minor personal injury or property damage.
	Do not attempt.	
	Do not disassemble.	
	Do not touch.	
	Unplug the power cord from the wall socket.	
	Make sure the machine is grounded to prevent electric shock.	
	Call the service center for help.	
	Follow directions explicitly.	

Operating environment

Warning



Do not use if the power cord is damaged or if the electrical outlet is not grounded. This could result in electric shock or fire.



Do not bend, or place heavy objects on the power cord. Stepping on or allowing the power cord to be crushed by a heavy object could result in electric shock or fire.



Do not place anything on top of the machine (water, small metal or heavy objects, candles, lit cigarettes, etc.). This could result in electric shock or fire.



Do not remove the plug by pulling on the cord; do not handle the plug with wet hands. This could result in electric shock or fire.

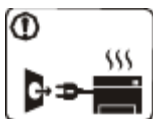

If the machine gets overheated, it releases smoke, makes strange noises, or generates an odd odor, immediately turn off the power switch and unplug the machine. This could result in electric shock or fire.

Caution

During an electrical storm or for a period of non-operation, remove the power plug from the electrical outlet.  If the plug does not easily enter the electrical outlet, do not attempt to force it in.



This could result in electric shock or fire.

⊘ Be careful, the paper output area is hot. Burns could occur.

ⓘ If the machine has been dropped, or if the cabinet appears damaged, unplug the machine from all interface connections and request assistance from qualified service personnel.

Otherwise, this could result in electric shock or fire.

ⓘ If the machine exhibits a sudden and distinct change in performance, unplug the machine from all interface connections and request assistance from qualified service personnel.

Otherwise, this could result in electric shock or fire.

Call an electrician to change the electrical outlet, or this could result in electric shock.

⊘ Do not allow pets to chew on the AC power, telephone or PC interface cords.

This could result in electric shock or fire and/or injury to your pet.

ⓘ If the machine does not operate properly after these instructions have been followed, unplug the machine from all interface connections and request assistance from qualified service personnel.

Otherwise, this could result in electric shock or fire.

Operating method

⚠ Caution



Do not forcefully pull the paper out during printing. It can cause damage to the machine.



Be careful not to put your hand between the machine and paper tray. You may get injured.

⊘ Do not block or push objects into the ventilation opening.

This could result in elevated component temperatures which can cause damage or fire.

⊘ Use care to avoid paper cuts when replacing paper or removing jammed paper. You may get hurt.



When printing large quantities, the bottom part of the paper output area may get hot. Do not allow children to touch.

Children may be burned.



When removing jammed paper, do not use tweezers or sharp metal objects. It can cause damage to the machine.

⊘ Do not allow too many papers to stack up in the paper output tray. It could cause damage to the machine.

⊘ This machine's power interception device is the power cord. To switch off the power supply, remove the power cord from the electrical outlet.

Installation / Moving

⚠ Warning



Do not place the machine in an area with dust, humidity or water leaks. This could result in electric shock or fire.

⚠ Caution



When moving the machine, turn the power off and disconnect all cords; then lift the machine with at least two people.

The machine could fall, causing human injury or machine damage.

ⓘ Do not place the machine on an unstable surface.

⊘ Do not put a cover over the machine or place it in an airtight location, such as a closet.

If the machine is not well-ventilated, this could result in fire.

ⓘ Make sure you plug the power cord into a grounded electrical outlet. Otherwise, this could result in electric shock or fire.

The machine could fall, causing human injury or machine damage.

⊗ The machine should be connected to the power level which is specified on the label. If you are unsure and want to check the power level you are using, contact the electrical utility company.

ⓘ Use only No.26 AWG^[a] or larger, telephone line cord, if necessary.

Otherwise, it can cause damage to the machine.

^[a] AWG: American Wire Gauge

⊗ Do not overload wall outlets and extension cords.

This can diminish performance, and could result in electric shock or fire.

ⓘ Use the power cord supplied with your machine for safe operation. If you are using a cord which is longer than 2 meters (79") with a 140V machine, then the gauge should be 16 AWG or larger.

Otherwise, it can cause damage to the machine, and could result in electric shock or fire.

Maintenance / Checking

⚠ Caution



Unplug this product from the wall outlet before cleaning the inside of the machine. Do not clean the machine with benzene, paint thinner or alcohol; do not spray water directly into the machine.

This could result in electric shock or fire.



When you are working inside the machine replacing supplies or cleaning the inside, do not operate the machine.

You may get injured.



Keep cleaning supplies away from children.

Children may get hurt.



Do not disassemble, repair or rebuild the machine by yourself.

It can cause damage to the machine. Call a certified technician when the machine needs repair.

ⓘ Keep the power cable and the contact surface of the plug clean from dust or water.

This could result in electric shock or fire.

ⓘ To clean and operate the machine, strictly follow the user's guide provided with the machine.

Otherwise, it can cause damage to the machine.

⊗ Do not remove any covers or guards that are fastened with screws.

The machine should only be repaired by Dell service technician.

Supply usage

⚠ Caution



Do not disassemble the toner cartridge. Toner dust can be dangerous to humans.



Do not burn any of the supplies such as toner cartridge or fuser unit.

It can cause an explosion or fire.



When storing supplies such as toner cartridges, keep them away from children.

Toner dust can be dangerous to humans.

⊗ Using recycled supplies, such as toner, can cause damage to the machine.

In case of damage due to the use of recycled supplies, a service fee will be charged.

ⓘ When changing the toner cartridge or removing jammed paper, be careful not to let toner dust touch your body or clothes.

Toner dust can be dangerous to humans.

About this user's guide

This user's guide provides information about basic understanding of the machine as well as detailed explanation on each step during actual usage.





- Read the safety information before using the machine.
- If you have a problem using the machine, refer to the troubleshooting chapter. (See [Troubleshooting.](#))
- Terms used in this user's guide are explained in the glossary chapter. (See [Glossary.](#))
- All illustrations in this user's guide may differ from your machine depending on its options or models.
- The procedures in this user's guide are mainly based on Windows XP.

Convention

Some terms in this guide are used interchangeably, as below:



- Document is synonymous with original.
- Paper is synonymous with media, or print media.
- Machine refers to printer or MFP.

The following table offers the conventions of this guide:

Convention	Description	Example
Bold	For texts on the display or button names on the machine.	Cancel
Note	Provides additional information or detailed specification of the machine function and feature.	 The date format may differ from country to country.
Caution	Gives users information to protect the machine from possible mechanical damage or malfunction.	 Do not touch the green underside of the toner cartridge.
Footnote	Provides additional more detailed information on certain words or a phrase.	a. pages per minute
("Cross-reference")	Guides users to a reference page for the additional detailed information.	(See Finding more information.)

Finding more information

You can find information for setting up and using your machine from the following resources, either as a print-out or on screen.

Material name	Description
Quick Install Guide 	This guide provides information on setting up your machine and this requires that you follow the instructions in the guide to prepare the machine.
User's Guide 	This guide provides you with step-by-step instructions for using your machine's full features, and contains information for maintaining your machine, troubleshooting and replacing supplies.
Printer	This help provides you with help information on printer driver and instructions for setting up the options for

Driver Help	printing. (See Using help.)
Dell website	If you have Internet access, you can get help, support, printer drivers, manuals, and order information from the Dell websites www.dell.com or support.dell.com .

Features of your new product

Your new machine is equipped with a number of special features that improve the quality of the documents you print.

Special Features

Print with excellent quality and speed



- You can print with a resolution of up to 1,200 x 600 dpi (Dell 1130) and up to 1,200 x 1,200 dpi (Dell 1130n) effective output.
- Dell 1130 prints up to 18 ppm, A4-sized paper or up to 19 ppm, letter sized paper. Dell 1130n prints up to 24 ppm, A4-sized paper and letter-sized paper.

Handle many different types of printable material

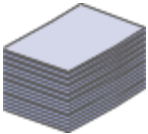

- Manual tray supports plain paper in various sizes, letterhead, envelopes, labels, custom-sized media, postcards, and heavy paper.
- The 250-sheet tray supports plain paper.

Create professional documents

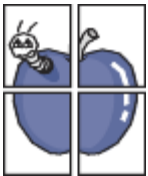

- Print Watermarks. You can customize your documents with words, such as “Confidential”. (See [Using watermarks](#).)
- Print Posters. The text and pictures of each page of your document are magnified and printed across the sheet of paper and can then be taped together to form a poster. (See [Printing posters](#).)
- You can use preprinted forms and letterhead with plain paper. (See [Using overlay](#).)

Save time and money



- To save paper, you can print multiple pages on one single sheet of paper. (See [Printing multiple pages on one sheet of paper](#).)
- This machine automatically conserves electricity by substantially reducing power consumption when not in use.
- To save paper, you can print on both sides of the paper (Manual). (See [Printing on both sides of paper \(Manual\)](#).)

Print in various environments



- You can print with Windows as well as Linux and Macintosh systems.
- Your machine is equipped with a USB interface.
- The Dell 1130n comes with a built-in Network interface, 10/100 BaseTX.

IPv6

This machine supports IPv6 (Dell 1130n only).



Features by Models

The machine is designed to support all of your document needs from printing to more advanced networking solutions for your business.

Features by models include:

FEATURES	Dell 1130	Dell 1130n
Hi-Speed USB 2.0	• [a]	•
Network Interface Ethernet 10/100 BaseTX wired LAN		•
Duplex (2-sided) printing (Manual)	•	•
[a] USB 1.1		

(•: Included, Blank: Not available)

Introduction

This chapter gives you an overview of your machine:

This chapter includes:

- [Machine overview](#)
- [Control panel overview](#)
- [Understanding the control panel](#)

Machine overview

Front view

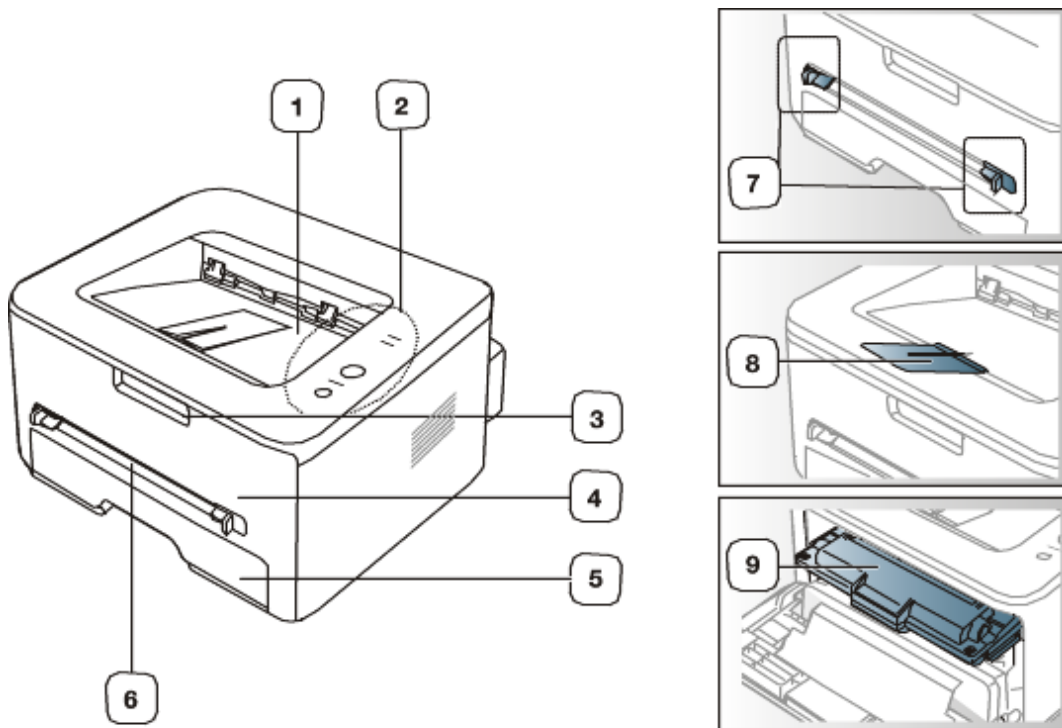

This illustration may differ from your machine depending on its model.

1	Document output tray	6	Manual feeder
2	Control panel	7	Manual feeder guide
3	Front cover handle	8	Output support
4	Front cover	9	Toner cartridge
5	Tray 1		

Rear view

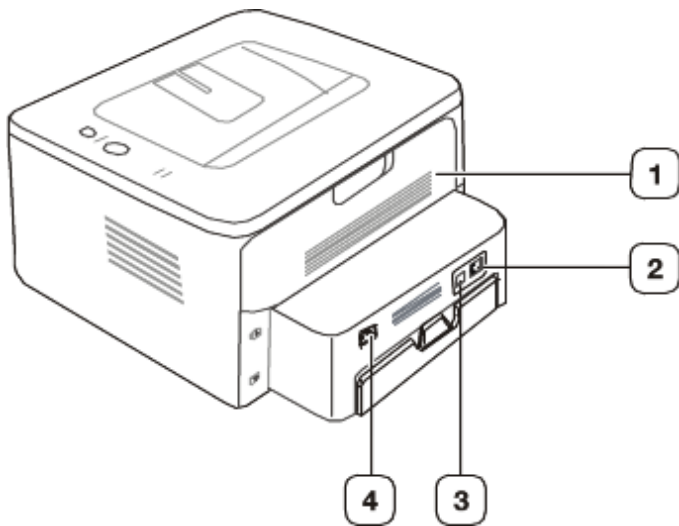

This illustration may differ from your machine depending on its model.

1	Rear cover	3	USB port
2	Network Port ^[a]	4	Power receptacle
[a] Dell 1130n only.			

Control panel overview

This control panel may differ from your machine depending on its model.

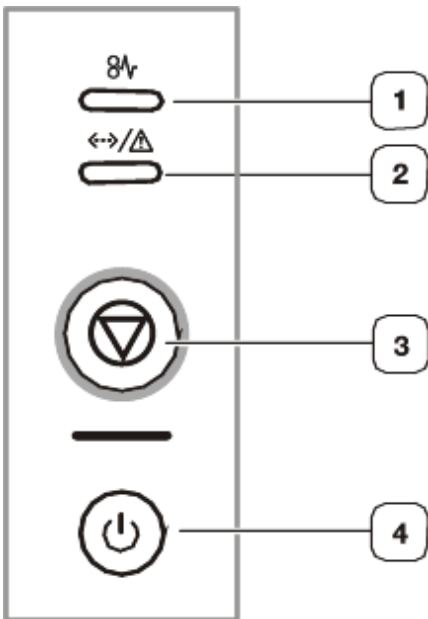

1		Jam	Shows the status of jam occurrence of your machine. (See LEDs .)
2		Online/Error	Shows the status of your machine. (See LEDs .)
3		Cancel	Stops an operation at any time. Also there are more functions. (See Understanding the control panel .)
4		Power	Turns power on or off. (See Understanding the control panel .)

Understanding the control panel

LEDs

The color of the LEDs indicates the machine's current status.



LED	Status		Description
Jam (Jam)	Orange	On	A paper jam has occurred. (See Clearing paper jams.)
Online/Error (↔/△)	Off		<ul style="list-style-type: none"> The machine is off-line.
	Green	On	<ul style="list-style-type: none"> The machine is in power saver mode. The machine is on-line and can receive data from the computer.
		Blinking	<ul style="list-style-type: none"> When the LED blinks slowly, the machine is receiving data from the computer. When the LED blinks rapidly, the machine is printing data.
	Red	On	<ul style="list-style-type: none"> The cover is open. Close the cover. There is no paper in the tray. Load paper in the tray. The machine has stopped due to a major error. Your system has some problems. If this problem occurs, contact your service representative. The toner cartridge has almost reached its estimated cartridge life^[a]. It is recommended to replace the toner cartridge. (See Replacing the toner cartridge.)
Blinking		<ul style="list-style-type: none"> A minor error has occurred and the machine is waiting for the error to be cleared. When the problem is cleared, the machine resumes. Toner is low. Replace the cartridge. The estimated cartridge life^[a] of toner is close. Prepare a new cartridge for replacement. You may temporarily increase the printing quality by redistributing the toner. (See Redistributing toner.) 	

[a] Estimated cartridge life means the expected or estimated toner cartridge life, which indicates the average capacity of print-outs and is designed pursuant to ISO/IEC 19752. The number of pages may be affected by operating environment, printing interval, media type, and media size. Some amount of toner may remain in the cartridge even when red LED turned on and the printer stops printing.



 Dell does not recommend using non-genuine Dell toner cartridge such as refilled or re-manufactured. Dell cannot guarantee non-genuine Dell toner cartridge's quality. Service or repair required as a result of using non-genuine Dell toner cartridges will not be covered under the machine warranty.

 All printing errors will be appear in the Printer Status Monitor program window. If the problem persists, call for service.

Buttons

(Cancel button)

By pressing the  (cancel button), you can:

Function	Description
Printing demo page ^[a]	In Ready mode, press and hold this button for about 2 seconds until the status LED blinks slowly, and release. (See Printing a demo page.)
Printing configuration sheet ^[b]	In Ready mode, press and hold this button for about 5 seconds until the status LED blinks fast, and release. (See Printing a machine report.)
Printing a cleaning sheet ^[b]	In Ready mode, press and hold this button for about 10 seconds until the status LED blinks slowly, and release. (See Cleaning the inside.)
Cancel print job	Press  (cancel button) during printing. The red LED blinks while the print job is cleared from both the machine and the computer and then the machine returns to ready mode. This may take some time depending on the size of the print job.
Manual print	Press  (cancel button) each time you load a sheet of paper in the manual tray when you select Manual Feeder for Source from your software application.

[a] When you print the demo page for Dell 1130, configuration sheet is printed as well.

[b] Dell 1130n only

(Power button)

This button must be used to turn the machine on/off.

Turning on the machine

1. Plug in the power cord.
2. Press  (power) on the control panel.

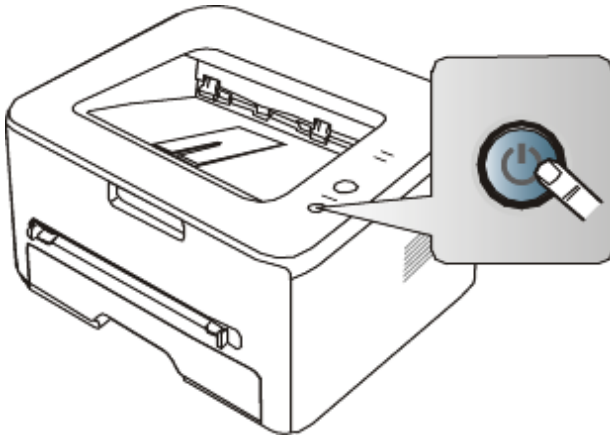

 If you want to turn the power off, press and hold this button for 1 second.

Getting started

This chapter gives you step-by-step instructions for setting up the USB connected machine and software.

This chapter includes:

- [Setting up the hardware](#)
- [Printing a demo page](#)
- [Supplied software](#)
- [System requirements](#)
- [Installing USB connected machine's driver](#)
- [Sharing your machine locally](#)

Setting up the hardware

This section shows the steps to set up the hardware, as is explained in the Quick Install Guide. Make sure you read the Quick Install Guide first and follow the steps below:

Location

1. Select a stable location.

Select a level, stable place with adequate space for air circulation. Allow extra space to open covers and trays.

The area should be well ventilated and away from direct sunlight or sources of heat, cold, and humidity. Do not set the machine close to the edge of your desk or table.

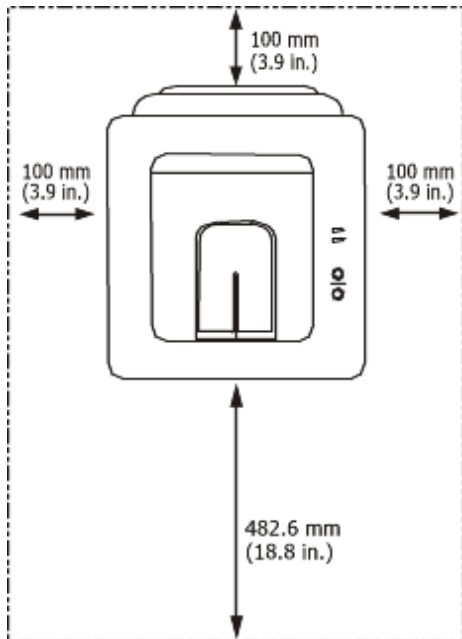

Printing is suitable for altitudes under 1,000 m (3,281 ft). Refer to the altitude setting to optimize your printing. (See [Altitude adjustment](#).)

Place the machine on a flat, stable surface so that there is no incline greater than 2 mm (0.08 inch). Otherwise, printing quality may be affected.

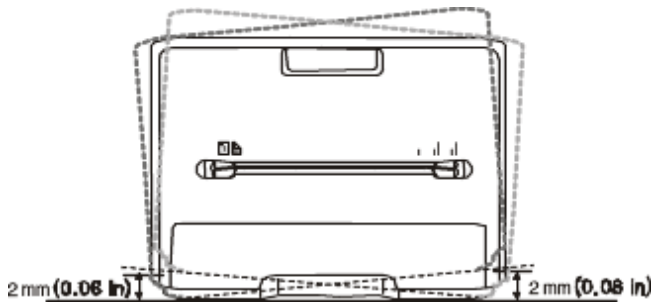

2. Unpack the machine and check all the enclosed items.
3. Remove tape holding the machine.
4. Install the toner cartridge.
5. Load paper. (See [Loading paper in the tray.](#))
6. Make sure that all cables are connected to the machine.
7. Turn the machine on. (See [Turning on the machine.](#))

! This equipment will be inoperable when mains power fails.

Printing a demo page

Print a demo page to make sure that the machine is operating correctly.

To print a demo page:

In ready mode, press and hold the  (cancel button) for about 2 seconds.

Supplied software

After you have set up your machine and connected it to your computer, you must install the printer software using the supplied CD. The software CD provides you with the following software.

OS	Contents
Windows	<ul style="list-style-type: none"> • Printer driver: Use this driver to take full advantage of your machine's features. • Printer Status Monitor: This program allows you to monitor the machine's status and alerts you when an error occurs during printing. • Printer Settings Utility (Dell 1130n only): This program allows you to set up printer's other options from your computer desktop. • Dell Toner Management System™: Displays the status of the printer and the name of the job when send a job to print. The Dell Toner Management System™ window also displays the level of toner remaining and allows you to order replacement toner cartridge. • Firmware Update Utility: This program helps you to update printer's firmware. • SetIP (Dell 1130n only): Use this program to set your machine's TCP/IP addresses.
Macintosh	<ul style="list-style-type: none"> • Printer Driver: Use this driver to take full advantage of your machine's features.
Linux	<ul style="list-style-type: none"> • Unified Linux Driver: Use this driver to take full advantage of your machine's features.

System requirements

Before you begin, ensure that your system meets the following requirements:

Microsoft® Windows®

Your machine supports the following Windows operating systems.

OPERATING SYSTEM	Requirement (recommended)		
	CPU	RAM	free HDD space
Windows 2000	Intel® Pentium® II 400 MHz (Pentium III 933 MHz)	64 MB (128	600 MB

		MB)	
Windows XP	Intel® Pentium® III 933 MHz (Pentium IV 1 GHz)	128 MB (256 MB)	1.5 GB
Windows Server® 2003	Intel® Pentium® III 933 MHz (Pentium IV 1 GHz)	128 MB (512 MB)	1.25 GB to 2 GB
Windows Server 2008	Intel® Pentium® IV 1 GHz (Pentium IV 2 GHz)	512 MB (2048 MB)	10 GB
Windows Vista®	Intel® Pentium® IV 3 GHz	512 MB (1024 MB)	15 GB
Windows 7	Intel® Pentium® IV 1 GHz 32-bit or 64-bit processor or higher	1 GB (2 GB)	16 GB
	<ul style="list-style-type: none"> • Support for DirectX® 9 graphics with 128 MB memory (to enable the Aero theme). • DVD-R/W Drive 		
Windows Server 2008 R2	Intel® Pentium® IV 1 GHz (x86) or 1.4 GHz (x64) processors (2 GHz or faster)	512 MB (2048 MB)	10 GB

- Internet Explorer® 5.0 or higher is the minimum requirement for all Windows operating systems.
- Administrator rights are required to install the software.
- **Windows Terminal Services** is compatible with this machine.

Macintosh

OPERATING SYSTEM	Requirements (recommended)		
	CPU	RAM	free HDD space
Mac OS X 10.3 ~ 10.4	<ul style="list-style-type: none"> • Intel Processors • PowerPC G4/ G5 	<ul style="list-style-type: none"> • 128 MB for a PowerPC based Mac (512 MB) • 512 MB for a Intel-based Mac (1 GB) 	1 GB
Mac OS X 10.5	<ul style="list-style-type: none"> • Intel Processors • 867 MHz or faster Power PC G4/ G5 	512 MB (1 GB)	1 GB
Mac OS X 10.6	<ul style="list-style-type: none"> • Intel Processors 	1 GB (2 GB)	1 GB

Linux

Item	Requirement (recommended)
Operating system	RedHat Enterprise Linux WS 4, 5 (32/64 bit) Fedora Core 2~10 (32/64 bit) SuSE Linux 9.1 (32 bit) OpenSuSE 9.2, 9.3, 10.0, 10.1, 10.2, 10.3, 11.0, 11.1 (32/64 bit) Mandrake 10.0, 10.1 (32/64 bit) Mandriva 2005, 2006, 2007, 2008, 2009 (32/64 bit) Ubuntu 6.06, 6.10, 7.04, 7.10, 8.04, 8.10 (32/64 bit) SuSE Linux Enterprise Desktop 9, 10 (32/64 bit) Debian 3.1, 4.0, 5.0 (32/64 bit)
CPU	Pentium IV 2.4 GHz (Intel Core™2)
RAM	512 MB (1024 MB)
Free HDD space	1 GB (2 GB)

Installing USB connected machine's driver

A locally connected machine is a machine directly attached to your computer using the USB cable. If your machine is attached to a network, skip the following steps below and go on to installing network connected machine's driver. (See [Installing network connected machine's driver.](#))

 Only use an USB cable shorter than 3 m (118 in.).

Windows

You can install the machine software using the typical or custom method.

The following steps below are recommended for most users who use a machine directly connected to your computer. All components necessary for machine operations will be installed.

1. Make sure that the machine is connected to the computer and powered on.

 If the “**Found New Hardware Wizard**” window appears during the installation procedure, click **Cancel** in close the window.

2. Insert the supplied software CD into your CD/DVD drive.

- The software CD should automatically run and an installation window should appear.
- If the installation window does not appear, click **Start** and then **Run**. Type X:**Setup.exe**, replacing “X” with the letter which represents your CD/DVD drive. Click **OK**.
- If you use Windows Vista, Windows 7 and Windows 2008 Server R2 click **Start** > **All programs** > **Accessories** > **Run**.
Type X:**Setup.exe** replacing “X” with the letter which represents your CD/DVD drive and click **OK**.
- If the **AutoPlay** window appears in Windows Vista, Windows 7 and Windows 2008 Server R2, click **Run Setup.exe** in **Install or run program** field, and click **Continue** or **Yes** in the **User Account Control** windows.

3. Click **Next**.

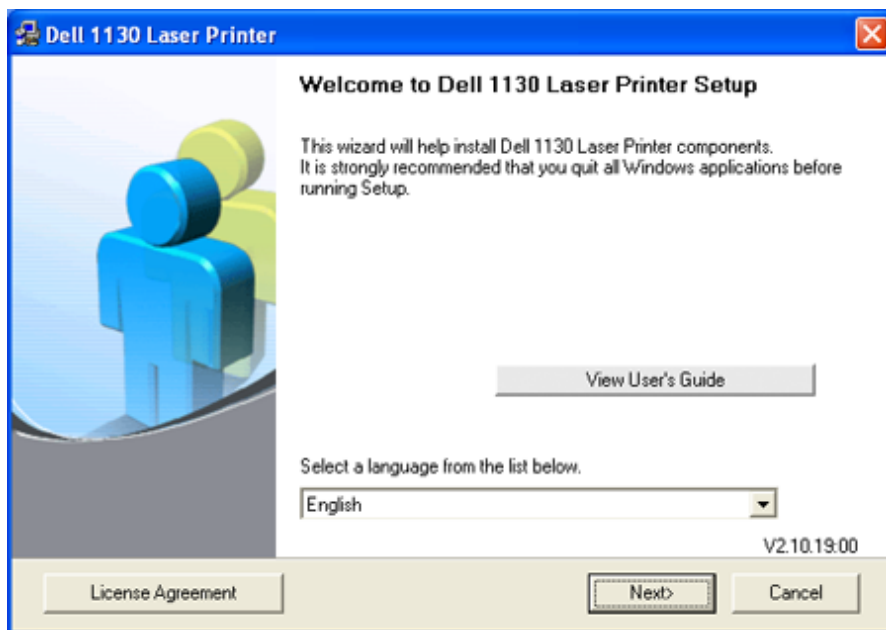

If necessary, select a language from the drop-down list.

4. Select **Typical** installation for a local printer. Then, click **Next**.

 The Custom allows you to select the machine's connection and choose individual component to install. Follow the on-screen instructions.

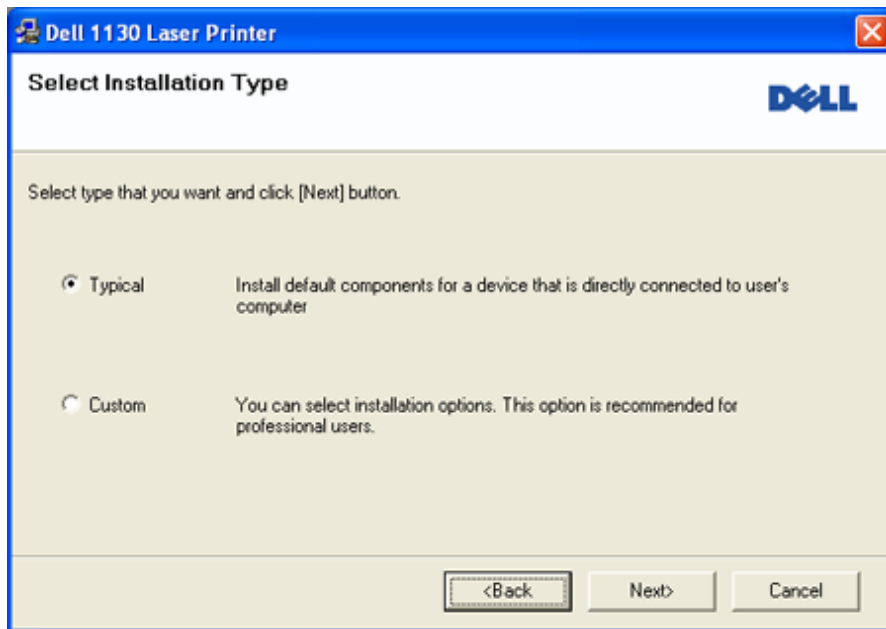

If your machine is not connected to the computer, the following window will appear.

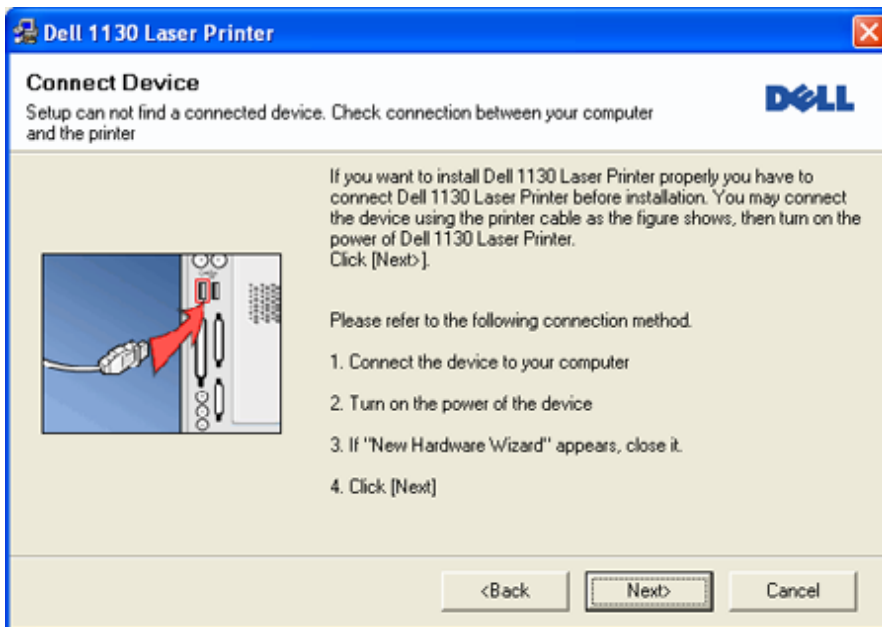

- After connecting the machine, click **Next**.
 - If you don't want to connect the printer at this time, click **Next**, and **No** on the following screen. The installation starts and a test page will not print at the end of the installation.
 - The installation window in this user guide may differ depending on the machine and interface in use.
5. After the installation is finished, a window asking you to print a test page appears. If you choose to print a test page, select the checkbox and click **Next**. Otherwise, just click **Next** and skip to step 7.
 6. If the test page prints out correctly, click **Yes**.
If not, click **No** to reprint it.
 7. Click **Finish**.

If the printer driver does not work properly, follow the steps below to repair or reinstall the driver.

1. Make sure that the machine is connected to your machine and powered on.
2. From the **Start** menu, select **Programs** or **All Programs** > **Dell** > **Dell Printers** > **your printer driver name** > **Maintenance**.
3. Select the option as you wish, follow the instruction on the window.

Macintosh

The software CD that came with your machine provides you with the PPD file that allows you to use the CUPS driver or

Apple LaserWriter driver (only available when you use a machine which supports the PostScript driver) for printing on a Macintosh computer.

1. Make sure that the machine is connected to your computer and powered on.
2. Insert the supplied software CD into your CD/DVD drive.
3. Double-click the CD-ROM icon that appears on your Macintosh desktop.
4. Double-click the **MAC_Installer** folder.
5. Double-click the **Installer OS X** icon.
6. Enter the password and click **OK**.
7. The Dell Installer window opens. Click **Continue**.
8. Select **Easy Install** and click **Install**. **Easy Install** is recommended for most users. All components necessary for machine operations will be installed.
If you select **Custom Install**, you can choose individual components to install.
9. When the message which warns that all applications will close on your computer appears, click **Continue**.
10. After the installation is finished, click **Quit**.
11. Open the **Applications** folder > **Utilities** > **Print Setup Utility**.
 - For Mac OS X 10.5~10.6, open the **Applications** folder > **System Preferences** and click **Print & Fax**.
12. Click **Add** on the **Printer List**.
 - For Mac OS X 10.5~10.6, click the "+" icon; a display window will pop up.
13. For Mac OS X 10.3, select the **USB** tab.
 - For Mac OS X10.4, click **Default Browser** and find the USB connection.
 - For Mac OS X 10.5~10.6, click **Default** and find the USB connection.
14. For Mac OS X 10.3, if Auto Select does not work properly, select **Dell** in **Printer Model** and your machine name in **Model Name**.
 - For Mac OS X 10.4, if Auto Select does not work properly, select **Dell** in **Print Using** and your machine name in **Model**.
 - For Mac OS X 10.5~10.6, if Auto Select does not work properly, select **Select a driver to use...** and your machine name in **Print Using**.

Your machine appears on the **Printer List**, and is set as the default machine.

15. Click **Add**.



If the printer driver does not work properly, uninstall the driver and reinstall it.

Follow steps below to uninstall the driver for Macintosh.

1. Make sure that the machine is connected to your computer and powered on.
2. Insert the supplied software CD into your CD/DVD drive.
3. Double-click CD-ROM icon that appears on your Macintosh desktop.
4. Double-click the **MAC_Installer** folder.
5. Double-click the **Installer OS X** icon.
6. Enter the password and click **OK**.
7. The Dell Installer window opens. Click **Continue**.
8. Select **Uninstall** and click **Uninstall**.
9. When the message which warns that all applications will close on your computer appears, Click **Continue**.
10. When the uninstall is done, click **Quit**.

Linux

Follow the steps below to install the driver for Linux. While installing the driver, the Unified Linux Driver package will automatically be installed as well.



The supplied software CD provides you with the Unified Linux Driver package for using your machine with a Linux computer easily in UI based management tool. (See [Using the Unified Linux Driver Configurator](#).)

1. Make sure that the machine is connected to your computer and powered on.
2. When the **Administrator Login** window appears, type in root in the **Login** field and enter the system password.



You must log in as a super user (root) to install the machine software. If you are not a super user, ask your system administrator.

3. Insert the supplied software CD into your CD/DVD drive.

The software CD will run automatically.

If the software CD does not run automatically, click the  icon at the bottom of the desktop. When the Terminal screen appears, type in the following:

If the software CD is secondary master and the location to mount is /mnt/cdrom,

```
[root@localhost root]#mount -t iso9660 /dev/hdc /mnt/cdrom
```

```
[root@localhost root]#cd /mnt/cdrom/Linux
```

```
[root@localhost Linux]#./install.sh
```

If you still failed to run the software CD type the followings in sequence:

```
[root@localhost root]#umount /dev/hdc
```

```
[root@localhost root]#mount -t iso9660 /dev/hdc /mnt/cdrom
```

 The installation program runs automatically if you have an autorun software package installed and configured.

4. When the welcome screen appears, click **Next**.

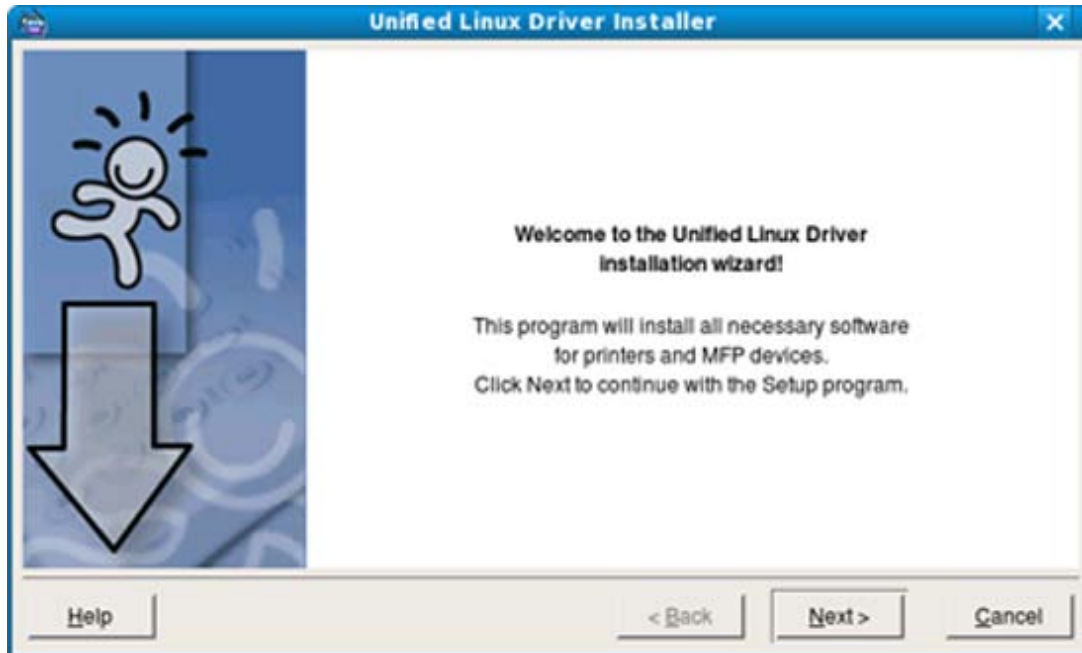

5. When the installation is complete, click **Finish**.

The installation program has added the Unified Driver Configurator desktop icon and the Unified Driver group to the system menu for your convenience. If you have any difficulties, consult the on screen help that is available through your system menu or can otherwise be called from the driver package Windows applications, such as **Unified Driver Configurator** or **Image Manager**.

-  Installing the driver in the text mode:
- If you do not use the graphical interface or have been unable to install the driver, you have to use the driver in the text mode.
 - Follow the steps 1 to 3, then type `[root@localhost Linux]# ./install.sh`. Follow the instructions on the terminal screen. The installation is completed.
 - When you want to uninstall the driver, follow the installation instructions above, but type `[root@localhost Linux]# ./uninstall.sh` on the terminal screen.

-  If the printer driver does not work properly, uninstall the driver and reinstall it. Follow the steps below steps to uninstall the driver for Linux.

1. Make sure that the machine is connected to your computer and powered on.
2. When the **Administrator Login** window appears, type in "root" in the **Login** field and enter the system password.
You must log in as a super user (root) to uninstall the printer driver. If you are not a super user, ask your system administrator.
3. Insert the supplied software CD into your CD/DVD drive.
The software CD will run automatically.
If the software CD does not run automatically, click the  icon at the bottom of the desktop. When the Terminal screen appears, type in:

```

If the software CD is secondary master and the location to mount is /mnt/cdrom,
[root@localhost root]#mount -t iso9660 /dev/hdc /mnt/cdrom
[root@localhost root]#cd /mnt/cdrom/Linux
[root@localhost Linux]#./uninstall.sh

```

The installation program runs automatically if you have an autorun software package installed and configured.

4. Click **Uninstall**.
5. Click **Next**.
6. Click **Finish**.

Sharing your machine locally

Follow the steps below to set up the computers to share your machine locally.

If the Host computer is directly connected to the machine with USB cable and is also connected to the local network environment, the client computer connected to the local network can use the shared machine through the host computer to print.

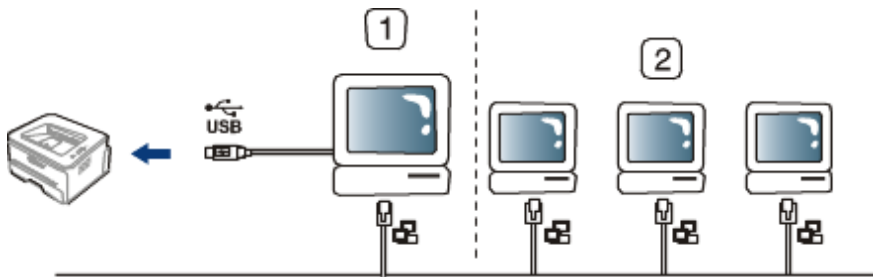

1	Host computer	A computer which is directly connected to the machine by USB cable.
2	Client computers	Computers which use the machine shared through the host computer.

Windows

Setting up a host computer

1. Install your printer driver. (See [Installing USB connected machine's driver](#), [Installing network connected machine's driver](#).)
2. Click the Windows **Start** menu.
3. For Windows 2000, select **Settings > Printers**.
 - For Windows XP/Server 2003, select **Printers and Faxes**.
 - For Windows Server 2008/Vista, select **Control Panel > Hardware and Sound > Printers**.
 - For Windows 7, select **Control Panel > Hardware and Sound > Devices and Printers**.
 - For Windows Server 2008 R2, select **Control Panel > Hardware > Devices and Printers**.
4. Right click your printer icon.
5. For Windows XP/Server 2003/ Server 2008/Vista, press **Properties**.
For Windows 7 and Windows Server 2008 R2, from context menus, select the **Printer properties**.

 If **Printer properties** item has ► mark, you can select other printer drivers connected with selected printer.

6. Select the **Sharing** tab.
7. Check the **Change Sharing Options**.
8. Check the **Share this printer**.
9. Fill in the **Share Name** field. Click **OK**.

Setting up a client computer

1. Install your printer driver. (See [Installing USB connected machine's driver](#), [Installing network connected machine's driver](#).)
2. Click the Windows **Start** menu.
3. Select **All programs > Accessories > Windows Explorer**.
4. Enter the IP address of the host computer in the address bar and press Enter in your keyboard.



 In case host computer requires **User name** and **Password**, fill in User ID and password of the host computer account.

5. Right click the printer icon you want to share and select **Connect**.
6. If a set up complete message appears, click **OK**.
7. Open the file you want to print and start printing.

Macintosh

 The following steps are for Mac OS X 10.5~10.6. Refer to Mac Help for other OS versions.

Setting up a host computer

1. Install your printer driver. (See [Macintosh](#).)
2. Open the **Applications** folder > **System Preferences** and click **Print & Fax**.
3. Select the printer to share in the **Printers list**.
4. Select **Share this printer**.

Setting up a client computer

1. Install your printer driver. (See [Macintosh](#).)
2. Open the **Applications** folder > **System Preferences** and click **Print & Fax**.
3. Click the "+" icon.
A display window showing the name of your shared printer appears.
4. Select your machine and click **Add**.

Network setup (Dell 1130n only)

This chapter gives you step-by-step instructions for setting up the network connected machine and software.

This chapter includes:

- [Network environment](#)
- [Introducing useful network programs](#)
- [Using a wired network](#)
- [Installing network connected machine's driver](#)
- [IPv6 Configuration](#)

Network environment

You need to set up the network protocols on the machine to use it as your network machine.

The following table shows the network environments supported by the machine:

Item	Requirements
Network interface	Ethernet 10/100 Base-TX
Network operating system	<ul style="list-style-type: none">• Windows 2000/XP/Server 2003/Server 2008/Vista/7/2008 Server R2• Various Linux OS• Mac OS X 10.3 ~ 10.6
Network protocols	<ul style="list-style-type: none">• TCP/IPv4• DHCP, BOOTP• DNS, WINS, Bonjour, SLP, UPnP• Standard TCP/IP Printing (RAW), LPR, IPP• SNMPv 1/2/3, HTTP, IPSec• TCP/IPv6 (DHCP, DNS, RAW, LPR, SNMPv 1/2/3, HTTP, IPSec (See IPv6 Configuration.)

Introducing useful network programs

There are several programs available to setup the network settings in network environment.

 Before using the programs below, set the IP address first.

Embedded Web Service

Web server embedded on your network machine, which allows you to:

- Configure the network parameters necessary for the machine to connect to various network environments.
- Customize machine settings.

(See [Using Embedded Web Service \(Dell 1130n only\)](#).)

SetIP

This utility program allows you to select a network interface and manually configure the IP addresses for use with the TCP/IP protocol. (See [IP setting using SetIP Program](#))

 TCP/IPv6 is not supported by this program.

Using a wired network

You must set up the network protocols on your machine to use it on your network. This chapter will show you how this is accomplished.

You can use network after connecting network cable to a corresponding port on your machine.

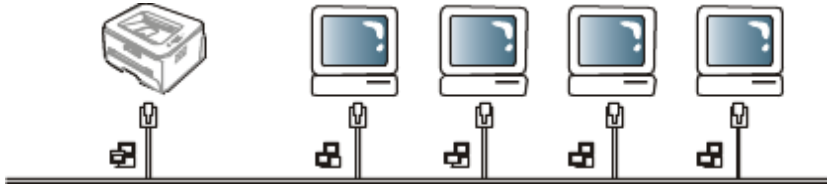

Printing network configuration report

You can print a **Network Configuration Report** from the machine's control panel that will show the current machine's network settings. This will help you to set up a network and troubleshooting problems.

To print the report:

In ready mode, press and hold the  (cancel button) for about 5 seconds. You can find your machine's MAC address and IP address.

For example:

- MAC Address : 00:15:99:41:A2:78
- IP Address : 192.0.0.192

Setting IP address

Firstly, you have to set up an IP address for network printing and managements. In most cases a new IP address will be automatically assigned by a DHCP (Dynamic Host Configuration Protocol) server located on the network.

In a few situations the IP address must be set manually. This is called a static IP and is often required in corporate Intranets for security reasons.

- **DHCP IP assignment:** Connect your machine to the network, and wait a few minutes for the DHCP server to assign an IP address to the machine. Then, print the **Network Configuration Report** as explained above. If the report shows that the IP address has changed, the assignment was successful. You will see the new IP address in the report.
- **Static IP assignment:** Use SetIP program to change the IP address from your computer.

In an office environment, we recommend that you contact a network administrator to set this address for you.

IP setting using SetIP Program

This program is for manually setting the network IP address of your machine using its MAC address to communicate with the machine. A MAC address is the hardware serial number of the network interface and can be found in the **Network Configuration Report**.

For using SetIP program, disable the computer firewall before continuing by performing the following:

1. Open **Start > All programs > Control Panel**.
2. Double click **Security Center**.
3. Click **Windows Firewall**.
4. Disable the firewall.

Installing the program

1. Insert the supplied software CD provided with your machine. When the driver CD runs automatically, close that window.
2. Start Windows Explorer and open the X drive. (X represents your CD/DVD drive.)
3. Double-click **Application > SetIP**.
4. Double-click **Setup.exe** to install this program.
5. Click **OK**. If necessary, select a language from the drop-down list.
6. Follow the instructions in the window and complete the installation.

Starting the program

1. Connect your machine to the network with a network cable.
2. Turned on the machine.
3. From the Windows **Start** menu, select **All Programs > Dell Printers > SetIP > SetIP**.
4. Click on the  icon (third from left) in the SetIP window to open the TCP/IP configuration window.

5. Enter the machine's new information into the configuration window as follows. In a corporate intranet, you may need to have this information assigned by a network manager before proceeding.

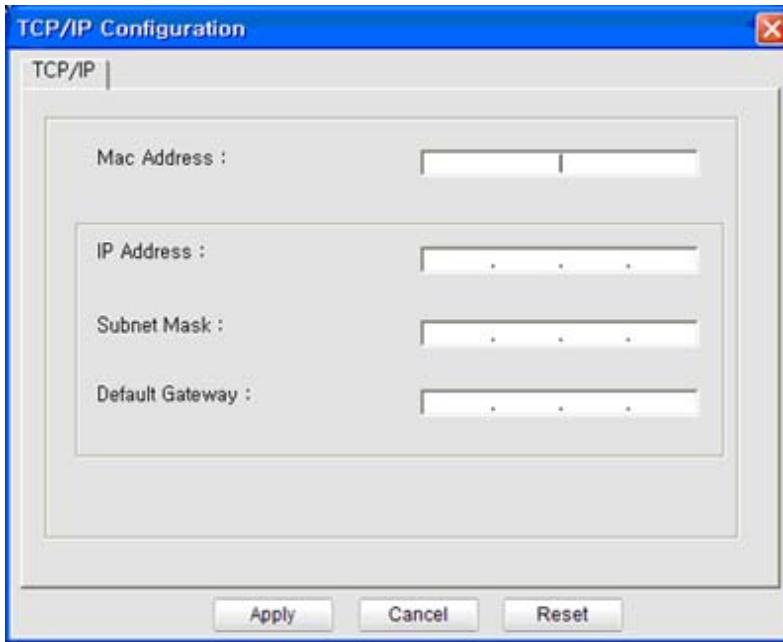

- **MAC Address** : Find the machine's MAC address from the **Network Configuration Report** and enter it without the colons. For example, 00:15:99:29:51:A8 becomes 0015992951A8.
 - **IP Address**: Enter a new IP address for your printer.
For example, if your computer's IP address is 192.168.1.150, enter 192.168.1.X. (X is number between 1 and 254 other than the computer's address.)
 - **Subnet Mask**: Enter a Subnet Mask.
 - **Default Gateway**: Enter a Default Gateway.
6. Click **Apply**, and then click **OK**. The machine will automatically print the **Network Configuration Report**. Confirm that all the settings are correct.
 7. Click **Exit** to close the SetIP program.
 8. If necessary, restart the computer's firewall.

Network parameter setting

You can also set up the various network settings through the network administration programs such as **Embedded Web Service**.

Restoring factory default settings

You may need to reset the machine to the factory default settings when machine that you are using is connected to new network environment.

Restoring factory default settings using Embedded Web Service

1. Start a web browser and enter your machine's new IP address in the browser window.

For example,



2. When the Embedded Web Service window opens, click **Network Settings**.
3. Click **Reset**. Then, click **Clear** for network.
4. Turn off and restart machine to apply settings.

Installing network connected machine's driver

Windows

You can set up the machine driver, follow the steps below.

This is recommended for most users. All components necessary for machine operations will be installed.

1. Make sure that the machine is connected to the network and powered on.

2. Insert the supplied software CD into your CD/DVD drive.
 - The software CD should automatically run and an installation window appear.
 - If the installation window does not appear, click **Start** and then **Run**. Type X:\Setup.exe, replacing "X" with the letter which represents your drive. Click **OK**.
 - If you use Windows Vista, Windows 7 and Windows 2008 Server R2 click **Start** > **All programs** > **Accessories** > **Run**. Type X:\Setup.exe replacing "X" with the letter which represents your drive and click **OK**.
 - If the **AutoPlay** window appears in Windows Vista, Windows 7 and Windows 2008 Server R2, click **Run Setup.exe** in **Install or run program** field, and click **Continue** or **Yes** in the **User Account Control** windows.
3. Click **Next**.

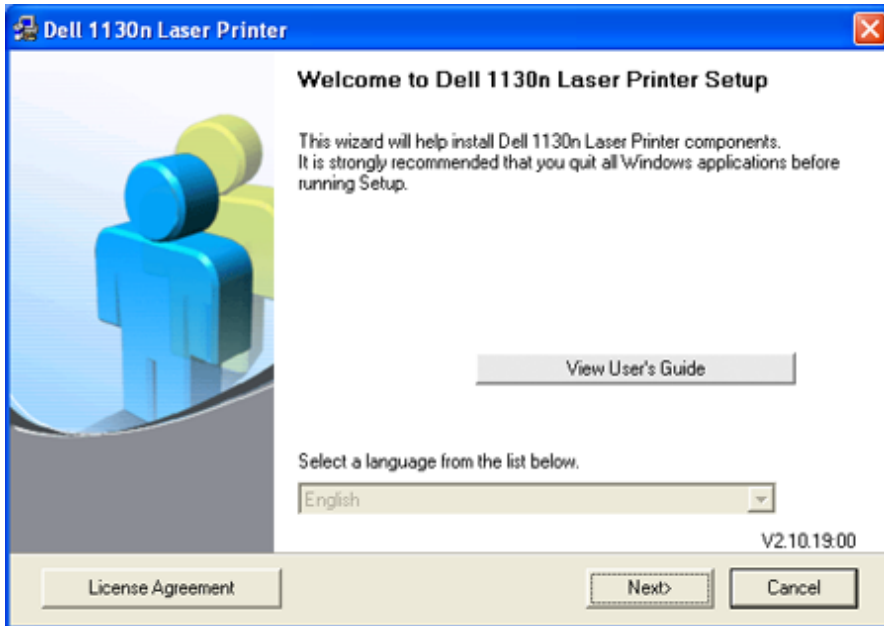

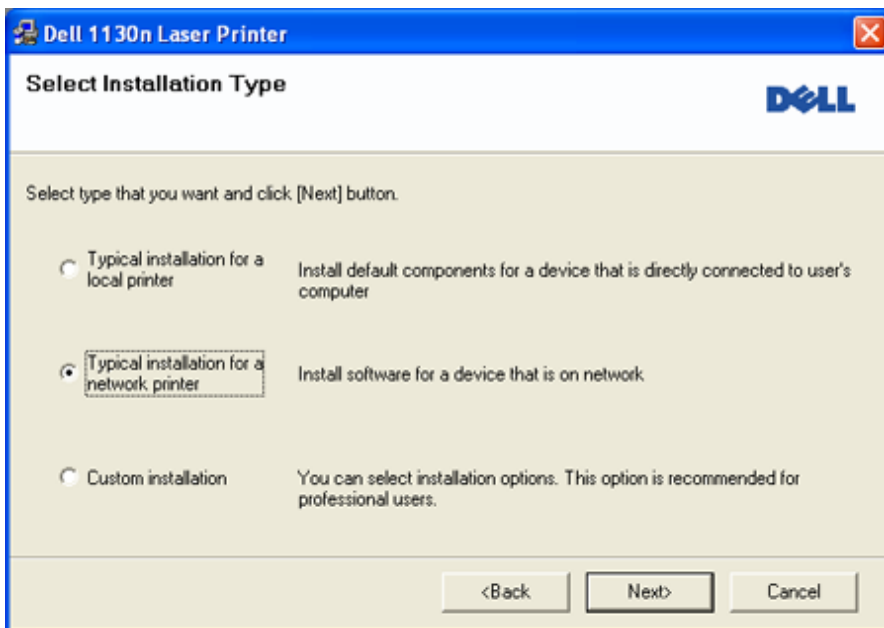

If necessary, select a language from the drop-down list.

4. Select **Typical installation for a network printer**. Then, click **Next**.
 -  The Custom Installation allows you to select the machine's connection and choose individual component to install. Follow the guide on the window.

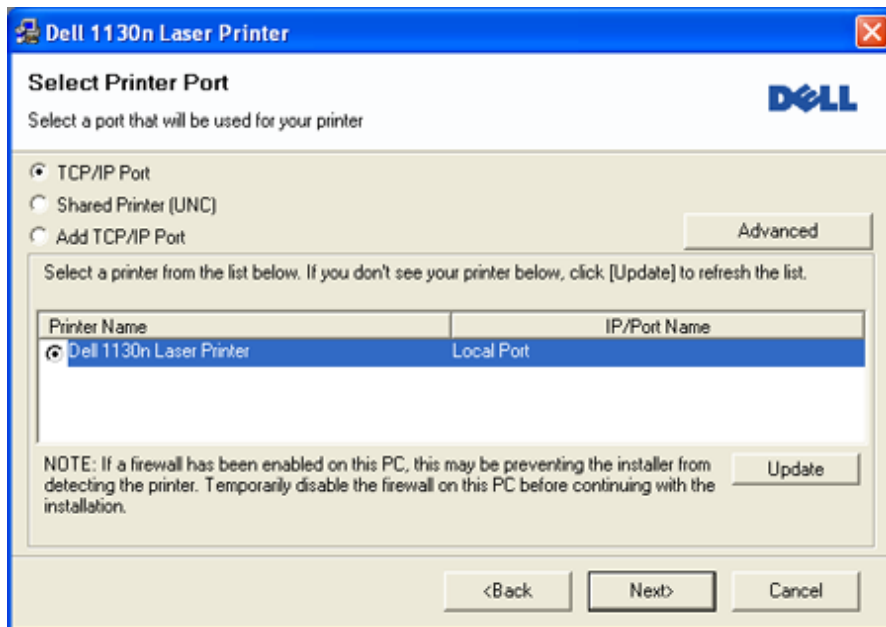

5. The list of printers available on the network appears. Select the printer you want to install from the list and then click **Next**.



- If you do not see your printer on the list, click **Update** to refresh the list, or select **Add TCP/IP Port** to add your printer to the network. To add the printer to the network, enter the port name and the IP address for the printer.
- To verify your printer's IP address, print a Network Configuration page. (By pressing the  (cancel button) for about 5 seconds, then release. (Example IP Address is 13.121.52.104)
- To find a shared network printer (UNC Path), select **Shared Printer [UNC]** and enter the shared name manually or find a shared printer by clicking the **Browse** button.



If you cannot find your machine in network, please turn off the firewall and click **Update**.
 For Windows operating system, **Start > Control Panel** and start windows firewall, and deactivate this option.
 For other operating system, refer to its on-line guide.

6. After the installation is finished, a window asking you to print a test page appears. If you choose to print a test page, select the checkbox and click **Next**. Otherwise, just click **Next** and skip to step 8.
7. If the test page prints out correctly, click **Yes**.
 If not, click **No** to reprint it.
8. Click **Finish**.



- After the driver setup, you may enable firewall.
- If the printer driver does not work properly, follow the steps below to repair or reinstall the driver.
 1. Make sure that the machine is connected to your machine and powered on.
 2. From the **Start** menu, select **Programs** or **All Programs > Dell > Dell Printers > your printer driver name > Maintenance**.
 3. Select the option as you wish, follow the instruction on the window.

Macintosh

1. Make sure that the machine is connected to your network and powered on. Also, your machine's IP address should have been set.
2. Insert the supplied software CD into your CD/DVD drive.
3. Double-click the CD-ROM icon that appears on your Macintosh desktop.
4. Double-click the **MAC_Installer** folder.
5. Double-click the **Installer OS X** icon.
6. Enter the password and click **OK**.
7. The **Dell Installer** window opens. Click **Continue**.
8. Select **Easy Install** and click **Install**. **Easy Install** is recommended for most users. All components necessary for machine operations will be installed.
 - If you select **Custom Install**, you can choose individual components to install.
9. The message which warns that all applications will close on your computer appears. Click **Continue**.

10. After the installation is finished, click **Quit**.
11. Open the **Applications** folder > **Utilities** > **Print Setup Utility**.
 - For Mac OS X 10.5~10.6, open the **Applications** folder > **System Preferences** and click **Print & Fax**.
12. Click **Add** on the **Printer List**.
 - For Mac OS X 10.5~10.6, click the "+" icon; a display window will pop up.
13. For Mac OS X 10.3, select the **IP Printing** tab.
 - For Mac OS X 10.4, click **IP Printer**.
 - For Mac OS X 10.5~10.6, click **IP**.
14. Select **Socket/HP Jet Direct** in **Printer Type**.
 When printing a document containing many pages, printing performance may be enhanced by choosing **Socket** for **Printer Type** option.
15. Enter the machine's IP address in the **Printer Address** field.
16. Enter the queue name in the **Queue Name** field. If you cannot determine the queue name for your machine server, try using the default queue first.
17. For Mac OS X 10.3, if Auto Select does not work properly, select **Dell** in **Printer Model** and your machine name in **Model Name**.
 - For Mac OS X 10.4, if Auto Select does not work properly, select **Dell** in **Print Using** and your machine name in **Model**.
 - For Mac OS X 10.5~10.6, if Auto Select does not work properly, select **Select a driver to use...** and your machine name in **Print Using**.Your machine appears on the **Printer List**, and is set as the default machine.
18. Click **Add**.



If the printer driver does not work properly, uninstall the driver and reinstall it. Follow steps below to uninstall the driver for Macintosh.

1. Make sure that the machine is connected to your computer and powered on.
2. Insert the supplied software CD into your CD/DVD drive.
3. Double-click CD-ROM icon that appears on your Macintosh desktop.
4. Double-click the **MAC_Installer** folder.
5. Double-click the **Installer OS X** icon.
6. Enter the password and click **OK**.
7. The Dell Installer window opens. Click **Continue**.
8. Select **Uninstall** and click **Uninstall**.
9. When the message which warns that all applications will close on your computer appears, Click **Continue**.
10. When the uninstall is done, click **Quit**.

Linux

Install Linux Driver

1. Make sure that the machine is connected to your network and powered on. Also, your machine's IP address should have been set.
2. Insert the supplied software CD into your CD/DVD drive.
3. Double-click CD-ROM icon that appears on your Linux desktop.
4. Double-click the **Linux** folder.
5. Double-click the **install.sh** icon.
6. The **Dell Installer** window opens. Click **Continue**.
7. The Add printer wizard window opens. Click **Next**.
8. Select Network printer and click **Search** button.
9. The Printer's IP address and model name appears on list field.
10. Select your machine and click **Next**.

Add network Printer

1. Double-click the **Unified Driver Configurator**.
2. Click **Add Printer...**
3. The **Add printer wizard** window opens. Click **Next**.
4. Select **Network printer** and click the **Search** button.
5. The printer's IP address and model name appears on list field.
6. Select your machine and click **Next**.
7. Input the printer description and **Next**
8. When the add printer is done, click **Finish**.

IPv6 Configuration

-  • **TCP/IPv6** is supported properly only in Windows Vista or higher.
- If the IPv6 network seems not working, set all the network setting to the factory defaults and try again. (See [Restoring factory default settings](#).)

To use the IPv6 network environment, follow the next procedure to use the IPv6 address:

The machine is provided with IPv6 feature on.

1. Connect your machine to the network with a network cable.
2. Turned on the machine.
3. Print a **Network Configuration Report** from the machine's control panel that will check IPv6 addresses.
4. Select **Start > Control Panel > Hardware and Sound > Printers > Add Printer**.
5. Click **Add a local printer** on the **Add Printer** windows.
6. Follow the instruction on the window.

-  If the machine does not work in the network environment, activate IPv6. Refer to the next section followed by.

Printing network configuration report

You can print a **Network Configuration Report** from the machine's control panel that will show the current machine's network settings. This will help you to set up a network and troubleshooting problems.

To print the report:

In ready mode, press and hold the  (cancel button) for about 5 seconds. You can find your machine's MAC address and IP address.

For example:

- MAC Address : 00:15:99:41:A2:78
- IP Address : 192.0.0.192

Setting IPv6 addresses

Machine supports following IPv6 addresses for network printing and managements.

- **Link-local Address**: Self-configured local IPv6 address. (Address starts with FE80.)
- **Stateless Address**: Automatically configured IPv6 address by a network router.
- **Stateful Address**: IPv6 address configured by a DHCPv6 server.
- **Manual Address**: Manually configured IPv6 address by a user.

Manual address configuration

1. Start a web browser such as Internet Explorer that supports IPv6 addressing as a URL. (See [Using Embedded Web Service \(Dell 1130n only\)](#).)

-  For IPv4, enter the IPv4 address (http://xxx.xxx.xxx.xxx) in the address field and press the Enter key or click **Go**.

2. When the Embedded Web Service window opens, click **Network Settings**.
3. Click **TCP/IP**.
4. Enable the **Manual Address** In the **TCP/IPv6** section.
5. Select the **Router Prefix** and click the **Add** button, then the router prefix will automatically be entered into the address field.

Enter the rest of address. (ex: 3FFE:10:88:194::**AAAA**. "A" is the hexadecimal 0 through 9, A through F.)

6. Click the **Apply** button.

Installing printer driver

Driver installation for network printer in IPv6 network environment is same as TCP/IPv4. (See [Installing network connected machine's driver.](#))

Select TCP/IP Port and when the list of machines is displayed, simply select your machine's IPv6 address.

Using Embedded Web Service

1. Start a web browser such as Internet Explorer that supports IPv6 addressing as a URL .
2. Select one of the IPv6 addresses (**Link-local Address**, **Stateless Address**, **Stateful Address**, **Manual Address**) from **Network Configuration Report**.
3. Enter the IPv6 addresses. (ex: http://[FE80::215:99FF:FE66:7701])



Address must be enclosed in '['] brackets.

Basic setup

After installation is complete, you may want to set the machine's default settings. Refer to the next section if you would like to set or change values. This chapter gives you step-by-step instructions for setting up the machine.

This chapter includes:

- [Altitude adjustment](#)
- [Setting the default tray and paper](#)
- [Changing font setting \(Dell 1130n only\)](#)

Altitude adjustment

The print quality is affected by atmospheric pressure, which is determined by the height of the machine above sea level. The following information will guide you on how to set your machine to the best print quality or best quality of print. Before you set the altitude value, find the altitude where you are using the machine.

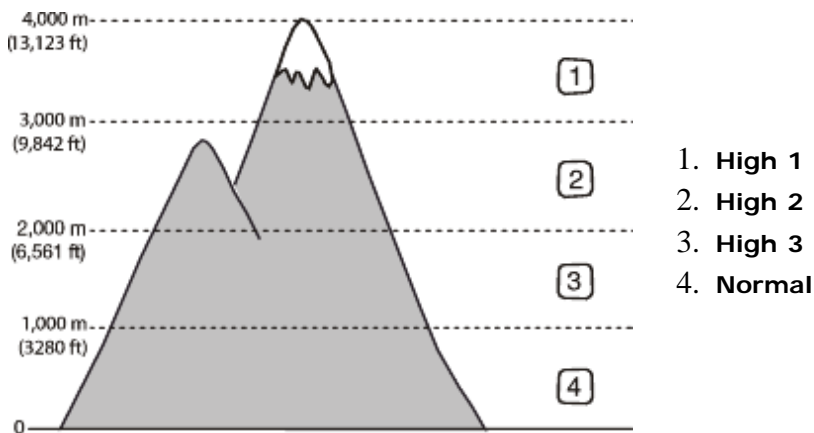

For Dell 1130

1. Install the driver. (See [Installing USB connected machine's driver](#) or [Installing network connected machine's driver](#).)
2. Click the Windows **Start** menu.
 - For Windows 2000, select **Settings > Printers**.
 - For Windows XP/Server 2003, select **Printer and Faxes**.
 - For Windows Server 2008/Vista, select **Control Panel > Hardware and Sound > Printers**.
 - For Windows 7, select **Control Panel > Hardware and Sound > Devices and Printers**.
 - For Windows Server 2008 R2, select **Control Panel > Hardware > Devices and Printers**.
3. Select the your machine's driver and right-click to open **Properties**.
4. In printer driver properties, select **Device Options**.
5. Select necessary options in the **Altitude Adjustment** drop-down list.
6. Click **OK**.

For Dell 1130n

You can altitude adjustment in Printer Settings Utility.

1. You can launch it from the **Start** menu, select **Programs** or **All Programs > Dell > Dell Printers > your printer driver name > Printer Settings Utility**.
2. Select necessary options in the **Altitude Adjustment** drop-down list.
3. Click the **Apply** button.

This can also be adjusted via Embedded Web Service.

Setting the default tray and paper

You can select the tray and paper you would like to keep using for printing job.

In the computer

Windows

1. Click the Windows **Start** menu.
2. For Windows 2000, select **Settings > Printers**.
 - For Windows XP/Server 2003, select **Printer and Faxes**.
 - For Windows Server 2008/Vista, select **Control Panel > Hardware and Sound > Printers**.
 - For Windows 7, select **Control Panel > Hardware and Sound > Devices and Printers**.
 - For Windows Server 2008 R2, select **Control Panel > Hardware > Devices and Printers**.
3. Right-click your machine.
4. For Windows XP/Server 2003/Server 2008/Vista, press **Printing Preferences**.
For Windows 7 and Windows Server 2008 R2, from context menus, select the **Printing Preferences**.



If **Printing Preferences** item has ► mark, you can select other printer drivers connected with selected printer.

5. Click **Paper** tab.
6. Select tray and its options, such as paper size and type.
7. Press **OK**.

Macintosh

Macintosh does not support this function. Macintosh users need to change the default setting manually each time they want to print using other settings.

1. Open a Macintosh application and select the file you want to print.
2. Open the **File** menu and click **Print**.
3. Go to **Paper Feed** pane.
4. Open the **File** menu and click **Print**.
5. Go to **Paper Feed**.
6. Set appropriate tray from which you want to print.
7. Go to **Paper** pane.
8. Set paper type to correspond to the paper loaded in the tray from which you want to print.
9. Click **Print** to print.

Using power saving feature

When you are not using the machine for a while, use this feature to save power.

For Dell 1130

1. Install the driver. (See [Installing USB connected machine's driver](#) or [Installing network connected machine's driver](#).)
2. Click the Windows **Start** menu.
 - For Windows 2000, select **Settings > Printers**.
 - For Windows XP/Server 2003, select **Printer and Faxes**.
 - For Windows Server 2008/Vista, select **Control Panel > Hardware and Sound > Printers**.
 - For Windows 7, select **Control Panel > Hardware and Sound > Devices and Printers**.
 - For Windows Server 2008 R2, select **Control Panel > Hardware > Devices and Printers**.
3. Select the your machine's driver and right-click to open **Properties**.
4. In printer driver properties, select **Device Options**.
5. Select the time you want, in the **Power Save** drop-down list.
6. Click **OK**.

For Dell 1130n

You change power save in Printer Settings Utility.

1. You can launch it from the **Start** menu, select **Programs** or **All Programs** > **Dell** > **Dell Printers** > **your printer driver name** > **Printer Settings Utility**.
2. Click **Power Save**. Select the appropriate value from the dropdown list, and then click **Apply**.

Changing font setting (Dell 1130n only)

Your machine has preset font setting depending on your region or country.

If you want to change the font or set the font for special condition, such as the DOS environment, you can change the font setting as follows:

1. Ensure that you have installed the printer driver with the provided software CD.
2. If you are a Windows user, you can launch it from the **Start** menu, select **Programs** or **All Programs** > **Dell** > **Dell Printers** > **your printer driver name** > **Printer Settings Utility**.
3. Click **Emulation Type**.
4. Select your preferred font.
5. Click **Apply**.



Following information shows the proper font list for corresponding languages.

- **Russian:** CP866, ISO 8859/5 Latin Cyrillic
- **Hebrew:** Hebrew 15Q, Hebrew-8, Hebrew-7 (Israel only)
- **Greek:** ISO 8859/7 Latin Greek, PC-8 Latin/Greek
- **Arabic & Farsi:** HP Arabic-8, Windows Arabic, Code Page 864, Farsi, ISO 8859/6 Latin Arabic
- **OCR:** OCR-A, OCR-B

Media and tray

This chapter provides information on how to load print media into your machine.

This chapter includes:

- [Selecting print media](#)
- [Changing the tray size](#)
- [Loading paper in the tray](#)
- [Printing on special media](#)
- [Using the output support](#)

Selecting print media

You can print on a variety of print media, such as plain paper, envelopes, labels, and transparencies. Always use print media that meet the guidelines for use with your machine.

Guidelines to select the print media

Print media that does not meet the guidelines outlined in this user's guide may cause the following problems:

- Poor print quality
- Increased paper jams
- Premature wear on the machine.

Properties, such as weight, composition, grain, and moisture content, are important factors that affect the machine's performance and the output quality. When you choose print materials, consider the following:

- The type, size and weight of the print media for your machine are described in print media specifications. (See [Print media specifications](#).)
- Desired outcome: The print media you choose should be appropriate for your project.
- Brightness: Some print media are whiter than others and produce sharper, more vibrant images.
- Surface smoothness: The smoothness of the print media affects how crisp the printing looks on the paper.

-  • Some print media may meet all of the guidelines in this section and still not produce satisfactory results. This may be the result of improper handling, unacceptable temperature and humidity levels, or other variables over which cannot be controlled.
- Before purchasing large quantities of print media, ensure that it meets the requirements specified in this user's guide.

 Using print media that does not meet these specifications may cause problems, requiring repairs. Such repairs are not covered by the warranty or service agreements.

The amount of paper put into the tray may differ according to media type used. (See [Print media specifications](#).)

Media sizes supported in each mode

Mode	Size	Type	Source
Simplex printing	For details about paper size, see Print media specifications .	For details about paper type, see Print media specifications .	<ul style="list-style-type: none">• tray 1• manual tray
Duplex printing (Manual) ^[a]	Letter, A4, Legal, US Folio, Oficio	Plain, Color, Preprinted, Recycled, Bond, Archive	<ul style="list-style-type: none">• tray 1

^[a] 75 to 90 g/m² (20~24 lb bond) only

Changing the tray size

The tray is preset to Letter or A4 size, depending on your country. To change the size, you need to adjust the paper guides.

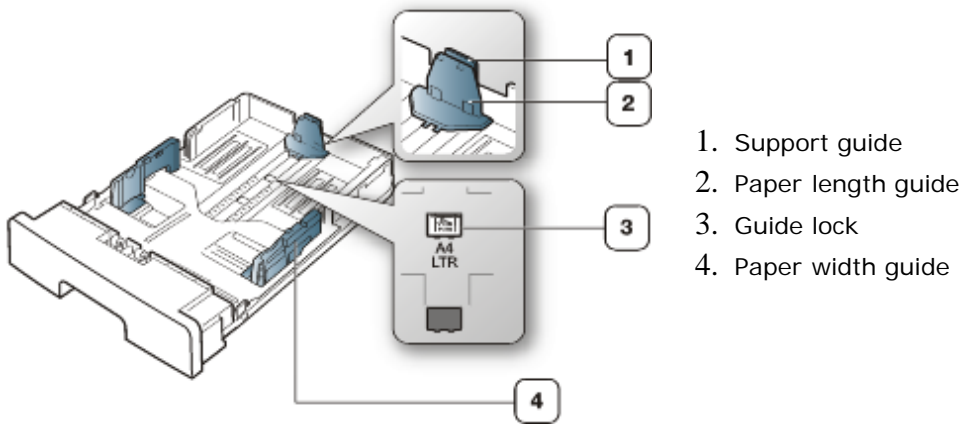

1. Support guide
2. Paper length guide
3. Guide lock
4. Paper width guide

1. With one hand press and hold the guide lock, and with the other hand, hold the paper length guide and support guide together. Slide the paper length guide and support guide to locate them in the correct paper size slot.

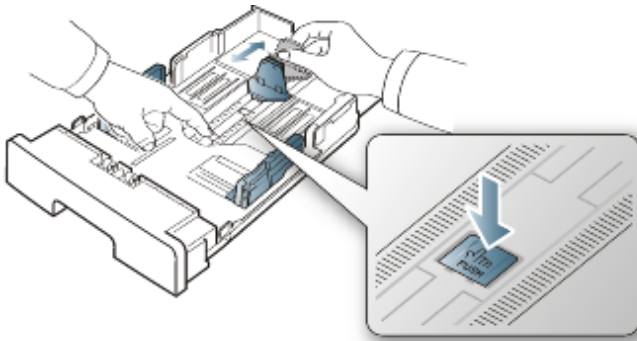

2. Flex or fan the edge of the paper stack to separate the pages before loading papers. Insert the paper into the tray.



3. After inserting paper into the tray, adjust the support guide so that it lightly touches the paper stack.

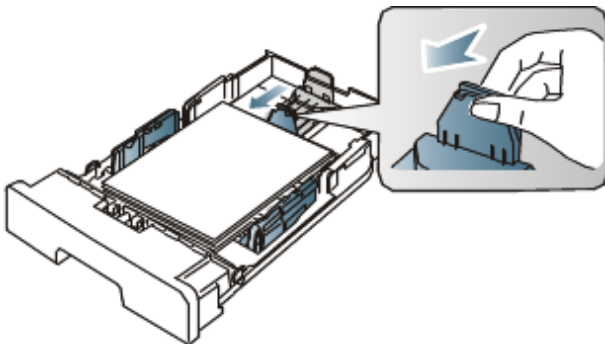

4. Squeeze the paper width guides and slide them to the desired paper size marked at the bottom of the tray.

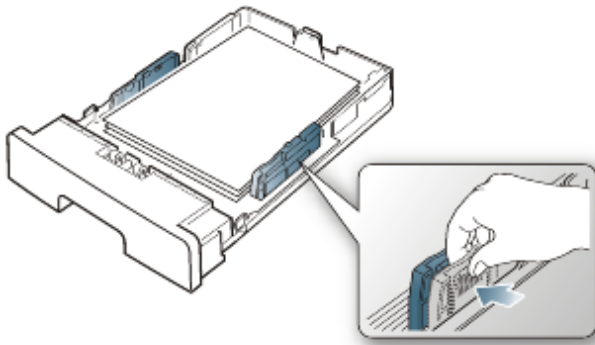

- Do not push the paper width guide too far causing the media to warp.
- If you do not adjust the paper width guide, it may cause paper jams.



- Do not use a paper with more than 6 mm curl.

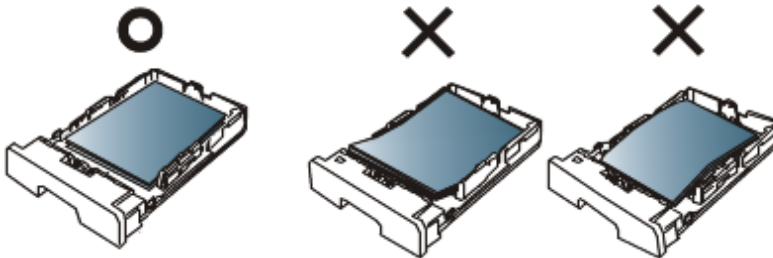

Loading paper in the tray

Tray 1

1. Pull out the paper tray . And adjust the tray size to the media size you are loading. (See [Changing the tray size.](#))
2. Flex or fan the edge of the paper stack to separate the pages before loading papers.



3. And place paper with the side you want to print facing down.

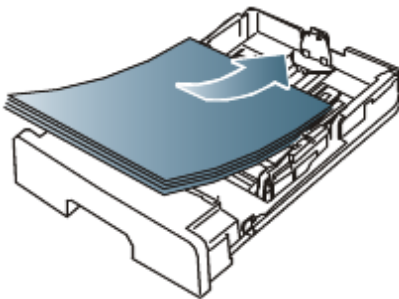

4. Set the paper type and size for the tray 1. (See [Setting the default tray and paper.](#))



If you experience problems with paper feeding, check whether the paper meets the media specification. (See [Print media specifications.](#))

Manual tray

The manual tray can hold special sizes and types of print material, such as postcards, note cards, and envelopes. It is useful for single page printing on letterhead or colored paper.

Tips on using the manual tray

- If you select **Manual Feeder** for **Source** from your software application, you need to press  (cancel button) each time you print a page and load only one type, size and weight of print media at a time in the manual tray.
 - To prevent paper jams, do not add paper while printing. This also applies to other types of print media.
 - Print media should be loaded face up with the top edge going into the manual tray first and be placed in the center of the tray.
 - Always load the specified print media only to avoid paper jams and print quality problems. (See [Print media specifications](#).)
 - Flatten any curl on postcards, envelopes, and labels before loading them into the manual tray.
1. Load the paper in the manual tray.

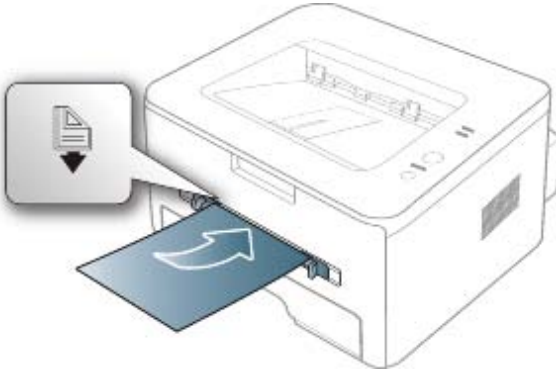

- Do not force the paper beyond the surface with  mark when loading.
- When printing the special media, you must follow the loading guideline. (See [Printing on special media](#).)
- When papers overlap when printing using manual tray, open tray 1 and remove overlapping papers then try printing again.
- When paper does not feed well while printing, push the paper in manually until it starts feeding automatically.

2. Squeeze the manual tray paper guides and adjust them to the width of the paper. Do not force them too much, or the paper will bent resulting in a paper jam or skew.
3. To print in application, open an application and start the print menu.
4. Open **Printing Preferences**. (See [Opening printing preferences](#).)
5. Press the **Paper** tab in **Printing Preferences**, and select an appropriate paper type.



For example, if you want to use a label, set the paper type to **Label**.

6. Select **Manual Feeder** in paper source, then press **OK**.
7. Start printing in application.



If you are printing multiple pages, load the next sheet after the first page prints out, and press the  (cancel button). Repeat this step for every page to be printed.

Printing on special media

The table below shows the available special media for each tray.

 When using special media, we recommend you feed one paper at a time. Check the maximum input number of media for each tray. (See [Print media specifications](#).)

Types	Tray 1	Manual tray
Plain	•	•
Thick	•	•
Thin	•	•
Bond		•
Color		•

CardStock		•
Labels		•
Transparency		•
Envelope		•
Preprinted		•
Cotton		•
Recycled	•	•
Archive	•	•

(•: supported, Blank: Not supported)

The media types are shown in the **Printing Preferences**. This paper type option allows you to set the type of paper to be loaded in the tray. This setting appears in the list, so that you can select it. This will let you get the best quality printout. If not, the desired print quality may not be achieved.

- **Plain:** 60 to 120 g/m² (16 to 32 lb) Normal plain paper.
- **Thick:** 90 (24 lb) thick paper.
- **Thin:** 60 to 70 g/m² (16 to 19 lb) thin paper.
- **Bond:** 105 to 120 g/m² (28 to 32 lb) bond.
- **Color:** 75 to 90 g/m² (20 to 24 lb) color-background paper.
- **CardStock:** 105 to 163 g/m² (24 to 43 lb) cardstock.
- **Labels:** 120 to 150 g/m² (32 to 40 lb) labels.
- **Transparency:** 138 to 146 g/m² (37 to 39 lb) transparency paper.
- **Envelope:** 75 to 90 g/m² (20 to 24 lb) envelope.
- **Preprinted:** 75 to 90 g/m² (20 to 24 lb) preprinted/letterhead paper.
- **Cotton:** 75 to 90 g/m² (20 to 24 lb) cotton paper.
- **Recycled:** 75 to 90 g/m² (20 to 24 lb) recycled paper.



When you use recycled paper, printouts might be wrinkled.

- **Archive:** 70 to 90 g/m² (19 to 24 lb) If you need to keep the print-out for a long period time, such as archives, select this option.

Envelope

Successful printing on envelopes depends upon the quality of the envelopes.

To print an envelope, the stamp area is on the left side and the end of the envelope with the stamp area enters the printer first and center of the manual tray.

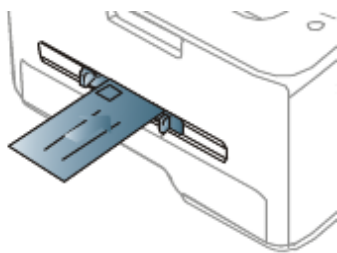

If envelopes are printed out with wrinkles, crease or black bold lines, open the rear cover and pull down the pressure lever and try printing again. Keep the rear cover opened during printing.

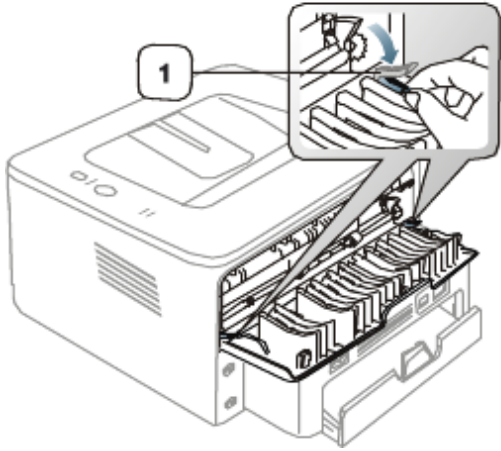

- When selecting envelopes, consider the following factors:
 - **Weight:** The weight of the envelope paper should not exceed 90 g/m² otherwise, jam may occur.
 - **Construction:** Prior to printing, envelopes should lie flat with less than 6 mm curl, and should not contain air.
 - **Condition:** Envelopes should not be wrinkled, nicked, nor damaged.
 - **Temperature:** Use envelopes that are compatible with the heat and pressure of the machine during operation.
- Use only well-constructed envelopes with sharp-and well-creased folds.
- Do not use stamped envelopes.
- Do not use envelopes with clasps, snaps, windows, coated lining, self-adhesive seals, or other synthetic materials.
- Do not use damaged or poorly made envelopes.
- Be sure the seam at both ends of the envelope extends all the way to the corner of the envelope.

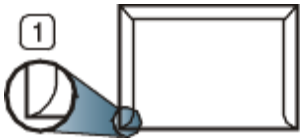

1. Acceptable

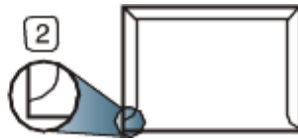

2. Unacceptable

- Envelopes with a peel-off adhesive strip or with more than one flap that folds over to seal must use adhesives compatible with the machine's fusing temperature about 170°C (338 °F) for 0.1 second. The extra flaps and strips might cause wrinkling, creasing, or jams, and may even damage the fuser.
- For the best print quality, position margins no closer than 15 mm from the edges of the envelope.
- Avoid printing over the area where the envelope's seams meet.

Transparency

To avoid damaging the machine, only use transparencies designed for use in laser printers.

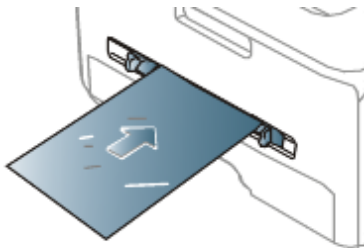

- Transparencies used in the machine must be able to withstand machine's fusing temperature.
- Place them on a flat surface after removing them from the machine.
- Do not leave unused transparencies in the paper tray for long periods of time. Dust and dirt may accumulate on them, resulting in spotty printing.
- To avoid smudging caused by fingerprints, handle them carefully.

- To avoid fading, do not expose printed transparencies to prolonged sunlight.
- Ensure that transparencies are not wrinkled, curled, or have any torn edges.
- Do not use transparencies that separates from the backing sheet.
- To prevent transparencies from sticking to each other, do not let the printed sheets stack up as they are begin printed out.

Labels

To avoid damaging the machine, use only labels designed for use in laser machines.

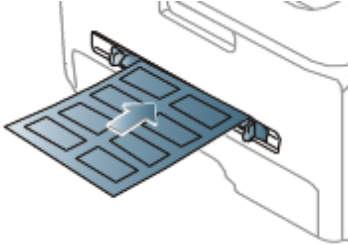

- When selecting labels, consider the following factors:
 - **Adhesives:** The adhesive material should be stable at your machine’s fusing temperature about 170°C (338 °F).
 - **Arrangement:** Only use labels with no exposed backing between them. Labels can peel off sheets that have spaces between the labels, causing serious jams.
 - **Curl:** Prior to printing, labels must lie flat with no more than 13 mm of curl in any direction.
 - **Condition:** Do not use labels with wrinkles, bubbles, or other indications of separation.
- Make sure that there is no exposed adhesive material between labels. Exposed areas can cause labels to peel off during printing, which can cause paper jams. Exposed adhesive can also cause damage to machine components.
- Do not run a sheet of labels through the machine more than once. The adhesive backing is designed for only a single pass through the machine.
- Do not use labels that are separating from the backing sheet or are wrinkled, bubbled, or otherwise damaged.

Card stock/Custom-sized paper

Postcards, cards and other custom-sized materials can be printed with this machine.

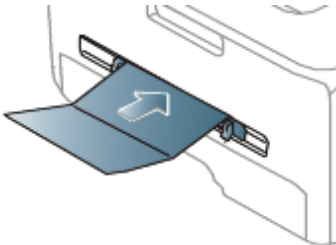

- Do not print on media smaller than 76 mm (3.00 inches) wide or 127 mm (5.00 inches) long.
- In the software application, set margins at least 6.4 mm (0.25 inches) away from the edges of the material.
- If media weight is over 160 g/m² (43 lb), try printing in the rear cover (face up).

Letterhead/Preprinted paper

	Single-sided	Double-sided
Tray1	Face down 	Face up
Manual tray	Face up	Face down

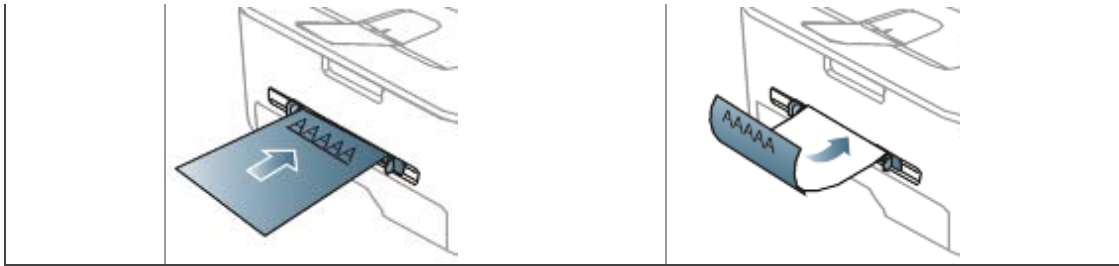

- Letterhead/ Preprinted paper must be printed with heat-resistant ink that will not melt, vaporize, or release hazardous emissions when subjected to the machine's fusing temperature about 170°C (338 °F) for 0.1 second.
- Letterhead/ Preprinted paper ink must be non-flammable and should not adversely affect machine rollers.
- Forms and letterhead should be sealed in a moisture-proof wrapping to prevent changes during storage.
- Before you load letterhead/preprinted paper, verify that the ink on the paper is dry. During the fusing process, wet ink can come off preprinted paper, reducing print quality.

Photo

- Make sure not to use the inkjet photo paper with this machine. It could cause damage to the machine.

Glossy

 Load one paper to the manual tray at a time, glossy side facing up.

- Recommended media: Glossy paper (Letter) for this machine by **HP Brochure Paper** (Product: Q6611A) only.
- Recommended media: Glossy paper (A4) for this machine by **HP Superior Paper 160 glossy** (Product: Q6616A).

Using the output support

 The surface of the output tray may become hot if you print a large number of pages at once. Make sure that you do not touch the surface, and do not allow children near it.

The printed pages stack on the output support, and the output support will help the printed pages to align. The printer sends output to the output tray by default. To use the output tray, make sure that the rear cover is closed.



 If you are using A5 paper, fold the output tray. Otherwise, printed pages might be mis-aligned or jammed.

Printing

This chapter explains common printing tasks.

This chapter includes:

- [Printer driver features](#)
- [Basic printing](#)
- [Opening printing preferences](#)
- [Using help](#)
- [Using special print features](#)
- [Changing the default print settings](#)
- [Setting your machine as a default machine](#)
- [Printing to a file \(PRN\)](#)
- [Macintosh printing](#)
- [Linux printing](#)

 The procedures in this chapter are mainly based on Windows XP.

Printer driver features

Your printer drivers support the following standard features:

- Paper orientation, size, source, and media type selection
- Number of copies

In addition, you can use various special printing features. The following table shows a general overview of features supported by your printer drivers:

 Some models or operating system may not support the certain feature(s) in the following table.

Printer driver

Feature	Windows
Machine quality option	•
Poster printing	•
Multiple pages per sheet	•
Booklet printing (manual)	•
Fit to page printing	•
Reduce and enlarge printing	•
Different source for first page	•
Watermark	•
Overlay	•
Double-sided printing (manual)	•





(•: supported, Blank: Not supported)

Basic printing

Your machine allows you to print from various Windows, Macintosh, or Linux applications. The exact steps for printing a document may vary depending on the application you use.



Your **Printing Preferences** window that appears in this user's guide may differ depending on the machine in use. However, the composition of the **Printing Preferences** window is similar. Check the operating system(s) that are compatible with your machine. Refer to the OS compatibility section of Printer Specifications. (See [System requirements](#).)

- When you select an option in **Printing Preferences**, you may see a warning mark, , or . An exclamation mark () means you can select that certain option but it is not recommended, and () mark means you cannot select that option due to the machine's setting or environment.

The following procedure describes the general steps required for printing from various Windows applications.



Macintosh basic printing. (See [Macintosh printing](#).)

Linux basic printing. (See [Linux printing](#).)

The following **Printing Preferences** window is for Notepad in Windows XP. Your **Printing Preferences** window may differ, depending on your operating system or the application you are using.

1. Open the document you want to print.
2. Select **Print** from the **File** menu. The **Print** window appears.
3. Select your machine from the **Select Printer** list.

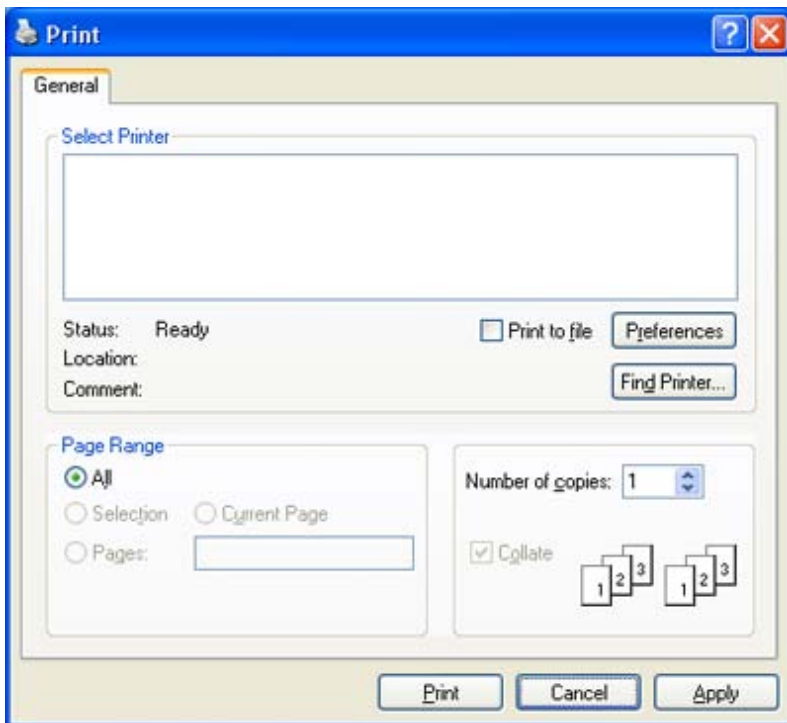

The basic print settings including the number of copies and print range are selected within the **Print** window.



To take advantage of the printer features provided by your printer driver, click **Properties** or **Preferences** in the application's **Print** window to change the print setting. (See [Opening printing preferences](#).)

4. To start the print job, click **OK** or **Print** in the **Print** window.

Canceling a print job



If the print job is waiting in a print queue or print spooler, cancel the job as follows:

1. Click the Windows **Start** menu.
2. For Windows 2000, select **Settings** > **Printers**.
 - For Windows XP/Server 2003, select **Printer and Faxes**.
 - For Windows Server 2008/Vista, select **Control Panel** > **Hardware and Sound** > **Printers**.
 - For Windows 7, select **Control Panel** > **Hardware and Sound** > **Devices and Printers**.
 - For Windows Server 2008 R2, select **Control Panel** > **Hardware** > **Devices and Printers**.
3. For Windows 2000, XP, Server 2003 and Vista, double-click your machine.
For Windows 7 and Windows Server 2008 R2, right click your printer icon > context menus > **See what's printing**.



If **See what's printing** item has ► mark, you can select other printer drivers connected with selected printer.

4. From the **Document** menu, select **Cancel**.

 You can also access this window by simply double-clicking the machine icon () in the Windows task bar.

You can also cancel the current job by pressing  on the control panel.

Opening printing preferences

You can preview the settings you selected on the upper right of the **Printing Preferences**.

1. Open the document you want to print.
2. Select **Print** from the file menu. The **Print** window appears.
3. Select your machine from the **Select Printer**.
4. Click **Properties** or **Preferences**.

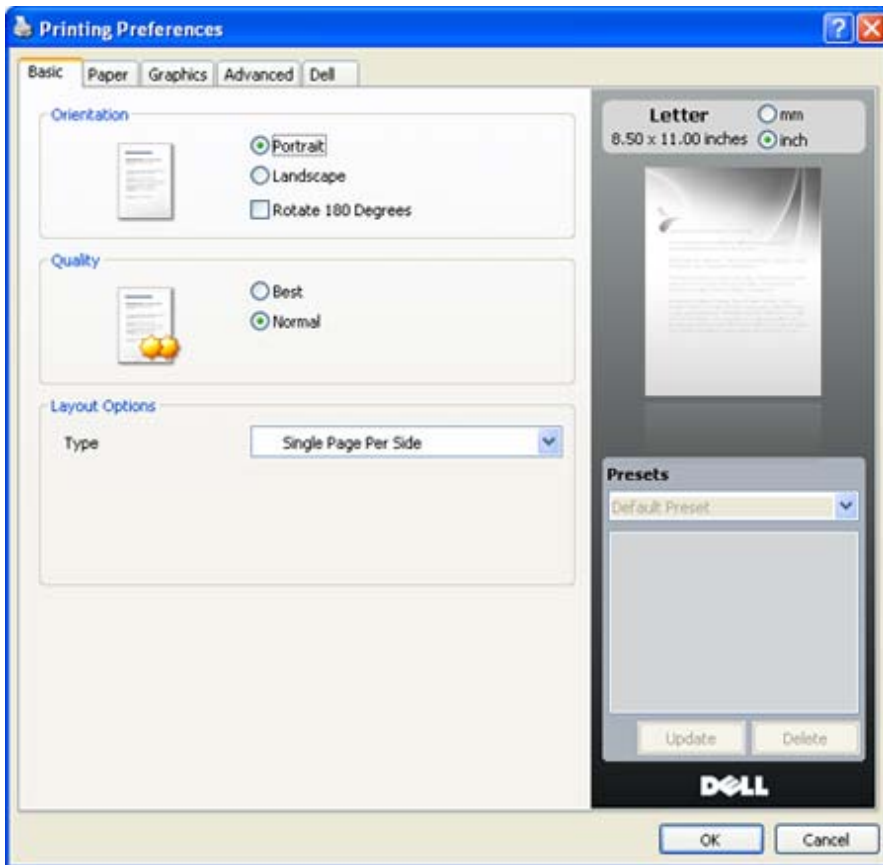

Using a favorite setting

The **Presets** option, which is visible on each preferences tab except for **Dell** tab, allows you to save the current preferences settings for future use.

To save a **Presets** item:

1. Change the settings as needed on each tab.
2. Enter a name for the item in the **Presets** input box.

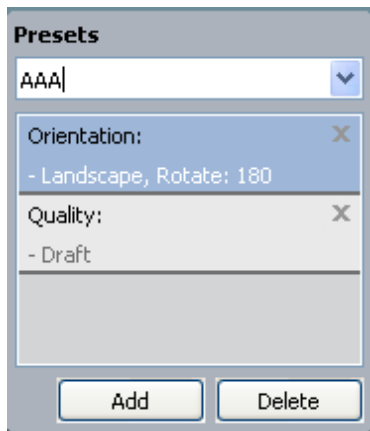

3. Click **Add**. When you save **Presets**, all current driver settings are saved.

If you click **Add**, the **Add** button changes to **Update** button. Select more options and click **Update**, settings will be added to the **Presets** you made.

To use a saved setting, select it from the **Presets** drop down list. The machine is now set to print according to the setting you selected.

To delete saved setting, select it from the **Presets** drop down list and click **Delete**.

You can also restore the printer driver's default settings by selecting **Default Preset** from the **Presets** drop down list.

Using help

Click the question mark from the upper-right corner of the window and click on any option you want to know about. Then a pop up window appears with information about that option's feature which is provided from the driver.



If you want to search information via a keyword, click the **Dell** tab in the **Printing Preferences** window, and enter a keyword in the input line of the **Help** option. To get information about supplies, driver update or registration and so on, click appropriate buttons.

Using special print features

Special print features include:

- [Printing multiple pages on one sheet of paper.](#)
- [Printing posters.](#)
- [Printing booklets \(Manual\).](#)
- [Printing on both sides of paper \(Manual\).](#)
- [Change percentage of your document.](#)
- [Fitting your document to a selected paper size.](#)
- [Using watermarks.](#)
- [Using overlay.](#)
- [Advanced Options.](#)

Printing multiple pages on one sheet of paper

You can select the number of pages to print on a single sheet of paper. To print more than one page per sheet, the pages will be reduced in size and arranged in the order you specify. You can print up to 16 pages on one sheet.

1. To change the print settings from your software application, access **Printing Preferences**. (See [Opening printing preferences.](#))
2. Click the **Basic** tab, select **Multiple Pages Per Side** in the **Type** drop-down list.
3. Select the number of pages you want to print per sheet (2, 4, 6, 9, or 16) in the **Pages per Side** drop-down list.
4. Select the page order from the **Page Order** drop-down list, if necessary.
5. Check **Print Page Border** to print a border around each page on the sheet.

6. Click the **Paper** tab, select the **Size**, **Source**, and **Type**.
7. Click **OK** or **Print** until you exit the **Print** window.

Printing posters

This feature allows you to print a single-page document onto 4, 9, or 16 sheets of paper, for the purpose of pasting the sheets together to form one poster-size document.

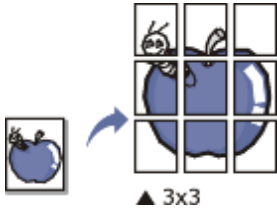

1. To change the print settings from your software application, access **Printing Preferences**. (See [Opening printing preferences](#).)
2. Click the **Basic** tab, select **Poster Printing** in the **Type** drop-down list.
3. Select the page layout you want.
 - **Poster 2x2**: Document will be enlarged and be divided into 4 pages.
 - **Poster 3x3**: Document will be enlarged and be divided into 9 pages.
 - **Poster 4x4**: Document will be enlarged and be divided into 16 pages.
4. Select the **Poster Overlap** value. Specify **Poster Overlap** in millimeters or inches by selecting the radio button on the upper right of **Basic** tab to make it easier to paste the sheets together.



5. Click the **Paper** tab, select the **Size**, **Source**, and **Type**.
6. Click **OK** or **Print** until you exit the **Print** window.
7. You can complete the poster by pasting the sheets together.



Printing booklets (Manual)

This feature prints your document on both sides of a paper and arranges the pages so that the paper can be folded in half after printing to produce a booklet.

 If you want to make a booklet, you need to print on Letter, Legal, A4, US Folio, or Oficio sized print media.



1. To change the print settings from your software application, access the **Printing Preferences**. (See [Opening printing preferences](#).)
2. Click the **Basic** tab, select **Booklet Printing** from the **Type** drop-down list.
3. Click the **Paper** tab, select the **Size**, **Source**, and **Type**.

 The **Booklet Printing** option is not available for all paper sizes. In order to find out the available paper size for this feature, select the available paper size in the **Size** option on the **Paper** tab. If you select an unavailable paper size, this option can be automatically canceled. Select only available paper. (paper without  or  mark).

4. Click **OK** or **Print** until you exit the **Print** window.
5. After printing, fold and staple the pages.

Printing on both sides of paper (Manual)

You can print on both sides of a paper; duplex. Before printing, decide how you want your document oriented. You can use this feature with Letter, Legal, A4, US Folio, or Oficio sized paper. (See [Print media specifications](#).)

- ⚠ • We recommend not to print on both sides of the special media, such as labels, envelopes, or thick paper to print on both sides of paper. It may cause a paper jam or damage the machine.
 - The **Double-Sided Printing (Manual)** feature is available only for the tray 1.
1. To change the print settings from your software application, access **Printing Preferences**. (See [Opening printing preferences.](#))
 2. Click the **Advanced** tab.
 3. From the **Double-Sided Printing (Manual)** section, select the binding option you want.

- **None**
- **Long Edge:** This option is the conventional layout used in bookbinding.



- **Short Edge:** This option is the conventional layout used in calendars.



4. Click the **Paper** tab, select the **Size**, **Source**, and **Type**.
5. Click **OK** or **Print** until you exit the **Print** window.

☑ If your machine does not have a duplex unit, you should complete the printing job manually. The machine prints every other page of the document first. After that, a message appears on your computer. Follow the on-screen instructions to complete the printing job.

Change percentage of your document

You can change the size of a document to appear larger or smaller on the printed page by typing in a percentage you want.

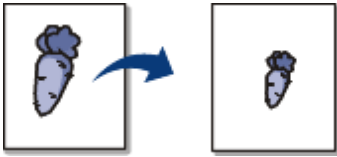

1. To change the print settings from your software application, access **Printing Preferences**. (See [Opening printing preferences.](#))
2. Click the **Paper** tab.
3. Enter the scaling rate in the **Percentage** input box.
You can also click the up/down arrows to select the scaling rate.
4. Select the **Size**, **Source**, and **Type** in **Paper Options**.
5. Click **OK** or **Print** until you exit the **Print** window.

Fitting your document to a selected paper size

This printer feature allows you to scale your print job to any selected paper size regardless of the document size. This can be useful when you want to check fine details on a small document.

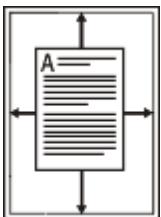

1. To change the print settings from your software application, access **Printing Preferences**. (See [Opening printing preferences.](#))

2. Click the **Paper** tab.
3. Select the paper size you want from the **Fit to Page**.
4. Select the **Size**, **Source**, and **Type** in **Paper Options**.
5. Click **OK** or **Print** until you exit the **Print** window.

Using watermarks

The watermark option allows you to print text over an existing document. For example, you use it when you want to have large gray letters reading "DRAFT" or "CONFIDENTIAL" printed diagonally across the first page or all pages of a document.

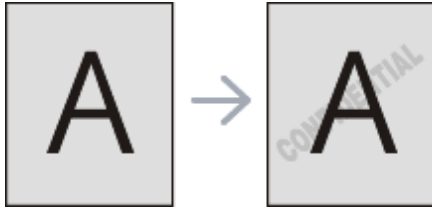

There are several predefined watermarks that come with the machine. They can be modified, or you can add new ones to the list.

Using an existing watermark

1. To change the print settings from your software application, access **Printing Preferences**. (See [Opening printing preferences](#).)
2. Click the **Advanced** tab, and select the desired watermark from the **Watermark** drop-down list. You will see the selected watermark in the preview image.
3. Click **OK** or **Print** until you exit the print window.

Creating a watermark

1. To change the print settings from your software application, access **Printing Preferences**. (See [Opening printing preferences](#).)
2. From the **Advanced** tab, select **Edit** from the **Watermark** drop-down list. The **Edit Watermarks** window appears.
3. Enter a text message in the **Watermark Message** box. You can enter up to 256 characters. The message displays in the preview window.
When the **First Page Only** box is checked, the watermark prints on the first page only.
4. Select watermark options.
You can select the font name, style, size, and shade from the **Font Attributes** section, as well as set the angle of the watermark from the **Message Angle** section.
5. Click **Add** to add a new watermark to the **Current Watermarks** list.
6. When you have finished editing, click **OK** or **Print** until you exit the **Print** window.

To stop printing the watermark, select **None** from the **Watermark** drop-down list.

Editing a watermark

1. To change the print settings from your software application, access **Printing Preferences**. (See [Opening printing preferences](#).)
2. Click the **Advanced** tab, select **Edit** from the **Watermark** drop-down list. The **Edit Watermarks** window appears.
3. Select the watermark you want to edit from the **Current Watermarks** list and change the watermark message and options.
4. Click **Update** to save the changes.
5. Click **OK** or **Print** until you exit the **Print** window.

Deleting a watermark

1. To change the print settings from your software application, access **Printing Preferences**. (See [Opening printing preferences](#).)
2. Click the **Advanced** tab, select **Edit** from the **Watermark** drop-down list. The **Edit Watermarks** window appears.
3. Select the watermark you want to delete from the **Current Watermarks** list and click **Delete**.

4. Click **OK** or **Print** until you exit the **Print** window.

Using overlay

An overlay is text and/or images stored in the computer hard disk drive (HDD) as a special file format that can be printed on any document. Overlays are often used to take the place of letterhead paper. Rather than using preprinted letterhead, you can create an overlay containing exactly the same information that is currently on your letterhead. To print a letter with your company's letterhead, you do not need to load preprinted letterhead paper in the machine just print the letterhead overlay on your document.



Creating a new page overlay

To use a page overlay, you must create a new page overlay containing your logo or image.

1. Create or open a document containing text or an image for use in a new page overlay. Position the items exactly as you wish them to appear when printed as an overlay.
2. To save the document as an overlay, access **Printing Preferences**. (See [Opening printing preferences.](#))
3. Click the **Advanced** tab, and select **Edit** from the **Text** drop-down list. **Edit Overlay** window appears.
4. In the **Edit Overlay** window, click **Create**.
5. In the **Save As** window, type a name of up to eight characters in the **File name** box. Select the destination path, if necessary. (The default is C:\Formover.)
6. Click **Save**. The name appears on the **Overlay List**.
7. Click **OK** or **Print** until you exit the **Print** window.
8. The file is not printed. Instead, it is stored on your computer hard disk drive.



The overlay document size must be the same as the document you print with the overlay. Do not create an overlay with a watermark.

Using a page overlay

After an overlay has been created, it is ready to be printed with your document. To print an overlay with a document:

1. Create or open the document you want to print.
2. To change the print settings from your software application, access **Printing Preferences**. (See [Opening printing preferences.](#))
3. Click the **Advanced** tab.
4. Select the desired overlay from the **Text** drop-down list.
5. If the overlay file you want does not appear in the **Text** drop-down list, select **Edit** from the list and click **Load**. Select the overlay file you want to use.
If you have stored the overlay file you want to use in an external source, you can also load the file when you access the **Open** window.
After you select the file, click **Open**. The file appears in the **Overlay List** box and is available for printing. Select the overlay from the **Overlay List** box.
6. If necessary, check **Confirm Page Overlay When Printing** box. If this box is checked, a message window appears each time you submit a document for printing, asking you to confirm your wish to print an overlay on your document.
If this box is not checked and an overlay has been selected, the overlay automatically prints with your document.
7. Click **OK** or **Print** until you exit the **Print** window.
The selected overlay prints on your document.



The resolution of the overlay document must be the same as that of the document you will print with the overlay.

Deleting a page overlay

You can delete page overlays that you no longer use.

1. In the **Printing Preferences** window, click the **Advanced** tab.

2. Select **Edit** in the **Overlay** drop down list.
3. Select the overlay you want to delete from the **Overlay List** box.
4. Click **Delete**.
5. When a confirming message window appears, click **Yes**.
6. Click **OK** or **Print** until you exit the **Print** window.

Advanced Options

Use the following Graphics options to adjust the print quality for your specific printing needs.

1. To change the print settings from your software application, access **Printing Preferences**. (See [Opening printing preferences](#).)
2. Click the **Graphics** tab.



- This options you can select may vary depending on your printer model.
- Refer to the online help for each option's information provided from the **Printing Preferences**.
- **Font/ Text:** Select **Darken Text** to print texts darker than on a normal document. Use **All Text Black** to prints solid black, regardless of the color it appears on the screen.
- **Advanced (Dell 1130n only):** You can set advanced settings by clicking the **Advanced** button.
 - **True Type Options:** This option determines what the driver tells the printer about how to image the text in your document. Select the appropriate setting according to the status of your document.
 - **Download as Outline:** When this option is selected, the driver will download any TrueType fonts that are used in your document not already stored (resident) on your printer. If, after printing a document, you find that the fonts did not print correctly, choose Download as bit image and resubmit your print job. The Download as bit image setting is often useful when printing Adobe®.
 - **Download as Bit Image:** When this option is selected, the driver will download the font data as bitmap images. Documents with complicated fonts, such as Korean or Chinese, or various other fonts, will print faster in this setting.
 - **Print as Graphics:** When this option is selected, the driver will download any fonts as graphics. When printing documents with high graphic content and relatively few TrueType fonts, printing performance (speed) may be enhanced in this setting.
 - **Use Printer Fonts:** When **Use Printer Fonts** is checked, the printer uses the fonts that are stored in its memory (resident fonts) to print your document, rather than downloading the fonts used in your document. Because downloading fonts takes time, selecting this option can speed up your printing time. When using Printer fonts, the printer will try to match the fonts used in your document to those stored in its memory. If, however, you use fonts in your document that are very different from those resident in the printer, your printed output will appear very different from what it looks like on the screen.
- **Graphic Controller: Fine Edge** allows user to emphasize edges of texts and fine lines for improving readability.
- **Toner Save:** Selecting this option extends the life of your toner cartridge and reduces your cost per page without a significant reduction in print quality.
 - **Printer Setting:** If you select this option, this feature is determined by the setting you've made from the machine.
 - **On:** Select this option to allow the printer to use less toner on each page.
 - **Off:** If you do not need to save toner when printing a document, select this option.
- **Darkness:** The option adjusts the toner density on print outputs. The values are **Normal**, **Light**, and **Dark**.



For Dell 1130n, you change darkness in the **Printer Settings Utility**.

3. Click **OK** or **Print** until you exit the **Print** window.

Changing the default print settings

 Most Windows applications will override settings you specify in the printer driver. Change all print settings available in the software application first, and change any remaining settings using the printer driver.

1. Click the Windows **Start** menu.
2. For Windows 2000, select **Settings > Printers**.
 - For Windows XP/Server 2003, select **Printers and Faxes**.

For Windows Server 2008/Vista, select **Control Panel > Hardware and Sound > Printers**.

- For Windows 7, select **Control Panel > Hardware and Sound > Devices and Printers**.
- For Windows Server 2008 R2, select **Control Panel > Hardware > Devices and Printers**.

3. Right-click your machine.

4. For Windows XP/Server 2003/Server 2008/Vista, press **Printing Preferences**.

For Windows 7 and Windows Server 2008 R2, from context menus, select the **Printing preferences**.

 If **Printing preferences** item has ► mark, you can select other printer drivers connected with selected printer.

5. Change the settings on each tab.

6. Click **OK**.

 If you want to change the settings for each print job, change it in **Printing Preferences**.

Setting your machine as a default machine

1. Click the Windows **Start** menu.

2. For Windows 2000, select **Settings > Printers**.

- For Windows XP/Server 2003, select **Printers and Faxes**.
- For Windows Server 2008/Vista, select **Control Panel > Hardware and Sound > Printers**.
- For Windows 7, select **Control Panel > Hardware and Sound > Devices and Printers**.
- For Windows Server 2008 R2, select **Control Panel > Hardware > Devices and Printers**.

3. Select your machine.

4. Right-click your machine and select **Set as Default Printer**.

 For Windows 7 and Windows Server 2008 R2
If **Set as default printer** item has ► mark, you can select other printer drivers connected with selected printer.

Printing to a file (PRN)

You will sometimes need to save the print data as a file.

To create a file:

1. Check the **Print to file** box at the **Print** window.

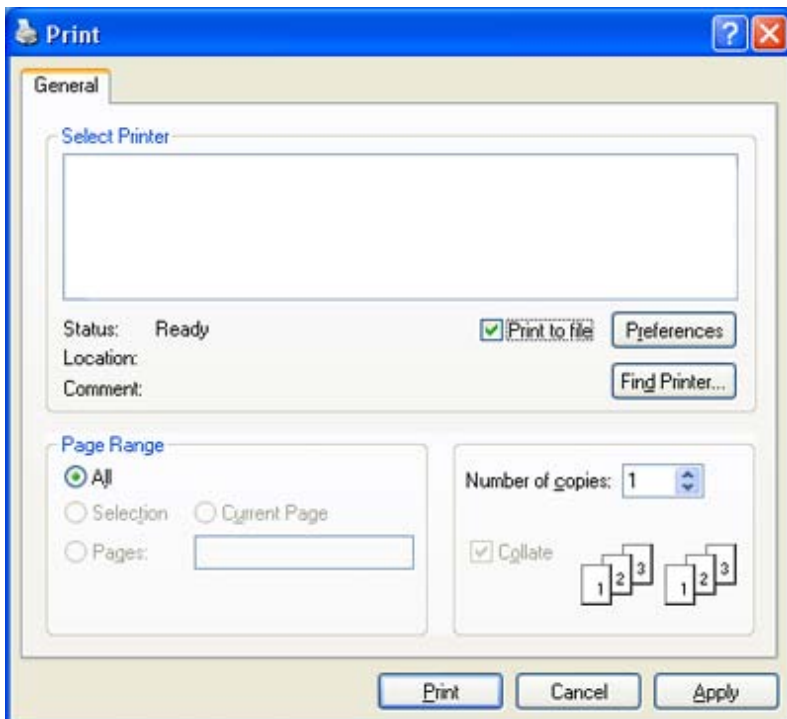

2. Click **Print**.

3. Type in the destination path and the file name, and then click **OK**.
For example c:\Temp\file name.

 If you type in only the file name, the file is automatically saved in **My Documents**. The saved folder may differ, depending on your operating system.

Macintosh printing

This chapter explains how to print using Macintosh. You need to set the print environment before printing.

- USB connected (See [Macintosh](#).)
- Network connected (See [Macintosh](#).)

Printing a document

When you print with a Macintosh, you need to check the printer driver setting in each application you use. Follow the steps below to print from a Macintosh:

1. Open an application and select the file you want to print.
2. Open the **File** menu and click **Page Setup** (**Document Setup** in some applications).
3. Choose your paper size, orientation, scaling, other options, and make sure that your machine is selected. Click **OK**.

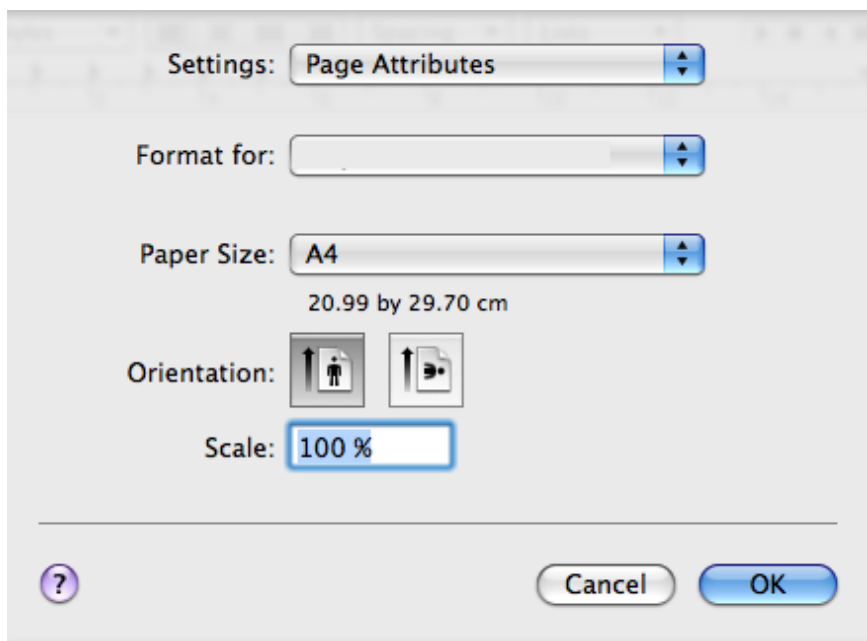

4. Open the **File** menu and click **Print**.
5. Choose the number of copies you want and indicate which pages you want to print.
6. Click **Print**.

Changing printer settings

You can use advanced printing features when using your machine.

Open an application and select **Print** from the **File** menu. The machine name, which appears in the printer properties window may differ depending on the machine in use. Except for the name, the composition of the printer properties window is similar to the following.

 The setting options may differ depending on printers and Macintosh OS version.

Layout

The **Layout** tab provides options to adjust how the document appears on the printed page. You can print multiple pages on one sheet of paper. Select **Layout** from the drop-down list under **Orientation** to access the following features.

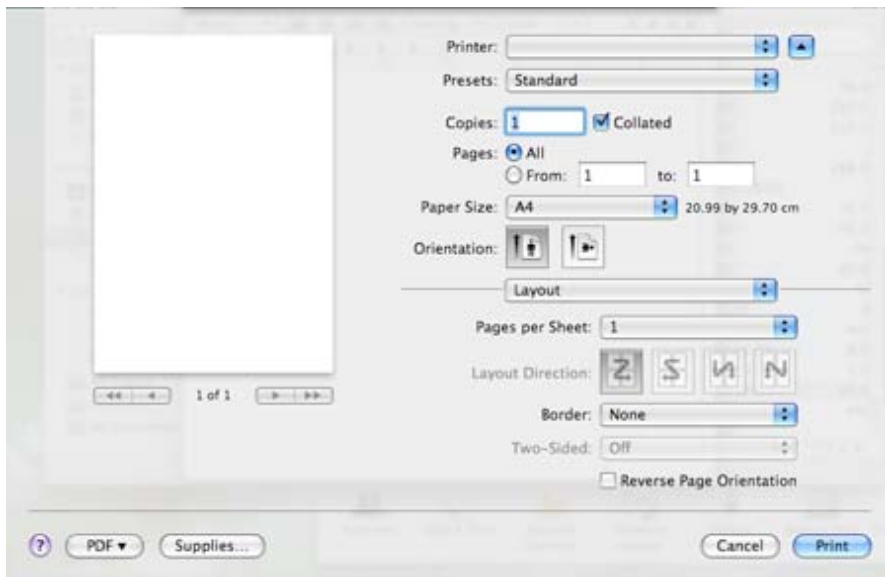

- **Pages per Sheet:** This option determines how many pages to be printed on one page. (See [Printing multiple pages on one sheet of paper.](#))
- **Layout Direction:** This option allows you to select the printing direction on a page similar to the examples on UI.
- **Border:** This option allows you to print a border around each page on the sheet.
- **Reverse Page Orientation:** This option allows you to rotate paper 180 degrees.

Graphics

The **Graphics** tab provides options for selecting **Resolution**. Select **Graphics** from the drop-down list under **Orientation** to access the graphic features.

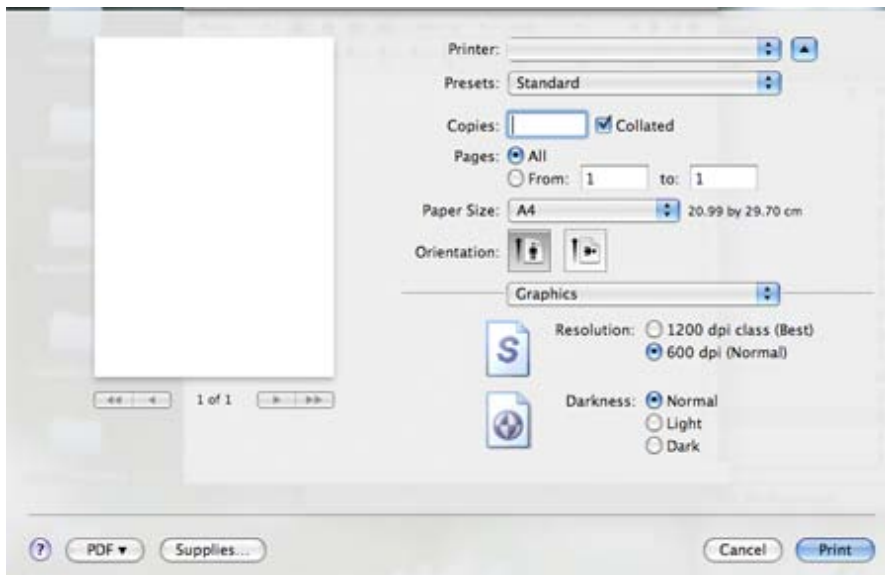

- **Resolution (Quality):** This option allows you to select the printing resolution. The higher the setting, the sharper the clarity of printed characters and graphics. The higher setting also may increase the time it takes to print a document.
- **Darkness:** This option allows you to enhance printouts. The available options are **Normal**, **Light**, and **Dark**.

Paper

Set **Paper Type** to correspond to the paper loaded in the tray from which you want to print. This will let you get the best quality printout. If you load a different type of print material, select the corresponding paper type.

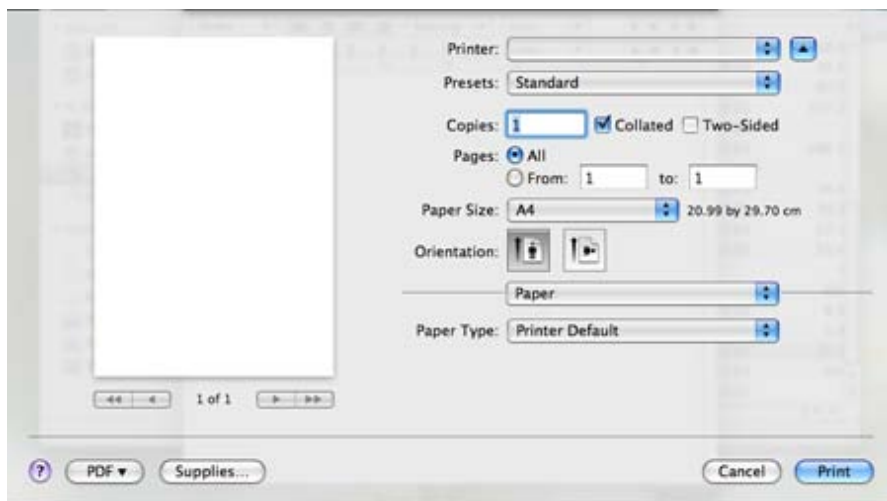

Printer Settings

Printer Settings tab provides **Toner Save Mode**, **Reprint When Jammed**, and **Power Save** options. Select **Printer Settings** from the drop-down list under **Orientation** to access the following features:

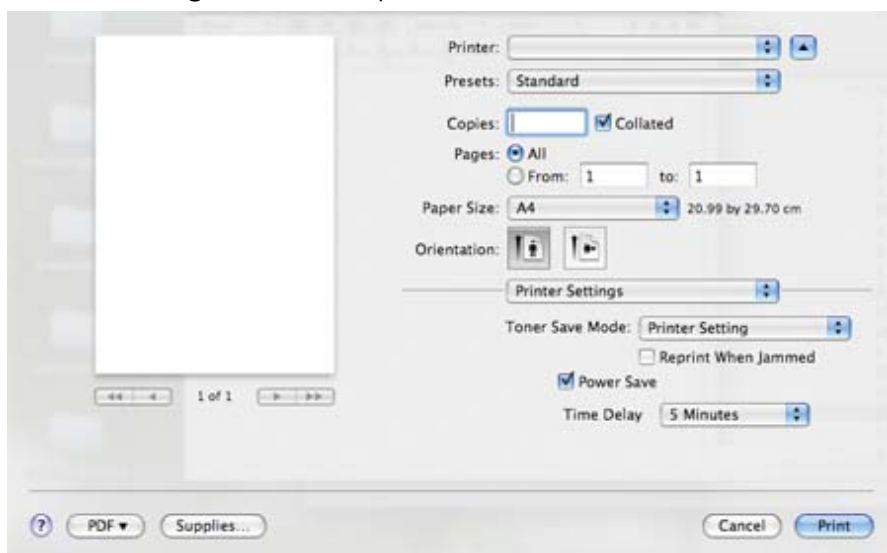

- **Toner Save Mode:** Selecting this option extends the life of your toner cartridge and reduces your cost per page without a significant reduction in print quality.
 - **Printer Setting:** If you select this option, this feature is determined by the setting you've made from the machine.
 - **On:** Select this option to allow the printer to use less toner on each page.
 - **Off:** If you do not need to save toner when printing a document, select this option.
- **Reprint When Jammed:** When this option is checked, the machine retains the image of a printed page until the machine signals that the page has successfully exited the machine. If a paper jam occurs, the printer will reprint the last page sent from the computer after you have cleared the jam. (Dell 1130 only)
- **Power Save:** When this option is checked, the machine turns to the power save mode after the selected time.

Printing multiple pages on one sheet of paper

You can print more than one page on a single sheet of paper. This feature provides a cost-effective way to print draft pages.

1. Open an application, and select **Print** from the **File** menu.
2. Select **Layout** from the drop-down list under **Orientation**. In the **Pages per Sheet** drop-down list, select the number of pages you want to print on one sheet of paper.

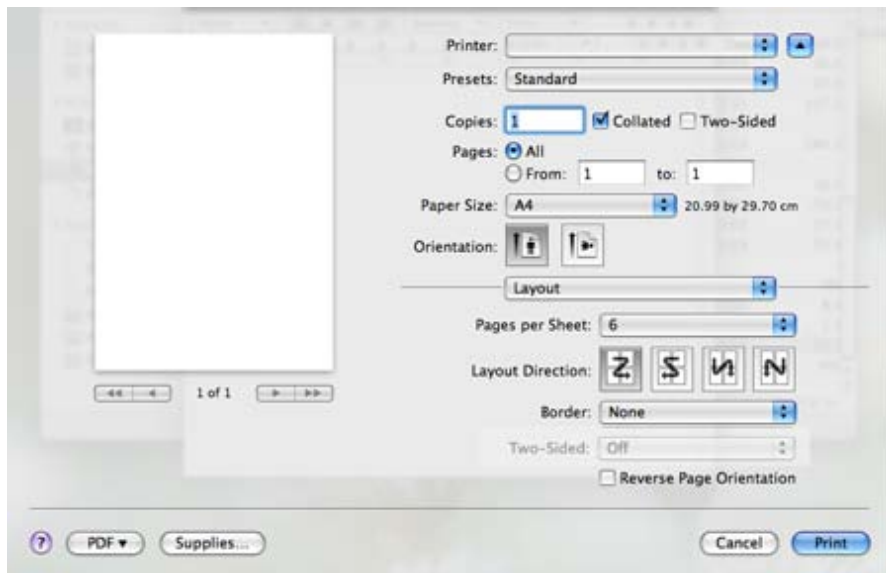

3. Select the other options you want to use.
4. Click **Print**, then the machine prints the selected the number of pages you want to print on one sheet of paper.

Linux printing

Printing from applications

There are a lot of Linux applications that allow you to print using Common UNIX Printing System (CUPS). You can print on your machine from any such application.

1. Open an application, and select **Print** from the **File** menu.
2. Select **Print** directly using lpr.
3. In the LPR GUI window, select the model name of your machine from the printer list and click **Properties**.

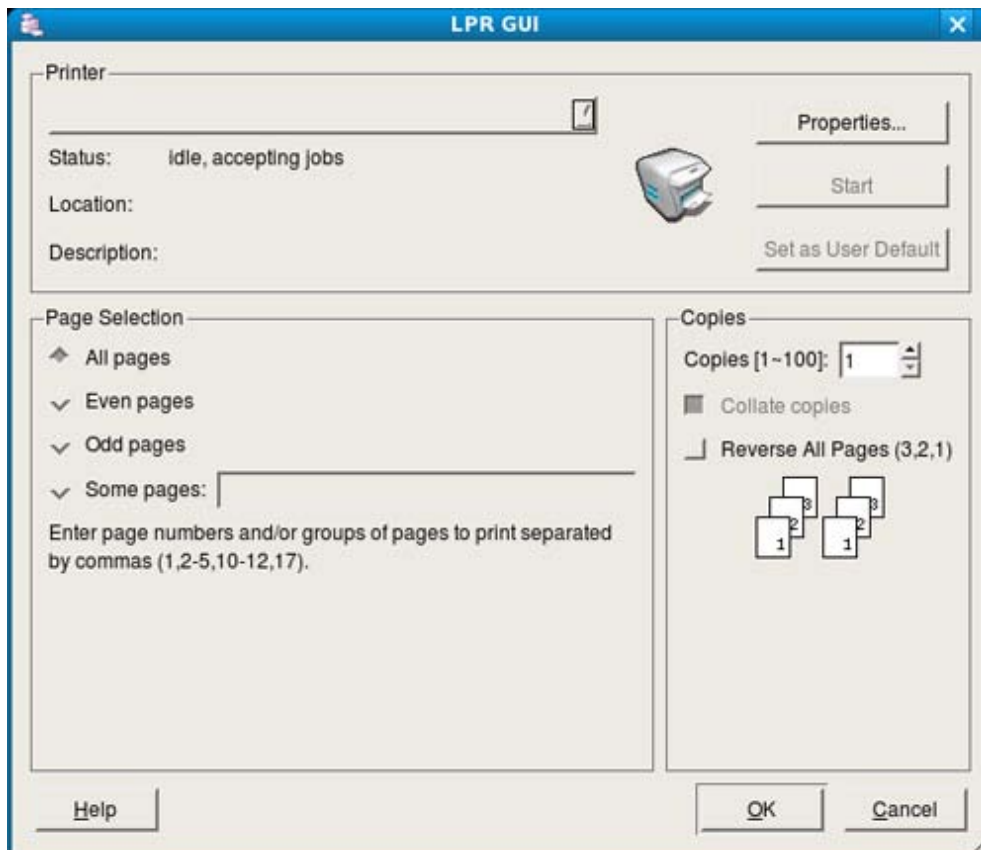

4. Change the print job properties using the following four tabs displayed at the top of the window.

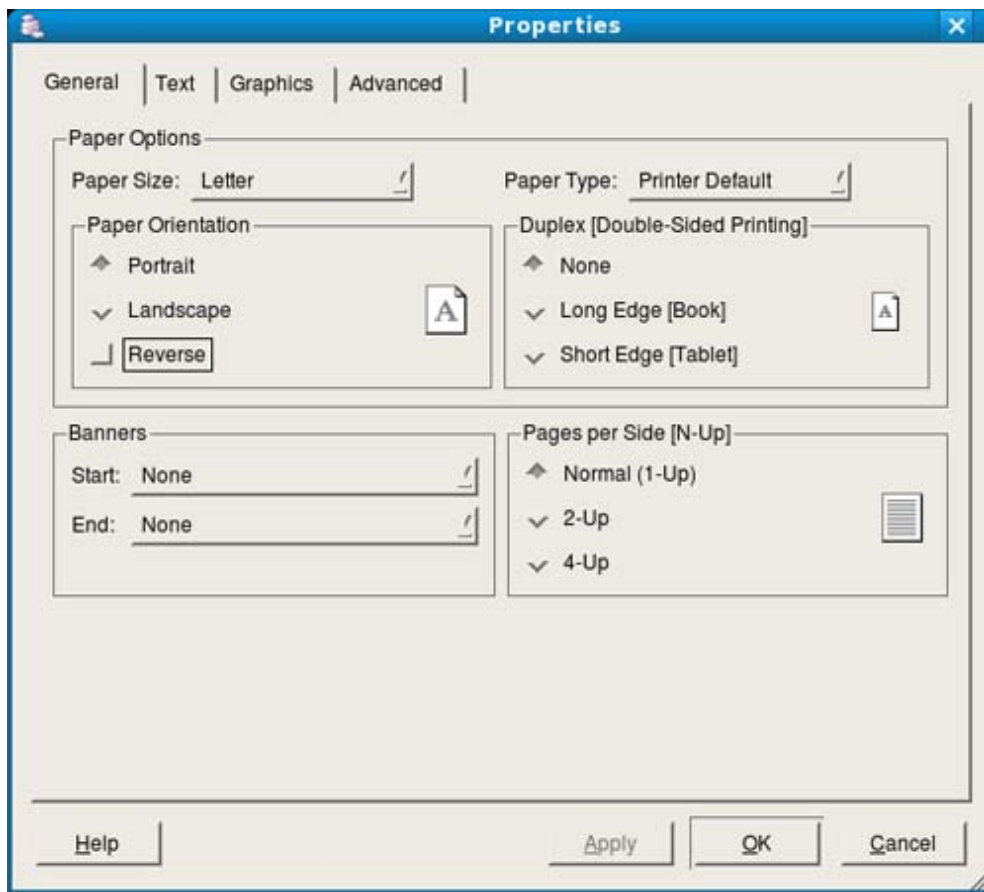

- **General:** This option allows you to change the paper size, the paper type, and the orientation of the documents. It enables the duplex feature, adds start and end banners, and changes the number of pages per sheet.
- **Text:** This option allows you to specify the page margins and set the text options, such as spacing or columns.
- **Graphics:** This option allows you to set image options that are used when printing images/files, such as color options, image size, or image position.
- **Advanced:** This option allows you to set the print resolution, paper source and special print features.



If an option is grayed out, it means that the grayed out option is not supported.

5. Click **Apply** to apply the changes and close the **Properties** window.
6. Click **OK** in the **LPR GUI** window to start printing.
7. The Printing window appears, allowing you to monitor the status of your print job.
To abort the current job, click **Cancel**.

Printing files

You can print many different types of files on your machine using the standard CUPS way, directly from the command line interface. The CUPS lpr utility allows you to do that. But the drivers package replaces the standard lpr tool by a much more user-friendly LPR GUI program.

To print any document file:

1. Type `lpr <file_name>` from the Linux shell command line and press Enter. The **LPR GUI** window appears.
When you type only `lpr` and press **Enter**, the **Select file(s) to print** window appears first. Just select any files you want to print and click **Open**.
2. In the **LPR GUI** window, select your machine from the list, and change the print job properties.
3. Click **OK** to start printing.

Configuring printer properties

Using the **Printer Properties** window provided by the **Printers configuration**, you can change the various properties for your machine as a printer.

1. Open the **Unified Driver Configurator**.
If necessary, switch to **Printers configuration**.
2. Select your machine on the available printers list and click **Properties**.

3. The **Printer Properties** window opens.

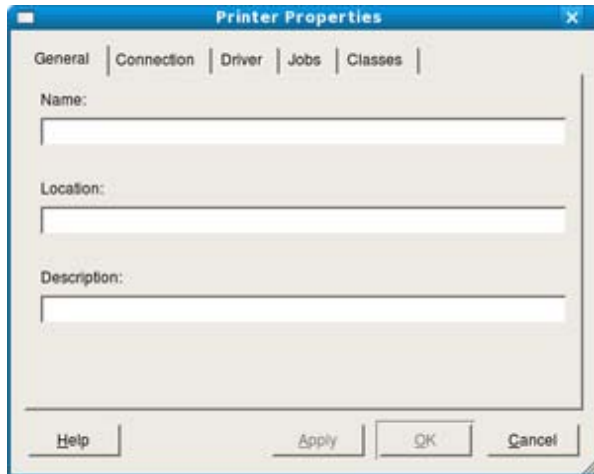

The following five tabs display at the top of the window:

- **General:** This option allows you to change the printer location and name. The name entered in this tab displays on the printer list in **Printers configuration**.
- **Connection:** This option allows you to view or select another port. If you change the machine port from USB to parallel or vice versa while in use, you must re-configure the machine port in this tab.
- **Driver:** Allows you to view or select another printer driver. By clicking **Options**, you can set the default device options.
- **Jobs:** This option shows the list of print jobs. Click **Cancel job** to cancel the selected job and select the **Show completed jobs** check box to see previous jobs on the job list.
- **Classes:** This option shows the class that your machine is in. Click **Add to Class** to add your machine to a specific class or click **Remove from Class** to remove the machine from the selected class.

4. Click **OK** to apply the changes and close the **Printer Properties** window.

Management tools

This chapter introduces management tools provided to help you make full use of your machine.

This chapter includes:

- [Introducing useful management tools](#)
- [Using Embedded Web Service \(Dell 1130n only\)](#)
- [Using the Printer Status Monitor](#)
- [Introducing useful management tools](#)
- [Using the printer settings utility](#)
- [Firmware update utility](#)
- [Using the Unified Linux Driver Configurator](#)

Introducing useful management tools

The programs below help you to use your machine conveniently.

- [Using Embedded Web Service \(Dell 1130n only\)](#).
- [Using the Printer Status Monitor](#).
- [Using the Unified Linux Driver Configurator](#).

Using Embedded Web Service (Dell 1130n only)

 Your Embedded Web Service window that appears in this user's guide may differ depending on the machine in use.

If you have connected your machine to a network and set up TCP/IP network parameters correctly, you can manage the machine via Embedded Web Service, an embedded web server. Use Embedded Web Service to:

- View the machine's device information and check its current status.
- Change TCP/IP parameters and set up other network parameters.
- Change printer preference.
- Set the email notifications advising of the machine's status.
- Get support for using the machine.

To access Embedded Web Service:

1. Access a web browser, such as Internet Explorer, from Windows.
Enter the machine IP address (http://xxx.xxx.xxx.xxx) in the address field and press the Enter key or click **Go**.
2. Your machine's embedded website opens.

Embedded Web Service overview

- **Information tab:** This tab gives you general information about your machine. You can check things, such as the machine's IP address, remaining amount of toner, ethernet information, firmware version, and so on. You can also print reports such as an error report and so on.
- **Machine Settings tab:** This tab allows you to set options provided by your machine.
- **Network Settings tab:** This tab allows you to view and change the network environment. You can set things, such as TCP/IP, enabling EtherTalk and so on.
- **Maintenance tab:** This tab allows you to maintain your machine by upgrading firmware and setting security information.
- **Support tab:** This tab allows you to set contact information for sending email. You can also connect to Dell website or download drivers by selecting Link.

E-mail notification setup

You can receive emails about your machine's status by setting this option. By setting information such as IP address, host name, e-mail address and SMTP server information, the machine status (toner cartridge shortage or machine error) will be sent to the specified e-mail address automatically. This option may be used more frequently by a machine administrator.

1. Start a web browser, such as Internet Explorer, from Windows.
Enter the machine IP address (http://xxx.xxx.xxx.xxx) in the address field and press the Enter key or click Go.
2. Your machine's embedded website opens.
3. From the **Machine Settings**, select **E-mail Notification Setup**.
4. Set required settings.
Set SMTP server information and other settings to use E-mail notification function. After setting the network environment, select the recipient list. And just by clicking a radio button, you can select in what case you want to receive an alert.
5. Click **Apply**.

Setting the contact information

Set the machine administrator information and this setting is necessary to use E-mail notification option.

1. Start a web browser, such as Internet Explorer, from Windows.
Enter the machine IP address (http://xxx.xxx.xxx.xxx) in the address field and press the Enter key or click **Go**.
2. Your machine's embedded website opens.
3. Select **Support**.
4. Enter the name of machine administrator, phone number, location or E-mail address.
5. Click **Apply**.

 If the firewall is activated, the E-mail may not be sent successfully. In that case, contact the a network administrator.

Using the Printer Status Monitor

The Printer Status Monitor program can only be used in the Windows system.

Printer Status Monitor is a program that monitors and informs you of the machine status. Printer Status Monitor is installed automatically when you install the machine software.

-  To use this program, you need the following system requirements:
- Windows. Check for windows operating system(s) compatible with your machine. (See [System requirements](#).)

Understanding Printer Status Monitor

If an error occurs while printing, you can check the error from the Printer Status Monitor.

You can launch it from the **Start** menu, select **Programs** or **All Programs** > **Dell** > **Dell Printers** > **your printer driver name** > **Printer Status Monitor**.

The Printer Status Monitor program displays the current status of the machine, the estimated level of toner remaining in the toner cartridge(s), and various other types of information.

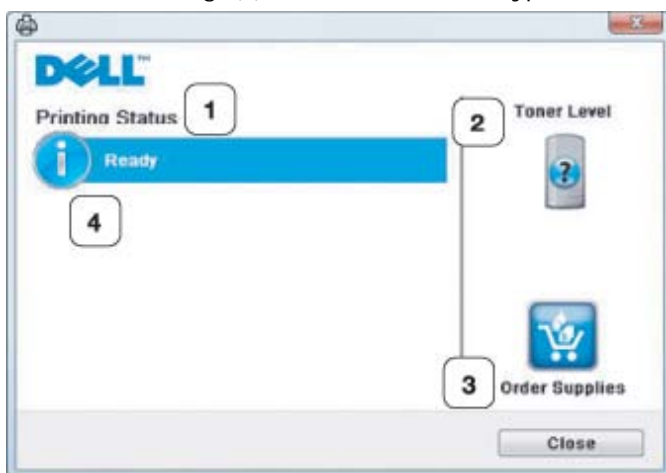

	Status	
2	Toner Level	View the level of toner remaining in the toner cartridge(s).
3	Order Supplies	Order replacement toner cartridge(s) online.
4	Help me	When error occurs, Help me button appears. You can directly open troubleshooting section in the user's guide.

Opening the Troubleshooting Guide

Find solutions for problems by using the **Troubleshooting Guide**.

Right-click the Printer Status Monitor icon and select **Troubleshooting Guide**.

Changing the Printer Status Monitor Program Settings

Right-click the Printer Status Monitor icon and select **Options**. Select the settings you want from the **Options** window.

Using the Dell Toner Management System™

The printer status monitor displays the status of the printer (printer ready, printer offline, and error-check printer) and the toner level (100%, 50%, Toner Low) for your printer. .

Using the printer settings utility

When you install the Dell software, the Printer Settings Utility is automatically installed.

To open the Printer Settings Utility.

If you are a Windows user, you can launch it from the **Start** menu, select **Programs** or **All Programs > Dell > Dell Printers > your printer driver name > Printer Settings Utility**.

The Printer Settings Utility window provides several features.

For more information, click the help icon button.

Firmware update utility

Firmware Update Utility allows you to maintain your machine by upgrading firmware.

If you are a Windows user, you can launch it from the **Start** menu, select **Programs** or **All Programs > Dell > Dell Printers > your printer driver name > Firmware Update Utility**.

Using the Unified Linux Driver Configurator

The supplied software CD provides you with the Unified Linux Driver package for using your machine with a Linux computer.

Unified Linux Driver Configurator is a tool primarily intended for configuring machine devices.

After the driver is installed on your Linux system, the Unified Linux Driver Configurator icon will automatically be created on your desktop.

Opening the Unified Driver Configurator

1. Double-click the **Unified Driver Configurator** on the desktop.
You can also click the **Startup** Menu icon and select **Dell Unified Driver > Unified Driver Configurator**.
2. Click each button on the left to switch to the corresponding configuration window.

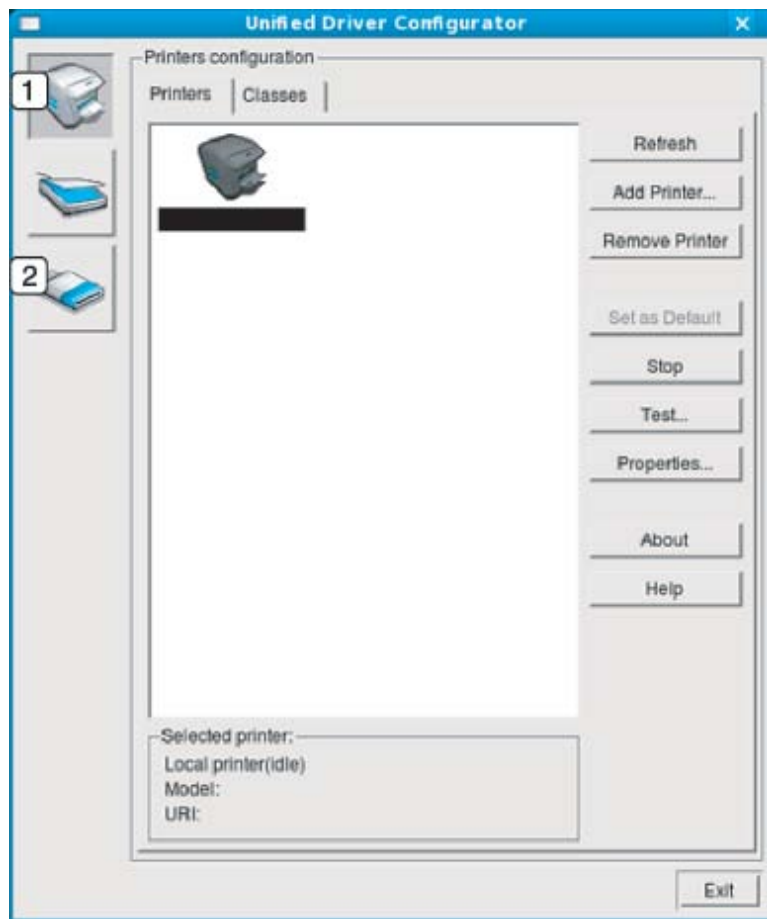

1. Printers Configuration
2. Ports Configuration

 To use the on screen help, click **Help**.

3. After changing the configurations, click **Exit** to close the Unified Driver Configurator.

Printers configuration

Printers configuration has the two tabs: **Printers** and **Classes**.

Printer tab

View the current system's printer configuration by clicking on the machine icon button on the left side of the Unified Driver Configurator window.

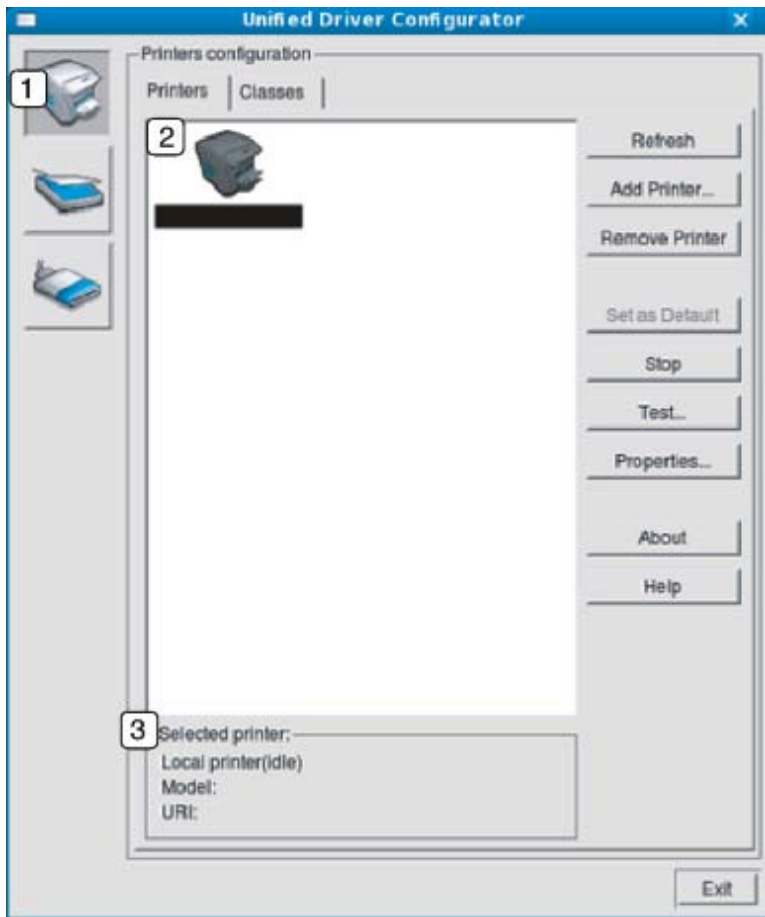

1	Switches to Printers configuration .
2	Shows all of the installed machine.
3	Shows the status, model name and URI of your machine.

The printer control buttons are, as follows:

- **Refresh:** Renews the available machines list.
- **Add Printer:** Allows you to add a new machines.
- **Remove Printer:** Removes the selected machine.
- **Set as Default:** Sets the current selected machine as a default machine.
- **Stop/Start:** Stops/starts the machine.
- **Test:** Allows you to print a test page to ensure the machine is working properly.
- **Properties:** Allows you to view and change the printer properties.

Classes tab

The Classes tab shows a list of available machine classes.

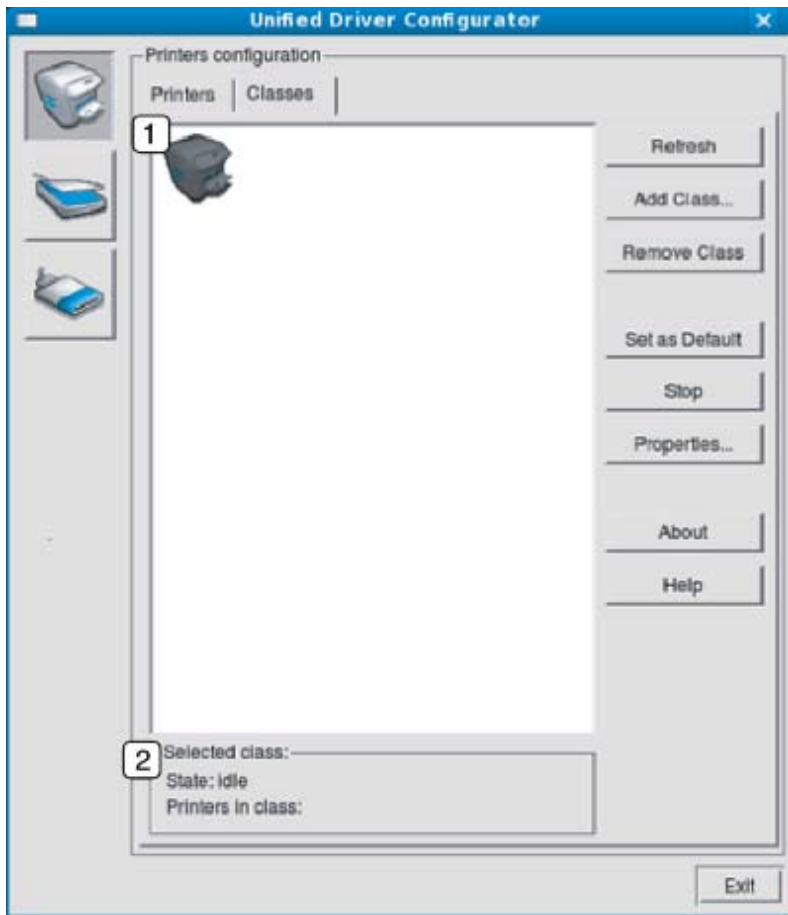

1	Shows all of the machine classes.
2	Shows the status of the class and the number of machines in the class.

- **Refresh:** Renews the classes list.
- **Add Class:** Allows you to add a new machine class.
- **Remove Class:** Removes the selected machine class.

Port configuration

In this window, you can view the list of available ports, check the status of each port and release a port that is stalled in a busy state when its owner has terminated the job for any reason.

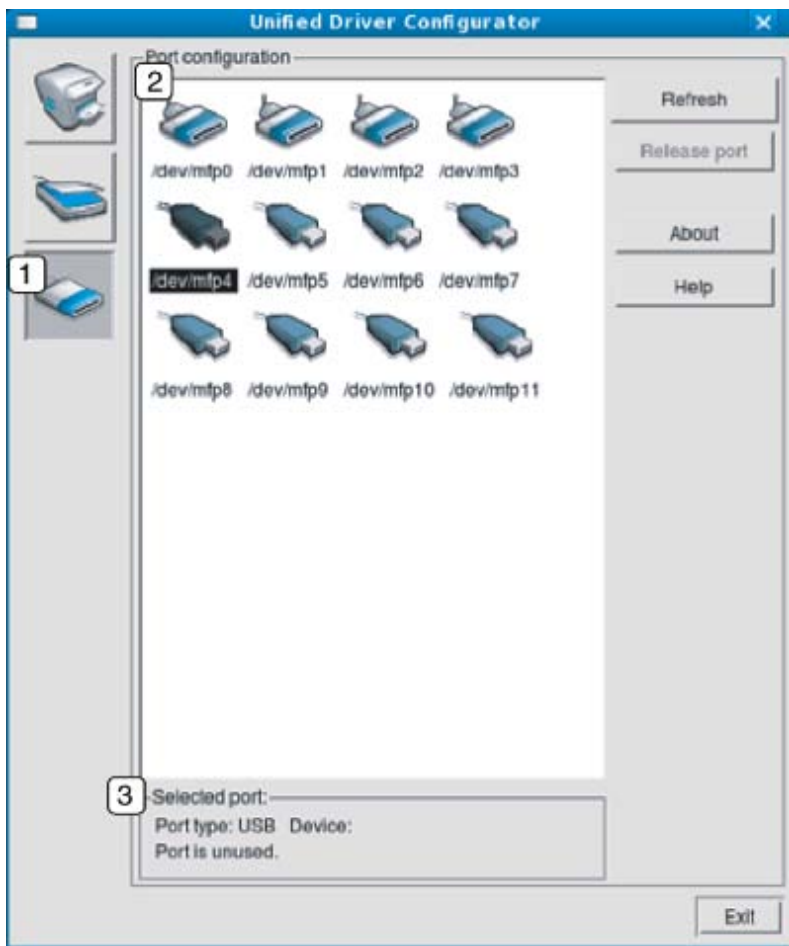

1	Switches to Ports configuration .
2	Shows all of the available ports.
3	Shows the port type, device connected to the port, and status.

- **Refresh**: Renews the available ports list.
- **Release port**: Releases the selected port.

Maintenance

This chapter provides information for maintaining your machine and the toner cartridge.

This chapter includes:

- [Printing a machine report](#)
- [Using toner low alert \(Dell 1130n only\)](#)
- [Cleaning a machine](#)
- [Storing the toner cartridge](#)
- [Tips for moving & storing your machine](#)

Printing a machine report

You can print a configuration page to view current printer settings, or to help troubleshoot printer problems.

In ready mode, press and hold the  (cancel button) for about 5 seconds.

A configuration page prints out.

For Dell 1130 this information is provided on the demo page.

Using toner low alert (Dell 1130n only)

If the amount of toner in the cartridge is low, the  /  LED blinks red. You can set the option for this  /  LED to blink or not.

1. Install the driver. (See [Installing USB connected machine's driver](#) or [Installing network connected machine's driver](#).)
2. You can launch it from the **Start** menu, select **Programs** or **All Programs** > **Dell** > **Dell Printers** > **your printer driver name** > **Printer Settings Utility**.
3. Click **Toner Low Alert**. Select the appropriate setting and then click **Apply**.

Cleaning a machine

If printing quality problems occur or if you use your machine in a dusty environment, you need to clean your machine regularly to keep the best printing condition and use your machine longer.

-  • Cleaning the cabinet of the machine with cleaning materials containing large amounts of alcohol, solvent, or other strong substances can discolor or distort the cabinet.
- If your machine or the surrounding area is contaminated with toner, we recommend you use cloth or tissue dampened with water to clean it. If you use a vacuum cleaner, toner blows in the air and might be harmful to you.

Cleaning the outside

Clean the machine cabinet with a soft, lint-free cloth. Dampen the cloth slightly with water, but be careful not to let any water drip onto or into the machine.

Printing a cleaning sheet (Dell 1130n only)

If you are experiencing blurred or smeared printouts, you can clear the problem by printing a cleaning sheet, provided by your machine.

To print the cleaning sheet:

In ready mode, press and hold the  (cancel button) for about 10 seconds.

- **OPC cleaning sheet:** Cleans the OPC drum of the toner cartridge.

This process will produce a page with toner debris, which should be discarded.

Your machine automatically picks up a sheet of paper from the tray and prints out a cleaning sheet with dust or toner particles on it.

Cleaning the inside

During the printing process, paper, toner, and dust particles can accumulate inside the machine. This buildup can cause print quality problems, such as toner specks or smearing. Cleaning the inside of the machine clears and reduces these problems.

1. Turn the machine off and unplug the power cord. Wait for the machine to cool down.
2. Open the front cover and pull the toner cartridge out. Set it on a clean flat surface

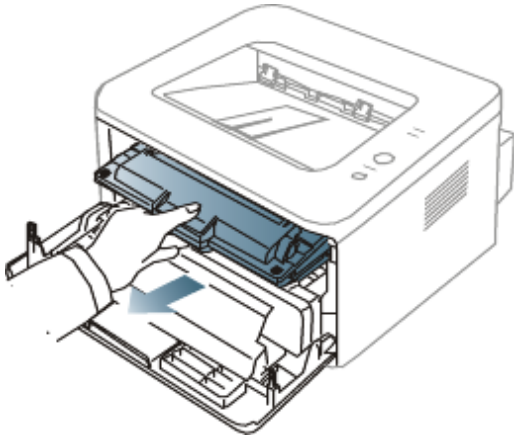

- To prevent damage to the toner cartridge, do not expose it to light for more than a few minutes. Cover it with a piece of paper, if necessary.
- Do not touch the green surface underside of the toner cartridge. Use the handle on the cartridge to avoid touching this area.

3. With a dry, lint-free cloth, wipe away any dust and spilled toner from the toner cartridge area.

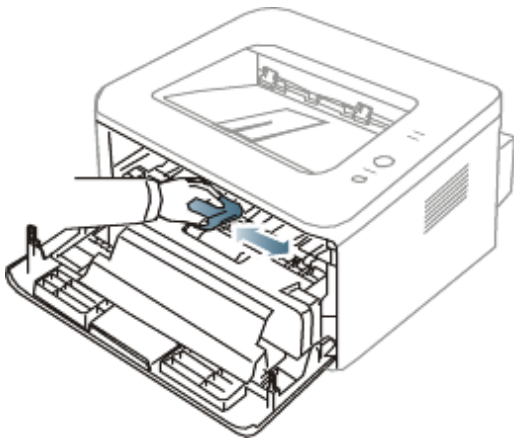

While cleaning the inside of the machine, be careful not to damage the transfer roller or any other inside parts. Do not use solvents such as benzene or thinner to clean. Printing quality problems can occur and cause damage to the machine.

4. Locate the long strip of glass (LSU) inside the machine and gently swab the glass to see if dirt turns the white cotton black.

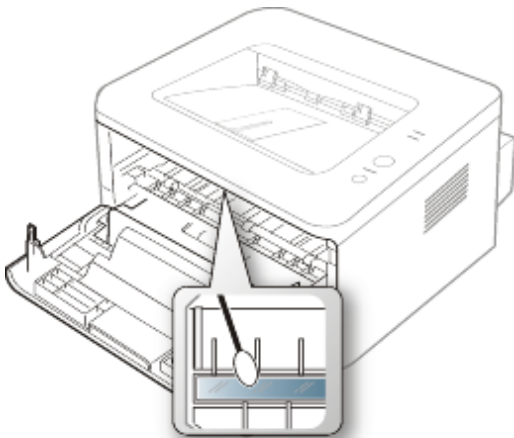

5. Reinsert the toner cartridge and close the front cover.

6. Plug in the power cord and turn the machine on.

Storing the toner cartridge

Toner cartridges contain components that are sensitive to light, temperature, and humidity. Dell suggests users follow the recommendations to ensure the optimum performance, highest quality, and longest life from your new Dell toner cartridge. Store this cartridge in the same environment as the printer it will be used in; this should be in controlled office temperature and humidity conditions. The toner cartridge should remain in its original, unopened package until installation – If original packaging is not available, cover the top opening of the cartridge with paper and store in a dark cabinet.

Opening the cartridge package prior to use dramatically shortens its useful shelf and operating life. Do not store on the floor. If the toner cartridge is removed from the printer, always store the cartridge:

- Inside the protective bag from the original package.
- Store lying flat (not standing on end) with the same side facing up as if they were installed in the machine.
- Do not store consumables in;
 - Temperature greater than 40°C (104°F).
 - Humidity range less than 20% nor not greater than 80%.
 - An environment with extreme changes in humidity or temperature.
 - Direct sunlight or room light.
 - Dusty places.
 - A car for a long period of time.
 - An environment where corrosive gases are present.
 - An environment with salty air.

Handling instructions

- Do not touch the surface of the photosensitive drum in the cartridge.
- Do not expose the cartridge to unnecessary vibrations or shock.
- Never manually rotate the drum, especially in the reverse direction; this can cause internal damage and toner spillage.

Use of non-Dell and refilled toner cartridge

Dell does not recommend or approve the use of non-Dell brand toner cartridges in your printer including generic, store brand, refilled, or remanufactured toner cartridges.

 Dell's printer warranty does not cover damage to the machine caused by the use of a refilled, remanufactured, or non-Dell brand toner cartridge.

Estimated cartridge life

Estimated cartridge life (the life of the toner cartridge yield) depends on the amount of toner that print jobs require. The actual print-out number may vary depending on the print density of the pages you print on, operating environment, printing interval, media type, and/or media size. For example, if you print a lot of graphics, the consumption of the toner is high and you may need to change the cartridge more often.

Tips for moving & storing your machine

- When moving the machine, do not tilt or turn it upside down. Otherwise, the inside of the machine may be contaminated by toner, which can cause damage to the machine or bad print quality.
- When moving the machine, make sure at least two people are holding the machine securely.

Troubleshooting

This chapter gives helpful information for what to do if you encounter an error.

This chapter includes:

- [Redistributing toner](#)
- [Tips for avoiding paper curls](#)
- [Tips for avoiding paper jams](#)
- [Clearing paper jams](#)
- [Solving other problems](#)

Redistributing toner

When the toner cartridge is near the end of its life:

- White streaks or light printing occurs.
- The ↔ / ⚠ LED blinks red.

If this happens, you can temporarily improve print quality by redistributing the remaining toner in the cartridge. In some cases, white streaks or light printing will still occur even after you have redistributed the toner.

1. Open the front cover.
2. Pull the toner cartridge out.

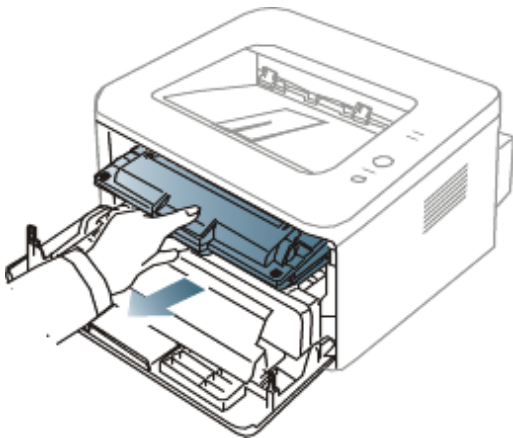

3. Thoroughly roll the cartridge five or six times to distribute the toner evenly inside the cartridge.

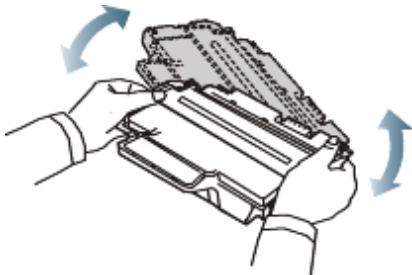

 If toner gets on your clothing, wipe it off with a dry cloth and wash clothing in cold water. Hot water sets toner into fabric.

 Do not touch the green underside of the toner cartridge. Use the handle on the cartridge to avoid touching this area.

4. Hold the toner cartridge by the handle and slowly insert the cartridge into the opening in the machine. Tabs on the sides of the cartridge and corresponding grooves within the machine will guide the cartridge into the correct position until it locks into place completely.

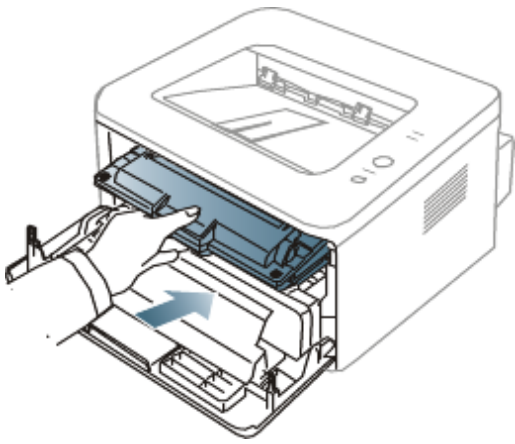

5. Close the front cover. Ensure that the cover is securely closed.

Tips for avoiding paper curls

1. Open the rear cover.
2. Pull down the pressure lever on each side.

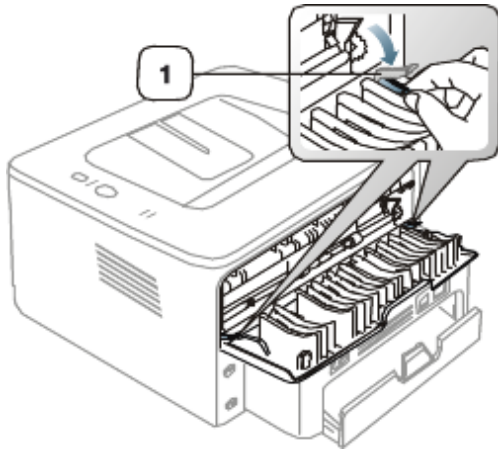

1. Pressure lever

-  Keep the rear cover opened during printing. Only use when the printout has more than 20 mm curl.





Tips for avoiding paper jams

By selecting the correct media types, most paper jams can be avoided. When a paper jam occurs, refer to the next guidelines.

- Ensure that the adjustable guides are positioned correctly. (See [Loading paper in the tray.](#))
- Do not overload the tray. Ensure that the paper level is below the paper capacity mark on the inside of the tray.
- Do not remove paper from the tray while your machine is printing.
- Flex, fan, and straighten paper before loading.
- Do not use creased, damp, or highly curled paper.
- Do not mix paper types in a tray.
- Use only recommended print media.
- Ensure that the recommended side of the print media is facing down in the tray, or facing up in the manual tray.

Clearing paper jams

If a paper jam occurs, the  LED on the control panel lights orange. Find and remove the jammed paper. To resume printing after clearing paper jams, you must open and close the front cover.

 To avoid tearing the paper, pull the jammed paper out slowly and gently. Follow the instructions in the following sections to clear the jam.

In tray

 [Click this link to open an animation about clearing a jam.](#)

1. Open and close the front cover. The jammed paper is automatically ejected from the machine.
If the paper does not exit, go to the next step.
2. Pull out tray.

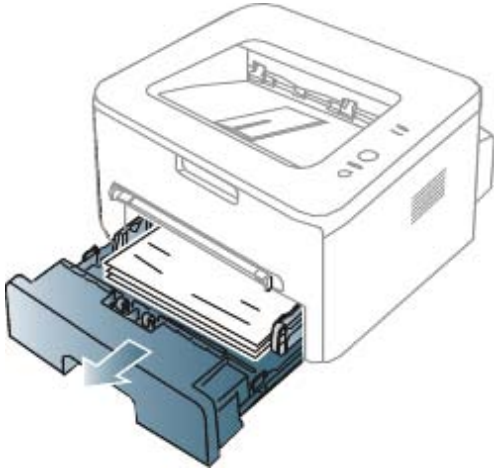

3. Remove the jammed paper by gently pulling it straight out.

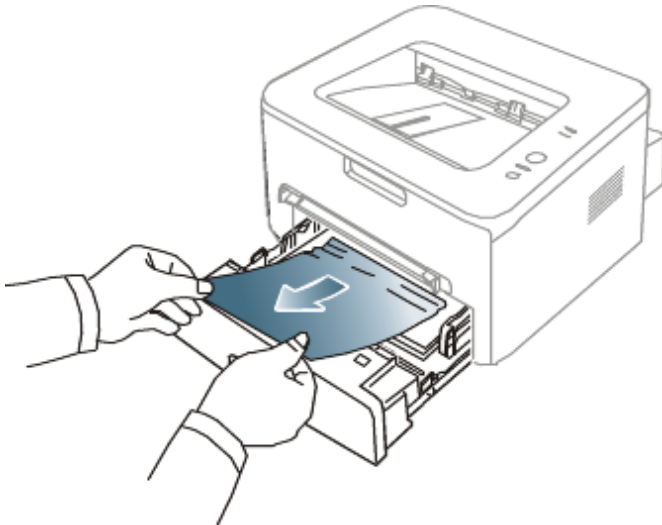

If the paper does not move when you pull, or if you do not see the paper in this area, check the fuser area around the toner cartridge. (See [Inside the machine.](#))

4. Insert tray back into the machine until it snaps into place. Printing automatically resumes.

In the manual tray

 [Click this link to open an animation about clearing a jam.](#)

1. If the paper is not feeding properly, pull the paper out of the machine.

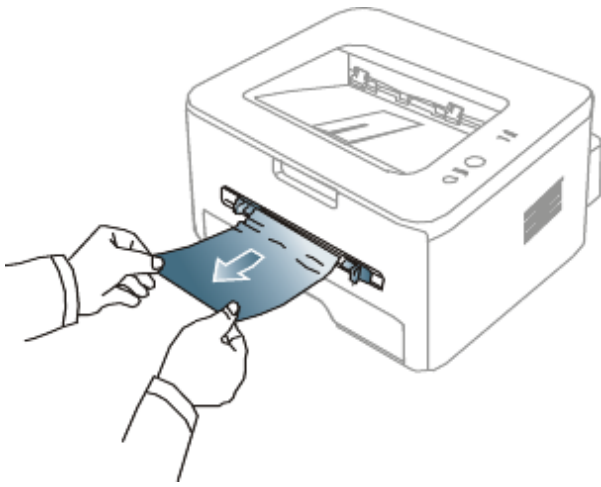

2. Open and close the front cover to resume printing.

Inside the machine

 [Click this link to open an animation about clearing a jam.](#)

 The fuser area is hot. Take care when removing paper from the machine.

1. Open the front cover and pull the toner cartridge out, lightly pushing it down.

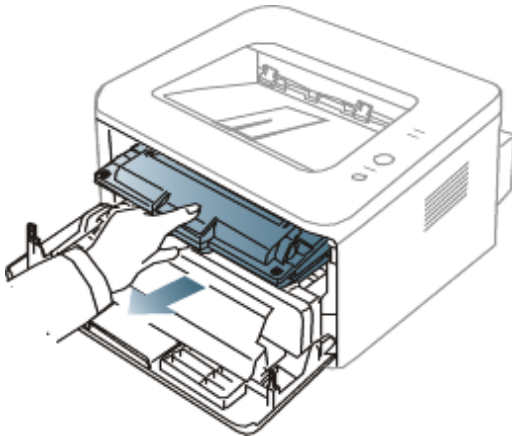

2. Remove the jammed paper by gently pulling it straight out.

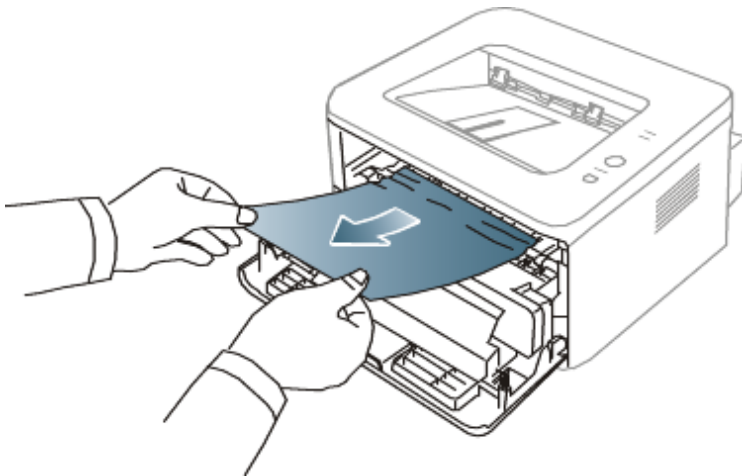

3. Replace the toner cartridge and close the front cover. Printing automatically resumes.

In exit area

 [Click this link to open an animation about clearing a jam.](#)

1. Open and close the front cover. The jammed paper is automatically ejected from the machine.
If you do not see the jammed paper, go to next step.

2. Gently pull the paper out of the output tray.

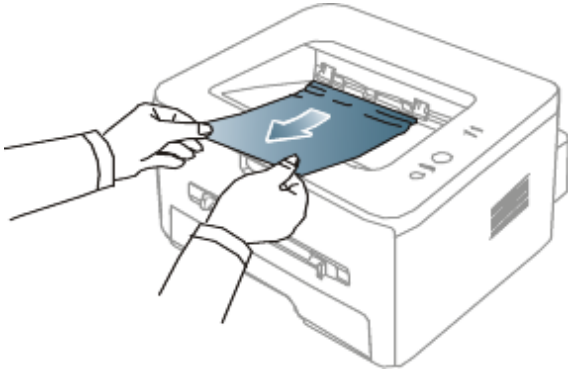

If you do not see the jammed paper or if there is any resistance when you pull, stop and go to the next step.

3. Open the rear cover.
4. Pull the pressure levers down and remove the paper.
Return the pressure levers to their original position.

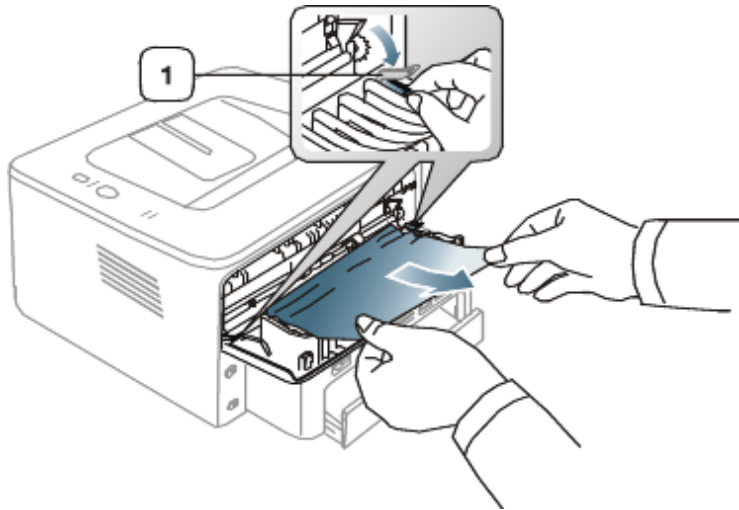

1. Pressure lever

If you do not see the jammed paper, go to next step.

5. Pull the fuser cover levers down and remove the paper.
Return the fuser cover levers to their original position.

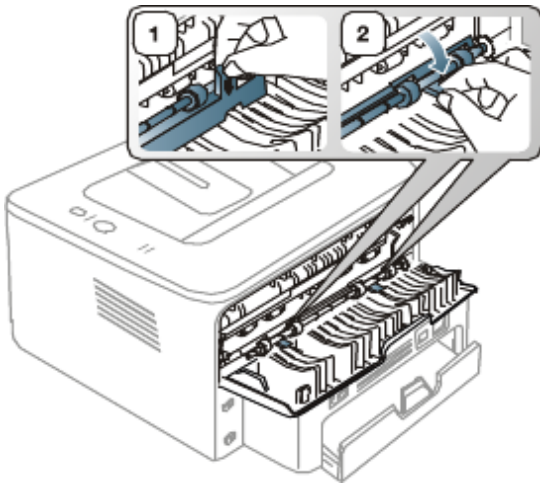

 The fuser area is hot. Take care when removing paper from the machine.



6. Close the rear cover.
7. Open and close front cover, printing automatically resumes.

Solving other problems

The following chart lists some conditions that may occur and the recommended solutions. Follow the suggested solutions until the problem is corrected. If the problem persists, call for service.

Power problems

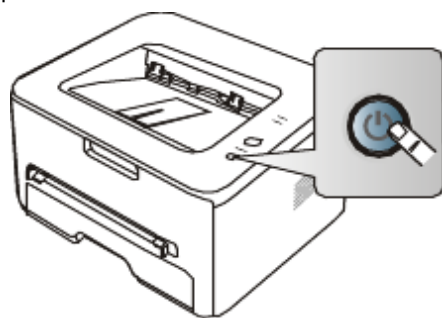
 [Click this link to open an animation about power problems.](#)

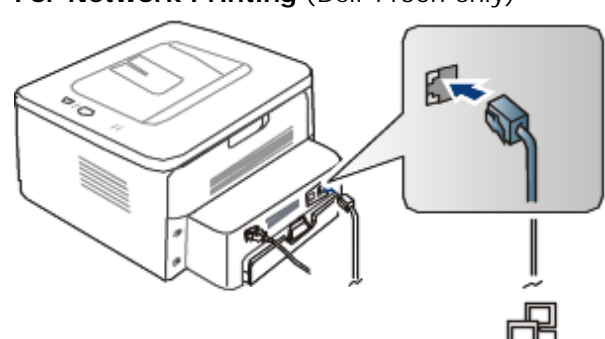
Condition	Suggested solutions
<p>The machine is not receiving power, or the connection cable between the computer and the machine is not connected properly.</p>	<ul style="list-style-type: none"> • Plug in the power cord and press  (power) on the control panel.  <ul style="list-style-type: none"> • Disconnect the machine cable and reconnect it. <ul style="list-style-type: none"> ◦ For Local Printing  <ul style="list-style-type: none"> ◦ For Network Printing (Dell 1130n only) 

Paper feeding problems

Condition	Suggested solutions
<p>Paper jams during printing.</p>	<p>Clear the paper jam. (See Clearing paper jams.)</p>
<p>Paper sticks together.</p>	<ul style="list-style-type: none"> • Check the maximum paper capacity of the tray. (See Print media specifications.) • Make sure that you are using the correct type of paper. (See Print media specifications.) • Remove paper from the tray and flex or fan the paper. • Humid conditions may cause some paper to stick together.
<p>Multiple sheets of paper do not feed.</p>	<p>Different types of paper may be stacked in the tray. Load paper of only one type, size, and weight.</p>
<p>Paper does not feed into the machine.</p>	<ul style="list-style-type: none"> • Remove any obstructions from inside the machine. • Paper has not been loaded correctly. Remove paper from the tray and reload it correctly.

	<ul style="list-style-type: none"> • There is too much paper in the tray. Remove excess paper from the tray. • The paper is too thick. Use only paper that meets the specifications required by the machine. (See Print media specifications.)
The paper keeps jamming.	<ul style="list-style-type: none"> • There is too much paper in the tray. Remove excess paper from the tray. If you are printing on special materials, use the manual tray. • An incorrect type of paper is being used. Use only paper that meets the specifications required by the machine. (See Print media specifications.) • There may be debris inside the machine. Open the front cover and remove any debris.
Transparencies stick together in the paper exit.	Use only transparencies specifically designed for laser printers. Remove each transparency as it exits from the machine.
Envelopes skew or fail to feed correctly.	Ensure that the paper guides are against both sides of the envelopes.

Printing problems

Condition	Possible cause	Suggested solutions
The machine does not print.	The machine is not receiving power.	Check the power cord connections.
	The machine is not selected as the default machine.	Select your machine as your default machine in your Windows.
	Check the machine for the following: <ul style="list-style-type: none"> • The front cover is not closed. Close the front cover. • Paper is jammed. Clear the paper jam. (See Clearing paper jams.) • No paper is loaded. Load paper. (See Loading paper in the tray.) • The toner cartridge is not installed. Install the toner cartridge. If a system error occurs, contact your service representative.	
	The connection cable between the computer and the machine is not connected properly.	Disconnect the machine cable and reconnect it.
	The connection cable between the computer and the machine is defective.	If possible, attach the cable to another computer that is working properly and print a job. You can also try using a different machine cable.
	The port setting is incorrect.	Check the Windows printer setting to make sure that the print job is sent to the correct port. If the computer has more than one port, make sure that the machine is attached to the correct one.
	The machine may be configured incorrectly.	Check the Printing Preferences to ensure that all of the print settings are correct. (See Opening printing preferences.)
	The printer driver may be incorrectly installed.	Repair the machine software. (See Installing USB connected machine's driver , Installing network connected machine's driver.)
	The machine is malfunctioning.	<ul style="list-style-type: none"> • Check the LEDs on the control panel to see if the machine is indicating a system error. Contact a service representative. • Checking an error message is also possible from the Printer Status Monitor on your computer.
The machine does not print.	The document size is so big that the hard disk space of the computer is insufficient to access the print job.	Get more hard disk space and print the document again.
	The output tray is full.	It can hold up to 80 sheets of plain paper. Once the paper is removed from the output tray, the machine resumes printing.
The machine selects print	The paper option that was	For many software applications, the paper source selection is

materials from the wrong paper source.	selected in the Printing Preferences may be incorrect.	found under the Paper tab within the Printing Preferences . Select the correct paper source. See the printer driver help screen. (See Opening printing preferences.)
A print job is extremely slow.	The job may be very complex.	Reduce the complexity of the page or try adjusting the print quality settings.
Half the page is blank.	The page orientation setting may be incorrect.	Change the page orientation in your application. See the printer driver help screen.
	The paper size and the paper size settings do not match.	Ensure that the paper size in the printer driver settings matches the paper in the tray.Or, ensure that the paper size in the printer driver settings matches the paper selection in the software application settings you use.
The machine prints, but the text is wrong, garbled, or incomplete.	The machine cable is loose or defective.	Disconnect the machine cable and reconnect. Try a print job that you have already printed successfully. If possible, attach the cable and the machine to another computer that you know works and try a print job. Finally, try a new machine cable.
	The wrong printer driver was selected.	Check the application's printer selection menu to ensure that your machine is selected.
	The software application is malfunctioning.	Try printing a job from another application.
	The operating system is malfunctioning.	Exit Windows and reboot the computer. Turn the machine off and back on again.
	If you are in a DOS environment, the font setting for your machine may be set incorrectly.	See Changing font setting (Dell 1130n only) .
Pages print, but they are blank.	The toner cartridge is defective or out of toner.	Redistribute the toner, if necessary. If necessary, replace the toner cartridge.
	The file may have blank pages.	Check the file to ensure that it does not contain blank pages.
	Some parts, such as the controller or the board, may be defective.	Contact a service representative.
The machine does not print PDF file correctly. Some parts of graphics, text, or illustrations are missing.	Incompatibility between the PDF file and the Acrobat products.	Printing the PDF file as an image may enable the file to print. Turn on Print As Image from the Acrobat printing options.  It will take longer to print when you print a PDF file as an image.
The print quality of photos is not good. Images are not clear.	The resolution of the photo is very low.	Reduce the photo size. If you increase the photo size in the software application, the resolution will be reduced.
Before printing, the machine emits vapor near the output tray.	Using damp paper can cause vapor during printing.	This is not a problem. Just keep printing.
The machine does not print special- sized paper, such as billing paper.	Paper size and paper size setting do not match.	Set the correct paper size in the Edit... in the Paper tab in the Printing Preferences . (See Opening printing preferences.)

Printing quality problems

If the inside of the machine is dirty or paper has been loaded improperly, there might be a reduction in print quality. See the table below to clear the problem.

Condition	Suggested Solutions
Light or faded print	<ul style="list-style-type: none"> If a vertical white streak or faded area appears on the page, the toner supply is low. You may be able to temporarily extend the toner cartridge life. (See Redistributing toner.) If this does not improve the print quality, install a new toner cart The paper may not meet paper specifications; for example, the paper may be too moist or rough. (See Print media specifications.)

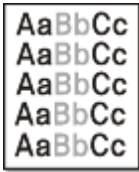

- If the entire page is light, the print resolution setting is too low or the toner save mode is on. Adjust the print resolution and turn the toner save mode off. See the help screen of the printer driver.
- A combination of faded or smeared defects may indicate that the toner cartridge needs cleaning. (See [Cleaning the inside.](#))
- The surface of the LSU part inside the machine may be dirty. (See [Cleaning the inside.](#))

Toner specks



- The paper may not meet specifications; for example, the paper may be too moist or rough. (See [Print media specifications.](#))
- The transfer roller may be dirty. Clean the inside of your machine. Contact a service representative.
- The paper path may need cleaning. Contact a service representative.

Dropouts

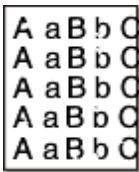

If faded areas, generally rounded, occur randomly on the page:

- A single sheet of paper may be defective. Try reprinting the job.
- The moisture content of the paper is uneven or the paper has moist spots on its surface. Try a different brand of paper. (See [Print media specifications.](#))
- The paper lot is bad. The manufacturing processes can cause some areas to reject toner. Try a different kind or brand of paper.
- Change the printer option and try again. Go to **Printing Preferences**, click **Paper** tab, and set type to **Thick**. (See [Opening printing preferences.](#))
- If these steps do not correct the problem, contact a service representative.

White Spots

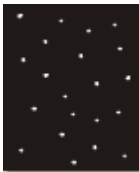

If white spots appear on the page:

- The paper is too rough and a lot of dirt from a paper falls to the inner devices within the machine, so the transfer roller may be dirty. Clean the inside of your machine. (See [Cleaning the inside.](#))
- The paper path may need cleaning. (See [Cleaning the inside.](#))

Vertical lines

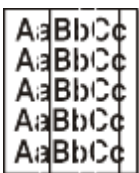

If black vertical streaks appear on the page:

- The surface (drum part) of the toner cartridge inside the machine has probably been scratched. Remove the toner cartridge and install a new one. (See [Replacing the toner cartridge.](#))

If white vertical streaks appear on the page:

- The surface of the LSU part inside the machine may be dirty. (See [Cleaning the inside.](#))

Black background



If the amount of background shading becomes unacceptable:



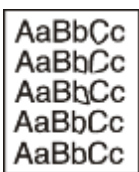

- Change to a lighter weight paper. (See [Print media specifications.](#))
- Check the environmental conditions: very dry conditions or a high level of humidity (higher than 80% RH) can increase the amount of background shading.
- Remove the old toner cartridge and, install a new one. (See [Replacing the toner cartridge.](#))



Toner smear

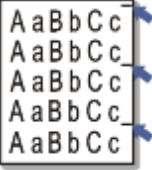

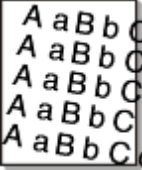
If toner smears on the page:

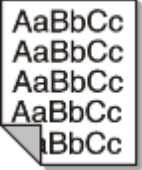
- Clean the inside of the machine. (See [Cleaning the inside.](#))
- Check the paper type and quality. (See [Print media specifications.](#))
- Remove the toner cartridge and then, install a new one. (See [Replacing the toner cartridge.](#))

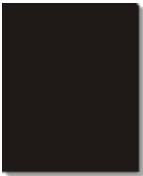
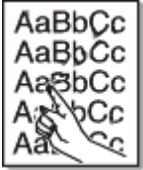
<p>Vertical repetitive defects</p> 	<p>If marks repeatedly appear on the printed side of the page at even intervals:</p> <ul style="list-style-type: none"> • The toner cartridge may be damaged. If you still have the same problem, remove the toner cartridge and, install a new one. (See Replacing the toner cartridge.) • Parts of the machine may have toner on them. If the defects occur on the back of the page, the problem will likely correct itself after a few more pages. • The fusing assembly may be damaged. Contact a service representative.
<p>Background scatter</p> 	<p>Background scatter results from bits of toner randomly distributed on the printed page.</p> <ul style="list-style-type: none"> • The paper may be too damp. Try printing with a different batch of paper. Do not open packages of paper until necessary so that the paper does not absorb too much moisture. • If background scatter occurs on an envelope, change the printing layout to avoid printing over areas that have overlapping seams on the reverse side. Printing on seams can cause problems. • If background scatter covers the entire surface area of a printed page, adjust the print resolution through your software application or in Printing Preferences. (See Opening printing preferences.)
<p>Misformed characters</p> 	<ul style="list-style-type: none"> • If characters are improperly formed and producing hollow images, the paper stock may be too slick. Try different paper. (See Print media specifications.)
<p>Page skew</p> 	<ul style="list-style-type: none"> • Ensure that the paper is loaded properly. • Check the paper type and quality. (See Print media specifications.) • Ensure that the guides are not too tight or too loose against the paper stack.
<p>Curl or wave</p> 	<ul style="list-style-type: none"> • Ensure that the paper is loaded properly. • Check the paper type and quality. Both high temperature and humidity can cause paper curl. (See Print media specifications.) • Turn the stack of paper over in the tray. Also try rotating the paper 180° in the tray.
<p>Wrinkles or creases</p> 	<ul style="list-style-type: none"> • Ensure that the paper is loaded properly. • Check the paper type and quality. (See Print media specifications.) • Turn the stack of paper over in the tray. Also try rotating the paper 180° in the tray.
<p>Back of printouts are dirty</p> 	<p>Check for leaking toner. Clean the inside of the machine. (See Cleaning the inside.)</p>
<p>Solid Color or Black pages</p>	<ul style="list-style-type: none"> • The toner cartridge may not be installed properly. Remove the cartridge and reinsert it. • The toner cartridge may be defective. Remove the toner cartridge and install a new one. (See Replacing the toner cartridge.)

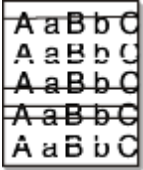
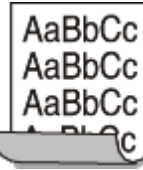
	<p>The machine may require repair. Contact a service representative.</p>
<p>Loose toner</p> 	<ul style="list-style-type: none"> • Clean the inside of the machine. (See Cleaning the inside.) • Check the paper type and quality. (See Print media specifications.) • Remove the toner cartridge and then, install a new one. (See Replacing the toner cartridge.) • If the problem persists, the machine may require repair. Contact a service representative.
<p>Character Voids</p> 	<p>Character voids are white areas within parts of characters that should be solid black:</p> <ul style="list-style-type: none"> • If you are using transparencies, try another type of transparency. Because of the composition of transparencies, some character voids are normal. • You may be printing on the wrong surface of the paper. Remove the paper and turn it around. • The paper may not meet paper specifications. (See Print media specifications.)
<p>Horizontal stripes</p> 	<p>If horizontally aligned black streaks or smears appear:</p> <ul style="list-style-type: none"> • The toner cartridge may be installed improperly. Remove the cartridge and reinsert it. • The toner cartridge may be defective. Remove the toner cartridge and install a new one. (See Replacing the toner cartridge.) • If the problem persists, the machine may require repair. Contact a service representative.
<p>Curl</p> 	<p>If the printed paper is curled or paper does not feed into the machine:</p> <ul style="list-style-type: none"> • Turn the stack of paper over in the tray. Also try rotating the paper 180° in the tray. • Change the printer option and try again. Go to Printing Preferences, click Paper tab, and set type to Thin. (See Opening printing preferences.)
<p>An unknown image repetitively appears on a few sheets or loose toner, light print, or contamination occurs.</p>	<p>Your machine is probably being used at an altitude of 1,000 m (3,281 ft) or above. The high altitude may affect the print quality, such as loose toner or light imaging. Change the correct altitude setting to your machine. (See Altitude adjustment.)</p>

Common Windows problems

Condition	Suggested solutions
<p>"File in Use" message appears during installation.</p>	<p>Exit all software applications. Remove all software from the startup group, then restart Windows. Reinstall the printer driver.</p>
<p>"General Protection Fault", "Exception OE", "Spool 32", or "Illegal Operation" messages appear.</p>	<p>Close all other applications, reboot Windows and try printing again.</p>
<p>"Fail To Print", "A printer timeout error occurred" messages appear.</p>	<p>These messages may appear during printing. Just keep waiting until the machine finishes printing. If the message appears in ready mode or after printing has been completed, check the connection and/or whether an error has occurred.</p>

 Refer to Microsoft Windows User's Guide that came with your computer for further information on Windows error messages.

Common Linux problems

condition	Suggested solutions

The machine does not print.	<ul style="list-style-type: none"> • Check if the printer driver is installed in your system. Open Unified Driver Configurator and switch to the Printers tab in Printers configuration window to look at the list of available machines. Make sure that your machine is displayed on the list. If not, open Add new printer wizard to set up your device. • Check if the machine is started. Open Printers configuration and select your machine on the printers list. Look at the description in the Selected printer pane. If its status contains Stopped string, press the Start button. After that normal operation of the machine should be restored. The “stopped” status might be activated when some problems in printing occurred. • Check if your application has special print option such as “-oraw”. If “-oraw” is specified in the command line parameter, then remove it to print properly. For Gimp front-end, select “print” -> “Setup printer” and edit command line parameter in the command item.
The machine does not print whole pages, and output is printed on half the page.	It is a known problem that occurs when a color machine is used on version 8.51 or earlier of Ghostscript, 64-bit Linux OS, and has been reported to bugs.ghostscript.com as Ghostscript Bug 688252. The problem is solved in AFPL Ghostscript v. 8.52 or above. Download the latest version of AFPL Ghostscript from http://sourceforge.net/projects/ghostscript/ and install it to solve this problem.
I encounter error “Cannot open port device file” when printing a document.	Avoid changing print job parameters (via LPR GUI, for example) while a print job is in progress. Known versions of CUPS server break the print job whenever print options are changed and then try to restart the job from the beginning. Since Unified Linux Driver locks the port while printing, the abrupt termination of the driver keeps the port locked and unavailable for subsequent print jobs. If this situation occurs, try to release the port by selecting Release port in Port configuration window.

 Refer to Linux User’s Guide that came with your computer for further information on Linux error messages.

Common Macintosh problems

condition	Suggested solutions
The machine does not print PDF files correctly. Some parts of graphics, text, or illustrations are missing.	Printing the PDF file as an image may enable the file to print. Turn on Print As Image from the Acrobat printing options.  It will take longer to print when you print a PDF file as an image.
The document has printed, but the print job has not disappeared from the spooler in Mac OS X 10.3.2.	Update your Mac OS to OS Mac OS X 10.3.3. or higher.
Some letters are not displayed normally during the Cover page printing.	Mac OS cannot create the font during the Cover page printing. The English alphabet and numbers are displayed normally on the Cover page.
When printing a document in Macintosh with Acrobat Reader 6.0 or higher, colors print incorrectly.	Make sure that the resolution setting in your machine driver matches the one in Acrobat® Reader®.

 Refer to Macintosh User’s Guide that came with your computer for further information on Macintosh error messages.

Supplies

This chapter provides information on purchasing supplies and maintenance parts available for your machine.

This chapter includes:

- [How to purchase](#)
- [Available supplies](#)
- [Replacing the toner cartridge](#)

 Available accessories may differ from country to country. Contact your sales representatives to obtain the list of available accessories.

How to purchase

To order Dell-authorized supplies and accessories visit www.dell.com/supplies, or contact your local Dell dealer or the retailer where you purchased your machine. You can also visit www.dell.com or support.dell.com, select your country/region, and obtain information on calling for service.



Available supplies

When supplies reach their lifespan, you can order the following types of supplies for your machine:

Type	Average yield ^[a]	Part name
Standard capacity toner cartridge	Approx. 1,500 pages	3J11D
High capacity toner cartridge	Approx. 2,500 pages	2MMJP

[a] Declared yield value in accordance with ISO/IEC 19752.

To replace a toner cartridge see [Replacing the toner cartridge](#).

-  Depending on the options and job mode used, the toner cartridge's lifespan may differ.
-  You must purchase supplies, including toner cartridges, in the same country where you purchased your machine. Otherwise, supplies will be incompatible with your machine since the system configuration of these vary from country to country.
-  Dell does not recommend using non-genuine Dell toner cartridge such as refilled or remanufactured. Dell cannot guarantee non-genuine Dell toner cartridge's quality. Service or repair required as a result of using non-genuine Dell toner cartridges will not be covered under the machine warranty.

Replacing the toner cartridge

 [Click this link to open an animation about replacing a toner cartridge.](#)

When the toner cartridge reaches its estimated cartridge life:

- The Printer Status Monitor program window appears on the computer telling you the toner cartridge needs to be replaced.
- The machine stops printing.

At this stage, the toner cartridge needs to be replaced. Check the type of the toner cartridge for your machine. (See [Available supplies](#).)

1. Open the front cover.
2. Pull the toner cartridge out.

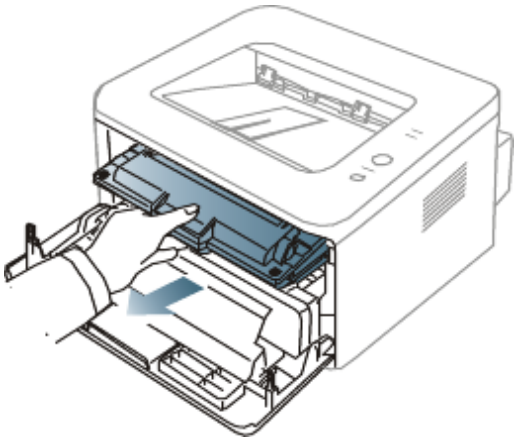

3. Take a new toner cartridge out of its package.
4. Remove the paper protecting the toner cartridge by pulling the packing tape.

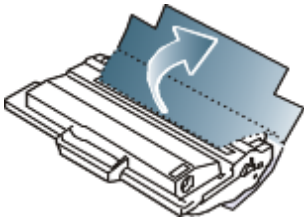

5. Locate the sealing tape at the end of the toner cartridge. Carefully pull the tape completely out of the cartridge and discard it.

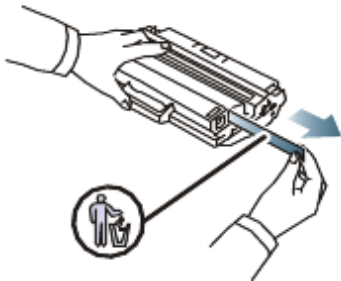

- The sealing tape should be longer than 60 cm when correctly removed.
- Holding the toner cartridge, pull the sealing tape straight to remove it from the cartridge. Be careful not to cut the tape. If this happens, you cannot use the toner cartridge.
- Refer to the helpful pictures on the cartridge wrapping paper.

6. Slowly shake the cartridge five or six times to distribute the toner evenly inside the cartridge. It will assure maximum copies per cartridge.

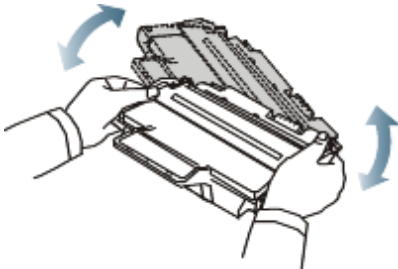

If toner gets on your clothing, wipe it off with a dry cloth and wash clothing in cold water. Hot water sets toner into fabric.



Do not touch the green underside of the toner cartridge. Use the handle on the cartridge to avoid touching this area.

7. Hold the toner cartridge by the handle and slowly insert the cartridge into the opening in the machine. Tabs on the sides of the cartridge and corresponding grooves within the machine will guide the cartridge into the correct position until it locks into place completely.

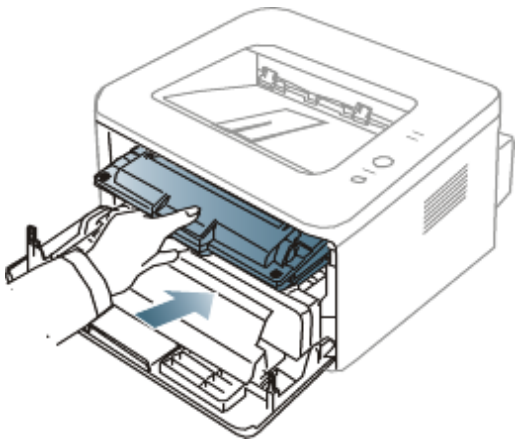

8. Close the front cover. Make sure that the cover is securely closed.

Specifications

This chapter guides you about this machine's specifications.

This chapter includes:

- [Hardware specifications](#)
- [Environmental specifications](#)
- [Electrical specifications](#)
- [Print media specifications](#)

 The specification values here are based on preliminary data. See www.dell.com or support.dell.com for current information.

Hardware specifications

Item		Description
Dimension	Height	197 mm (7.76 inches)
	Depth	389 mm (15.31 inches)
	Width	360 mm (14.17 inches)
Weight	Machine with consumables	<ul style="list-style-type: none">• Dell 1130: 7.25 Kg (15.98 lbs)• Dell 1130n: 7.30 Kg (16.09 lbs)
Package weight	Paper	1.23 Kg (2.70 lbs)
	Plastic	0.19 Kg (0.42 lbs)

Environmental specifications

Item		Description
Noise Level ^[a]	Ready mode	26 dB(A)
	Printing mode	<ul style="list-style-type: none">• Dell 1130: 49 dB(A)• Dell 1130n: 50 dB(A)
Temperature	Operation	10 to 32 °C (50 to 90 °F)
	Storage (unpacked)	0 to 40 °C (32 to 104 °F)
Humidity	Operation	20 to 80% RH
	Storage (unpacked)	10 to 80% RH

^[a] Sound Pressure Level, ISO 7779. Configuration tested: machine basic installation, A4 paper, simplex printing.

Electrical specifications

 Power requirements are based on the country/region where the device is sold. Do not convert operating voltages. Doing so might damage the device and void the product warranty.

Item		Description
Power rating ^[a]	110 volt models	AC 110 - 127 V
	220 volt models	AC 220 - 240 V
Power consumption	Average operating mode	Less than 360 W

Ready mode	<ul style="list-style-type: none"> • Dell 1130: Less than 45 W • Dell 1130n: Less than 60 W
Power save mode	<ul style="list-style-type: none"> • Dell 1130: Less than 4.5 W • Dell 1130n: Less than 6.5 W
Power off mode	Less than 0.8 W

[a] See the rating label on the machine for the correct voltage, frequency (hertz) and type of current for your machine.

Print media specifications

Type	Size	Dimensions	Print media weight ^[a] /Capacity ^[b]	
			Tray1	Manual tray
Plain paper	Letter	216 x 279 mm (8.50 x 11.00 inches)	60 to 120 g/m ² (16 to 32 lb bond) <ul style="list-style-type: none"> • 250 sheets of 80 g/m² (20 lb bond) 	60 to 220 g/m ² (16 to 43 lb bond) <ul style="list-style-type: none"> • 1 sheet stacking
	Legal	216 x 356 mm (8.50 x 14.00 inches)		
	US Folio	216 x 330 mm (8.50 x 13.00 inches)		
	A4	210 x 297 mm (8.27 x 11.69 inches)		
	Oficio	216 x 343 mm (8.50 x 13.50 inches)		
	JIS B5	182 x 257 mm (7.17 x 10.12 inches)	60 to 90 g/m ² (16 to 24 lb bond) <ul style="list-style-type: none"> • 150 sheets of 80 g/m² (20 lb bond) 	
	ISO B5	176 x 250 mm (6.93 x 9.84 inches)		
	Executive	184 x 267 mm (7.25 x 10.51 inches)		
	A5	148 x 210 mm (5.83 x 8.27 inches)		
	A6	105 x 148 mm (4.13 x 5.83 inches)		
Envelope	Envelope Monarch	98 x 191 mm (3.87 x 7.50 inches)	Not available in tray1.	75 to 90 g/m ² (20 to 24 lb bond) <ul style="list-style-type: none"> • 1 sheet stacking
	Envelope No. 10	105 x 241 mm (4.12 x 9.50 inches)		
	Envelope DL	110 x 220 mm (4.33 x 8.66 inches)		
	Envelope C5	162 x 229 mm (6.38 x 9.02 inches)		
	Envelope C6	114 x 162 mm		

		(4.49 x 6.38 inches)		
Thick paper	Refer to the Plain paper section	Refer to the Plain paper section	90 g/m ² (24 lb bond)	90 g/m ² (24 lb bond) • 1 sheet stacking
Thin paper	Refer to the Plain paper section	Refer to the Plain paper section	60 to 70 g/m ² (16 to 19 lb bond)	60 to 70 g/m ² (16 to 19 lb bond) • 1 sheet stacking
Transparency	Refer to the Plain paper section	Refer to the Plain paper section	Not available in tray1.	138 to 146 g/m ² (36.81 to 38.91 lb bond) • 1 sheet stacking
Labels [c]	Letter, Legal, US Folio, A4, JIS B5, ISO B5, Executive, A5, Statement	Refer to the Plain paper section	Not available in tray1.	120 to 150 g/m ² (32 to 40 lb bond) • 1 sheet stacking
Card stock	Letter, Legal, US Folio, A4, JIS B5, ISO B5, Executive, A5, Statement, PostCard 4x6	Refer to the Plain paper section	Not available in tray1.	105 to 163 g/m ² (28 to 43 lb bond) • 1 sheet stacking
Minimum size (custom)		76 x 127 mm (3.00 x 5.00 inches)	60 to 163 g/m ² (16 to 43 lb bond)	
Maximum size (custom)		216 x 356 mm (8.50 x 14.02 inches)		

[\[a\]](#) If media weight is over 120 g/m² (32 lb), load a paper into the tray one by one.

[\[b\]](#) Maximum capacity may differ depending on media weight, thickness and environmental conditions.

[\[c\]](#) Smoothness: 100 to 250 (sheffield).

Appendix

Dell technical support policy

Technician-assisted technical support requires the cooperation and participation of the customer in the troubleshooting process and provides for restoration of the Operating System, application software, and hardware drivers to the original default configuration as shipped from Dell, as well as the verification of appropriate functionality of the printer and all Dell-installed hardware. In addition to this technician assisted technical support, online technical support is available at Dell Support website at support.dell.com. Additional technical support options may be available for purchase.

Dell provides limited technical support for the printer and any Dell-installed software and peripherals. Support for third-party software and peripherals is provided by the original manufacturer, including those purchased and/or installed through Software & Peripherals (DellWare), ReadyWare, and Custom Factory Integration (CFI/DellPlus).

Contacting Dell

For customers in the United States, call 800-WWW-DELL (800-999-3355).

 If you do not have an active Internet connection, you can find contact information on your purchase invoice, packing slip, bill, or Dell product catalog.

Dell provides several online and telephone-based support and service options. Availability varies by country and product, and some services may not be available in your area. To contact Dell for sales, technical support, or customer service issues:

1. Visit support.dell.com, and verify your country or region in the Choose A Country/Region drop-down menu at the bottom of the page.
2. Click **Contact Us** on the left side of the page, and select the appropriate service or support link based on your need.

Warranty and return policy

Dell Inc. ("Dell") manufactures its hardware products from parts and components that are new or equivalent to new in accordance with industry-standard practices. For information about the Dell warranty for your printer, refer to the **Product Information Guide**.

Glossary



The following glossary helps you get familiar with the product by understanding the terminologies commonly used with printing as well as mentioned in this user's guide.

802.11

802.11 is a set of standards for wireless local area network (WLAN) communication, developed by the IEEE LAN/MAN Standards Committee (IEEE 802).

802.11b/g

802.11b/g can share same hardware and use the 2.4 GHz band. 802.11b supports bandwidth up to 11 Mbps; 802.11g up to 54 Mbps. 802.11b/g devices may occasionally suffer interference from microwave ovens, cordless telephones, and Bluetooth devices.

Access point

Access Point or Wireless Access Point (AP or WAP) is a device that connects wireless communication devices together on wireless local area networks (WLAN), and acts as a central transmitter and receiver of WLAN radio signals.

ADF

An Automatic Document Feeder (ADF) is a mechanism that will automatically feed an original sheet of paper so that the machine can scan some amount of the paper at once.

AppleTalk

AppleTalk is a proprietary suite of protocols developed by Apple, Inc for computer networking. It was included in the original Macintosh (1984) and is now deprecated by Apple in favor of TCP/IP networking.

BIT Depth

A computer graphics term describing the number of bits used to represent the color of a single pixel in a bitmapped image. Higher color depth gives a broader range of distinct colors. As the number of bits increases, the number of possible colors becomes impractically large for a color map. 1-bit color is commonly called as monochrome or black and white.

BMP

A bitmapped graphics format used internally by the Microsoft Windows graphics subsystem (GDI), and used commonly as a simple graphics file format on that platform.

BOOTP

Bootstrap Protocol. A network protocol used by a network client to obtain its IP address automatically. This is usually done in the bootstrap process of computers or operating systems running on them. The BOOTP servers assign the IP address from a pool of addresses to each client. BOOTP enables 'diskless workstation' computers to obtain an IP address prior to loading any advanced operating system.

CCD

Charge Coupled Device (CCD) is a hardware which enables the scan job. CCD Locking mechanism is also used to hold the CCD module to prevent any damage when you move the machine.

Collation

Collation is a process of printing a multiple-copy job in sets. When collation is selected, the device prints an entire set before printing additional copies.

Control Panel

A control panel is a flat, typically vertical, area where control or monitoring instruments are displayed. They are typically found in front of the machine.

Coverage

It is the printing term used for a toner usage measurement on printing. For example, 5% coverage means that an A4 sided paper has about 5% image or text on it. So, if the paper or original has complicated images or lots of text on it, the coverage will be higher and at the same time, a toner usage will be as much as the coverage.

CSV

Comma Separated Values (CSV). A type of file format, CSV is used to exchange data between disparate applications. The file format, as it is used in Microsoft Excel, has become a pseudo standard throughout the industry, even among non-Microsoft platforms.

DADF

A Duplex Automatic Document Feeder (DADF) is a mechanism that will automatically feed and flip over an original sheet of paper so that the machine can scan on both sides of the paper.

Default

The value or setting that is in effect when taking a printer out of its box state, reset, or initialized.

DHCP

A Dynamic Host Configuration Protocol (DHCP) is a client-server networking protocol. A DHCP server provides configuration parameters specific to the DHCP client host requesting, generally, information required by the client host to participate on an IP network. DHCP also provides a mechanism for allocation of IP addresses to client hosts.

DIMM

Dual Inline Memory Module (DIMM), a small circuit board that holds memory. DIMM stores all the data within the machine like printing data, received fax data.

DNS

The Domain Name Server (DNS) is a system that stores information associated with domain names in a distributed database on networks, such as the Internet.

Dot Matrix Printer

A dot matrix printer refers to a type of computer printer with a print head that runs back and forth on the page and prints by impact, striking an ink-soaked cloth ribbon against the paper, much like a typewriter.

DPI

Dots Per Inch (DPI) is a measurement of resolution that is used for scanning and printing. Generally, higher DPI results in a higher resolution, more visible detail in the image, and a larger file size.

DRPD

Distinctive Ring Pattern Detection. Distinctive Ring is a telephone company service which enables a user to use a single telephone line to answer several different telephone numbers.

Duplex

A mechanism that will automatically flip over a sheet of paper so that the machine can print (or scan) on both sides of the paper. A printer equipped with a Duplex can print double-sided of paper.

Duty Cycle

Duty cycle is the page quantity which does not affect printer performance for a month. Generally the printer has the lifespan limitation such as pages per year. The lifespan means the average capacity of print-outs, usually within the

warranty period. For example, if the duty cycle is 48,000 pages per month assuming 20 working days, a printer limits 2,400 pages a day.

ECM

Error Correction Mode (ECM) is an optional transmission mode built into Class 1 fax machines or fax modems. It automatically detects and corrects errors in the fax transmission process that are sometimes caused by telephone line noise.

Emulation

Emulation is a technique of one machine obtaining the same results as another.

An emulator duplicates the functions of one system with a different system, so that the second system behaves like the first system. Emulation focuses on exact reproduction of external behavior, which is in contrast to simulation, which concerns an abstract model of the system being simulated, often considering its internal state.

Ethernet

Ethernet is a frame-based computer networking technology for local area networks (LANs). It defines wiring and signaling for the physical layer, and frame formats and protocols for the media access control (MAC)/data link layer of the OSI model. Ethernet is mostly standardized as IEEE 802.3. It has become the most widespread LAN technology in use during the 1990s to the present.

EtherTalk

A suite of protocols developed by Apple Computer for computer networking. It was included in the original Macintosh (1984) and is now deprecated by Apple in favor of TCP/IP networking.

FDI

Foreign Device Interface (FDI) is a card installed inside the machine to allow a third party device such as a coin operated device or a card reader. Those devices allow the pay-for-print service on your machine.

FTP

A File Transfer Protocol (FTP) is a commonly used protocol for exchanging files over any network that supports the TCP/IP protocol (such as the Internet or an intranet).

Fuser Unit

The part of a laser printer that melts the toner onto the print media. It consists of a hot roller and a back-up roller. After toner is transferred onto the paper, the fuser unit applies heat and pressure to ensure that the toner stays on the paper permanently, which is why paper is warm when it comes out of a laser printer.

Gateway

A connection between computer networks, or between a computer network and a telephone line. It is very popular, as it is a computer or a network that allows access to another computer or network.

Grayscale

A shades of gray that represent light and dark portions of an image when color images are converted to grayscale; colors are represented by various shades of gray.

Halftone

An image type that simulates grayscale by varying the number of dots. Highly colored areas consist of a large number of dots, while lighter areas consist of a smaller number of dots.

HDD

Hard Disk Drive (HDD), commonly referred to as a hard drive or hard disk, is a non-volatile storage device which stores digitally-encoded data on rapidly rotating platters with magnetic surfaces.

IEEE

The Institute of Electrical and Electronics Engineers (IEEE) is an international non-profit, professional organization for the advancement of technology related to electricity.

IEEE 1284

The 1284 parallel port standard was developed by the Institute of Electrical and Electronics Engineers (IEEE). The term "1284-B" refers to a specific connector type on the end of the parallel cable that attaches to the peripheral (for example, a printer).

Intranet

A private network that uses Internet Protocols, network connectivity, and possibly the public telecommunication system to securely share part of an organization's information or operations with its employees. Sometimes the term refers only to the most visible service, the internal website.

IP address

An Internet Protocol (IP) address is a unique number that devices use in order to identify and communicate with each other on a network utilizing the Internet Protocol standard.

IPM

The Images Per Minute (IPM) is a way of measuring the speed of a printer. An IPM rate indicates the number of single-sided sheets a printer can complete within one minute.

IPP

The Internet Printing Protocol (IPP) defines a standard protocol for printing as well as managing print jobs, media size, resolution, and so forth. IPP can be used locally or over the Internet to hundreds of printers, and also supports access control, authentication, and encryption, making it a much more capable and secure printing solution than older ones.

IPX/SPX

IPX/SPX stands for Internet Packet Exchange/Sequenced Packet Exchange. It is a networking protocol used by the Novell NetWare operating systems. IPX and SPX both provide connection services similar to TCP/IP, with the IPX protocol having similarities to IP, and SPX having similarities to TCP. IPX/SPX was primarily designed for local area networks (LANs), and is a very efficient protocol for this purpose (typically its performance exceeds that of TCP/IP on a LAN).

ISO

The International Organization for Standardization (ISO) is an international standard-setting body composed of representatives from national standards bodies. It produces world-wide industrial and commercial standards.

ITU-T

The International Telecommunication Union is an international organization established to standardize and regulate international radio and telecommunications. Its main tasks include standardization, allocation of the radio spectrum, and organizing interconnection arrangements between different countries to allow international phone calls. A -T out of ITU-T indicates telecommunication.

ITU-T No. 1 chart

Standardized test chart published by ITU-T for document facsimile transmissions.

JBIG

Joint Bi-level Image Experts Group (JBIG) is an image compression standard with no loss of accuracy or quality, which was designed for compression of binary images, particularly for faxes, but can also be used on other images.

JPEG

Joint Photographic Experts Group (JPEG) is a most commonly used standard method of lossy compression for

photographic images. It is the format used for storing and transmitting photographs on the World Wide Web.

LDAP

The Lightweight Directory Access Protocol (LDAP) is a networking protocol for querying and modifying directory services running over TCP/IP.

LED

A Light-Emitting Diode (LED) is a semiconductor device that indicates the status of a machine.

MAC address

Media Access Control (MAC) address is a unique identifier associated with a network adapter. MAC address is a unique 48-bit identifier usually written as 12 hexadecimal characters grouped in pairs (e. g., 00-00-0c-34-11-4e). This address is usually hard-coded into a Network Interface Card (NIC) by its manufacturer, and used as an aid for routers trying to locate machines on large networks.

MFP

Multi Function Peripheral (MFP) is an office machine that includes the following functionality in one physical body, so as to have a printer, a copier, a fax, a scanner and etc.

MH

Modified Huffman (MH) is a compression method for decreasing the amount of data that needs to be transmitted between the fax machines to transfer the image recommended by ITU-T T.4. MH is a codebook-based run-length encoding scheme optimized to efficiently compress white space. As most faxes consist mostly of white space, this minimizes the transmission time of most faxes.

MMR

Modified Modified READ (MMR) is a compression method recommended by ITU-T T.6.

Modem

A device that modulates a carrier signal to encode digital information, and also demodulates such a carrier signal to decode transmitted information.

MR

Modified Read (MR) is a compression method recommended by ITU-T T.4. MR encodes the first scanned line using MH. The next line is compared to the first, the differences determined, and then the differences are encoded and transmitted.

NetWare

A network operating system developed by Novell, Inc. It initially used cooperative multitasking to run various services on a PC, and the network protocols were based on the archetypal Xerox XNS stack. Today NetWare supports TCP/IP as well as IPX/SPX.

OPC

Organic Photo Conductor (OPC) is a mechanism that makes a virtual image for print using a laser beam emitted from a laser printer, and it is usually green or gray colored and a cylinder shaped.

An exposing unit of a drum is slowly worn away by its usage of the printer, and it should be replaced appropriately since it gets scratches from grits of a paper.

Originals

The first example of something, such as a document, photograph or text, etc, which is copied, reproduced or translated to produce others, but which is not itself copied or derived from something else.

OSI

Open Systems Interconnection (OSI) is a model developed by the International Organization for Standardization (ISO) for communications. OSI offers a standard, modular approach to network design that divides the required set of complex functions into manageable, self-contained, functional layers. The layers are, from top to bottom, Application, Presentation, Session, Transport, Network, Data Link and Physical.

PABX

A private automatic branch exchange (PABX) is an automatic telephone switching system within a private enterprise.

PCL

Printer Command Language (PCL) is a Page Description Language (PDL) developed by HP as a printer protocol and has become an industry standard. Originally developed for early inkjet printers, PCL has been released in varying levels for thermal, matrix printer, and page printers.

PDF

Portable Document Format (PDF) is a proprietary file format developed by Adobe Systems for representing two dimensional documents in a device independent and resolution independent format.

PostScript

PostScript (PS) is a page description language and programming language used primarily in the electronic and desktop publishing areas. - that is run in an interpreter to generate an image.

Printer Driver

A program used to send commands and transfer data from the computer to the printer.

Print Media

The media like paper, envelopes, labels, and transparencies which can be used on a printer, a scanner, a fax or, a copier.

PPM

Pages Per Minute (PPM) is a method of measurement for determining how fast a printer works, meaning the number of pages a printer can produce in one minute.

PRN file

An interface for a device driver, this allows software to interact with the device driver using standard input/output system calls, which simplifies many tasks.

Protocol

A convention or standard that controls or enables the connection, communication, and data transfer between two computing endpoints.

PS

See PostScript.

PSTN

The Public-Switched Telephone Network (PSTN) is the network of the world's public circuit-switched telephone networks which, on industrial premises, is usually routed through the switchboard.

RADIUS

Remote Authentication Dial In User Service (RADIUS) is a protocol for remote user authentication and accounting. RADIUS enables centralized management of authentication data such as usernames and passwords using an AAA (authentication, authorization, and accounting) concept to manage network access.

Resolution

The sharpness of an image, measured in Dots Per Inch (DPI). The higher the dpi, the greater the resolution.

SMB

Server Message Block (SMB) is a network protocol mainly applied to share files, printers, serial ports, and miscellaneous communications between nodes on a network. It also provides an authenticated Inter-process communication mechanism.

SMTP

Simple Mail Transfer Protocol (SMTP) is the standard for e-mail transmissions across the Internet. SMTP is a relatively simple, text-based protocol, where one or more recipients of a message are specified, and then the message text is transferred. It is a client-server protocol, where the client transmits an email message to the server.

SSID

Service Set Identifier (SSID) is a name of a wireless local area network (WLAN). All wireless devices in a WLAN use the same SSID in order to communicate with each other. The SSIDs are case-sensitive and have a maximum length of 32 characters.

Subnet Mask

The subnet mask is used in conjunction with the network address to determine which part of the address is the network address and which part is the host address.

TCP/IP

The Transmission Control Protocol (TCP) and the Internet Protocol (IP); the set of communications protocols that implement the protocol stack on which the Internet and most commercial networks run.

TCR

Transmission Confirmation Report (TCR) provides details of each transmission such as job status, transmission result and number of pages sent. This report can be set to print after each job or only after failed transmissions.

TIFF

Tagged Image File Format (TIFF) is a variable-resolution bitmapped image format. TIFF describes image data that typically come from scanners. TIFF images make use of tags, keywords defining the characteristics of the image that is included in the file. This flexible and platform-independent format can be used for pictures that have been made by various image processing applications.

Toner Cartridge

A kind of bottle within a machine like printer which contains toner. Toner is a powder used in laser printers and photocopiers, which forms the text and images on the printed paper. Toner can be melted by the heat of the fuser, causing it to bind to the fibers in the paper.

TWAIN

An industry standard for scanners and software. By using a TWAIN-compliant scanner with a TWAIN-compliant program, a scan can be initiated from within the program.; an image capture API for Microsoft Windows and Apple Macintosh operating systems.

UNC Path

Uniform Naming Convention (UNC) is a standard way to access network shares in Window NT and other Microsoft products. The format of a UNC path is: \\<servername>\<sharename>\<Additional directory>

URL

Uniform Resource Locator (URL) is the global address of documents and resources on the Internet. The first part of the address indicates what protocol to use, the second part specifies the IP address or the domain name where the resource is located.

USB

Universal Serial Bus (USB) is a standard that was developed by the USB Implementers Forum, Inc., to connect computers and peripherals. Unlike the parallel port, USB is designed to concurrently connect a single computer USB port to multiple peripherals.

Watermark

A watermark is a recognizable image or pattern in paper that appears lighter when viewed by transmitted light. Watermarks were first introduced in Bologna, Italy in 1282; they have been used by papermakers to identify their product, and also on postage stamps, currency, and other government documents to discourage counterfeiting.

WEP

Wired Equivalent Privacy (WEP) is a security protocol specified in IEEE 802.11 to provide the same level of security as that of a wired LAN. WEP provides security by encrypting data over radio so that it is protected as it is transmitted from one end point to another.

WIA

Windows Imaging Architecture (WIA) is an imaging architecture that is originally introduced in Windows Me and Windows XP. A scan can be initiated from within these operating systems by using a WIA-compliant scanner.

WPA

Wi-Fi Protected Access (WPA) is a class of systems to secure wireless (Wi-Fi) computer networks, which was created to improve upon the security features of WEP.

WPA-PSK

WPA-PSK (WPA Pre-Shared Key) is special mode of WPA for small business or home users. A shared key, or password, is configured in the wireless access point (WAP) and any wireless laptop or desktop devices. WPA-PSK generates a unique key for each session between a wireless client and the associated WAP for more advanced security.

Free Manuals Download Website

<http://myh66.com>

<http://usermanuals.us>

<http://www.somanuals.com>

<http://www.4manuals.cc>

<http://www.manual-lib.com>

<http://www.404manual.com>

<http://www.luxmanual.com>

<http://aubethermostatmanual.com>

Golf course search by state

<http://golfingnear.com>

Email search by domain

<http://emailbydomain.com>

Auto manuals search

<http://auto.somanuals.com>

TV manuals search

<http://tv.somanuals.com>