



# Dell Networking C1048P Installation Guide

Regulatory Model: C1048P



# Notes, Cautions, and Warnings

-  **NOTE:** A NOTE indicates important information that helps you make better use of your computer.
-  **CAUTION:** A CAUTION indicates either potential damage to hardware or loss of data and tells you how to avoid the problem.
-  **WARNING:** A WARNING indicates a potential for property damage, personal injury, or death.

**Copyright © 2015 Dell Inc. All rights reserved.** This product is protected by U.S. and international copyright and intellectual property laws. Dell™ and the Dell logo are trademarks of Dell Inc. in the United States and/or other jurisdictions. All other marks and names mentioned herein may be trademarks of their respective companies.

2015 - 10

Rev. A00

# About This Guide

This document provides information about how to install a C1048P port extender in a rack. For complete information about C1048P installation and configuration, refer to these documents:

**Table 1. C1048P Documentation**

<b>Information</b>	<b>Documentation</b>
Hardware installation, power-up, and initial software configuration instructions	<i>Dell Networking C1048P Getting Started Guide</i>
Software configuration	<i>Dell Networking Configuration Guide for the C9000 Series</i>
Command-line interface	<i>Dell Networking Command-Line Reference Guide for the C9000 Series</i>
Latest updates	<i>Dell Networking C9010 and C1048P Release Notes</i>

## C1048P Hardware Description

The Dell Networking C1048P is a stackable Gigabit Ethernet port extender (PE) for campus access deployments. The C1048P is used as a 1 rack unit (RU) port extender for the C9010 modular chassis and requires a C9010 switch to operate. The C1048P functions as a remote line card that is physically connected to, and provisioned by, a C9010 over 10GbE uplinks. You can connect up to 40 C1048P PEs (standalone and stacked) to a C9010 switch.

Deployed as a port extender, the C1048P extends the switching capability of the C9010. The C1048P uses a standards-based tagging mechanism coupled with virtual port technology to multiplex and demultiplex data-plane traffic to and from the C9010, which functions as a central point of control.

Although the C1048P PE does not switch traffic, it provides switch services in the same way as a chassis line card, including ACLs for quality of service (QoS) and security, statistics gathering, multicast delivery, LACP link aggregation, and device discovery through LLDP. The C1048P provides 1GbE Power over Ethernet plus (PoE+) connectivity, 10GbE uplink capability, and supports PE stacking.

The C1048P PE has the following physical dimensions:

- 440.0 x 257.0 x 43.5 mm (W x D x H)
- 17.3 x 15.2 x 1.7 inches (W x D x H)

## Unpacking the Switch

The C1048P PE and its accessories ship in a single box. Before unpacking the switch, inspect the container and immediately report any evidence of damage. Verify that you have received your ordered items. If any item is missing or damaged, contact your Dell Networking representative or reseller for assistance.

 **CAUTION: Always wear an electrostatic discharge (ESD)-preventive wrist or heel ground strap when handling the PE and its components. Ground yourself by using an antistatic wrist strap or other device and connect it to the ESD grounding jack on the chassis. As with all electrical devices of this type, take the necessary safety precautions to prevent injury when installing this system.**

Unpack the C1048P by carefully removing the device from the container and place it on a secure and clean surface.

The base C1048P package ships with:

- One C1048P chassis
- One rack-mount kit for rack installation, including two mounting brackets, bolts, and cage nuts
- One set of self-adhesive rubber pads for a free-standing PE (four pads are included)
- *C1048P Getting Started Guide*
- *Safety and Regulatory Information*

- *Warranty and Support Information*
- *Software License Agreement*

You can order additional items, such as optics, cables, and external power supplies.

## C1048P Front Panel

The ports on the front panel of the C1048P PE are shown in the following illustration and described below.

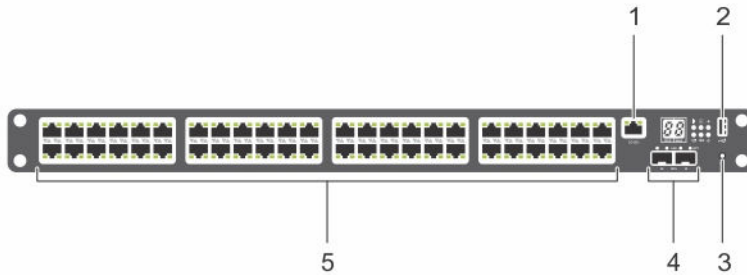

**Figure 1. C1048P Front Panel: Ports and Reset Button**

1. Console port

The console port provides serial communication using the RS-232 protocol to connect a console terminal and access the C1048P command-line interface (CLI). To set up a console connection, use the serial cable (RJ-45 to DB-9 female connectors) shipped with the C9010. The console port operates as an asynchronous link from 1200 to 115,200 baud. The default settings are 9600 baud rate, 8 data bits, No Parity, 1 Stop Bit, and No Flow Control.

2. USB port

The Type-A, female USB port supports a USB 2.0-compliant flash memory drive. The C1048P can read or write to a flash drive formatted as FAT-32. Use a USB flash drive to copy files and images to the C1048P.

3. Reset button

Access the reset button through a pinhole. To perform a hard reset of the C1048P, insert the tip of a paper clip or similar tool into the pinhole. When the PE reboots, it re-establishes communication with an attached C9010, which downloads the latest SW configuration settings.

4. Two 10GbE SFP+ ports

Two SFP+ ports provide 10GbE uplinks to communicate with a C9010. To connect to a C9010 switch, at least one C1048P 10GbE SFP+ port is required. On the C1048P, 10GbE SFP+ ports are numbered 1 and 2, and only support uplinks to a parent C9010; they cannot be used as data ports.

5. Forty-eight Gigabit Ethernet ports

The 48 Gigabit Ethernet (10BASE-T, 100BASE-TX, 1000BASE-T) RJ-45 ports connect to downstream servers and edge devices. These ports support auto-negotiation for speed and duplex transmission. C1048P Gigabit Ethernet ports are numbered 1 to 48.

**NOTE:** Dell Networking does not recommend that you connect a Gigabit Ethernet port to another switch or bridge. A loop in the topology may result.

The C1048P automatically detects the difference between crossed and straight-through cables on RJ-45 ports and automatically chooses the MDI or MDIX configuration to match the other end. The RJ-45 ports support full-duplex mode 10/100/1000 Mbps speeds on standard Category 5 UTP cable and Power over Ethernet — PoE (15.4W) and PoE+ (30W).

You can configure up to eight C1048P Gigabit Ethernet interfaces in a port channel that connects to a downstream edge device.

## LED Descriptions: Front Panel

The light emitting diode (LED) displays for PE ID and stack number, temperature, power, system, stack master, power, fan, and SFP+ link status are on the right side of the C1048P front panel. 10/100/1000BASE-T port LEDs are located above each port.

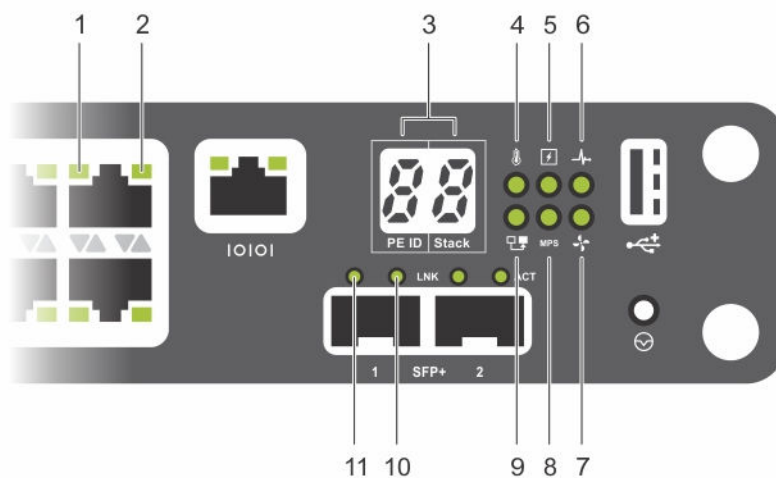

**Figure 2. C1048P Front Panel: LEDs**

- |     |                                    |     |  |
|-----|------------------------------------|-----|--|
| 1.  | 10/100/1000BASE-T port LED: Link   | 2.  | 10/100/1000BASE-T port LED: Activity   |
| 3.  | PE ID and Stack ID numbers         | 4.  | Temperature LED                        |
| 5.  | Power/Locator LED                  | 6.  | Status LED                             |
| 7.  | Fan LED                            | 8.  | External power supply: Status LED      |
| 9.  | Stack Master/Member LED            | 10. | 10GbE SFP+ uplink port 1: Activity LED |
| 11. | 10GbE SFP+ uplink port 1: Link LED |     |  |

## 10/100/1000BASE-T Port LEDs

The following table describes 10/100/1000BASE-T port LEDs (items 1 and 2 in Figure 2).



### C1048P 10/100/1000BASE-T Port LEDs





LED	Description
Link	Link speed on port <ul style="list-style-type: none"><li>• Off: No link is up.</li><li>• Solid green: The port is operating at 1000 Mbps.</li><li>• Solid yellow: The port is operating at 10/100 Mbps.</li></ul>
Activity	Data transmission on port <ul style="list-style-type: none"><li>• Off: No transmit/receive activity and PoE power is off.</li><li>• Flashing green: The port is actively transmitting/receiving and PoE power is off.</li><li>• Flashing yellow: The port is actively transmitting/receiving and PoE power is on.</li><li>• Solid yellow: No transmit/receive activity and PoE power is on.</li></ul>

## System LEDs

The following table describes the system LEDs on the C1048P front panel (items 3 to 11 in Figure 2).

### C1048P System LEDs

LED	Description
PE ID   Stack	When the C1048P is online and connected to a C9010, a scrolling port-extender ID (PE ID) from 0 to 255 displays in the left, seven-segment LED. A fixed stack-unit ID number from 0 to 7 displays in the right LED. If the C1048P is not connected to a C9010, the PE ID LED is blank.   <b>NOTE:</b> The PE ID number displays as a scrolling three-digit number. Each digit displays briefly followed by a dash ( - ) before the next digit displays. A blank displays before the three-digit number repeats in the display. For example, the PE ID 175 displays 1, -, 7, -, 5, followed by a blank before the PE ID number repeats. Similarly, the PE ID 7 displays as 007: 0, -, 0, -, 7, followed by a blank.
 Temperature	Temperature status <ul style="list-style-type: none"><li>• Solid green: Normal operation; the temperature is below the minor threshold of 140°F (60°C).</li><li>• Solid red: Warning condition; the temperature exceeds the major threshold of 167°F (75°C).</li></ul>
 Power/Locator	Internal power status <ul style="list-style-type: none"><li>• Solid green: Normal operation</li><li>• Blinking green: The PE locator is enabled.</li><li>• Off: Error condition — There is no power reaching the PE or the PE has a power failure.</li></ul>

LED	Description
 Status	<p>System operational status</p> <ul style="list-style-type: none"> <li>• Solid green: Normal operation</li> <li>• Blinking green: The PE is booting.</li> <li>• Solid red: Critical system error</li> <li>• Blinking red: Non-critical system error, such as a fan failure</li> </ul>
 Fan	<p>Fan status</p> <ul style="list-style-type: none"> <li>• Solid green: The fan is powered on and is operating at normal RPM speed.</li> <li>• Solid red: Fan failure</li> </ul>
 MPS	<p>Modular power supply (MPS) status (redundant external power supply)</p> <ul style="list-style-type: none"> <li>• Off: No external (modular) power supply is used.</li> <li>• Solid green: The PE is receiving power.</li> <li>• Solid red: An external power supply is detected, but is not receiving power.</li> </ul>
 Stack Master/ Member	<p>Stack master status</p> <ul style="list-style-type: none"> <li>• Off: The PE is operating as the standby unit or a stack member.</li> <li>• Solid green: The PE is operating as a stack master or in standalone mode.</li> </ul> <p> <b>NOTE:</b> While the C1048P is booting up in standalone or stacking mode, the Stack Master LED is solid green.</p>
SFP+ LNK (left LED above port)	<p>SFP+ link status</p> <ul style="list-style-type: none"> <li>• Off: No data link</li> <li>• Solid green: Link is up and operating at maximum 10G port speed.</li> </ul>
SFP+ ACT (right LED above port)	<p>SFP+ activity status</p> <ul style="list-style-type: none"> <li>• Off: No data link activity</li> <li>• Flashing green: Link is up and transmitting/receiving data.</li> </ul>



# C1048P Back Panel

The back panel of the C1048P PE is shown in the following illustration and described below.

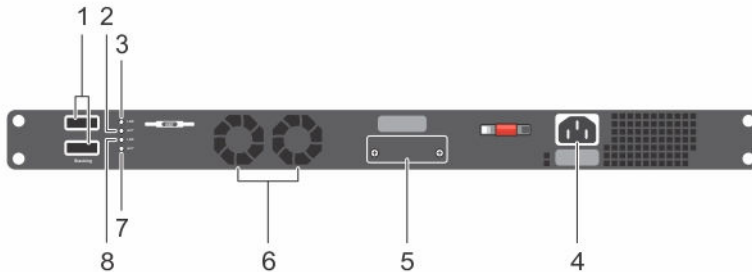

**Figure 3. C1048P Back Panel**

1. Stack ports: Each C1048P has two fixed mini-SAS (STD) stacking connectors on its back panel. Stack port 1 is on top; stack port 2 is on the bottom.

You can stack up to eight C1048P PEs using the mini-SAS ports on the back panel. A C1048P PE supports stacking only with other C1048P PEs. When you connect multiple C1048P PEs using the stack ports, the PEs operate as a single unit with up to 384 front panel ports. The stack operates and is managed from a C9010 switch as a single entity.

In a C1048P stack, the Stack Master/Member LED on the front panel indicates operational status (standalone, stack master, or member unit). For more information about C1048P LED behavior, see [System LEDs](#).

2. Stack port 1: Activity LED
3. Stack port 1: Link LED
4. Main AC power supply connector: The C1048P PE has an internal 1000-watt power supply that feeds up to 24 PoE devices at full PoE+ power (850W). PoE power is dynamically allocated.

**NOTE:** The AC power connector on a C1048P requires an IEC-320-C15 power cable, which is different than the C13 power cable used on most lower wattage switches.

5. External DC power supply connector: You can connect an additional external power supply (MPS1000) to provide 1000 watts and full power coverage for all 48 PoE devices (1800W).
6. Fan vents: Two fans are used to cool the C1048P PE.
7. Stack port 2: Activity LED
8. Stack port 2: Link LED

## Stack Port LEDs

The stack port LEDs are located to the right of each stack port. The Link LED is above the Activity LED.

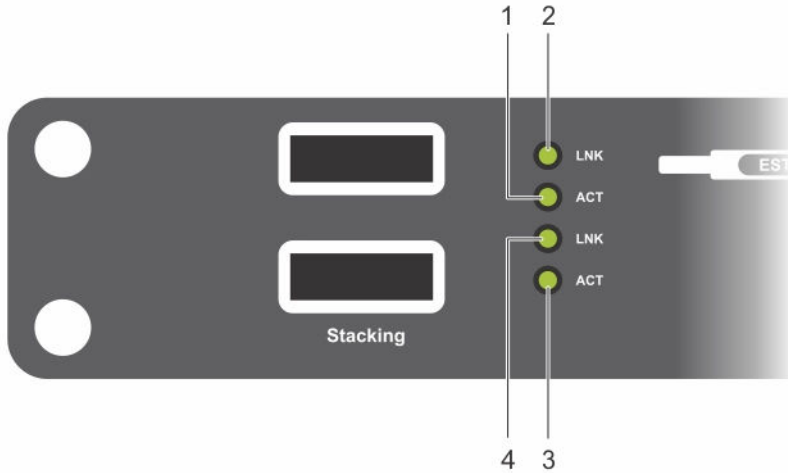

**Figure 4. C1048P Back Panel: Stack Port LEDs**

- |                               |                           |
|-------------------------------|---------------------------|
| 1. Stack port 1: Activity LED | 2. Stack port 1: Link LED |
| 3. Stack port 2: Activity LED | 4. Stack port 2: Link LED |

**Table 2. C1048P Stack Port LEDs**

Stack Port LED	Description
LNK	Stack port link <ul style="list-style-type: none"><li>Off: No link is up.</li><li>Solid green: Stack link is up.</li></ul>
ACT	Stack port activity <ul style="list-style-type: none"><li>Off: No data link activity.</li><li>Flashing green: Stack link is up and transmitting/receiving data.</li></ul>

## Before You Start: Site Preparation

Before installing the C1048P port extender, make sure that your installation site meets these requirements:

- **Clearance:** There is adequate space in front of the PE so you can read the LEDs, and adequate space around and behind the switch for cabling, power connections, and ventilation. The AC power cord can reach from the power outlet to the utility-panel connector. Airflow around the PE and through the rear vents is unobstructed.
- **Cabling:** Route the cabling to avoid sources of electrical noise, such as radio transmitters, broadcast amplifiers, power lines, and fluorescent lighting fixtures. Make sure that the cabling is safely away from

other devices that might damage the cables. If necessary, allow one RU space between devices to provide room for cabling.

- **Temperature:** The ambient temperature around the operating PE is from 0 to 45°C (32 to 113°F).
- **Altitude:** Altitude at the installation site is below 10,000 feet (3048 m).
- **Humidity:** The relative humidity around the operating PE is 8% to 85% (non-condensing) with a maximum humidity gradation of 10% per hour.
- **Dust:** Install the PE in an environment as free as possible from dust and foreign conductive material (such as metal flakes from construction activities). Cooling mechanisms, such as fans and blowers in the switch, can draw dust and other particles causing contaminant buildup inside the chassis, which can result in system malfunction.

## Installing the Hardware

To install the C1048P PE, mount it into a 19" wide, EIA-310-E compliant rack. You can install the C1048P in a 1U 4-post front-rack or 1U 2-post (flush and center) rack configuration. Using a rack mount tray is optional.

To install the C1048P PE in a rack:

1. (Optional) Install a rack mount tray in a 2- or 4-post rack.
2. Install the C1048P chassis in the rack using mounting brackets.
3. Connect the C1048P to a C9010 switch.
4. (Optional) Set up a C1048P stack by connecting to other C1048Ps.
5. Power up the system.

 **NOTE:** Although Dell Networking strongly recommends that you install the C1048P in a rack, you may install it on a flat surface as a free-standing device. The surface must be able to support the weight of the C1048P and the PE cables. The C1048P ships with four self-adhesive rubber pads.

1. When installing the C1048P on a flat surface, attach the self-adhesive rubber pads on each location marked on the bottom of the switch (unless you are using a rack).
2. Set the C1048P on a flat surface. Make sure that it has proper ventilation by leaving 5 cm (2 inches) on each side and 13 cm (5 inches) at the back.

## Before You Start: Rack Safety Considerations

Before installing the C1048P in a rack, review the following rack mounting safety considerations.

 **WARNING:** For complete safety information, read the safety instructions in your *Safety, Environmental, and Regulatory Information* booklet before you begin. This document contains a condensed summary.

- Rack loading — Overloading or uneven loading of racks may result in shelf or rack failure, causing damage to the equipment and possible personal injury. Stabilize racks in a permanent location before loading begins. Mount components beginning at the bottom of the rack, then work to the top. Do not exceed your rack load rating.
- Power considerations — Connect only to the power source specified on the unit. When you install multiple electrical components in a rack, ensure that the total component power ratings do not exceed circuit capabilities. Overloaded power sources and extension cords present fire and shock hazards.
- Elevated ambient temperature — If you install the system in a closed rack assembly, the operating temperature of the rack environment may be greater than room ambient. Use care not to exceed the 50 degrees C maximum ambient temperature of the switch.
- Reduced air flow — Install the port extender in the rack so that the front-to-back airflow (I/O ports to PSU) is not obstructed.

- Reliable earthing — Maintain reliable earthing of rack-mounted equipment. Pay particular attention to supply connections other than direct connections to the branch circuit; for example, use of power strips.
- Rack mounting — Do not mount the port extender with the rear panel facing in the downward position.

## Installing a Rack Mount Tray (Optional)

You can use a rack mount tray to support the weight of the C1048P in a 4-post rack. You must order the tray separately.

To install a rack mount tray in a 4-post rack, follow the instructions provided with the tray kit. Decide on the desired height to mount the switch in the rack. Position the tray at that height and tighten it to the rack posts using the screws shipped with the tray (items 1 to 4 in Figure 5).

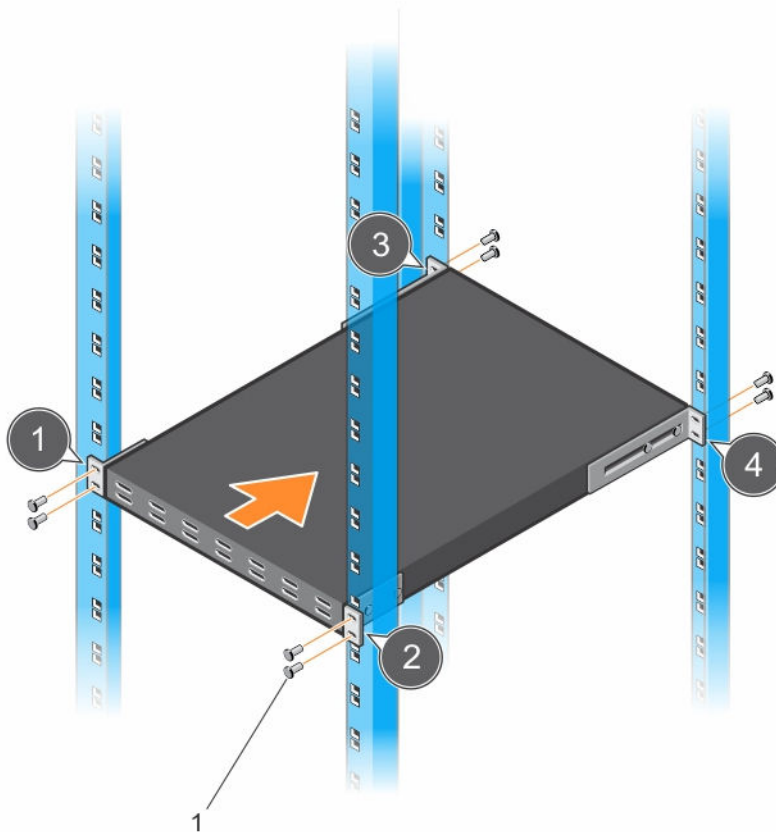

Figure 5. Example of a Mount Rack Tray

## Installing the C1048P in a Rack

You can install the C1048P in a 1 RU 4-post front-rack or 1 RU 2-post (flush and center) rack configuration. Although the procedure in this section describes C1048P installation in a 1 RU 2-post front-rack configuration, follow the same steps to install a C1048P in a 1 RU 4-post rack.

**⚠ WARNING: Never mount the C1048P in a rack that is suspended under a table or desk, or attached to a wall.**

**△ CAUTION:** Before installing the C1048P in a rack, disconnect all cables (if attached) and remove all self-adhesive pads (if attached) from the underside of the C1048P.

**△ CAUTION:** If you plan to install multiple C1048P PEs in a rack, mount the C1048s from the bottom up. Make sure that the air flow through the ventilation holes on each C1048P is not obstructed.

To install the C1048P in a rack:

1. Align the holes on the right rack-mount bracket with the holes on the right side (facing you) of the C1048P.
2. Secure the bracket (item 3 in Figure 6) to the chassis by tightening the screws (item 2 in Figure 6) provided with the mount bracket.

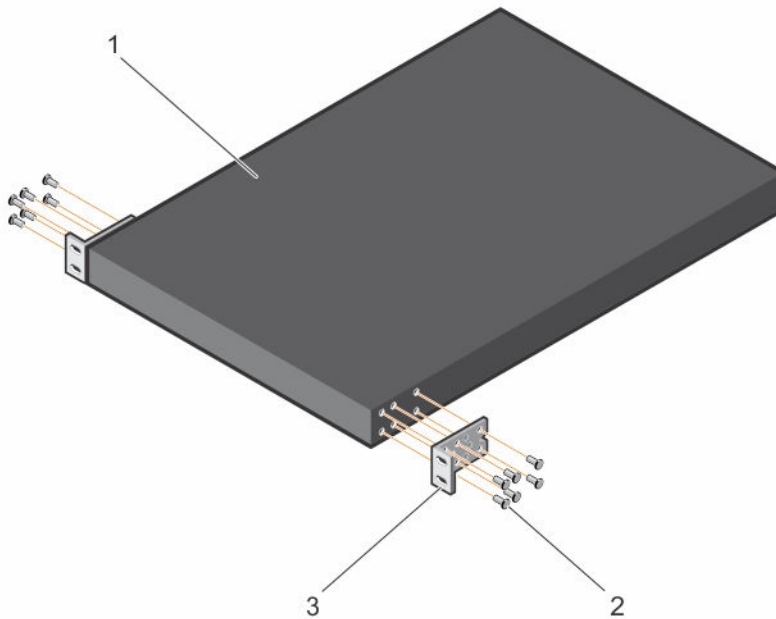

**Figure 6. Attaching Mount Brackets to the C1048P**

3. Repeat Steps 1 and 2 to attach the left rack-mount bracket on the C1048P.
4. Mount the C1048P into a 48.26 cm (19 inch) rack. Align the holes on each bracket flange with the holes on a rack post.
5. Secure the C1048P to the rack using the rack bolts (provided with the mount brackets) or cage nuts and cage-nut bolts with washers (provided with the rack). Tighten the bolts on the bottom of each bracket flange first; then tighten the bolts on top (item 1 in Figure 7).

**△ CAUTION:** Make sure that the rack bolts provided with the mounting brackets fit the threaded holes in the rack.

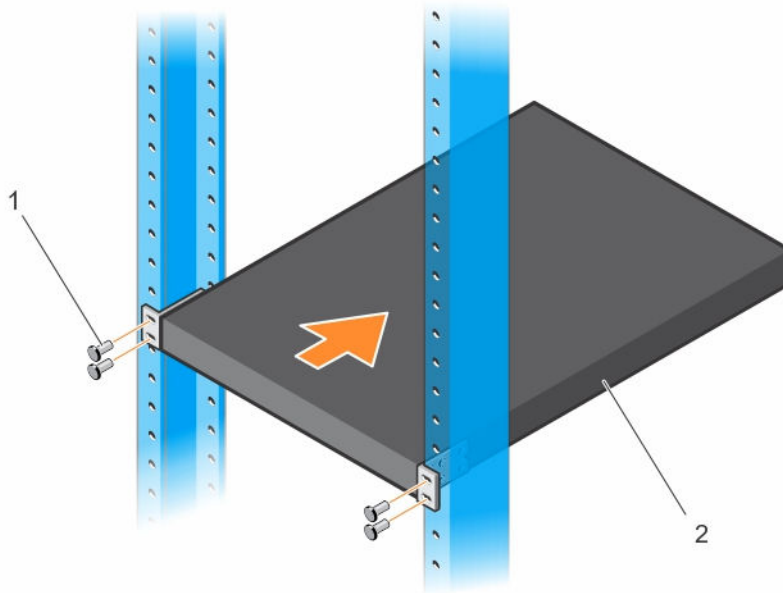

Figure 7. Mounting the C1048P in a 2-Post Rack

## Connecting to a C9010 Switch

The C1048P port extender has two 10G SFP+ ports on the front panel (see Figure 2). The two SFP+ ports provide 10GbE uplinks to a C9010 switch with SFP+ transceivers. At least one 10GbE SFP+ uplink is required to connect to a C9010 switch.

**NOTE:** A C1048P can connect to a C9010 switch only through a 10GbE SFP+ port; a C1048P cannot connect to a C9010 through a 10/100/1000 Mbps RJ-45 port.

**CAUTION:** ESD damage can occur if the components are mishandled. Always wear an ESD-preventive wrist or heel ground strap when handling the PE and its components.

**WARNING:** When working with optical fibres, follow all the warning labels and always wear eye protection. Never look directly into the end of a terminated or unterminated fibre or connector as it may cause eye damage.



To connect to a C9010:

1. Position the SFP+ optic correctly over a port. The optic has a key that prevents it from being inserted incorrectly.
2. Insert the optic into an SFP+ port until it gently snaps into place.
3. Connect one end of an appropriately connectorized fiber-optic cable into the port. Connect the other end to an SFP+ connector in a C9010 switch.

## Stacking Multiple C1048P Port Extenders

The C1048P supports PE stacking, which allows multiple C1048P units to act as a single port extender. You can stack up to eight C1048Ps using the stack ports on the back panel.

C1048P stack ports support the Serial Attached SCSI (SAS) protocol and operate as mini-SAS ports. The C1048P supports stacking only with other C1048P port extenders. The stacked PEs operate as a single unit with up to 384 front panel ports.

-  **NOTE:** If you are installing a stack of C1048Ps, assemble and cable the stack before powering it up. When you power up a stack for the first time, the C1048P units receive the provisioned configuration from the parent C9010. A stack master unit is elected based on the highest MAC address. The master unit may occupy any location in the stack. The Stack Master LED on the front panel is illuminated on the master unit.
-  **NOTE:** Although individual C1048P stack members do not require a separate uplink to a parent C9010, Dell Networking recommends connecting more than one C1048P stack unit to the C9010 for redundancy. For more information, see [Connecting to a C9010 Switch](#).

### Creating a C1048P Stack

Create a C1048P stack by connecting adjacent units using the mini-SAS stack ports on the back panel. Figure 8 shows the switches connected in a ring topology, the recommended topology for a C1048P stack.

1. Install the C1048Ps to be stacked in a rack as described in [Installing the C1048P in a Rack](#).
2. Starting with the C1048P at the top of the stack, connect a mini-SAS cable from a stack port on its back panel into one of the stack ports on the C1048P directly below it in the rack. You must separately order mini-SAS cables. If necessary, use a longer (1 meter or 3 meter) mini-SAS cable to connect the C1048Ps.
3. Connect a mini-SAS cable in the other stack port on the second C1048P and into one of the stack ports on the third C1048P directly below it. Continue from top to bottom until all C1048Ps in the rack are connected with a mini-SAS cable.
4. Connect a mini-SAS cable from the bottom C1048P in the stack to the top C1048P to complete a ring topology.



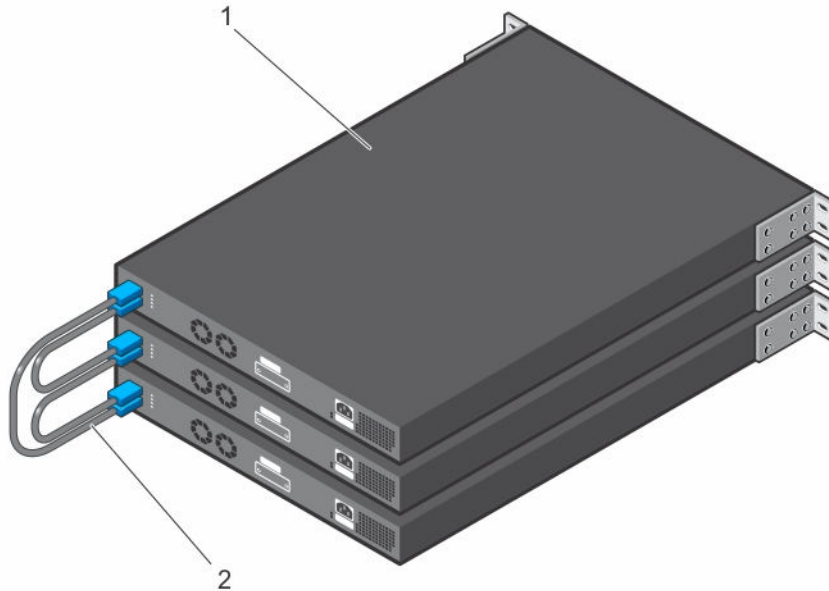

**Figure 8. C1048P Stack in a Ring Topology**

1. C1048P stack
2. Mini-SAS cables attached in a ring topology

The C1048P stack in Figure 8 is connected in a ring topology with the following physical connections between port extenders. The PEs are numbered Unit 0 to Unit 2. After you power on the stack units, the Stack Master LED on the C1048P that is elected master displays solid green.

- The bottom mini-SAS port on the top unit is connected to the top mini-SAS port on the middle unit.
- The bottom mini-SAS port on the middle unit is connected to the top mini-SAS port on the bottom unit.
- The bottom mini-SAS port on the bottom unit is connected to the top mini-SAS port on the top unit.

## C1048P Standby

A C1048P stack supports a standby or backup unit that assumes the stack master role if the master unit fails. When the system detects a stack-master failure, the C9010 initializes the standby unit and it becomes the stack master. The parent C9010 maintains the running configuration for the stack, which it pushes to all stack units.

When a PE stack first comes up, the master and standby units are chosen based on the MAC address. By default, the unit with the highest MAC address becomes the master; the unit with the second highest MAC address becomes the standby.

## Powering up the C1048P

 **CAUTION:** Read the safety information in the *Safety and Regulatory Information* manual and the safety information for C9000 Series switches that connect to the C1048P.

The C1048P has one internal power supply. The AC and DC power connectors are on the back panel (see [Back Panel](#)).

To power up a C1048P, connect it to an AC power source:

1. Using an IEC-320-C15 power cable with safety ground, connect the power cable to the AC main receptacle on the back panel.
2. Connect the power cable to a grounded AC outlet.

If you connect to a redundant, external DC power supply, use the Dell Networking MPS1000. Connect the DC power cable from the power supply to the DC receptacle on the back panel.

After you connect the C1048P to a power source, the C1048P boots up. After a successful boot-up, the temperature, power, system status, and fan LEDs display solid green. The fans adjust to an operational speed based on the current traffic load. The SFP+ Link LED displays solid green when the uplink to the parent C9010 is up. The SFP+ Activity LED blinks green when the uplink is transmitting/receiving data.

# Dell Networking Support

The Dell Networking Support site provides a range of documents and tools to assist you with using Dell Networking equipment and mitigating the impact of network outages. Through the support site you can obtain technical information regarding Dell Networking products, access software upgrades and patches, download available management software, and manage your open cases. The Dell Networking support site provides integrated, secure access to these services.

To access the Dell Networking Support site, go to <https://www.dell.com/support/>. To display information in your language, scroll down to the bottom of the web page and select your country from the drop-down menu.

- To obtain product-specific information, enter the 7-character service tag or 11-digit express service code of your C1048P and click **Submit**.  
To view the service tag or express service code on a C1048P, pull out the tag (item 1 in Figure 9) on the upper left side of the back panel.
- To receive additional kinds of technical support, click **Contact Us**. On the Contact Information web page, click **Technical Support**.

To access C9000 Series documentation, go to <https://www.dell.com/manuals/>.

To search for drivers and downloads, go to <https://www.dell.com/drivers/>.

To participate in Dell community blogs and forums, go to <https://www.dell.com/community>.

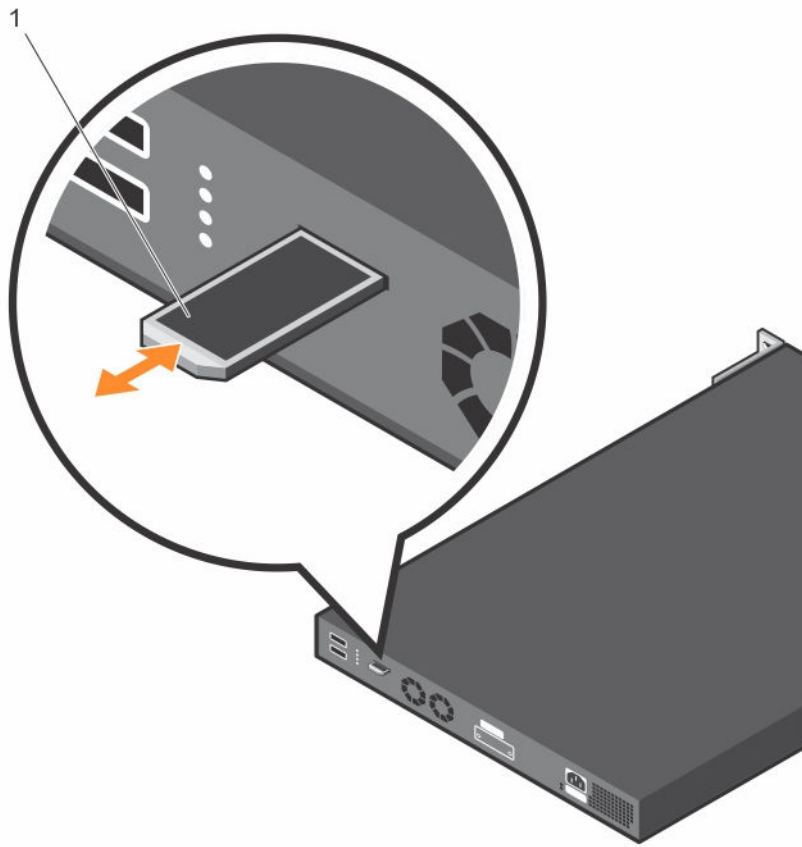

Figure 9. C1048P Service Tag

# Technical Specifications

The following tables describe the technical specifications for the C1048P port extender.

**Table 3. Chassis Physical Design**

Parameter	Specifications
Height	1.7 inches (4.35 cm)
Width	17.32 inches (44 cm)
Depth	15.23 inches (38.7 cm)
Chassis weight	15 lbs (6.8 kg) with factory installed components 44.31 lbs (20.1 kg) fully loaded

**Table 4. Environmental Parameters**

Parameter	Specifications
Operating temperature	32°F to 113°F (0°C to 45°C)
Maximum operating humidity	95% (non-condensing)
Storage temperature	-40°F to 149°F (-40°C to 65°C)
Storage relative humidity	85% (non-condensing)

**Table 5. AC Power Requirements**

Parameter	Specifications
Nominal input voltage	100-240 VAC 50/60 Hz
Maximum AC power supply input current (based on 1200W output for 100/120V lines and 1600W output for 200/240V lines)	8.9 A @ 100V per AC power supply 7.9 A @ 120V per AC power supply 3.85 A @ 200V per AC power supply 3.55 A @ 240V per AC power supply
Maximum steady state current consumption for main PSU with an MPS1000 external power supply bank	110V circuit: ~15.8A 220V circuit: ~7.7A
Maximum power consumption for main PSU with an MPS1000 external power supply bank	1,738W @ 110V 1,694W @ 220V

---

<b>Parameter</b>	<b>Specifications</b>
Maximum thermal output	1,017 BTU/hr @ 110V (1.738W - 1,440W PoE = 298W switch power)

---

# Agency Compliance

The C1048P complies with the following safety and agency requirements.

## European Union EMC Directive Conformance Statement

This product is in conformity with the protection requirements of EU Council Directive 2004/108/EC on the approximation of the laws of the Member States relating to electromagnetic compatibility. Dell Networking can not accept responsibility for any failure to satisfy the protection requirements resulting from a non-recommended modification of this product, including the fitting of non-Dell Networking option cards.

This product has been tested and found to comply with the limits for Class A Information Technology Equipment according to CISPR 22/European Standard EN 55022. The limits for Class A equipment were derived for commercial and industrial environments to provide reasonable protection against interference with licensed communication equipment.



**WARNING: This is a Class A product. In a domestic environment, this device may cause radio interference, in which case, you may be required to take adequate measures.**

European Community Contact

Dell Networking, EMEA - Central

Dahlienweg 19

66265 Heusweiler

Germany

<http://www.force10networks.com/german/>

Tel: +49 172 6802630

Email: EMEA Central Sales

## Japan: VCCI Compliance for Class A Equipment

この装置は、情報処理装置等電波障害自主規制協議会（VCCI）の  
に基づくクラスA情報技術装置です。この装置を家庭環境で使用する  
妨害を引き起こすことがあります。この場合には使用者が適切な対策を  
取るよう要求されることがあります。

Figure 10. Japan: VCCI Compliance for Class A Equipment

This is Class A product based on the standard of the Voluntary Control Council For Interference by Information Technology Equipment (VCCI). If this equipment is used in a domestic environment, radio disturbance may arise. When such trouble occurs, the user may be required to take corrective actions.

 **WARNING: Use the AC power cords with Dell Networking equipment only. Do not use Dell Force10 AC power cords with any unauthorized hardware.**

本製品に同梱いたしております電源コードセットは、本製品専用です。  
本電源コードセットは、本製品以外の製品ならびに他の用途でご使用い  
ただくことは出来ません。製品本体には同梱された電源コードセットを  
使用し、他製品の電源コードセットを使用しないで下さい。

Figure 11. Japan: Warning Label

## Korean Certification of Compliance

A급 기기 (업무용 방송통신기자재)	이 기기는 업무용(A급) 전자파적합기기로서 판 매자 또는 사용자는 이 점을 주의하시기 바라 며, 가정외의 지역에서 사용하는 것을 목적으로 합니다.
------------------------	--

Figure 12. Korean Certification of Compliance



	 <i>[equipment type]</i>
품명(Product Name)	Ethernet Switch
모델명(Model)	<i>[model number]</i>
신청인(Applicant)	Force10 Networks, Inc.
제조사(Manufacturer)	Delta Networks, (Dongguan) Ltd.
제조년월(Manufacturing Date)	<i>[date]</i>
제조국(Country of Origin)	China

Figure 13. Korean Package Label

## Safety Standards and Compliance Agency Certifications

- CUS UL 60950-1, 2nd Edition or later
- CSA 60950-1-03, 2nd Edition or later
- EN 60950-1, 2nd Edition or later
- EN 60825-1, 1st Edition or later
- EN 60825-1 Safety of Laser Products—Part 1: Equipment Classification Requirements and User's Guide
- EN 60825-2 Safety of Laser Products—Part 2: Safety of Optical Fibre Communication Systems
- FDA Regulation 21CFR 1040.10 and 1040.11
- IEC 60950-1, 2nd Edition or later, including all National Deviations and Group Differences

## Electromagnetic Compatibility (EMC)

### Emissions

- International: CISPR 22, Class A
- Australia/New Zealand: AS/NZS CISPR 22, Class A
- Canada: ICES-003, Issue-4, Class A
- Europe: EN55022 (CISPR 22), Class A
- Japan: VCCI V-3/2011.04 Class A
- USA: FCC CFR47 Part 15, Subpart B, Class A

### Immunity

- EN 300 386 v1.5.1 EMC for Network Equipment
- EN55022 Class A
- EN 55024 1998 + A1 + A2 or later

- EN 61000-3-2 Harmonic Current Emissions
- EN 61000-3-3 Voltage Fluctuations and Flicker
- EN 61000-4-2 ESD
- EN 61000-4-3 Radiated Immunity
- EN 61000-4-4 EFT
- EN 61000-4-5 Surge
- EN 61000-4-6 Low Frequency Conducted Immunity

## Product Recycling and Disposal

You must recycle or discard this system according to applicable local and national regulations. Dell Networking encourages owners of information technology (IT) equipment to responsibly recycle their equipment when it is no longer needed. Dell Networking offers a variety of product return programs and services in several countries to assist equipment owners in recycling their IT products.

### Waste Electrical and Electronic Equipment (WEEE) Directive for Recovery, Recycle and Reuse of IT and Telecommunications Products

Dell Networking switches are labeled in accordance with European Directive 2002/96/EC concerning waste electrical and electronic equipment (WEEE). The Directive determines the framework for the return and recycling of used appliances as applicable throughout the European Union. This label is applied to various products to indicate that the product is not to be thrown away, but rather reclaimed upon end of life per this Directive.



**Figure 14. The European WEEE Symbol**

In accordance with the European WEEE Directive, electrical and electronic equipment (EEE) is to be collected separately and to be reused, recycled, or recovered at end of life. Users of EEE with the WEEE marking per Annex IV of the WEEE Directive, as shown above, must not dispose of end of life EEE as unsorted municipal waste, but use the collection framework available to customers for the return, recycling and recovery of WEEE. Customer participation is important to minimize any potential effects of EEE on the environment and human health due to the potential presence of hazardous substances in EEE.

Dell Networking products, which fall within the scope of the WEEE, are labeled with the crossed-out wheelie-bin symbol, as shown above, as required by WEEE.

For information on Dell Networking product recycling offerings, see the WEEE Recycling instructions on iSupport. For more information, contact the Dell Networking Technical Assistance Center (TAC) (refer to [Contacting the Technical Assistance Center](#)).

## Free Manuals Download Website

<http://myh66.com>

<http://usermanuals.us>

<http://www.somanuals.com>

<http://www.4manuals.cc>

<http://www.manual-lib.com>

<http://www.404manual.com>

<http://www.luxmanual.com>

<http://aubethermostatmanual.com>

Golf course search by state

<http://golfingnear.com>

Email search by domain

<http://emailbydomain.com>

Auto manuals search

<http://auto.somanuals.com>

TV manuals search

<http://tv.somanuals.com>