

Dell OptiPlex 3011 AIO Owner's Manual

Regulatory Model: W07B
Regulatory Type: W07B001



Notes, Cautions, and Warnings



NOTE: A NOTE indicates important information that helps you make better use of your computer.



CAUTION: A CAUTION indicates either potential damage to hardware or loss of data and tells you how to avoid the problem.



WARNING: A WARNING indicates a potential for property damage, personal injury, or death.

© 2013 Dell Inc. All Rights Reserved.

Trademarks used in this text: Dell™, the DELL logo, Dell Precision™, Precision ON™, ExpressCharge™, Latitude™, Latitude ON™, OptiPlex™, Venue™, Vostro™, and Wi-Fi Catcher™ are trademarks of Dell Inc. Intel®, Pentium®, Xeon®, Core™, Atom™, Centrino®, and Celeron® are registered trademarks or trademarks of Intel Corporation in the U.S. and other countries. AMD® is a registered trademark and AMD Opteron™, AMD Phenom™, AMD Sempron™, AMD Athlon™, ATI Radeon™, and ATI FirePro™ are trademarks of Advanced Micro Devices, Inc. Microsoft®, Windows®, MS-DOS®, Windows Vista®, the Windows Vista start button, and Office Outlook® are either trademarks or registered trademarks of Microsoft Corporation in the United States and/or other countries. Blu-ray Disc™ is a trademark owned by the Blu-ray Disc Association (BDA) and licensed for use on discs and players. The Bluetooth® word mark is a registered trademark and owned by the Bluetooth® SIG, Inc. and any use of such mark by Dell Inc. is under license. Wi-Fi® is a registered trademark of Wireless Ethernet Compatibility Alliance, Inc.

2013 - 11

Rev. A01

Contents

1 Working on Your Computer.....	5
Before Working Inside Your Computer.....	5
Recommended Tools.....	6
Turning Off Your Computer.....	6
After Working Inside Your Computer.....	7
Important Information.....	7
2 Removing and Installing Components.....	8
System Overview.....	8
Inside view	8
Removing the Stand Cover.....	9
Installing the Stand Cover.....	9
Removing the VESA Stand.....	9
Installing the VESA Stand.....	10
Removing the Back Cover.....	10
Installing the Back Cover.....	12
Removing the Optical Disk Drive.....	12
Installing the Optical Disk Drive.....	13
Removing the Control Board.....	13
Installing the Control Board.....	14
Removing the Wireless Local Area Network (WLAN) Card.....	14
Installing the WLAN Card.....	15
Removing the Memory.....	15
Installing the Memory.....	16
Removing the System Board Cover.....	16
Installing the System Board Cover.....	17
Removing the Coin-Cell Battery.....	17
Installing the Coin-Cell Battery.....	18
Removing the Heat Sink.....	18
Installing the Heat Sink.....	19
Removing the System Fan.....	19
Installing the System Fan.....	19
Removing the Processor.....	20
Installing the Processor.....	20
Removing the Intrusion Switch.....	20
Installing the Intrusion Switch.....	21
Removing the Speakers.....	21
Installing the Speakers.....	22

Removing the Power Switch.....	22
Installing the Power Switch.....	23
Removing the Hard Drive.....	23
Installing the Hard Drive.....	25
Removing the System Board.....	25
System Board Components.....	29
Installing the System Board.....	30
Removing the Display Bracket.....	30
Installing the Display Bracket.....	33
Removing the Camera.....	34
Installing the Camera.....	34
Removing the Serial Port.....	35
Installing the Serial Port.....	36
3 System Setup.....	37
Boot Sequence.....	37
Navigation Keys.....	37
System Setup Options.....	38
Updating the BIOS	46
System and Setup Password.....	47
Assigning a System Password and Setup Password.....	47
Deleting or Changing an Existing System and/or Setup Password.....	48
4 Diagnostics.....	49
Enhanced Pre-Boot System Assessment (ePSA) Diagnostics.....	49
5 Troubleshooting Your Computer.....	50
Important Information.....	50
Diagnostic Power LED Codes.....	50
Beep Codes.....	51
Error Messages.....	51
6 Technical Specifications.....	53
7 Contacting Dell.....	58

Working on Your Computer

Before Working Inside Your Computer

Use the following safety guidelines to help protect your computer from potential damage and to help to ensure your personal safety. Unless otherwise noted, each procedure included in this document assumes that the following conditions exist:

- You have read the safety information that shipped with your computer.
- A component can be replaced or--if purchased separately--installed by performing the removal procedure in reverse order.

 **WARNING:** Before working inside your computer, read the safety information that shipped with your computer. For additional safety best practices information, see the Regulatory Compliance Homepage at www.dell.com/regulatory_compliance

 **CAUTION:** Many repairs may only be done by a certified service technician. You should only perform troubleshooting and simple repairs as authorized in your product documentation, or as directed by the online or telephone service and support team. Damage due to servicing that is not authorized by Dell is not covered by your warranty. Read and follow the safety instructions that came with the product.

 **CAUTION:** To avoid electrostatic discharge, ground yourself by using a wrist grounding strap or by periodically touching an unpainted metal surface, such as a connector on the back of the computer.

 **CAUTION:** Handle components and cards with care. Do not touch the components or contacts on a card. Hold a card by its edges or by its metal mounting bracket. Hold a component such as a processor by its edges, not by its pins.

 **CAUTION:** When you disconnect a cable, pull on its connector or on its pull-tab, not on the cable itself. Some cables have connectors with locking tabs; if you are disconnecting this type of cable, press in on the locking tabs before you disconnect the cable. As you pull connectors apart, keep them evenly aligned to avoid bending any connector pins. Also, before you connect a cable, ensure that both connectors are correctly oriented and aligned.

 **NOTE:** The color of your computer and certain components may appear differently than shown in this document.

To avoid damaging your computer, perform the following steps before you begin working inside the computer.

1. Ensure that your work surface is flat and clean to prevent the computer cover from being scratched.
2. Turn off your computer (see Turning Off Your Computer).

 **CAUTION:** To disconnect a network cable, first unplug the cable from your computer and then unplug the cable from the network device.

3. Disconnect all network cables from the computer.
4. Disconnect your computer and all attached devices from their electrical outlets.
5. Press and hold the power button while the computer is unplugged to ground the system board.
6. Remove the cover.

⚠ CAUTION: Before touching anything inside your computer, ground yourself by touching an unpainted metal surface, such as the metal at the back of the computer. While you work, periodically touch an unpainted metal surface to dissipate static electricity, which could harm internal components.

Recommended Tools



The procedures in this document may require the following tools:

- Small flat-blade screwdriver
- Phillips screwdriver
- Small plastic scribe

Turning Off Your Computer

⚠ CAUTION: To avoid losing data, save and close all open files and exit all open programs before you turn off your computer.

1. Shut down the operating system:

- In Windows 8:
 - Using a touch-enabled device:
 - a. Swipe in from the right edge of the screen, opening the Charms menu and select **Settings**.
 - b. Select the  and then select **Shut down**
 - Using a mouse:
 - a. Point to upper-right corner of the screen and click **Settings**.
 - b. Click the  and select **Shut down**.

- In Windows 7:

1. Click **Start** .
2. Click **Shut Down**.

or

1. Click **Start** .
2. Click the arrow in the lower-right corner of the **Start** menu as shown below, and then click **Shut Down**.



2. Ensure that the computer and all attached devices are turned off. If your computer and attached devices did not automatically turn off when you shut down your operating system, press and hold the power button for about 6 seconds to turn them off.

After Working Inside Your Computer

After you complete any replacement procedure, ensure you connect any external devices, cards, and cables before turning on your computer.

1. Replace the cover.



CAUTION: To connect a network cable, first plug the cable into the network device and then plug it into the computer.

2. Connect any telephone or network cables to your computer.
3. Connect your computer and all attached devices to their electrical outlets.
4. Turn on your computer.
5. If required, verify that the computer works correctly by running the Dell Diagnostics.

Important Information



NOTE: Avoid using the touchscreen in dusty, hot, or humid environments.



NOTE: Sudden change in temperature may cause condensation on the inner surface of the glass screen, which will disappear after a short time and does not affect normal usage.

Removing and Installing Components

This section provides detailed information on how to remove or install the components from your computer.

System Overview

The following figure displays the inside view of the computer after the back cover has been removed. The call outs show the names and the layout of the components inside the computer.

Inside view

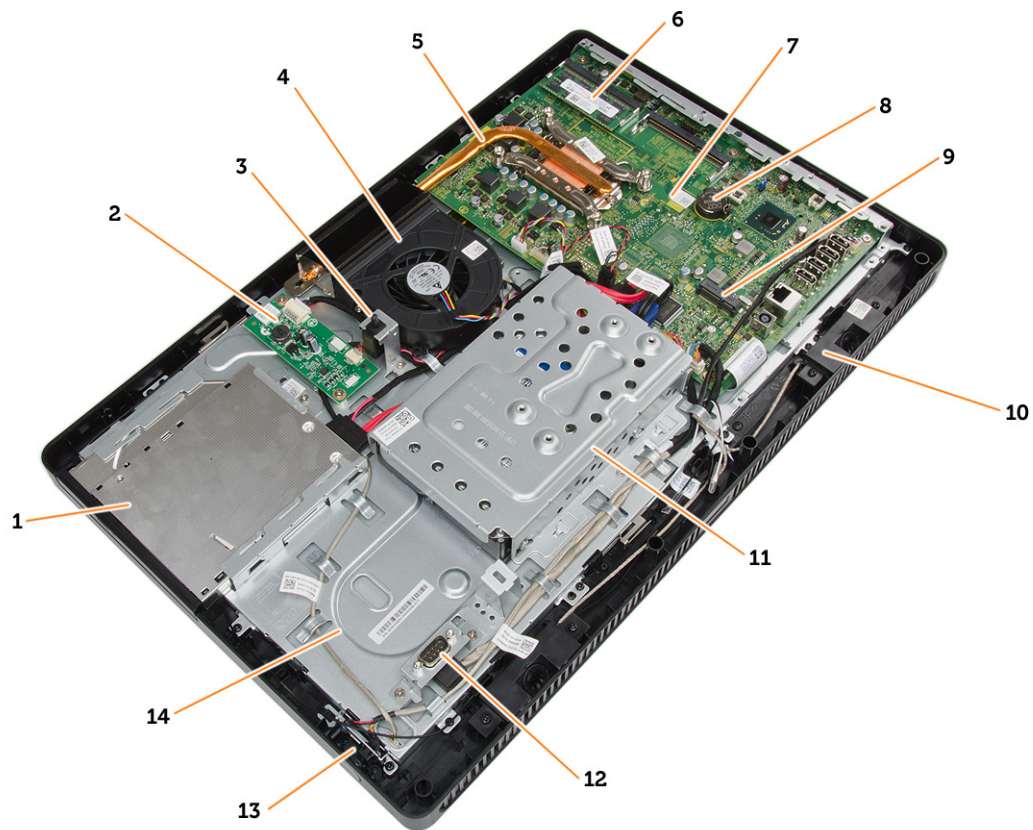

1. optical disk drive
2. control board
3. intrusion switch
4. system fan
5. heat sink

6. memory
7. system board
8. coin-cell battery
9. speaker
10. WLAN card slot
11. hard drive
12. communication port
13. power switch
14. chassis

Removing the Stand Cover

1. Follow the procedures in *Before Working Inside Your Computer*.
2. Place the computer on a flat surface, display side facing downwards.
3. Press the tab in to release the stand cover and remove it from the computer.

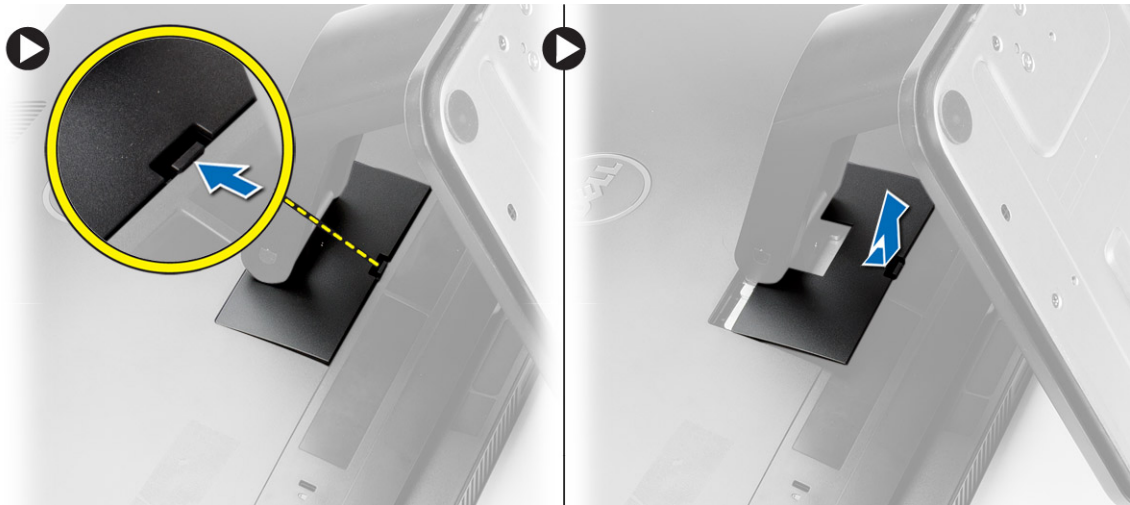

Installing the Stand Cover

1. Slide the stand cover into its place and press to secure it to the computer.
2. Follow the procedures in *After Working Inside Your Computer*.

Removing the VESA Stand

1. Follow the procedures in *Before Working Inside Your Computer*.
2. Remove the stand cover.
3. Remove the screws that secure the VESA stand to the computer and remove the VESA stand from the computer.



Installing the VESA Stand

1. Place the VESA stand on the computer.
2. Tighten the screws to secure the VESA stand to the computer.
3. Install:
 - a. stand cover
4. Follow the procedures in *After Working Inside Your Computer*.

Removing the Back Cover

1. Follow the procedures in *Before Working Inside Your Computer*.
2. Remove:
 - a. stand cover
 - b. VESA stand
3. Using a plastic scribe, release the back cover from the computer.



4. Remove the back cover from the computer.



Installing the Back Cover

1. Place the back cover on the computer.
2. Press at the corners of the back cover to secure it to the computer.
3. Install:
 - a. VESA stand
 - b. stand cover
4. Follow the procedures in *After Working Inside Your Computer*.

Removing the Optical Disk Drive

1. Follow the procedures in *Before Working Inside Your Computer*.
2. Remove:
 - a. stand cover
 - b. VESA stand
 - c. back cover
3. Remove the screw that secures the optical disk drive to the computer and disconnect the cable from the optical disk drive. Slide the optical disk drive out of the computer.

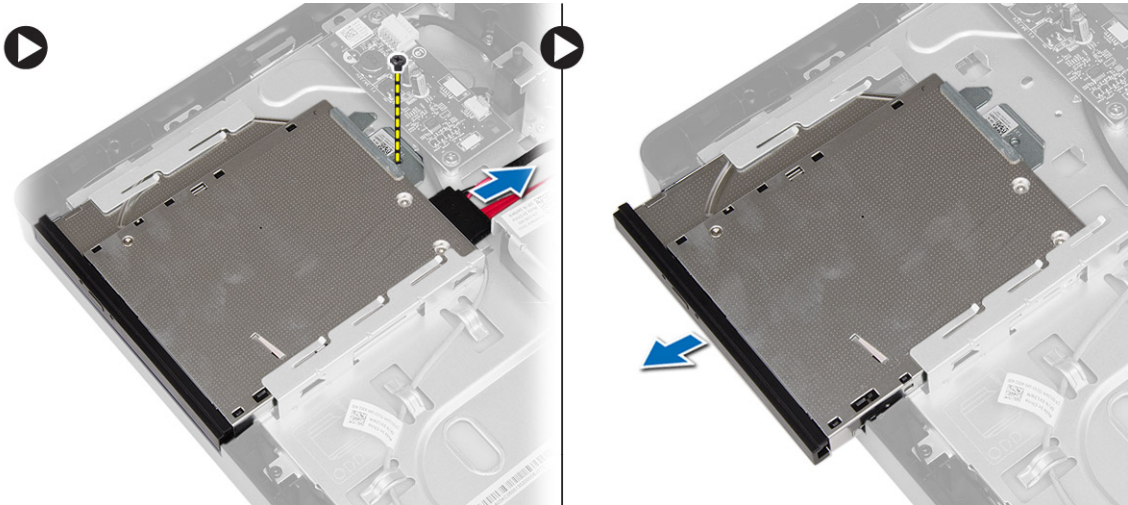

4. Remove the screws that secure the bracket to the optical disk drive and remove it from the optical drive.



Installing the Optical Disk Drive

1. Place the bracket on the optical disk drive and tighten the screws to secure it.
2. Slide the optical disk drive to the computer and tighten the screw to secure it.
3. Connect the cables to the control board.
4. Install:
 - a. back cover
 - b. VESA stand
 - c. stand cover
5. Follow the procedures in *After Working Inside Your Computer*.

Removing the Control Board

1. Follow the procedures in *Before Working Inside Your Computer*.
2. Remove:

- a. stand cover
 - b. VESA stand
 - c. back cover
3. Disconnect the cables from the control board and remove the screws that secure the control board to the computer. Remove the control board from the computer.

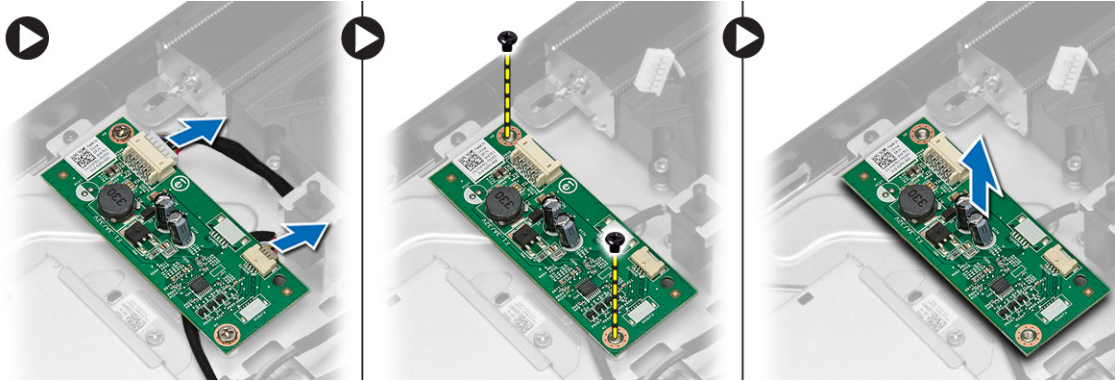

Installing the Control Board

1. Place the control board on the computer.
2. Tighten the screws to secure the control board to the computer.
3. Connect the cables to the control board.
4. Install:
 - a. back cover
 - b. VESA stand
 - c. stand cover
5. Follow the procedures in *After Working Inside Your Computer*.

Removing the Wireless Local Area Network (WLAN) Card

1. Follow the procedures in *Before Working Inside Your Computer*.
2. Remove:
 - a. stand cover
 - b. VESA stand
 - c. back cover
 - d. system board cover
3. Disconnect the antenna cables from the WLAN card. Remove the screw that secures the WLAN card to the system board. Lift and remove the WLAN card from the computer.

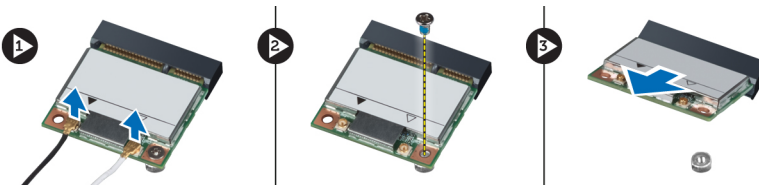

Installing the WLAN Card

1. Slide the WLAN card into its slot and tighten the screw to secure it to the system board.
2. Connect the antenna cables to the WLAN card.
3. Install:
 - a. system board cover
 - b. back cover
 - c. VESA stand
 - d. stand cover
4. Follow the procedures in *After Working Inside Your Computer*.

Removing the Memory

1. Follow the procedures in *Before Working Inside Your Computer*.
2. Remove:
 - a. stand cover
 - b. VESA stand
 - c. back cover
3. Remove the screw that secures the memory stand to the computer and slide to release the memory cover from the computer. Remove the memory cover from the computer.

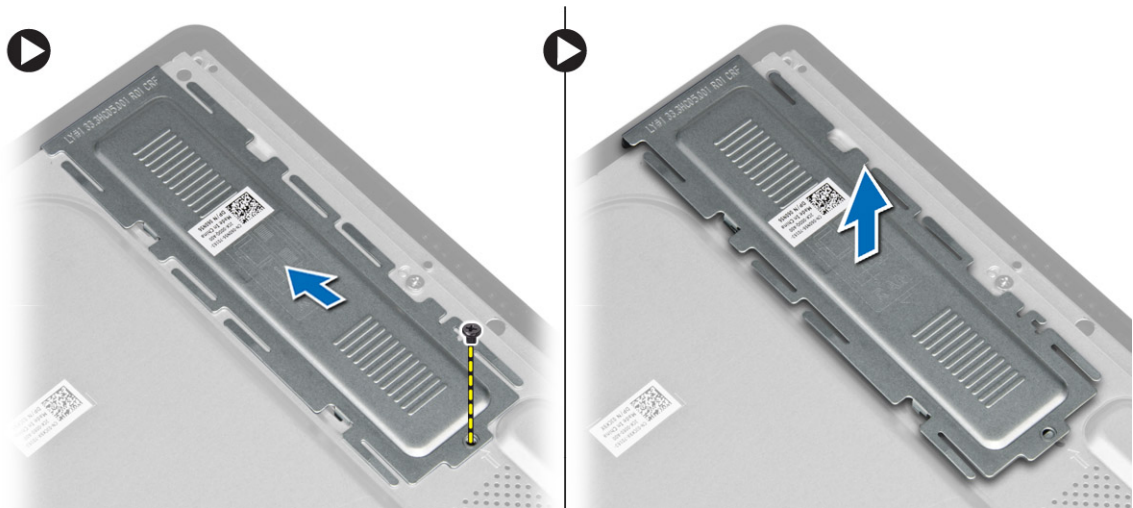

4. Pry the retention clips away from the memory module until it pops up. Lift and remove the memory module from its connector.

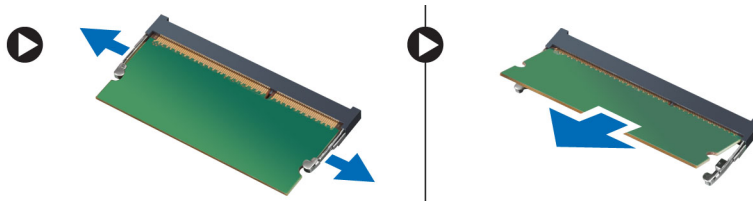

Installing the Memory

1. Align the notch on the memory-card with the tab in the system-board connector.
2. Press down on the memory module until the release tabs spring back to secure them in place.
3. Place the memory cover back into its place and tighten the screw to secure it.
4. Install:
 - a. back cover
 - b. VESA stand
 - c. stand cover
5. Follow the procedures in *After Working Inside Your Computer*.

Removing the System Board Cover

1. Follow the procedures in *Before Working Inside Your Computer*.
2. Remove:
 - a. stand cover
 - b. VESA stand
 - c. back cover
3. Remove the screw that secures the system board cover to the computer.

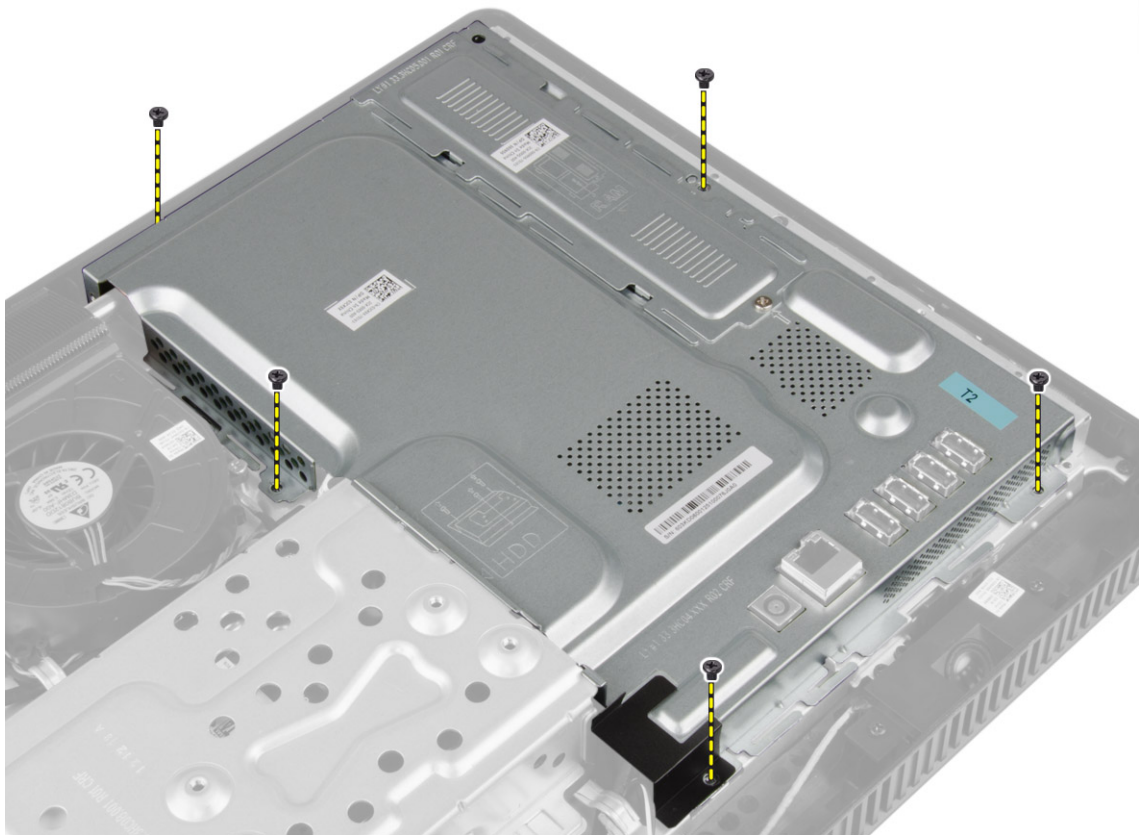

4. Lift the system board cover up to remove it from the computer.

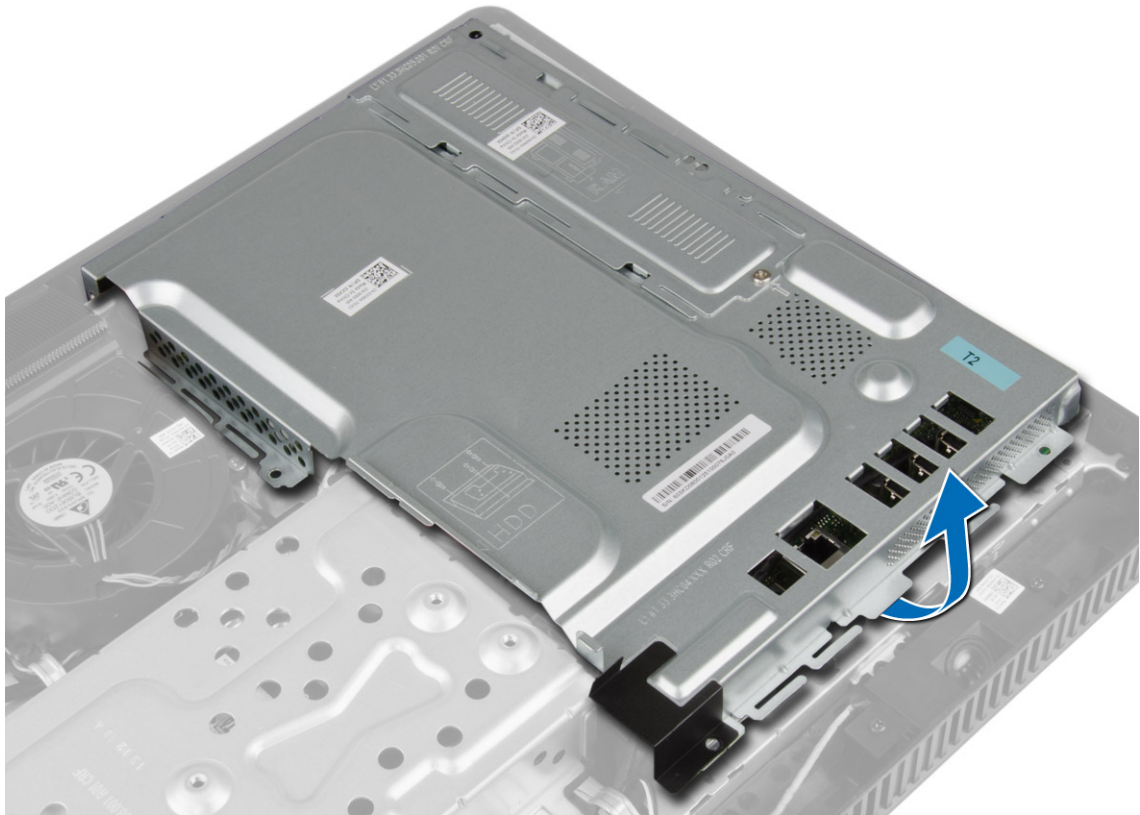

Installing the System Board Cover

1. Place the system board cover on the computer.
2. Tighten the screws to secure the system board cover to the computer.
3. Install:
 - a. back cover
 - b. VESA stand
 - c. stand cover
4. Follow the procedures in *After Working Inside Your Computer*.

Removing the Coin-Cell Battery

1. Follow the procedures in *Before Working Inside Your Computer*.
2. Remove:
 - a. stand cover
 - b. VESA stand
 - c. back cover
 - d. system board cover
3. Press the release latch away from the battery to allow the battery to pop up from the socket and lift the coin-cell battery out of the computer.

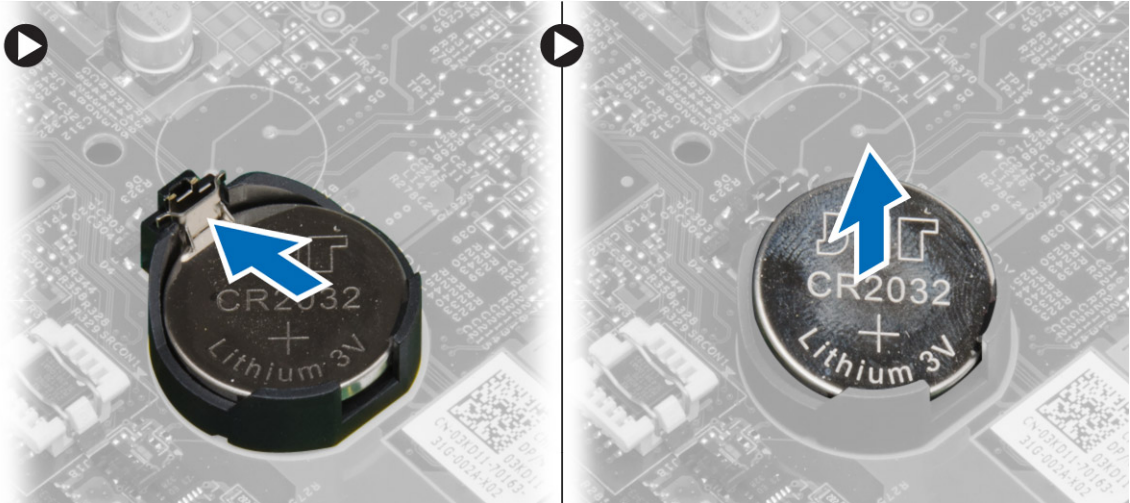

Installing the Coin-Cell Battery

1. Place the coin-cell battery into its slot on the system board.
2. Press the coin-cell battery downward until the release latch springs back into place and secures it.
3. Install:
 - a. system board cover
 - b. back cover
 - c. VESA stand
 - d. stand cover
4. Follow the procedures in *After Working Inside Your Computer*.

Removing the Heat Sink

1. Follow the procedures in *Before Working Inside Your Computer*.
2. Remove:
 - a. stand cover
 - b. VESA stand
 - c. back cover
 - d. system board cover
3. Remove the screws that secure the heat sink to the computer and remove it from the computer.

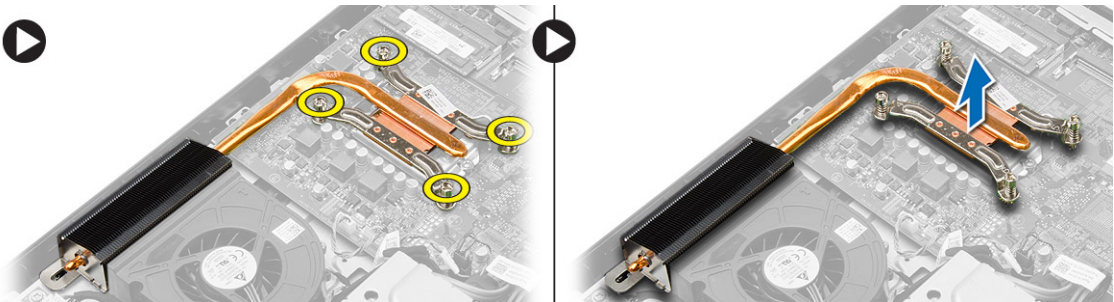

Installing the Heat Sink

1. Place the heat sink on the computer.
2. Tighten the screws to secure the heat sink to the computer.
3. Install:
 - a. system board cover
 - b. back cover
 - c. VESA stand
 - d. stand cover
4. Follow the procedures in *After Working Inside Your Computer*.

Removing the System Fan

1. Follow the procedures in *Before Working Inside Your Computer*.
2. Remove:
 - a. stand cover
 - b. VESA stand
 - c. back cover
 - d. system board cover
3. Disconnect and release the system-fan cable from the system board. Remove the screws that secure the system fan to the computer and remove it from the computer.

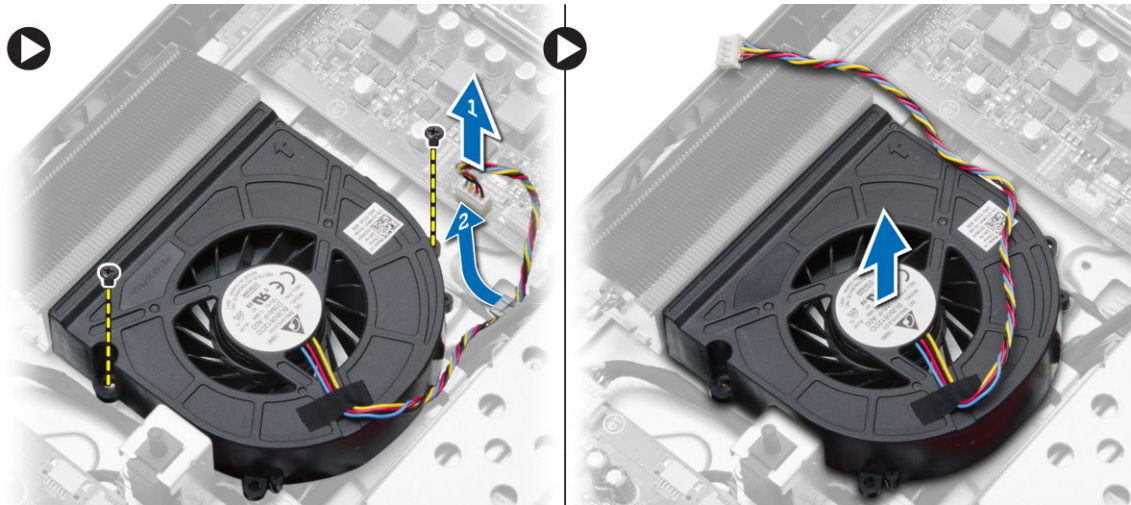

Installing the System Fan

1. Place the system fan on the computer.
2. Guide the system-fan cable through its tab on the computer and connect the cable to the system board.
3. Install:
 - a. system board cover
 - b. back cover
 - c. VESA stand
 - d. stand cover

4. Follow the procedures in *After Working Inside Your Computer*.

Removing the Processor

1. Follow the procedures in *Before Working Inside Your Computer*.
2. Remove the:
 - a. stand cover
 - b. VESA stand
 - c. back cover
 - d. system board cover
 - e. heat sink
3. Press the release lever down and then move it outward to release it from the retention hook that secures it. Lift the processor cover and remove the processor from its socket.



Installing the Processor

1. Insert the processor into the processor socket. Ensure the processor is properly seated.
2. Press the release lever down and then move it inward to secure it with the retention hook.
3. Install:
 - a. heat sink
 - b. system board cover
 - c. back cover
 - d. VESA stand
 - e. stand cover
4. Follow the procedures in *After Working Inside Your Computer*.

Removing the Intrusion Switch

1. Follow the procedures in *Before Working Inside Your Computer*.
2. Remove:
 - a. stand cover
 - b. VESA stand
 - c. back cover
 - d. system board cover
 - e. system fan
3. Disconnect the intrusion-switch cable from the system board and release the cable from its tab on the chassis. Slide and remove the intrusion switch from the computer.

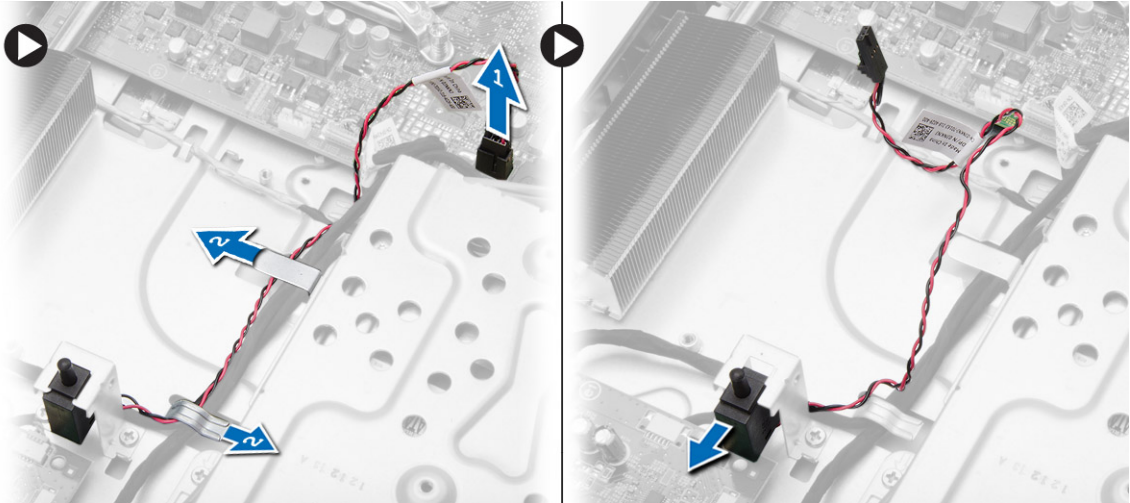

Installing the Intrusion Switch

1. Place the intrusion switch on the computer.
2. Guide the intrusion-switch cables through the tabs on the computer and connect the cable to the system board.
3. Install:
 - a. system fan
 - b. system board cover
 - c. back cover
 - d. VESA stand
 - e. stand cover
4. Follow the procedures in *After Working Inside Your Computer*.

Removing the Speakers

1. Follow the procedures in *Before Working Inside Your Computer*.
2. Remove:
 - a. stand cover
 - b. VESA stand
 - c. back cover
 - d. system board cover
3. Disconnect the speaker cable from the system board. Remove the screws that secure the speakers to the computer and remove the speakers from the computer.

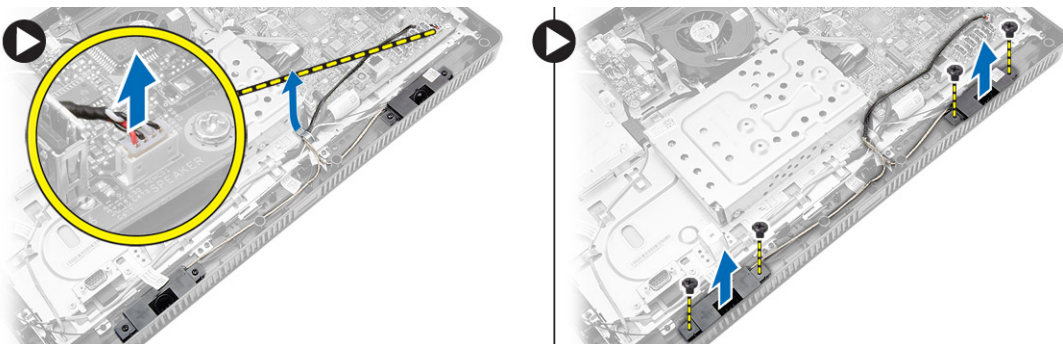

Installing the Speakers

1. Tighten the screws to secure the speakers to the computer.
2. Guide the speaker cables through the tabs on the computer and connect the cable to the system board.
3. Install:
 - a. system board cover
 - b. back cover
 - c. VESA stand
 - d. stand cover
4. Follow the procedures in *After Working Inside Your Computer*.

Removing the Power Switch

1. Follow the procedures in *Before Working Inside Your Computer*.
2. Remove:
 - a. stand cover
 - b. VESA stand
 - c. back cover
 - d. system board cover
3. Disconnect the power-switch cable from the system board. Release the power-switch cable from its tabs on the chassis.

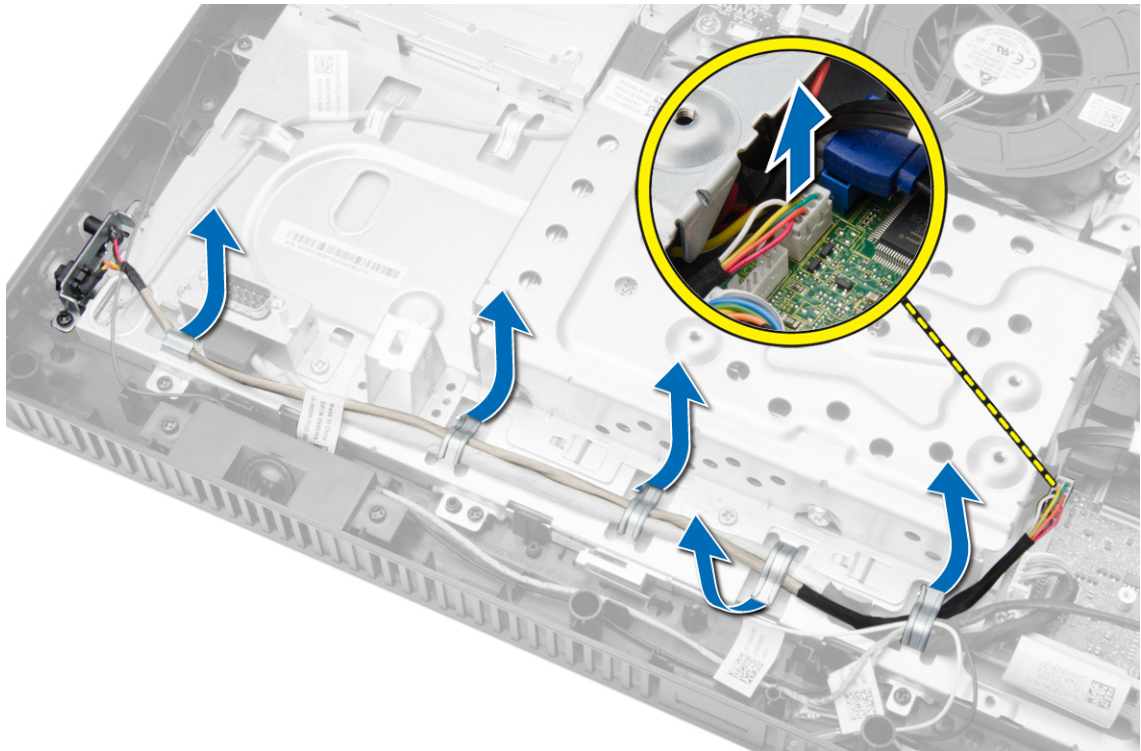

4. Remove the screw that secures the power switch to the computer. Release and remove the power switch from the computer.

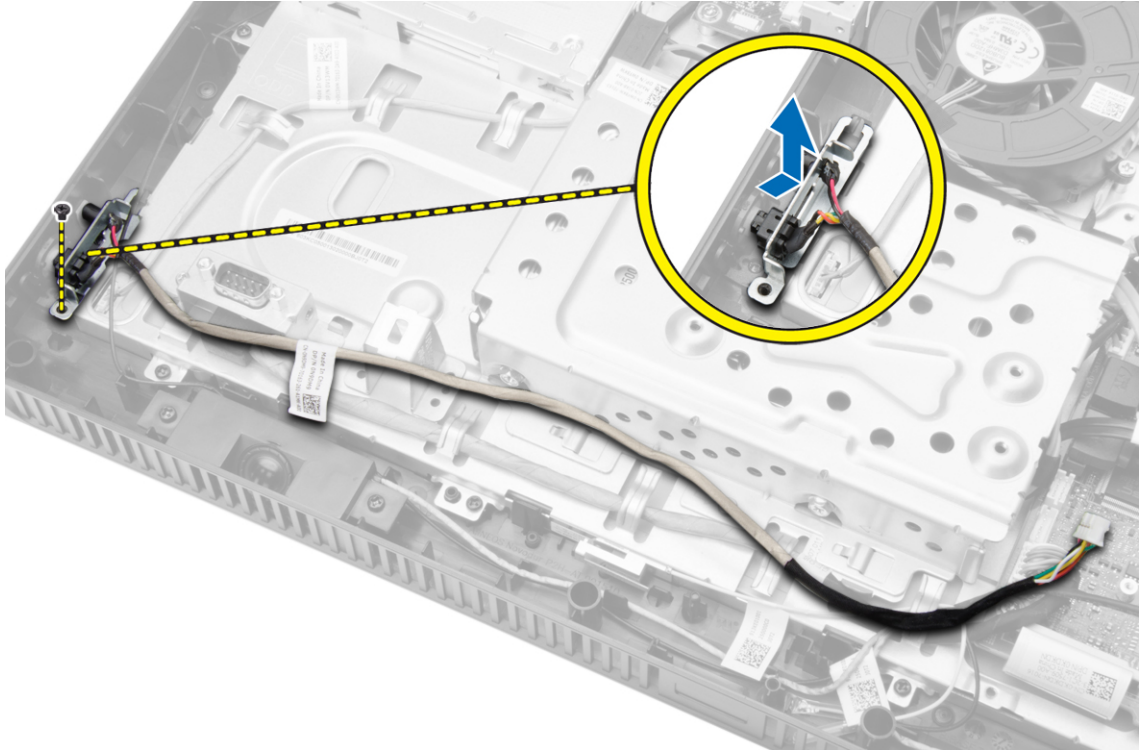

Installing the Power Switch

1. Place the power switch into its slot on the computer and tighten the screws to secure the it to the computer.
2. Guide the power-switch cable through the tabs on the computer and connect the power-switch cable to the system board.
3. Install:
 - a. system board cover
 - b. back cover
 - c. VESA stand
 - d. stand cover
4. Follow the procedures in *After Working Inside Your Computer*.

Removing the Hard Drive

1. Follow the procedures in *Before Working Inside Your Computer*.
2. Remove:
 - a. stand cover
 - b. VESA stand
 - c. back cover
3. Move the hard-drive cable to access the hard-drive bracket screws. Remove the screws and slide the hard-drive bracket to release it from the chassis.

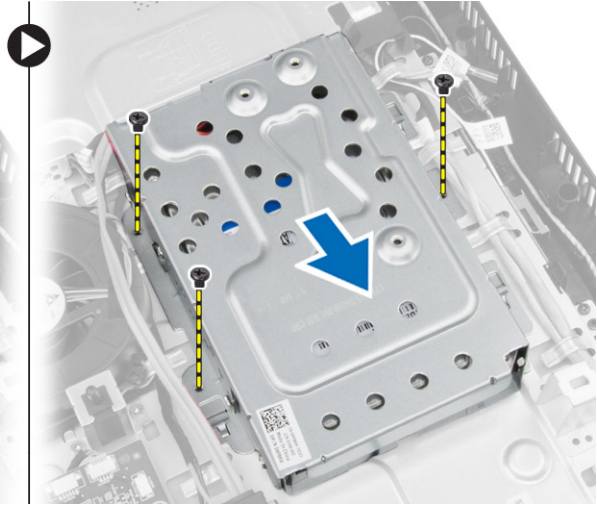
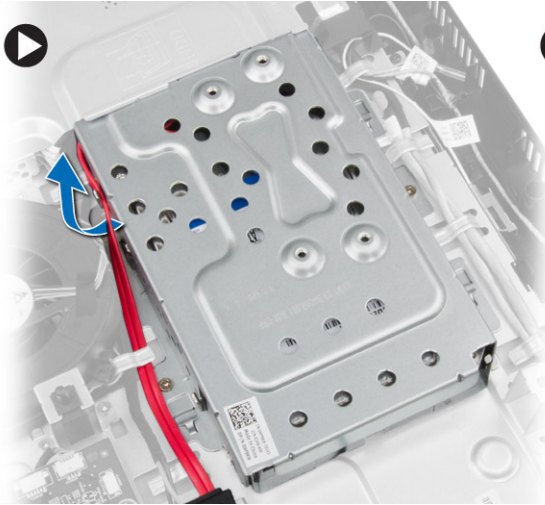

4. Turn and place the hard drive on the hard-drive bracket to access the hard-drive cable. Disconnect the hard-drive cable from the hard drive.

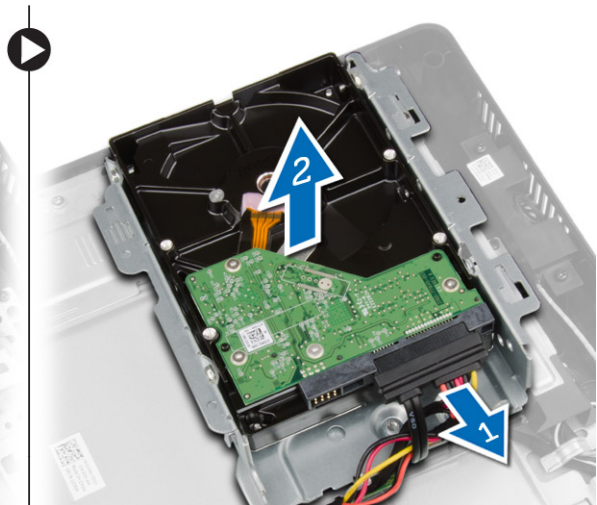
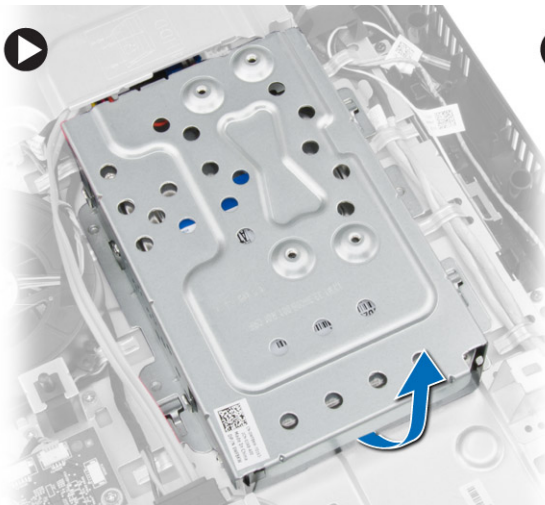

5. Remove the screws that secure the hard-drive bracket to the hard drive and remove the hard drive from the hard-drive bracket.

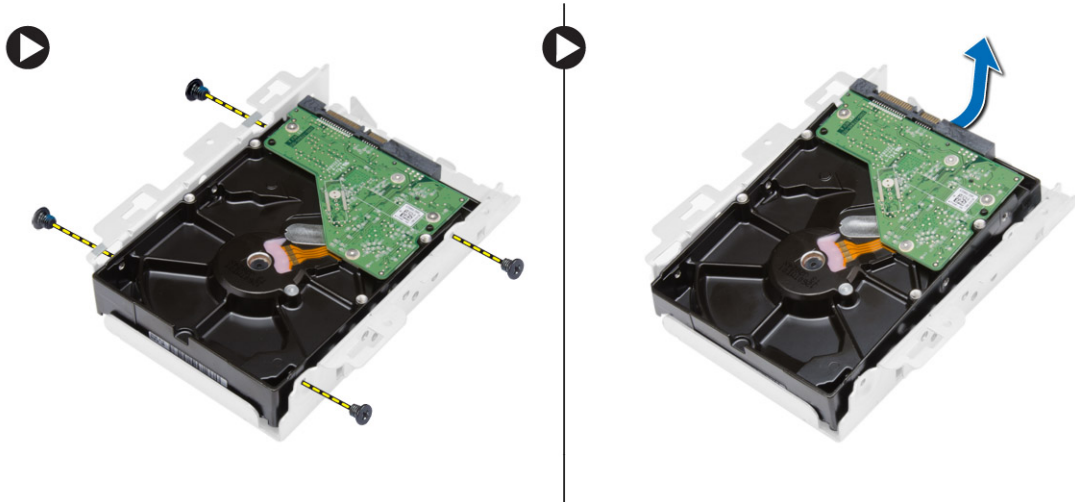

Installing the Hard Drive

1. Place the hard drive in the bracket and tighten the screws to secure the hard drive to the bracket.
2. Connect the hard-drive cable to the hard drive and place the hard drive into its slot on the computer.
3. Tighten the screws to secure the hard-drive bracket to the computer.
4. Install:
 - a. back cover
 - b. VESA stand
 - c. stand cover
5. Follow the procedures in *After Working Inside Your Computer*.

Removing the System Board

1. Follow the procedures in *Before Working Inside Your Computer*.
2. Remove:
 - a. stand cover
 - b. VESA stand
 - c. back cover
 - d. system board cover
 - e. memory
 - f. WLAN card
 - g. heat sink
 - h. hard drive
 - i. optical disk drive
3. Disconnect all the cables connected to the system board.

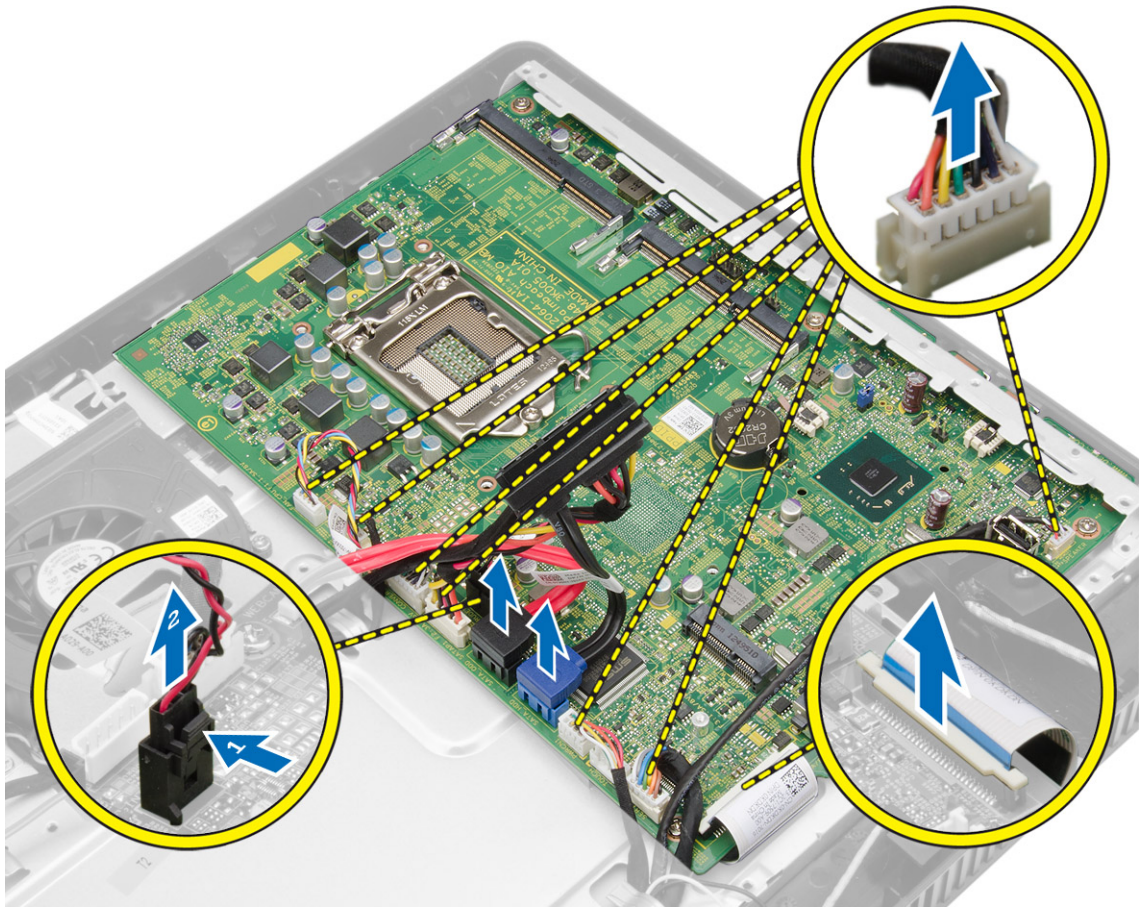

4. Remove the screws that secure the system board to the chassis of the computer and slide the system board to release it from the chassis.

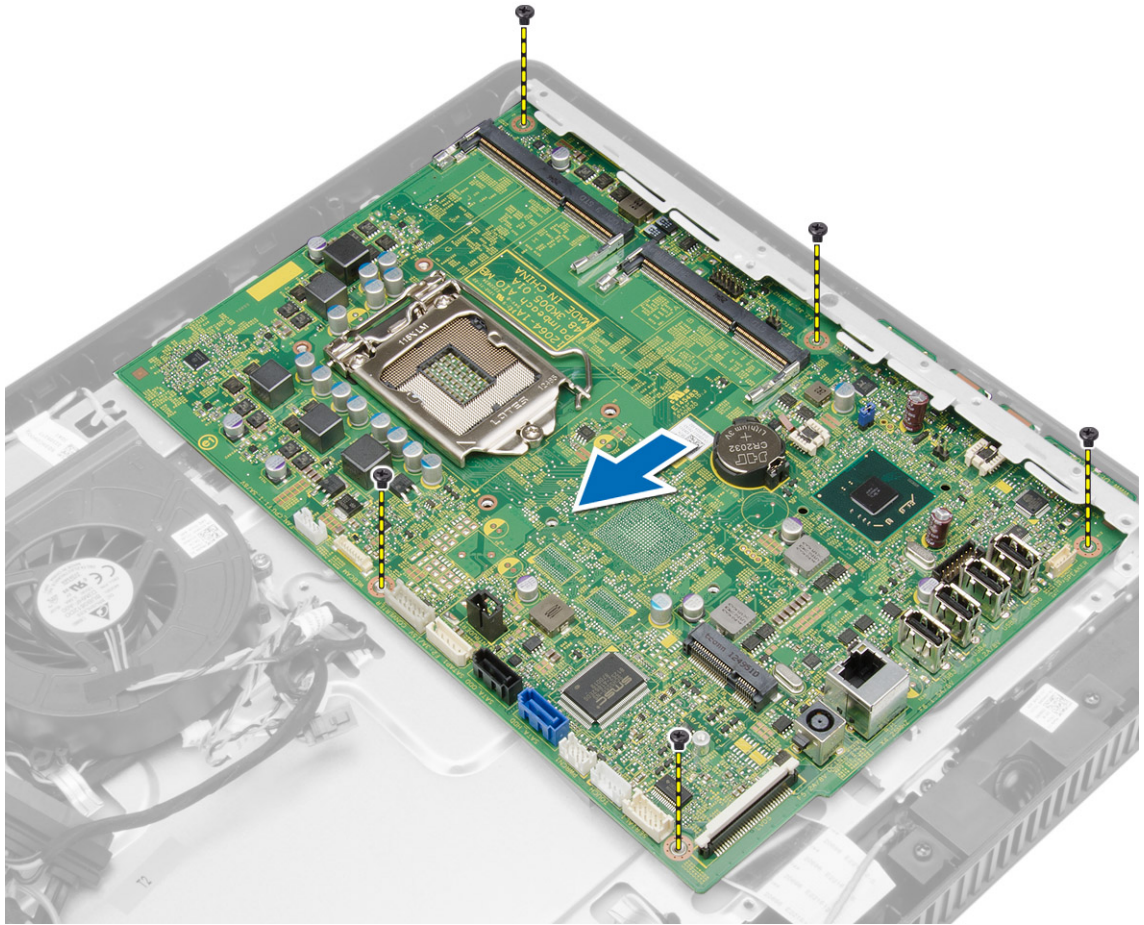

5. Lift the system board from one side to remove it from the computer.

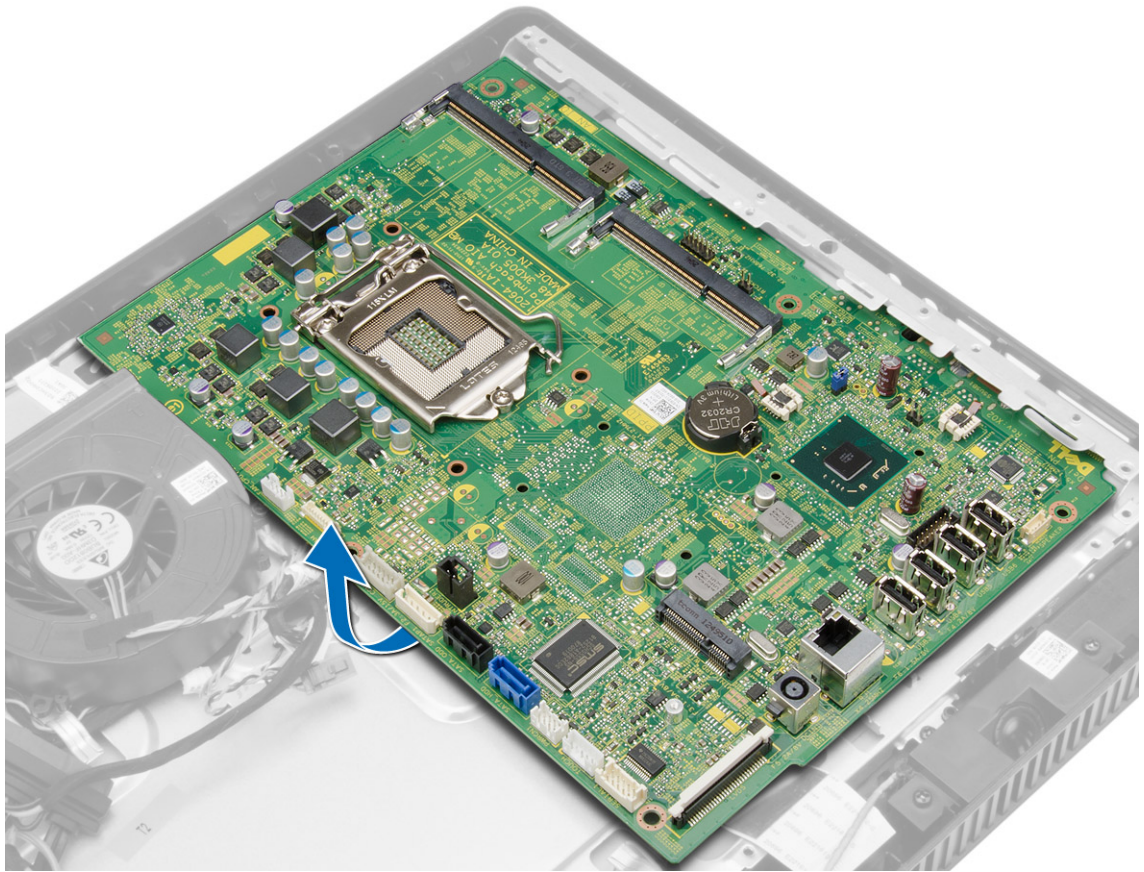

System Board Components

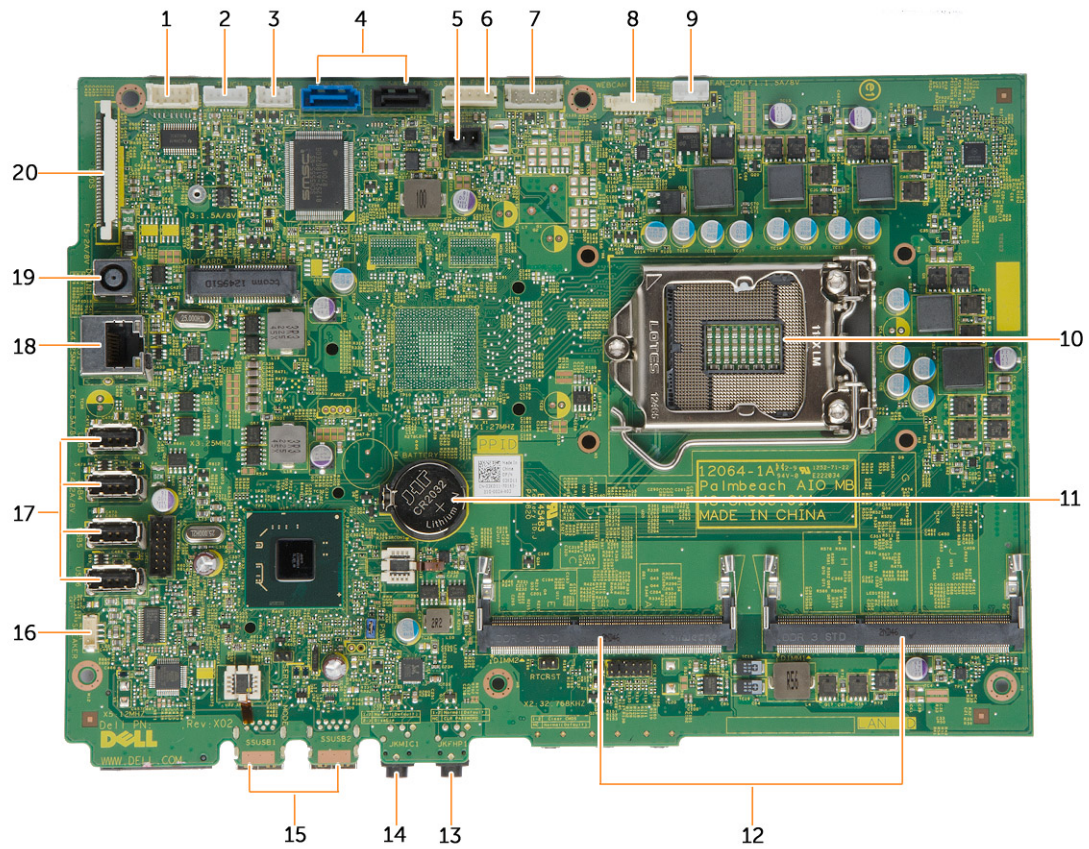

Figure 1. Components Of The System Board

- | | |
|-------------------------------|---|
| 1. serial port connector | 2. touchscreen board connector |
| 3. LED board connector | 4. SATA connectors |
| 5. intrusion switch connector | 6. hard drive/optical drive power connector |
| 7. converter board connector | 8. camera connector |
| 9. system fan connector | 10. CPU Socket |
| 11. coin-cell battery | 12. SO-DIMM memory slots (2) |
| 13. headphone connector | 14. microphone connector |
| 15. USB 3.0 connectors (2) | 16. speaker connector |
| 17. USB 2.0 connectors (4) | 18. network connector |
| 19. DC-in Connector | 20. LVDS connector |

Installing the System Board

1. Place the system board on the computer.
2. Tighten the screws to secure the system board to the base panel.
3. Connect all the cables to the system board.
4. Install:
 - a. optical disk drive
 - b. hard drive
 - c. heat sink
 - d. WLAN card
 - e. memory
 - f. system board cover
 - g. back cover
 - h. VESA stand
 - i. stand cover
5. Follow the procedures in *After Working Inside Your Computer*.

Removing the Display Bracket

1. Follow the procedures in *Before Working Inside Your Computer*.
2. Remove:
 - a. stand cover
 - b. VESA stand
 - c. back cover
 - d. system board cover
 - e. WLAN card
 - f. memory
 - g. heat sink
 - h. hard drive
 - i. optical disk drive
 - j. control board
 - k. system fan
 - l. intrusion switch
 - m. power switch
 - n. system board
3. Release the camera cable and the display cable from their tabs on the display bracket.

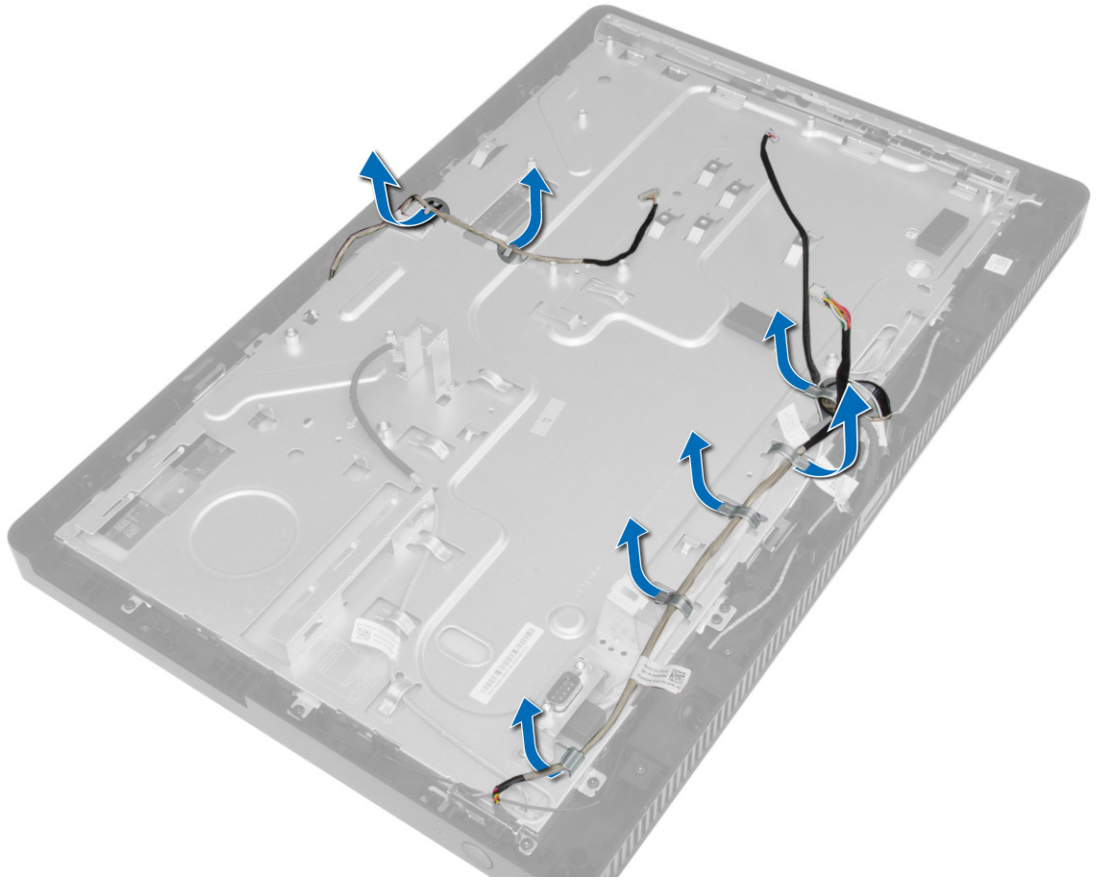

4. Remove the screws that secure the display bracket to the computer.
 **NOTE:** The number of screws to be removed in touch display is 8 only.

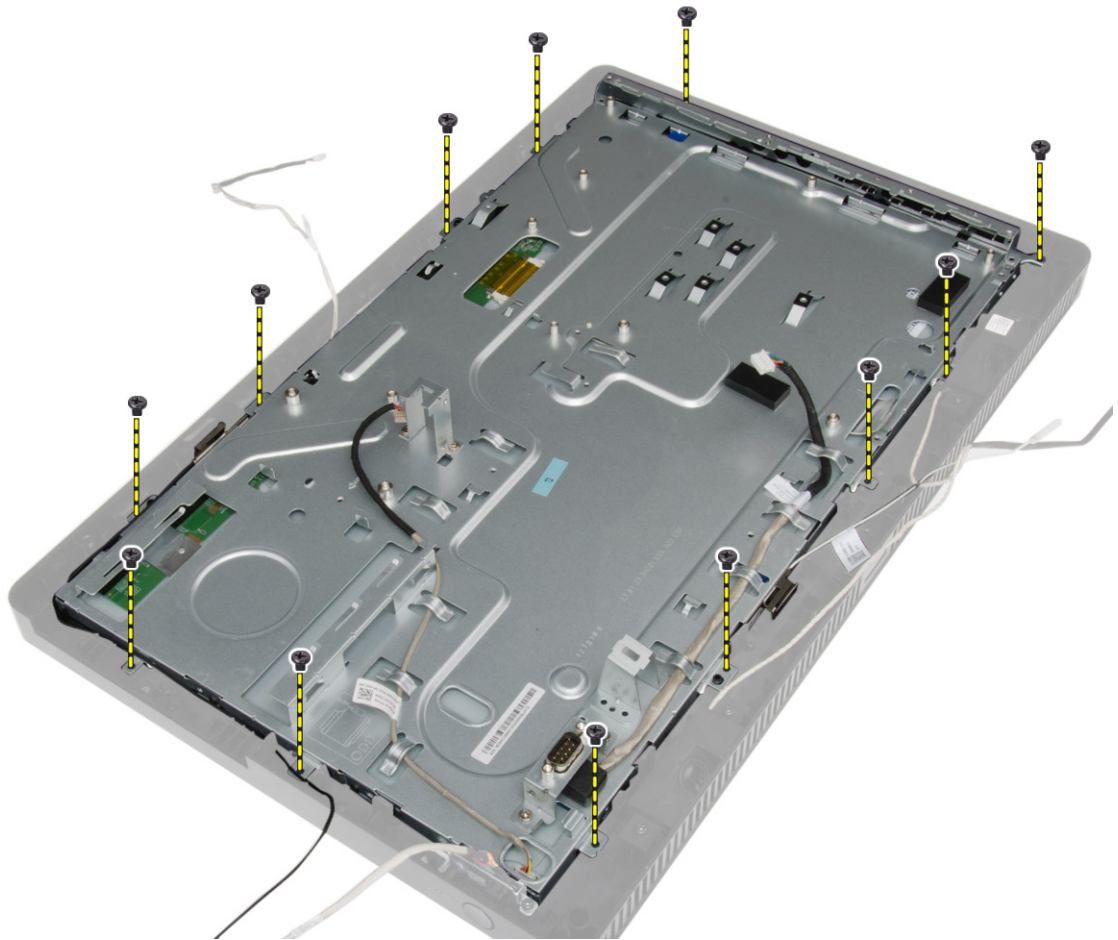

5. Release the display bracket from its tab on the chassis and remove it from the computer.

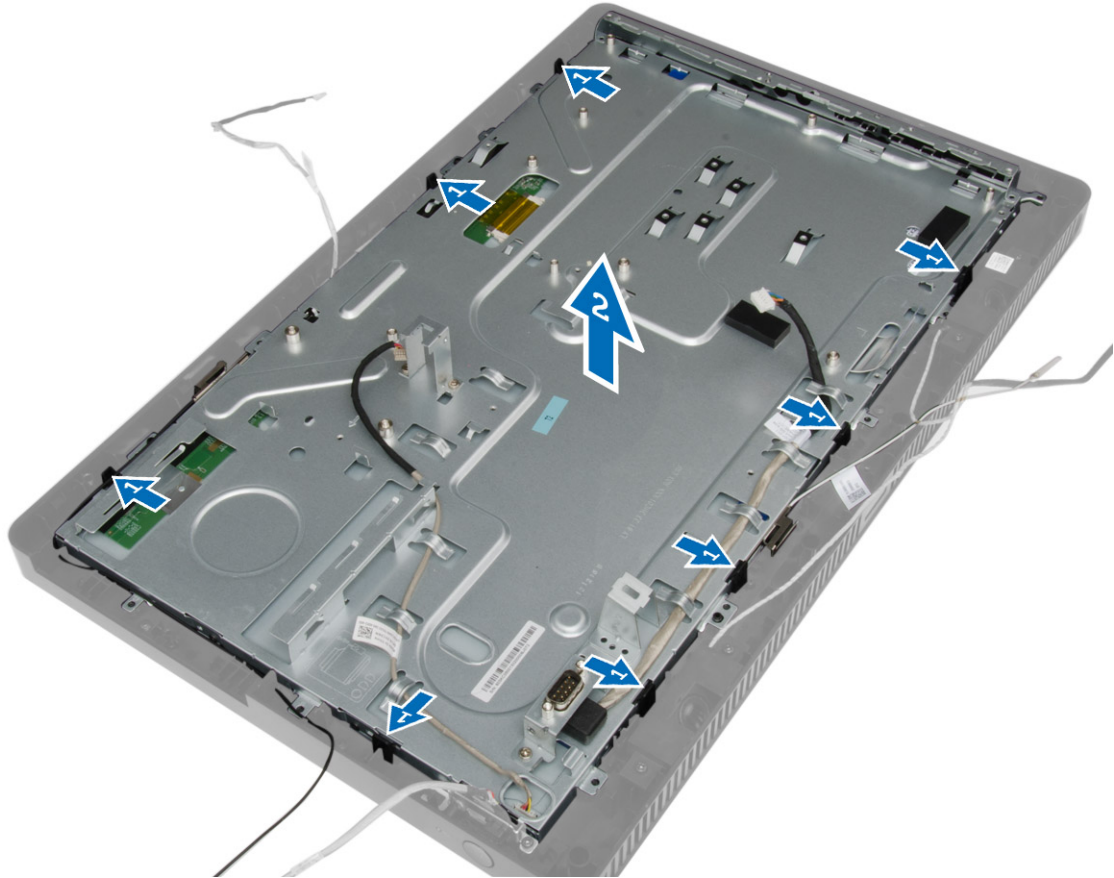

Installing the Display Bracket

1. Place the display bracket on the computer.
2. Tighten the screws to secure the display bracket to the computer.
3. Guide the camera cable and the display cable through their tabs.
4. Install:
 - a. system board
 - b. power switch
 - c. intrusion switch
 - d. system fan
 - e. control board
 - f. optical disk drive
 - g. hard drive
 - h. heat sink
 - i. memory
 - j. WLAN card
 - k. system board cover
 - l. back cover

- m. VESA stand
 - n. stand cover
5. Follow the procedures in *After Working Inside Your Computer*.

Removing the Camera

1. Follow the procedures in *Before Working Inside Your Computer*.
2. Remove:
 - a. stand cover
 - b. VESA stand
 - c. back cover
 - d. system board cover
 - e. WLAN card
 - f. memory
 - g. heat sink
 - h. hard drive
 - i. optical drive
 - j. control board
 - k. system fan
 - l. intrusion switch
 - m. power switch
 - n. system board
 - o. display bracket
3. Remove the screws that secure the camera to the computer and remove it from the computer.

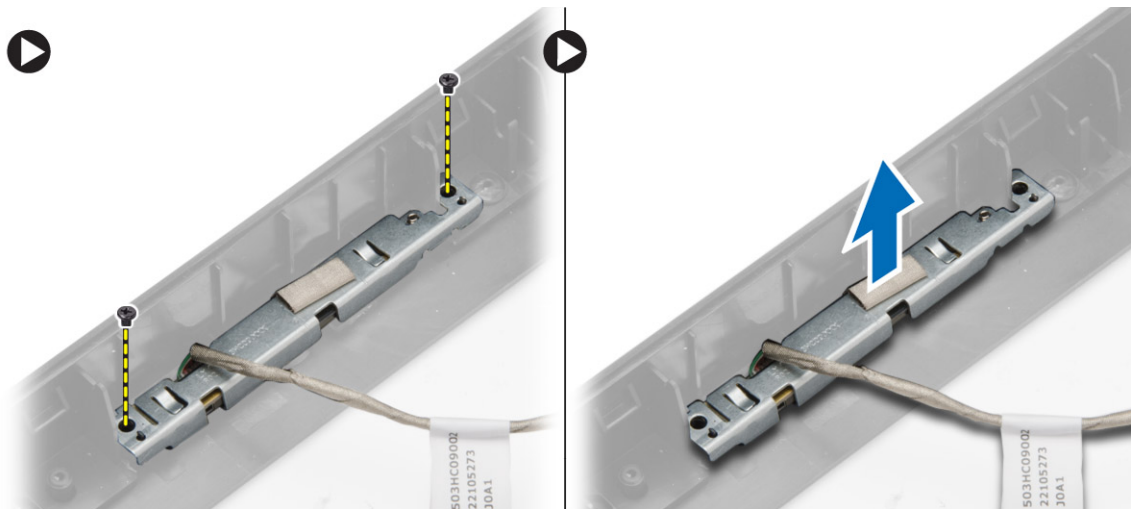

Installing the Camera

1. Place the camera on the computer.
2. Tighten the screws to secure the camera to the computer.
3. Install:
 - a. display bracket
 - b. system board

- c. power switch
 - d. intrusion switch
 - e. system fan
 - f. control board
 - g. optical disk drive
 - h. hard drive
 - i. heat sink
 - j. memory
 - k. WLAN card
 - l. system board cover
 - m. back cover
 - n. VESA stand
 - o. stand cover
4. Follow the procedures in *After Working Inside Your Computer*.

Removing the Serial Port

1. Follow the procedures in *Before Working Inside Your Computer*.
2. Remove:
 - a. stand cover
 - b. VESA stand
 - c. back cover
 - d. system board cover
3. Disconnect and release the serial-port cable from its tabs on the computer.

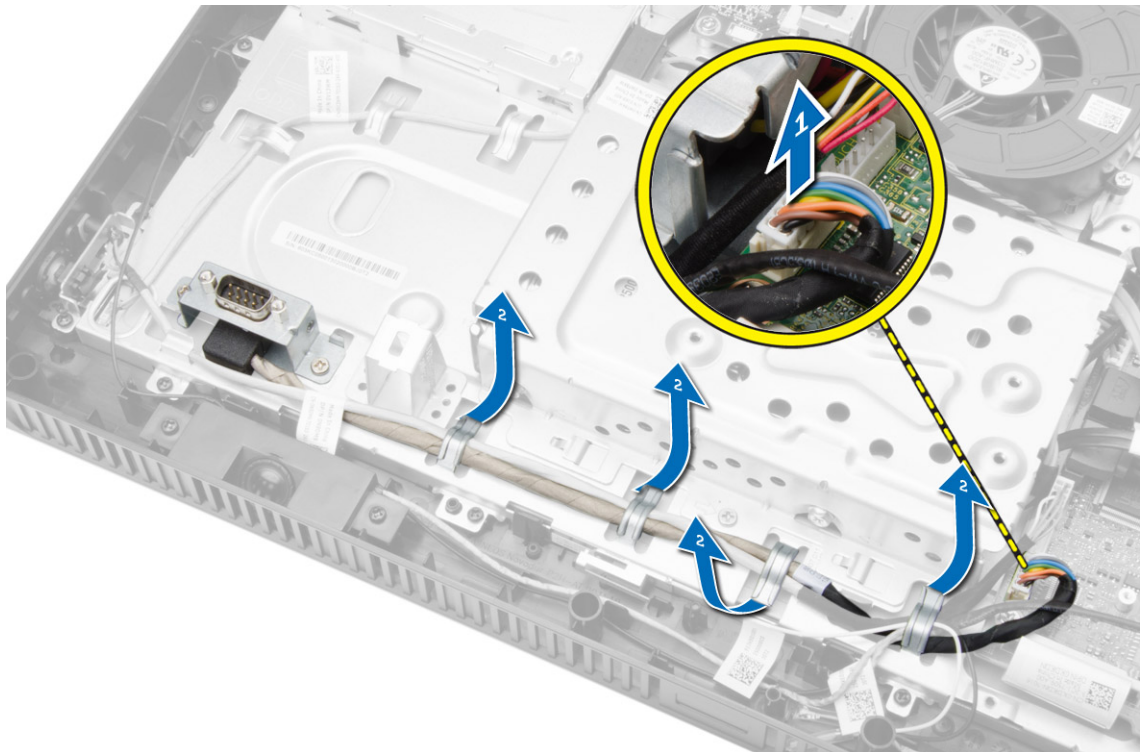

4. Remove the screws that secure the serial port to the computer and remove it from the computer.

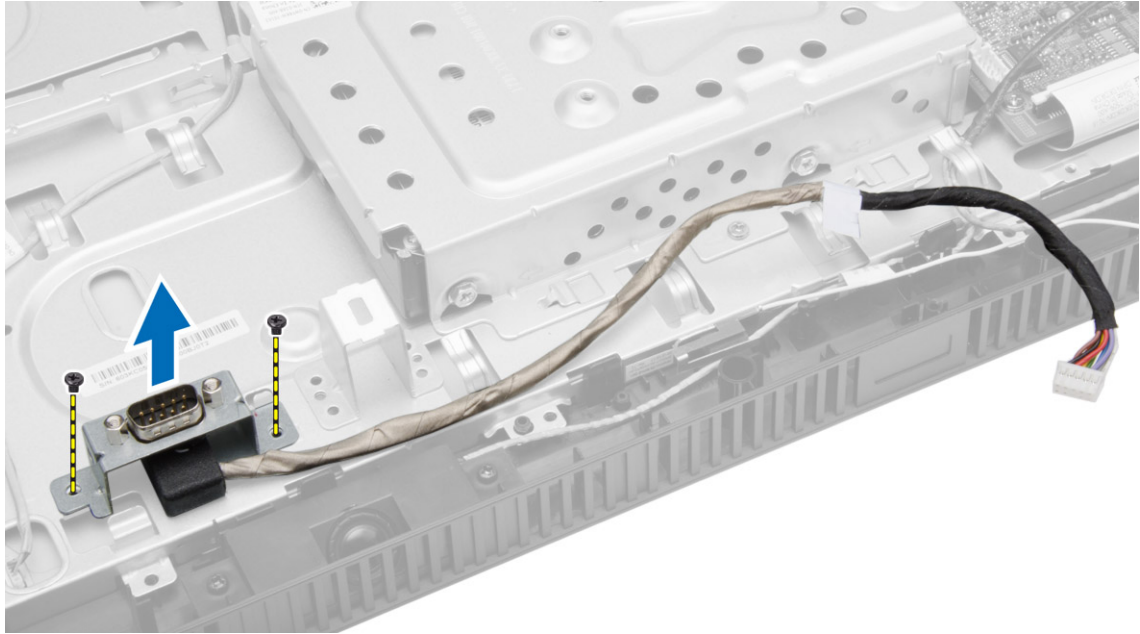

Installing the Serial Port

1. Tighten the screws to secure the serial port to the computer.
2. Guide the serial-port cable through its tabs on the computer and connect it to the system board.
3. Install:
 - a. system board cover
 - b. back cover
 - c. VESA stand
 - d. stand cover
4. Follow the procedures in *After Working Inside Your Computer*.

System Setup

System Setup enables you to manage your computer hardware and specify BIOS-level options. From the System Setup, you can:

- Change the NVRAM settings after you add or remove hardware
- View the system hardware configuration
- Enable or disable integrated devices
- Set performance and power management thresholds
- Manage your computer security

Boot Sequence

Boot Sequence allows you to bypass the System Setup-defined boot device order and boot directly to a specific device (for example: optical drive or hard drive). During the Power-on Self Test (POST), when the Dell logo appears, you can:

- Access System Setup by pressing <F2> key
- Bring up the one-time boot menu by pressing <F12> key

The one-time boot menu displays the devices that you can boot from including the diagnostic option. The boot-menu options are:

- Removable Drive (if available)
- STXXXX Drive

 **NOTE:** XXX denotes the SATA drive number.

- Optical Drive
- Diagnostics

 **NOTE:** Choosing Diagnostics, will display the **ePSA diagnostics** screen.

The boot sequence screen also displays the option to access the System Setup screen.

Navigation Keys

The following table displays the system setup navigation keys.



 **NOTE:** For most of the system setup options, changes that you make are recorded but do not take effect until you re-start the system.

Table 1. Navigation Keys

Keys	Navigation
Up arrow	Moves to the previous field.
Down arrow	Moves to the next field.
<Enter>	Allows you to select a value in the selected field (if applicable) or follow the link in the field.
Spacebar	Expands or collapses a drop-down list, if applicable.
<Tab>	Moves to the next focus area.
	 NOTE: For the standard graphics browser only.
<Esc>	Moves to the previous page till you view the main screen. Pressing <Esc> in the main screen displays a message that prompts you to save any unsaved changes and restarts the system.
<F1>	Displays the System Setup help file.

System Setup Options



 **NOTE:** Depending on the computer and its installed devices, the items listed in this section may or may not appear

Table 2. General

Option	Description
System Information	<p>Displays the following information:</p> <ul style="list-style-type: none"> • System Information - Displays BIOS Version, Service Tag, Asset Tag, Ownership Tag, Ownership Date, Manufacture Date, and Express Service Code. • Memory Information - Displays Memory Installed, Memory Available, Memory Speed, Memory Channels Mode, Memory Technology, DIMM 1 Size, DIMM 2 Size. • Processor Information - Displays Processor Type, Core Count, Processor ID, Current Clock Speed, Minimum Clock Speed, Maximum Clock Speed, Processor L2 Cache, Processor L3 Cache, HT Capable, and 64-Bit Technology. • PCI Information - Displays SLOT1 • Device Information - Displays SATA-0, SATA-1, LOM MAC Address, and Video Controller Audio Controller.
Boot Sequence	<p>Allows you to specify the order in which the computer attempts to find an operating system. To change the boot order, select the device that you want to change in the list, which is available on the right-hand side. After you select the device, click up/down arrows or use your keyboard PgUp / PgDn keys to change the boot options order. You can also select or de-select from the list using the check-boxes available on the left hand side. You should enable the Legacy Option ROMs to setup the Legacy boot mode. This Legacy boot mode is not allowed when you enable the Secure Boot. The options are:</p> <ul style="list-style-type: none"> • Boot Sequence - By default, the Windows Boot Manager check box is selected. • Boot List Option - The list options are Legacy and UEFI. By default, the option UEFI is selected and if Secure Boot is disabled then the option Legacy is selected. • Add Boot Option - Enables you to add a boot option. • Delete Boot Option - Enables you to delete an existing boot option. • View - Enables you to view the current boot option in the computer. • Load Defaults - Restores the default settings of the computer.

Option	Description
	<ul style="list-style-type: none"> • Apply - Enables you to apply the settings. • Exit - Exits and starts the computer.
Advanced Boot Options	<p>The Enable Legacy Option ROMs option will allow the legacy option ROMs to load, when in UEFI boot mode. Without this option, only UEFI option ROMs will load. This option is required for Legacy boot mode. This Legacy boot mode is not allowed when you enable the Secure Boot. By default, the Enable Legacy Option ROMs check-box is not selected. The other options are:</p> <ul style="list-style-type: none"> • Load Defaults - Restores the default settings of the computer. • Apply - Enables you to apply the settings. • Exit - Exits and starts the computer.
Date/Time	Allows you to set the date and time. The changes to the system date and time takes effect immediately.

Table 3. System Configuration

Option	Description
Integrated NIC	<p>Allows you to enable or disable the integrated network card. You can set the integrated NIC to:</p> <ul style="list-style-type: none"> • Disabled • Enabled • Enabled w/PXE (This option is selected by default) • Enabled w/ImageServer • Enable UEFI Network Stack <p> NOTE: Depending on the computer and its installed devices, the items listed in this section may or may not appear.</p>
Serial Port	<p>Allows you to define the serial port settings. You can set the serial port to:</p> <ul style="list-style-type: none"> • Disabled • COM1 (This option is selected by default) • COM2 • COM3 • COM4 <p> NOTE: The operating system may allocate resources even though the setting is disabled.</p>
SATA Operation	<p>Allows you to configure the operating mode of the integrated SATA hard drive controller.</p> <ul style="list-style-type: none"> • Disabled - The SATA controllers are hidden. • ATA - SATA is configured for ATA mode. • AHCI - SATA is configured for AHCI mode. This option is enabled by default.
Drives	<p>Allows you to enable or disable the various on-board drives:</p> <ul style="list-style-type: none"> • SATA-0



Option	Description
	<ul style="list-style-type: none"> SATA-1
SMART Reporting	<p>This field controls if the hard drive errors for the integrated drives are reported during system startup. This technology is part of the SMART (Self Monitoring Analysis and Reporting Technology) specification.</p> <ul style="list-style-type: none"> Enable SMART Reporting - This option is disabled by default.
USB Configuration	<p>This field configures the integrated USB controller. If <i>Boot Support</i> is enabled, the system is allowed to boot any type of USB mass storage devices (HDD, memory key, floppy).</p> <p>If USB port is enabled, device attached to this port is enabled and available for operation system.</p> <p>If USB port is disabled, the operation system cannot see any device attached to this port.</p> <p>The options for USB configuration:</p> <ul style="list-style-type: none"> Enable Boot Support Enable Rear Quad USB Ports Enable Front USB Ports <p> NOTE: USB keyboard and mouse always work in the BIOS setup irrespective of these settings.</p>
OSD Button Management	<p>Allows you to disable OSD buttons, the OSD buttons are enabled by default.</p> <ul style="list-style-type: none"> Disable OSD buttons
Audio	<p>Allows you to enable or disable the integrated audio controllers. By default, the Enable Audio option is selected.</p>
Miscellaneous Devices	<p>Allows you to enable or disable various on-board devices.</p> <ul style="list-style-type: none"> Enable Microphone - This option is selected by default. Enable Camera - This option is selected by default. Enable Media Card - This option is selected by default. Disable Media Card



Table 4. Security

Option	Description
Admin Password	<p>This field lets you set, change, or delete the administrator (admin) password (sometimes called the setup password). The admin password enables several security features.</p> <p>The drive does not have a password set by default.</p> <ul style="list-style-type: none"> Enter the old password Enter the new password Confirm the new password <p>The successful changes in the password will take effect immediately.</p>

Option	Description
System Password	<p> NOTE: If you delete the admin password, the system password also gets deleted. You can also use the admin password to delete the HDD password. You cannot set an admin password if a system password or an HDD password is already set. You must set the admin password first, if you want to use the admin password with a system password and/or HDD password.</p> <p>Allows you to set, change, or delete the computer password (previously called the primary password). The drive does not have a password set by default.</p> <ul style="list-style-type: none"> • Enter the old password • Enter the new password • Confirm the new password <p>The successful changes in the password will take effect immediately.</p>
Internal HDD-0 Password	<p>Allows you to set, change, or delete the password on the computer's internal hard disk drive (HDD). Successful changes to this password take effect immediately. The drive does not have a password set by default.</p> <ul style="list-style-type: none"> • Enter the old password • Enter the new password • Confirm the new password
Strong Password	Enable strong password - This option is disabled by default.
Password Configuration	<p>This field controls the minimum and maximum number of characters allowed for the admin and system passwords.</p> <ul style="list-style-type: none"> • Admin Password Min • Admin Password Max • System Password Min • System Password Max
Password Bypass	<p>Allows you to bypass the <i>System Password</i> and the internal HDD password prompts during a system restart.</p> <ul style="list-style-type: none"> • Disabled - Always prompt for the system and internal HDD password when they are set. This option is disabled by default. • Reboot Bypass - Bypass the password prompts on restarts (warm boots). <p> NOTE: The system will always prompt for the system and internal HDD passwords when powered on from the off state (a cold boot). Also, the system will always prompt for passwords on any module bay HDDs that may be present.</p>
Password Change	<p>Allows you to determine whether changes to the system and hard disk passwords are permitted when an administrator password is set.</p> <ul style="list-style-type: none"> • Allow Non-Admin Password Changes - This option is enabled by default.
Computrace	<p>This field lets you activate or disable the BIOS module interface of the optional <i>Computrace Service</i> from <i>Absolute Software</i>.</p> <ul style="list-style-type: none"> • Deactivate - This option is enabled by default. • Disable

Option	Description
	<ul style="list-style-type: none"> • Activate
Chassis Intrusion	<p>This field controls the chassis intrusion feature. The options are:</p> <ul style="list-style-type: none"> • Disable • Enable - This option is enabled by default • On-Silent
CPU XD Support	<p>Allows you to enable or disable the execute disable mode of the processor.</p> <ul style="list-style-type: none"> • Enable CPU XD Support - This option is enabled by default.
Admin Setup Lockout	<p>Allows you to enable or disable the option to enter setup when an admin password is set.</p> <ul style="list-style-type: none"> • Enable Admin Setup Lockout - This option is not set by default.
HDD Protection Support	<p>Allows you to enable or disable HDD protection support. This option is only available for some regions. This option is not set by default.</p>

Table 5. Secure Boot

Option	Description
Secure Boot Enable	<p>This option enables or disables the Secure Boot feature. To enable the Secure Boot, the computer has to be in UEFI boot mode and the Enable Legacy Option ROMs option needs to be turned-off.</p> <ul style="list-style-type: none"> • Disabled • Enabled <p> NOTE: The default setting for this will depend on the operating system of your computer.</p> <p> NOTE: If the Secure Boot is already disabled by fault, the jumper reset will leave Secure Boot disabled and reset the "Boot Mode" and "Enable Legacy Option ROM" to their default value.</p>
Expert Key Management	<p>Allows you to manipulate the security key databases only if the system is in Custom Mode. The Enable Custom Mode option is disabled by default. The options are:</p> <ul style="list-style-type: none"> • PK • KEK • db • dbx <p>If you enable the Custom Mode, the relevant options for PK, KEK, db, and dbx appear. The options are:</p> <ul style="list-style-type: none"> • Save to File- Saves the key to a user-selected file • Replace from File- Replaces the current key with a key from a user-selected file • Append from File- Adds a key to the current database from a user-selected file • Delete- Deletes the selected key • Reset All Keys- Resets to default setting • Delete All Keys- Deletes all the keys



Option	Description
	 NOTE: If you disable the Custom Mode, all the changes made will be erased and the keys will restore to default settings.

Table 6. Performance

Option	Description
Multi Core Support	<p>Specifies whether the process will have one or all cores enabled. The performance of some applications will improve with the additional cores.</p> <ul style="list-style-type: none"> • All - Enabled by default • 1 • 2
Intel® SpeedStep™	Allows you to enable or disable the Intel SpeedStep mode of the processor. This option is enabled by default.
C States Control	Allows you to enable or disable the additional processor sleep states. This option is enabled by default.
Hyper-Thread Control	Allows you to enable or disable the Hyper-Threading technology. This option is enabled by default.
Rapid Start Technology	Improves the power management automatically by putting system into a low power state during Sleep, after a user-specified amount of time. Some increase in resume time from Sleep state may be experience, but the average resume times should be faster than the resume from Hibernate. The timer can be set starting from the value "0". By default, this option is disabled.

Table 7. Power Management

Option	Description
AC Recovery	<p>Specifies how the computer will respond when AC power is applied after an AC power loss. You can set the AC Recovery to:</p> <ul style="list-style-type: none"> • Power Off (default) • Power On • Last Power State
Auto On Time	<p>This option sets the time of the day when you would like the system to turn on automatically. Time is kept in standard 12-hour format (hour:minutes:seconds). The startup time can be changed by typing the values in the time and A.M./P.M. fields.</p> <ul style="list-style-type: none"> • Disabled (default) - The system will not automatically power up. • Every Day - The system will power up every day at the time you specified above . • Weekdays - The system will power up Monday through Friday at the time you specified above. • Select Days - The system will power up on days selected above at the time you specified above. <p>  NOTE: This feature does not work if you turn off your computer using the switch on a power strip or surge protector or if Auto Power is set to disabled. </p>
Deep Sleep Control	<p>Allows you to define the controls when Deep Sleep is enabled.</p> <ul style="list-style-type: none"> • Disabled

Option	Description
	<ul style="list-style-type: none"> Enabled in S5 only Enabled in S4 and S5 <p>Enabled in S4 and S5 is enabled by default.</p>
Fan Control Override	<p>Controls the speed of the system fan. This option is disabled by default.</p> <p> NOTE: When enabled, the fan runs at full speed.</p>
USB Wake Support	<p>This option allows you to enable USB devices to wake the computer from standby.</p> <ul style="list-style-type: none"> Enable USB Wake Support - This option is enabled by default.
Wake on LAN / WLAN	<p>This option allows the computer to power up from the off state when triggered by a special LAN signal. Wake-up from the Standby state is unaffected by this setting and must be enabled in the operating system. This feature only works when the computer is connected to AC power supply. The options differ based on the form factor.</p> <ul style="list-style-type: none"> Disabled - Does not allow the system to power on by special LAN signals when it receives a wake-up signal from the LAN or wireless LAN. LAN Only - Allows the system to be powered on by special LAN signals. WLAN Only - Allows the system to be powered on by special WLAN signals. (For Ultra Small Form Factor only) LAN or WLAN - Allows the system to be powered on by special LAN or WLAN signals. (For Ultra Small Form Factor only) LAN with PXE Boot - Allows the system to be powered on by special LAN signals. <p>This option is Disabled by default.</p>
Block Sleep	<p>This option lets you block entering to sleep (S3 state) in operating system environment.</p> <ul style="list-style-type: none"> Block Sleep (S3 state) - This option is disabled by default.
Intel Smart Connect Technology	<p>This option is disabled by default. If this option is enabled, the feature will periodically sense the nearby wireless connection while the system is asleep. The Smart Connect will synchronize the email or social media applications that are open, when the computer enters the sleep state.</p>

Table 8. POST Behavior

Option	Description
Adapter Warnings	<p>This option allows you to choose whether the system should display warning messages when a certain power adapter is used. This option is enabled by default.</p>
Numlock LED	<p>Specifies if the NumLock function can be enabled when the system boots. This option is enabled by default.</p>
Keyboard Errors	<p>Specifies whether keyboard related errors are reported when it boots. This option is enabled by default.</p>
POST Hotkeys	<p>Specifies whether the sign-on screen displays a message, that displays the keystroke sequence required to enter the BIOS Boot Option Menu.</p> <ul style="list-style-type: none"> Enable F12 Boot Option menu - This option is enabled by default.
Fastboot	<p>Speeds up the boot process by bypassing some compatibility steps. The options are:</p>

Option	Description
	<ul style="list-style-type: none"> Minimal Thorough - This option is selected by default. Auto

Table 9. Virtualization Support

Option	Description
Virtualization	<p>This option specifies whether a Virtual Machine Monitor (VMM) can utilize the additional hardware capabilities provided by Intel Virtualization technology.</p> <ul style="list-style-type: none"> Enable Intel Virtualization Technology - This option is enabled by default.



Table 10. Wireless

Option	Description
Wireless Device Enable	<p>Allows enabling/disabling the internal wireless devices. The options are:</p> <ul style="list-style-type: none"> WLAN Bluetooth <p>This options is enabled by default.</p>

Table 11. Maintenance

Option	Description
Service Tag	Displays the service tag of your computer.
Asset Tag	Allows you to create a system asset tag if an asset tag is not already set. This option is not set by default.
SERR Messages	Controls the SERR message mechanism. This option is not set by default. Some graphics cards require that the SERR message mechanism be disabled.

Table 12. Cloud Desktop

Option	Description
Server Lookup Method	<p>This option specifies how the Cloud Desktop software will lookup the server address. The options are:</p> <ul style="list-style-type: none"> Static IP - Uses the static IP address DNS - Obtains several IP addresses using the Domain Name System (DNS) protocol. This option is selected by default <p> NOTE: This option is relevant only when the Integrated NIC control in the System Configuration group is set to Enable with Cloud Desktop.</p>
Server IP Address	<p>This option specifies the primary static IP address of the Cloud Desktop Server with which the client software communicates. The default Server IP Address is 255.255.255.255</p> <p> NOTE: This option is relevant only when the Integrated NIC control in the System Configuration group is set to Enable with Cloud Desktop.</p>





Option	Description
Server Port	This option specifies the primary IP port of the Cloud Desktop with which the client software communicates. The default Server Port value is 06910 .  NOTE: This option is relevant only when the Integrated NIC control in the System Configuration group is set to Enable with Cloud Desktop.
Client Address Method	This option specifies how the client obtains its IP address. The options are: <ul style="list-style-type: none"> • Static IP - Uses the static IP address • DHCP - Obtains IP addresses using DHCP. This option is selected by default  NOTE: This option is relevant only when the Integrated NIC control in the System Configuration group is set to Enable with Cloud Desktop.
Client IP Address	This option specifies the static IP address of the client. The default IP Address is 255.255.255.255  NOTE: This option is relevant only when the Integrated NIC control in the System Configuration group is set to Enable with Cloud Desktop.
Client SubnetMask	This option specifies the subnet mask IP address of the client. The default IP Address is 255.255.255.255  NOTE: This option is relevant only when the Integrated NIC control in the System Configuration group is set to Enable with Cloud Desktop.
Client Gateway	This option specifies the gateway IP address of the client. The default IP Address is 255.255.255.255  NOTE: This option is relevant only when the Integrated NIC control in the System Configuration group is set to Enable with Cloud Desktop.
Advanced	This option allows you to enable the Verbose Mode. <ul style="list-style-type: none"> • Verbose Mode

Table 13. Image Server

License Status	Displays the EasyConnect Embedded license status.
----------------	---

Table 14. System Logs

Option	Description
BIOS events	Displays the system event log and allows you to clear the log. <ul style="list-style-type: none"> • Clear Log

Updating the BIOS

It is recommended to update your BIOS (system setup), on replacing the system board or if an update is available. For laptops, ensure that your computer battery is fully charged and connected to a power outlet

1. Re-start the computer.
2. Go to dell.com/support.
3. Enter the **Service Tag** or **Express Service Code** and click **Submit**.

 **NOTE:** To locate the Service Tag, click **Where is my Service Tag?**

 **NOTE:** If you cannot find your Service Tag, click **Detect My Product**. Proceed with the instructions on screen.

4. If you are unable to locate or find the Service Tag, click the Product Category of your computer.
5. Choose the **Product Type** from the list.
6. Select your computer model and the **Product Support** page of your computer appears.
7. Click **Get drivers** and click **View All Drivers**.
The Drivers and Downloads page opens.
8. On the Drivers and Downloads screen, under the **Operating System** drop-down list, select **BIOS**.
9. Identify the latest BIOS file and click **Download File**.
You can also analyze which drivers need an update. To do this for your product, click **Analyze System for Updates** and follow the instructions on the screen.
10. Select your preferred download method in the **Please select your download method below window**; click **Download File**.
The **File Download** window appears.
11. Click **Save** to save the file on your computer.
12. Click **Run** to install the updated BIOS settings on your computer.
Follow the instructions on the screen.

System and Setup Password

You can create a system password and a setup password to secure your computer.

Password Type	Description
System password	Password that you must enter to log on to your system.
Setup password	Password that you must enter to access and make changes to the BIOS settings of your computer.

 **CAUTION:** The password features provide a basic level of security for the data on your computer.

 **CAUTION:** Anyone can access the data stored on your computer if it is not locked and left unattended.

 **NOTE:** Your computer is shipped with the system and setup password feature disabled.

Assigning a System Password and Setup Password

You can assign a new **System Password** and/or **Setup Password** or change an existing **System Password** and/or **Setup Password** only when **Password Status** is **Unlocked**. If the Password Status is **Locked**, you cannot change the System Password.

 **NOTE:** If the password jumper is disabled, the existing System Password and Setup Password is deleted and you need not provide the system password to log on to the computer.

To enter a system setup, press <F2> immediately after a power-on or re-boot.

1. In the **System BIOS** or **System Setup** screen, select **System Security** and press <Enter>.
The **System Security** screen appears.
2. In the **System Security** screen, verify that **Password Status** is **Unlocked**.
3. Select **System Password**, enter your system password, and press <Enter> or <Tab>.
Use the following guidelines to assign the system password:

- A password can have up to 32 characters.
- The password can contain the numbers 0 through 9.
- Only lower case letters are valid, upper case letters are not allowed.
- Only the following special characters are allowed: space, ("), (+), (.), (-), (.), (/), (:), ([), (\), (]), (^).

Re-enter the system password when prompted.

4. Type the system password that you entered earlier and click **OK**.
5. Select **Setup Password**, type your system password and press <Enter> or <Tab>. A message prompts you to re-type the setup password.
6. Type the setup password that you entered earlier and click **OK**.
7. Press <Esc> and a message prompts you to save the changes.
8. Press <Y> to save the changes.

The computer reboots.

Deleting or Changing an Existing System and/or Setup Password

Ensure that the **Password Status** is Unlocked (in the System Setup) before attempting to delete or change the existing System and/or Setup password. You cannot delete or change an existing System or Setup password, if the **Password Status** is Locked.

To enter the System Setup, press <F2> immediately after a power-on or reboot.

1. In the **System BIOS** or **System Setup** screen, select **System Security** and press <Enter>. The **System Security** screen is displayed.
2. In the **System Security** screen, verify that **Password Status** is **Unlocked**.
3. Select **System Password**, alter or delete the existing system password and press <Enter> or <Tab>.
4. Select **Setup Password**, alter or delete the existing setup password and press <Enter> or <Tab>.



NOTE: If you change the System and/or Setup password, re-enter the new password when prompted. If you delete the System and/or Setup password, confirm the deletion when prompted.

5. Press <Esc> and a message prompts you to save the changes.
6. Press <Y> to save the changes and exit from the System Setup.

The computer reboots.

Diagnostics

If you experience a problem with your computer, run the ePSA diagnostics before contacting Dell for technical assistance. The purpose of running diagnostics is to test your computer's hardware without requiring additional equipment or risking data loss. If you are unable to fix the problem yourself, service and support personnel can use the diagnostics results to help you solve the problem.

 **NOTE:** Before proceeding download and install the latest BIOS version from support.dell.com

Enhanced Pre-Boot System Assessment (ePSA) Diagnostics

The ePSA diagnostics (also known as system diagnostics) performs a complete check of your hardware. The ePSA is embedded with the BIOS and is launched by the BIOS internally. The embedded system diagnostics provides a set of options for particular devices or device groups allowing you to:

- Run tests automatically or in an interactive mode
- Repeat tests
- Display or save test results
- Run thorough tests to introduce additional test options to provide extra information about the failed device(s)
- View status messages that inform you if tests are completed successfully
- View error messages that inform you of problems encountered during testing

 **CAUTION:** Use the system diagnostics to test only your computer. Using this program with other computers may cause invalid results or error messages.



 **NOTE:** Some tests for specific devices require user interaction. Always ensure that you are present at the computer terminal when the diagnostic tests are performed.

1. Power-on the computer.
2. As the computer boots, press the <F12> key as the Dell logo appears.
3. On the boot menu screen, select the **Diagnostics** option.
The **Enhanced Pre-boot System Assessment** window is displayed, listing all devices detected in the computer. The diagnostics starts running the tests on all the detected devices.
4. If you wish to run a diagnostic test on a specific device, press <Esc> and click **Yes** to stop the diagnostic test.
5. Select the device from the left pane and click **Run Tests**.
6. If there are any issues, error codes are displayed.
Note the error code and contact Dell.

Troubleshooting Your Computer

You can troubleshoot your computer using indicators like Diagnostic Lights, Beep Codes, and Error Messages during the operation of the computer.

Important Information

-  **NOTE:** Avoid using the touchscreen in dusty, hot, or humid environments.
-  **NOTE:** Sudden change in temperature may cause condensation on the inner surface of the glass screen, which will disappear after a short time and does not affect normal usage.

Diagnostic Power LED Codes

The power LED states are shown in the following table.

-  **NOTE:** The power LED can only serve as an indicator of the progress through the POST process. These LEDs do not indicate the problem that caused the POST routine to stop.

Power LED	Description
OFF	Power is off. LED is blank.
Blinking Amber	Initial state of LED at power up. Refer the following table for Blinking Amber Power LED diagnostics suggestion and possible failures.
Solid Amber	Second state of the LED at power up. Indicates the POWER_GOOD signal is active.
Blinking White	System is in a low power state. Does not indicate a fault condition.
Solid White	The computer is in power-on state.

The power LED light blinking amber pattern will help you determine a few failures as shown below. The Amber LED blinking pattern is as follows: the pattern is 2 or 3 blinks followed by a short pause then X number of blinks up to 7. The repeated pattern has a long pause inserted in the middle. For example 2,3 = 2 amber blinks, short pause, 3 amber blinks followed by long pause then repeats.

Blinking Amber Power LED	Problem Description
2,1	The motherboard may be faulty.
2,2	The motherboard, power supply or power supply cabling may be faulty.
2,3	The motherboard, memory or processor may be faulty.
2,4	The coin-cell battery may be faulty.
2,5	The system may be in recovery mode. Download and install the latest BIOS from support.dell.com/support .

Blinking Amber Power LED	Problem Description
2,6	The processor may be faulty.
2,7	The memory may be faulty. Reseat the memory or install a different memory module.
3,1	The video device or subsystem may be faulty.
3,2	The video subsystem may be faulty.
3,3	No memory module was detected.
3,4	The storage device may be faulty.
3,5	The memory may not be compatible.
3,6	The system board may be faulty.
3,7	The memory has been detected but of an invalid configuration.

Beep Codes

The beep pattern 1-3-2 (1 beep, then 3 beeps, then 2 beeps) indicates that the computer has encountered a memory problem. Occasionally, re-seating the memory modules may fix the beep code errors.

Error Messages

Message	Description
Alert! Previous attempts at booting this system have failed at checkpoint [nnnn]. For help in resolving this problem, please note this checkpoint and contact Dell Technical Support.	The computer failed to complete the boot routine three consecutive times for the same error. Contact Dell and report the checkpoint code (nnnn) to the support technician.
System fan failure	Possible fan failure
CPU fan failure	Possible CPU fan failure
Hard-disk drive failure	Possible hard drive failure during POST.
Hard-disk drive read failure	Possible hard drive failure during boot test.
Keyboard failure	A cable or connector may be loose, or the keyboard or keyboard/mouse controller may be faulty.
RTC is reset, BIOS Setup default has been loaded. Strike	RTC Jumper may be wrongly set.

Message	Description
<p>the F1 key to continue, F2 to run the setup utility.</p>	
<p>No boot device available</p>	<p>No bootable partition on the hard drive, a cable or connector is loose, or no bootable device exists.</p> <ul style="list-style-type: none"> • If the hard drive is your boot device, ensure that the cables are connected and that the drive is installed properly and partitioned as a boot device. • Enter system setup and ensure that the boot sequence information is correct.
<p>No timer tick interrupt</p>	<p>A chip on the system board might be malfunctioning.</p>
<p>USB over current error</p>	<p>Disconnect the USB device. The USB device needs more power for it to function properly. Use an external power source to connect the USB device, or if the device has two USB cables, connect both of them.</p>
<p>CAUTION - Hard Drive SELF MONITORING SYSTEM has reported that a parameter has exceeded its normal operating range. Dell recommends that you back up your data regularly. A parameter out of range may or may not indicate a potential hard drive problem</p>	<p>S.M.A.R.T error or possible hard disk drive failure. Contact Dell and report the issue to a support technician.</p>

Technical Specifications



NOTE: Offerings may vary by region. For more information regarding the configuration of your computer, click Start (Start icon) → **Help and Support**, and then select the option to view information about your computer.

Table 15. System Information

Feature	Specification
Processor type	<ul style="list-style-type: none"> Intel Celeron Dual Core Intel Core i3 / i5 series (3rd generation) Intel Pentium dual core
Total cache	Up to 8 MB cache depending on processor type
Chipset	Intel B75 Express chipset

Table 16. Memory

Feature	Specification
Type	up to 1600 MHz, unbuffered non-ECC, dual-channel DDR3 configuration
Connectors	two internally-accessible DDR3 SODIMM sockets
Capacity	2 GB and 4 GB
Minimum Memory	2 GB
Maximum Memory	8 GB

Table 17. Video

Feature	Specification
Video Controller (Integrated)	Integrated Intel® HD Graphics 2500
Video Memory	shared memory
External Display Support	Wi-Fi display



NOTE: Wi-Fi display requires a wireless card which can be purchased separately.

Table 18. Audio

Feature	Specification
Controller	Intel High Definition Audio with Waves MazzAudio 3
Speaker	single 4-ohms speakers in both the left and right speaker assembly (3 W average per channel)
Internal microphone support	single digital microphone
Volume controls	Volume up/down buttons, program menus, and keyboard media-control keys

Table 19. Communications

Feature	Specification
Network adapter	Intel 10/100/1000 Mbps Ethernet LAN on system board
Wireless	half mini-card (Wi-Fi b/g/n supporting Wi-Fi display)

Table 20. Cards

Feature	Specification
Mini PCI Express	one

Table 21. Displays

Feature	Specification
Type	20 inch HD+ WLED
Maximum resolution	1600 x 900
Refresh rate	60 Hz
Operating angle	178° (horizontal) / 178° (vertical)
Pixel pitch	0.27 mm
Controls	on-screen controls
Dimensions:	
Height	249.08 mm (9.81 inches)
Width	442.80 mm (17.43 inches)
Diagonal	508.00 mm (20.00 inches)

Table 22. Drives

Feature	Specification
Hard drive	one 3.5-inch SATA drive or one 2.5-inch SATA drive with an adapter bracket
Optical drive (optional)	one DVD-ROM, DVD+/- RW or combo Blu-ray writer

Table 23. Ports and Connectors

Feature	Specification
Audio:	<ul style="list-style-type: none"> one audio input/microphone port one headphone port
Network adapter	one RJ45 connector
USB 2.0	four connectors in the back panel
USB 3.0	two connectors on the side panel
Serial	one 9-pin connector; 16550 C compatible
Media card reader	one 8-in-1 slot

Table 24. Power

Feature	Specification
AC Adapter:	
Type	180 W
Frequency	50 Hz — 60 Hz
Voltage	100 VAC — 240 VAC
Rated output voltage	19.50 VDC
Input current	2.34 A Maximum
Output current (continuous)	9.23 A
Dimensions:	
Height	30.00 mm (1.18 inches)
Width	76.20 mm (3.00 inches)
Depth	155.00 mm (6.10 inches)
Weight	0.58 kg (1.28 lbs)
Temperature range:	
Operating	0 °C to 40 °C (30 °F to 104 °F)
Storage	-40 °C to 70 °C (-40 °F to 158 °F)
Coin-cell battery	3 V CR2032 lithium coin cell

Table 25. Camera (optional)

Feature	Specification
Image resolution	1024 x 720 p
Video resolution	720p HD
Diagonal viewing angle	66.2 degrees

Table 26. Stand

Feature	Specification
Tilt	-5 degrees to 30 degrees

Table 27. Physical Dimensions

Feature	Specification	
	non-Touch	Touch
Width	506.80 mm (19.95 inches)	506.80 mm (19.95 inches)
Height:		
Without Stand	323.00 mm (12.72 inches)	323.00 mm (12.72 inches)
With Stand	376.95 mm (14.84 inches)	376.95 mm (14.84 inches)
Depth	63.20 mm (2.49 inches)	65.50 mm (2.58 inches)
Weight (minimum)	6.95 kg - 7.44 kg (15.32 lb - 16.40 lb)	8.14 kg - 8.63 kg (17.94 lb - 19.02 lb)
Stand (Width x Depth)	220.00 mm (8.66 inches) x 220.00 mm (8.66 inches)	



NOTE: The weight of your computer may vary depending on the configuration ordered and the manufacturing variability.

Table 28. Controls and Lights

Feature	Specification
Power button light	White light — Solid white light indicates power-on state; blinking white light indicates sleep state of the computer.
Hard Drive activity light	White light — Blinking white light indicates that the computer is reading data from or writing data to the hard drive.
Camera LED	White light — solid white light indicates that the camera is on.
Back panel:	
Link integrity light on integrated network adapter :	Green — a good 10 Mbps connection exists between the network and the computer. Green— a good 100 Mbps connection exists between the network and the computer. Orange — a good 1000 Mbps connection exists between the network and the computer. Off (no light) — the computer is not detecting a physical connection to the network.
Network activity light on integrated network adapter	Yellow light — A blinking yellow light indicates that network activity is present.

Feature	Specification
Power supply diagnostic light	Green light — The power supply is turned on and is functional. The power cable must be connected to the power connector (at the back of the computer) and the electrical outlet.

Table 29. Environmental

Feature	Specification
Temperature range:	
Operating	5 °C to 35 °C (41 °F to 95 °F)
Storage	–40 °C to 65 °C (–40 °F to 149 °F)
Relative humidity (maximum):	
Operating	10% to 90% (non-condensing)
Storage	10% to 95% (non-condensing)
Maximum vibration:	
Operating	0.66 GRMS
Storage	1.30 GRMS
Maximum shock:	
Operating	110 G
Storage	160 G
Altitude:	
Operating	–15.20 m to 3048 m (–50 ft to 10,000 ft)
Storage	–15.20 m to 10,668 m (–50 ft to 35,000 ft)
Airborne contaminant level	G2 or lower as defined by ANSI/ISA-S71.04-1985

Contacting Dell

 **NOTE:** If you do not have an active Internet connection, you can find contact information on your purchase invoice, packing slip, bill, or Dell product catalog.

Dell provides several online and telephone-based support and service options. Availability varies by country and product, and some services may not be available in your area. To contact Dell for sales, technical support, or customer service issues:

1. Go to dell.com/contactdell.
2. Verify your country or region from the drop-down menu at the top left corner of the page.
3. Select your support category: **Technical Support**, **Customer Support**, **Sales**, or **International Support Services**.
4. Select the appropriate service or support link based on your requirement.

 **NOTE:** If you have purchased a Dell system, you may be asked for the Service Tag.

Free Manuals Download Website

<http://myh66.com>

<http://usermanuals.us>

<http://www.somanuals.com>

<http://www.4manuals.cc>

<http://www.manual-lib.com>

<http://www.404manual.com>

<http://www.luxmanual.com>

<http://aubethermostatmanual.com>

Golf course search by state

<http://golfingnear.com>

Email search by domain

<http://emailbydomain.com>

Auto manuals search

<http://auto.somanuals.com>

TV manuals search

<http://tv.somanuals.com>