



# Dell™ OptiPlex™ XE — Powered Serial Port Configuration

Your Dell OptiPlex XE allows you to configure the power settings of the serial connectors, based on the voltage requirements of the device attached to the serial port.

To configure the power to the serial port, change the jumper settings on the system board or the expansion card.







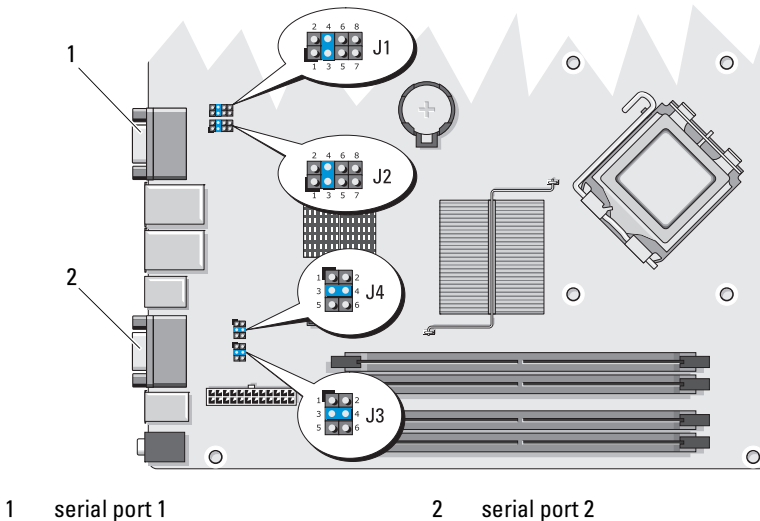

## Setting the Jumpers on the System Board









The illustration below shows the location of the jumpers and the serial port on the system board. For instructions to access the jumpers on the system board, see the *OptiPlex XE Service Manual* available at [support.dell.com/manuals](http://support.dell.com/manuals).

 **NOTE:** To locate the serial port on your computer, see the *Setup and Features Information Tech Sheet* that shipped with your computer.















## System Board Jumper Configuration — Serial Port 1

Serial Port Voltage	Jumper 1 (J1)
5 V 	
DCD 	
12 V 	
9 V 	

Serial Port Voltage	Jumper 2 (J2)
 5 V	
 RI	
 12 V	
 9 V	

## System Board Jumper Configuration — Serial Port 2

Serial Port Voltage	Jumper 3 (J3)
5 V 	
DCD 	
12 V 	
Serial Port Voltage	Jumper 4 (J4)
 5 V	
 RI	
 12 V	

# Setting the Jumpers on the Expansion Card



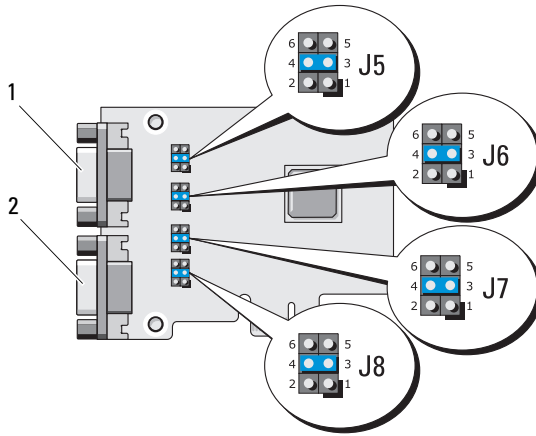









The illustration below shows the location of the jumpers and the serial port on the expansion card.









1 serial port 3







2 serial port 4

## Expansion Card Jumper Configuration — Serial Port 3

Serial Port Voltage	Jumper 5 (J5)
5 V 	
DCD 	
12 V 	
Serial Port Voltage	Jumper 6 (J6)
 5 V	
 RI	
 12 V	

## Expansion Card Jumper Configuration — Serial Port 4

Serial Port Voltage	Jumper 7 (J7)
5 V 	
DCD 	
12 V 	

Serial Port Voltage	Jumper (J8)
 5 V	
 RI	
 12 V	

**Information in this document is subject to change without notice.**  
 © 2010 Dell Inc. All rights reserved.

Reproduction of these materials in any manner whatsoever without the written permission of Dell Inc. is strictly forbidden.

Trademarks used in this text: *Dell*, the *DELL* logo, and *OptiPlex* are trademarks of Dell Inc.

Other trademarks and trade names may be used in this document to refer to either the entities claiming the marks and names or their products. Dell Inc. disclaims any proprietary interest in trademarks and trade names other than its own.

## Free Manuals Download Website

<http://myh66.com>

<http://usermanuals.us>

<http://www.somanuals.com>

<http://www.4manuals.cc>

<http://www.manual-lib.com>

<http://www.404manual.com>

<http://www.luxmanual.com>

<http://aubethermostatmanual.com>

Golf course search by state

<http://golfingnear.com>

Email search by domain

<http://emailbydomain.com>

Auto manuals search

<http://auto.somanuals.com>

TV manuals search

<http://tv.somanuals.com>