

Dell PowerEdge FD332

Owner's Manual

Notes, cautions, and warnings

 **NOTE:** A NOTE indicates important information that helps you make better use of your computer.

 **CAUTION:** A CAUTION indicates either potential damage to hardware or loss of data and tells you how to avoid the problem.

 **WARNING:** A WARNING indicates a potential for property damage, personal injury, or death.

Copyright © 2015 Dell Inc. All rights reserved. This product is protected by U.S. and international copyright and intellectual property laws. Dell™ and the Dell logo are trademarks of Dell Inc. in the United States and/or other jurisdictions. All other marks and names mentioned herein may be trademarks of their respective companies.

Contents

1 About your Dell PowerEdge FD332.....	5
Terms used in this document.....	5
Front panel features and indicators—PowerEdge FD332.....	6
Storage sled status indicator.....	6
Hard drive/SSD indicators.....	7
Storage Controller Module indicators.....	7
Documentation matrix.....	8
Quick Resource Locator.....	9
2 Performing initial system configuration.....	10
Setting up your PowerEdge FD332.....	10
Managing your system remotely.....	10
Downloading drivers and firmware.....	11
3 Storage sled mapping configurations.....	12
Single PERC/HBA Controller and joined mode mapping configurations.....	12
Split mode mapping configurations.....	13
Split single host mapping configuration.....	14
Split dual host mapping configuration.....	14
Drive to storage controller mapping.....	15
4 Installing and removing storage sled components.....	17
Customer and field replaceable units—PowerEdge FD332.....	17
Safety instructions.....	17
Before working inside your system.....	18
After working inside your system.....	18
Recommended tools.....	18
Storage sled.....	18
Removing a storage sled.....	18
Installing a storage sled.....	20
Inside the sled.....	22
Drive drawer.....	22
Opening the drive drawer.....	23
Closing the drive drawer.....	24
Mini Enterprise Service Tag.....	25
Removing the Mini Enterprise Service Tag.....	25
Installing the Mini Enterprise Service Tag.....	26
Hard drive/SSD assembly.....	26
Removing a hard drive/SSD assembly.....	26
Installing a hard drive/SSD assembly.....	28
Removing a hard drive/SSD from the drive rails.....	30
Installing a hard drive/SSD into the drive rails.....	31

Storage controller module.....	32
Removing the storage controller module.....	32
Installing the storage controller module.....	34
Bezel assembly.....	34
Removing the bezel assembly.....	35
Installing the bezel assembly.....	36
5 Troubleshooting your system.....	38
Safety first—for you and your system.....	38
Troubleshooting hard drives/SSDs.....	38
Troubleshooting a storage controller module.....	39
System messages.....	39
Warning messages.....	39
Diagnostic messages.....	40
Alert messages.....	40
6 Using system diagnostics.....	41
Dell Embedded System Diagnostics.....	41
When to use the Embedded System Diagnostics.....	41
Running the Embedded System Diagnostics from Boot Manager.....	41
Running the Embedded System Diagnostics from the Dell Lifecycle Controller.....	42
Running Embedded System Diagnostics from an external media.....	42
System diagnostics controls.....	42
7 Technical specifications—PowerEdge FD332.....	43
8 Getting help.....	45
Contacting Dell.....	45
Locating your system Service Tag.....	45
Quick Resource Locator.....	45

About your Dell PowerEdge FD332

The Dell PowerEdge FD332 is a storage sled supported on the Dell PowerEdge FX2s enclosure. PowerEdge FD332 supports up to sixteen hot swap 2.5 inch hard drives/SSDs, and a storage controller module with single or dual controller modes.

Topics:

- [Terms used in this document](#)
- [Front panel features and indicators—PowerEdge FD332](#)
- [Hard drive/SSD indicators](#)
- [Storage Controller Module indicators](#)
- [Documentation matrix](#)
- [Quick Resource Locator](#)

Terms used in this document

The following table describes the terms used in this document.

Term	Description
Enclosure or chassis	Refers to the PowerEdge FX2s enclosure. NOTE: PowerEdge FD332 is not supported on the PowerEdge FX2 enclosure.
Three-bay chassis	Refers to the PowerEdge FX2s enclosure configuration that supports one full-width and two half-width sleds.
Four-bay chassis	Refers to the PowerEdge FX2s enclosure configuration that supports four half-width sleds.
Six-bay chassis	Refers to the PowerEdge FX2s enclosure configuration that supports four quarter-width sleds and two half-width sleds.
Storage sled or system	Refers to PowerEdge FD332.
Compute sled	Refers to the half-width, quarter-width, or full-width sleds, to which the storage sled(s) may be mapped. NOTE: The storage sled is not supported with the PowerEdge FM120x4 half-width compute sled.
Hot swap	A component is considered hot swap if it can be removed or installed while the sled is powered on.
Drive drawer	Refers to the hard drive/SSD drawer that can support up to 16 hot swap hard drives/SSDs.
PowerEdge RAID Controller (PERC)	Refers to the storage adapter(s) on the storage controller module.
PowerEdge HBA Controller (HBA)	Refers to the storage adapter(s) on the storage controller module.

Front panel features and indicators—PowerEdge FD332

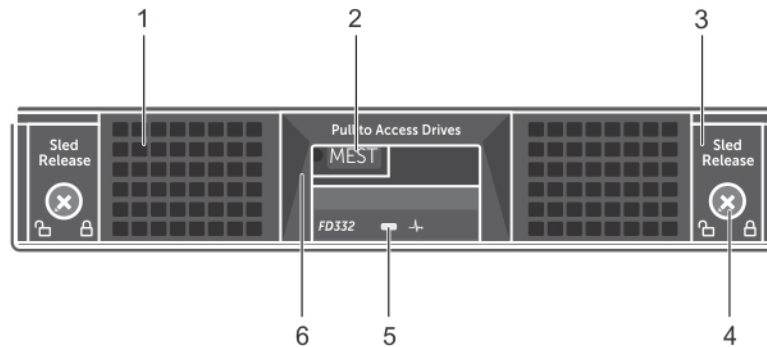

Figure 1. Front panel features and indicators

Item	Indicator, Button, or Connector	Description
1	Drive drawer	Consists of up to sixteen 2.5 inch hard drives/SSDs.
2	Mini Enterprise Service Tag (MEST)	A removable label panel that lists the system Service Tag.
3	Sled release latch (2)	Used to slide the storage sled out of the enclosure.
4	Sled lock (2)	Used to secure or release the storage sled from the enclosure.
5	Storage sled status indicator	Provides information on the overall status of the storage sled.
6	Drive drawer release handle	Used to slide the drive drawer out of the storage sled.

Storage sled status indicator

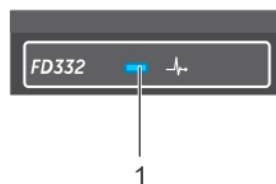

Figure 2. Storage sled status indicator

- 1 storage sled status indicator

The storage sled status indicator located on the sled front panel provides the following information on the overall status of the sled.

Indicator pattern	Description
Solid blue	The storage sled is powered on, and is operating normally.
Blinking blue	The compute sled to which the storage sled is mapped, is identified.
Blinking amber	The storage sled or any component inside the storage sled is in fault condition.

Hard drive/SSD indicators

The hard drive/SSD indicators are located on top of the drive drawer. There is a single status/activity indicator for each drive slot.

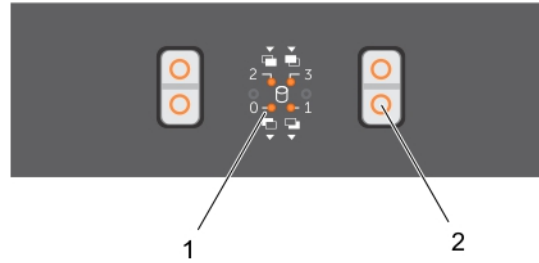

Figure 3. Hard drive/SSD indicators

- 1 hard drive/SSD indicator
- 2 hard drive/SSD release tab

Drive-Status Indicator Pattern	Description
Off	Drive slot empty
Steady green	Drive online, but no activity
Blinks green and turns off	Drive online with drive activity
Blinks green (On 250 ms Off 250 ms)	Drive being identified or preparing for removal
Blinks green (On 400 ms Off 100 ms)	Drive rebuilding
Blinks amber (On 150 ms Off 150 ms)	Drive failed
Blinks green (500 ms), amber (500 ms), and turns off one second	Drive predicted failure
Blinks green three seconds, turns off three seconds, blinks amber three seconds, and turns off three seconds	Drive rebuild aborted

Storage Controller Module indicators

The Storage Controller Module (SCM) indicators are located on top of the drive drawer.

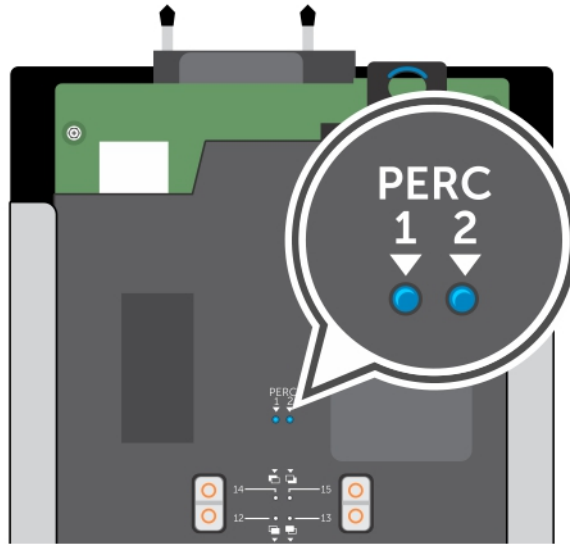

Figure 4. Storage Controller Module (SCM) indicators

1 indicator for PERC/HBA 1

2 indicator for PERC/HBA 2

NOTE: The PERC/HBA 2 indicator is always Off if you are using a single PERC/HBA

Indicator pattern	Description
Off	SCM is offline
Solid blue	SCM is online
Blinks blue	SCM or the compute sled to which it is mapped is being identified
Blinks amber and turns off	SCM is in fault condition

Documentation matrix

The documentation matrix provides information about documents that you can refer to, for setting up and managing your system.

To...	Refer to...
Set up your system and know the system technical specifications	Getting Started With Your System
Know the storage sled features, storage sled to compute sled configuration options, remove and install storage sled components, and troubleshoot components	Owner's Manual at dell.com/poweredgemanuals
Get an overview of the Dell Systems Management offerings	Dell OpenManage Systems Management Overview Guide at dell.com/openmanagemanuals
Know about how to configure storage mode in the storage sled and remote management of the storage sled from the Chassis Management Controller (CMC) interface	PowerEdge FX2/FX2s CMC User's Guide at dell.com/esmmanuals
Know about remote management of the storage sled from the integrated Dell Remote Access Controller (iDRAC) interface	iDRAC User's Guide at dell.com/esmmanuals
Know about the RACADM subcommands and supported RACADM interfaces	RACADM Command Line Reference Guide for iDRAC and CMC at dell.com/esmmanuals

To...

Know the compute sled features, remove and install compute sled components, and troubleshoot components

Know the enclosure features, remove and install enclosure components, and troubleshoot enclosure components

Know the features of the storage controller module, deploy the module, and manage the storage subsystem

See the event and error messages generated by the system firmware and agents that monitor system components

Refer to...

Compute sled Owner's Manual at dell.com/poweredgemanuals

Enclosure Owner's Manual at dell.com/poweredgemanuals

Storage controller documentation at dell.com/storagecontrollermanuals

Dell Event and Error Messages Reference Guide at dell.com/esmanuals

Quick Resource Locator

Use the Quick Resource Locator (QRL) to get immediate access to system information and how-to videos. This can be done by visiting dell.com/QRL or by using your smartphone and a model specific Quick Resource (QR) code located on your Dell PowerEdge system. To try out the QR code, scan the following image.

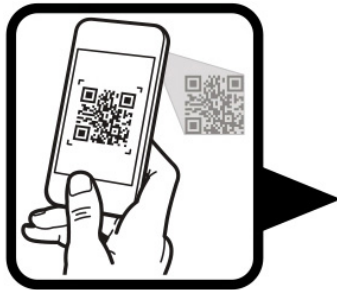

Performing initial system configuration

After you receive your PowerEdge FD332 system, you must set up your system in the enclosure. If your storage sled has shipped pre-installed in the enclosure, it is recommended that you remove the sled before you install the enclosure in the rack, to reduce chassis weight.

Topics:

- [Setting up your PowerEdge FD332](#)
- [Managing your system remotely](#)
- [Downloading drivers and firmware](#)

Setting up your PowerEdge FD332

1 Unpack the storage sled.

NOTE: If your storage sled has shipped pre-installed in the enclosure, remove the sled before installing the enclosure in the rack, to reduce chassis weight. See [Removing a storage sled](#).

NOTE: If you are installing the storage sled in an enclosure that is already powered on, you need not turn off the enclosure to install the storage sled. Only the compute sled(s) to which the storage sled is mapped must be turned off.

2 Turn off the compute sled(s) to which the storage sled is mapped, by using the CMC, iDRAC, or the power button on the compute sled(s). For information on mapping configurations of storage sleds to compute sleds, see [Storage sled mapping configurations](#).

3 Remove the I/O connector cover from the storage sled connectors.

4 Install the storage sled in the enclosure. See [Installing a storage sled](#).

NOTE: Install the storage sled(s) in the bottom slots of the PowerEdge FX2s enclosure, beginning from the left (slot 3). In the four-bay chassis that supports up to three storage sleds, you can also install a storage sled in the top right slot (slot 2) of the enclosure. For information on sled slot numbering, see the *Dell PowerEdge FX2 and FX2s Enclosure Owner's Manual* at dell.com/poweredgemanuals.

NOTE: You cannot install the storage sled in the top left slot (slot 1) of the four-bay chassis.

5 Turn on the compute sled(s) to which the storage sled is mapped, by using the iDRAC, CMC, or the compute sled power button.

NOTE: The storage sled turns on when the compute sled(s) to which it is mapped is/are turned on. For information on the mapping configurations, see [Storage sled mapping configurations](#).

NOTE: If the enclosure is not powered on when you are installing the compute and storage sleds, turn on the enclosure and wait for it to initialize before turning on the compute sled(s).

Managing your system remotely

You can manage and monitor the storage sled by using:

- the Chassis Management Controller (CMC). For more information, see the CMC User's Guide at dell.com/esmmanuals.
- the iDRAC of the compute sled to which the storage sled is mapped. For more information, see the iDRAC User's Guide at dell.com/esmmanuals.
- the Dell OpenManage Server Administration (OMSA) software. For more information, see dell.com/openmanagemanuals.

Downloading drivers and firmware

It is recommended that you download and install the latest BIOS, drivers, and systems management firmware on the compute sled to which the storage sled is mapped, and on the chassis infrastructure.

Prerequisite

Ensure that you clear the web browser cache.

Steps

- 1 Go to **dell.com/support/drivers**.
- 2 In the **Product Selection** section, enter the Service Tag of your system in the **Service Tag or Express Service Code** field.

i **NOTE:** If you do not have the Service Tag, select **Automatically detect my Service Tag for me to allow the system to automatically detect your Service Tag, or select Choose from a list of all Dell products to select your product from the Product Selection page.**

- 3 Click **Get drivers and downloads**.
The drivers that are applicable to your selection are displayed.
- 4 Download the drivers you require to a diskette drive, USB drive, CD, or DVD.

Storage sled mapping configurations

The storage controller(s) inside a storage sled map to compute sled(s) in the enclosure. PowerEdge FX2s supports multiple storage sled to compute sled mapping configurations.

NOTE: Storage sled to compute sled mapping is pre-configured.

NOTE: The PowerEdge FM120x4 compute sled does not support the storage sled. You cannot map a storage sled to the PowerEdge FM120x4 half-width compute sled.

For information on configuring the storage mode in the storage sleds, see the PowerEdge FX2/FX2s CMC User's Guide at dell.com/esmmanuals.

Topics:

- Single PERC/HBA Controller and joined mode mapping configurations
- Split mode mapping configurations

Single PERC/HBA Controller and joined mode mapping configurations

CAUTION: Changing the storage sled mapping configuration from Split Single Host mode to Joined mode can change some hard drives/SSDs to non-RAID mode.

The single PERC/HBA Controller and joined mode configurations apply to the following:

- The storage sled supports a storage controller module with a single controller, and all hard drives/SSDs map to the single controller.
- The storage sled supports a storage controller module with dual controllers, but only the primary controller is enabled by setting the **Storage Mode** to **Joined** in the Chassis Management Controller (CMC) interface. All hard drives/SSDs in the storage sled map to the primary controller in the joined mode.

The following enclosure configurations support single PERC/HBA controller and joined mode mapping.

- Four-bay chassis—controllers inside two storage sleds map to two half-width compute sleds
- Four-bay chassis (one compute sled)—controllers inside three storage sleds map to one half-width compute sled
- Six-bay chassis—controllers inside two storage sleds map to two quarter-width compute sleds
- Three-bay chassis—controllers inside two storage sleds map to one full-width compute sled

NOTE: PowerEdge FX2s supports multiple single PERC/HBA controller and joined mode mapping configurations. You must select the desired configuration based on your intended usage.



Figure 5. Single PERC/HBA joined mode mapping configuration—four-bay chassis



Figure 6. Single PERC/HBA joined mode mapping configuration—four-bay chassis (one compute sled)

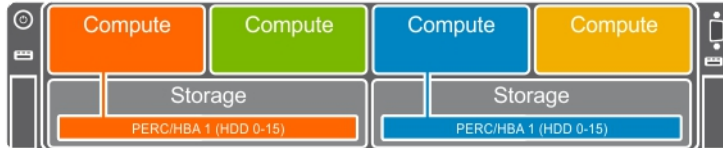

Figure 7. Single PERC/HBA joined mode mapping configuration—six-bay chassis

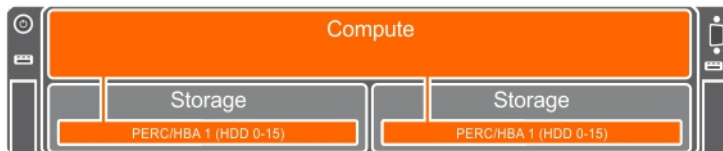

Figure 8. Single PERC/HBA joined mode mapping configuration—three-bay chassis

Split mode mapping configurations

CAUTION: Changing the storage sled mapping configuration from Joined mode to Split mode can result in loss of configuration and/or loss of access to hard drives/SSDs.

NOTE: When changing the mapping configuration from Joined mode to Split mode, the secondary controller is powered on. It is recommended that you run the latest PERC/HBA firmware Dell Update Package (DUP) to ensure that both controllers are running the latest firmware.

The split mode mapping configurations apply to the following:

- The storage sled supports a storage controller module with dual PERC/HBA controllers.
- Both controllers are enabled by setting the **Storage Mode** to split mode in the CMC interface.

In the split mode, eight hard drives/SSDs are mapped to each controller. Hard drives/SSDs in slots 0 to 7 map to controller 1 or primary controller, and hard drives/SSDs in slots 8 to 15 map to controller 2. For more information, see [Drive to storage controller mapping](#).

There are two split mode options available in the CMC interface:

- **Split Single Host** mode
- **Split Dual Host** mode

Split single host mapping configuration

In the split single host mapping configuration, dual controllers inside a storage sled map to a single compute sled.

The following enclosure configurations support split single host mapping.

- Four-bay chassis with two compute sleds—dual controllers inside a storage sled map to a half-width compute sled.
- Four-bay chassis with one compute sled—dual controllers inside each storage sled map to the single half-width compute sled.
- Three-bay chassis with one compute sled—dual controllers inside each storage sled map to the single full-width compute sled.

NOTE: PowerEdge FX2s supports multiple split single host mapping configurations. You must select the desired configuration based on your intended usage.



Figure 9. Split single host mapping configuration—four-bay chassis

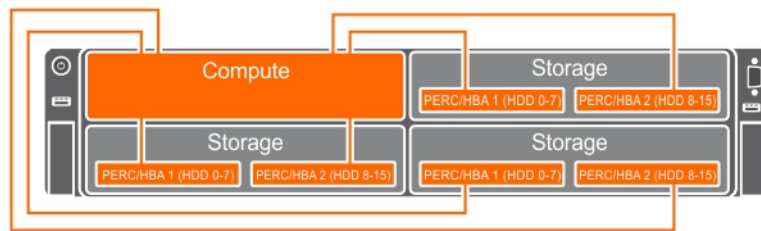

Figure 10. Split single host mapping configuration—four-bay chassis (one compute sled)

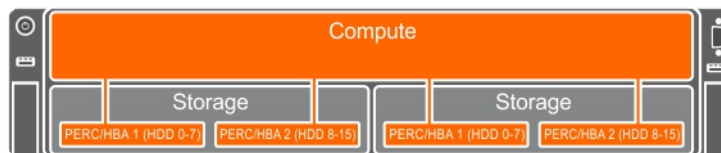

Figure 11. Split single host mapping configuration—three-bay chassis

Split dual host mapping configuration

In the split dual host mapping configuration, dual controllers inside one storage sled are mapped to two different compute sleds.

NOTE: PowerEdge FX2s supports multiple split dual host mapping configurations. You must select the desired configuration based on your intended usage.

The following are examples of split dual host mapping configurations.



Figure 12. Split dual host configuration—four-bay chassis

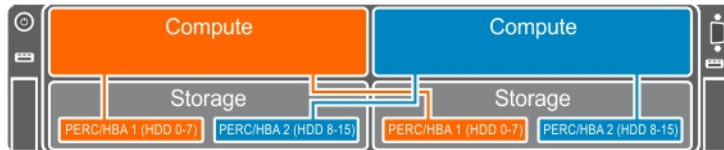

Figure 13. Split dual host configuration—four-bay chassis

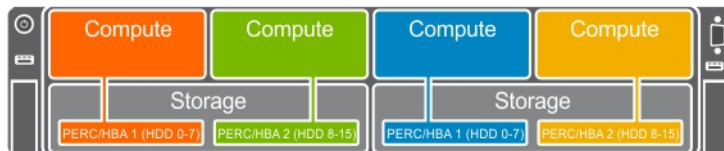

Figure 14. Split dual host configuration—six-bay chassis

Drive to storage controller mapping

Your system supports up to sixteen 2.5 inch SAS/SATA hard drives/SSDs.

When you install a storage controller module with a single controller, all the drives map to the single controller.

When you install a storage controller module with dual controllers, the drives in slots 0 to 7 map to controller 1 or the primary controller. The drives in slots 8 to 15 map to controller 2 or the secondary controller.

NOTE: In the split single host storage mode, the storage controller enumeration in the PERC/HBA BIOS Configuration (Ctrl+R) utility is different from the enumeration in the iDRAC and Human Interface Infrastructure (HII) interfaces. In the Ctrl+R utility, the secondary controller is listed before the primary controller. It is recommended that you review the Ctrl+R slot information detail to determine the appropriate controller. For example, Slot 0x31, where 3 refers to the storage sled slot number and 1 refers to the controller 1. Similarly, in Slot 0x32, 3 refers to the storage sled slot number and 2 refers to controller 2.

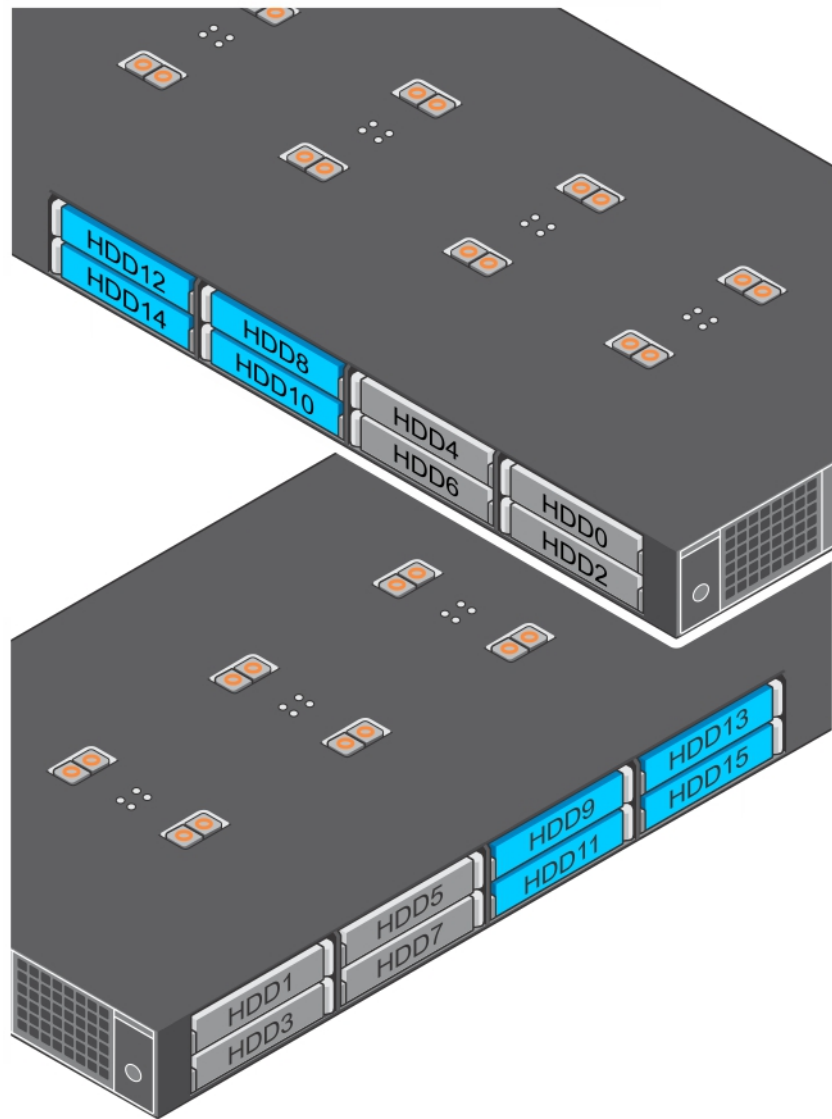

Figure 15. Mapping of drives to dual storage controllers

Icon	Description
■	Hard drives/SSDs mapped to the primary controller or controller 1.
■	Hard drives/SSDs mapped to the secondary controller or controller 2.

Installing and removing storage sled components

This section provides information on installing and removing the storage sled components. For information on removing and installing the compute sled components, see the relevant sled Owner's Manual at dell.com/poweredgemanuals. For information on installing and removing the enclosure components, see the enclosure Owner's Manual at dell.com/poweredgemanuals.

Topics:

- [Customer and field replaceable units—PowerEdge FD332](#)
- [Safety instructions](#)
- [Before working inside your system](#)
- [After working inside your system](#)
- [Recommended tools](#)
- [Storage sled](#)
- [Inside the sled](#)
- [Drive drawer](#)
- [Mini Enterprise Service Tag](#)
- [Hard drive/SSD assembly](#)
- [Storage controller module](#)
- [Bezel assembly](#)

Customer and field replaceable units—PowerEdge FD332

The following components are customer replaceable units (CRUs):

- hard drive/SSD assembly
- storage controller module batteries

NOTE: For information on removing and installing the storage controller module batteries, see the *Dell PowerEdge RAID Controller (PERC) 9 User's Guide* at dell.com/storagecontrollermanuals.

The following components are field replaceable units (FRUs). Removal and installation procedures of the FRUs should be performed only by Dell certified service technicians.

- Hard drives/SSDs from drive rails
- Mini Enterprise Service Tag (MEST)
- Storage controller module
- Bezel assembly

Safety instructions

CAUTION: Many repairs may only be done by a certified service technician. You should only perform troubleshooting and simple repairs as authorized in your product documentation, or as directed by the online or telephone service and support team. Damage due to servicing that is not authorized by Dell is not covered by your warranty. Read and follow the safety instructions that came with the product.

NOTE: It is recommended that you always use an antistatic mat and antistatic strap while working on components inside the system.

Before working inside your system

- 1 Turn off the compute sled(s) to which the storage sled is mapped, by using the CMC, iDRAC, or the power button on the compute sled.

When the sled is turned off, its front panel power indicator is off.

The storage sled also turns off.

- 2 Remove the storage sled from the enclosure.
- 3 Install the I/O connector cover.

Related link

[Removing a storage sled](#)

After working inside your system

- 1 Remove the I/O connector cover.
- 2 Install the storage sled in the enclosure.
- 3 Turn on the compute sled(s) to which the storage sled is mapped.

The storage sled turns on after the compute sled is turned on.

Related link

[Installing a storage sled](#)

Recommended tools

You may need the following items to perform the procedures in this section:

- #1 and #2 Phillips screwdrivers
- T15 Torx driver

Storage sled

Removing a storage sled

Prerequisites

CAUTION: Many repairs may only be done by a certified service technician. You should only perform troubleshooting and simple repairs as authorized in your product documentation, or as directed by the online or telephone service and support team. Damage due to servicing that is not authorized by Dell is not covered by your warranty. Read and follow the safety instructions that came with the product.

CAUTION: Removing the storage sled from the enclosure when the storage sled is powered on results in loss of data.

CAUTION: To prevent damage to the storage sled locks, use a #2 Phillips screwdriver to turn the sled locks to lock or unlock positions.

- 1 Ensure that you read the Safety instructions provided in this document.
- 2 Turn off the compute sled(s) to which the storage sled is mapped, by using the CMC, iDRAC, or the sled power button.
- 3 Keep the #2 Phillips screwdriver ready.

Steps

1 Using a Phillips #2 screwdriver, turn the storage sled locks on the sled front panel to unlock position.

CAUTION: If you are permanently removing the sled, install a sled blank. Operating the enclosure for extended periods of time without a sled blank installed can cause the enclosure to overheat.

2 Lift the sled release latches upward by 90 degrees, and holding it by the latches, pull the sled out of the enclosure.

CAUTION: To protect the I/O connector pins, install the I/O connector cover every time a sled is removed from the enclosure.

3 Install the I/O connector cover over the I/O connectors.

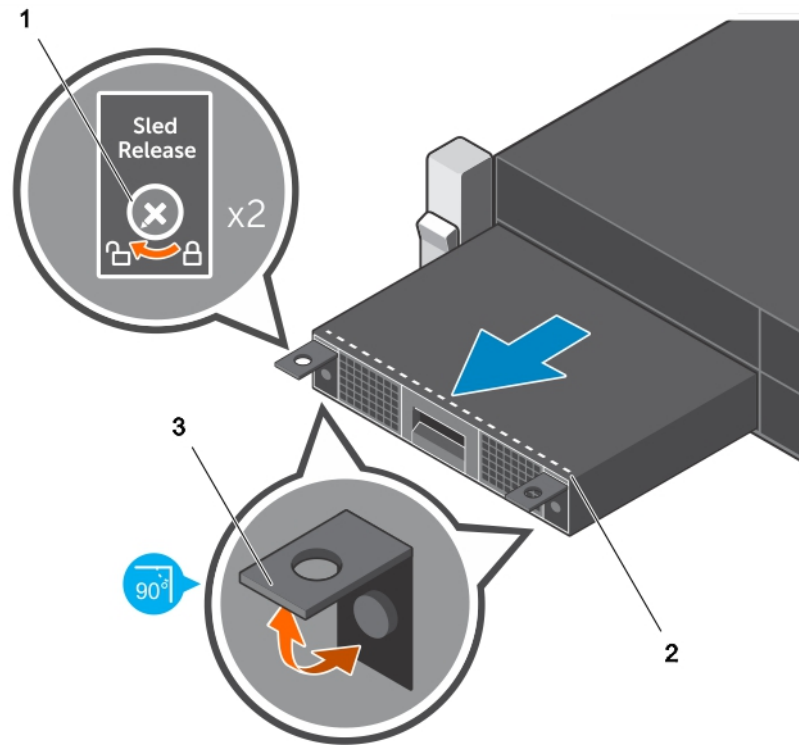

Figure 16. Removing a storage sled

1 sled lock (2)

3 sled release latch (2)

2 dotted line on storage sled

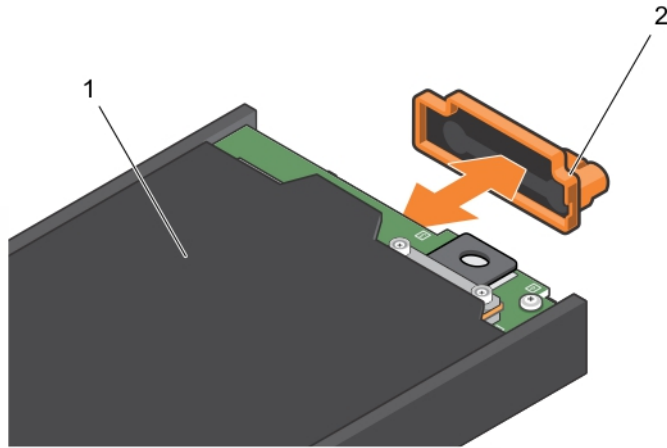

Figure 17. Removing and installing the I/O connector cover

1 storage sled

2 I/O connector cover

Next step

Install the storage sled or sled blank.

Related links

[Safety instructions](#)

[Storage sled mapping configurations](#)

Installing a storage sled

Prerequisites

CAUTION: Many repairs may only be done by a certified service technician. You should only perform troubleshooting and simple repairs as authorized in your product documentation, or as directed by the online or telephone service and support team. Damage due to servicing that is not authorized by Dell is not covered by your warranty. Read and follow the safety instructions that came with the product.

CAUTION: To prevent damage to the I/O connectors, do not touch the connectors or the connector pins.

CAUTION: To prevent damage to the sled locks, use a #2 Phillips screwdriver to turn the sled locks to lock or unlock positions.

NOTE: Install the storage sleds in the bottom slots of the PowerEdge FX2s enclosure, beginning from the left (slot 3). In the four-bay chassis, you can also install a storage sled in the top right slot (slot 2) of the enclosure. For more information on sled slot numbering, see the *Dell PowerEdge FX2 and FX2s Enclosure Owner's Manual* at dell.com/poweredgemanuals.

NOTE: If your storage sled has shipped pre-installed in the enclosure, it is recommended that you remove the sled before installing the enclosure in the rack, to reduce chassis weight.

NOTE: If you are installing the storage sled in an enclosure that is already powered on, you need not turn off the enclosure to install the storage sled. Only the compute sled(s) to which the storage sled is mapped must be turned off.

- 1 Ensure that you read the Safety instructions.
- 2 Turn off the compute sled to which the storage sled is mapped, by using the CMC, iDRAC, or the power button on the compute sled.
- 3 Keep the #2 Phillips screwdriver ready.

Steps

- 1 If you are installing a new storage sled, remove the I/O connector cover and save for future use.
- 2 Align the storage sled with the bay in the enclosure.

⚠ **CAUTION:** To ensure that a storage sled is properly installed, slide the sled into the enclosure bay until the dotted line on top of the storage sled is not visible from the top edge of the bay in which the storage sled is being installed.

⚠ **CAUTION:** If a compute sled is already installed in an enclosure bay above the bay in which you are installing a storage sled, the compute sled may obscure the dotted line on the storage sled. Do not use the compute sled installed in the top enclosure bay as a point of reference for visibility of the dotted line on top of the storage sled. For the storage sled to be properly installed, ensure that the dotted line on the storage sled is not visible from the top edge of the bay in which the storage sled is installed.

3 Slide the storage sled into the enclosure until the dotted line on top of the sled is not visible from the top edge of the bay, and the sled clicks into place.

4 Turn the storage sled locks to the lock position, to secure the sled in the enclosure.

⚠ **CAUTION:** Ensure that the sled locks are in locked position before opening the storage sled drive drawer, as the storage sled must be locked in the enclosure before you open the drive drawer.

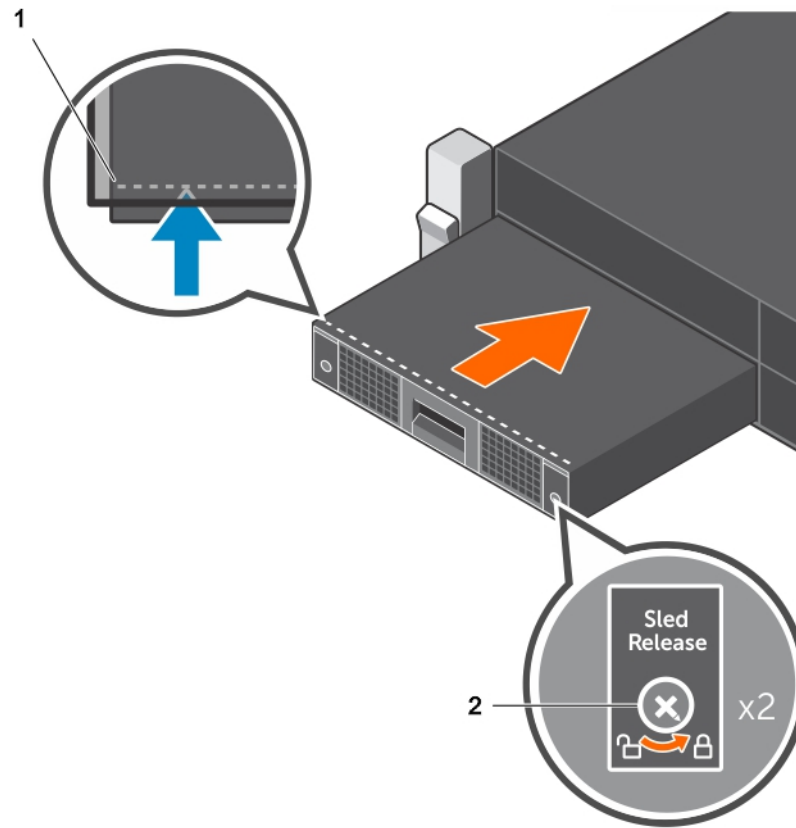

Figure 18. Installing a storage sled

1 dotted line on storage sled

2 sled lock (2)

Next step

Turn on the compute sled(s) to which the storage sled is mapped. The storage sled turns on.

Related links

[Safety instructions](#)

[Storage sled mapping configurations](#)

Inside the sled

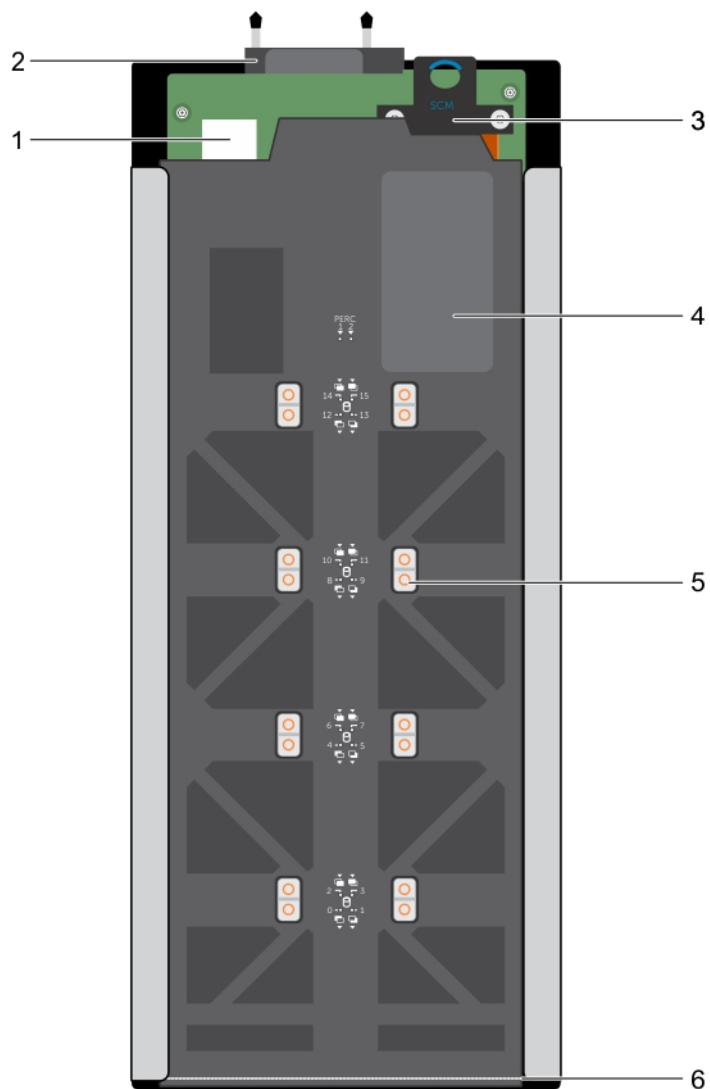

Figure 19. Inside the sled

- | | | | |
|---|---------------------------------|---|-------------------------------------|
| 1 | storage controller module | 2 | I/O connector to enclosure midplane |
| 3 | storage controller module cable | 4 | drive drawer |
| 5 | hard-drive/SSD release tab (16) | 6 | dotted line on top of storage sled |

Drive drawer

The drive drawer supports up to 16 hot swap hard drives/SSDs. You must open the drive drawer and access the drives from the sides of the drawer.

Opening the drive drawer

Prerequisites

- ⚠ **CAUTION:** Many repairs may only be done by a certified service technician. You should only perform troubleshooting and simple repairs as authorized in your product documentation, or as directed by the online or telephone service and support team. Damage due to servicing that is not authorized by Dell is not covered by your warranty. Read and follow the safety instructions that came with the product.
- ⚠ **CAUTION:** The storage sled must be locked in the enclosure before you open the drive drawer. Ensure that the sled locks are in locked position.
- ⚠ **CAUTION:** Do not keep the drive drawer open for more than three minutes.

Ensure that you read the [Safety instructions](#).

Step

Pull the drive drawer handle on the front panel of the storage sled, and slide the drawer out of the sled until you access the hard drives/SSDs.

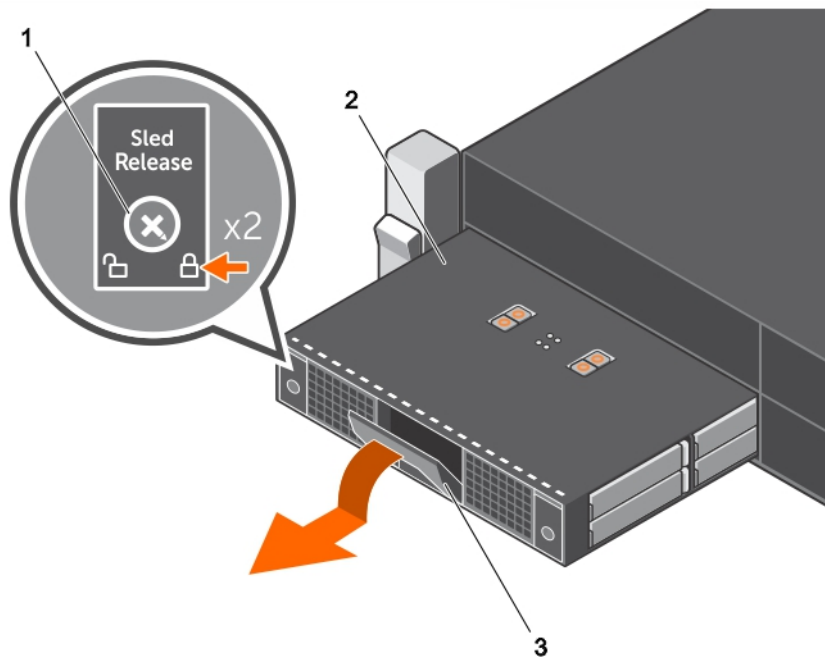

Figure 20. Opening the drive drawer

- 1 sled lock
- 2 drive drawer
- 3 drive drawer handle

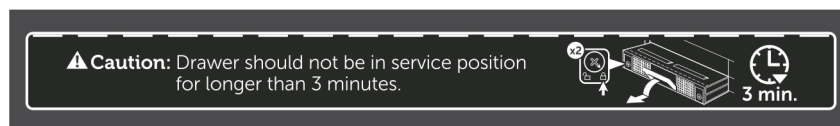

Figure 21. Service caution label on the drive drawer

Next step

Close the drive drawer.

Related link

[Closing the drive drawer](#)

Closing the drive drawer

Prerequisites

⚠ **CAUTION:** Many repairs may only be done by a certified service technician. You should only perform troubleshooting and simple repairs as authorized in your product documentation, or as directed by the online or telephone service and support team. Damage due to servicing that is not authorized by Dell is not covered by your warranty. Read and follow the safety instructions that came with the product.

⚠ **CAUTION:** Ensure that the sled locks are in the locked position.

⚠ **CAUTION:** Ensure that the drive drawer handle is in closed position before closing the drawer.

📄 **NOTE:** You must open the drive drawer to install hard drives/SSDs or service hard drives/SSDs in the drawer.

- 1 Ensure that you read the [Safety instructions](#).
- 2 Open the drive drawer.

Step

Slide the drive drawer into the sled until it is fully seated.

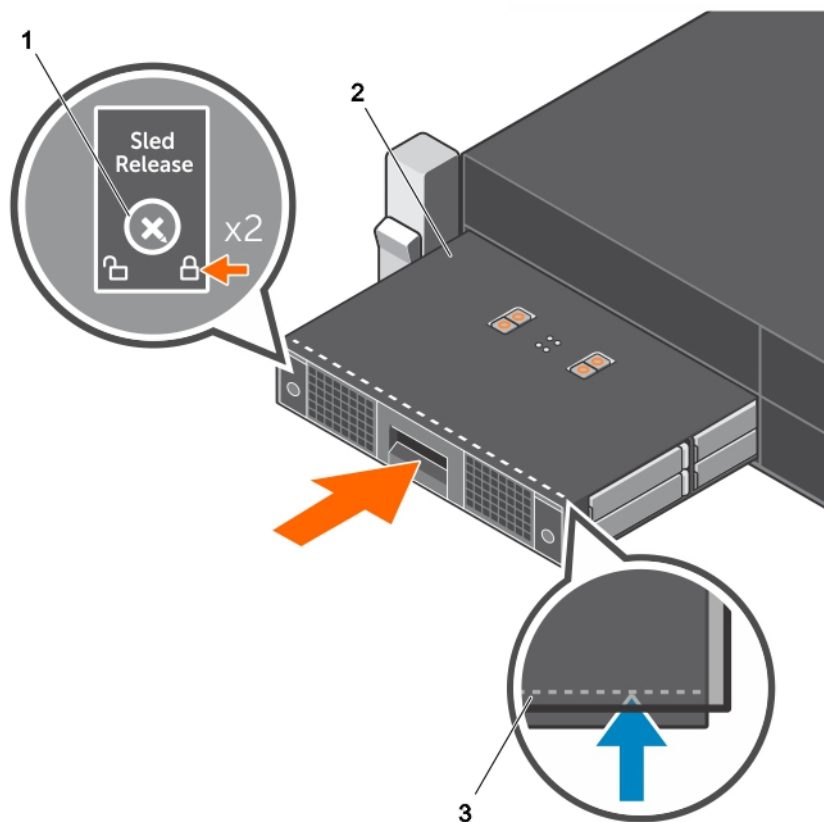

Figure 22. Closing the drive drawer

1 sled lock (2)

2 drive drawer

- 3 dotted line on the drive drawer

Related link

[Opening the drive drawer](#)

Mini Enterprise Service Tag

The Mini Enterprise Service Tag is a removable label panel located on the storage sled front panel, which lists the system Service Tag.

Removing the Mini Enterprise Service Tag

Prerequisites

⚠ CAUTION: Many repairs may only be done by a certified service technician. You should only perform troubleshooting and simple repairs as authorized in your product documentation, or as directed by the online or telephone service and support team. Damage due to servicing that is not authorized by Dell is not covered by your warranty. Read and follow the safety instructions that came with the product.

📌 NOTE: This is a field replaceable unit (FRU). Removal and installation procedures must be performed only by Dell certified service technicians.

- 1 Ensure that you read the [Safety instructions](#).
- 2 Keep the #1 Phillips screwdriver ready.

Steps

- 1 Pull the drive drawer handle on the front panel of the storage sled, and keep it in open position.
- 2 Remove the screw securing the Mini Enterprise Service Tag (MEST) to the sled front panel.
- 3 Remove the MEST from the sled.

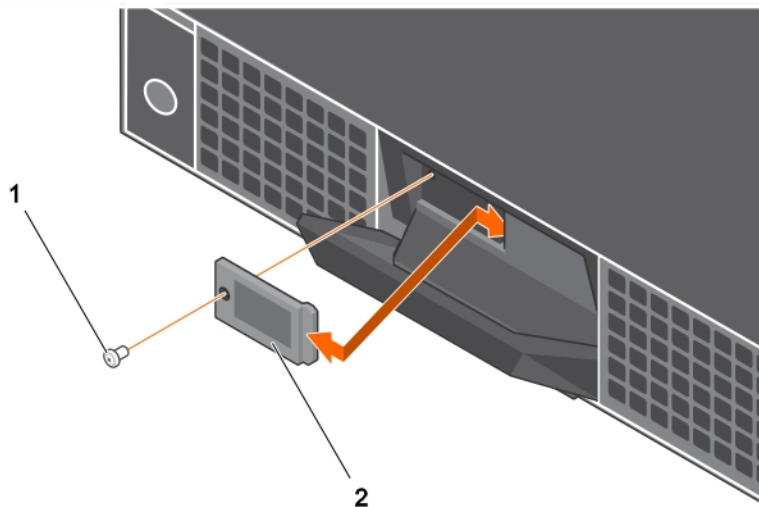

Figure 23. Removing and installing the MEST

1 screw

2 MEST

Next step

Install the MEST.

Related link

[Installing the Mini Enterprise Service Tag](#)

Installing the Mini Enterprise Service Tag

Prerequisites

⚠ CAUTION: Many repairs may only be done by a certified service technician. You should only perform troubleshooting and simple repairs as authorized in your product documentation, or as directed by the online or telephone service and support team. Damage due to servicing that is not authorized by Dell is not covered by your warranty. Read and follow the safety instructions that came with the product.

ℹ NOTE: This is a field replaceable unit (FRU). Removal and installation procedures must be performed only by Dell certified service technicians.

- 1 Ensure that you read the [Safety instructions](#).
- 2 Keep the #1 Phillips screwdriver ready.
- 3 Remove the Mini Enterprise Service Tag (MEST).

Steps

- 1 Align the edge of the MEST opposite to the screw hole end, with the slot on the sled front panel.
- 2 Align the screw hole on the tag with the screw hole on the sled front panel and install the screw to secure the tag to the sled front panel.
- 3 Close the drive drawer handle.

Related link

[Removing the Mini Enterprise Service Tag](#)

Hard drive/SSD assembly

Your storage sled supports up to sixteen 2.5 inch SAS/SATA hard drives/SSDs.

The hard drive assembly consists of the following:

- Hard drive/SSD
- Hot swap drive rails that fit in the drive slots, and into which the drive is installed
- Screws securing the drive to the drive rails

Removing a hard drive/SSD assembly

Prerequisites

⚠ CAUTION: Many repairs may only be done by a certified service technician. You should only perform troubleshooting and simple repairs as authorized in your product documentation, or as directed by the online or telephone service and support team. Damage due to servicing that is not authorized by Dell is not covered by your warranty. Read and follow the safety instructions that came with the product.

⚠ CAUTION: To prevent data loss, ensure that your operating system supports hot-swap drive installation. See the documentation supplied with your operating system.

⚠ CAUTION: Do not keep the drive drawer open for more than three minutes.

- 1 Ensure that you read the [Safety instructions](#).
- 2 Using the management software like OpenManage Server Administrator (OMSA), prepare the hard drive/SSD for removal. If the hard drive/SSD is online, the drive indicator flashes as the drive is turned off. You can remove the hard drive/SSD when the drive indicator turns off.
- 3 Open the drive drawer.

Steps

- 1 Press the release tab of the hard drive/SSD that you want to remove.
The drive rail release handle slides out of the drive slot.

NOTE: The hard drive/SSD release tabs are located on top of the drive drawer. The drive slot number near each release tab indicates the release tab for the drive in the slot.

CAUTION: Exercise caution when you pull out the hard drive/SSD assembly, because excess force can cause the drive assembly to fall. It is recommended that you support the bottom of the drive assembly with one hand while holding the drive release handle with the other hand.

- 2 Holding the drive rail release handle, pull the hard drive/SSD assembly out of the drive slot.

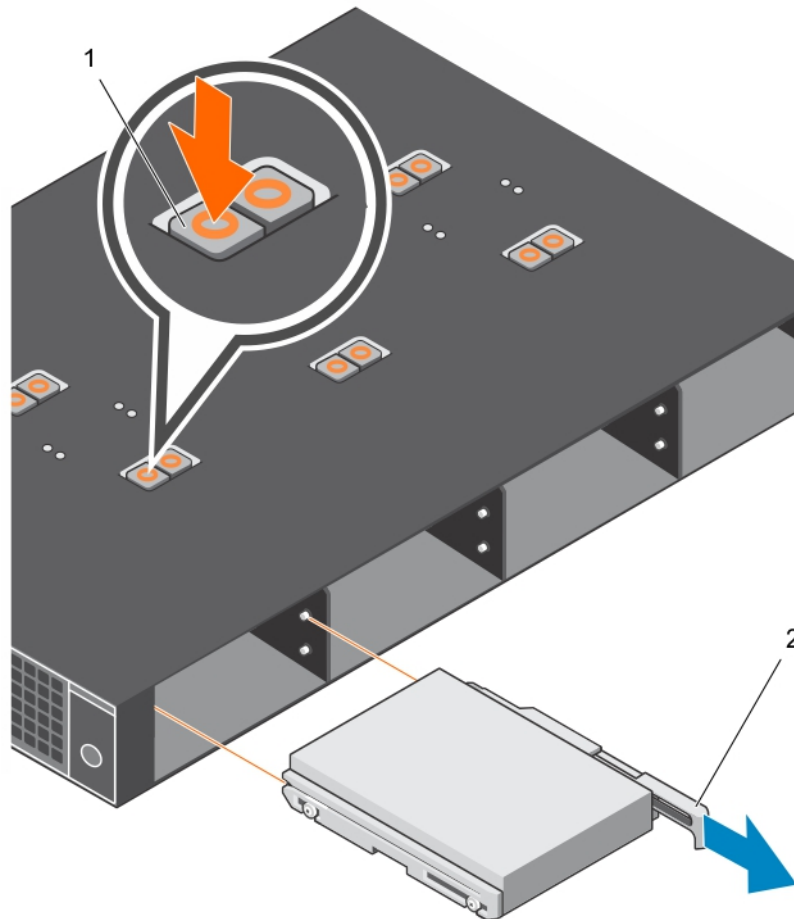

Figure 24. Removing and installing a hard drive/SSD assembly

1 hard drive/SSD release tab

2 drive rail release handle

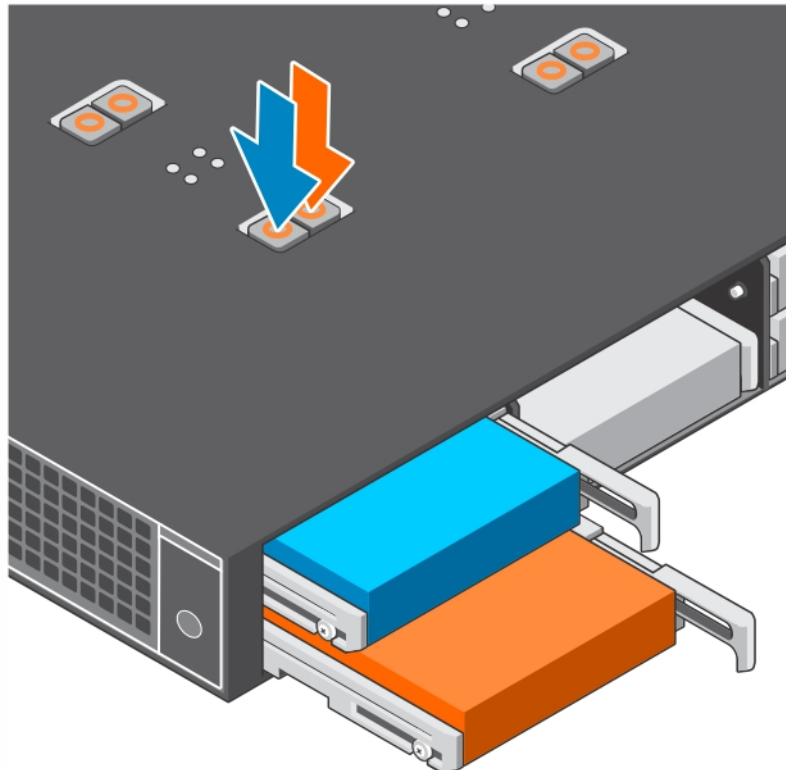

Figure 25. Release tabs for the top and bottom hard drives/SSDs

Next step

Install the hard drive/SSD assembly.

Related links

[Installing a hard drive/SSD assembly](#)

[Opening the drive drawer](#)

Installing a hard drive/SSD assembly

Prerequisites

- △ **CAUTION:** Many repairs may only be done by a certified service technician. You should only perform troubleshooting and simple repairs as authorized in your product documentation, or as directed by the online or telephone service and support team. Damage due to servicing that is not authorized by Dell is not covered by your warranty. Read and follow the safety instructions that came with the product.
- △ **CAUTION:** Use only hard drives/SSDs that have been tested and approved for use with the hard drive backplane.
- △ **CAUTION:** Combining SAS and SATA hard drives/SSDs in the same RAID volume is not supported.
- △ **CAUTION:** When installing a hard drive/SSD, ensure that the adjacent drives are fully installed. Inserting a drive assembly and attempting to lock its handle next to a partially installed assembly can damage the shield spring of the partially installed assembly, and make it unusable.

- ⚠ **CAUTION:** To prevent data loss, ensure that your operating system supports hot-swap drive installation. See the documentation supplied with your operating system.
- ⚠ **CAUTION:** Do not keep the drive drawer open for more than three minutes.
- ⚠ **CAUTION:** When a replacement hot-swappable hard drive is installed and the system is powered on, the hard drive automatically begins to rebuild. Make absolutely sure that the replacement hard drive is blank or contains data that you wish to have overwritten. Any data on the replacement hard drive is immediately lost after the hard drive is installed.
- ⓘ **NOTE:** If the replacement hard drive/SSD is an online drive that is migrated from another system, it is detected as Foreign in the PERC BIOS Configuration utility. You can import the existing configuration or clear the data from the drive. For more information on foreign configuration, see the *Dell PowerEdge RAID Controller (PERC) 9 User's Guide* at dell.com/storagecontrollermanuals.

- 1 Ensure that you read the [Safety instructions](#).
- 2 Open the drive drawer.

Steps

- 1 Align the drive rails with the standoffs in the drive slot, with:
 - a the connector side of the hard drive/SSD facing up, for even-numbered drive slots.
 - b the connector side of the hard drive/SSD facing down, for odd-numbered drive slots.

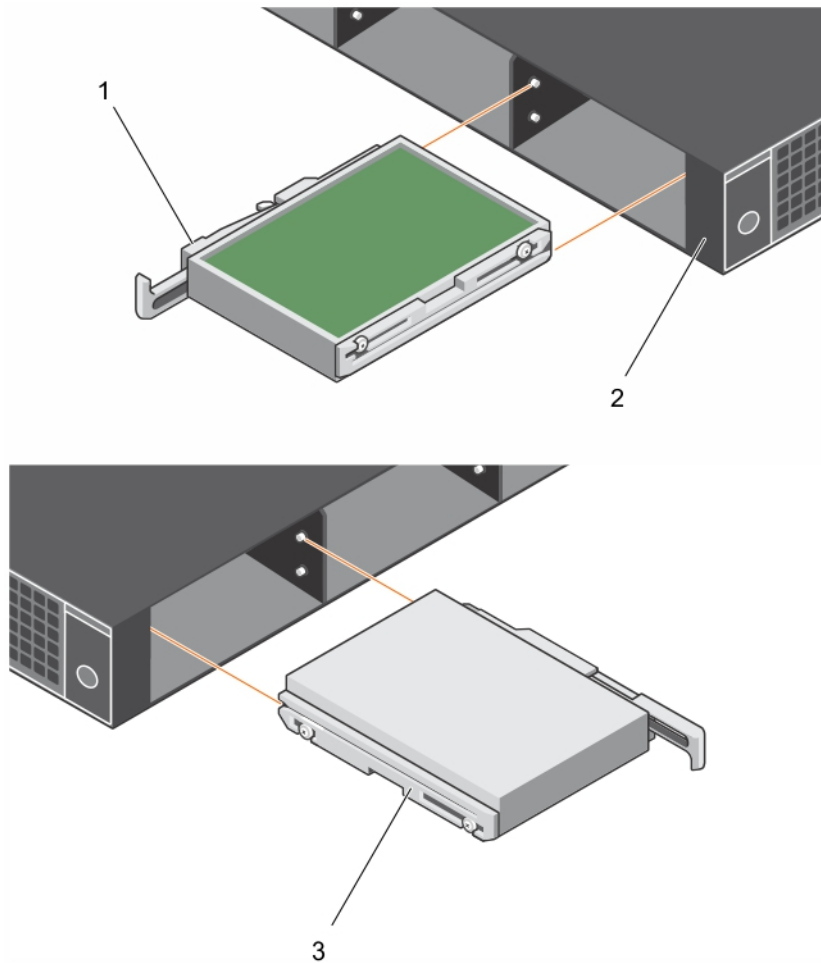

Figure 26. Hard drive/SSD assembly orientation for even and odd-numbered slots

- | | | | |
|---|--|---|--------------|
| 1 | hard drive/SSD assembly orientation for even numbered slots (with connector side of drive facing up) | 2 | storage sled |
|---|--|---|--------------|

- 3 hard drive/SSD assembly orientation for odd numbered slots (with connector side of drive facing down)
- 2 Slide the drive assembly into the slot until the drive connector engages with the connector on the backplane.
- 3 Close the drive release handle until it clicks into place, to lock the hard drive/SSD.

Next step

Close the drive drawer.

Related links

[Removing a hard drive/SSD assembly](#)

[Opening the drive drawer](#)

[Closing the drive drawer](#)

Removing a hard drive/SSD from the drive rails

Prerequisites

CAUTION: Many repairs may only be done by a certified service technician. You should only perform troubleshooting and simple repairs as authorized in your product documentation, or as directed by the online or telephone service and support team. Damage due to servicing that is not authorized by Dell is not covered by your warranty. Read and follow the safety instructions that came with the product.

CAUTION: Do not keep the drive drawer open for more than three minutes.

NOTE: This is a field replaceable unit (FRU). Removal and installation procedures must be performed only by Dell certified service technicians.

NOTE: You must remove a hard drive/SSD from the drive rails if you are replacing the hard drive/SSD with a new drive.

NOTE: The drive rails are attached to the sides of the hard drive/SSD. One of the rails comprises the release handle.

- 1 Ensure that you read the [Safety instructions](#).
- 2 Open the drive drawer.
- 3 Remove the hard drive/SSD assembly from the drive drawer.
- 4 Close the drive drawer.
- 5 Keep the #1 Phillips screwdriver ready.

Step

Remove the screws securing the hard drive/SSD to the drive rails.

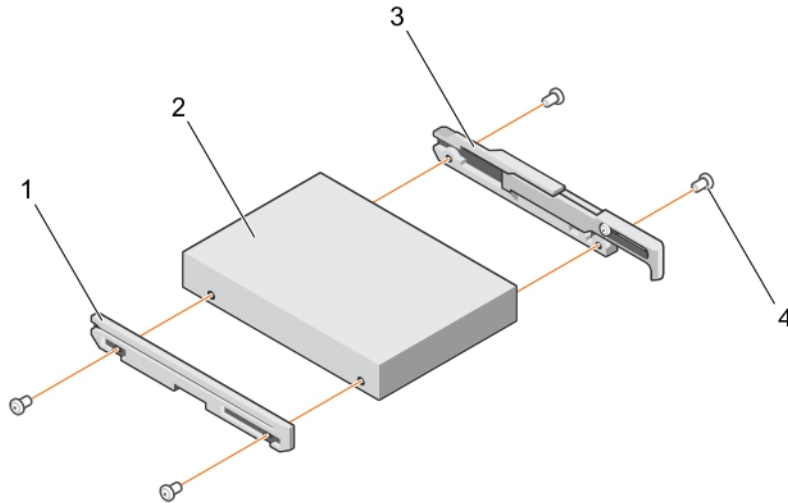

Figure 27. Removing and installing a hard drive/SSD into the drive rails

- | | | | |
|---|--------------------------------|---|----------------|
| 1 | drive rail | 2 | hard drive/SSD |
| 3 | drive rail with release handle | 4 | screw (4) |

Next step

Install the hard drive/SSD into the drive rails.

Related links

- [Installing a hard drive/SSD into the drive rails](#)
- [Opening the drive drawer](#)
- [Closing the drive drawer](#)
- [Removing a hard drive/SSD assembly](#)

Installing a hard drive/SSD into the drive rails

Prerequisites

⚠ CAUTION: Many repairs may only be done by a certified service technician. You should only perform troubleshooting and simple repairs as authorized in your product documentation, or as directed by the online or telephone service and support team. Damage due to servicing that is not authorized by Dell is not covered by your warranty. Read and follow the safety instructions that came with the product.

⚠ CAUTION: Do not keep the drive drawer open for more than three minutes.

ⓘ NOTE: This is a field replaceable unit (FRU). Removal and installation procedures must be performed only by Dell certified service technicians.

ⓘ NOTE: You must remove a hard drive/SSD from the drive rails if you are replacing the hard drive/SSD with a new drive.

- 1 Ensure that you read the [Safety instructions](#).
- 2 Keep the #1 Phillips screwdriver ready.
- 3 Remove the hard drive/SSD from the drive rails.

Steps

- 1 Lay the hard drive/SSD on a flat surface with the connector side of the drive facing down.
- 2 Align the screw holes on the drive rails with the screw holes on the hard drive/SSD.

When aligned correctly, the drive rails are flush with the surface of the hard drive/SSD.

- 3 Install the screws to secure the drive to the drive rails.

Next steps

- 1 Open the drive drawer.
- 2 Install the drive assembly in the drive drawer.
- 3 Close the drive drawer.

Related links

- [Removing a hard drive/SSD from the drive rails](#)
- [Installing a hard drive/SSD assembly](#)
- [Opening the drive drawer](#)
- [Closing the drive drawer](#)

Storage controller module

Your system supports one storage controller module (SCM), which is available in four options:

- FD33xS—storage controller module with single PERC
- FD33xD—storage controller module with dual PERC
- FD33xS—storage controller module with single HBA
- FD33xD—storage controller module with dual HBA

NOTE: The default mode for all storage controller modules is HBA mode. To enable RAID mode for a PERC controller, you must upgrade to RAID mode licensing. For more information on RAID mode licensing, see the *PowerEdge FX2s CMC User's Guide* at dell.com/esmanuals. For information on how to import RAID mode license, see the *Dell PowerEdge FX2/FX2s CMC Online Help*.

For more information on the storage controller modules, and removing and installing the SCM components, see the *Dell PowerEdge RAID Controller (PERC) 9 User's Guide* at dell.com/storagecontrollermanuals and *Dell Host Bus Adaptor User's Guide* at https://www.dell.com/support/home/us/en/19/products/server_int/server_data_center_infrastructure.

Removing the storage controller module

Prerequisites

CAUTION: Many repairs may only be done by a certified service technician. You should only perform troubleshooting and simple repairs as authorized in your product documentation, or as directed by the online or telephone service and support team. Damage due to servicing that is not authorized by Dell is not covered by your warranty. Read and follow the safety instructions that came with the product.

NOTE: This is a field replaceable unit (FRU). Removal and installation procedures must be performed only by Dell certified service technicians.

NOTE: You must remove the storage controller module (SCM) to replace a faulty module.

- 1 Ensure that you read the [Safety instructions](#).
- 2 Follow the procedure listed in [Before working inside your system](#).
- 3 Keep the T15 Torx screwdriver ready for the storage controller module cable screws.
- 4 Keep the #2 Phillips screwdriver ready for the screws securing the storage controller module to the module holder.

Steps

- 1 Open the drive drawer until the storage controller module is accessible.
- 2 Loosen the screws securing the module cable to the SCM.

- 3 Lift the module cable away from the SCM by holding the cable touch point.
- 4 Holding the touch point, allow the module cable to slowly retract into the cable coil.
- 5 Remove the screws securing the SCM to the module holder on the midplane interface module.
- 6 Holding the SCM by the touch points, lift the SCM from the connector on the midplane interface module.

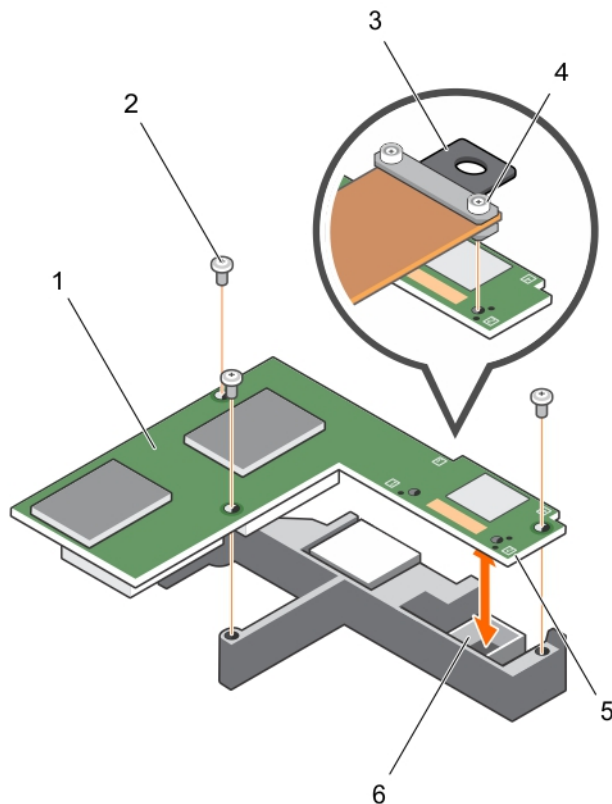

Figure 28. Removing and installing the storage controller module

- | | | | |
|---|----------------------------|---|--|
| 1 | storage controller module | 2 | screw (3) |
| 3 | SCM cable touch point | 4 | SCM cable screw (2) |
| 5 | touch point on the SCM (4) | 6 | connector on midplane interface module |

Next step

Install the storage controller module.

Related links

- [Installing the storage controller module](#)
- [Opening the drive drawer](#)
- [Closing the drive drawer](#)
- [Installing the storage controller module](#)
- [Opening the drive drawer](#)

Installing the storage controller module

Prerequisites

CAUTION: Many repairs may only be done by a certified service technician. You should only perform troubleshooting and simple repairs as authorized in your product documentation, or as directed by the online or telephone service and support team. Damage due to servicing that is not authorized by Dell is not covered by your warranty. Read and follow the safety instructions that came with the product.

NOTE: This is a field replaceable unit (FRU). Removal and installation procedures must be performed only by Dell certified service technicians.

- 1 Ensure that you read the [Safety instructions](#).
- 2 Follow the procedure listed in [Before working inside your system](#).
- 3 Keep the T15 Torx screwdriver ready for the storage controller module (SCM) cable screws.
- 4 Keep the #2 Phillips screwdriver ready for the screws securing the SCM to the module holder.
- 5 Remove the storage controller module.

Steps

- 1 Align the SCM with the connector on the midplane interface module.
- 2 Lower the SCM until it is firmly seated on the connector on the midplane interface module.
- 3 Install the screws to secure the SCM to the module holder on the midplane interface module.
- 4 Holding the module cable touch point, align the cable guide pins with the holes on the SCM.
- 5 Tighten the screws to secure the SCM cable to the module.

Next steps

- 1 Close the drive drawer.
 - 2 Follow the procedure listed in [After working inside your system](#).
- NOTE:** The replacement storage controller module is set to HBA mode by default. After replacing a RAID mode licensed storage controller module, you must set the replacement module to RAID mode.
- 3 Set the replacement storage controller module to RAID mode by using the PERC BIOS Configuration Utility (Ctrl+R) or the Human Interface Infrastructure (HII) utility.

Related links

- [Removing the storage controller module](#)
- [Opening the drive drawer](#)
- [Closing the drive drawer](#)
- [Removing the storage controller module](#)
- [Closing the drive drawer](#)

Bezel assembly

The bezel assembly on the storage sled front panel comprises the drive drawer handle and the Mini Enterprise Service Tag.

Removing the bezel assembly

Prerequisites

⚠ CAUTION: Many repairs may only be done by a certified service technician. You should only perform troubleshooting and simple repairs as authorized in your product documentation, or as directed by the online or telephone service and support team. Damage due to servicing that is not authorized by Dell is not covered by your warranty. Read and follow the safety instructions that came with the product.

⚠ CAUTION: To prevent damage to the storage sled locks, use a #2 Phillips screwdriver to turn the sled locks to lock or unlock positions.

ⓘ NOTE: This is a field replaceable unit (FRU). Removal and installation procedures must be performed only by Dell certified service technicians.

ⓘ NOTE: You must remove the bezel assembly to replace a faulty bezel assembly or when you are replacing the chassis.

- 1 Ensure that you read the [Safety instructions](#).
- 2 Follow the procedure listed in [Before working inside your system](#).
- 3 Remove the Mini Enterprise Service Tag (MEST) and save for future use.
- 4 Keep tweezers ready for the service caution label.
- 5 Keep the #2 Phillips screwdriver ready.

Steps

- 1 Release the service caution label from top of the storage sled by using tweezers.
- 2 Remove the service caution label and save for future use.

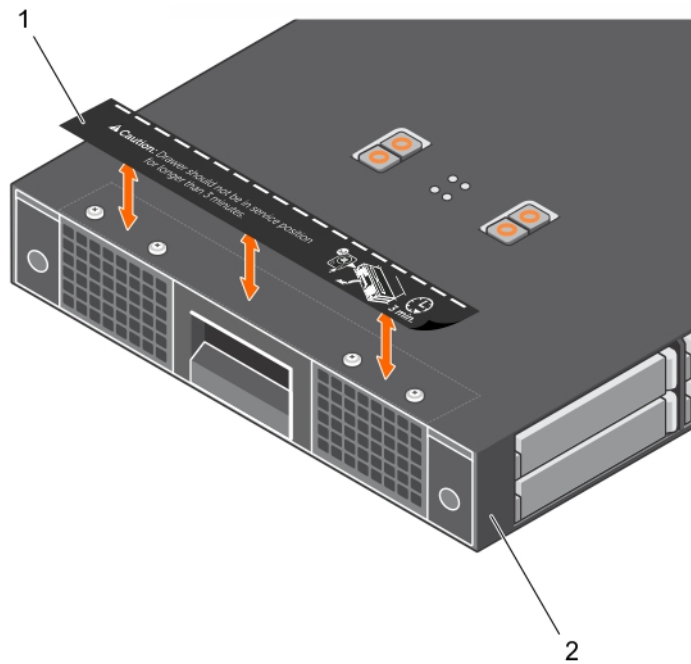

Figure 29. Removing and installing the service caution label

- | | | | |
|---|-----------------------|---|--------------|
| 1 | service caution label | 2 | storage sled |
|---|-----------------------|---|--------------|
- 3 Using a Phillips #2 screwdriver, turn the sled locks to lock position.
 - 4 Pull the drive drawer handle and open the drive drawer.

- 5 Remove the screws securing the bezel assembly to the top of the sled.
- 6 Turn the sled over with the bottom side of the sled facing up.
- 7 Remove the screws securing the bezel assembly to the bottom side of the sled.
- 8 Pull the bezel assembly out of the sled.

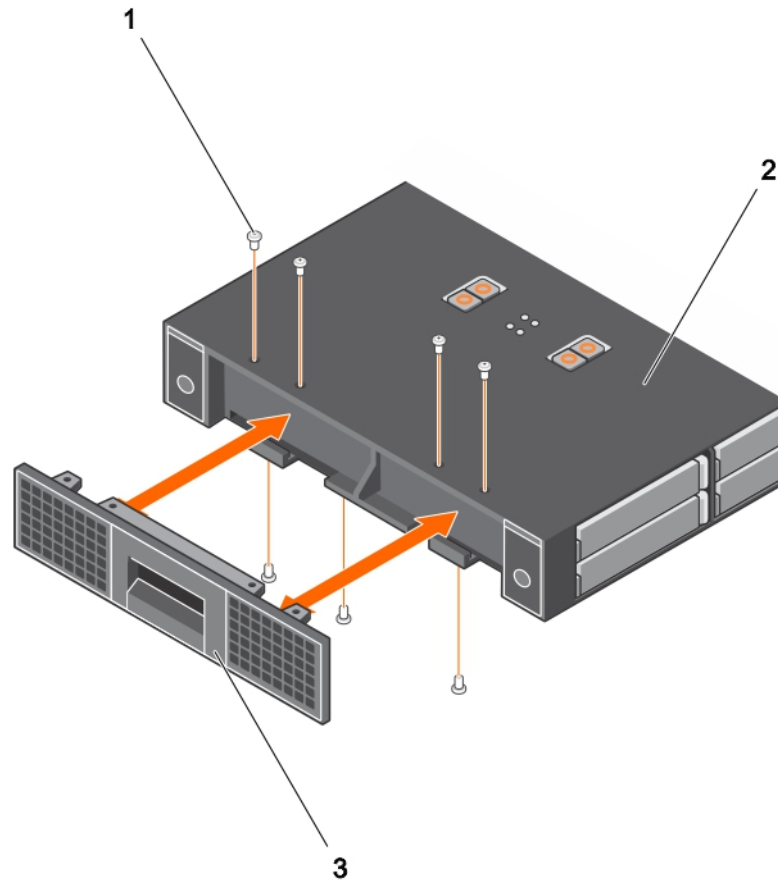

Figure 30. Removing and installing the bezel assembly

- 1 screw (7)
- 3 bezel assembly

2 top side of the sled

Next step

Install the bezel assembly.

Related links

[Installing the bezel assembly](#)

[Removing the Mini Enterprise Service Tag](#)

Installing the bezel assembly

Prerequisites

CAUTION: Many repairs may only be done by a certified service technician. You should only perform troubleshooting and simple repairs as authorized in your product documentation, or as directed by the online or telephone service and support team. Damage due to servicing that is not authorized by Dell is not covered by your warranty. Read and follow the safety instructions that came with the product.

CAUTION: To prevent damage to the storage sled locks, use a #2 Phillips screwdriver to turn the sled locks to lock or unlock positions.

NOTE: This is a field replaceable unit (FRU). Removal and installation procedures must be performed only by Dell certified service technicians.

- 1 Ensure that you read the [Safety instructions](#).
- 2 Follow the procedure listed in [Before working inside your system](#).
- 3 Keep the #2 Phillips screwdriver ready.
- 4 Remove the bezel assembly.

Steps

- 1 Turn the sled over with the bottom side of the sled facing up.
- 2 Align the bezel assembly with the sled front panel and push the assembly into the sled until it is fully seated.
- 3 Install the screws securing the bezel assembly to the bottom side of the sled.
- 4 Turn the sled over with the top side of the sled facing up.
- 5 Install the screws securing the bezel assembly to the top of the sled.
- 6 Close the drive drawer.
- 7 Using a #2 Phillips screwdriver, turn the sled locks to unlock position.
- 8 Align the service caution label and paste the label on top of the drive drawer.

Next steps

- 1 Install the Mini Enterprise Service Tag (MEST).
- 2 Follow the procedure listed in [After working inside your system](#).

Related links

[Removing the bezel assembly](#)

[Installing the Mini Enterprise Service Tag](#)

Troubleshooting your system

Safety first—for you and your system

CAUTION: Many repairs may only be done by a certified service technician. You should only perform troubleshooting and simple repairs as authorized in your product documentation, or as directed by the online or telephone service and support team. Damage due to servicing that is not authorized by Dell is not covered by your warranty. Read and follow the safety instructions that came with the product.

NOTE: For troubleshooting information on the PowerEdge FX2s enclosure components, see the *Dell PowerEdge FX2 and FX2s Enclosure Owner's Manual* at dell.com/poweredgemanuals. For information on troubleshooting the compute sled components, see the relevant compute sled Owner's Manual at dell.com/poweredgemanuals.

Topics:

- [Troubleshooting hard drives/SSDs](#)
- [Troubleshooting a storage controller module](#)
- [System messages](#)

Troubleshooting hard drives/SSDs

Prerequisites

CAUTION: Many repairs may only be done by a certified service technician. You should only perform troubleshooting and simple repairs as authorized in your product documentation, or as directed by the online or telephone service and support team. Damage due to servicing that is not authorized by Dell is not covered by your warranty. Read and follow the safety instructions that came with the product.

CAUTION: This procedure can destroy data stored on the hard drive/SSD. Before you proceed, back up all the files on the hard drive/SSD.

Steps

- 1 Run the appropriate controllers test and the hard drive/SSD tests in system diagnostics.
If the tests fail, go to step 3.
- 2 Take the hard drive/SSD offline, remove, and reseal the drive assembly in the sled drive slot.
- 3 Restart the sled, enter the System Setup and confirm that the drive controller is enabled.
- 4 Ensure that any required device drivers are installed and are configured correctly.

NOTE: Installing a hard drive/SSD into another bay may break the mirror if the mirror state is optimal.

- 5 Remove the hard drive/SSD assembly and install it in the other drive bay.
- 6 If the problem is resolved, reinstall the drive assembly in the original bay.
- 7 If the hard drive/SSD is the boot drive, ensure that the drive is configured and connected properly.
- 8 Partition and logically format the hard drive/SSD.
- 9 If possible, restore the files to the drive.
If the problem persists, see [Getting Help](#).

Related links

- [Hard drive/SSD indicators](#)
- [Removing a hard drive/SSD assembly](#)
- [Installing a hard drive/SSD assembly](#)

Troubleshooting a storage controller module

Prerequisites

⚠ CAUTION: Many repairs may only be done by a certified service technician. You should only perform troubleshooting and simple repairs as authorized in your product documentation, or as directed by the online or telephone service and support team. Damage due to servicing that is not authorized by Dell is not covered by your warranty. Read and follow the safety instructions that came with the product.

📌 NOTE: When troubleshooting the storage controller module, also see the documentation for your operating system and the controller module.

Steps

- 1 Open the drive drawer.
- 2 Check the storage controller module indicators. If the indicator blinks amber, it indicates a fault condition.
- 3 Turn off the compute sled to which the storage sled is mapped.
The storage sled also turns off.
- 4 Remove the storage sled from the enclosure.
- 5 Reseat the storage controller module, module cable, and the storage controller battery.
- 6 Install the storage sled in the enclosure.
- 7 If the storage controller module functions properly, close the drive drawer.
- 8 If the storage controller module does not function properly, log in to the CMC web interface and view the properties of the storage controller. For more information, see the CMC User's Guide at dell.com/esmmanuals.
If the problem is not resolved, see [Getting Help](#).

Related links

- [Storage Controller Module indicators](#)
- [Opening the drive drawer](#)
- [Closing the drive drawer](#)
- [Removing the storage controller module](#)
- [Installing the storage controller module](#)

System messages

For a list of event and error messages generated by the system firmware and agents that monitor system components, see the Dell Event and Error Messages Reference Guide at dell.com/esmmanuals.

Warning messages

A warning message alerts you to a possible problem and prompts you to respond before the system continues a task. For example, before you format a hard drive, a message warns you that you may lose all data on the hard drive. Warning messages usually interrupt the task and require you to respond by typing y (yes) or n (no).

📌 NOTE: Warning messages are generated by either the application or the operating system. For more information, see the documentation that accompanied the operating system or application.

Diagnostic messages

The system diagnostic utilities may issue messages if you run diagnostic tests on your system. For more information about system diagnostics, see [Using system diagnostics](#).

Alert messages

Systems management software generates alert messages for your system. Alert messages include information, status, warning, and failure messages for drive, temperature, fan, and power conditions. For more information, see the systems management software documentation.

Using system diagnostics

NOTE: You cannot run diagnostics tests on PowerEdge FD332. You must run system diagnostics from the compute sled(s) to which PowerEdge FD332 is mapped.

If you experience a problem with your system, run the system diagnostics before contacting Dell for technical assistance. The purpose of running system diagnostics is to test your system hardware without requiring additional equipment or risking data loss. If you are unable to fix the problem yourself, service and support personnel can use the diagnostics results to help you solve the problem.

Dell Embedded System Diagnostics

NOTE: You cannot run diagnostics tests on PowerEdge FD332. You must run system diagnostics from the compute sled(s) to which PowerEdge FD332 is mapped.

NOTE: The Dell Embedded System Diagnostics is also known as Enhanced Pre-boot System Assessment (ePSA) diagnostics.

The Embedded System Diagnostics provides a set of options for particular device groups or devices allowing you to:

- Run tests automatically or in an interactive mode
- Repeat tests
- Display or save test results
- Run thorough tests to introduce additional test options to provide extra information about the failed device(s)
- View status messages that inform you if tests are completed successfully
- View error messages that inform you of problems encountered during testing

When to use the Embedded System Diagnostics

If a major component or device in the system does not operate properly, running the Embedded System Diagnostics may indicate component failure.

Running the Embedded System Diagnostics from Boot Manager

- 1 As the system boots, press <F11>.
- 2 Use the up and down arrow keys to select **System Utilities > Launch Diagnostics**.

The **ePSA Pre-boot System Assessment** window is displayed, listing all devices detected in the system. The diagnostics starts executing the tests on all the detected devices.

Running the Embedded System Diagnostics from the Dell Lifecycle Controller

- 1 As the system boots, press <F11>.
- 2 Select **Hardware Diagnostics** → **Run Hardware Diagnostics**.
The **ePSA Pre-boot System Assessment** window is displayed, listing all devices detected in the system. The diagnostics starts executing the tests on all the detected devices.

Running Embedded System Diagnostics from an external media

- 1 Format the external resource media (USB flash drive or CD) to emulate a hard drive.
See the documentation that came with the resource media for instructions.
- 2 Configure the resource media to be a bootable device.
- 3 Create a directory for system diagnostics on the resource media.
- 4 Copy the system diagnostics files into the directory.
To download the Dell diagnostics utility, go to dell.com/support/drivers, select your product, and click **Get drivers and downloads** from the product page.
- 5 Connect the resource media to your system.
- 6 As the system boots, press <F11>.
- 7 When prompted, select the media to perform a one-time boot.
If diagnostics does not start automatically after the diagnostics media is booted, enter **psa** at the command prompt.

System diagnostics controls

Menu	Description
Configuration	Displays the configuration and status of all detected devices.
Results	Displays the results of all tests that are executed.
System health	Provides the current overview of the system performance.
Event log	Displays a time-stamped log of the results of all tests run on the system. This is displayed if at least one event description is recorded.

For information about Embedded System Diagnostics, see the *ePSA Diagnostics Guide (Notebooks, Desktops and Servers)* at dell.com/support/home.

Technical specifications—PowerEdge FD332

Physical

Width	21.09 cm (8.3 inch)
Height	4.01 cm (1.57 inch)
Depth	52.36 cm (20.61 inch)
Weight (maximum)	7.93 kg (17.48 lb)

Drives

Hard drives/SSDs	Up to sixteen 2.5-inch, hot swap SAS or SATA hard drives/SSDs
------------------	---

RAID Controller

Controller type	PERC FD33xS, PERC FD33xD
-----------------	--------------------------

HBA Controller

Controller type	HBA FD33xS, HBA FD33xD
-----------------	------------------------

Environmental specifications

NOTE: For additional information about environmental measurements for specific system configurations, see dell.com/environmental_datasheets.

Temperature

Storage	–40°C to 65°C (–40°F to 149°F)
Continuous operation (for altitude less than 950 m or 3117 ft)	10°C to 35°C (50°F to 95°F) with no direct sunlight on the equipment.
Maximum temperature gradient (operating and storage)	20°C/h (36°F/h)

Relative humidity

Storage	5% to 95% RH with 33°C (91°F) maximum dew point. Atmosphere must be non-condensing at all times.
Operating	10% to 80% Relative Humidity with 29°C (84.2°F) maximum dew point.

Maximum vibration

Operating	0.26 G _{rms} at 5 Hz to 350 Hz (all operation orientations).
Storage	1.88 G _{rms} at 10 Hz to 500 Hz for 15 min (all six sides tested).

Maximum shock

Operating	One shock pulse in the positive z axis of 31 G for 2.6 ms in the operational orientation.
-----------	---

Environmental specifications

Storage

Six consecutively executed shock pulses in the positive and negative x, y, and z axes (one pulse on each side of the system) of 71 G for up to 2 ms.

Maximum altitude

Operating

3048 m (10,000 ft).

Storage

12,000 m (39,370 ft).

Operating temperature de-rating

Up to 35 °C (95 °F)

Maximum temperature is reduced by 1°C/300 m (1°F/547 ft) above 950 m (3,117 ft).

Particulate contamination

NOTE: This section defines the limits to help avoid IT equipment damage and/or failure from particulates and gaseous contamination. If it is determined that levels of particulates or gaseous pollution are beyond the limits specified below and are the reason for the damage and/or failures to your equipment, it may be necessary for you to re-mediate the environmental conditions that are causing the damage and/or failures. Re-mediation of environmental conditions will be the responsibility of the customer.

Air filtration

Data center air filtration as defined by ISO Class 8 per ISO 14644-1 with a 95% upper confidence limit.

NOTE: Applies to data center environments only. Air filtration requirements do not apply to IT equipment designed to be used outside a data center, in environments such as an office or factory floor.

NOTE: Air entering the data center must have MERV11 or MERV13 filtration.

Conductive dust

Air must be free of conductive dust, zinc whiskers, or other conductive particles.

NOTE: Applies to data center and non-data center environments.

Corrosive dust

NOTE: Applies to data center and non-data center environments.

- Air must be free of corrosive dust.
- Residual dust present in the air must have a deliquescent point less than 60% relative humidity.

Gaseous contamination

NOTE: Maximum corrosive contaminant levels measured at ≤50% relative humidity.

Copper coupon corrosion rate

<300 Å/month per Class G1 as defined by ANSI/ISA71.04-1985.

Silver coupon corrosion rate

<200 Å/month as defined by AHSRAE TC9.9.

Getting help

Topics:

- [Contacting Dell](#)
- [Locating your system Service Tag](#)
- [Quick Resource Locator](#)

Contacting Dell

Dell provides several online and telephone-based support and service options. If you do not have an active Internet connection, you can find contact information on your purchase invoice, packing slip, bill, or Dell product catalog. Availability varies by country and product, and some services may not be available in your area. To contact Dell for sales, technical support, or customer-service issues:

- 1 Go to **dell.com/support**.
- 2 Select your country from the drop-down menu on the bottom right corner of the page.
- 3 For customized support:
 - a Enter your system Service Tag in the **Enter your Service Tag** field.
 - b Click **Submit**.The support page that lists the various support categories is displayed.
- 4 For general support:
 - a Select your product category.
 - b Select your product segment.
 - c Select your product.The support page that lists the various support categories is displayed.

Locating your system Service Tag

Your system is identified by a unique Express Service Code and Service Tag number. The Express Service Code and Service Tag are found on the front of the system by pulling out the information tag. Alternatively, the information may be on a sticker on the chassis of the system. This information is used by Dell to route support calls to the appropriate personnel.

Quick Resource Locator

Use the Quick Resource Locator (QRL) to get immediate access to system information and how-to videos. This can be done by visiting **dell.com/QRL** or by using your smartphone and a model specific Quick Resource (QR) code located on your Dell PowerEdge system. To try out the QR code, scan the following image.



Free Manuals Download Website

<http://myh66.com>

<http://usermanuals.us>

<http://www.somanuals.com>

<http://www.4manuals.cc>

<http://www.manual-lib.com>

<http://www.404manual.com>

<http://www.luxmanual.com>

<http://aubethermostatmanual.com>

Golf course search by state

<http://golfingnear.com>

Email search by domain

<http://emailbydomain.com>

Auto manuals search

<http://auto.somanuals.com>

TV manuals search

<http://tv.somanuals.com>