

Dell™ Venue  
User's Manual



# Notes, Cautions, and Warnings



**NOTE:** A NOTE indicates important information that helps you make better use of your smartphone.



**CAUTION:** A CAUTION indicates potential damage to hardware or loss of data if instructions are not followed.



**WARNING:** A WARNING indicates a potential for property damage, personal injury, or death.

-----  
**Information in this document is subject to change without notice.**

**© 2010 Dell Inc. All rights reserved.**

Reproduction of these materials in any manner whatsoever without the written permission of Dell Inc. is strictly forbidden.

Trademarks used in this text: Dell™ and the DELL logo are trademarks of Dell Inc.

Adobe Acrobat® is a trademark of Adobe Systems Incorporated which may be registered in certain jurisdictions; Microsoft®, Windows®, Excel®, and Powerpoint®, are either trademarks or registered trademarks of Microsoft Corporation in the United States and/or other countries; Bluetooth® is a registered trademark owned by Bluetooth SIG, Inc. and is used by Dell under license.

Other trademarks and trade names may be used in this document to refer to either the entities claiming the marks and names or their products. Dell Inc. disclaims any proprietary interest in trademarks and trade names other than its own.

**December 2010    A00**

## **Federal Communications Commission (FCC) Statement**

**This smartphone complies with Part 15 of the FCC Rules. Operation is subject to the following two conditions:**

- 1) this smartphone may not cause harmful interference and
- 2) this smartphone must accept any interference received, including interference that may cause undesired operation of the smartphone.

## **FCC RF Radiation Exposure Statement:**

For body worn operation, this smartphone has been tested and meets FCC RF exposure guidelines when used with an accessory that contains no metal and that positions the handset a minimum of 1.5 cm from the body. Use of other accessories may not ensure compliance with FCC RF exposure guidelines.

# Contents

1	Setting Up Your Dell Venue Smartphone . . . . .	6
	<b>Getting Your Smartphone Ready for Use . . . . .</b>	<b>6</b>
	<b>Turning On Your Smartphone . . . . .</b>	<b>11</b>
	<b>Turning Off Your Smartphone . . . . .</b>	<b>11</b>
	<b>Turning Off the Screen . . . . .</b>	<b>11</b>
2	Dell Venue Smartphone Features . . . . .	12
	<b>Touch Screen . . . . .</b>	<b>17</b>
	<b>Screen Orientation . . . . .</b>	<b>23</b>
	<b>Applications, Widgets, and Shortcuts . . . . .</b>	<b>23</b>
	<b>The Stage Desktop . . . . .</b>	<b>24</b>
	<b>Dell Stage Widgets . . . . .</b>	<b>27</b>
	<b>Status Bar . . . . .</b>	<b>38</b>
	<b>Quick Buttons . . . . .</b>	<b>41</b>
	<b>Navigating Applications . . . . .</b>	<b>42</b>
3	Using Your Dell Venue Smartphone . . . . .	44
	<b>Calling . . . . .</b>	<b>44</b>
	<b>Managing Contacts . . . . .</b>	<b>51</b>

	<b>Messaging</b> . . . . .	<b>55</b>
	<b>Pop-Up Menu</b> . . . . .	<b>61</b>
	<b>Android Keyboard</b> . . . . .	<b>62</b>
	<b>Swype Keyboard</b> . . . . .	<b>66</b>
	<b>Google Search Widget</b> . . . . .	<b>68</b>
	<b>Power Control Widget</b> . . . . .	<b>69</b>
	<b>Managing Your Smartphone Settings</b> . . . . .	<b>70</b>
<b>4</b>	<b>Internet</b> . . . . .	<b>72</b>
	<b>Connecting to the Internet</b> . . . . .	<b>72</b>
	<b>Browsing the Internet</b> . . . . .	<b>76</b>
	<b>E-mail</b> . . . . .	<b>83</b>
	<b>Web Applications</b> . . . . .	<b>85</b>
<b>5</b>	<b>Customizing Your Dell Venue Smartphone</b>	<b>120</b>
	<b>To change the display settings</b> . . . . .	<b>120</b>
	<b>To change sound and ringtone settings</b> . . . . .	<b>121</b>
	<b>To manually set the date, time and time zone</b> . . . . .	<b>123</b>
	<b>To set the language</b> . . . . .	<b>124</b>
<b>6</b>	<b>Protecting Your Dell Venue Smartphone</b> . . . . .	<b>125</b>
	<b>Protect Your Smartphone Data With a Screen Unlock Pattern</b> . . . . .	<b>125</b>

	<b>Protect Your Smartphone Data With a PIN</b> . . . . .	<b>128</b>
	<b>Protect Your Smartphone Data With a Password</b> . . . . .	<b>128</b>
	<b>Protect Your SIM Card With the SIM Lock Password</b> . . . . .	<b>129</b>
<b>7</b>	<b>Applications</b> . . . . .	<b>130</b>
	<b>Camera</b> . . . . .	<b>130</b>
	<b>Copying Files to and from the MicroSD</b> . . . . .	<b>135</b>
	<b>Bluetooth</b> . . . . .	<b>136</b>
	<b>Photos and Videos</b> . . . . .	<b>138</b>
	<b>Music</b> . . . . .	<b>141</b>
	<b>Calendar</b> . . . . .	<b>144</b>
	<b>Alarm Clock</b> . . . . .	<b>146</b>
	<b>Calculator</b> . . . . .	<b>148</b>
	<b>Sound Recorder</b> . . . . .	<b>148</b>
	<b>Voice Dialer</b> . . . . .	<b>149</b>
<b>8</b>	<b>Synchronizing Your Dell Venue Smartphone and Computer Using Dell Mobile Sync</b> . . . . .	<b>150</b>
<b>9</b>	<b>Troubleshooting</b> . . . . .	<b>152</b>

# 1 Setting Up Your Dell Venue Smartphone

## Getting Your Smartphone Ready for Use

### 1 Remove the back cover

a Slide the back cover down towards the bottom of the smartphone.

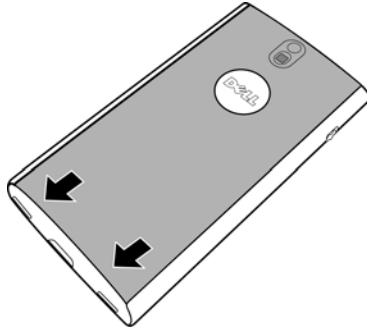



b Lift the back cover off the smartphone.

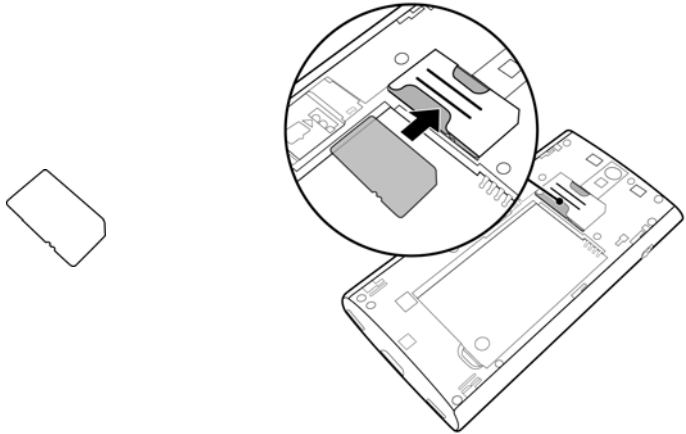

## 2 Insert the SIM card

Insert the SIM card in the illustrated direction under the metal plate that covers the SIM card holder.



 **NOTE:** If you have difficulty in inserting the SIM card, ensure that the angled corner of the SIM card is aligned with the angled corner of the SIM card holder.

## 3 Insert the battery

Align the metal contacts on the battery with the contacts on the battery holder and insert the battery.

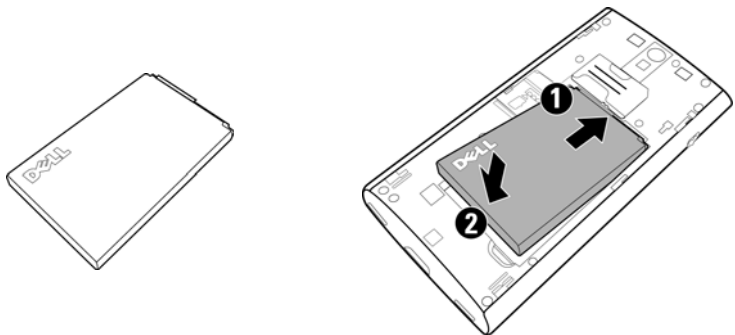

#### 4 Install the microSD card

a Hold the microSD card with the metal contacts facing down.



b Slide the microSD card into the microSD card holder.

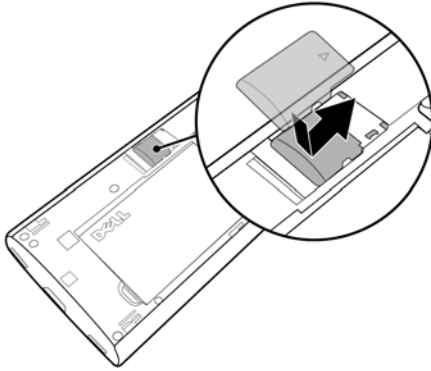



## 5 Close the back cover

- a Align the tabs on the back cover with the slots on back of the smartphone.

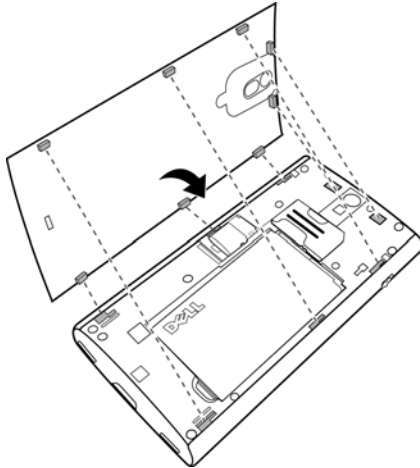

- b Place the cover onto the back of the smartphone, and then slide the cover towards the top of the smartphone to secure the cover in place.

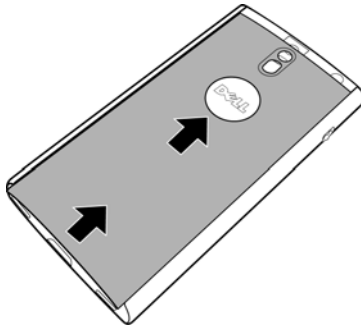



## 6 Charge the smartphone

 **NOTE:** Charge the battery in an environmental temperature between 0°C and 45°C.

The battery is not fully charged when first unpacked.

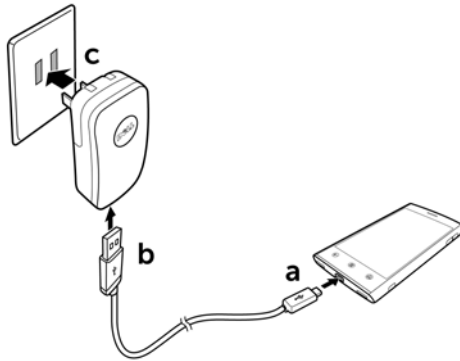
- a Plug the supplied USB cable's micro USB connector into the connector on the smartphone.
- b Plug the other end of the cable to the supplied USB wall charger plug.
- c Plug the USB wall charger plug into an electric outlet and charge the smartphone till the battery is fully charged.





 **NOTE:** The smartphone is fully charged within two hours when connected to a power outlet.

 **NOTE:** To charge your smartphone using a computer, connect the supplied USB cable's micro USB connector to the smartphone, and the other end of the cable to a USB connector on the computer.

 **NOTE:** The type of USB wall charger plug may vary depending on the country/region where you purchased the smartphone.

## Turning On Your Smartphone

 **NOTE:** Use this smartphone in an environmental temperature between -10°C and 55°C.

- 1 Press and hold the Power button to turn on your smartphone. The operating system starts up.
- 2 If the screen is locked automatically, flick the  icon right to unlock the screen.
- 3 If your SIM card is locked by a Personal Identification Number (PIN), type the PIN by touching the corresponding number keys using the on-screen keypad. Touch the **OK** button to confirm your input.
- 4 The smartphone is ready for use when the default Home screen is displayed.

## Turning Off Your Smartphone

- 1 Press and hold the Power button.
- 2 Touch the **Power off** option on the screen.

## Turning Off the Screen

If both the smartphone and the screen are on, press the Power button to turn off the screen.



 **NOTE:** If the smartphone is on, but the screen is off, press the Power button to turn on the screen.

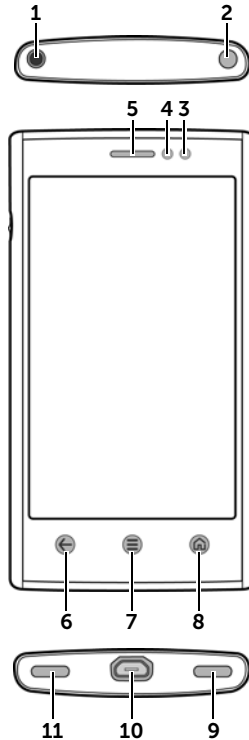

# 2 Dell Venue Smartphone Features

This section provides information about the features available on your Dell Venue smartphone.



Feature	Function(s)
1 Headphone connector	Connects to headphones.

Feature	Function(s)
2 Power and Sleep/Wake button	<ul style="list-style-type: none"> <li>• If the smartphone is off, press and hold to turn on the smartphone.</li> <li>• If the smartphone is on, but the screen is off, press to turn on the screen.</li> <li>• If both the smartphone and the screen are on, <ul style="list-style-type: none"> <li>– Press to turn off the screen.</li> <li>– Press and hold to select one of these options: <ul style="list-style-type: none"> <li><b>Silent mode:</b> The smartphone is set to vibrate mode; all sounds are disabled except for alarms.</li> <li><b>Airplane mode:</b> Select to disable all wireless connections.</li> <li><b>Power off:</b> Turn off the smartphone.</li> </ul> </li> </ul> </li> </ul>
3 Ambient light sensor (ALS)	<p>Controls screen brightness according to the surrounding lighting conditions.</p> <p><b>NOTE:</b> To enable the ambient light sensor, touch the Home button  → Menu button , and then select <b>Settings</b> → <b>Display</b> → <b>Brightness</b> → <b>Automatic brightness</b> → <b>OK</b>.</p>
4 Proximity sensor	<p>Automatically turns off screen as you bring the smartphone close to your face to make or receive a call, in order to prevent unintentional touch on the screen.</p>
5 Earpiece	<p>Use to listen to phone conversations.</p>
6 Back button 	<p>Touch to return to the previous screen, close a dialog box, menu, or pop-up message, and to dismiss the keyboard.</p>

Feature	Function(s)
7 Menu button 	Touch to open or close the pop-up menu that displays the available options for the current application or actions that you can perform on the current screen.
8 Home button 	<ul style="list-style-type: none"> <li>• Touch to return to the default Home screen.</li> <li>• Touch and hold: For quick access to the recently accessed applications.</li> </ul>
9 Microphone	Use for voice calls.
10 Micro USB connector	<ul style="list-style-type: none"> <li>• Connects to a USB cable to transfer files to a computer.</li> <li>• Connects to a charger to charge the smartphone.</li> </ul>
11 Speaker and speakerphone	Audio output for video and music playback.

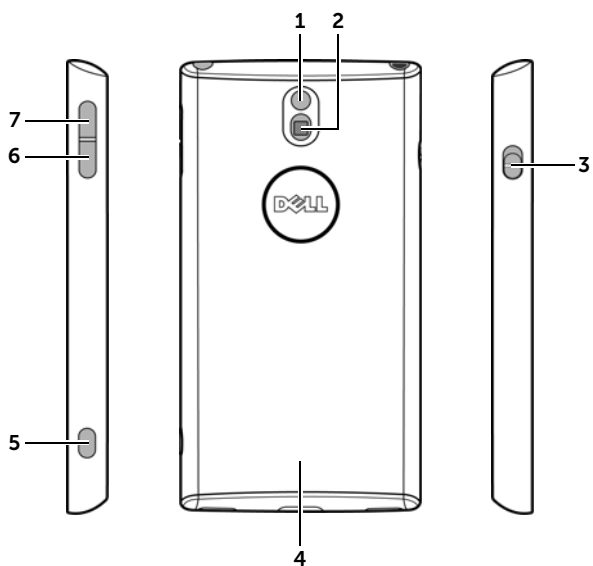

Feature	Function(s)
1 Camera lens	Captures photos and videos.
2 Camera flash	For using while capturing photos and videos.
3 Ring/Silent switch	Switches between ring and silent modes. <ul style="list-style-type: none"> <li>Slide the switch upward to enable silent mode. The  icon appears in the status area.</li> <li>Slide the switch downward to enable ring mode.</li> </ul>
4 Back cover	Secures the battery in place.

Feature	Function(s)
5 Camera button	<ul style="list-style-type: none"> <li>• If the camera is not active, press and hold to start the camera.</li> <li>• If the camera is active, half press to focus the camera.</li> <li>• If the camera is active, press to capture a photo or record a video.</li> <li>• When recording a video, press to stop.</li> </ul>
6 Volume down button	<ul style="list-style-type: none"> <li>• While playing media such as music tracks or video clips: <ul style="list-style-type: none"> <li>– Press to decrease the media volume by one level.</li> <li>– Press and hold to continuously decrease the media volume.</li> </ul> </li> <li>• Press to mute the ringer while receiving a call.</li> <li>• In all other situations: <ul style="list-style-type: none"> <li>– Press to decrease the ringer volume by one level.</li> <li>– Press and hold to continuously decrease the ringer volume.</li> </ul> </li> </ul>
7 Volume up button	<ul style="list-style-type: none"> <li>• While playing media such as music tracks or video clips: <ul style="list-style-type: none"> <li>– Press to increase the media volume by one level.</li> <li>– Press and hold to continuously increase the media volume.</li> </ul> </li> <li>• Press to mute the ringer while receiving a call.</li> <li>• In all other situations: <ul style="list-style-type: none"> <li>– Press to increase the ringer volume by one level.</li> <li>– Press and hold to continuously increase the ringer volume.</li> </ul> </li> </ul>



# Touch Screen

Your smartphone has a multi-touch sensitive screen. You can touch the surface of the screen to operate the smartphone.

---

## Finger Gestures

---

## Allows you to:

---

### Touch

Touch gently on the screen with your fingertip.



- Select the items on the screen including options, entries, images, and icons.
- Start applications.
- Press the buttons on the screen.
- Input text using the on-screen keyboard or numeric keypad.

---

**Finger Gestures**

---

**Allows you to:****Touch and hold**

Touch and hold your finger on the screen.

Move an item on a Home screen, except for the HOME Stage widget.



---

**Finger Gestures**

---

**Allows you to:**

---

**Drag**

- 1 Touch and hold your finger on an item on the screen.
  - 2 Keeping your finger in contact with the screen, move your fingertip to the desired location.
  - 3 Take your finger off the screen to drop the item in the desired location.
- Move items such as images and icons on the screen.
  - Open/close the application drawer:
    - From any of the desktop Home screens, drag up in the lower area of the screen to open the application drawer.
    - To close the application drawer, drag down anywhere within the application drawer.



---

**Finger Gestures**

---

**Allows you to:**

---

**Flick or swipe**

Move your finger in a vertical or horizontal direction on the screen.

Scroll through Home screens, web pages, lists, entries, photo thumbnails, contacts, and so on.



---

**Finger Gestures**

---

**Allows you to:**

---

**Zoom out**

Move two fingers close together on the screen.

Reduce the view of an image or web page.

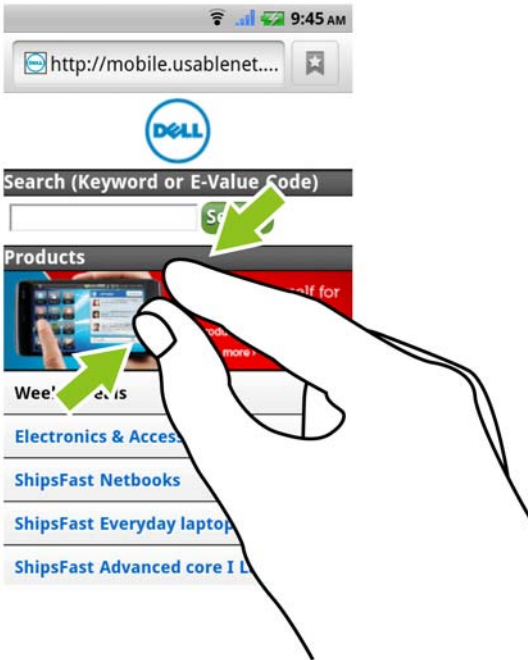

---

**Finger Gestures**

---

**Allows you to:****Zoom in**

Move two fingers apart on the screen.



Enlarge the view of an image or web page.



# Screen Orientation

For optimal viewing experience, the screen orientation changes automatically to portrait or landscape format depending on how you hold the smartphone.

 **NOTE:** The Home screens are always displayed in portrait format and does not automatically orient to landscape format. Applications downloaded from the Android Market may not support automatic screen orientation to landscape or portrait format.

 **NOTE:** To modify the default behavior, open the orientation settings by touching the Home button  → Menu button  → **Settings** → **Display** → **Auto-rotate screen**.

# Applications, Widgets, and Shortcuts

**Application** - Software which allows you to perform a specific task. Your smartphone is preloaded with a variety of applications, and additional applications can be downloaded from the Android Market.

**Widget** - A small application which resides on a Home screen and provides quick and easy access to information.



**Shortcut** - A link that you can add on a Home screen to provide quicker access to an application or a folder containing contacts or bookmarks.

# The Stage Desktop

As part of the new Dell Stage interface, the Stage desktop is composed of seven individual screens including the HOME screen. The desktop displays predefined Stage widgets, shortcuts, and widgets to give you quick and easy access to frequently-used applications, Twitter or Facebook postings, music, pictures, and more.

You can customize the Stage desktop to your personal preferences by adding your own shortcuts or widgets, or by displaying your favorite picture as the desktop wallpaper.

 **NOTE:** For more information on using Dell Stage widgets, see "Dell Stage Widgets" on page 27.

 **NOTE:** To return to the Home screen from anywhere, touch the Home screen button .

## To navigate across the desktop

Flick the desktop horizontally until the desired Home screen is displayed.





## To control the Home screens using Home screen thumbnails

The Home screen thumbnails work as shortcuts to their individual Home screens. The icon of the thumbnail will change to represent the Stage widget displayed on the Home screen.

- To bring up the Home screen thumbnails:



---

**1** Touch the bottom area on either side of the quick buttons, as illustrated in red.

---

**2** Touch and hold the Launcher button  to display the thumbnails.

---

- To control the Home screens using the thumbnails, either:
  - Touch the corresponding thumbnail to go to the desired screen.



— Home screen thumbnails

- To quickly pan through the Home screens, drag your finger horizontally across the shortcuts, until the desired Home screen appears.



# Dell Stage Widgets

Dell Stage widgets are designed to provide you direct access to your recently-used applications, e-mails, photos, music, videos, contacts, Facebook & Twitter applications, and frequently-used websites.

Touching the label of any Stage Widget opens the supporting application to it's default screen. For example, touching the label of the **MUSIC** widget opens up the **Music** player just as it would by touching the **Music** icon in the application drawer.

You can use the free Home screens to add the other Stage widgets. The following are the available Dell Stage widgets:

- HOME (see "Using the CONTACTS Stage widget" on page 28.)
- CONTACTS (see "Using the CONTACTS Stage widget" on page 28.)
- EMAIL (see "Using the EMAIL Stage widget" on page 29.)
- GALLERY (see "Using the GALLERY Stage widget" on page 30.)
- MUSIC (see "Using the MUSIC Stage widget" on page 31.)
- SOCIAL (see "Using the SOCIAL Stage widget" on page 32.)
- WEB (see "Using the WEB Stage widget" on page 32.)

## Adding a Stage Widget

- 1 Navigate to a free Home screen.
- 2 Touch and hold on the Home screen until the **Add to Home screen** menu appears.
- 3 Touch **Stage Widgets**.
- 4 From the **Select Stage Widget** menu, touch to select Stage widget you want to add to the Home screen.

## Deleting a Stage Widget

To delete a Stage widget, touch and hold the Stage widget, and then drag it to the  icon that appears at the bottom of the screen. When the Stage widget turns red, release your finger from the screen.

## Using Stage Widgets

### Using the HOME Stage widget

From the **HOME** Stage widget, you can view the weather information of your current location, use Android Market and Google Search, and also touch application shortcuts to access your most recently-used applications.



### Using the CONTACTS Stage widget

From the **CONTACTS** Stage widget, you can view your favorite contacts, or add a new contact quickly.

- Touch a favorite contact to select the action to proceed with.

- Touch **ADD** to go to your address book to add a new contact. Refer to "To add a new contact" on page 51 for instructions on adding contacts. Designate your contact as a Favorite to see it in the Stage **CONTACTS** Widget.



### Using the EMAIL Stage widget

From the **EMAIL** Stage widget, you can read the e-mail messages in your e-mail account or compose a new message. If you have not set up an e-mail account, touch **Add an Account** and follow the instructions on the screen to complete your e-mail configuration.

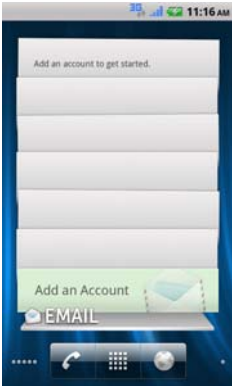

### Using the GALLERY Stage widget

- From the **GALLERY** Stage widget, you can view thumbnails of your image and video files in the Gallery application. Touch to open an image or a video file.
- Touch the camera in the lower right to take a new picture or video.

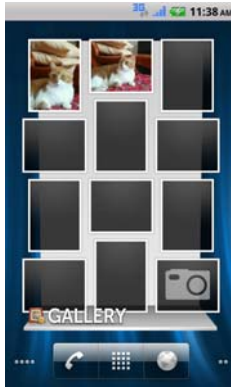

## Using the MUSIC Stage widget

From the **MUSIC** Stage widget, you can view the music albums or playlists created on your smartphone, and also can quickly open the Amazon MP3 application where available.

 **NOTE:** Amazon MP3 is not available in all areas.

- Touch a music album to browse the songs available. Touch a song to start playback.
- Touch a playlist to view the playlist you created. Touch a song to start playback.
- Touch Amazon MP3 to open the application.



### Using the SOCIAL Stage widget

The **SOCIAL** Stage widget provides shortcuts to Facebook and Twitter applications.

 **NOTE:** The **SOCIAL** Stage Widget displays either Facebook or Twitter. If you want to display both applications on the Home screen, add another **SOCIAL** widget to a different screen and sign in to the appropriate service there.



### Using the WEB Stage widget

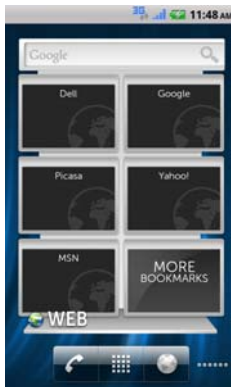

The **WEB** Stage widget displays your website bookmarks. Touch the website you want to visit, or touch **MORE BOOKMARKS** to select a website you want to visit.







# Customizing Your Home Screens



## To add an item to a Home screen

- 1 Touch the Home button .
- 2 To access the **Add to Home screen** menu, either:
  - Touch and hold an empty area on a home screen. The **Add to Home screen** menu appears.
  - Touch the Menu button  and then touch the **Add** option. The **Add to Home screen** menu appears.
- 3 Touch the item you want to add on the Home screen:

Items	Steps
<b>Shortcuts</b> Add shortcuts for items that you want to access directly from the Home screen.	<b>Applications:</b> <ol style="list-style-type: none"><li>1 Flick the application menu to locate the desired application.</li><li>2 Touch the desired application to create the shortcut on the current Home screen.</li></ol> <b>Bookmark:</b> <ol style="list-style-type: none"><li>1 Flick the <b>Bookmarks</b> list to locate the desired bookmark.</li><li>2 Touch the desired bookmark to create the shortcut on the current Home screen.</li></ol> <b>Contact:</b> <ol style="list-style-type: none"><li>1 Flick the Contacts entries to locate the desired contact.</li><li>2 Touch the desired contact to create the shortcut on the current Home screen.</li></ol> <b>Direct dial:</b> <p>Touch the desired phone number to create the shortcut on the Home screen. You can touch the shortcut to dial the number directly.</p> <b>Direct message:</b> <p>Touch the desired phone number to create the shortcut on the Home screen. You can touch the shortcut to compose and send a message to the number.</p>

Items	Steps
Shortcuts	<p><b>Directions &amp; Navigation:</b> Create a shortcut that you can touch to open Google Maps and view directions to a location.</p> <ol style="list-style-type: none"> <li>1 Type your destination in the <b>Destination</b> field.</li> <li>2 Choose how you want to get to your destination by touching the By car , By public transit , or Walking  icon (from left to right).</li> <li>3 Type a name for the shortcut.</li> <li>4 Touch the shortcut icon that you want to use for the shortcut.</li> <li>5 Touch the <b>Save</b> button.</li> </ol> <p><b>NOTE:</b> For more information on getting directions using Google Maps, see "To get directions" on page 99.</p> <p><b>Latitude:</b> Create a shortcut that you can touch to open Google Latitude to share locations with your friends and family who have signed in to the service with their Google accounts.</p> <p><b>Music playlist:</b> Create a <b>Play all</b> or a <b>Recently added</b> shortcut that you can touch to play all songs or recently added songs.</p> <p><b>Settings:</b></p> <ol style="list-style-type: none"> <li>1 Scroll through the settings to locate the desired setting.</li> <li>2 Touch the desired setting to create the shortcut on the current Home screen.</li> </ol>

Items	Steps
<b>Widgets</b>	<ol style="list-style-type: none"> <li>1 Touch and hold an empty area on a Home screen.</li> <li>2 Touch <b>Widgets</b> in the <b>Add to Home screen</b> menu that appears.</li> <li>3 Flick the available applications or services to locate the desired one.</li> <li>4 Touch the desired widget to add it on the Home screen.</li> </ol>
<b>Folders</b>	Touch the desired folder to create a folder on the Home screen.
You can create the following folders:	Once the folder is on your Home screen, you can drag and drop an item on top of the folder in order to add it to the folder.
<b>New folder:</b> Add a folder where you can store your Home screen shortcuts.	
<b>All contacts:</b> Add a shortcut to all your contacts stored in the Contacts application.	
<b>Bluetooth received:</b> Add a shortcut to access files received through Bluetooth.	
<b>Contacts with phone numbers:</b> Add a shortcut to the contacts with phone numbers.	
<b>Starred contacts:</b> Add a shortcut to the contacts marked with a star.	

Items	Steps
<p><b>Wallpapers</b></p> <p>Change the wallpaper of your Home screen.</p> <p><b>NOTE:</b> You can also touch the Home button  → the Menu button  → <b>Wallpaper</b> to change your Home screen wallpaper.</p>	<p><b>Gallery:</b> Open the Gallery application and select a saved picture as a wallpaper, or touch  to open the camera application and capture a picture that you can set as a wallpaper.</p> <ol style="list-style-type: none"> <li>1 Touch a picture category from your collection, such as <b>Camera, bluetooth,</b> and so on.</li> <li>2 Flick the picture thumbnails horizontally to locate the desired picture.</li> <li>3 Touch the picture to display it.</li> <li>4 To cut a portion of the picture as the wallpaper, move the crop frame and drag the angles to locate the desired part.</li> <li>5 Touch the <b>Save</b> button to set the wallpaper.</li> </ol> <p><b>Live wallpapers:</b> Select an animated and interactive wallpaper.</p> <p><b>Wallpapers:</b> Flick to or touch a picture thumbnail to display a picture, then touch <b>Set wallpaper</b> to set it as a wallpaper.</p>

To add an application shortcut to a Home screen:

- 1 Touch the Launcher button  at the bottom of the screen to enter the main applications view.
- 2 On the main applications view, touch and hold a desired application and drag it onto the current Home screen. The application's icon appears on the Home screen.

### To move a Home screen item

- 1 Touch and hold the item you want to reposition until it magnifies and becomes movable. The smartphone vibrates to indicate that the item's moving mode is activated.



**NOTE:** To disable the item's moving mode, release the item.

- 2 With your finger remaining in contact with the item on the screen, drag the item to another location on the screen.
- 3 Release the item in the desired location.

#### **To remove a Home screen item**

- 1 Touch and hold an item such as a widget, shortcut, or folder that you want to remove, until it magnifies and becomes movable.
- 2 Drag it to the Trash icon  that appears at the bottom of the screen.

#### **To open a Home screen folder**

- 1 Touch the folder to open the panel displaying the contents of the folder.
- 2 Touch the desired application shortcut to run the application.

#### **To close a Home screen folder**

Touch the Close icon  to close the panel.

#### **To move a Home screen shortcut into a folder**

- 1 Touch and hold a shortcut to make it movable.
- 2 Drag and drop the shortcut into a folder on the Home screen.



**NOTE:** Widgets and folders cannot be moved inside a folder.

#### **To remove a Home screen shortcut from a folder**

- 1 Touch a folder on the Home screen to view the contents.
- 2 Touch and hold a shortcut to make it movable.
- 3 Drag the shortcut in the folder to the Trash icon  that appears at the bottom of the screen.

### To rename a folder

- 1 Touch the folder you want to rename. A panel displaying the contents of the folder appears.
- 2 Touch and hold the top area of the folder panel  
, until the **Rename folder** menu pops up.
- 3 Touch the Folder name input field to type the name using the on-screen keyboard.
- 4 Touch **OK** to confirm.





























## Status Bar

The status bar at the top of the Home screen displays the notification, status, and time areas.

























<b>1</b> Notification area	<ul style="list-style-type: none"><li>• The notification area displays notification icons to inform you of missed calls, new e-mail, messages, and so on.</li><li>• Touch and drag the status bar down to view the notifications listed the order of arrival time, and then touch a notification to view the desired message, e-mail, or missed call record.</li></ul>
<b>2</b> Status area	<ul style="list-style-type: none"><li>• Displays status icons to show the current state of your smartphone, such as battery power, charging progress, alarms set, network connections, and so on.</li><li>• Touch and drag the status bar down to view the information regarding the carrier currently in use, remaining battery charge, and so on.</li></ul>
<b>3</b> Time area	Displays the current time.

**The status area may also display some of the following icons:**

 Alarm is set	 3G data network is connected
 Battery status — 100% full	 3G data network is in use
 Battery is low and needs to be charged	 GPRS data network is connected
 Battery is extremely low and needs to be charged immediately	 GPRS data network is in use
 Battery is charging	 EDGE data network is connected
 Vibrate mode is enabled	 EDGE data network is in use
 Silent mode is enabled	 HSPA data network is connected (only available for carrier-specific versions)
 Microphone is on mute	 HSPA data network is in use (only available for carrier-specific versions)
 Speakerphone is on	 Roaming signal strength — strong
 Signal strength — strong	 Connected to a Wi-Fi network
 No signal	 No SIM card is inserted
 Airplane mode is enabled	 GPS satellites function is enabled
 Bluetooth is enabled	 Receiving location data from GPS satellites
 Connected to a new Bluetooth device	 Ongoing data synchronization

**The notification area may also display some of the following icons:**

 Missed call	 New e-mail message
 Call in progress	 Problem with sign-in or sync
 Call on hold	 MicroSD card is full
 Call forwarding is enabled	 A Wi-Fi network is found
 Call in progress using a Bluetooth headset	 USB cable is connected
 New Gmail message	 Some notifications not displayed
 New SMS/MMS	 Song is playing
 Problem with SMS/MMS delivery	 Download in progress
 New Google Talk message	 Download finished
 New voicemail	 Application update available
 Upcoming calendar event	 The MicroSD card is safe to remove



# Quick Buttons

The quick buttons at the bottom of the Home screen allow you to access the application menu and some main functions quickly.

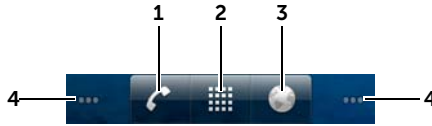

---

## 1 Phone button





Touch the Phone button  to open the **Phone** application to make calls.

---

## 2 Launcher button



- Touch the Launcher button  to display the applications menu:
    - The applications menu contains all of the applications on your smartphone, including those you have downloaded from the Android Market.
    - Touch an application to launch it.
  - Touch and hold the Launcher button  to display thumbnails of the Home screens.
- 

## 3 Browser button



Touch the Browser button  to open the **Browser** application.

---

## 4 Dots

The panoramic Home screen is made up of seven individual screens. Small dots at the lower left and right of the screen indicate which Home screen you are viewing.

---



# Navigating Applications

You can find applications available on your smartphone in these screen elements:

## Application Drawer

The application drawer can be accessed from any home screen and contains all of the applications installed on the smartphone, including those you have downloaded from the Android Market.



### To open the application drawer

- 1 Touch the Home button  to display the default Home screen on the desktop.
- 2 From any of the desktop Home screens, you can:
  - Drag up in the lower area of the screen.
  - Touch the Launcher button .

### To navigate pages of applications

Flick the applications drawer horizontally and touch an application to run it.

### To close the application drawer

- Drag down anywhere within the application drawer.
- To return to the default Home screen, touch .
- To return to the current Home screen, touch .

## Application Shortcuts

To quickly launch applications on the Home screen, you can add shortcuts for frequently-used applications to a Home screen or to the folder that you created on a Home screen. For more information, see "Customizing Your Home Screens" on page 33.

### **To open an application using the application shortcuts**

- 1 Touch the Home button .
- 2 If the desired application shortcut is displayed on the Home screen, touch the shortcut to launch the application.  
If the desired application is stored in a folder on the Home screen, touch the folder to display the contents of the folder, and then touch the desired application shortcut.

### **Recent Applications**

#### **To open a recently used application**



- 1 Touch and hold the Home button  to view the recently used applications.
- 2 Touch the desired application shortcut to launch the application.

# 3 Using Your Dell Venue Smartphone

## Calling





### Making Calls

To make calls, you can perform either of the following:

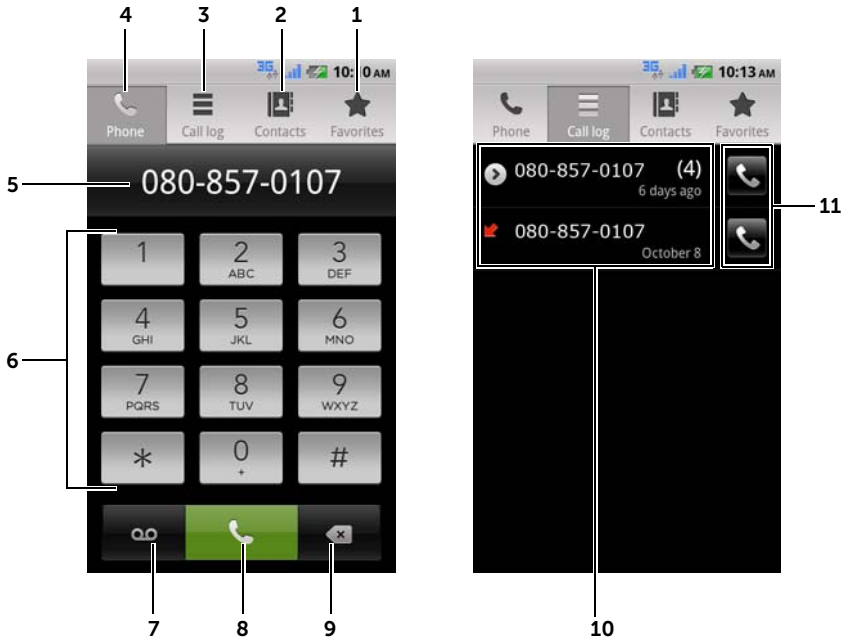
- Touch the Phone button  on the Home screen to open the Phone application quickly.
- Touch the Launcher button  to open the applications menu and flick the screen horizontally to touch **Phone**  on the applications menu to open the Phone application.

## To make a call



- 1 Touch to select a contact from your Favorites contact list. Touch a contact and then touch  to call or touch  to send a text message to the contact.
- 2 Touch to select a contact from your Contacts list. Touch a contact and then touch  to call or touch  to send a text message to the contact.
- 3 Touch to view the call log, call or text message the caller, or save or view the caller in Contacts.  
**NOTE:** To erase all calls from the call log, touch the Menu button  → **Clear call log** → **OK**.
- 4 Touch to open the on-screen dialpad.
- 5
  - Touch to bring up the numeric keypad or move the cursor.
  - Touch and hold to bring up the Edit text pop-up menu.
- 6 Type the number to call using the on-screen dialpad.

---

7 Touch to call your voicemail box.

**NOTE:** If no voicemail number is stored on your SIM card, you will be prompted to enter a number. Touch **Add number** to enter and save your voicemail number.

---

8 Touch to call the typed number.

---

9 Touch to clear an incorrect number.

---

10 Touch a call record to view the call information, call or send a message to the caller, or save or view the caller in Contacts. For more information on using Contacts, see "Managing Contacts" on page 51.

---

11 Touch to call a desired phone number or contact from the call log.

---

### To call a number with an extension

- 1 Type the number to call using the on-screen dialpad.
- 2 Touch and hold the asterisk key on the dialpad until "," appears.
- 3 Type the extension.
- 4 Touch  to make the call.

### To make an international call

- 1 Touch and hold the number 0 key on the dialpad until "+" appears.
- 2 Enter the country code, area code, and phone number.
- 3 Touch  to make the call.

### To listen to your voicemail

Touch and hold the number 1 key on the dialpad to call your voicemail box.



**NOTE:** If no voicemail number is stored on your SIM card, you will be prompted to enter a number. Touch **Add number** to enter and save your voicemail number.

## To answer or reject an incoming call

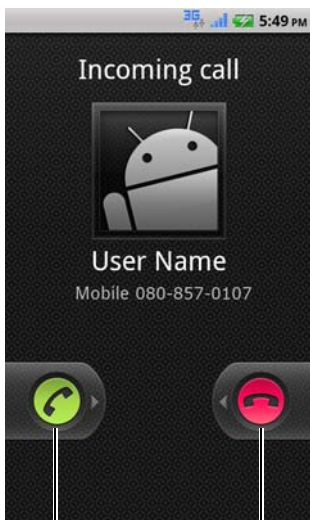

1

2

---

1

Drag right  to answer an incoming call.

---





2

Drag left  to reject an incoming call.

---

## Controls during a call



- 
- 1**
- Touch to hold an active call. To resume a held call, touch .
  - Touch  to swap between active and held calls.
- 
- 2**
- Touch  to bring up the dialpad and make another call. The first call is placed on hold automatically.
  - Touch  to connect the active and held calls to have a conference call.
- 
- 3**
- Touch to accept calls using a Bluetooth headset when a Bluetooth headset is connected to your smartphone. For information on connecting a Bluetooth headset to your smartphone, see "Bluetooth" on page 136.
- 
- 4**
- Touch to mute the microphone during a call.
-



---

5 Touch to turn the speaker on or off.



**WARNING:** Ensure that you turn off the speaker before you hold the smartphone close to your ear as this could damage your hearing.

---

6 Touch to open the dialpad for dialing.



---

7 Touch to end an active call or cancel dialing.

---

## Adjust Call Settings

You can change call settings to suit your personal needs, or enable the call services available from your network service provider.

Touch the Home button  → Menu button , and then select **Settings** → **Call settings**.

---

**Fixed Dialing Numbers (FDN)** Restricts outgoing calls to the phone numbers on the FDN list. To enable this service, you need to enter your SIM card's PIN2 that you can obtain from your network service provider.

---

### **Voicemail**

- **Voicemail service:** Displays the name of your carrier.
  - **Voicemail settings:** Stores another voicemail number other than the one already on your SIM card.
-

---

## Other call settings

- **Call forwarding:** Diverts incoming calls to a designated phone number when your phone is busy, unreachable, does not answer, or if you want to always forward calls.

To enable call forwarding, enter the number to divert to or touch  to select a contact from your Contacts list, and then touch **Enable**.

**NOTE:** Your smartphone can use Call forwarding only if the Call forwarding function is supported by your network service provider.

- **Call barring:** Blocks certain types of incoming or outgoing calls.

- **Additional settings:**

– **Caller ID:** Shows the caller ID or number on the screen based on the setting.

**NOTE:** Your smartphone displays the caller ID only if the caller ID function is supported by your network service provider.

– **Call waiting:** Alerts an incoming call with a call waiting tone or message when you are on another call.

**NOTE:** To use call waiting, you may need to register this service with your service provider.



- **Auto Answer:** Sets the duration your phone waits before automatically answering an incoming call.
- **TTY mode:** Enable Teletypewriter (TTY) mode to let the user with speech or hearing disabilities have a phone conversation by typing.
- **Hearing aids:** Enable Hearing Aid Compatible (HAC) mode to minimize interference from the smartphone with the user's hearing aid, and optimize audio output for the hearing aid.

**NOTE:** Enabling the HAC mode disables the Bluetooth and Wi-Fi transmitter functions.

---

# Managing Contacts

To view and manage your contacts, touch **Contacts**  or touch

**Phone**  → **Contacts**  .

## To add a new contact

Touch the Menu button  → **New contact** → Create contact under account.

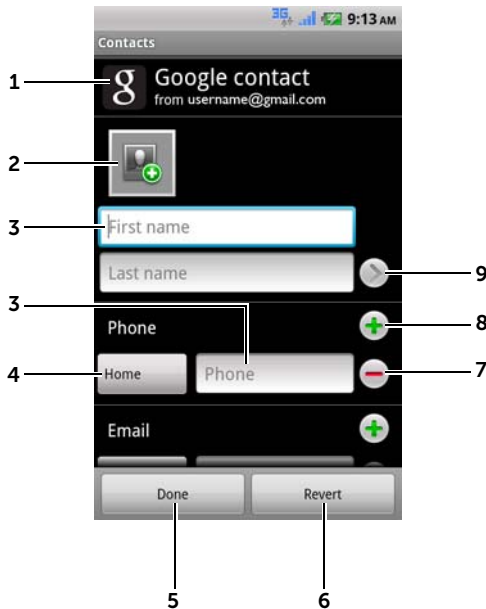

- 1 This area shows the account in which the new contact is stored.
- 2 Touch to capture a photo or select a photo from the **Gallery** application to use as the contact's visual caller ID.
- 3 Enter the contact information using the on-screen keyboard. Scroll the screen to find more items to fill.
- 4 Touch to replace a default information label with another one that you choose from the **Select label** list, for example from **Mobile** phone number to **Home** phone number.

- 
- 5 Touch to save the new contact to your Contacts list.

---

  - 6 Touch to return to your Contacts list.

---

  - 7 Touch to remove an item from the current information category.

---

  - 8 Touch to add a new item to the current information category, for example a second phone number.

---

  - 9 Touch to fill more name information.

---

### To find a contact

- 1 To find a contact, you can either:
  - Flick the Contacts list until you find the contact.
  - Touch the Menu button  → **Search**, and then type either the contact's full name or only the first letters of it into the **Search contacts** text field. The screen displays the matching contacts.
- 2 Once the contact is found, touch the contact's entry to view the contact's details.

### To call, e-mail, or send a message to a contact

- From the Contacts list, select a desired contact.

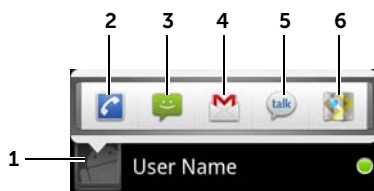

- 
- 1 Touch to see the actions that you can do with the contact.

---

  - 2 Touch to call the contact.

---

  - 3 Touch to text message the contact.

---

  - 4 Touch to e-mail the contact using Gmail.

---

  - 5 Touch to start an instant messaging chat on Google Talk

---

  - 6 Touch to view the contact's address using Google Maps.

---

- When viewing the contact details:





---

**1** Touch an action you want to do with the contact.

---

**2** Touch to add the current contact to your **Favorites** list.

---





**3** Touch the Menu button  to edit the contact details or share the contact information with your friends through e-mail. To designate a ringtone for the contact's incoming calls, or to allow your smartphone to automatically send the contact's calls to your voicemail box, touch **Options**.

---

 **NOTE:** For information about composing and sending SMS and MMS, see "Messaging" on page 55. To find out how to start an instant messaging chat on Google Talk, see "Google Talk" on page 88. For information about using the e-mail applications, see "Gmail" on page 85 and "E-mail" on page 83.

## Contacts settings

To see the contact settings, you can either:

- Touch **Contacts**  on the home screen, and then touch the Menu button .
- Touch **Phone**  → **Contacts**  and then touch the Menu button .

---

**Display options** Choose from which accounts you want to display the contacts, or set your smartphone to only display the contacts who have phone numbers.

---

**Accounts** Contacts stored on your smartphone can be synchronized with a computer using Dell Mobile Sync; contacts stored on your personal e-mail account like Gmail can be synchronized through an Internet connection.



### To select the data to synchronize:

- 1 Select **Background data** to make all the sync options available.
- 2 Select **Auto-sync** to let the smartphone automatically synchronize the selected data in your e-mail account.

### To select the data to sync from your e-mail account:

- 1 Touch your e-mail account to open the data list.
- 2 Select the data that you want the smartphone to synchronize automatically: **Sync Picasa Web Albums, Sync Contacts, Sync Calendar, and/or Sync Gmail.**

**NOTE:** If you want to synchronize individual data manually, clear **Auto-sync**, and then from your account, touch a data item to start synchronization of that data.

**NOTE:** While data is syncing, the sync icon  appears on the status bar, and the sync icon  appears on the option of the data being synced.



---

**Import/Export**

You can import contacts from your SIM/microSD card to your phone, export contacts from your phone to your microSD card, or share visible contacts using Bluetooth or Gmail.

---

## Messaging



To compose, send, and read text (SMS) or multimedia (MMS) messages, touch the Launcher button  → **Messaging** . The Messaging screen opens with a list of messages or message threads representing all the received, sent, and draft messages.

 **NOTE:** For information about the message thread, see "Receiving text and multimedia messages" on page 59.

### To compose and send a text message

- 1 On the Messaging screen, touch the **New message** thread. The compose screen opens.
- 2 In the **To** field, type the mobile phone number or the contact name of the recipient. As you type a phone number or contact name, matching contacts with their mobile numbers appear below the **To** field. Touch a matched contact to enter the contact's mobile number, or continue typing the desired phone number.

 **NOTE:** Repeat step 2 to enter more mobile numbers if you want to send the message to multiple recipients. You need to enter ";" for a second number.

 **NOTE:** To add a subject line to the message by touching the Menu button  → **Add subject**.

 **NOTE:** When adding a subject, the message automatically changes to MMS format.



- 3 Touch the **Type to compose** text field to start composing your message.
- 4 Touch the **Send** button to send the text message.

- 5 To start a text conversation similar to online instant messaging, you can continue to compose and send messages to the same recipient(s). All of the sent and received messages between you and recipient(s) appear in the form of chat logs.

### To compose and send a multimedia message

- 1 In the **To** field, type the recipient's mobile phone number, e-mail address, or contact name. Matching contacts with their mobile numbers or e-mail addresses appear below the **To** field. Touch a matched contact, or continue manually typing the desired phone number or e-mail address.

 **NOTE:** Repeat step 1 to enter more mobile numbers if you want to send the message to multiple recipients. You need to enter ";" for a second number.

 **NOTE:** To add a subject line to the message by touching the Menu button  → **Add subject**.

- 2 Touch the **Type to compose** text field to start composing your message.
- 3 While editing your message, you can touch the Menu button  → **Attach** to insert media items into the message.
- 4 When you have completed editing the multimedia message, touch the **Send** button to send the message.

You can attach any of the following items to a multimedia message:

<b>Picture</b>	Open the <b>Gallery</b> application and touch a picture file to attach it to your message.
<b>Capture picture</b>	Open the <b>Camera</b> application to capture a picture, then attach it to your message. For information about the Camera application, see "Camera" on page 130.
<b>Video</b>	Open the <b>Gallery</b> application and touch a video clip to attach it to your message.
<b>Capture video</b>	Open the <b>Camcorder</b> application to capture a video clip, then attach it to your message. For more information about the Camcorder application, see "Camera" on page 130.



---

## Audio

Open the **Select audio** menu. Touch a desired audio file, and then touch **OK** to attach the file to your message.



To attach an audio file stored on the microSD card to your MMS:

- 1 Create a folder named Ringtones in the microSD card.
- 2 Open the Ringtones folder.
- 3 Copy the audio file you want to attach to your MMS into the Ringtones folder.
- 4 On the MMS composer screen, touch the Menu button  → **Attach** → **Audio**.
- 5 Select the audio file to attach it to your MMS.

---

## Record audio

Open the **Recorder** application to record an audio clip.



- Touch  to start recording.
  - Touch  to stop recording.
  - Touch  to listen to the recording.
  - Touch **Use this recording** to attach the recording to your message.
-

---



## Slideshow

Open the **Edit slideshow** screen to create a slide show and attach it to your message.

- 1 Touch **Add slide** to create new slides.
- 2 Touch a created slide such as **Slide 1** to open the slideshow editor screen.
- 3 Touch **Add picture**, and then select the picture you want to add to the slide.
- 4 You can touch the text field on the lower part of the screen to compose a caption for the displayed slide.
- 5 Touch the Menu button  to preview the slide, remove the picture, add a music to the current slide, add a new slide, or change the slide duration or the text and picture layout.

- When editing multiple slides, touch  to edit the next slide; touch  to return to the previous slide.

**NOTE:** You can create a slideshow of up to ten slides.

- To replace a picture, on the slideshow editor screen, touch the **Replace picture** button and select a new picture to replace. To remove the current slide, touch the **Remove Slide** button. To preview the slideshow, touch the **Preview** button.
  - When complete, touch the **Done** button at the bottom right to attach the slideshow to your message.
  - On the message composer screen, touch the slideshow attachment icon  to play back the slide show; touch **Edit** to modify the slideshow.
  - To remove the slideshow attachment from your message, touch **Edit**→ Menu button  → **Discard slideshow**.
-

## Receiving text and multimedia messages

Depending on your notification settings, the smartphone rings, vibrates, or displays a message briefly in the status bar as a new text or multimedia message arrives.

A new message icon  appears and stays in the notifications area of the status bar to remind you of a new message.



**NOTE:** To alter the notification settings for new messages, in the



**Messaging** application touch the Menu button  → **Settings** →

**Notification settings**. In the **Notification settings** section, you can decide whether to receive a text notification in the status bar when a new message arrives by enabling/disabling **Notifications**. You can also select a ringtone that rings on the arrival of a new message, or let the smartphone vibrate to report a new message.

Text and multimedia messages that are sent to and received from the same contact or a number are grouped into message threads similar to text conversations of an online chat. You can see all of the messages exchanged between you and the contact. Message threads are listed according to when they are sent or received, with the latest message at the top.

## To read a text message

To read a text message, you can either:

- Touch and drag down the status bar where the new message icon  is displayed. A list of notifications is displayed. Touch a new message notification to open and read the message.
- Touch the Launcher button  → **Messaging**  to open the message list, and then touch a text message or message thread to open and read it.

If the message includes a:

- Website link — touch the link to open the **Browser** application and visit the website.
- Phone number — touch the number to open the **Phone** application and call the number.

- E-mail address — touch the e-mail address to open the **Email/Gmail** application and compose an e-mail to send to the address.

### To forward the message

- 1 Touch and hold the message. The **Message options** menu pops up.
- 2 Touch **Forward** to forward the message.

### To view a multimedia message

- 1 Touch and drag down the status bar where the new message icon  is displayed. A list of notifications is displayed. Touch a new message notification to open the message.

Or

Touch the Launcher button  → **Messaging**  to open the message list, and then touch a multimedia message or message thread to open the message.

- 2 Touch the thumbnail of the attached picture to display the picture; touch the **Play** button  to play back the attached video.

 **NOTE:** Touch the **Download** button, to manually download the media file in the message.



 **NOTE:** To save the attached media item to your microSD card, touch and hold the message until the **Message options** menu pops up. Touch **Copy attached to SD card**.

### To reply to a text or multimedia message

- 1 Touch a message or message thread to open it.
- 2 Type your reply message into the **Type to compose** text field.
- 3 Touch **Send** to send your message to the sender.

### To delete a message or a message thread

- 1 In the Messaging list, touch and hold the message thread that you want to delete.
- 2 To delete the entire thread, touch **Delete thread** and then touch **Delete** to confirm deletion.  
To delete a message within a thread, touch and hold the message to delete, and then touch **Delete message** on the Message options menu. Touch **Delete** to confirm deletion.

 **NOTE:** To delete all messages in the Messaging list, touch the Menu button  → **Delete threads**.



### To edit message settings

In the Message application, touch the Menu button  → **Settings** to change the text or multimedia message settings. Follow the instructions on the screen.

## Pop-Up Menu

Touch the Menu button  to open or close the pop-up menu that lists the available options for the current application, or actions that you can perform on the current screen.

### To select an option or item on the pop-up menu

- 1 Touch the Menu button  to open the pop-up menu.
- 2 Touch the desired item on the pop-up menu.
- 3 If the menu has a scroll bar on the right side, you can flick the menu until the desired item is found.
- 4 Touch the Menu button  again to close the pop-up menu.

# Android Keyboard

You can type text using the Android on-screen keyboard. When you start an application or touch a field that requires text input, the on-screen keyboard opens. The keyboard automatically changes to either the portrait or landscape mode based on the orientation of your phone.

## To open the Android keyboard

Touch a text box, or touch and hold the Menu button .



**NOTE:** To open the Swype keyboard:

- Touch and hold a text box to open the **Edit text** context menu→ **Input method**→ **Swype**.
- On the Android keyboard, touch and hold  to open the **Android keyboard** context menu→ **Input method**→ **Swype**. For information on using the Swype keyboard, see "Swype Keyboard" on page 66.



**NOTE:** To switch back to the Android keyboard from the Swype keyboard, touch and hold a text box to open the **Edit text** context menu→ **Input method**→ **Android keyboard**.

## To close the keyboard

Touch the Back button , or touch and hold the Menu button .

## To display the keyboard

Touch a text field, or touch and hold the Menu button .

## Keyboard controls

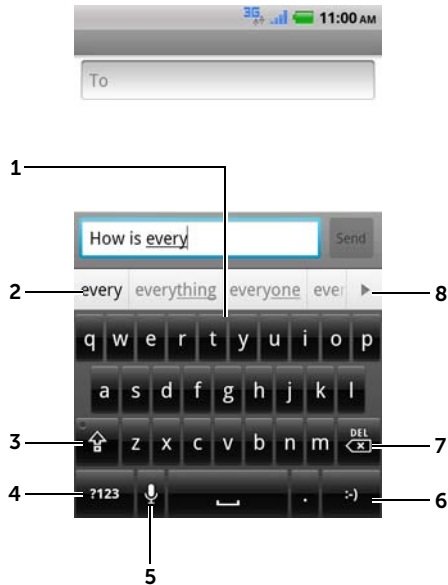

- 
- 1
    - Touch to type letters into the field where the cursor appears.
    - Touch and hold to type accented letters for applicable languages.

---

  - 2
    - Based on the letters being typed, the keyboard shows suggested words along the top, the most probable one highlighted in color.
    - You can touch a suggested word to enter it into the text field.

---





  - 3
    - Touch once to show the uppercase keyboard for typing an upper case letter.
    - Touch and hold to enable the Caps Lock mode.
    - Touch to change back to the lowercase keyboard.

---

  - 4
    - Touch to show the keyboard for typing numbers, punctuation marks, and symbols other than the period.
    - Touch to switch back to the alphabet keyboard.
      - **Android keyboard settings:** Configure the keyboard settings.
      - **Input method:** Choose to use the Swype or Android keyboard.
-

- 
- 5 Touch to use voice input. Say the words you want to enter to the microphone. The device enters the words that it can recognize from your voice.
- 
- 6
    - Touch to enter the smiley emoticon.
    - Touch and hold to see the other available emoticons.
- 
- 7
    - Touch to delete a typed character, symbol, or a space to the left of the cursor.
    - Touch and hold to quickly delete typed text.
- 
- 8 Touch  to see more suggested words.
- 

### To configure the keyboard settings

- 1 Touch the Home button  → Menu button  → **Settings** → **Language & keyboard** → **Android keyboard**.
- 2 To enable a setting, touch the setting option to select the check box ; to disable a setting, touch the setting option to clear the check box .

### Available keyboard settings

<b>Vibrate on keypress</b>	The smartphone vibrates when you touch a key.
<b>Sound on keypress</b>	The smartphone beeps when you touch a key.  <b>NOTE:</b> To activate this feature, you also need to select <b>Settings</b> → <b>Sound</b> → <b>Audible selection</b> .
<b>Auto-capitalization</b>	The first letter of the word in a new sentence is capitalized.
<b>Voice input</b>	Turn on the microphone to enable voice input for the main keyboard or symbols keyboard.
<b>Input languages</b>	Select more input languages. To change to use another input language, use your finger to slide on the spacebar.

---





## Word suggestion settings

<b>Quick fixes</b>	Mark and correct wrong spellings and typos.
<b>Show suggestions</b>	Show suggested words as you type.
<b>Auto-complete</b>	A space or a proper punctuation mark is automatically inserted after a typed word.



## Create your personal dictionary

The keyboard uses the default dictionary to display suggested words as you type. You can create a personal dictionary to include words not found in the main dictionary. The keyboard will also look at the words that are added to your personal dictionary to make word suggestions.



### To add a word to the dictionary

- 1 Touch the Home button  → Menu button  → **Settings** → **Language & keyboard** → **User dictionary**.
- 2 Touch the Menu button  → **Add**.
- 3 Type the desired word into the **Add to dictionary** text field.
- 4 Touch **OK**.

### To edit a word in the dictionary

- 1 Touch the Home button  → Menu button  → **Settings** → **Language & keyboard** → **User dictionary**.
- 2 Touch the desired word.
- 3 Touch **Edit**.
- 4 Edit the spelling of the word in the **Edit word** text field.
- 5 Touch **OK**.

### To delete a word from the dictionary

- 1 Touch the Home button  → Menu button  → **Settings** → **Language & keyboard** → **User dictionary**.
- 2 Touch the word you want to delete.
- 3 Touch **Delete**.

# Swype Keyboard

The Swype keyboard allows you to enter text by drawing a path through the letters of a word, instead of touching each key to type the word.

## To open the Swype keyboard

Touch and hold a text box to open the **Edit text** context menu→ **Input method**→ **Swype**.

## Swype Keyboard controls for composing an e-mail

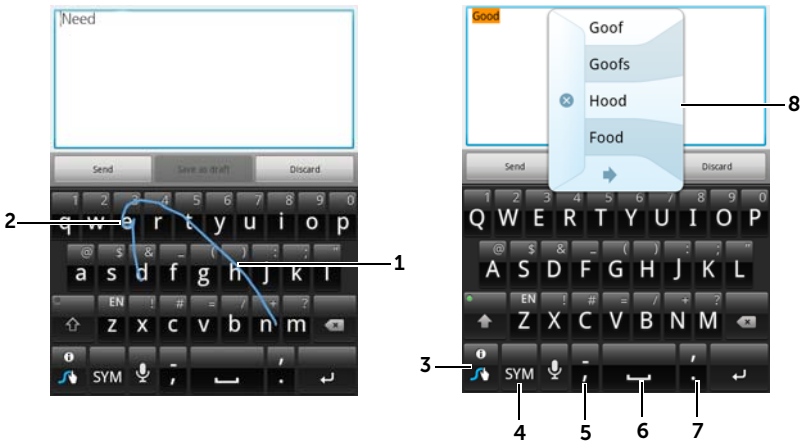

- 1 To enter the word “Need” for example, place your finger on the first letter “N” and glide to the following letters. Lift your finger after the last letter “d”. The keyboard predicts and enters the word according to the letters that the path you drew goes through. Letters irrelevant to the spelling of the word are ignored.
- 2 To enter the double letters “ee” for the word “Need”, do a quick back-and-forth scribble or draw a loop on the letter “e”.

- 
- 3**
- When no word is entered into the text box, touch the key to choose from the following:
    - **Tutorial:** Play the animated tutorial demonstrating how to use Swype.
    - **More Help:** Read Swype Help for detailed information on using Swype.
    - **Options:** Adjust the Swype keyboard settings.
  - After words are entered into the text box, touch the key to see other word suggestions to replace the word where the cursor is inserted.
  - Touch and hold the key to access Swype Help directly.
- 

- 4**
- Touch to show the keyboard for typing numbers, punctuation marks, and symbols.
- 

- 5**
- Touch to enter “,”.
  - Touch and hold to enter “-”.
- 

- 6**
- Touch to enter a space.
  - Touch and hold to enter a tab space.
- 

- 7**
- Touch to enter “.”
  - Touch and hold to enter “.”
- 

- 8** The Swype keyboard display word suggestions when it cannot predict the word according to the trace you draw, or when you touch .
-



# Google Search Widget

You can use the Google Quick Search Box to find websites and information on Google, access applications installed on your smartphone, or find contacts stored in your Contacts list.

## To search by typing



- 1 From the Google Search widget you created on the Home screen, touch  to select the type of your search: **All**, **Web**, **Apps** or **Contacts**.



- 2 Touch the **Google Quick Search Box**. The on-screen keyboard appears.
- 3 Type a keyword or text into the box using the keyboard. As you type, the search results that fully or partially match the text being typed appear below the search box.
- 4 Scroll the listed search results and touch to select a desired keyword. If you only want to view matching web links on Google, either touch the  key on the keyboard or the search icon  on the search box.
- 5 The matching application or the browser with matching web links opens.
- 6 Touch the desired link if you want to view a web page.

## To search by voice

- 1 Touch  that is displayed next to the search box.
- 2 Say the name or keyword of the item you are looking for.
- 3 The browser with matching web links opens.

 **NOTE:** You can also access the Voice Search function by touching the Launcher button  → **Voice Search** .

## Power Control Widget

To conserve battery, you may choose to disable one of these modes when not in use.

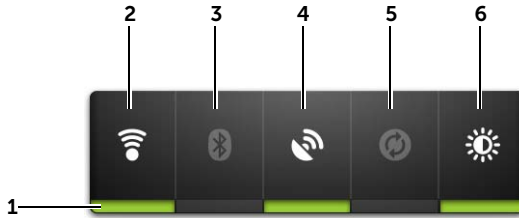

- 
- 1** Indicates if the appropriate mode is enabled or disabled.

---

  - 2** Touch to enable or disable Wi-Fi connection.

---

  - 3** Touch to enable or disable Bluetooth.

---

  - 4** Touch to enable or disable the **Use GPS satellites** mode, which allows you to pinpoint locations down to the street-level. This mode requires a clear view of the sky and more battery power.

---

  - 5** Touch to enable or disable the Auto-sync mode, which lets your phone automatically sync your Gmail data and Outlook data using Dell Mobile Sync.



---

  - 6** Touch repeatedly to adjust the brightness of your display backlight.



---

# Managing Your Smartphone Settings



## To check storage spaces

Touch the Home button  → Menu button  → **Settings** → **SD card & phone storage**. The screen displays the total and available space on the phone and on the microSD card.

## To erase unwanted application data to free storage space

- 1 Touch the Home button  → Menu button  → **Settings** → **Applications** → **Manage applications**.
- 2 From the **Manage applications** list, touch the application whose cache or data you want to remove.
- 3 In the **Application info** screen, touch **Clear data** under **Storage** to erase unwanted application data; touch **Clear cache** under **Cache** to erase unwanted cache.

## To format the microSD card

- 1 Touch the Home button  → Menu button  → **Settings** → **SD card & phone storage**.
- 2 Touch **Unmount SD card** to enable the **Format SD card** option.



**CAUTION:** Formatting a microSD card erases all data and downloaded applications stored on it. Ensure that you back up the data that you need before formatting your microSD card.



**NOTE:** For information on how to back up your smartphone data, see "Synchronizing Your Dell Venue Smartphone and Computer Using Dell Mobile Sync" on page 150.

- 3 Touch **Format SD card** → **Format SD card** → **Erase everything** button.



## To remove the microSD card safely



**CAUTION:** Removing the microSD card while the smartphone is working may cause data lost or result in application errors.



**CAUTION:** It is strongly recommended to unmount the microSD card before removing it.

- 1 Touch the Home button  → Menu button  → **Settings** → **SD card & phone storage**.
- 2 Touch **Unmount SD card**.
- 3 Turn off your smartphone.
- 4 Remove the back cover.
- 5 Remove the microSD card from your smartphone.

### To erase all data from your smartphone

 **CAUTION:** The following steps will erase all the data including your Google account and downloaded applications from your smartphone. Ensure that you back up all the required data before you proceed.

- 1 Touch the Home button  → Menu button  → **Settings** → **Privacy** → **Factory data reset** → **Erase everything**.
- 2 Touch **Reset phone**.



**NOTE:** You need to draw your screen unlock pattern if it is enabled.

- 3 Touch **Reset phone** after you read the warning.

### To reset your smartphone to the default state

 **CAUTION:** The following steps will restore your smartphone to the default state and erase all data and downloaded applications stored on it. Ensure that you back up all the required data before you reset the smartphone.

- 1 Press and hold the Power button and then touch the **Power off** option → **OK** on the screen to turn off the smartphone.
- 2 Simultaneously press and hold the volume up and down buttons.
- 3 Without releasing the volume buttons, press and hold the Power button, until the smartphone displays the configuration screen.
- 4 Press the volume buttons to move the highlight bar on the screen to the **Factory reset** option.
- 5 Press the Camera button to start the reset process and wait for the smartphone to restart.

# 4 Internet

## Connecting to the Internet

To browse the web and access web-based utilities such as instant messaging, one of the following data networking connections must be available:





- GPRS
- EDGE
- 3G
- HSPA
- Wi-Fi

### GPRS/EDGE/3G/HSPA

#### To connect to the internet using GPRS, EDGE, 3G, or HSPA

Your smartphone is configured with GPRS, EDGE, 3G, or HSPA network available with the service provider of the SIM card installed in your smartphone. However, this is only limited to voice calling and text messaging. If a Wi-Fi connection is currently available, the smartphone automatically uses the Wi-Fi connection to access the internet. The internet connection through GPRS, EDGE, 3G, or HSPA becomes temporarily inactive, until the Wi-Fi connection ends.

If you want to connect to the internet using a GPRS, EDGE, 3G, or HSPA data network:

- 1 Touch the Home button  → Menu button  → **Settings** → **Wireless & networks**, then clear the **Wi-Fi** check box to disable Wi-Fi.
- 2 Touch the Home button  → Menu button  → **Settings** → **Wireless & networks** → **Mobile networks**, then touch **Data enabled**.









**NOTE:** Depending on whether a GPRS, EDGE, 3G, or HSPA network is currently in use, a corresponding data network icon appears on the status bar after a data connection is established. For information about identifying the data network icons, see "Status Bar" on page 38.

You can set the smartphone to search for available networks if you are outside your home network or want to register to a different network.

### To manually select a new network





- 1 Touch the Home button  → Menu button  → **Settings** → **Wireless & networks** → **Mobile networks** → **Network operators** → **Search networks**. A list of networks currently available is displayed.
- 2 Select a network manually from the network list.

### To automatically select a new network

Touch the Home button  → Menu button  → **Settings** → **Wireless & networks** → **Mobile networks** → **Network operators** → **Select automatically**.

### To schedule mobile data connection

You can schedule your data connection to minimize the amount of time that you use your data connection to save battery power.

- 1 To enable this feature, touch the Home button  → Menu button  → **Settings** → **Wireless & networks** → **Mobile networks** → **Schedule data connection** → **Enable**.
- 2 In the **off-peak hours** section, set a time range as off-peak hours.
  - Touch **Start Time**. Adjust the time by touching  or , or touch the hour and minute fields to enter a time. Touch **Set** when done.
  - Touch **End Time** and repeat the step above to set **End Time**.

- 3 Touch **Cellular Data Timeout** to set the timeout value. For example, if you select **15 minutes**, data connection will be turned off after 15 minutes of inactivity.

To resume data connection, turn on the display of your smartphone.

 **NOTE:** You can also touch **Cellular Data Timeout** in the **peak hours** section to set the timeout value for peak hours.



## Wi-Fi

You can connect your smartphone to the Internet using Wi-Fi.

To use Wi-Fi on your smartphone, you need access to a wireless point or "hotspot" within a distance of up to 300 feet (100 meters).

 **NOTE:** The range and quality of the Wi-Fi signal is affected by the number of connected devices, infrastructure, and objects through which the signal is transmitted.

### To turn on Wi-Fi and connect to a network

- 1 Touch the Home button  → Menu button  → **Settings** → **Wireless & networks** → **Wi-Fi** to select the Wi-Fi check box. The smartphone scans for available wireless networks.
- 2 Touch **Wi-Fi settings**. The network names and security settings (Open network or Secured with WEP/WPA/WPA2/WPS) of discovered Wi-Fi networks are displayed in the **Wi-Fi networks** list.
- 3 Flick the list and touch to select a Wi-Fi network to connect to.
- 4 Enter a password (if necessary), then touch **Connect** to connect to the Wi-Fi network.

 **NOTE:** To connect to a network protected by Wired Equivalent Privacy (WEP), WPA (Wi-Fi Protected Access), WPA2, or WPS (Wireless Protected Setup), you must enter the WEP/WPA/WPA2/WPS security key to obtain authorized access to the network. The next time your smartphone connects to a previously accessed secured wireless network, you will not be required to enter the WEP/WPA/WPA2/WPS key again, unless you reset your smartphone to its factory default settings.

 **NOTE:** Your smartphone has the ability to maintain a constant internet connection through Wi-Fi or mobile networks (GPRS, EDGE, 3G, or HSPA). However, Wi-Fi connection has priority over mobile network connection if both are available.



### To check the current Wi-Fi network connection

From the status bar:

When your smartphone is connected to a wireless network, the Wi-Fi icon  in the status bar indicates the signal strength (number of bands that light up). If **Wireless & networks** → **Wi-Fi settings** →



**Network notification** is enabled, the  icon appears in the status bar as the smartphone discovers an accessible Wi-Fi network within range.



From the Wi-Fi network:

- 1 Touch the Home button  → Menu button  → **Settings** → **Wireless & networks** → **Wi-Fi settings**.
- 2 Touch the Wi-Fi network that the smartphone is currently connected to (labeled **Connected**). A window opens displaying the Wi-Fi network's name, status, security info, signal strength, link speed, and IP address.

 **NOTE:** If you want to disconnect the Wi-Fi network from your smartphone, touch **Forget** on the window. You will need to configure the Wi-Fi settings again if you want to restore connection to this wireless network.

### To connect to another Wi-Fi network

- 1 Touch the Home button  → Menu button  → **Settings** → **Wireless & networks** → **Wi-Fi settings**. The detected Wi-Fi networks are displayed in the **Wi-Fi networks** list.



 **NOTE:** To start a new search for available Wi-Fi networks, on the **Wi-Fi settings** screen, touch the Menu button  → **Scan**.

- 2 Flick through the Wi-Fi networks list and touch the name of the network you want to connect to.

 **NOTE:** If the wireless network you want to connect to is not in the list of detected networks, flick to the bottom of the list to touch **Add Wi-Fi network**. Enter the Wi-Fi network settings, and then touch **Save**.

## Disable All Connections Using the Airplane Mode

Selecting the Airplane mode disables all mobile and Wi-Fi connections. This feature is useful when wireless connectivity is strictly prohibited, such as on an airplane.

Touch the Home button  → Menu button  → **Settings** → **Wireless & networks** → **Airplane mode** to enable or disable the Airplane mode.

## Browsing the Internet

### To open the browser

Touch the Launcher button  → **Browser** .

### To use the browser controls bar



- 1 Touch the web page address field and type the address of the web page you want to go to.
- 2 Touch to view bookmarks, most visited web pages, and browsing history.

### To go to a web page

- 1 On the browser screen, touch the web page address field on the screen.
- 2 Type the web page address using the on-screen keyboard. As you type the address, matching web page addresses appear.
- 3 Touch an address displayed on the screen to go directly to that web page, or complete typing the web page address, then touch the **Go** button.

## To set up your home page

To manually enter a home page:

- 1 Touch the Menu button  → **More** → **Settings** → **Set home page**.
- 2 Enter the web address of the website you want to use as your home page and then touch **OK**.

To set the current page as the home page:

- 1 Go to the web page that you want to set as the home page.
- 2 Touch the Menu button  → **More** → **Settings** → **Set home page**.
- 3 Touch **Use current page** → **OK**.

To select a home page from bookmarks:

- 1 Touch  from the browser control bar to view the lists of bookmarks, most visited sites, and browsing history.
- 2 Touch and hold a desired bookmark to display the commands menu → **Set as homepage**.

## Viewing Web Pages

### To navigate on a web page

Flick your finger horizontally or vertically on the screen to scroll and view desired areas of a web page.



### To zoom in on a web page

Pinch-out a desired area of a web page by moving two fingers apart on the screen.

### To zoom out on a web page

Pinch-in a desired area of a web page by bringing two fingers closer together on the screen.

### To view the next or previous page

Touch the Back button  to view the previous page; touch to Menu button  → **Forward** to view the next page.

### To open a new window

Touch the Menu button  → **New window**. A new browser window opens and displays the home page.

### To switch between browser windows

You can open multiple browser windows and easily switch from one web page to another.

- 1 On a browser window, touch the Menu button  → **Windows**.



 **NOTE:** To close a browser window, touch  on the browser window.

- 2 Touch the web address of a desired web page. The window opens displaying the page in full screen.

### To find text within a web page

- 1 When viewing a web page, touch the Menu button  → **More** → **Find on page**.

- 2 Type the search item in the search bar.

- 3 Touch  or  to go to the previous or next matching item.

 **NOTE:** Touch  to close the search bar.

### To copy text on a web page

You can copy and paste text from a web page to your e-mail, text, or multimedia messages.

- 1 Go to the web page from where you want copy the text.
- 2 Locate the text you want to copy and then touch the Menu button  → **More** → **Select text**.
- 3 Position your finger at the start of the text you want to copy and then drag to the end of the text you want to copy. The copied text is highlighted in pink.
- 4 Release your finger from the screen.
- 5 To paste text on an e-mail, text, or multimedia message, touch and hold the text field on a message or e-mail screen and then touch **Paste** on the pop-up menu.



## Using Web Links, History, and Downloads



### To select a link on a web page

Move to a link you want on a web page. The link is framed by an orange box when you touch it.

Link type	Functionality
<b>Web page address</b>	Touch and hold the link to open a pop-up menu that allows you to copy the link of the web page to the clipboard, or share the link through Bluetooth, Evernote, Facebook, Gmail, text messaging, or Twitter.
<b>E-mail address</b>	<ul style="list-style-type: none"><li>• Touch to send an e-mail to the e-mail address.</li><li>• Touch and hold till a pop-up menu appears.<ul style="list-style-type: none"><li>– Touch <b>Send email</b> to send an e-mail to the e-mail address.</li><li>– Touch <b>Copy</b> to copy the e-mail address to the clipboard. You can paste the e-mail address later to a new contact or while composing a new e-mail.</li></ul></li></ul>
<b>Phone number</b>	Touch to open the <b>Phone</b> application to call the phone number.  <b>NOTE:</b> You can call a number from the web page only if the feature is supported by your service provider.

### To check the history of visited web pages



- 1 On the browser screen, touch  → **History**, or touch the Menu button  → **Bookmarks**.
- 2 Touch the **History** tab .
- 3 Touch the day when your desired web page was last visited.
- 4 Touch a web address to open the web page.

 **NOTE:** To check your most visited web pages, touch the **Most visited** tab .

## To allow download of web applications

 **CAUTION:** Applications downloaded from the web can be from unknown sources. To protect your smartphone and personal data, download applications only from trusted sources such as Android Market.

To download web applications, enable your smartphone's downloading feature.

- 1 Touch the Home button  → Menu button  → **Settings** → **Applications**.
- 2 Touch **Unknown sources** to select the check box.
- 3 When the **Attention** dialog box appears, touch **OK**.



**NOTE:** All downloaded applications are saved to the microSD card. Before you download an application from the web, ensure that you have installed a microSD card on your smartphone. For information on how to install a microSD card, see "Install the microSD card" on page 8.

## To install an application

- 1 On the browser screen, touch the application you want to download.
- 2 The application details screen appears. Read details about the application, such as its cost, overall rating, comments by users, the developer contact info, and more.
- 3 To install the application, select either **Install** (free applications) or **Buy** (applications that require purchase).

## To check downloads



On the browser screen, touch the Menu button  → **More** → **Downloads**.





## Manage Bookmarks

You can store as many bookmarks as you want on your smartphone.



### To bookmark a web page

- 1 On the browser screen, go to the web page you want to bookmark.
- 2 Touch  or touch the Menu button  → **Bookmarks**. The **Bookmarks** window opens.
- 3 On the **Bookmarks** tab, touch **Add**.
- 4 Enter the bookmark name or edit the web address as needed.
- 5 Touch **OK** to save the web page as a bookmark.

### To open a bookmark

- 1 On the browser screen, touch  or touch the Menu button  → **Bookmarks**. The **Bookmarks** window opens.
- 2 On the **Bookmarks** window, you can either:
  - Touch the bookmark you want to open in the same browser window.
  - Touch and hold the bookmark you want to open, then on the pop-up menu touch **Open** to open the bookmark in the same browser window, or **Open in new window** to open the bookmark in a new window.

### To manage your bookmarks

- 1 On the browser screen, touch  or touch the Menu button  → **Bookmarks**.
- 2 On the **Bookmarks** window, touch and hold a desired bookmark to open a pop-up menu that provides the following options:

<b>Edit bookmark</b>	Touch to open the <b>Edit bookmark</b> window. Enter the bookmark's name and address and touch <b>OK</b> .
<b>Add shortcut to Home</b>	Touch to create the bookmark's shortcut on the current Home screen. Then you can touch the shortcut on the Home screen to start the browser and go directly to the bookmarked page.
<b>Share link</b>	Touch to share the link through Bluetooth, Evernote, Facebook, Gmail, Messaging, or Twitter. <ul style="list-style-type: none"> <li>• <b>Bluetooth:</b> Touch <b>Bluetooth</b>. If your device is not listed under Bluetooth devices, touch <b>Scan for devices</b>. Touch the device you want to share the link with.</li> <li>• <b>Gmail:</b> Touch to open the Compose window with the bookmark's address automatically pasted on the text field. Then send the bookmark's address to others with an e-mail.</li> <li>• <b>Messaging:</b> Touch to open the message composer with the bookmark's address automatically pasted on the text field. Then send the bookmark's address to others with a text message.</li> </ul>
<b>Copy link URL</b>	Copy the link of the web page to the clipboard.
<b>Delete bookmark</b>	Touch to delete the selected bookmark.
<b>Set as homepage</b>	Set the selected bookmark as the home page.

### To configure browser settings

On the browser screen, touch the Menu button  → **More** → **Settings** to adjust the browser settings.

# E-mail

You can create POP3, IMAP, and exchange e-mail accounts from web-based e-mail services on your smartphone.

## To open the e-mail application

Touch the Launcher button  → **Email** .

## To set up an e-mail account

- 1 On the **Set up email** screen, type the e-mail address and password of the e-mail account you want to add and then touch **Next**.

 **NOTE:** If the e-mail account you want to set up is not in the smartphone e-mail database, you will be asked to manually enter the e-mail account settings, including the e-mail server, protocol, and so on after touching **Next**.



 **NOTE:** Touch **Manual setup** rather than **Next** to directly enter incoming and outgoing server settings for the account being set up.

- 2 Enter the name for the account and the name you want displayed in outgoing e-mails and then touch **Done**.

After creating one e-mail account, touch the Menu button  →

**Accounts** → touch the Menu button  again → **Add account**, if you need to create another e-mail account.

## To compose and send e-mails



- 1 Touch the Launcher button  → **Email** .



- 2 In an e-mail account inbox, touch the Menu button  → **Compose**.

- 3 Type the recipient's e-mail address in the **To** field. As you type information, matching contacts appear on the screen. Touch the recipient to automatically add the e-mail address, or continue

typing the e-mail address completely. If you are sending the e-mail to multiple recipients, separate their e-mail addresses with a comma. You can add as many recipients as you need.

- 4 Type the subject.
- 5 Compose your message.
- 6 Touch the Menu button  → **Send**.



 **NOTE:** If you want to save the message as a draft and modify it later, touch  or touch **Save as draft**.

 **NOTE:** When you receive a new e-mail, the e-mail icon  appears on the status bar to alert you of a new e-mail. Drag down the status bar to open the Notifications panel and touch the new e-mail to view it.

#### To delete an e-mail

- 1 On the e-mail account inbox, touch and hold the e-mail you want to delete.
- 2 On the pop-up menu, touch **Delete**.

#### To delete or edit an e-mail account on your smartphone

- 1 Touch the Launcher button  → **Email** .
- 2 Touch the Menu button  → **Accounts**.
- 3 To delete an e-mail account, touch and hold the account you want to remove under the Accounts bar, then touch **Remove account** on the pop-up menu. When the confirm deletion screen is displayed, touch **OK**.
- 4 To edit an e-mail account, touch and hold the account you want to edit, then touch **Account settings** on the pop-up menu.

# Web Applications

 **NOTE:** You require an active Wi-Fi or mobile data network connection (GPRS, EDGE, 3G, or HSPA) to be able to connect to the web. For more information about configuring your smartphone for web connectivity, see "Connecting to the Internet" on page 72.

 **NOTE:** Not all applications are available in all versions of this product.

## Gmail

Gmail is a web-based e-mail service provided by Google.

### To open Gmail

Touch the Launcher button  → **Gmail** .

### To set up your Google account

You need to sign in to a Google account to use Google applications and services such as Gmail, Google Maps, Google Talk, and Android Market. Signing in to your Google account also synchronizes all e-mails and contacts on your Google account with your smartphone.

 **NOTE:** You will not be required to sign in with your Google account if you have already signed in when previously using an application that requires signing in to your Google account.

- 1 On the **Add a Google Account** screen, touch the **Next** button to proceed.
- 2 Touch the **Sign in** button. Enter your Google user name and password, then touch the **Sign in** button.

 **NOTE:** If you need to use a different Google user name and password with your smartphone, you must erase all data from your smartphone by performing a Factory Reset (see "To erase all data from your smartphone" on page 71).

 **NOTE:** Signing in to your Google Account requires an Internet connection. Ensure that your smartphone has an active Wi-Fi or mobile data connection (GPRS, EDGE, 3G, or HSPA) before you sign in. For more information about setting up a data connection, see "Connecting to the Internet" on page 72.



**NOTE:** Touch the **Create** button if you do not have a Google Account.

Your Gmail inbox opens as the default Gmail view. All your received e-mails are delivered to your inbox.



- 
- 1 Indicates the number of e-mails grouped under the same subject.

---

  - 2 Folder (or Label) and number of unread e-mails.

---

  - 3 Touch the check box to select the e-mail. To use this feature, touch the Menu button → **More** → **Settings**, then enable **Batch operations**.

---

  - 4 Touch to store the selected e-mail thread in the **All Mail** folder.

---

  - 5 Touch to delete the selected e-mail thread.

---

  - 6 Touch to label the selected e-mail thread.

---

  - 7 Starred e-mail. Touch the star to add or remove the star.

---

### To refresh Gmail

Touch the Menu button → **Refresh** to send or receive e-mails and to synchronize your e-mails with your Gmail account on the web.

## To view e-mails in different folders or with labels

To view e-mails stored in the folders other than the inbox, such as in the Sent or All Mail folders, or to view labeled or starred e-mails:

- 1 Touch the Menu button  → **Go to labels**.
- 2 Touch the folder that stores the e-mails you want to view, or touch the label with which the e-mails are marked.

## To read e-mails

- When you receive a new e-mail, the e-mail icon  appears on the status bar to alert you of a new e-mail. Drag down the status bar to open the Notifications panel and touch the new e-mail to view it.
- While in the inbox or in any other folder, scroll the e-mail threads on the screen, and then touch an e-mail to open it.



- 
- 1 Touch to view previous e-mails with the same subject.
  - 2 Touch to star an e-mail. To check the starred e-mails, in **Inbox**, touch the Menu button  → **Go to labels** → **Starred**.
  - 3 Touch to reply to the contact.
  - 4 Touch to read the next e-mail thread.
-

- 
- 5 Touch to read the previous e-mail thread.

---

  - 6 Touch to reply to all contacts in the mail loop.





---

  - 7 Touch to forward the e-mail to another contact.

---

  - 8 Touch to open or close the **Reply all** and **Forward** buttons.
- 



### To create and send an e-mail

- 1 Touch the Menu button  → **Compose**.
  - 2 Enter the contact's e-mail address in the **To** field. To send e-mail to multiple contacts, separate their e-mail addresses with a comma. To send a carbon copy (Cc) or a blind carbon copy (Bcc), touch the Menu button  → **Add Cc/Bcc**.
  - 3 Enter the e-mail subject.
  - 4 Compose your e-mail. To attach a picture, touch the Menu button  → **Attach**. Select the picture you want to attach from the Gallery application (for more information, see "Photos and Videos" on page 138).
-  **NOTE:** Touch  to remove an attachment.
- 5 Touch **Send** to send the e-mail.

### Google Talk

Google Talk is an instant messaging application provided by Google.

#### To activate Google Talk

- 1 Touch the Launcher button  → **Google Talk** .
- 2 Sign in to Google Talk with your Google account. If you do not have a Google account, follow the instructions on the screen to create an account (see "To set up your Google account" on page 85).
- 3 The Talk window opens with your friends list.



### To sign in automatically

You can sign in to your Google Talk account automatically whenever you turn on the smartphone.

- 1 In the friends list, touch the Menu button  → **Settings**.
- 2 Select **Automatically sign in**.

### To add a new friend to your friends list



**NOTE:** You can only add friends who have a Google Account.

- 1 In the friends list, touch the Menu button  → **Add friend**.
- 2 Enter the Google Talk instant messaging ID or Gmail address of the friend you want to add to your friends list.



**NOTE:** When you type the instant messaging ID of a friend who is already a contact saved in Contacts with the same ID, this matching contact will display on the screen before you finish typing. You can touch the contact whose ID is then entered automatically.

- 3 Touch **Send invitation**.

### To view and accept an invitation

- 1 In the friends list, touch the Menu button  → **More** → **Invites**. All chat invitations you have sent or received but have not been answered are listed on the pending invitations screen.
- 2 Touch a pending invitation.
- 3 Touch **Accept** or **Cancel**.

When a friend accepts your chat invitation, the pending invitation disappears from the list.

### To change your online status and message

- 1 Touch the online status icon  next to your name.
- 2 Select the status you want from the Set Status menu.
- 3 To enter your status message, touch the text box and enter your message.

- 4 To change your ID photo, touch the photo icon → **Change** to open Gallery, then select the photo to use.
- 5 When finished, touch **Done**.

### To start a conversation

- 1 Touch to select a friend in the friends list.
- 2 Type your message in the text box.
- 3 Touch the **Send** button to send the message.

### To add a friend to an active conversation

- 1 On the chat screen, touch the Menu button  → **Add to chat**.
- 2 Select the friend you want to invite to the current conversation.

### To disable the chat log

On the chat screen, touch the Menu button  → **Chat off record**. The subsequent chat conversations will not be recorded. To resume the chat log, touch **Chat on record**.

### To switch between active conversations

- 1 While on a chat screen or in the friends list, touch the Menu button  → **Switch chats**.
- 2 In the panel that opens, touch the name of the friend you want to chat with.

### To close a conversation

- In your friends list, touch and hold the name of a friend with an active chat. Touch **End chat** on the menu that pops up.
- On a chat screen, touch the Menu button  → **End chat**.

### To display all friends in your friends list

Only the friends you chat with most frequently are listed as the most popular friends. If you want to display all your friends, touch the Menu button  → **All friends**.

### To show a friend in the most popular list

- 1 In the friends list, touch and hold the friend's name to open the options menu.
- 2 Touch **Show friend**.

### To always show a friend in most popular list

You can let a friend always appear in your most popular friends list.

- 1 In the friends list, touch and hold the friend's name to open the options menu.
- 2 Touch **Always show friend**.



**NOTE:** To remove a friend from the most popular list, in the friends list, touch and hold the friend you want to remove from the list, and then touch **Auto show friend** in the options menu.



**NOTE:** To keep a friend from appearing in the most popular list, touch and hold the friend's name, and then touch **Hide friend** in the menu.

### To block a friend from sending you messages

- 1 In the friends list, find the friend to block.
- 2 Touch and hold the friend's name, and then touch **Block friend**.

Your friend is removed from your friends list and is added to the blocked friends list.



**NOTE:** To unblock a friend, in the friends list, touch the Menu button  → **More** → **Blocked**. In the blocked friends list, touch the name of the friend to unblock, then touch **OK**.

### To permanently remove a friend

- 1 In the friends list, find the friend to remove.
- 2 Touch and hold the friend's name, and then touch **Remove friend**.

## To find out what device your friend uses to chat on Google talk

- 1 In the friends list, touch the Menu button  → **Settings** → **Mobile indicator**.
- 2 In the friends list, check the image that appears next to your friend's name. For example, if your friend is using an Android phone, the Android image will appear. If no image is displayed, it indicates that your friend has signed in to Google using a computer.

## To sign out from Google Talk

In the friends list, touch the Menu button  → **Sign out**.



## Maps

Google Maps helps you find your current location, view real-time traffic situations, and get directions to your destination. You can also use the search tool to locate addresses or places of interest on a map or in a street view.

 **NOTE:** The Google Maps application does not completely cover every location.

## To enable location source

To search for desired places or find your current location using Google Maps, you need to enable My location sources:

- 1 Touch Home button  → Menu button  → **Settings** → **Location & security**.
- 2 Select **Use wireless networks**, **Use GPS satellites**, or both.

 **NOTE:** Selecting **Use GPS satellites** allows you to pinpoint locations down to the street-level. However, this mode requires a clear view of the sky and more battery power.

## To open Google Maps

Touch the Launcher button  → **Maps** .

## To see your location on a map

On the Maps screen, touch . Your location is marked on the map with a blinking blue dot.

 **NOTE:** Selecting Enable GPS satellites allows you to pinpoint your current location down to the street-level. However, this mode requires a clear view of the sky and more battery power.

## To find a location on the map

1 On the Maps screen, touch the Menu button  → **Search**.

2 To search by typing:

a Type the place you want to find in the search box. You can enter an address, a city or country, or a type of business or organization such as a “restaurant” or “school”.

b Touch the search key on the keyboard or the search icon  on the search box.

To search by voice:

a Touch .

b Say your destination.

 **NOTE:** As you enter information, previous searches or matching locations appear below the search box. You can touch a place name or address to show the location on the map.

3 The search results are marked on the map by lettered balloons.



---

1 Touch the place name to view the address, details, and reviews for the place if the information is available. For more information, see "To view the details of a place" on page 95.

---

2 Touch to show the list of search results.

---

3 Touch to zoom in or out on the map.

---

4 The search result is marked by a lettered marker. Touch the marker to display the name of the place.

---

## To view the details of a place

When you touch a place name on the map view, the following screen appears, showing the address, details and review for the place (if available).



- 
- 1 Touch to display the map view.

---

  - 2 Touch to obtain directions. For more information, see "To get directions" on page 99.

---

  - 3 Touch to view the address, details, and reviews for the place if the information is available. Scroll down the list to find more actions you can do.

---

  - 4 Touch to call the contact number of the place if available.

---

  - 5 Touch to switch to street view for the location. For more information, see "To view a map in street view" on page 99.

---



  - 6 Touch the photo thumbnail to switch to street view for the location. For more information, see "To view a map in street view" on page 99.
-

### To move around a map

- 1 Flick or drag the map in any direction on the screen to view the desired areas.
- 2 If you spot a place of interest while navigating the map, touch and hold the place to display the address (a picture thumbnail is also displayed if the street view for the location is available).



### To zoom-in or zoom-out on a map

Touch  to zoom out and touch  to zoom in.

### To change map layers

Google Maps opens with the default map layer. You can apply different types of layers to view additional information or images on the map.

- 1 Touch .
- 2 From the Layers menu, touch the desired layer to display it on the map.





## Map layer

The map layer displays streets, highways, buildings, main establishments, mass transit stations, parks, rivers, lakes, mountains, boundaries, and so on.



## Traffic layer

The traffic layer displays colored lines along the roads where real-time traffic data can be collected. Green lines indicate good traffic speeds, yellow lines indicate slower speeds, and brown lines indicate congested traffic. 

 indicates where construction work is taking place;  indicates where the road is blocked.



### Satellite layer



The satellite layer displays the map in non-real-time satellite view.



### Terrain layer

The terrain layer combines street maps with visual information about terrains.



 **NOTE:** Touch  → **More Layers** to find more layers that you can apply to the map. For information about the other layers, visit the Google Maps website.





**NOTE:** To remove all of the layers other than the map layer, touch



→ **Clear Map.**

### To view a map in street view

You can switch to street view for the location that you found on the map. The street view is composed of imagery captured from the streets.



- 1 Locate a place of interest on the map. For more information, see "To find a location on the map" on page 93 and "To move around a map" on page 96.
- 2 On the map, touch the name or address of the place.
- 3 On the location details screen, touch Street View .
- 4 To view the area around the place, turn the view on the screen with your finger.
- 5 To move the view along the street, touch the arrows displayed on the screen, or touch the Menu button  → **Step forward** or **Step backward**.



**NOTE:** While viewing a street view of a location, touch the Menu button  → **Compass mode** to enable the compass mode, which allows you to view the area around the selected location by tilting or turning your smartphone, rather than by moving the view on the screen with your finger.

### To get directions

Use Google Maps to obtain directions to your destination.

- 1 When viewing a map:
  - touch the Menu button  → **Directions.**
  - Or
  - When a place is found:
    - a Touch the place's name or address displayed on the map.
    - b On the location details screen, touch  → **Get directions.**

- 2 Enter the starting point in the first text box and your destination in the second text box.

 **NOTE:** By default, your current location is the starting point, and the place you found on the map is your destination.



- 
- 1 Starting point
  - 2 Destination
  - 3 Choose how you want to get to your destination: driving, public transportation, or walking.
  - 4 Touch to render directions.
  - 5 Touch to set your current location, a contact address, or a place on the map as the starting point or destination.
- 

- 3 Touch **Go**. The directions to your destination are listed.
- 4 Touch **Show on map** or **Navigate**, or touch a direction instruction on the list to show the directions or routes on the map.

### To clear a map

Touch the Menu button  → **Clear Map**. All the search results, directions and traffic indicators are deleted from the map.

## Using Google Latitude



**NOTE:** To use Google Latitude, you will be required to sign in to a Google account.

The Google Latitude location service allows you to share locations with your friends and family who have signed in to the service with their Google accounts. You can also send instant messages and e-mails, make phone calls, and get directions to your friends' locations.

To let your friends view your location and accept their invitations, you need to enable **Latitude**.

- 1 While viewing a map in any mode, touch the Menu button  → **Latitude**.
- 2 Sign in to Google Latitude with your Google account. If you do not have a Google account, follow the instructions on the screen to create an account (see "To set up your Google account" on page 85).
- 3 Read the privacy policy. If you accept, touch **Agree & share**.

### To launch Latitude

While viewing a map, touch the Menu button  → **Latitude**.

### To invite friends to share locations

- 1 On the Latitude screen, touch the Menu button  → **Add friends**.
- 2 Choose the friends you want to share locations with:
  - **Select from Contacts:** Select friends from your contacts. Friends already using Latitude have an icon next to their names.
  - **Add via email address:** Enter an e-mail address.
- 3 Touch **Add friends** then **Yes**.
- 4 Your friends already using Latitude receive an e-mail request and a notification on Latitude requesting them to share locations. If they have not yet joined Latitude, they receive an e-mail that requests them to sign in to Latitude with their Google accounts.

### To accept an invitation

When you receive a request to share your location with a friend on Latitude, choose how you want to respond:

- **Accept and share your location:** You can see your friend's location, and your friend can see yours.
- **Accept, but hide your location:** You can see your friend's location, but they cannot see yours.
- **Don't accept:** Reject the sharing request. No location information is shared.

### To show your friends

You can show your friends on the map or in the list view.

- **Map view**

When you open Google Maps, it displays the locations of your friends. Each friend is marked by a photo icon with an arrow that indicates their location. To see a friend's profile and communicate with them, touch the photo, then touch their location callout right above their photo. To see other friends, touch either one of the arrow buttons next to the callout.

- **List view**

To show a list of your friends, touch the Menu button → **Latitude**. To see a friend's profile and communicate with them, touch the friend's name from the list.

## To connect with your friends

Touch a friend's name in map view or list view to open the friend's profile. In the profile screen, you can communicate with your friend and configure privacy options.

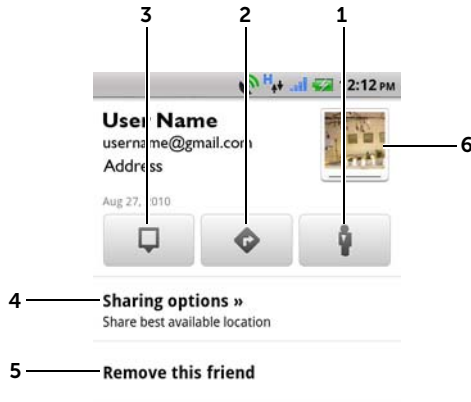

---

1 Switch to street view of the friend's location.

---

2 Get directions to the friend's location.

---

3 See a friend's location on the map.

---

### 4 Sharing options:

- **Share best available location:** Share street-level location with your friend.
  - **Share only city level location:** Share only the city or the approximate area you are in, not the street-level location. Your friend can see your photo icon in the middle of the city you are in.
  - **Hide from this friend:** Stop location sharing with this friend. Your friend cannot see your photo icon on the map.
- 

5 **Remove this friend:** Remove this friend from your list and end all location sharing.

---

6 Touch the thumbnail to open the pop-up menu. Depending on available settings, you may use **Messaging** and **Gmail** services to send a message to your friend.

---

## To control what to share and change your public profile

- 1 In Maps, touch the Menu button  → **Latitude**.
- 2 Touch your name to open your public profile window.

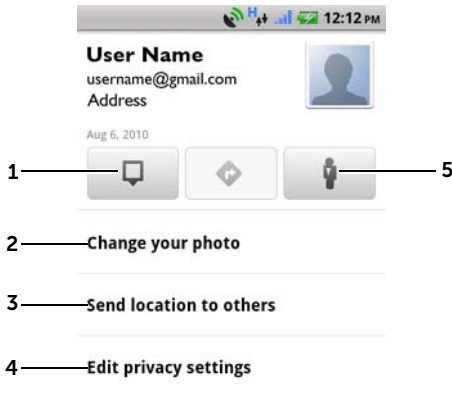

- 3 Set the following options based on your preferences.

---

- 1 See your location on the map.

---

- 2 **Change your photo:**

Change the picture that your friends see on the map or in their list of friends.

You can capture a picture using the Camera application, or select a picture from the Gallery.

---

- 3 **Send location to others:**

Touch if you want to send your location to others through **Bluetooth**, **Messaging**, or **Gmail**.

---



---

**4 Edit privacy settings:** Manage how your location is shared with your friends.

- **Turn off Latitude:** Disable Latitude and end location sharing.
- **Detect your location:** Latitude automatically detects and updates your current location.

**NOTE:** To let Latitude report your location, you must enable My location sources. For more information, see "To enable location source" on page 92.

- **Set your location:** Select a location from the map, contact addresses or nearby places, or type an address.
- **Hide your location.** All of your friends will not be able to see your location on their maps.

---

**5** Switch to street view of your location.

---

## Places

Touch the Launcher button  → **Places** .

Places automatically detects your current location and offers guide to nearby restaurants, coffee shops, bars, hotels, attractions, ATMs, gas stations, etc.

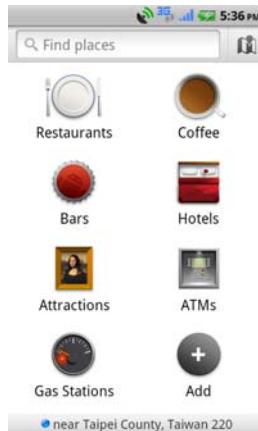

- 1 Touch to select a category.
- 2 From the list of places, touch the desired one to view more details. For more information on using the controls on this screen, see "To view the details of a place" on page 95.

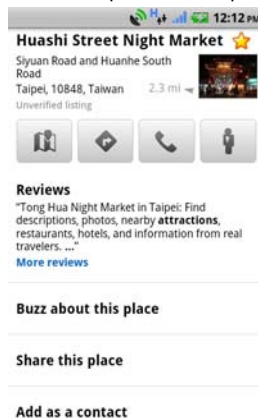

## Navigation



**NOTE:** Google Maps Navigation is not available in all areas.



**NOTE:** Google Maps Navigation is only available for use in the United States at this time.



**WARNING:** Ensure that you use this application in a safe and responsible manner. You must obey local traffic laws, posted road signs, and safety regulations. Do not operate your smartphone while driving.

Touch the Launcher button



→ **Navigation**



Google Maps Navigation is an internet-connected GPS satellite navigation system with voice guidance. Navigation provides the following features:

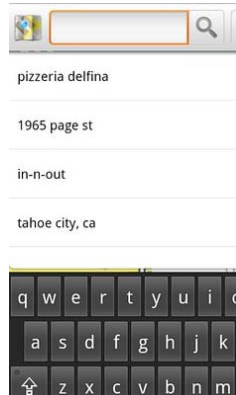

Feature	Description
Searching in plain language	Type a place, a name of a business, or a kind of business.

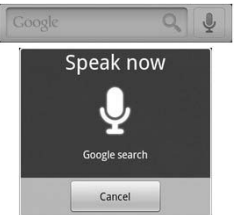

Feature	Description
Searching by voice	<p>Speak your destination using Google Search by voice (English only).</p> 

Traffic view	<p>Traffic view provides live traffic data and shows up-to-date traffic status on the screen. Touch the Menu button (☰) → <b>Layers</b> → <b>Traffic</b> to turn on Traffic view.</p>
--------------	---



Feature	Description
Searching along route	Search for any kind of business along your route. Touch the Menu button  → <b>Layers</b> to access popular types of places.
Satellite View	Satellite view allows you to view your route overlaid on 3D satellite views with Google's high-resolution aerial imagery. Touch the Menu button  → <b>Layers</b> → <b>Satellite</b> to turn on Satellite view.
Street View	Street view helps visualize turns with Street View imagery. Navigation automatically switches to Street View as you approach your destination.
Car dock mode	Place your phone in a car dock to access Navigation and Voice Search easily.

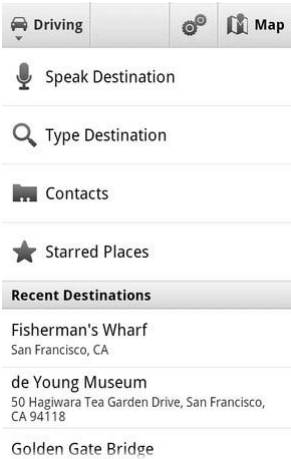

Feature	Description
Navigation shortcut	<ul style="list-style-type: none"> <li>• <b>Speak Destination:</b> Speak your destination.</li> <li>• <b>Type Destination:</b> Type your destination.</li> <li>• <b>Contacts:</b> Select a destination from the location of your contacts.</li> <li>• <b>Starred Places:</b> Select a destination from the list of Starred Places.</li> </ul>  <p>The screenshot shows a navigation interface with a top bar containing 'Driving', a settings icon, and 'Map'. Below this are four menu items: 'Speak Destination' with a microphone icon, 'Type Destination' with a magnifying glass icon, 'Contacts' with a contacts icon, and 'Starred Places' with a star icon. A 'Recent Destinations' section follows, listing 'Fisherman's Wharf' (San Francisco, CA), 'de Young Museum' (50 Hagiwara Tea Garden Drive, San Francisco, CA 94118), and 'Golden Gate Bridge'.</p>

Feature	Description
Walking navigation	Get voice-guided navigation for walking directions. Your smartphone vibrates for turn notifications.

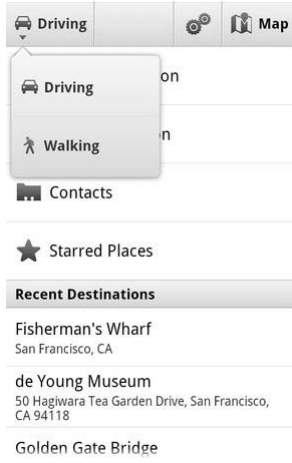

## News and Weather

Touch the Launcher button  → **News and Weather** .

### Weather

The Weather service automatically detects your current location and shows the local weather information.

If your current location is temporarily unavailable, you can set the location manually using the following instructions:

- 1 In the **News and Weather** screen, touch the Menu button  → **Settings** → **Weather settings**.
- 2 Clear the **Use my location** check box.
- 3 Touch Set location.
- 4 Enter a city or postal code.

- 5 Touch . The weather information will be updated to the location you manually set.

## News

When holding the smartphone in portrait format, flick pages horizontally to view news topics, such as Top Stories, U.S., Sports, and Entertainment. Touch the news headline you are interested in to view the full content.

### To add/remove news topics

To manage the news topics displayed on your smartphone:

- 1 In the **News and Weather** screen, touch the Menu button  → **Settings** → **News settings**.
- 2 Touch **Select news topics**.
  - Select the check boxes next to the news topics you want to display on the smartphone.
  - Clear the check boxes next to the unwanted news topics.

### To refresh news and weather settings

- 1 In the **News and Weather** screen, touch the Menu button  → **Settings** → **Refresh settings**.
- 2 To refresh the settings automatically, select the **Auto-refresh** check box.
- 3 Touch **Refresh interval** to adjust the refresh interval. Faster refresh intervals use more battery power.



**NOTE:** To refresh the settings manually, in the **News and Weather** screen, touch the Menu button  → **Refresh**.



## YouTube

YouTube is an internet video streaming service that allows you to view videos uploaded by YouTube members.





**NOTE:** Browsing and viewing videos does not require you to sign in to a YouTube account. However, to use all of the YouTube features, such as rating or commenting on a video or viewing “My account”, you must create and sign in to a YouTube account.

### To open YouTube



Touch the Launcher button  → **YouTube** .

The YouTube screen opens with the videos grouped into categories such as Most viewed, Most discussed, Top rated, and so on.

### To search for a video by typing

- 1 Touch the icon  on the top right of the YouTube screen, or touch the Menu button  → **Search** to open the search bar.
- 2 Type the video name or keyword into the search box using the on-screen keyboard. The search results that fully or partially match the text being typed appear below the search box. You can:
  - Scroll the search results and touch a desired one.
  - Touch the search key on the keyboard or the search icon  on the search box to search for results that match the entered text, then touch a desired search result.
- 3 Touch the video to start playing the video.

### To search for a video by voice command

- 1 Touch  on the top right corner of the YouTube screen, or touch the Menu button  → **Search** to open the search bar.
- 2 Touch .
- 3 Say the video name or a keyword.

- 4 The videos that match the words you said are listed.
- 5 Touch the video to start playing the video.



### To search for a video by category

- 1 Touch the Menu button  → **Categories**.
- 2 Scroll the listed categories and touch the category under which the video appears.
- 3 Touch to start playing the video.

### To filter videos by different time frames

- 1 In the search results that appear, touch the Menu button  → **Time filter**.
- 2 Select a time frame such as **Today** or **This week**.
- 3 The videos that match the selected time frame are listed.

### To watch videos

- 1 Select a video listed on the on the YouTube screen. The video starts playing automatically.
- 2 To control video playback, touch anywhere on the screen to display and use the playback controls.
- 3 To end playback, touch the Back button  or the Home button .

### To manage a video

- 1 When browsing videos in a list, touch and hold a video to open the options menu.  
When playing a video, touch the Menu button .
- 2 You can perform these actions that require signing in to your YouTube account.

<b>Rate</b>	Rate the video with stars.
<b>Favorite</b>	Add the video's web link to your browser bookmarks.
<b>Share</b>	Send the video's web link to others by e-mail.

---

<b>Comments</b>	Write and send your comments about the video.
<b>Flag</b>	If you find the video inappropriate to get posted and want to have it removed, you can flag the video to notify the service provider.

---



## Android Market

You can use Android Market to download and install applications and games on your smartphone.



**NOTE:** Applications downloaded from Android Market may not support automatic screen orientation to portrait or landscape.

### To open Android Market

- 1 Touch the Launcher button  → **Market** .
- 2 Sign in to Android Market with your Google account. If you do not have a Google account, follow the instructions on the screen to create an account (see "To set up your Google account" on page 85).
- 3 Touch the **Accept** button after you read and agree with the **Android Market Terms of Service**.

4 The Android Market screen opens.



- 
- 1
- Touch **Apps** to view the application categories. All applications available for download are sorted by these categories.
  - Touch **Games** to view the game categories. All games available for download are sorted by these categories.
- 
- 2
- The Market screen displays popular application categories here for direct access.
- 
- 3
- The Market screen opens with featured applications for direct access.
- 
- 4
- Shows user rating about the item and whether it is free or requires a purchase.
- 
- 5
- Touch **Downloads** to view your downloads.
- 
- 6
- Touch to search Android Market for applications or games.
-

When a category is selected, for example, touch the **Games** tab→ **Brain & Puzzle**:

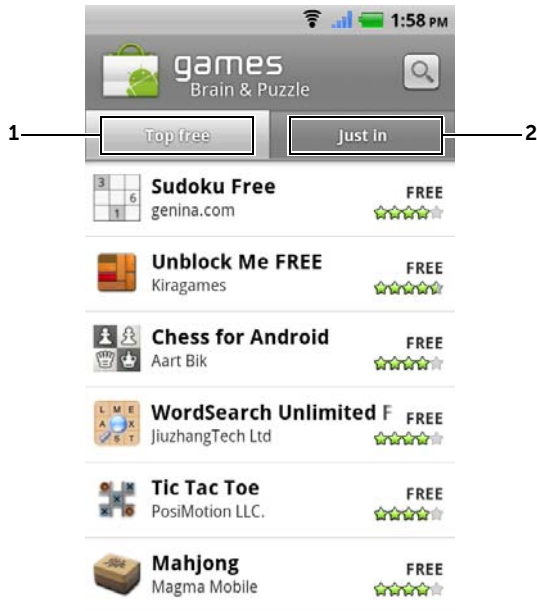

- 
- 1 Touch **Top free** to sort the items by rating.
  - 2 Touch **Just in** to sort by date.
- 





### To download and install an application or game

- 1 Scroll and browse listed applications or games to locate the desired application.
- 2 Touch the application or game you want to download and install.
- 3 On the application details screen, you can read the introduction to the application or game, user ratings and comments, and developer information.



**NOTE:** Touch the Menu button (☰) → **Security** to view the functions or data that the application or game can access on your smartphone.

- 4 On the application details screen, touch **Install** to start download and installation. The application's download screen displays the progress of the download.

-  **NOTE:** If the application requires access to any of your data or functions on your smartphone, Market displays the information that the application can access. Touch the **OK** button to start download and installation.
  -  **NOTE:** During installation, the downloading icon  appears in the notification area of the status bar. Touch the notification area of the status bar to open the Notifications panel and check download progress.
  -  **NOTE:** To stop downloading an application, touch **Cancel download** on the application's download screen.
- 5 After the application is downloaded and installed on your smartphone, the download complete icon  appears in the notification area of the status bar.

### To open an application or game

From the Market screen:

- 1 Touch the **Downloads** tab on the Market screen.
- 2 Touch the installed application in the list.
- 3 Touch the **Open** button. The selected application starts running.

From the main application menu:

- 1 Touch the Launcher button .
- 2 Touch the application's icon.

From the status bar:

- 1 Drag down the status bar to view the Notifications panel where the download complete icon  appears to indicate a recently downloaded application.
- 2 Touch the name of the application you want to open.



### To uninstall an application or game



- 1 On the downloads screen, touch the application you want to uninstall.
- 2 Touch **Uninstall**.
- 3 After the uninstall is completed, you can select the reason for removing the application.



## Synchronizing Your Google Data

Through a web connection, your smartphone can synchronize your Google data including Gmail, calendar, and contacts with your computer or any other device that you use to access your Google account.

### To select the applications to synchronize

- 1 Touch Home button  → Menu button  → **Settings** → **Accounts & sync**.
- 2 Under the **General sync settings** bar, touch to select **Background data** to make all the sync options available.
- 3 Under the **General sync settings** bar, touch to select **Auto-sync** to allow the device to automatically synchronize the selected data.
- 4 Under the **Manage accounts** bar, touch your account to select the data that you want the smartphone to synchronize automatically: **Picasa Web Albums, Contacts, Gmail, and/or Calendar**.







 **NOTE:** If you want to synchronize individual applications manually, touch to clear the **Auto-sync** check box, then touch a data option to start synchronization of the touched data. To sync all of the data manually, touch the Menu button  → **Sync now**.

 **NOTE:** While data is syncing, the sync icon  appears on the status bar, and the sync icon  appears on the option of the data being synced.

# 5 Customizing Your Dell Venue Smartphone

You can customize your smartphone, using the options available in the **Settings** menu.

## To change the display settings

- 1 Touch the Home button  → Menu button  → **Settings** → **Display**, or  
touch the Launcher button  → **Settings** icon  → **Display**.
- 2 Touch the desired item under **Display settings**.
- 3 To enable a setting, touch the setting option to select the check box ; to disable a setting, touch the setting option to clear the check box .

---

### Brightness

Manually adjust screen brightness.

- 1 Drag the brightness slider horizontally or touch the desired portion on the slider. The length of the highlighted bar on the slider determines the brightness of the screen.

- 2 Touch **OK** to confirm the adjustment.

**NOTE:** If **Automatic brightness** is enabled, the smartphone adjusts the screen brightness automatically based on the surrounding light conditions.

---

### Auto-rotate screen

If enabled, the screen will switch the orientation to landscape or portrait as you rotate the smartphone.

---

### Animation

Set the smartphone to play an animation when opening and closing windows.

---



---

## Screen timeout

- Set how long the screen remains on after the last operation. Scroll the options and touch a preferred timeout period; to disable this feature select **Never timeout**.
- The screen automatically turns off and locks itself based on the preset timeout duration.
- To turn on and unlock the screen, press the

Power button and then flick the





icon right to unlock the screen if it is automatically locked.

**NOTE:** If you select **Never timeout**, the screen does not turn off, and depletes the battery charge soon.

**NOTE:** You must draw the unlock pattern if you have set up and enabled the screen lock pattern. For more information, see "Protect Your Smartphone Data With a Screen Unlock Pattern" on page 125.

---

## To change sound and ringtone settings

- 1 Touch the Home button  → Menu button  → **Settings** →

**Sound**, or touch  → **Settings** icon  → **Sound**.

Use the options under **Sound settings**, and then touch a desired option.

- 2 Flick the list to locate and touch a desired option.
- 3 To enable a setting, touch the setting option to select the check

box ; to disable a setting, touch the setting option to clear

the check box .

## General settings

<b>Silent mode</b>	Silence all sounds except media and alarms.
<b>Vibrate</b>	Set the smartphone to vibrate based on the available settings.
<b>Volume</b>	<ul style="list-style-type: none"><li>• <b>Ringtone:</b> Adjust ringer volume for incoming calls and notifications.</li><li>• <b>Media:</b> Adjust volume for music and video playback.</li><li>• <b>Alarm:</b> Adjust volume for alarm ringtone.</li></ul> <ol style="list-style-type: none"><li>1 To adjust volume, drag the sliders horizontally or touch the desired portion of the slider to increase or decrease volume.</li><li>2 If you want to set a different volume for notifications, touch <b>Use incoming call volume for notifications</b> to clear its check box. Then adjust the <b>Notification</b> volume.</li><li>3 Touch <b>OK</b> to confirm the adjustment.</li></ol>

## Incoming calls settings

<b>Phone ringtone</b>	Select the desired ringtone for incoming calls.
-----------------------	---





## Notifications settings

<b>Notification ringtone</b>	Select the desired ringtone for notifications.
<b>Notification sound</b>	Enables/disables notification sound.

## Feedback settings

<b>Audible touch tones</b>	Plays a tone as you dial using the on-screen dialpad.
<b>Audible selection</b>	Plays a tone as you touch the screen to select items.
<b>Screen lock sounds</b>	Plays a tone when the screen is locked and unlocked.
<b>Haptic feedback</b>	The smartphone vibrates when you touch some buttons on the screen in certain circumstances.

# To manually set the date, time and time zone

- 1 Touch the Home button  → Menu button  → **Settings** → **Date & time**.
- 2 Touch the desired option.
- 3 Flick the list to locate and touch the desired item.
- 4 To enable a setting, touch the setting option to select the check box ; to disable a setting, touch the setting option to clear the check box .



---

## Select time source

- **Manual:** Allows you to manually adjust the date, time zone and time.
- **Mobile Cell Network:** Your smartphone automatically displays the date, time zone and time provided by the mobile cell network.
- **Internet:** Your smartphone automatically displays the date, time zone and time provided by the Internet time server.

---

## Set date



- 1 Touch or touch and hold  or  to adjust the month, day and year; you can also touch the month, day or year to type a date using the on-screen keyboard.
- 2 Touch **Set** to confirm the date.

---





## Select time zone

Select a city or region that represents the time zone for your smartphone. Touch the Menu button  to sort the time zone list alphabetically or by time zone.

---

<b>Set time</b>	<ol style="list-style-type: none"> <li>1 Touch or touch and hold  or  to adjust the hour and minute; you can also touch the hour or minute to type a time using the on-screen keyboard.</li> <li>2 Touch the AM/PM button if the 12-hour format is in use.</li> <li>3 Touch <b>Set</b> to confirm the time.</li> </ol>
<b>Use 24-hour format</b>	Clear this check box to display the time in 12-hour format.
<b>Select date format</b>	Select a format used for displaying the date.

## To set the language

- 1 Touch the Home button  → Menu button  → **Settings** → **Language & keyboard** → **Select language**, or touch  → **Settings** icon  → **Language & keyboard** → **Select language**.
- 2 Select a language of your choice from the Locale list that appears.

# 6 Protecting Your Dell Venue Smartphone

## Protect Your Smartphone Data With a Screen Unlock Pattern

You can protect your smartphone data against unauthorized access by locking the touch screen with a screen unlock pattern. Once the unlock pattern is enabled and the screen is locked, you need to draw the correct unlock pattern to unlock the screen.





After you fail to draw the correct unlock pattern on the screen for five consecutive times, you will be asked to wait for 30 seconds before you can try again. If you no longer remember your screen unlock pattern, follow these steps to unlock your screen:

- 1 Touch **Forgot pattern**.
- 2 When prompted, sign on to the Google website using your Google account name and password.
- 3 Draw a new screen unlock pattern as described in "To create a screen unlock pattern" on page 125.



**NOTE:** If you are unable to obtain a new unlock pattern following the above steps, visit [support.dell.com](http://support.dell.com).

### To create a screen unlock pattern

- 1 Touch the Home button  → Menu button  → **Settings** → **Location & security** → **Set up screen lock** → **Pattern**, or touch the Launcher button  → **Settings** icon  → **Location & security** → **Set up screen lock** → **Pattern**.
- 2 Read the instructions on the screen and then touch **Next**.

- 3 Study the animated example of how to draw a pattern. Then touch **Next** when you are ready to draw your own pattern.

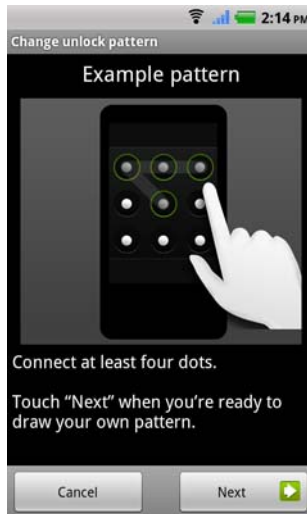

- 4 Drag your finger to draw an unlock pattern by connecting at least four dots in a vertical, horizontal and/or diagonal direction. Take your finger off the screen when a pattern is drawn.







 **NOTE:** You touch and drag your finger on the screen to create the pattern.

- 5 The smartphone records the pattern if it is correctly drawn. Touch **Continue**.

- 6 Draw the pattern again as prompted, and then touch **Confirm**.

 **NOTE:** To change your unlock screen pattern, you need to draw the old pattern and perform steps 4 to 6 to create a new pattern.

## To enable or disable the screen unlock pattern and change related settings

- 1 Touch the Home button  → Menu button  → **Settings** → **Location & security** → **Change screen lock**, or  
touch the Launcher button  → **Settings** icon  → **Location & security** → **Change screen lock**.
- 2 To enable a setting, touch the setting option to select the check box ; to disable a setting, touch the setting option to clear the check box .

---

### Change screen lock

- Select **None** to disable screen unlock security.
- Select **Pattern** to enable screen unlock security by drawing an unlock pattern.
- Select **PIN** to enable screen unlock security by entering a PIN code.
- Select **Password** to enable screen unlock security by entering a password.

---

### Use visible pattern

Clear the **Use visible pattern** check box if you do not want the lines of the unlock pattern to display on the screen when you draw it.





---

### Use tactile feedback

Clear this option if you do not want the smartphone to give you tactile feedback when drawing the unlock pattern.





---

# Protect Your Smartphone Data With a PIN

- 1 Touch the Home button  → Menu button  → **Settings** → **Location & security** → **Set up screen lock** → **PIN**, or touch the Launcher button  → **Settings** icon  → **Location & security** → **Set up screen lock** → **PIN**.
- 2 In the **Choose your PIN** screen, type a PIN in the text box. Your PIN must have a minimum of 4 characters.
- 3 Touch **Continue** to proceed.
- 4 Enter the PIN code again to confirm.
- 5 Touch **OK**.

To unlock your screen using the PIN, type the PIN and touch **OK**.

# Protect Your Smartphone Data With a Password

- 1 Touch the Home button  → Menu button  → **Settings** → **Location & security** → **Set up screen lock** → **Password**, or touch the Launcher button  → **Settings** icon  → **Location & security** → **Set up screen lock** → **Password**.
- 2 In the **Choose your password** screen, type a password in the text box. Your password must have a minimum of 4 characters, and must include a letter.
- 3 Touch **Continue** to proceed.
- 4 Enter the password again to confirm.
- 5 Touch **OK**.

To unlock your screen using the password, type the password and touch **OK**.







# Protect Your SIM Card With the SIM Lock Password

You can protect your SIM card against unauthorized use with a personal identification number (PIN). After a PIN is enabled to lock your SIM, you will need to enter the PIN each time you turn on the smartphone in order to unlock your SIM.





 **NOTE:** The SIM card will be permanently locked if you enter an incorrect PIN in three consecutive attempts. You must then enter the Personal Unblocking Key (PUK) to unlock the SIM card. Please contact your service provider to obtain the PUK.

 **NOTE:** You can make emergency calls without unlocking the SIM.

## To enable the SIM card PIN

- 1 Touch the Home button  → Menu button  → **Settings** → **Location & security** → **Set up SIM card lock** → **Lock SIM Card**, or touch the Launcher button  → **Settings** icon  → **Location & security** → **Set up SIM card lock** → **Lock SIM Card**.
- 2 Type your SIM card PIN using the on-screen keyboard, and then touch **OK**.

## To change the SIM card PIN

- 1 Touch the Home button  → Menu button  → **Settings** → **Location & security** → **Set up SIM card lock** → **Change SIM PIN**, or touch the Launcher button  → **Settings** icon  → **Location & security** → **Set up SIM card lock** → **Change SIM PIN**.
- 2 Type the old SIM card PIN using the on-screen keyboard, and then touch **OK**.
- 3 Type the new SIM card PIN, and then touch **OK**.
- 4 Type the new SIM card PIN again, and then touch **OK**.

# 7 Applications



## Camera

Your smartphone has a 8.0 megapixel camera with auto-focus feature that allows you to capture and share high-quality pictures and videos.

 **NOTE:** Before you use the camera application, you need to install a microSD card in your smartphone. All pictures and videos that you capture using your smartphone's camera are stored on the microSD card. For more information on how to install a microSD card on your smartphone, see "Install the microSD card" on page 8.

### To launch the camera in picture mode

To launch the camera, do one of the following:

- Press and hold the camera button.
- Touch the Launcher button  → **Camera** .

### Camera controls

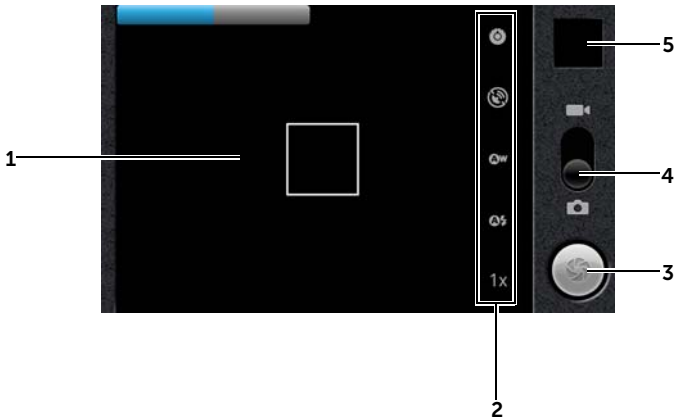

- 
- 1 Viewfinder screen.
  - 2 Camera setting indicator. Touch each indicator to open the camera settings.
-

- 
- 3
    - On-screen shutter button.
    - To capture a picture:
      - 1 Focus on the object in the viewfinder screen.
      - 2 To start the auto focus mode, half-press and hold the camera button, or touch and hold the on-screen shutter button.
      - 3 Touch the on-screen shutter button or press the camera button all the way down and release to capture the picture.

**NOTE:** To achieve optimal focus such as for taking a close shot, half-press and hold the camera button to use the auto-focus mode. Then without releasing the camera button, press it again to capture the picture.
- 
- 4 Drag this on-screen switch to toggle between the camera mode for capturing pictures, and the camcorder mode for shooting videos.
- 
- 5 Touch the thumbnail view of the last taken picture to view and manage the picture.
- 

### To manage pictures

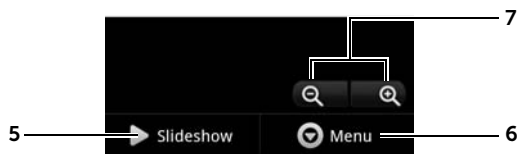
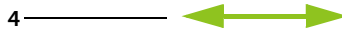
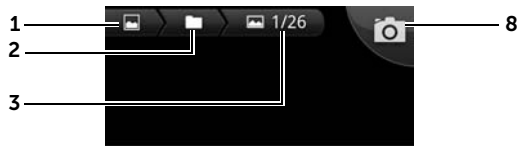

- 
- 1 Touch to return to the Gallery main page.
  - 2 Touch to return to the album the current picture belongs to.
  - 3 Display current/total number of pictures.
-

- 
- 4 Flick horizontally to view the previous or next picture.

---

  - 5 Touch to run a slideshow of the pictures stored in the same album.

---

  - 6 Touch to view more actions you can do with the picture.
    - **Share:** Touch to select a way to share the picture.
      - Select **Picasa** to upload the picture to Picasa to allow your friends see it.
      - Select **Bluetooth** to send the picture to another paired Bluetooth device, or print the picture using a paired Bluetooth printer.
      - Send the picture using **Messaging** or **Gmail**.
    - **Delete:** Touch to delete the picture from your smartphone.
    - **More:**

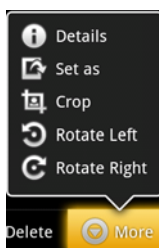

- **Details:** Touch to view detailed information about the picture.
- **Set as:** Touch to set the picture as a contact’s visual caller ID, or the wallpaper of the Home screen. Drag and move the frame to crop the desired portion as the wall paper.
- **Crop:** Touch to drag and move the frame to crop the desired portion of the picture.
- **Rotate Left:** Touch to rotate the picture 90 degrees counterclockwise.
- **Rotate Right:** Touch to rotate the picture 90 degrees clockwise.

- 
- 7 Touch to zoom-in or zoom-out the picture.

**NOTE:** You can also tap anywhere inside the picture frame to toggle between the zoom-in and zoom-out states. After a picture is zoomed in, you can flick the screen to see the desired portion of the picture.

- 
- 8 Touch to return to the camera viewfinder.
-

## To start the camcorder mode

Touch the Launcher button  → Camcorder .

## Camcorder controls

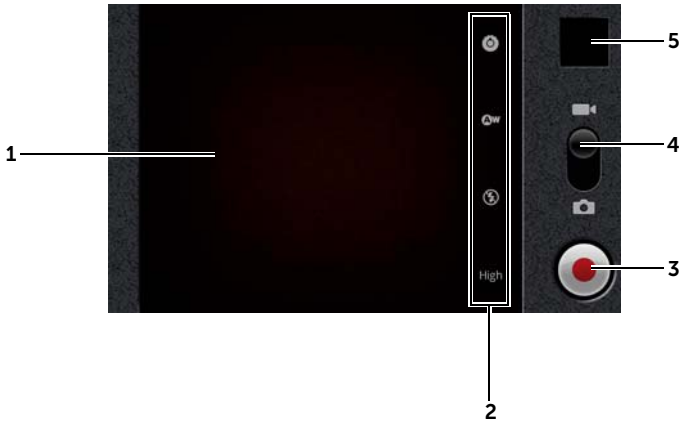

- 
- 1 Viewfinder screen.
  - 2 Camcorder setting indicator. Touch each indicator to open the camcorder settings.
  - 3 To start or stop recording, touch this on-screen video recording button or press the camera button.
  - 4 Drag this on-screen switch to toggle between the camera mode for capturing pictures, and the camcorder mode for shooting videos.
  - 5 Touch the thumbnail view of the last captured video to play and manage the video.
-

## To manage videos

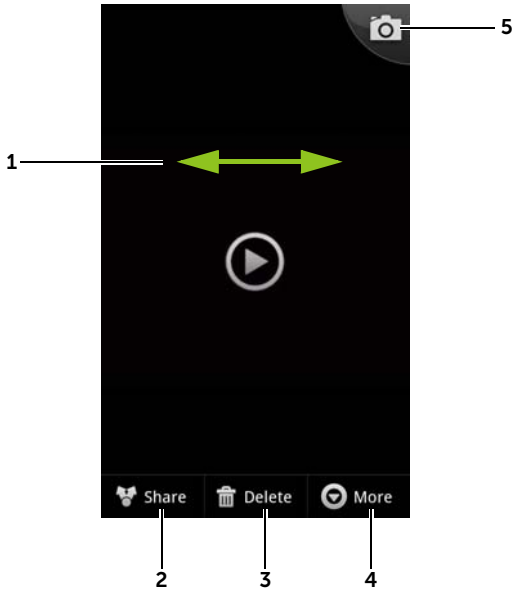

- 
- 1 Flick horizontally to view the previous or next video.

---

  - 2 **Share:** Touch to select a way to share the video.
    - Select **YouTube** to upload the video to the video streaming website YouTube, where people can view the posted video. To upload videos to YouTube, you must first sign in to your YouTube account.
    - Select **Bluetooth** to send the video to another paired Bluetooth device.
    - Send the video using **Messaging** or **Gmail**.

---

  - 3 **Delete:** Touch to delete the video from your smartphone.

---

  - 4 **More:**
    - **Details:** Touch to view detailed information about the video.

---

  - 5 Touch to return to the camera viewfinder.

---

# Copying Files to and from the MicroSD

The files on your smartphone are stored on the microSD card. To exchange pictures, videos, music, and other files between your smartphone and a computer, use the microSD card as a USB drive by connecting the smartphone to a computer with the included USB cable.

## To set the microSD card as a USB drive

- 1 Connect one end of the USB cable to the micro-USB connector on your smartphone and the other end to an available USB connector on your computer.
- 2 The USB notification icon  appears on the status bar's notification area.
- 3 Drag down the status bar, and from the Notifications panel that opens, touch **USB connected**.
- 4 Touch **Turn on USB storage** → **OK**, if you want to copy files between your computer and the microSD card.
- 5 Open the **My Computer** window on your computer to locate a removable drive that maps to the microSD card installed on your smartphone. Then copy desired files such as music or pictures from another drive/folder to the removable drive, or vice versa.

## To turn off USB storage

The smartphone will not recognize the microSD card when the card is used as a USB drive. You will not be able to use the smartphone's applications that involve saving or retrieving files on the microSD card, such as camera or music playback. You need to turn off USB storage for the smartphone to recognize the microSD card when the smartphone is connected to a computer.

To turn off the USB storage function:

- 1 Drag down the status bar to open the Notifications panel.
- 2 Touch **Turn off USB storage**.

### To remove the microSD card

- 1 Press and hold the Power button and then touch the **Power off** option to turn the smartphone off.
- 2 Remove the back cover.
- 3 Slide and lift the microSD card out of the microSD card slot on the smartphone.

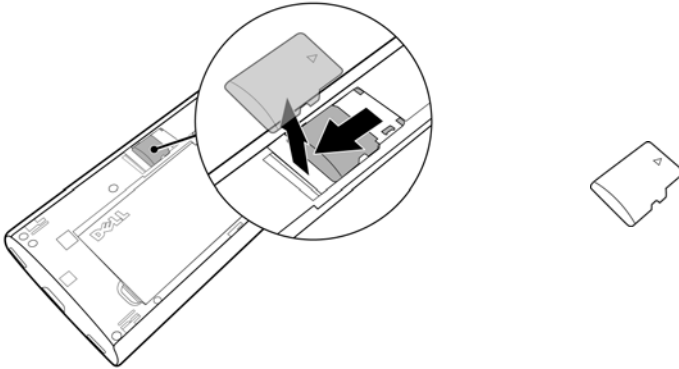

## Bluetooth



Bluetooth is a short-range wireless communications technology that lets your smartphone connect over a wireless network to other Bluetooth-enabled devices for data exchange.

Bluetooth on your smartphone operates in three different modes:

<b>On</b>	Bluetooth is turned on. Your smartphone is enabled to detect Bluetooth devices within range, but will not be found by them.
<b>Discoverable</b>	Bluetooth is turned on, and other Bluetooth devices can detect your smartphone.
<b>Off</b>	Bluetooth is turned off. Your smartphone is unable to send and receive data using Bluetooth.



## To turn on Bluetooth and make the smartphone discoverable

- 1 Touch the Home button  → Menu button  → **Settings** → **Wireless & networks**.
- 2 Select the **Bluetooth** check box to turn on Bluetooth. The Bluetooth icon  appears in the status bar.
- 3 Touch **Bluetooth settings**, then select the **Discoverable** check box to make the smartphone recognizable by other nearby Bluetooth devices.

## To pair and connect a Bluetooth headset

- 1 Touch the Home button  → Menu button  → **Settings** → **Wireless & networks** → **Bluetooth settings**.
- 2 Touch and select the **Bluetooth** check box. Your smartphone starts to scan for Bluetooth devices within range and then displays all detected devices in the **Bluetooth devices** section.



**NOTE:** To detect more devices, touch **Scan for devices**.

- 3 To initiate a connection with a device, touch the name of the device.
- 4 You may be prompted to enter a password to authenticate. Enter the same password on both devices, or enter the specific password provided by the device manufacturer. Ensure that you read the documentation of the pairing device to check if it requires a default password.
- 5 When the pairing is successful, **Paired but not connected** is displayed under the paired device.
- 6 Touch the paired device to start the connection. When the paired device is successfully connected to your smartphone, the Bluetooth connected icon  appears in the status bar.



**NOTE:** To make and receive calls or listen to the music using a Bluetooth headset, pair the headset to your smartphone.





**NOTE:** Pairing is a one-time process. Once your smartphone successfully pairs with another device, your smartphone recognizes that device without the need to re-enter the password.



### To end a Bluetooth connection

- 1 Touch the Home button  → Menu button  → **Settings** → **Wireless & networks** → **Bluetooth settings**.
- 2 Touch and hold the name of a connected device.
- 3 Touch **Disconnect** on the pop-up menu that appears.



### To terminate a pairing partnership

- 1 Touch the Home button  → Menu button  → **Settings** → **Wireless & networks** → **Bluetooth settings**.
- 2 Touch and hold the name of a paired device.
- 3 Touch **Unpair** on the pop-up menu that appears to erase all pairing information with that device. You need to enter the password again if you want to restore a Bluetooth connection to that device.

### To change your smartphone's Bluetooth name

- 1 Ensure that you have turned on Bluetooth on your smartphone ( indicates in the status bar that Bluetooth is enabled).
- 2 Touch the Home button  → Menu button  → **Settings** → **Wireless & networks** → **Bluetooth settings** → **Device name**.
- 3 Enter a name to identify the smartphone when you connect using Bluetooth.
- 4 Touch **OK**.

## Photos and Videos

To view and manage the pictures and videos stored on your smartphone, touch the Launcher button  → **Gallery** .

 **NOTE:** Refer to "Using the GALLERY Stage widget" on page 30 as an alternative way of using Gallery.

The Gallery application displays not only the pictures and videos stored on your microSD card, but also those uploaded to the Picasa web album of your Gmail account which you signed in with on your smartphone.



 **NOTE:** Before you run the Gallery application, ensure that a microSD card containing media files is installed on your smartphone. All pictures and videos that you capture using your smartphone's camera are stored on the microSD card. For more information on installing a microSD card on your smartphone, see "Install the microSD card" on page 8.

### To share or delete albums

All pictures and videos are grouped in separate albums as overlapping thumbnails, according to their dates, sources, or folders in which they are stored. For example, pictures captured using the smartphone's camera are grouped as **Camera**, and downloaded pictures are grouped as **download**.

- 1 Touch and hold an album until the check box  appears.
- 2 Touch more albums to select them if you want to do the same task for those albums.
  - To post the selected album to YouTube, Picasa, or to send it using Bluetooth, Messaging or Gmail, touch **Share**.
  - To delete the album, touch **Delete**.

### To browse picture and video thumbnails

- 1 Touch an album to display the thumbnails of all pictures and videos inside.
- 2 To browse the thumbnails:
  - Touch or drag  to display all the thumbnails in grid view, or group them by date as overlapping thumbnails.
  - When the thumbnails are displayed in grid view, drag  or touch the arrows on it to move thumbnails horizontally, until the desired thumbnail is located.
- 3 To select a thumbnail, touch and hold it until  appears; touch more thumbnails as you need.



- To post a selected picture or video to YouTube, Picasa, or to send it using Bluetooth, Messaging or Gmail, touch **Share**.
- To delete a selected picture or video, touch **Delete**.
- To set a picture as the Home screen wallpaper, touch **More**→ **Set as**→ **Wallpaper**.

### To display a full picture



Touch a desired picture thumbnail to display the picture in full screen.

- Flick the picture to view the next or previous picture.
- To see the picture viewing controls, touch anywhere on the picture.
- To zoom-in or zoom-out on the picture, you can:
  - Touch .
  - Pinch the picture with two fingers, then move the fingers apart to enlarge the picture, or bring them closer together to reduce the picture.
  - To zoom in or out a particular area of the picture, tap that area twice.
  - When a picture view is being enlarged, flick or drag the enlarged picture across the screen until the required area appears.

### To play a video

- 1 Touch a video thumbnail to start playback of the video.
- 2 To control playback, use these controls below the viewing screen:
  - Touch the  button to pause and the  button to resume playback.
  - Touch or drag the blue playback progress bar to rewind or fast-forward the video.

# Music

-  **NOTE:** The Music application only plays audio files saved on the microSD card of your smartphone. Before opening Music, ensure that the needed audio files have been copied to the microSD card of your smartphone.
-  **NOTE:** Refer to "Using the MUSIC Stage widget" on page 31 as an alternative way of using Music.

## To open Music

Touch the Launcher button  → **Music** .

The Music library screen appears and displays the music files grouped in the **Artists**, **Albums**, **Songs**, and **Playlists** tabs. You can touch a tab to display the desired category.

All the music files available on your smartphone are grouped into one of the following categories: **Artists**, **Albums**, **Songs**, and **Playlists**.

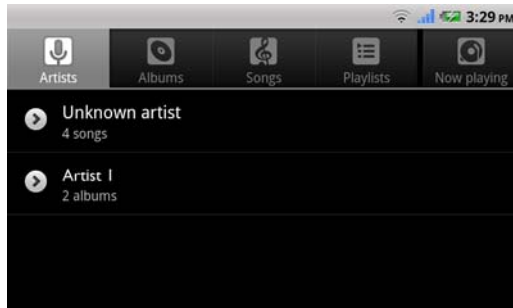

-  **NOTE:** If you rotate your smartphone to landscape format, an additional **Now playing** tab appears.

## To select a song

- 1 Touch an album or category to view the list within it.
- 2 Inside a category, flick the list until you find the music you want to play. For instance, to select music by artist:
  - a Touch **Artists**. A list of artists appears in alphabetical order.

- b Flick the list and touch the name of an artist. A list displays the songs by the artist according to the album name.
- c Touch a music file to open the music playback screen and play the music.

**To control music playback**

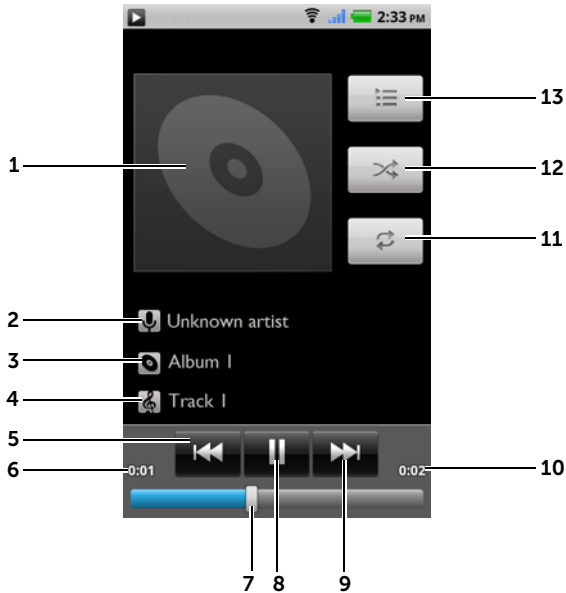

- 
- 1 The album's cover image if available.

---

  - 2 The name of the artist.

---

  - 3 The name of the album.

---

  - 4 The name of the song being played.



---

  - 5
    - If the song is playing for more than five seconds, touch to jump to the beginning of the song.
    - If the song is playing for less than five seconds, touch to play the previous song.



---

  - 6 The current playback time.

---

- 
- 7
    - Touch the playback control bar to jump to any part of the song.
    - Drag and scroll the playback control bar forward to fast-forward the song.
    - Drag and scroll the playback control bar backward to rewind the song.
- 
- 8 Touch  to pause playback; touch  to resume playback.
- 
- 9 Touch to play the next song.
- 
- 10 The duration of the song.
- 
- 11 Touch to cycle through the repeat modes.
- 
- 12 Touch to turn the shuffle mode on and off.
- 
- 13 Go to the Now playing list.
- 

 **NOTE:** Press the volume up button or volume down button to adjust the playback volume.

 **NOTE:** On the Music screen, touch the Menu button  → **Shuffle all** to play all songs in your library in random order. The first randomly selected song starts to play.

### To create a playlist

- 1 On the **Music** screen, touch the **Artists**, **Albums**, or **Songs** tab.
  - 2 Flick the screen until you reach the artist, album, or song that you want to add to the playlist.
  - 3 Touch and hold the artist, album, or song that you want to add in the playlist. A pop-up menu appears.
  - 4 Touch **Add to playlist**.
  - 5 In the **Add to playlist** window, touch **New**.
-  **NOTE:** If you want to add the artist, album, or song to the current playlist, touch **Current playlist** in the **Add to playlist** options menu.
- 6 Enter the name for your new playlist in the text field and then touch **Save**.

# Calendar

Use the calendar to schedule and manage your events, meetings, and appointments.

## To open the calendar

Touch the Launcher button  → **Calendar** .

## To set up an event

- 1 On any calendar view, touch the Menu button  → **More** → **New event** to open the **Event details** screen.
- 2 Type the event name using the on-screen keyboard.
- 3 If there is a time period for the event, touch and type the **From** and **To** date and time.  
If the event is a special occasion such as a birthday or spans the whole day, set the **From** and **To** date, and then select the **All day** check box.
- 4 Type the event location and description.
- 5 If you have more than one calendar, you can choose the calendar to which to add the event.
- 6 Set the event reminder time in **Reminders**, then decide whether it is a recurring event in **Repetition**.
- 7 Touch **Done**.



**NOTE:** To quickly set up an event in day, week, or month view, touch and hold an empty time slot → **New event**. A new **Event details** screen appears with the selected time slot and date in the **From** and **To** fields.

## To view the calendar

You can display the calendar in daily, weekly, monthly, or agenda view.

To change the calendar view, touch the Menu button  → **Day/Week/Month/Agenda/Today**.

While viewing the calendar you can:



- In day or week views, touch an event to open a quick view window of the event on the lower part of the screen.
- Touch the quick view window to view details about the event.
- Touch and hold an event to open a menu with options for viewing, editing, or deleting the event, or creating a new event.

### To view and synchronize multiple calendars

If you have set up more than one account on your smartphone, you can view multiple calendars from the accounts on your smartphone. You can configure which calendars to synchronize to the smartphone, and which of those to show or hide on the smartphone in **Calendar**.

To set whether calendars are synchronized to the smartphone or visible, follow the steps below.

- 1 In **Calendar**, touch the Menu button  → **More** → **Calendars**.

The **Calendars** screen displays all the calendars you have added or subscribed to for each account on your smartphone, organized by account. Touch the name of an account to show or hide its calendars on your smartphone. An icon to the right of each calendar indicates whether its events are synchronized to the smartphone and whether they are visible in **Calendar**.

- 2 Touch the icon next to a calendar to change whether it is synchronized to the smartphone and visible in **Calendar**.



Calendar events are synchronized to the smartphone and visible in **Calendar**.



Calendar events are synchronized to the smartphone but not visible in **Calendar**.





Calendar events are not synchronized to the smartphone.

- 3 Touch **OK**.

### Event reminders

If you set a reminder for an event, the upcoming event icon  appears in the notifications area of the status bar at the time of the event.



### To view, dismiss, or snooze a reminder

- 1 Touch the notification area of the status bar, to open the notification menu.
- 2 Touch the upcoming event name to display the event.  
 **NOTE:** If you have other pending event reminders, these events will also appear on the screen.
- 3 Touch **Snooze all** to put off all event reminders for five minutes. Touch **Dismiss all** to turn off all event reminders.  
Press  to keep the reminders pending in the notification area of the status bar.

## Alarm Clock

Your smartphone can work as an alarm clock. You can set as many alarms as you require.



### To open the alarm clock

- 1 Touch the Launcher button  → **Clock** .
- 2 Touch .

### To set an alarm



- 1 On the **Alarms** screen, touch **Add alarm**.
- 2 Set the alarm time as needed.
- 3 The **Set alarm** menu appears with these settings:

---

<b>Turn on alarm</b>	Turn on the alarm that you have set on the smartphone.
<b>Time</b>	Set the alarm time. Adjust the time by touching  or  , or touch the hour and minute fields to enter a time. Touch <b>AM</b> to change to <b>PM</b> or vice versa, then touch <b>Set</b> when done.

---

<b>Repeat</b>	Select the days you want the alarm to ring, then touch <b>OK</b> .  <b>NOTE:</b> If you did not select any days for the alarm, <b>Never</b> appears to hint that your alarm will only go off once.
<b>Ringtone</b>	Select the alarm ringtone.
<b>Vibrate</b>	Select the check box if you want the smartphone to vibrate when the alarm goes off.
<b>Label</b>	Give the alarm a name for a special event.

 **NOTE:** On the **Alarm Clock** screen you can also add a new alarm by touching the Menu button  → **Add alarm**.

### To temporarily disable an alarm

On the **Alarms** screen, touch to clear the green bar that appears next to the alarm you want to disable.

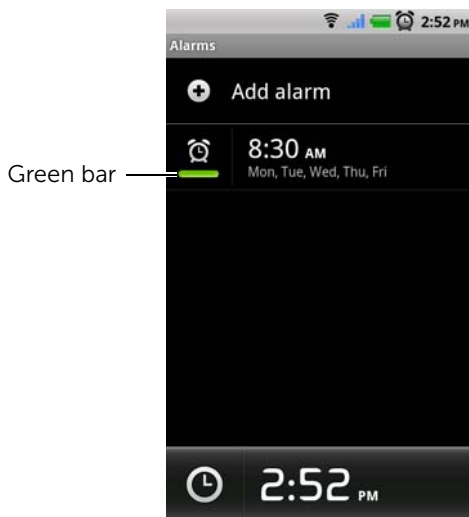

### To delete an alarm



- 1 On the **Alarms** screen, touch the alarm time you want to delete.
- 2 On the **Set alarm** screen, touch **Delete**.

## To silence all alarms

You can change the settings to choose if the alarm should ring when the smartphone is in Silent mode.

- 1 On the **Alarms** screen, touch the Menu button  → **Settings**.
- 2 Touch **Alarm in silent mode** to set the alarm to ring when the smartphone is in Silent mode.







## Calculator

- 1 Touch the Launcher button  → **Calculator** . The basic calculator panel opens.
- 2 Perform calculations by touching the corresponding buttons on the calculator panel; touch the **CLEAR** button to clear the displayed numbers or symbols.
- 3 To perform advanced calculations, flick the basic calculator panel away to the left and reveal the advanced panel, or touch the Menu button  → **Advanced panel**.

## Sound Recorder

The sound recorder allows you to record sounds and play them. You can also set the recording as a ringtone for your smartphone.

 **NOTE:** Sound Recorder only supports recording in amr format.

- 1 Touch the Launcher button  → **Sound Recorder** .
- 2 Touch  to start recording.
- 3 Touch  to end recording.
- 4 Touch  to start playback of the recording; touch  to stop playback.
- 5 Touch **Save this recording** to save the recording on the microSD card.

- 6 To play back a sound recording again, touch the Launcher button



**Music**



**Playlist**



**My recordings**, then select a

recording to play. For information about **Music**, see "Music" on page 141.

## Voice Dialer

Touch the Launcher button



**Voice Dialer**



The voice dialer allows you to make calls and run applications using voice commands on your smartphone. The voice dialer pop-up displays examples of voice commands that you can use.

### To use a voice command to start an action

- 1 When Voice Dialer prompts you with voice command examples such as to call a contact, say an appropriate command to start an action. For example, if you want to call a contact named John, say "Call John".
- 2 Once your smartphone recognizes your command, it automatically calls the contact or number.

# 8 Synchronizing Your Dell Venue Smartphone and Computer Using Dell Mobile Sync

The Dell Mobile Sync (powered by Nero™) software allows you to copy or sync music, photos, videos, and Outlook contacts between your device and a computer.

 **NOTE:** The Dell Mobile Sync software is supported by Microsoft Windows XP (SP3), Windows Vista, and Windows 7 operating systems.

## To install the Dell Mobile Sync software on your computer:

- 1 Connect the supplied USB cable to your device and a computer. Wait for your computer to automatically install the device driver.

After the driver installation is complete, the Dell Mobile Sync installer may start automatically on computers running the Microsoft Windows XP (SP3) and Windows Vista operating systems.

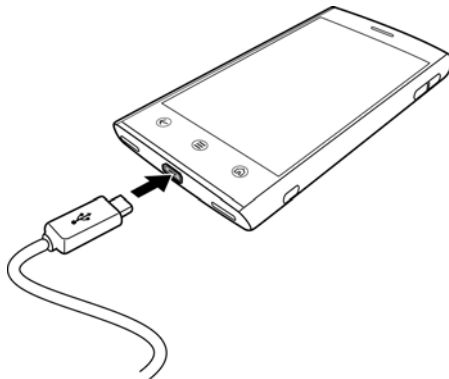

- 2 If the Dell Mobile Sync installer does not start automatically:
  - a Double-click the new **Removable Disk** that appears on your computer.

- b Navigate to the **Dell Mobile Sync** folder on the removable disk.
- c Double-click the **InstallDellMSync.exe** file to start the installation.



**NOTE:** You can also download and install the drivers and Dell Mobile Sync software from [support.dell.com/support/downloads](https://support.dell.com/support/downloads).

### To sync music, photos, videos, and Outlook contacts:

- 1 Ensure that the supplied USB cable is connected to your device and a computer.
- 2 Double-click the Dell Mobile Sync icon  on the Windows desktop. Your device appears under the **Devices** section in the Dell Mobile Sync software.
- 3 After the copy or sync is complete, disconnect the USB cable.









**NOTE:** For information about the Dell Mobile Sync software and to learn how to sync your device to a computer using Wi-Fi, see the documentation included in the Dell Mobile Sync software.

# 9 Troubleshooting

Problem	Possible causes	Possible solutions
<b>Call-related problems</b>		
SIM card error	SIM card malfunction or damage.	Take the SIM card to your service provider for testing.
	The SIM card may be inserted improperly.	Insert the SIM card properly.
	The SIM card's metal contacts may have dirt or dust.	Use a soft, dry cloth to clean the SIM card's metal contacts.
Poor reception	The network signal may be too weak at your current location. For example, network signals cannot reach effectively near tall buildings or in the basement.	Move to a location where the network signal can be received properly.
	The network may be busy at the at present. For example, during peak network traffic, the network may not be able to handle additional calls.	Try calling again after waiting for a short duration.
	You may be too far away from a base station for your service provider.	You can request a service area map from your service provider.



Problem	Possible causes	Possible solutions
You cannot make outgoing calls	The SIM card may not be installed.	Install a valid SIM card in your smartphone.
	Poor signal.	Move to an open space, or if you are inside a building, move closer to a window.
	Your smartphone is in Airplane mode with no wireless connectivity.	Press and hold the Power button and then touch the <b>Airplane mode</b> option to disable it.
	You have enabled the Call barring feature.	Touch the Home button  → Menu button  → <b>Settings</b> → <b>Call settings</b> → <b>Call barring</b> → <b>Deactivate all</b> .
	You have enabled Fixed Dialing Numbers.	Touch the Home button  → Menu button  → <b>Settings</b> → <b>Call settings</b> → <b>Fixed Dialing Numbers</b> . Disable <b>Fixed Dialing Numbers (FDN)</b> .
You cannot answer incoming calls	Poor signal.	Move to an open space, or if you are inside a building, move closer to a window.
	Your smartphone is in Airplane mode with no wireless connectivity.	Press and hold the Power button and then touch the <b>Airplane mode</b> option to disable it.
	You have enabled the Call barring feature.	Touch the Home button  → Menu button  → <b>Settings</b> → <b>Call settings</b> → <b>Call barring</b> → <b>Deactivate all</b> .
Unable to add contacts to the smartphone	Memory for storing contacts is already full.	Delete unnecessary contact information from the smartphone.

<b>Problem</b>	<b>Possible causes</b>	<b>Possible solutions</b>
Echo or noise	Poor network trunk quality from your service provider, or poor local telephone line quality.	End the call and dial again. You may be switched to a better-quality network trunk or phone line.
Noises during a call	You may be near a strong electromagnetic source such as a TV, microwave oven, and so on during a call.	Move to another location to reduce the interference effects.
You cannot enable certain call features	Your service provider does not support these features, or you have not subscribed for services that provide these features.	Contact your service provider.
PIN Code is blocked	You have entered an incorrect PIN code in three consecutive attempts.	Contact your service provider. If the service provider provides the SIM card's PUK code, use the PUK code to unlock the SIM card.
<b>System problems</b>		
Battery does not charge	The battery or battery charger is damaged.	Contact the dealer.
	The smartphone's temperature is below 0°C or higher than 45°C.	Try charging the phone at temperatures ranging between 0°C and 45°C.
	Poor contact between the battery and charger.	Check to see if you have connected the USB cable and charging plug correctly.
Unable to turn the smartphone on.	The battery is empty.	Charge the smartphone.
	The smartphone system is corrupted.	See page 157 for solutions.
	Battery contacts are not clean.	Seek your dealer's help to clean the contacts.

<b>Problem</b>	<b>Possible causes</b>	<b>Possible solutions</b>
Shortened standby time	The standby time is affected by your service provider's system configuration.	If you are located in an area where the network signal is weak, temporarily turn off your smartphone.
	The battery is depleted. In high-temperature environments, battery life will be shortened.	Use a new battery.
	If you are not able to connect to the network, the smartphone will continue to send out signals as it attempts to locate a base station. Doing this consumes battery power and consequently shortens standby time.	Change your location to one where the network is accessible, or temporarily turn off your smartphone.
<b>Messaging problems</b>		
Unable to send or receive text messages.	Your smartphone is in Airplane mode with no wireless connectivity.	Press and hold the Power button and then touch the <b>Airplane mode</b> option to disable it.
	The signal strength is not strong enough.	Try moving to a different location for better signal reception.

<b>Problem</b>	<b>Possible causes</b>	<b>Possible solutions</b>
Unable to send or receive multimedia messages.	Your smartphone is in Airplane mode with no wireless connectivity.	Press and hold the Power button and then touch the <b>Airplane mode</b> option to disable it.
	No MMS service is available.	Subscribe to the MMS service from your network service provider.
	Your MMS settings are not configured properly.	Check your network connection, and confirm with your network service provider if your MMS settings are configured correctly.
	Not enough space left on your smartphone memory.	Check if there is enough space on your smartphone memory. Delete data that you do not require to free space if necessary.
Unable to send or receive e-mail.	The Internet connection or the e-mail setting is not configured properly.	Check your network connection, and confirm with your e-mail service provider if your e-mail setting has been configured correctly.
<b>Internet problems</b>		
Unable to connect to the network.	Invalid SIM card.	Contact your service provider.
	You are not within the network's service area.	Check the service area with your service provider.
	Poor signal.	Move to an open space or if you are inside a building, move closer to a window.
<b>Media problems</b>		
Windows Media Player on my computer cannot play the sounds of the video captured using the smartphone.	The smartphone records video sounds in amr format. Windows media player does not support the amr format.	Play the video using a video player with the amr decoder, such as QuickTime.

**If your smartphone does not turn on due to corrupt system files, you can either reset your smartphone or start emergency software recovery.**

#### **Reset your smartphone to the default state**

- 1 Press and hold the Power button and then touch the **Power off** option→ **OK** on the screen to turn off the smartphone.
- 2 Press and hold the volume up and volume down buttons simultaneously.
- 3 Without releasing the volume buttons, press and hold the Power button, until the smartphone turns on the configuration screen.
- 4 Press the volume buttons to move the highlight bar on the screen to the **Factory reset** option.
- 5 Press the Camera button to start the reset process.
- 6 Wait for the smartphone to restart.

#### **Start emergency software recovery**

- 1 Remove the microSD card from the smartphone.
- 2 Connect a microSD card adapter to your computer and insert your smartphone's microSD card in the adapter.
- 3 On your computer, go to **support.dell.com** and follow the instructions to download the software upgrade package to the microSD card.

**NOTE:** Check if the downloaded file is named as Update.pkg. If not, rename the file as Update.pkg.

- 4 Disconnect the microSD card adapter from your computer, and insert the microSD card in your smartphone.
- 5 Follow steps 1 to 3 in "Reset your smartphone to the default state" on page 157 to turn on the configuration screen.
- 6 Press the volume buttons to move the highlight bar to the **Software upgrade from update.z** option, and press the Camera button to confirm your selection.
- 7 Press the Camera button to confirm and start emergency software recovery.

**NOTE:** If you want to cancel software recovery, press the volume down button.

- 8 Wait for the smartphone to load files and restart.



**NOTE:** For service and contact information, visit: [www.dell.com](http://www.dell.com).

# Index

## A

- Airplane Mode, 76
- Alarm Clock, 146
- Ambient light sensor, 13
- Android Market, 115
- Applications
  - Definition, 23
  - Erase data, 70
  - Navigate, 42
  - Recently used, 43
  - Shortcuts, 42

## B

- Back cover
  - Close, 9
  - Remove, 6
- Battery
  - Charge, 10
  - Insert, 7
- Bluetooth, 136
- Button
  - Back, 13
  - Camera, 16
  - Home, 14
  - Menu, 14
  - Power and Sleep/Wake, 13
  - Volume up/down, 16

## C

- Calculator, 148
- Calendar, 144
- Calling, 44
- Camera, 130
- Charging, 10
- Connection
  - Mobile networks, 72
  - To a computer, 135
  - Wi-Fi, 74
- Contacts, 51
  - Add, 51
  - View, 52
- Controls, 12
  - Touch screen, 17

## D

- Data connection, 72
- Date, 123
- Dell Mobile Sync, 150
- Disable all connections, 76
- Display settings, 120

## E

- E-mail, 83

Emergency software  
recovery, 157

Erase all data, 71

## F

Factory reset, 71

## G

Gmail, 85

Google Account  
Setup, 85

Google Maps, 92

Google Search, 68

Google Talk, 88

## H

Home Screen  
Customize, 33

## K

Keyboard, 62

## L

Language, 124

## M

Maps, 92

Messaging, 55

microSD, 135

Format, 70

Install, 8

Set as USB drive, 135

Turn off USB storage, 135

Mobile networks, 72

Music, 141

Create a playlist, 143

Playback, 142

## O

On-Screen Keyboard, 62

## P

Photos & Videos, 138

PIN

Change, 129

Enable, 129

Pop-Up menu, 61

Proximity sensors, 13

## R

Recorder, 148

Ringtone, 121

## S

### Screen

- Orientation, 23
- Turn off/on, 11

### Screen Unlock Pattern, 125

- Create, 125
- Enable/disable, 127

### Search, 68

### Sensor, 13

### Settings

- Date and time, 123
- Display, 120
- Language, 124
- Sound and ringtone, 121

### Shortcuts, 42

- Add, 33
- Definition, 23

### SIM card

- Insert, 7

### Smartphone

- Overview, 12
- Protect, 125
- Reset, 71
- Settings, 70
- Turn off, 11
- Turn on, 11

### Software

- Recovery, 157

### Sound, 121

### Stage

- Desktop, 24
- Widgets, 27

### Status bar, 38

### Icons, 39

### Synchronize Google Data, 119

### Synchronize with Computer

- Use Dell Mobile Sync, 150

## T

### Text Messages

- Compose
  - MMS, 56
  - SMS, 55
- Receive, 59

### Time, 123

### Time zone, 123

### Touch screen, 17

### Troubleshooting, 152

## V

### Voice Control, 149

### Voice Search, 68

## W

### Web

- Applications, 85
- Bookmarks, 81
- Browse, 76
- Connection, 72

### Widgets

- Add, 35
- Definition, 23
- Google Search, 68



Stage Widgets, 27  
Wi-Fi, 74

Y

YouTube, 113

## Free Manuals Download Website

<http://myh66.com>

<http://usermanuals.us>

<http://www.somanuals.com>

<http://www.4manuals.cc>

<http://www.manual-lib.com>

<http://www.404manual.com>

<http://www.luxmanual.com>

<http://aubethermostatmanual.com>

Golf course search by state

<http://golfingnear.com>

Email search by domain

<http://emailbydomain.com>

Auto manuals search

<http://auto.somanuals.com>

TV manuals search

<http://tv.somanuals.com>