Kodak EasyShare V610 dual lens digital camera



User's guide

www.kodak.com

For interactive tutorials, www.kodak.com/go/howto

For help with your camera, www.kodak.com/go/v610support



Eastman Kodak Company
Rochester, New York 14650
© Eastman Kodak Company, 2006

All screen images are simulated.

Kodak, EasyShare, and Perfect Touch are trademarks of Eastman Kodak Company.
Schneider-Kreuznach and C-Variogon are trademarks of Jos. Schneider Optische
Werke GmbH used under license by Eastman Kodak Company.

The Bluetooth word mark and logos are owned by Bluetooth SIG, Inc. and any use of
such marks by Kodak is under license.

P/N 4J4375_en

Front view

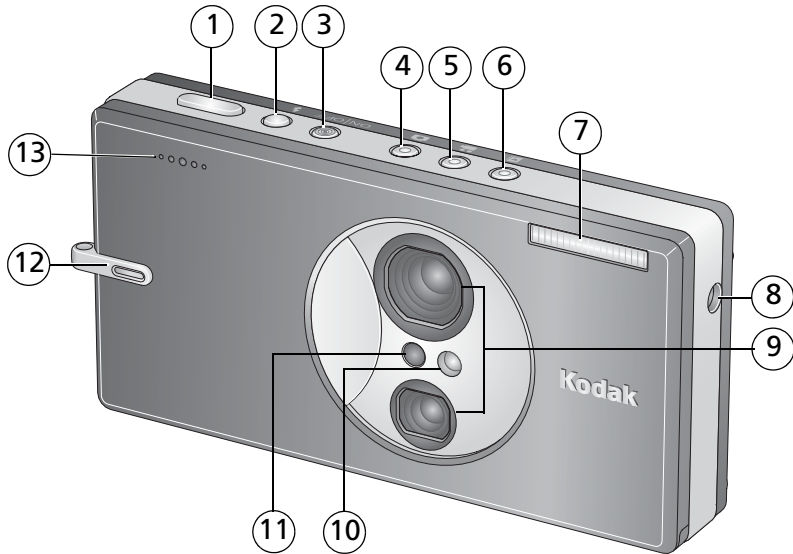

- | | | | |
|---|-----------------------------|----|--|
| 1 | Shutter button | 7 | Flash |
| 2 | Flash button | 8 | DC-In (5V)  |
| 3 | On/Off button | 9 | Lenses |
| 4 | Auto (pictures) mode button | 10 | Video/Self-timer lights |
| 5 | Video mode button | 11 | Light sensor |
| 6 | Favorites mode button | 12 | Strap post |
| | | 13 | Microphone |

Back view

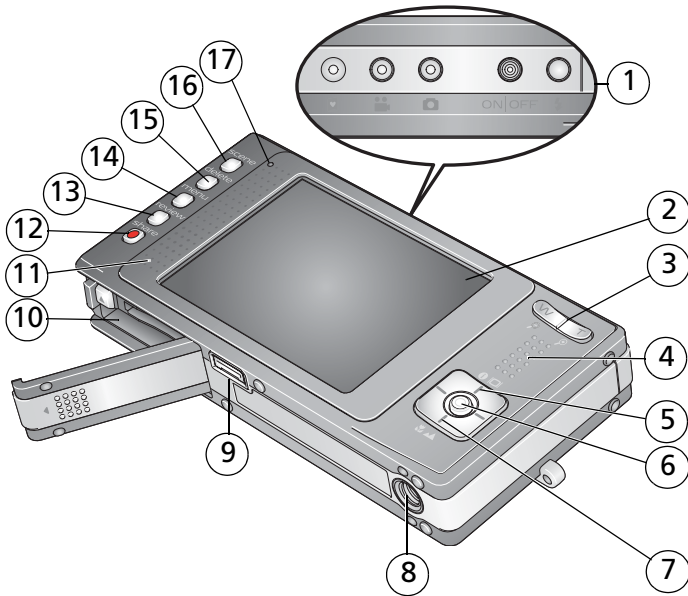

- | | |
|--|--|
| 1 On/Off, Mode buttons/Battery charging lights/Bluetooth status lights | 10 Battery compartment; slot for optional SD or MMC card |
| 2 LCD | 11 Speaker |
| 3 Wide angle/Telephoto button | 12 Share button |
| 4 Grip | 13 Review button |
| 5 LCD/Info button | 14 Menu button |
| 6 OK button | 15 Delete button |
| 7 Macro/Landscape mode button | 16 Scene mode button |
| 8 Tripod socket | 17 Ready light |
| 9 Dock connector, USB, A/V Out | |

Table of contents

1	Setting up your camera	1
	Attaching the strap	1
	Loading the KLIC-7001 battery	1
	Charging the battery	2
	Turning on the camera	3
	Setting the language and date/time	3
	Storing pictures on an SD or MMC card	4
2	Taking pictures/videos	5
	Taking a picture	5
	Using the framing marks to take pictures	6
	Taking a video	6
	Using the optical zoom	7
	Using the self-timer	8
	Using the flash	9
	Using different modes	10
	Taking panoramic pictures	14
	Understanding the picture-taking icons	15
3	Working with pictures/videos	16
	Reviewing pictures/videos	16
	Deleting pictures/videos	17
	Cropping pictures	18
	Using Kodak Perfect Touch technology	18
	Editing videos	19
	Running a slide show	20
	Viewing pictures/videos in different ways	24
	Selecting multiple pictures/videos	25
	Copying pictures/videos	25
	Understanding the review icons	26

4 Doing more with your camera	28
Using the menu to change settings.....	28
Customizing your camera	32
Using exposure compensation to adjust picture brightness.....	35
Using the histogram to view picture brightness.....	36
Using the framing grid to compose a picture.....	36
Sharing your pictures.....	36
5 Transferring and printing pictures	43
Installing the software.....	43
Transferring pictures/videos.....	44
Printing pictures.....	45
Dock compatibility for your camera.....	47
6 Using Bluetooth wireless technology features	48
Setting up the Bluetooth feature of your camera	48
Making the “set as trusted” choice	49
Getting the best Bluetooth reception	50
Sending pictures to a device.....	51
Receiving pictures from a device.....	52
Sending pictures to a printer.....	53
Sending pictures to a computer	54
7 Troubleshooting	55
8 Getting help	60
9 Appendix	62
Camera specifications	62
Important safety instructions	67
Battery replacement, battery life	68
Upgrading your software and firmware.....	69
Additional care and maintenance	69
Warranty.....	69
Regulatory compliance	71

1

Setting up your camera

Attaching the strap

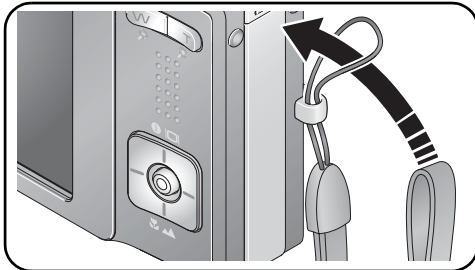

Loading the KLIC-7001 battery

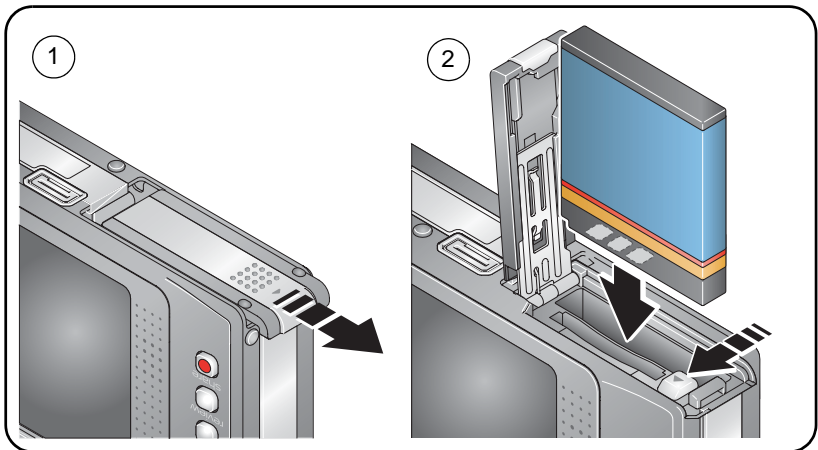

For information on replacing batteries and extending battery life, see [page 68](#).

www.kodak.com/go/support

EN 1

Charging the battery

Charge until all 3 battery charging lights are lit (approximately 2 hours).

5-volt AC adapter

(included with your camera)

NOTE: Use this AC adapter to charge the battery and to power the EasyShare photo frame dock 2.

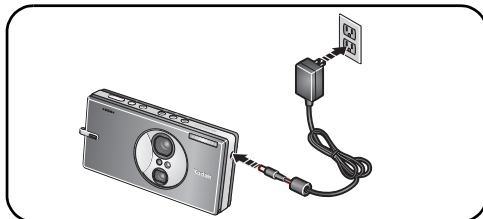

Kodak EasyShare photo frame dock 2

May be sold separately. Visit www.kodak.com/go/v610accessories.

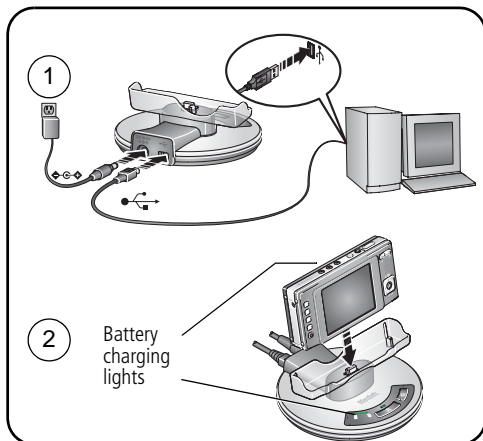

Kodak EasyShare printer dock series 3 or EasyShare camera dock series 3

May be sold separately. Visit www.kodak.com/go/v610accessories. For details, see the dock user's guide. For dock compatibility, see [page 47](#).

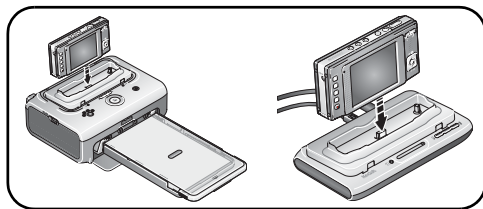

Turning on the camera

Press the On/Off button to turn the camera on in Auto mode.

NOTE: You can also press the Auto, Video, or Favorites button to turn on the camera in that mode.

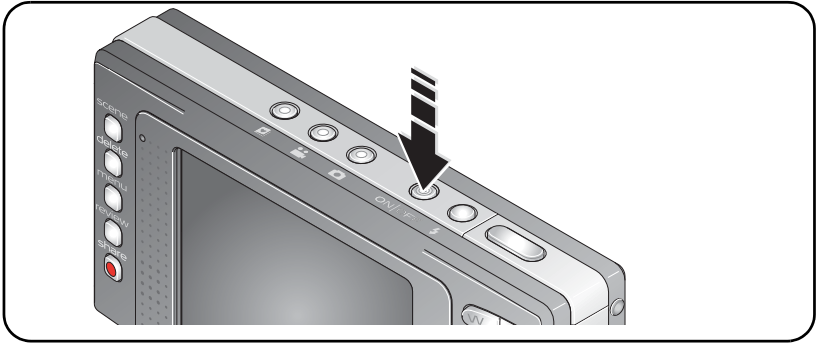

Setting the language and date/time

Language:

- 1 ▲/▼ to change.
- 2 OK to accept.

Date/Time:

- 1 At the prompt, press OK.
- 2 ▲/▼ to change.
◀/▶ for previous/next field.
OK to accept.

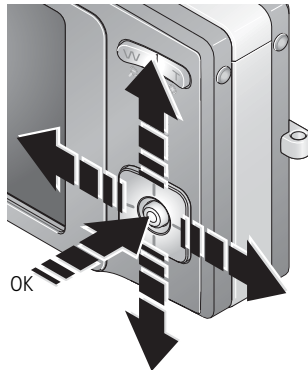

Storing pictures on an SD or MMC card

Your camera has internal memory. You can purchase an SD or MMC card to conveniently store more pictures/videos (www.kodak.com/go/v610accessories). We recommend Kodak SD cards.

NOTE: When using the card for the first time, format it in this camera before taking pictures (see [page 35](#)).

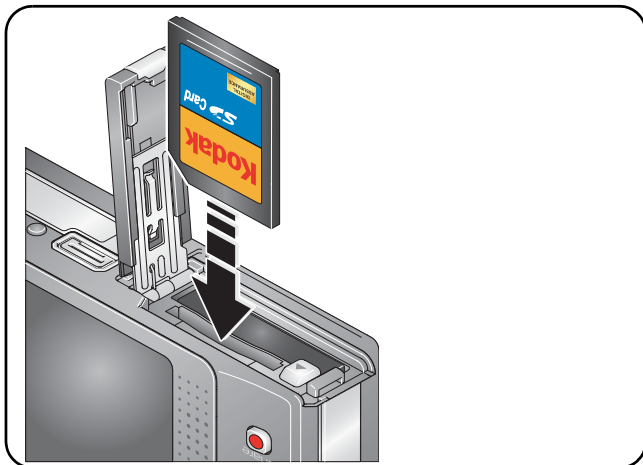

CAUTION:

A card can only be inserted one way; forcing it may cause damage. Inserting or removing a card when the Ready light is blinking may damage the pictures, card, or camera.

See [page 66](#) for storage capacities.



2

Taking pictures/videos

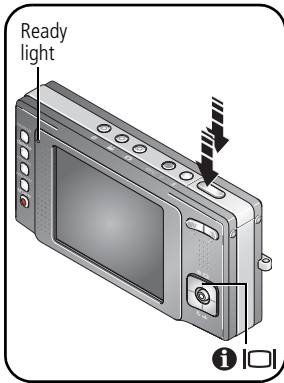
Taking a picture



- 1 Press the On/Off or the Auto mode button to turn on the camera.
- 2 Compose the picture.
- 3 Press the Shutter button **halfway** to focus and set exposure.
When the Ready light turns green, press the Shutter button **completely down**.

NOTE: You can repeatedly press LCD/Info   to turn on/off status icons, histogram, and framing grid.

Reviewing the picture just taken

After you take a picture/video, the LCD displays a quickview for approximately 5 seconds. If you press no buttons, the picture/video is saved.

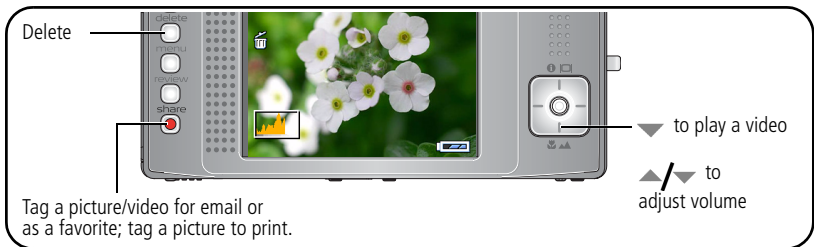

To review pictures/videos anytime, see [page 16](#).

Using the framing marks to take pictures

Framing marks indicate the camera focus area. The camera attempts to focus on foreground subjects, even if the subjects are not centered in the scene.

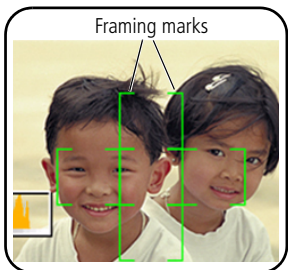

- 1 Press the Shutter button **halfway**.
When the framing marks turn green, focus is accomplished.
- 2 If the camera is not focusing on the desired subject (or if the framing marks disappear), release the Shutter button and recompose the scene.
- 3 Press the Shutter button **completely down** to take the picture.

NOTE: Framing marks do not appear in Landscape or Video mode. When you use Focus Zone and set Center Zone, the framing marks are fixed at Center Wide.

Taking a video

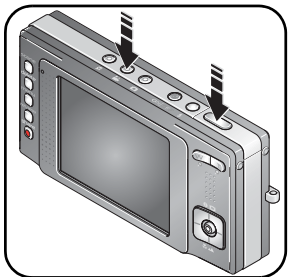

- 1 Press the Video mode button.
The camera enters Video mode.
- 2 Press the Shutter button **completely down**, then release it. To stop recording, press and release the Shutter button again.
To review and edit videos, see [page 16](#).

Using the optical zoom

When taking pictures/videos, use optical zoom to get up to 10X closer to your subject. Optical zoom is effective when the lens is no closer than 24 in. (60 cm) to the subject or 2 in. (5 cm) in Macro mode.

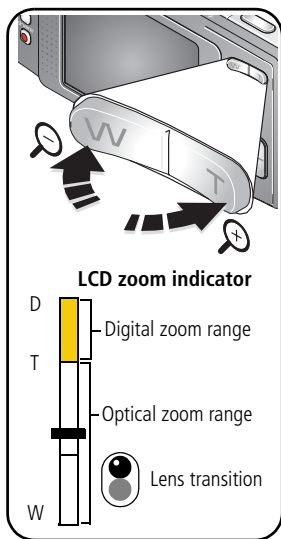

- 1 Use the LCD to frame your subject.
- 2 Press Telephoto (T) to zoom in. Press Wide Angle (W) to zoom out.

The zoom indicator shows zoom status. The Lens Transition icon indicates when the camera transitions from one lens to another.

- 3 Take the picture/video.

Using digital zoom

Use digital zoom in any Still mode to get up to 4X magnification beyond optical zoom.

- 1 Press Telephoto (T) to the optical zoom limit (10X). Release the button, then press it again.
- 2 Take the picture.

NOTE: You cannot use digital zoom for video recording. You may notice decreased image quality when using digital zoom. The slider on the zoom indicator turns red when the picture quality reaches the limit for an acceptable 4 x 6-in. (10 x 15 cm) print.

Using the self-timer

Use the self-timer when you want to be included in a picture, or to ensure a steady Shutter button press.

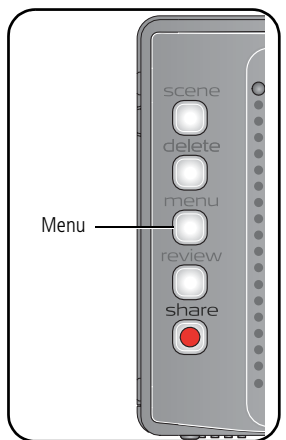

- 1 Place camera on a tripod or flat surface.
- 2 In any Still mode, press the Menu button.
- 3 Press ▲/▼ to highlight Self-timer, then press the OK button. Choose:

2 seconds—A picture is taken after a 2-second delay (for a steady, auto-shutter release on a tripod).

10 seconds—A picture is taken after a 10-second delay (so you have time to get into the scene).

Off

2 shot —The first picture is taken after a 10-second delay. A second picture is taken 8 seconds later.

Then press the OK button.

- 4 Compose the scene.
- 5 Press the Shutter button **halfway**, then **completely down**.

The camera takes the picture/pictures after the delay.

Use the same procedure to take a video, but:

- Press the Video mode button .
- Press the Shutter button **completely down**.



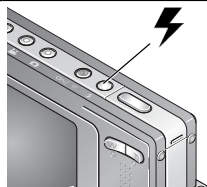

NOTE: The video stops when no storage space remains. Only the 2- and 10-second options are available in video mode.

Using the flash



Press the flash button repeatedly to scroll through flash modes.



The current flash mode is shown in the LCD status area.

Flash modes	Flash fires
 Auto	When the lighting conditions require it.
 Fill	Every time you take a picture, regardless of the lighting conditions. Use when the subject is in shadow or is "backlit" (when light is behind the subject). In low light, hold the camera steady or use a tripod.
 Red Eye	<p>In Red Eye flash, you can reduce red eye by using a preflash or by using automatic red eye reduction. To make the camera:</p> <ul style="list-style-type: none"> ■ Preflash, turn the Red Eye Preflash on. (The first flash shrinks the eye pupil to reduce the chance of red eye.) ■ Flash once and automatically remove red eye, turn the Red Eye Preflash off. <p>(To turn the Red Eye Preflash on/off, see page 34.)</p> <p>NOTE: When automatic red eye reduction is on, the camera cannot take more than 2 pictures in quick succession. Take more pictures when the Ready light turns green.</p>
 Off	Never



For flash settings in each mode, see [page 65](#).

Using different modes

Choose the mode that best suits your subjects and surroundings.

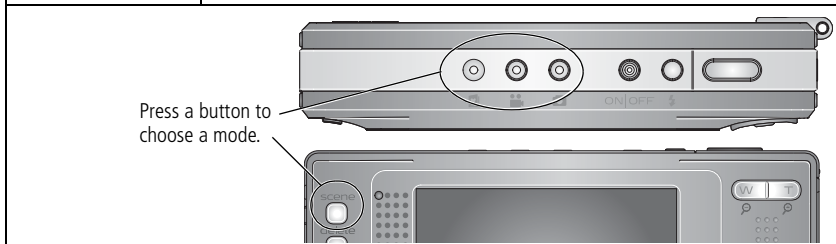
Use this mode	For
 Auto	General picture-taking—offers an excellent balance of image quality and ease of use.
 Video	Capturing video with sound. (See page 6.)
 Favorites	Viewing favorite pictures. (See page 39.)
Scene	Point-and-shoot simplicity when taking pictures under special conditions. (See page 11.)



Use this mode	For
 Landscape	Far-away scenes. The camera uses infinity auto-focus. Auto-focus framing marks are not available in Landscape.
 Macro	Close range. Use available light instead of flash, if possible. Camera automatically sets focus distance depending on the zoom position.

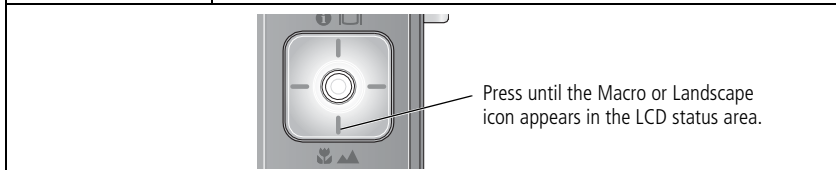

Using Scene modes

Choose a Scene mode—for great pictures in practically any situation!

- 1 Press the Scene mode button.
- 2 Press ◀/▶ ▶/▼ to view scene mode descriptions. (If the mode description turns off, press the OK or Scene button.)
- 3 Press the OK button to choose a Scene mode.

NOTE: To exit a Scene mode, press the Auto mode button.

Scene mode	For	Camera pre-settings
Portrait	Full-frame portraits of people.	Subject is sharp and the background is indistinct. Position your subject at least 6 ft (2 m) away and fill the frame with a head and shoulder pose. Use Telephoto to exaggerate background blur.
Panorama Left-Right	See page 14 .	Multi-Zone Focus, Flash off
Panorama Right-Left	See page 14 .	Multi-Zone Focus, Flash off
Sport	Subjects that are in motion.	Fast shutter speed, Multi-Pattern Exposure Metering
Landscape	Far-away scenes. The camera uses infinity auto-focus.	Auto-focus framing marks are not available in Landscape.
Close-up	Close range. Use available light instead of flash if possible.	The camera automatically sets the focus distance depending on the zoom position.
Night Portrait	Reduces red eye of people in night scenes or low-light conditions. Place the camera on a flat, steady surface or use a tripod.	Multi-Pattern Exposure Metering, Multi-Zone Focus, Red Eye flash

Scene mode	For	Camera pre-settings
Night Landscape	Distant scenery at night. Flash does not fire. Place the camera on a flat, steady surface or use a tripod.	Infinity Focus, Center-Weight Metering, Daylight White Balance, Flash Off, maximum 2-second exposure
Snow	Bright snow scenes.	Center-Weight Metering, Multi-Zone Focus, +1 Exposure Compensation
Beach	Bright beach scenes.	Center-Weight Metering, Daylight White Balance, +1 Exposure Compensation
Text	Documents. Place the camera on a flat, steady surface or use a tripod.	Macro Focus, Center-Weight Metering, Multi-Zone Focus, +1 Exposure Compensation
Fireworks	Flash does not fire. Place the camera on a flat, steady surface or use a tripod.	2-second exposure, Infinity Focus, Center-Weight Metering, Daylight White Balance
Flower	Close-ups of flowers or other small subjects in bright light.	Macro Focus, Daylight White Balance, Center-Zone Focus, Center-Weight Metering
Manner/Museum	Quiet occasions, like a wedding or lecture. Flash and sound are disabled. Place the camera on a flat, steady surface or use a tripod.	No sounds, no flash, Multi-Pattern Exposure Metering, Multi-Zone Focus
Self-Portrait	Close-ups of yourself. Assures proper focus and minimizes red eye.	Macro Focus, Multi-Pattern Exposure Metering, Multi-Zone Focus, Red Eye Flash
Party	People indoors. Minimizes red eye.	Multi-Pattern Exposure Metering, Multi-Zone Focus, Red Eye Flash
Children	Action pictures of children in bright light.	Multi-Pattern Exposure Metering, Multi-Zone Focus

Scene mode	For	Camera pre-settings
Backlight	Subjects that are in shadow or “backlit” (when light is behind the subject).	Multi-Pattern Exposure Metering, Multi-Zone Focus, Fill-Flash
Panning Shot	Shooting a fast-moving subject. The background gives the sense of movement, while the subject appears still.	Shutter speed > 1/180 sec., Multi-Zone Focus, Multi-Pattern Exposure Metering
Candle Light	Subjects illuminated by candle light.	Multi-Pattern Exposure Metering, Multi-Zone Focus, Daylight White Balance
Sunset	Subjects at dusk.	Multi-Pattern Exposure Metering, Multi-Zone Focus, Daylight White Balance
Custom	Choosing your own settings.	Settings are saved, even after the camera is turned off. (To reset, see page 31 .)

Taking panoramic pictures

Use panorama to “stitch” up to 3 pictures into a panoramic scene.

NOTE: For best results, use a tripod. Only the panoramic picture is saved; individual pictures are not. (Picture size is set to 3.1 MP for each picture. Exposure and white balance are set with the first picture. The flash is set to Off.)

- 1 Press the Scene mode button.
- 2 Press **◀/▶** to highlight Panorama Left-Right or Panorama Right-Left (depending on the direction you want to pan), then press the OK button.
- 3 Take the first picture.

After a quickview, the LCD displays the liveview and an “overlay” from the first picture.

- 4 Compose the second picture. Make the overlay from the first picture cover the same portion in the new picture. (You may press the Delete button to re-take a picture.)
- 5 If you are taking only 2 pictures, press the OK button to stitch them together.

After you take 3 pictures, the pictures are automatically stitched together.



NOTE: For printing options, visit the Kodak EasyShare Gallery www.kodakgallery.com.

Understanding the picture-taking icons

In capture mode—no buttons pressed

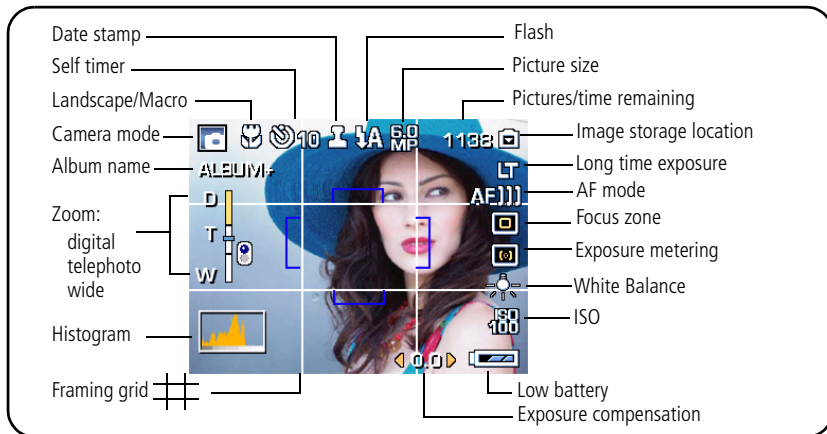

In capture mode—shutter button pressed halfway

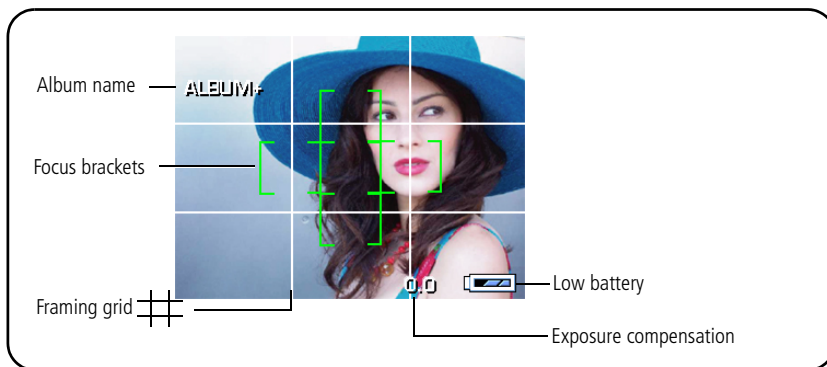

3

Working with pictures/videos

Reviewing pictures/videos

Press the Review button to view and work with your pictures/videos.

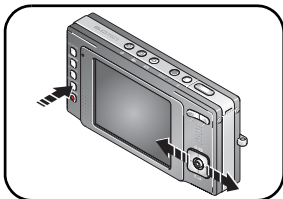

- 1 Press the Review button.
- 2 Press ◀/▶ to view previous/next picture/video.

NOTE: To view pictures with the lens closed, press the Favorites mode button, then the Review button. To save battery power, use a Kodak EasyShare photo frame dock 2 or an EasyShare dock. (Visit www.kodak.com/go/v610accessories.)

Magnifying a picture during review

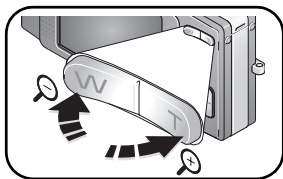

- 1 Press W/T to magnify 1X–8X.
- 2 Press ▲/▼ ◀/▶ to view other parts of the picture.
- 3 Press the OK button to return to 1X.

NOTE: If you press W while at 1X, the view changes from single-picture to multi-up thumbnails. (See [page 24](#).)

Playing a video during review

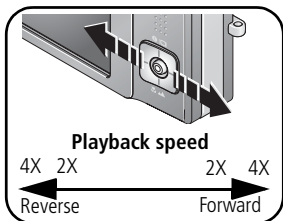

- Press ▼ to play a video. Press OK pause/unpause.
- Press ▲/▼ to adjust the audio volume playback.
- Press ▶ during playback to play at 2X speed; press again for 4X. Press ◀ during playback to reverse at 2X speed; press again for 4X.

Deleting pictures/videos

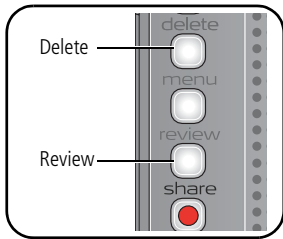

- 1 Press the Review button.
- 2 Press ◀/▶ for previous/next picture/video.
- 3 Press the Delete button.
- 4 Follow the screen prompts.

NOTE: To select more than one picture, see [Viewing as thumbnails \(multi-up\)](#), page 24. To delete protected pictures/videos, remove protection before deleting.

Using the undo delete feature

If you accidentally delete a picture, you may be able to use Undo Delete to retrieve it. This feature is only available immediately after you delete a picture.

Protecting pictures/videos from deletion

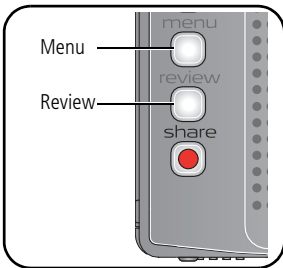

- 1 Press the Review button.
- 2 Press ◀/▶ for previous/next picture/video.
- 3 Press the Menu button.
- 4 Press ▲/▼ to highlight Protect, then press OK.

The picture/video is protected and cannot be deleted. The Protect icon  appears with the protected picture/video.

- Press the Menu button to exit the menu.



CAUTION:

Formatting internal memory or an SD or MMC card deletes all (including protected) pictures/videos. (Formatting internal memory also deletes email addresses, album names, and favorites. To restore them, see EasyShare software Help.)

Cropping pictures

You can crop a picture so that only the desired portion of the picture remains.

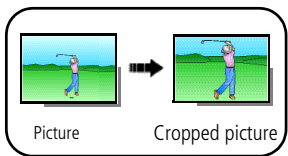

- 1 Press the Review button, then **◀/▶** to find a picture to crop.
- 2 Press the Menu button, choose Crop, then press the OK button.
- 3 Press Telephoto (T) to zoom in, or **◀/▶** **▲/▼** to move the crop box. Press the OK button.
- 4 Follow the screen prompts.

The picture is cropped. (The original is saved.) Cropped pictures cannot be cropped again on the camera.

- Press the Menu button to exit the menu.

Using Kodak Perfect Touch technology

Kodak Perfect Touch technology helps ensure better, brighter pictures.

- 1 Press the Review button.
- 2 Press **◀/▶** for previous/next picture.
- 3 Press the Menu button, choose Perfect Touch tech., then press the OK button.

*The enhancement is previewed in a split screen. Press **◀/▶** to view other parts of the picture.*

- 4 Follow the screen prompts to apply or discard the enhancement, and to save as a new picture or replace the original.

The picture is enhanced. An enhanced picture cannot be enhanced again on the camera. Kodak Perfect Touch technology can only be used with pictures, not video.

- Press the Menu button to exit the menu.

Editing videos

You can do incredible things with your videos!

Making a picture from a video

You can choose a single frame from a video, then make a picture suitable for a 4 x 6-inch (10 x 15 cm) print.

NOTE: You cannot make a picture from a QVGA 320 x 240 video. (See [page 29](#).)

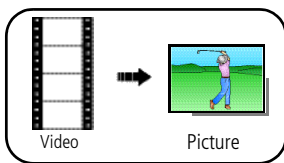

- 1 Press the Review button, then ◀/▶ to find a video.
 - 2 Press the Menu button, choose Make Picture, then press the OK button.
 - 3 Follow the screen prompts.
A picture is created. (The original video is saved.)
- Press the Menu button to exit the menu.

Trimming a video

You can delete an unwanted portion from the beginning or end of a video.

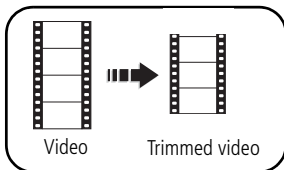

- 1 Press the Review button, then ◀/▶ to find a video.
 - 2 Press the Menu button, choose Edit Video, then press the OK button. Choose Trim, then press OK.
 - 3 Follow the screen prompts.
The video is trimmed. (You can save it as a new video or replace the original.)
- Press the Menu button to exit the menu.

Making a video action print

From a video, you can make a 4-, 9-, or 16-up picture, suitable for a 4 x 6-inch (10 x 15 cm) print.

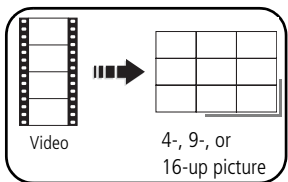

- 1 Press the Review button, then ◀/▶ to find a video.
- 2 Press the Menu button, choose Edit Video, then press the OK button. Choose Action Print, then press the OK button.

- 3 Choose an option, then press the OK button.

Auto options: The camera includes the first and last frames, then 2, 7, or 14 equally spaced frames.

Manual options: You choose the first and last frames; the camera chooses 2, 7, or 14 equally spaced frames.

Full Manual options: You choose all frames.

A 4-, 9-, or 16-up picture is created. (The original video is saved.)

- Press the Menu button to exit the menu.

Running a slide show

Use Slide Show to display your pictures/videos on the LCD.

NOTE: If you have an EasyShare photo frame dock 2, see [page 23](#).

Starting the slide show

- 1 Press the Review button, then the Menu button.
- 2 Press ▲/▼ to highlight Slide Show, then press the OK button.
- 3 Press ▲/▼ to highlight Begin Show, then press the OK button.

Each picture/video is displayed once.

To interrupt the Slide Show, press the OK button.

Changing the slide show display interval

The default interval setting displays each picture for 5 seconds. You can set the display interval from 3–60 seconds.

- 1 On the Slide Show menu, press ▲/▼ to highlight Interval, then press the OK button.
- 2 Select a display interval.
To scroll through the seconds quickly, press and hold ▲/▼.
- 3 Press the OK button.

The interval setting remains until you change it.

Running a continuous slide show loop

When you turn on Loop, the slide show is continuously repeated.

- 1 On the Slide Show menu, press ▲/▼ to highlight Loop, then press the OK button.
- 2 Press ▲/▼ to highlight On, then press the OK button.
- 3 Press ▲/▼ to highlight Begin Show, then press the OK button.

The slide show repeats until you press the OK button or until battery power is exhausted. The Loop feature remains until you change it.

Choosing a slide show transition

- 1 On the Slide Show menu, press ▲/▼ to highlight Transition, then press the OK button.
- 2 Press ▲/▼ to select a transition, then press the OK button.

Displaying pictures/videos on a television

You can display pictures/videos on a television, computer monitor, or any device equipped with a video input. To connect the camera to a television, use the USB / A/V connector and A/V cable (may be sold separately).

NOTE: Ensure that the Video Out setting (NTSC or PAL) is correct (see [page 33](#)). The slide show stops if you connect or disconnect the cable while the slide show is running. (Image quality on a television screen may not be as good as on a computer monitor or when printed.)

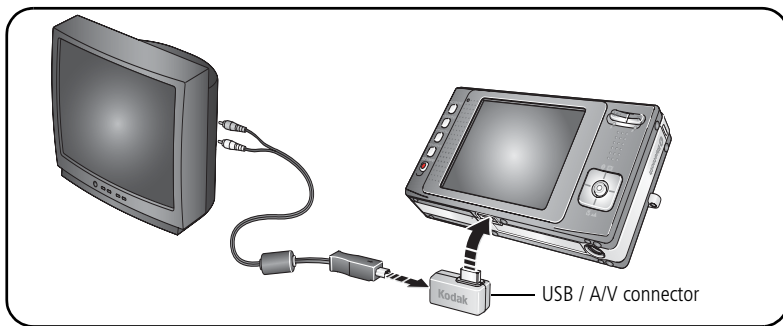

Running a slide show with the photo frame dock 2

Your package may include an EasyShare photo frame dock 2. (To purchase accessories, visit www.kodak.com/go/v610accessories.)

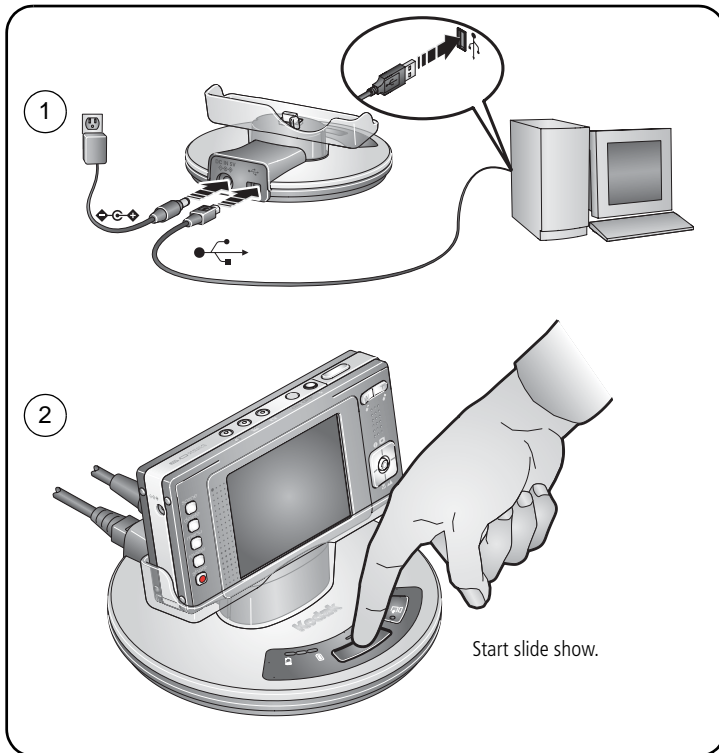

Viewing pictures/videos in different ways

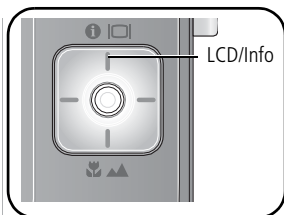

Viewing picture/video information

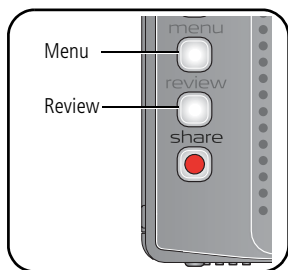

- 1 Press the Review button.
- 2 Repeatedly press the LCD/Info  button to turn on/off status icons and picture/video info.
 - Press the Review button to exit Review.

Viewing by date or by album



- 1 Press the Review button, then the Menu button.
- 2 Press  to highlight View By, then press the OK button.
- 3 Press  to highlight All (default), Date, or Album, then press the OK button. For more about albums, see [page 41](#).
 - Press the Review button to exit Review.

Viewing as thumbnails (multi-up)

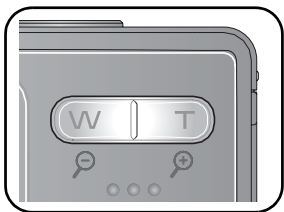

- 1 Press the Review button.
- 2 Press W to change from single-picture view to multi-up thumbnails.
- 3 Press T to return to single-picture view.
 - To select multiple pictures/videos, see [page 25](#).
 - Press the Review button to exit Review.

Selecting multiple pictures/videos

Use the multi-select feature when you have two or more pictures/videos to print, transfer, delete, etc. (Multi-select is used most effectively in multi-up mode, [page 24](#).)

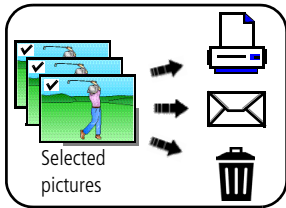

- 1 Press the Review button, then ◀/▶ to find a picture/video.
- 2 Press the OK button to select pictures/videos.

A check mark appears on the picture. You can now print, transfer, delete, etc. the selected pictures. You can press OK a second time to remove a check mark.

Copying pictures/videos

You can copy pictures/videos from a card to internal memory or from internal memory to a card.

Before you copy, make sure that:

- A card is inserted in the camera.
- The camera's picture storage location is set to the location **from** which you are copying (see [page 32](#)).

Copy pictures/videos:

- 1 Press the Review button, then the Menu button.
- 2 Press ▲/▼ to highlight Copy ►►, then press the OK button.
- 3 Press ▲/▼ to highlight an option.
- 4 Press the OK button.

NOTE: Pictures/videos are copied, not moved. To remove pictures/videos from the original location after copying, delete them (see [page 17](#)).

Tags that you applied for print, email, and favorites are not copied. Protection settings are not copied. To apply protection to a picture/video, see [page 17](#).

Understanding the review icons

Pictures

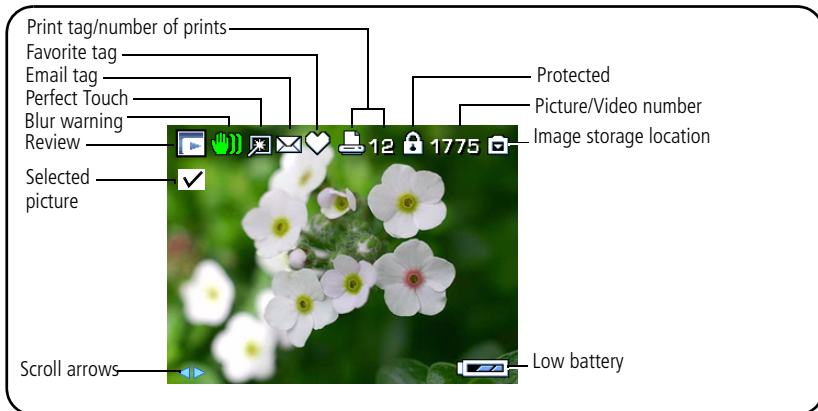

Videos

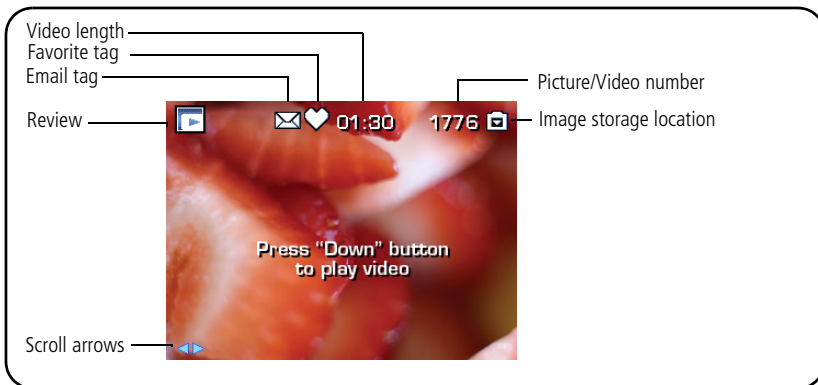

Understanding the blur warning icons

A blur alert icon  is displayed during picture review and (if the feature is turned on) in quickview (see [page 34](#)).

Green—Picture is sharp enough for an acceptable 4 x 6-inch (10 x 15 cm) print.

Yellow—Picture may be sharp enough for an acceptable 4 x 6-inch (10 x 15 cm) print or sharpness is not determined. (You may want to view on a computer monitor before printing.)

Red—Picture is not sharp enough for an acceptable 4 x 6-inch (10 x 15 cm) print.

White—Print sharpness is not determined.

4

Doing more with your camera

Using the menu to change settings

You can change settings to get the best results from your camera. (Some settings are unavailable in some modes.)

- 1 Press the Menu button.
- 2 Press ▲/▼ to highlight a setting, then press the OK button.
- 3 Choose an option, then press the OK button.

Setting	Options
Self-timer Choose a self-timer setting. (Place camera on a tripod or flat surface.) In Video mode, only the 2- and 10-second options are available. A video stops when no storage space remains.	See page 8 .
Burst Camera takes up to 8 pictures while the Shutter button is pressed. Capture an expected event, such as a person swinging a golf club.	Press the Shutter button halfway to focus and set exposure. Press the Shutter button completely down and hold it to take pictures. <i>The camera stops taking pictures when you release the Shutter button, when the pictures are taken, or when no storage space remains.</i> During quickview, you can delete all pictures in the burst series. To delete selectively, do so in Review (see page 17).

Setting	Options
<p>Picture Size Choose a picture resolution. <i>This setting remains until you change it.</i></p>	<p>6.0 MP (default)—for printing up to 20 x 30 in. (50 x 76 cm); pictures are highest resolution, largest file size.</p> <p>5.3 MP (3:2)— ideal for printing 4 x 6 in. (10 x 15 cm) prints without cropping. Also for printing up to 20 x 30 in. (50 x 76 cm).</p> <p>4.0 MP— for printing up to 20 x 30 in. (50 x 76 cm); pictures are medium resolution, smaller file size.</p> <p>3.1 MP—for printing up to 11 x 14 in. (28 x 36 cm); pictures are medium resolution, smaller file size.</p> <p>1.1 MP—for printing 4 x 6 in. (10 x 15 cm) prints, emailing, Internet, screen display, or for conserving space.</p>
<p>Video Size Choose a video resolution. <i>This setting remains until you change it.</i></p>	<p>640 x 480 (default)—Best quality; largest file size.</p> <p>640 x 480 Long—Medium quality; medium file size.</p> <p>320 x 240—Lowest quality; smallest file size.</p>
<p>White Balance Choose your lighting condition. <i>This setting remains until you change modes or turn off the camera.</i></p>	<p>Auto (default)—automatically corrects white balance. Ideal for general picture taking.</p> <p>Daylight—for pictures in natural lighting.</p> <p>Tungsten—corrects the orange cast of household light bulbs. Ideal for indoor pictures under tungsten or halogen lighting without flash.</p> <p>Fluorescent—corrects the green cast of fluorescent lighting. Ideal for indoor pictures under fluorescent lighting without flash.</p> <p>Open Shade—for pictures in shade in natural lighting. Available in Auto and Scene-Custom mode.</p>

Setting	Options
<p>ISO Speed Control the sensitivity of the camera sensor. <i>This setting remains until you change modes or turn off the camera.</i></p>	<p>Auto (default) ISO 64, 100, 200, 400, 800</p>
<p>Color Mode Choose color tones. <i>This setting remains until you change modes or turn off the camera.</i></p>	<p>High Color Natural Color (default) Low Color Black & White Sepia—for a reddish-brown, antique look. NOTE: EasyShare software also lets you change a color picture to black-and-white or sepia. Unavailable in Video mode.</p>
<p>Sharpness Control picture sharpness. <i>This setting remains until you change it.</i></p>	<p>High Normal (default) Low</p>
<p>Exposure Metering Evaluate light levels at specific areas of a scene. <i>This setting remains until you change modes or turn off the camera.</i></p>	<p>Multi-pattern (default)—evaluates lighting conditions throughout the image to give an optimum picture exposure. Ideal for general picture taking. Center-weight—evaluates the lighting conditions of the subject centered in the lens. Ideal for backlit subjects. Center-spot—similar to Center-weight, except the metering is concentrated on a smaller area of the subject centered in the lens. Ideal when you need an exact exposure of a specific area in the picture.</p>

Setting	Options
<p>AF Control Choose an auto-focus setting. <i>This setting remains until you change it.</i></p>	<p>Continuous AF (default for video)—because the camera is always focusing, there is no need to press the Shutter button halfway down to focus.</p> <p>Single AF (default for pictures)—uses TTL-AF (through-the-lens auto focus) when the Shutter button is pressed halfway down.</p>
<p>Focus Zone Select a large or concentrated area of focus. <i>This setting remains until you change it.</i></p>	<p>Multi-zone (default)—evaluates 5 zones to give an even picture focus. Ideal for general picture taking.</p> <p>Center-zone—evaluates the small area centered in the lens. Ideal when precise focus of a specific area in the picture is needed.</p>
<p>Long Time Exposure Choose how long the shutter stays open.</p>	<p>None (default) 0.5, 0.6, 0.8, 1.0, 1.3, 1.6, 2.0, 2.5, 3.2, 4.0, 5.0, 6.0, or 8.0 seconds</p>
<p>Reset to Default</p>	<p>All picture-taking settings return to their default. Available only in Scene-Custom mode.</p>
<p>Set Album Choose, Add, or Delete albums. <i>This setting remains until you change it. You can apply different Set Album choices to videos and to pictures.</i></p>	<p>Choose an album Clear All (check marks) Pre-select album names before you take pictures/videos. Then, all the pictures/videos you take are tagged with those album names. See page 42.</p>
<p>Video Length Choose video record length. <i>This setting remains until you change it.</i></p>	<p>Continuous (default) 5 seconds 15 seconds 30 seconds</p>
<p>Image Stabilizer Improve video stability.</p>	<p>On (default) Off</p>

Setting	Options
Image Storage Choose a storage location for pictures/videos. <i>This setting remains until you change it.</i>	Auto (default) —the camera uses the card if one is in the camera. If not, the camera uses internal memory. Internal Memory —the camera always uses internal memory, even if a card is installed.
Setup Menu Choose additional settings.	See Customizing your camera .

Customizing your camera

Use Setup to customize your camera settings.

- 1 In any mode, press the Menu button.
- 2 Press ▲/▼ to highlight Setup Menu, then press the OK button.
- 3 Press ▲/▼ to highlight the setting you wish to change, then press the OK button.
- 4 Choose an option, then press the OK button.

Setting	Options
Return to previous menu.	
Camera Sounds Choose sound effects.	Theme —applies the same sound effect set to all functions. Individual —choose a sound for each function.
Sound Volume	Off High Medium (default) Low



Setting	Options
Bluetooth	Set Passcode Security Camera Name Transfer Size
Digital Zoom	On (default) Off
LCD Brightness Choose LCD brightness.	Power Save High Power (default)
LCD Dimmer Choose inactivity time until LCD dims.	30 seconds 20 seconds 10 seconds (default) Off (no dimming)
Auto Power Off Choose inactivity time until camera turns off.	10 minutes 5 minutes 3 minutes (default) 1 minute
Date & Time	See page 3 .
Video Out Choose the regional setting that lets you connect the camera to a television or other external device.	NTSC (default) —used in North America and Japan; most common format. PAL —used in Europe and China.
Photo Frame Choose EasyShare photo frame dock 2 settings.	Interval (between slide show frames) Loop (On/Off, for slide show) Transition (between slide show frames) Source (Auto/Internal/Favorites) Run Time (for slide show)

Setting	Options
Auto Picture Rotation Orient pictures so that they are displayed with the correct side up on the camera.	On (default) Off
Orientation Sensor Orient pictures so that they are displayed with the correct side up on the computer.	On (default) Off On Transfer —sets Orientation Sensor on camera LCD to Off. When a picture is transferred to the computer using EasyShare software, it is rotated to the proper orientation.
Red Eye Preflash Choose if a preflash fires when the flash is in Red Eye mode.	On (default) —red eye flash fires before the picture is taken. Off —red eye flash does not fire. NOTE: The camera automatically corrects red eye, even if the Red Eye Preflash is set to Off.
Date Stamp Imprint the date on pictures.	Choose a date option, or turn off the feature. (Default is off.)
Video Date Display Display Date/Time at the start of video playback.	Choose a date option, or turn off the feature. (Default is off.)
Blur Warning	On (default) Off See page 27 .
Language	Choose your language.

Setting	Options
Format  CAUTION: Formatting deletes all pictures/videos, including those that are protected. Removing a card during formatting may damage the card.	Memory Card —deletes everything on the card; formats the card. Cancel —exits without making a change. Internal Memory —deletes everything in internal memory including email addresses, album names, and favorites; formats the internal memory.
About View camera information.	

Using exposure compensation to adjust picture brightness

You can adjust exposure compensation before you take a picture to make your pictures darker or lighter.

- Press  to decrease exposure compensation.
- Press  to increase exposure compensation.

The exposure compensation level is shown on the LCD; the LCD gets brighter or dimmer.

Using the histogram to view picture brightness

Use the histogram to evaluate the distribution of light before or after you take a picture. If the peak is to the right of the graph, the subject is bright; if it's to the left, the subject is dark. Optimal exposure is achieved when the peak is in the middle of the histogram. The flash may affect a picture's light and shadow.

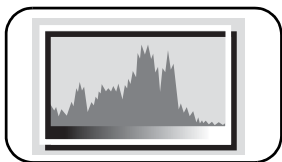

To turn on the histogram in Capture mode or in Review, press the LCD/Info **i**  button until the histogram appears.

Using the framing grid to compose a picture

The framing grid divides the LCD into thirds—vertically and horizontally. This is helpful if, for example, you want to balance a picture between water, earth, and sky.



To turn on the framing grid in Capture mode, press the LCD/Info **i**  button until the grid appears.

Sharing your pictures

Press the Share button to tag your pictures/videos. When they are transferred to your computer, you can share them. Press the Share button to tag pictures/videos:

- Any time. (The most recent picture/video taken is then displayed.)
- Just after you take a picture/video, during quickview (see [page 5](#)).
- After pressing the Review button (see [page 16](#)).

Tagging pictures for printing

- 1 Press the Share button. Press ◀/▶ to find a picture.
- 2 Press ▲/▼ to highlight Print, then press the OK button.*
- 3 Press ▲/▼ to select the number of copies (0–99). Zero removes the tag for that picture.

The Print icon appears in the status area. The default quantity is one.

- 4 **Optional:** You can apply a print quantity to other pictures. Press ◀/▶ to find a picture. Keep the print quantity as is, or press ▲/▼ to change it. Repeat this step until the desired print quantity is applied to the pictures.

- 5 Press the OK button. Then press the Share button to exit the menu.

* To tag all pictures in the storage location, highlight Print All, press the OK button, then indicate the number of copies. Print All is not available in quickview. To remove print tagging for all pictures in the storage location, highlight Cancel Prints, then press the OK button. Cancel Prints is not available in quickview.

Printing tagged pictures

When you transfer the tagged pictures to your computer, the EasyShare software print screen opens. For details on printing, see Help in EasyShare software.

For more information on printing from your computer, printer dock, PictBridge enabled printer, or card, see [page 45](#).

NOTE: For the best 4 x 6 in. (10 x 15 cm) prints, use the 5.3 MP (3:2) picture size. See [page 29](#).

Tagging pictures/videos for emailing

First—create email addresses

You can add email addresses using Kodak EasyShare software. Then, copy up to 32 email addresses to the camera's internal memory. (For details, see Help in EasyShare software.)

Second—tag pictures/videos on your camera

1 Press the Share button. Press ◀/▶ to find a picture/video.

2 Press ▲/▼ to highlight Email, then press the OK button.

The Email icon  appears in the status area.

3 Press ▲/▼ to highlight an email address, then press the OK button.

To tag other pictures/videos with the same address, press ◀/▶ to scroll through them. When the picture you want is displayed, press the OK button.

To send the pictures/videos to more than one address, repeat step 3 for each address.

Selected addresses are checked.

4 To remove a selection, highlight a checked address and press the OK button. To remove all email selections, highlight Clear All.

5 Press ▲/▼ to highlight Exit, then press the OK button.

The Email icon  appears in the status area.

6 Press the Share button to exit the menu.







Third—transfer and email

When you transfer the tagged pictures/videos to your computer, the Email screen opens and lets you send them to the addresses you specified. For details, see Help in EasyShare software.

Tagging pictures as favorites

You can preserve your favorite pictures in the Favorites  section of your camera's internal memory, then share them with friends and family.



NOTE: When you transfer pictures from your camera to your computer, all pictures (including favorites) are stored on your computer at full size. Favorite pictures—smaller copies of your originals—are loaded back to your camera, so you can share and enjoy more.

Step	Action
1. Tag pictures as favorites	<p>1 Press the Share button. Press  to find a picture.</p> <p>2 Press  to highlight Favorite , then press the OK button.</p> <p><i>The Favorite icon  appears in the status area. To remove the tag, press the OK button again.</i></p>
2. Transfer pictures to your computer	<p>1 To enjoy full functionality, load and use the EasyShare software that was packaged with this camera. (See page 43.)</p> <p>2 Connect the camera to the computer using a USB cable model U-8 (see page 44) or an EasyShare dock.</p> <p><i>The first time you transfer pictures, the software helps you make choices about your favorite pictures. Then, your pictures are transferred to the computer. Favorite pictures (smaller versions of the originals) are loaded to the Favorites section of your camera's internal memory.</i></p>
3. View favorites on your camera	<p>1 Press the Favorites  button.</p> <p>2 Press  to scroll through favorites.</p>

NOTE: The camera holds a limited number of favorites. Use Camera Favorites in EasyShare software to customize the size of your camera Favorites section. Videos tagged as favorites remain in the Favorites folder in EasyShare software. For details, see Help in EasyShare software.



Optional settings

In Favorites mode, press the Menu button to access optional settings.

	Slide Show (page 20)		Remove all favorites (page 40)
	Multi-up (page 24)		Setup Menu (page 32)

NOTE: Pictures taken at the 5.3 MP (3:2) picture size are displayed at a 3:2 aspect ratio with a black bar at the top and bottom of the screen.

Removing all favorites from your camera

- 1 Press the Favorites  button.
- 2 Press the Menu button.
- 3 Press / to highlight Remove Favorites, then press the OK button.

All pictures stored in the Favorites section of internal memory are removed. Favorites are restored the next time you transfer pictures to the computer.



- 4 Press the Menu button to exit the menu.

Preventing favorites from transferring to the camera

- 1 Open Kodak EasyShare software. Click the My Collection tab.
- 2 Go to the Albums view.
- 3 Click the Camera Favorites Album for your camera.
- 4 Click Remove Album.

The next time you transfer pictures from your camera to the computer, use the Camera Favorites Wizard/Assistant to either recreate your Camera Favorites Album or to turn off the Camera Favorites feature.

Printing and emailing favorites

- 1 Press the Favorites  button. Press /  to find a picture.
- 2 Press the Share button.
- 3 Highlight Print or Email, then press the OK button.

NOTE: Favorites that were taken on this camera (not imported from another source) are good for prints up to 4 x 6 in. (10 x 15 cm).





Tagging pictures/videos for albums



Use the Album feature in Review mode to tag the pictures/videos in your camera with album names.

First—on your computer

Use Kodak EasyShare software to create album names on your computer, then copy up to 32 album names to the camera's internal memory. For details, see Help in EasyShare software.

Second—on your camera

- 1 Press the Review button, then find the picture/video.
- 2 Press the Menu button.
- 3 Press /  to highlight Album, then press the OK button.
- 4 Press /  to highlight an album name, then press the OK button.

To add other pictures to the same album, press /  to scroll through the pictures. When the picture you want is displayed, press the OK button.

To add the pictures to more than one album, repeat step 4 for each album.

The album name appears with the picture. A plus (+) after the album name means the picture was added to more than one album.

To remove a selection, highlight an album name and press the OK button. To remove all album selections, select Clear All.

Third—transfer to your computer

When you transfer the tagged pictures/videos to your computer, EasyShare software opens and categorizes your pictures/videos in the appropriate album. For details, see Help in EasyShare software.

Pre-tagging for album names

Use the Set Album (Still or Video) feature to pre-select album names before you take pictures/videos. Then, all the pictures/videos you take are tagged with those album names.

First—on your computer

You can add albums using Kodak EasyShare software. Then, copy up to 32 album names to the camera's internal memory. (For details, see Help in EasyShare software.)

Second—on your camera

- 1 In any capture mode, press the Menu button.
- 2 Press $\blacktriangle/\blacktriangledown$ to highlight Set Album, then press the OK button.
- 3 Press $\blacktriangle/\blacktriangledown$ to highlight an album name, then press the OK button. Repeat to mark pictures/videos for albums.
- 4 Highlight Exit, then press the OK button.
- 5 Press the Menu button to exit the menu.

Your selections are saved. Your album selection is displayed on the LCD. A plus (+) after the album name means more than one album is selected.

Third—transfer to your computer

When you transfer the tagged pictures/videos to your computer, EasyShare software opens and categorizes your pictures/videos in the appropriate album. For details, see Help in EasyShare software.

5

Transferring and printing pictures



CAUTION:

Install Kodak EasyShare software *before* connecting an EasyShare camera or dock to the computer. Failure to do so may cause the software to load incorrectly.

Installing the software

- 1 Close all software applications that are open on your computer (including anti-virus software).
- 2 Place the Kodak EasyShare software CD into the CD-ROM drive.
- 3 Load the software:
Windows OS—if the install window does not appear, choose Run from the Start menu and type **d:\setup.exe** where **d** is the drive letter that contains the CD.
Mac OS X—double-click the CD icon on the desktop, then click the Install icon.
- 4 Follow the on-screen instructions to install the software.

NOTE: When prompted, register your camera and software. Registering lets you sign up for information that keeps your system up-to-date. To register later, visit www.kodak.com/go/register.

For information on the software applications included on the Kodak EasyShare software CD, see Help in EasyShare software.

Transferring pictures/videos

Using the USB cable

If you do not have an EasyShare dock, use the USB / A/V connector and Kodak USB cable, model U-8 (may be sold separately).

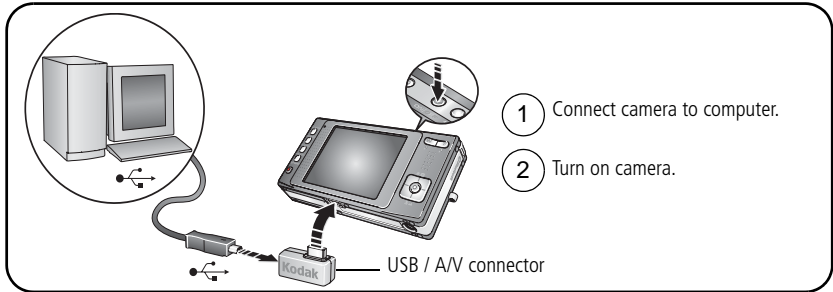

Using the photo frame dock 2

If you have a Kodak EasyShare photo frame dock 2, use it to transfer pictures. (To purchase accessories, visit www.kodak.com/go/v610accessories.)

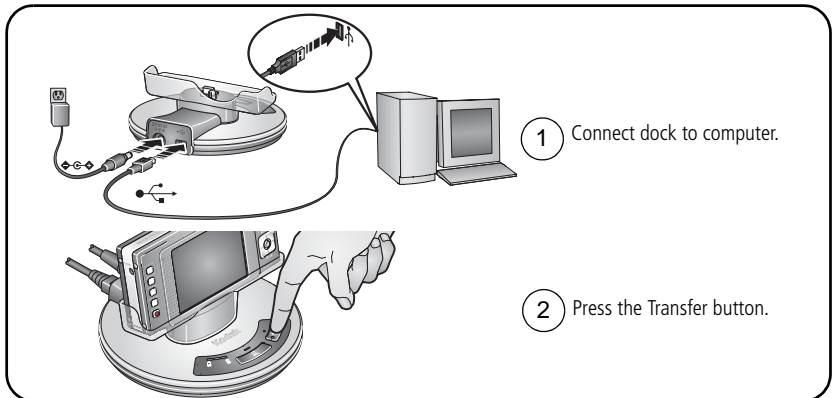

Using other options

You can also use these Kodak products to transfer your pictures/videos:

- Kodak EasyShare camera dock, Kodak EasyShare printer dock (see [page 47](#))
- Kodak card readers

NOTE: To purchase accessories, visit www.kodak.com/go/v610accessories.

Visit www.kodak.com/go/howto for an online tutorial on connecting.

Printing pictures

Printing with a Kodak EasyShare printer dock

Dock your camera to the Kodak EasyShare printer dock and print with or without a computer. To purchase accessories, visit www.kodak.com/go/v610accessories.

For dock compatibility, see [page 47](#).

Direct printing with a PictBridge enabled printer

Your camera is compatible with PictBridge technology, so you can print directly to PictBridge enabled printers. You need:

- Camera with fully charged battery
- PictBridge enabled printer
- USB cable

Connecting the camera to a PictBridge enabled printer

- 1 Turn off the camera and printer.
- 2 Connect the appropriate USB cable from the camera to the printer. See your printer user guide for details or www.kodak.com/go/v610accessories to order cables.

Printing from a PictBridge enabled printer

- 1 Turn on the printer. Turn on the camera.

The PictBridge logo is displayed, followed by the current picture and menu. (If no pictures are found, a message is displayed.) If the menu interface turns off, press any button to redisplay it.

- 2 Press ▲/▼ to choose a printing option, then press the OK button.

Current Picture—Press ◀/▶ to choose a picture. Choose the number of copies.

Tagged Pictures—If your printer is capable, print pictures that you tagged for printing and choose a print size.

Index Print—Print thumbnails of all pictures. (This option requires one or more sheets of paper.) If the printer is capable, choose a print size.

All Pictures—Print all pictures in internal memory, on a card, or in Favorites. Choose the number of copies.

Image Storage—Access internal memory, a card, or Favorites.

NOTE: During direct printing, pictures are not permanently transferred or saved to the printer. To transfer pictures to your computer, see [page 43](#). In Favorites mode, the current favorite picture is displayed.

Disconnecting the camera from a PictBridge enabled printer

- 1 Turn off the camera and printer.
- 2 Disconnect the USB cable from the camera and the printer.

Using a printer that is not PictBridge enabled

After you transfer pictures from the camera to your computer, you can print them from EasyShare software. For details, see Help in EasyShare software.

Ordering prints online

Kodak EasyShare gallery (www.kodakgallery.com) is one of the many online print services offered in EasyShare software. You can easily:

- Upload your pictures.
- Edit, enhance, and add borders to your pictures.
- Store pictures, and share them with family and friends.
- Order high-quality prints, photo greeting cards, frames, and albums—and have them delivered to your door.

Printing from an optional SD or MMC card

- Automatically print tagged pictures when you insert your card into a printer with an SD/MMC card slot. See your printer user's guide for details.
- Make prints at an SD/MMC card-capable Kodak picture maker/picture kiosk. (Contact a location prior to visiting. Visit www.kodak.com/go/picturemaker.)
- Take the card to your local photo retailer for professional printing.

Dock compatibility for your camera

To see which EasyShare camera and printer docks are compatible with your camera, visit www.kodak.com/go/adaptorkitchart.

To purchase camera docks, printer docks, and other accessories, visit www.kodak.com/go/v610accessories.

6

Using Bluetooth wireless technology features

Your camera features Bluetooth® wireless technology, so your camera can share pictures with a Bluetooth device such as a printer, cell phone, PDA, or computer.

NOTE: For the best Bluetooth experience, check your device or service provider documentation to learn its capabilities and limits. Kodak is not responsible for variables beyond our control. When using Bluetooth devices, obey all laws and respect the privacy and rights of others. Do not use a Bluetooth device when it may cause radio interference.

This camera can send/receive pictures in the JPEG (.jpg) format; it cannot send/receive videos.

Setting up the Bluetooth feature of your camera

- 1 Press the Menu button.
- 2 Press $\blacktriangle/\blacktriangledown$ to highlight Setup Menu, then press the OK button.
- 3 Press $\blacktriangle/\blacktriangledown$ to highlight Bluetooth, then press the OK button. Then choose:

Setting	Options
Set Passcode —A password for your camera. A passcode minimizes risk of unauthorized access.	Enter a passcode up to 4 digits.
Security —Turn security on to minimize risk of unauthorized access. A passcode needs to be set first.	On Off (default)
Camera Name —How your camera is known to devices. (Default is Kodak EasyShare V610.)	Enter an alphanumeric name up to 32 characters.
Transfer Size —Choose a default picture size; or choose the size each time pictures are transferred.	Ask Every Time (default) QVGA-Fast Transfer XGA-4 x 6 Print Quality Full Resolution

Making the “set as trusted” choice

You can share pictures between your camera and another Bluetooth device in 2 ways. Choose the method that is best for you:

Method	Advantage	See
Set up your camera so it trusts your devices	Faster if you will use this device again in the future. <ul style="list-style-type: none"> ■ You make fewer menu choices when sending pictures. ■ Your camera will be familiar with Bluetooth passcodes of trusted devices. (A Passcode is not required to connect with a trusted device.) ■ Only trusted Bluetooth devices appear as “Available.” 	Set up your camera to trust your devices, page 49
Skip the “Set as Trusted” step	Faster for one-time communication.	Getting the best Bluetooth reception, page 50.

Set up your camera to trust your devices

NOTE: Skip this section if you are not going to set your devices as trusted. To learn more, see [Making the “set as trusted” choice, page 49.](#)

- 1 Press the Share button.
- 2 Press ▲/▼ to highlight Bluetooth, then press the OK button. Highlight Set as Trusted, then press the OK button.
- 3 Highlight one of four available Trusted Device slots. (Choose an open slot, or choose one that already has a trusted device and overwrite it.) Then press the OK button.

The camera’s Bluetooth radio turns on and searches for devices.

- 4 On the camera, select the device to be trusted.
On the device, enter the V610 passcode.

NOTE: If a device is not trusted, you may set it as trusted after you send pictures.

Getting the best Bluetooth reception

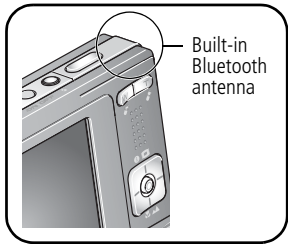

While sending and receiving pictures:

- Point the back of the camera toward another Bluetooth device.
- Keep metal objects (such as jewelry) away from the Bluetooth antenna. Do not cover the antenna.
- Keep the camera within 33 ft (10 m) of the device.

NOTE: 10 ft (3 m) is best for camera-to-camera sharing.

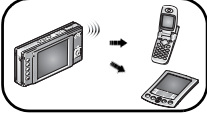
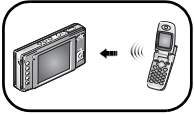
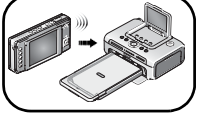
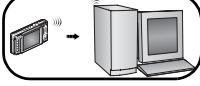
To	See
Send pictures to a device 	page 51
Receive pictures from a device 	page 52
Send pictures to a printer 	page 53
Send pictures to a computer 	page 54

Sending pictures to a device

Before you begin

- You need a Bluetooth enabled device.
- You can send pictures, but not videos. To transfer several different pictures, select them first (see [Selecting multiple pictures/videos, page 25](#)).

Transferring pictures

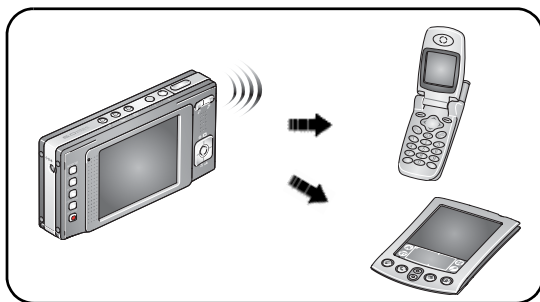

- 1 Press the Share button.
- 2 Press $\blacktriangle/\blacktriangledown$ to highlight Bluetooth, then press the OK button.
- 3 If your device is trusted by your camera, go to step 4. If it's not trusted, press $\blacktriangle/\blacktriangledown$ to highlight Send, then press the OK button.
- 4 Select the trusted device, then press the OK button.
- 5 Follow the prompts to:
 - Enter passcode (if required)
 - Choose picture size (if required)
 - Set as a trusted device (if required)

Selected pictures are transferred. If no pictures are selected, the picture currently shown on the LCD is transferred.

Receiving pictures from a device

Before you begin

You need a Bluetooth enabled device, such as a cell phone.

NOTE: Your camera can only accept JPEG files that have a .jpg suffix.

Transferring pictures

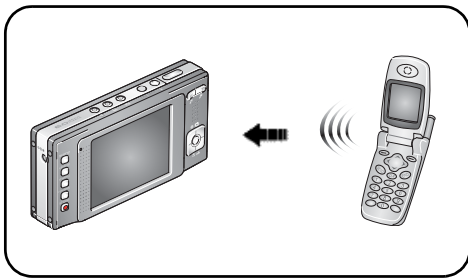

- 1 Press the Share button.
- 2 Press $\blacktriangle/\blacktriangledown$ to highlight Bluetooth, then press the OK button.
- 3 Press $\blacktriangle/\blacktriangledown$ to highlight Receive, then press the OK button.
The camera's Bluetooth radio turns on.
- 4 On the sending device, find the V610 camera. Then send the pictures.
The camera prompts you to accept the file.

Sending pictures to a printer

Before you begin

- You need a Bluetooth enabled printer.
- You can send pictures, but not videos. To print several different pictures, select them first (see [Selecting multiple pictures/videos, page 25](#)).

Printing pictures

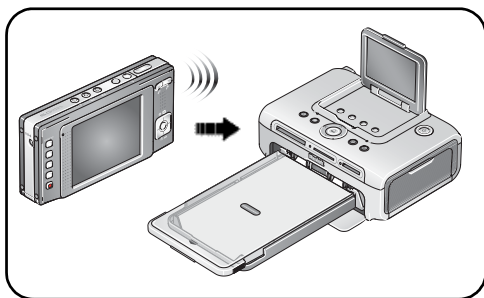

- 1 Press the Share button.
- 2 Press $\blacktriangle/\blacktriangledown$ to highlight Bluetooth, then press the OK button.
- 3 If your device is trusted by your camera, skip to the next step. If it's not trusted, press $\blacktriangle/\blacktriangledown$ to highlight Send, then press the OK button.
- 4 Select the device, then press the OK button.
- 5 Follow the prompts to:
 - Enter passcode (if required)
 - Choose picture size (if required)
 - Set as a trusted device (if required)

Selected pictures are printed. If no pictures are selected, the picture currently shown on the LCD is printed.

Sending pictures to a computer

Before you begin

- You need a Bluetooth enabled computer.
- You can send pictures, but not videos. To transfer several different pictures, select them first (see [Selecting multiple pictures/videos, page 25](#)).

Transferring pictures

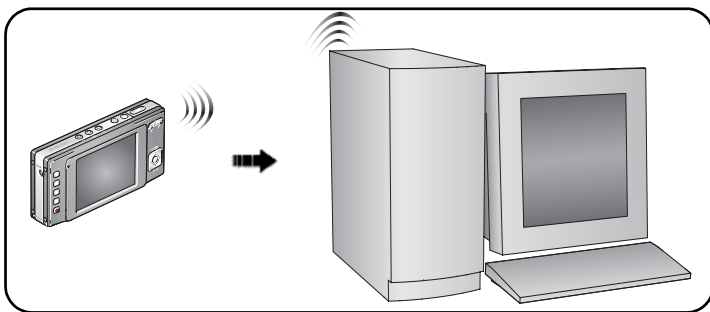

- 1 Press the Share button.
- 2 Press $\blacktriangle/\blacktriangledown$ to highlight Bluetooth, then press the OK button.
- 3 If your device is trusted by your camera, go to step 4. If it's not trusted, press $\blacktriangle/\blacktriangledown$ to highlight Send, then press the OK button.
- 4 Select the device, then press the OK button.
- 5 Follow the prompts to:
 - Enter passcode (if required)
 - Choose picture size (if required)
 - Set as a trusted device (if required)

Selected pictures are transferred. If no pictures are selected, the picture currently shown on the LCD is transferred.

7

Troubleshooting

Camera problems

Status	Possible Solutions
Camera does not turn on or off	<ul style="list-style-type: none"> ■ Make sure the correct battery type is properly installed and charged (page 1).
Camera buttons and controls do not function	
In Review, a blue or black screen is displayed instead of a picture	<ul style="list-style-type: none"> ■ Transfer <i>all</i> pictures to the computer (page 43). ■ Take another picture. If the problem continues, change the image storage location to internal memory (page 32).
Pictures remaining number does not decrease after taking a picture	<ul style="list-style-type: none"> ■ Continue taking pictures. The camera is operating normally. (The camera estimates the number of pictures remaining after each picture is taken, based on picture size and content.)
Picture orientation is not accurate	<ul style="list-style-type: none"> ■ Set the Orientation Sensor to ON (page 34).
Flash does not fire	<ul style="list-style-type: none"> ■ Check the flash setting, and change as needed (page 9). <p>NOTE: The flash does not fire in all modes.</p>
Storage location is almost or entirely full	<ul style="list-style-type: none"> ■ Transfer the pictures to the computer (page 43). ■ Delete pictures from the card or insert a new card. ■ Change the image storage location to internal memory (page 32).

Status	Possible Solutions
Battery life is short	<ul style="list-style-type: none"> ■ Make sure the correct battery type is installed (page 1). ■ Wipe the contacts with a clean, dry cloth before inserting a battery in the camera. ■ Insert a new or charged battery (page 1).
You cannot take a picture	<ul style="list-style-type: none"> ■ Turn the camera off, then on again. Make sure the camera is not in Favorites mode. ■ Depress the Shutter button all the way (page 5). ■ Insert a new or charged battery (page 1). ■ Wait until the Ready light turns green before taking another picture. ■ Memory is full. Transfer pictures to the computer (page 43), delete pictures (page 17), change image storage location, or insert another card.
Error message appears on LCD	<ul style="list-style-type: none"> ■ Turn the camera off, then on again. ■ Remove the memory card. ■ Remove the battery. Wipe the contacts with a clean, dry cloth. ■ Insert a new or charged battery. ■ If the problem still exists, get help (page 60).
Memory card not recognized or camera freezes with card	<ul style="list-style-type: none"> ■ Card may be corrupted. Format the card in the camera (page 35). ■ Use another memory card.

Computer/connectivity problems

Status	Possible Solutions
Computer does not communicate with the camera	<ul style="list-style-type: none"> ■ Insert a charged battery (page 1). ■ Turn on the camera. ■ Make sure the USB cable model U-8 is connected to the camera and the computer (page 44). (If using an EasyShare dock, check all cable connections. Make sure the camera is seated on the dock.) ■ Make sure EasyShare software is installed (page 43).
Pictures do not transfer to computer	<ul style="list-style-type: none"> ■ See Help in EasyShare software.
Slide Show does not run on an external video device	<ul style="list-style-type: none"> ■ Adjust the camera Video Out setting (NTSC or PAL, page 33). ■ Make sure the external device settings are correct. (See the device's user's guide).

Bluetooth problems

Light status	Cause
Camera cannot communicate with another device.	<ul style="list-style-type: none"> ■ Make sure the antenna is not obscured, and the camera is properly set up. (See Using Bluetooth wireless technology features, page 48.) ■ Make sure the external device settings are correct. (See the device's user's guide).
Bluetooth status lights flash in succession	The camera's Bluetooth radio is on; the camera is connecting to another device.
Bluetooth status lights flash in unison	The camera's Bluetooth radio is on; the camera is sending/receiving.
Lights are off	The camera's Bluetooth radio is off; the camera is unable to send/receive Bluetooth signals.

Picture quality problems

Status	Possible Solutions
Picture is not clear	<ul style="list-style-type: none"> ■ To automatically set exposure and focus, press the Shutter button halfway. When the Ready light turns green, press the Shutter button completely down to take the picture. ■ Clean the lens (page 69). ■ Make sure the camera is not in Close-up mode if you are more than 27.6 in. (70 cm) from your subject. ■ Place the camera on a flat, steady surface or use a tripod (especially in high-zoom settings or in low light).
Picture is too dark	<ul style="list-style-type: none"> ■ Reposition the camera for more available light. ■ Use Fill flash (page 9) or change your position so light is not behind the subject. ■ Move so that the distance between you and the subject is within the effective flash range (page 63). ■ To automatically set exposure and focus, press the Shutter button halfway. When the Ready light turns green, press the Shutter button completely down to take the picture.
Picture is too light	<ul style="list-style-type: none"> ■ Reposition the camera to reduce the amount of available light. ■ Turn the flash off (page 9). ■ Move so that the distance between you and the subject is within the effective flash range (page 63). ■ To automatically set exposure and focus, press the Shutter button halfway. When the Ready light turns green, press the Shutter button completely down to take the picture. ■ In Auto and Scene-Custom modes, adjust the Exposure Compensation (page 35).

Direct printing (PictBridge enabled printer) problems

Status	Possible Solutions
Cannot find desired picture	<ul style="list-style-type: none"> ■ Turn on the camera. Make sure the camera is not in Favorites mode. ■ Use the Direct print menu to change the image storage location.
The Direct print menu interface turns off	<ul style="list-style-type: none"> ■ Press any camera button to redisplay the menu.
Cannot print pictures	<ul style="list-style-type: none"> ■ Make sure there is a connection between the camera and the printer (page 45). ■ Make sure the printer and the camera have power.
Camera or printer display an error message	<ul style="list-style-type: none"> ■ Follow the prompts to resolve the issue.

8

Getting help

Camera

Email, write, or phone Kodak	www.kodak.com/go/contact
Get support for your product (FAQs, troubleshooting information, arrange for repairs, etc.)	www.kodak.com/go/v610support
Purchase camera accessories (camera docks, printer docks, lenses, cards, etc.)	www.kodak.com/go/v610accessories
Download the latest camera firmware and software	www.kodak.com/go/v610downloads
See online demonstrations of your camera	www.kodak.com/go/howto

Software

Get information on EasyShare software	www.kodak.com/go/easysw (or see Help in EasyShare software)
Get help with the Windows operating system and working with digital pictures	www.kodak.com/go/pcbasics

Other

Get support for cameras, software, accessories, more	www.kodak.com/go/support
Get information on Kodak EasyShare printer docks	www.kodak.com/go/printerdocks
Get information on Kodak inkjet products	www.kodak.com/go/inkjet
Optimize your printer for truer, more vibrant colors	www.kodak.com/go/onetouch
Register your camera	www.kodak.com/go/register

NOTE: If you have questions concerning this product, you may speak with Kodak customer support.

Australia	1800 147 701	New Zealand	0800 440 786
Austria	0179 567 357	Norway	23 16 21 33
Belgium	02 713 14 45	Philippines	1 800 1 888 9600
Brazil	0800 150000	Poland	00800 4411625
Canada	1 800 465 6325	Portugal	021 415 4125
China	800 820 6027	Russia	8 495 929 9166
Denmark	3 848 71 30	Singapore	800 6363 036
Ireland	01 407 3054	Spain	91 749 76 53
Finland	0800 1 17056	Sweden	08 587 704 21
France	01 55 1740 77	Switzerland	01 838 53 51
Germany	069 5007 0035	Taiwan	0800 096 868
Greece	00800 44140775	Thailand	001 800 631 0017
Hong Kong	800 901 514	Turkey	00800 448827073
India	91 22 617 5823	United Kingdom	0870 243 0270
Italy	02 696 33452	United States	1 800 235 6325 585 781 6231 (toll)
Japan	03 5540 9002	International Toll Line	+44 131 458 6714
Korea	00798 631 0024	International Toll Fax	+44 131 458 6962
Netherlands	020 346 9372		

Camera specifications

For more specifications, visit www.kodak.com/go/v610support.

CCD—1/2.5 in. CCD, 4:3 aspect ratio

Picture size—

- 6.0 MP: 2832 x 2128 pixels
- 5.3 MP (3:2): 2832 x 1888 pixels
- 4.0 MP: 2304 x 1728 pixels
- 3.1 MP: 2048 x 1536 pixels
- 1.1 MP: 1200 x 900 pixels

Color display—2.8 in. (7 cm) color hybrid LCD, 960 x 240 (230 K) pixels

Preview (LCD)—Frame rate: 30 fps

Taking lens—Two Schneider-Kreuznach C-Variogon lenses; combined zoom ratio 10X

Lens protection—Built-in

Focal length—35 mm equivalent:

- Wide: 38–114 mm, f/3.9–4.4
- Tele: 130–380 mm, f/4.8

Digital zoom—Combined zoom settings 1–4X in 0.2X increments (not supported for movie capture)

Exposure metering—TTL-AE; Multi-pattern, Center-spot, Center-weight

Exposure compensation—+/-2.0 EV with 1/3 EV step

ISO speed—

- Auto: 64–400
- Selectable: 64, 100, 200, 400, 800

Shutter speed—8–1/1200 sec. (Wide and Tele)

Focus system—TTL-AF; auto, multi-zone, center-zone. Working range:

2 ft (0.6 m)—infinity @ Wide

2 ft (0.6 m)—infinity @ T-Wide

5.2 ft (1.6 m)—infinity @ T-Tele

0.2–2.3 ft (0.05–0.7 m) @ W-Wide macro

1–2.3 ft (0.3–0.7 m) @ W-Tele macro

1–2.3 ft (0.3–0.7 m) @ T-Wide macro

2.3–5.6 ft (0.7–1.7 m) @ T-Tele macro

32.9 ft (10 m)—infinity @ Landscape mode

Flash—Auto flash with photo sensor; Auto, Fill, Red Eye, Off; working range:

@ Auto ISO 280:

2–9.5 ft (0.6–3.4 m) @ W-Wide

2–8.2 ft (0.6–2.5 m) @ W-Tele

@ Auto ISO 400:

2–10.8 ft (0.6–3.3 m) @ T-Wide

2–10.8 ft (0.6–3.3 m) @ T-Tele

Capture modes—Auto, Video, Scene modes

Burst mode—Maximum 8 pictures @ 3 fps; Auto Exposure, Auto Focus, Auto White Balance executed for first shot only

Video capture—30 fps; VGA (640 x 480) @ 30 fps; VGA (640 x 480) Long; QVGA (320 x 240) @ 30 fps

Image file format—

Still: EXIF 2.21 (JPEG compression); file organization DCF

Video: QuickTime (CODEC MPEG-4)

Image storage—Optional MMC or SD Card  (The SD logo is a trademark of the SD Card Association.)

Internal storage capacity—32 MB internal memory/28 MB available for image storage. (1 MB equals one million bytes.)

Quickview—Yes

Video output—NTSC or PAL

Power—Kodak Li-Ion rechargeable digital camera battery KLIC-7001

Communication with computer—USB 2.0 (PIMA 15740 protocol), via USB cable model U-8, EasyShare camera dock or printer dock; Bluetooth technology version 2.0 + EDR

PictBridge support—Yes

Self-timer—2 seconds, 10 seconds, 2-shot (10 and 18 seconds)

White Balance—Auto, Daylight, Tungsten, Fluorescent, Open Shade

Color modes—High Color, Natural Color, Low Color, Black & White, Sepia

Date stamp—None, YYYYMMDD, MMDDYYYY, DDMMYYYY

Tripod mount—1/4 inch

Operating temperature—32–104° F (0–40° C)

Size—4.3 x 2.2 x 0.9 in. (11 x 5.5 x 2.3 cm) @ power off

Weight—5.6 oz (160 g) without card or battery

Flash settings in each mode

Capture modes	Default setting	Available settings
Auto	Auto*	Auto, Off, Fill Flash, Red Eye
Portrait	Auto*	Auto, Off, Fill Flash, Red Eye
Panorama L-R, R-L	Off	Off
Sport	Auto*	Auto, Off, Fill Flash, Red Eye
Landscape	Off	Off
Close-up	Off	Off, Fill Flash
Night Portrait	Red Eye*	Auto, Off, Fill Flash, Red Eye
Night Landscape	Off	Off
Snow	Auto*	Auto, Off, Fill Flash, Red Eye
Beach	Auto*	Auto, Off, Fill Flash, Red Eye
Text	Off	Off, Fill Flash
Fireworks	Off	Off
Flower	Off	Off, Fill Flash
Manner/Museum	Off	Off
Self-Portrait	Red Eye*	Auto, Off, Fill Flash, Red Eye
Party	Red Eye*	Auto, Off, Fill Flash, Red Eye
Children	Auto*	Auto, Off, Fill Flash, Red Eye
Backlight	Fill Flash	Fill Flash
Panning Shot	Off	Off, Fill Flash
Candle Light	Off	Off, Fill Flash, Red Eye, Auto
Sunset	Off	Auto, Off, Fill Flash, Red Eye
Custom	Auto*	Auto, Off, Fill Flash, Red Eye

* When you change to Auto or Red Eye, it becomes the default until you change it.

Storage capacities

Actual storage capacity varies depending on subject composition, card brand, and other factors. You may be able to store more or fewer pictures/videos. Favorites take up additional space in internal memory.

Picture storage capacity

	Number of pictures				
	6.0 MP	5.3 MP (3:2)	4.0 MP	3.1 MP	1.1 MP
Internal memory	14	16	21	26	64
32 MB SD/MMC	16	18	24	30	73
64 MB SD/MMC	33	37	48	60	146
128 MB SD/MMC	66	74	97	121	293
256 MB SD/MMC	133	149	196	242	588
512 MB SD/MMC	266	298	392	485	1176
1 GB SD/MMC	533	596	784	970	2352

Video storage capacity

	Minutes/seconds of video		
	VGA (640 x 480)	VGA (640 x 480) Long	QVGA (320 x 240)
Internal memory	54 sec.	1 min. 46 sec.	2 min. 19 sec.
32 MB SD/MMC	1 min. 1 sec.	1 min. 59 sec.	2 min. 36 sec.
64 MB SD/MMC	2 min. 3 sec.	3 min. 59 sec.	5 min. 13 sec.
128 MB SD/MMC	4 min. 7 sec.	7 min. 59 sec.	10 min. 26 sec.
256 MB SD/MMC	8 min. 14 sec.	15 min. 58 sec.	20 min. 53 sec.
512 MB SD/MMC	16 min. 28 sec.	31 min. 57 sec.	41 min. 46 sec.
1 GB SD/MMC	32 min. 56 sec.	63 min. 54 sec.	83 min. 32 sec.

Important safety instructions

CAUTION:

Do not disassemble this product; there are no user-serviceable parts inside. Refer servicing to qualified service personnel. Do not expose this product to liquid, moisture, or extreme temperatures. Kodak AC adapters and battery chargers are intended for indoor use only. The use of controls, adjustments, or procedures other than those specified herein may result in exposure to shock and/or electrical or mechanical hazards. If the LCD breaks, do not touch the glass or liquid. Contact Kodak customer support.

Using this product

- The use of an accessory attachment that is not recommended by Kodak, such as an AC adapter, may cause fire, electric shock, or injury.
- If using this product in an airplane, observe all instructions of the airline.

Battery safety and handling

CAUTION:

When removing the battery, allow it to cool; it may be hot.

- Read and follow all warnings and instructions supplied by the battery manufacturer.
- Use only batteries approved for this product to avoid risk of explosion.
- Keep batteries out of the reach of children.
- Do not allow batteries to touch metal objects, including coins. Otherwise, a battery may short circuit, discharge energy, become hot, or leak.

- Do not disassemble, install backward, or expose batteries to liquid, moisture, fire, or extreme temperature.
- Remove the battery when the product is stored for an extended period of time. In the unlikely event that battery fluid leaks inside the product, contact Kodak customer support.
- In the unlikely event that battery fluid leaks onto your skin, wash immediately with water and contact your local health provider. For additional health-related information, contact your local Kodak customer support.
- Dispose of batteries according to local and national regulations.
- Do not charge non-rechargeable batteries.

For more information on batteries, see

www.kodak.com/global/en/service/batteries/batteryUsage.jhtml

Battery replacement, battery life

Kodak Li-Ion rechargeable digital camera battery KLIC-7001: 135 pictures per charge. Battery life per CIPA testing method. (Approx. number of pictures in Auto mode, using 128 MB SD card.) Actual life may vary based on usage.

Extending battery life

- Limit the following activities that quickly deplete battery power:
 - Reviewing your pictures on the LCD
 - Excessive use of the flash
- Dirt on the battery contacts can affect battery life. Wipe the contacts with a clean, dry cloth before loading the battery in the camera.
- Battery performance is reduced at temperatures below 41° F (5° C). When using your camera in cold weather, carry spare batteries and keep them warm. Do not discard cold batteries that do not work; when they return to room temperature, they may be usable.

Upgrading your software and firmware

Download the latest versions of the software included on the Kodak EasyShare software CD and the camera firmware (the software that runs on the camera). See www.kodak.com/go/v610downloads.

Additional care and maintenance

- If the camera has been subjected to inclement weather or you suspect water has gotten inside the camera, turn off the camera and remove the battery and card. Allow all components to air-dry for at least 24 hours before using the camera again.
- Blow gently on the lens or LCD to remove dust and dirt. Wipe gently with a soft, lint-free cloth or an untreated lens-cleaning tissue. Do not use cleaning solutions unless designed specifically for camera lenses. Do not allow chemicals, such as suntan lotion, to contact painted surfaces.
- Service agreements may be available in your country. Contact a dealer of Kodak products for more information.
- For digital camera disposal or recycling information, contact your local authorities. In the US, visit the Electronics Industry Alliance Web site at www.eiae.org or the Kodak Web site at www.kodak.com/go/v610support.

Warranty

Limited warranty

Kodak warrants Kodak EasyShare digital cameras and accessories (excluding batteries) to be free from malfunctions and defects in both materials and workmanship for one year from the date of purchase. Retain the original dated sales receipt. Proof of the date of purchase will be required with any request for warranty repair.

Limited warranty coverage

This limited warranty will be honored only within the geographical location that Kodak digital cameras and accessories were purchased.

www.kodak.com/go/support

Kodak will REPAIR or REPLACE Kodak EasyShare digital cameras and accessories if they fail to function properly during the warranty period, subject to any conditions and/or limitations stated herein. Such repair service will include all labor as well as any necessary adjustments and/or replacement parts. Such repair or replacement is the sole remedy under this warranty.

If replacement parts are used in making repairs, these parts may be remanufactured, or may contain remanufactured materials. If it is necessary to replace the entire product, it may be replaced with a remanufactured product.

Limitations

Request for Warranty service will not be accepted without proof of date of purchase, such as a copy of the original dated Kodak EasyShare digital camera or accessory sales receipt. (Always keep the original for your records.)

This warranty does not apply to the battery(s) used in digital cameras or accessories. This warranty does not cover circumstances beyond Kodak's control, nor problems caused by failure to follow the operating instructions in the Kodak EasyShare digital cameras and accessories User's Guides.

This warranty does not apply when failure is due to shipping damage, accident, alteration, modification, unauthorized service, misuse, abuse, use with incompatible accessories or attachments, failure to follow Kodak's operation, maintenance or repacking instructions, failure to use items supplied by Kodak (such as adapters and cables), or claims made after the duration of this warranty.

Kodak makes no other express or implied warranty for this product. In the event that the exclusion of any implied warranty is ineffective under the law, the duration of the implied warranty will be one year from the purchase date.

The option of replacement is Kodak's only obligation. Kodak will not be responsible for any special, consequential or incidental damages resulting from the sale, purchase, or use of this product, regardless of the cause. Liability for any special, consequential or incidental damages (including but not limited to loss of revenue or profit, downtime costs, loss of the use of the equipment, cost of substitute equipment, facilities or services, or claims of your customers for such damages resulting from the purchase, use or failure of the product), regardless of cause or for breach of any written or implied warranty is expressly disclaimed and excluded herefrom.

Your rights

Some states or jurisdictions do not allow exclusion or limitation of incidental or consequential damages, so the above limitation or exclusion may not apply to you. Some states or jurisdictions do not allow limitations on how long an implied warranty lasts, so the above limitation may not apply to you. This warranty gives you specific rights, and you may have other rights which vary from state to state or by jurisdiction.

Outside the United States and Canada

In countries other than the United States and Canada, the terms and conditions of this warranty may be different. Unless specific Kodak warranty is communicated to the purchaser in writing by a Kodak company, no warranty or liability exists beyond any minimum requirements imposed by law, even though defect, damage, or loss may be by negligence or other act.

Regulatory compliance

FCC compliance and advisory



Kodak EasyShare V610 dual lens digital camera

This equipment has been tested and found to comply with the limits for a Class B digital device, pursuant to Part 15 of the FCC Rules. These limits are designed to provide reasonable protection against harmful interference in a residential installation.

This equipment generates, uses, and can radiate radio frequency energy and, if not installed or used in accordance with the instructions, may cause harmful interference to radio communications. However, there is no guarantee that interference will not occur in a particular installation.

If this equipment does cause harmful interference to radio or television reception, which can be determined by turning the equipment off and on, the user is encouraged to try to correct the interference by one or more of the following measures: 1) reorient or relocate the receiving antenna; 2) increase the separation between the equipment and the receiver; 3) connect the equipment to an outlet on a circuit different from that to which the receiver is connected; 4) consult the dealer or an experienced radio/TV technician for additional suggestions.

Any changes or modifications not expressly approved by the party responsible for compliance could void the user's authority to operate the equipment. Where shielded interface cables have been provided with the product or specified additional components or accessories elsewhere defined to be used with the installation of the product, they must be used in order to ensure compliance with FCC regulation.

Waste Electrical and Electronic Equipment labeling



In the European Union, do not discard this product as unsorted municipal waste. Contact your local authorities or go to www.kodak.com/go/recycle for recycling program information.

Australian C-Tick



N137

VCCI Class B ITE

この装置は、情報処理装置等電波障害自主規制協議会（VCCI）の基準に基づいたクラスB情報技術装置です。この装置は、家庭環境で使用することを目的としていますが、この装置がラジオやテレビジョン受信機に近接して使用されると、受信障害を引き起こすことがあります。取扱説明書に従って正しい取り扱いをして下さい。

English translation: This is a Class B product based on the standard of the Voluntary Control Council for Interference from Information Technology Equipment (VCCI). If this is used near a radio or television receiver in a domestic environment, it may cause radio interference. Install and use the equipment according to the instruction manual.

Korean Class B ITE

이 기기는 가정용으로 전자파적합등록을 한 기기로서 주거지역에서는 물론 모든 지역에서 사용할 수 있습니다.

English translation: As this equipment has obtained EMC registration for household use, it can be used in any area including residential areas.

Canadian DOC statement

DOC Class B Compliance—This Class B digital apparatus complies with Canadian ICES-003.

Observation des normes-Classe B—Cet appareil numérique de la classe B est conforme à la norme NMB-003 du Canada.

MPEG-4

Use of this product in any manner that complies with the MPEG-4 visual standard is prohibited, except for use by a consumer engaging in personal and non-commercial activities.

Co-location statement for Portable (NON SAR test)

This transmitter must not be co-located or operated in conjunction with any other antenna or transmitter. This equipment complies with FCC radiation exposure limits set forth for uncontrolled equipment and meets the FCC radio frequency (RF) Exposure Guidelines in Supplement C to OET65. This equipment has very low levels of RF energy that it is deemed to comply without testing of specific absorption ratio (SAR).

FCC Part 15 15.27

Properly shielded grounded cables and connectors must be used for connection to host computer and /or peripherals in order to meet FCC emission limits. AC adapter with ferrite core must be used for RF interference suppression.

FCC Part15 Subpart C 15.19(a)(3)

This device complies with Part 15 of the FCC Rules. Operation is subject to the following two conditions: (1) this device may not cause harmful interference, and (2) this device must accept any interference received, including interference that may cause undesired operation.

Industry Canada RSS-Gen Issue 1

This device complies with Part 15 of FCC Rules and RSS-Gen of IC Rules. Operation is subject to the following two conditions: (1) this device may not cause interference, and (2) this device must accept any interference, including interference that may cause undesired operation of the device.

CE

This camera contains a wireless module that is compliant with R&TTE directive. We, the manufacturer (Eastman Kodak Company) hereby declare that this equipment (Kodak EasyShare V610 dual lens digital camera; Bluetooth module BTMC2.0EDR-EP02A) is in compliance with the essential requirements and other relevant provisions of Directive 1999/5/EC.

Country-specific statements

China

<p>1. 标明附件中所规定的技术指标和使用范围, 说明所有控制、调整及开关等使用方法:</p> <ul style="list-style-type: none"> ■ 使用频率: 2.4 - 2.4835 GHz ■ 等效全向辐射功率(EIRP): <ul style="list-style-type: none"> 天线增益 < 10dBi时: ≤ 100 mW 或 ≤ 20 dBm ■ 最大功率密度: <ul style="list-style-type: none"> 天线增益 < 10dBi时: ≤ 10 dBm / MHz(EIRP) ■ 载频窄带: 20 ppm <p>2. 不得擅自更改发射功率, 加大发射功率(包括额外加载发射功率放大器), 不得擅自升降天线或改用其它发射天线;</p> <p>3. 使用时不得对各种合法的无线电业务产生有害干扰; 一旦发现有干扰现象时, 应立即停止使用, 并采取措施消除干扰后方可继续使用。</p> <p>4. 使用带功率无线电设备, 必须避免各种无线电业务的干扰或工业、科学及医疗应用设备的辐射干扰;</p> <p>5. 不得在飞机和机场附近使用。</p>

Taiwan

低功率管理办法:

- 第十二 條 經型式認證合格的低功率射頻電機, 非經許可, 公司、商號或使用者均不得擅自變更頻率、加大功率或變更原設計之特性及功能。
- 第十四 條 低功率射頻電機之使用不得影響飛航安全及合法通信; 如發現有干擾現象時, 應立即停用, 並改善至無干擾時方得繼續使用。
- 前項合法通信, 指依電信法規定作業之無線電通信。低功率射頻電機須忍受合法通信或工業、科學及醫療用電波輻射性電機設備之干擾。

Brazil

Resolução 365 – ANATEL:

"Este equipamento opera em caráter secundário, isto é, não tem direito a proteção contra interferência prejudicial, mesmo de estações do mesmo tipo, e não pode causar interferência a sistemas operando em caráter primário."

English translation: This equipment operates on a secondary basis and, consequently, must accept harmful interference, including from a station of the same kind, and may not cause harmful interference to systems operating on a primary basis.

UAE (Dubai)



Israel

א. השימוש במכשיר היינו על בסיס "משני" ופטור מרשיון הפעלה אלוטוי.
 ב. רק "בפעולת בוק" לשימוש עצמי של הלקוח בלבד, הציוד פטור מרשיון הפעלה אלוטוי.
 ג. אסור להחליף את האנטנה המקורית של המכשיר, ולא לעשות בו כל שינוי טכני אחר.

English translation: A.The usage of the device doesn't make necessary approval for radio activated operated devices. B.The device is allowed for personal usage only. Customer is not allowed to replace the original antenna or to make any kind of technical modification.

Mexico COFTEL

Este equipo opera a titulo secundario, consecuentemente, debe aceptar interferencias perjudiciales incluyendo equipos de la misma clase y puede no causar interferencias a sistemas operando a titulo primario.

English translation: This equipment operates on a secondary basis and, consequently, must accept harmful interference, including from a station of the same kind, and may not cause harmful interference to systems operating on a primary basis.

Index

A

- A/V out, 22
- about picture, video, 24
- about this camera, 35
- accessories, 45
 - battery, 68
 - buying, 60
 - printer dock, 45
 - SD/MMC card, 4
- album
 - set, 31
- albums
 - tagging pictures for, 42
- auto, 10
 - enhancement, 18
 - focus control, 31
 - focus framing marks, 6
 - power off, 33
- Auto button, i
- auto picture rotation, 34

B

- backlight, 13
- batteries
 - expected life, 68
 - extending life, 68
 - loading, 1
 - safety, 67
 - types, 68
- battery
 - compartment, ii
- beach, 12

- Bluetooth, 33
- blur warning, 27, 34
- button
 - Auto, i
 - delete, ii, 5
 - favorites, i
 - flash, i
 - LCD/Info, ii
 - Macro/Landscape, ii
 - menu, ii
 - OK, ii
 - On/Off, i
 - review, ii, 16
 - scene, ii
 - share, ii
 - shutter, i
 - video mode, i
 - wide angle, ii
 - zoom, 7

C

- cable
 - audio/video, 22
 - USB, 44
- camera sounds, 32, 48
- Canadian compliance, 72
- caring for your camera, 69
- children, 12
- clock, setting, 3
- color mode, 30
- computer
 - connecting camera, 43

transfer to, 43
connector, USB / A/V, 22, 44
copy pictures
 card to memory, 25
 memory to card, 25
 to computer via USB cable, 43
cropping pictures, 18, 19
customer support, 61
customizing camera settings, 32

D

date setting, 3
date stamp, 34
DC-in, i
delete button, ii
deleting
 during quickview, 5
 from internal memory, 17
 from SD/MMC card, 17
 protecting pictures, videos, 17
digital zoom, 33
digital zoom, using, 7
displaying slide show, 20
disposal, recycling, 69
dock
 connector, ii
 printer, 45
downloading pictures, 43

E

EasyShare software, 43
emailing pictures, videos, 38
expected battery life, 68
exposure

compensation, 35
 long time, 31
 metering, 30
external video device
 viewing pictures, videos, 22

F

favorites
 removing, 40
 settings, 40
 tagging, 39
favorites button, i
FCC compliance, 71
fireworks, 12
firmware, upgrading, 69
flash, i, ii
flash button, i
flower, 12, 13
focus
 framing marks, 6
 zone, 31
format, 35
framing grid, 36

G

grid, framing, 36
guidelines, battery, 68

H

help
 Web links, 60
histogram, 36

I

icon

- blur, 27
- icons, modes, 10
- Image stabilizer, 31
- image storage, 32
- information
 - about pictures, videos, 24
- installing
 - batteries, 1
 - SD/MMC card, 4
 - software, 43
- internal memory capacity, 66
- ISO speed, 30

K

- Kodak EasyShare software
 - installing, 43
 - upgrading, 69
- Kodak Perfect Touch technology, 18
- Kodak Web sites, 60

L

- language, 34
- LCD
 - brightness, 33
 - dimmer, 33
 - reviewing pictures, 16
 - reviewing videos, 16
- LCD/Info button, ii
- lens
 - cleaning lens, 69
- lenses, i
- light sensor, i
- loading
 - batteries, 1

- SD/MMC card, 4
 - software, 43
- long time exposure, 31

M

- Mac OS, installing software, 43
- Macro/Landscape button, ii
- maintenance, camera, 69
- manner, 12
- memory
 - inserting card, 4
 - storage capacities, 66
- menu button, ii
- microphone, i
- modes, 10
 - auto, 10
 - backlight, 13
 - beach, 12
 - children, 12
 - fireworks, 12
 - flower, 12, 13
 - manner, 12
 - night landscape, 12
 - night portrait, 11
 - party, 12
 - Scene, 10
 - self-portrait, 12
 - snow, 12
 - text, 12

N

- night landscape, 12
- night portrait, 11

O

OK button, ii
On/Off button, i
online prints, ordering, 47
optical zoom, 7
orientation sensor, 34

P

panoramic pictures, 14
party, 12
Perfect Touch technology, 18
PictBridge enabled printer, 45
picture quality, 28, 29
pictures
 checking settings, 26
 copying, 25
 cropping, 18, 19
 deleting, 17
 emailing tagged, 38
 Kodak Perfect Touch, 18
 printing, 47
 printing tagged, 37
 protecting, 17
 reviewing, 16
 storage capacity, 66
 tagging, 42
 taking, modes, 10
 transfer via USB cable, 43
power
 camera, 3
 power off, 33
 printer dock, 45
 printing
 from a card, 47

 from computer, 47
 optimizing printer, 60
 order online, 47
 PictBridge, 45
 tagged pictures, 47
 with EasyShare printer dock, 45
protecting pictures, videos, 17

Q

quickview, using, 5

R

ready light, ii, 5
recycling, disposal, 69
regulatory information, 71
removing favorites, 40
repair, 60
review button, ii, 16
reviewing pictures
 as you take them, 5
 deleting, 17
 LCD, 16
 protecting, 17
 slide show, 20
reviewing videos
 deleting, 17
 LCD, 16
 protecting, 17
 slide show, 20
running slide show, 20

S

safety, batteries, 67
Scene, 10
scene button, ii

- scene modes
 - panorama, 14
- SD/MMC card
 - inserting, 4
 - printing from, 47
 - slot, ii
 - storage capacities, 66
- self-portrait, 12
- self-timer, 28
 - with pictures, 8
- service and support telephone numbers, 61
- setting
 - auto picture rotation, 34
 - auto power off, 33
 - auto-focus, 31
 - Bluetooth, 33
 - blur warning, 34
 - camera sounds, 32, 48
 - color mode, 30
 - date and time, 3
 - date stamp, 34
 - digital zoom, 33
 - exposure metering, 30
 - focus zone, 31
 - image storage, 32
 - ISO, 30
 - language, 34
 - LCD brightness, 33
 - LCD dimmer, 33
 - long time exposure, 31
 - orientation sensor, 34
 - picture quality, 28, 29
 - picture-taking mode, 10
 - self-timer, 8, 28
 - sharpness, 30
 - sound volume, 32
 - video date display, 34
 - video out, 33
 - white balance, 29
- setting, album, 31
- setup mode, using, 32
- shaking hand, 27
- share button, ii
- sharpness, 30
- shutter
 - self-timer delay, 8
- shutter button, i
- shutter problems, 56
- slide show
 - continuous loop, 21
 - problems, 57
 - running, 20
- snow, 12
- software
 - installing, 43
 - upgrading, 69
- sound volume, 32
- sounds, 32, 48
- speaker, ii
- specifications, camera, 62
- status
 - blur warning, 27
- storage capacity, 66
- strap, 1
- support, technical, 61

T

tagging
 favorites, 39
 for albums, 42
 for email, 38
 for print, 37
telephone support, 61
television, slide show, 22
text, 12
time, setting, 3
timer, shutter delay, 8
tips
 battery guidelines, 68
 care & maintenance, 69
transfer, via USB cable, 43
trash can, deleting, 5
tripod socket, ii
turning camera on and off, 3

U

undelete, 17
undo, 17
upgrading software, firmware, 69
URLs, Kodak Web sites, 60
USB
 transferring pictures, 43

V

VCCI compliance, 72
video
 action print, 20
 checking settings, 26
 copying, 25
 date display, 34

deleting, 17
emailing tagged, 38
out, 33
protecting, 17
reviewing, 16
storage capacities, 66
transfer to computer, 43
viewing, 16
video mode button, i
video/self-timer light, i
viewing
 by date, album, 24
viewing picture
 after taking, 5, 16
viewing picture, video information, 24
volume, 32

W

warranty, 69
white balance, 29
wide angle button, ii
Windows OS, installing software, 43

Z

zoom
 digital, 7
 optical, 7

Free Manuals Download Website

<http://myh66.com>

<http://usermanuals.us>

<http://www.somanuals.com>

<http://www.4manuals.cc>

<http://www.manual-lib.com>

<http://www.404manual.com>

<http://www.luxmanual.com>

<http://aubethermostatmanual.com>

Golf course search by state

<http://golfingnear.com>

Email search by domain

<http://emailbydomain.com>

Auto manuals search

<http://auto.somanuals.com>

TV manuals search

<http://tv.somanuals.com>