

# WS-1913U-IT WEATHER CENTER

## Instruction Manual

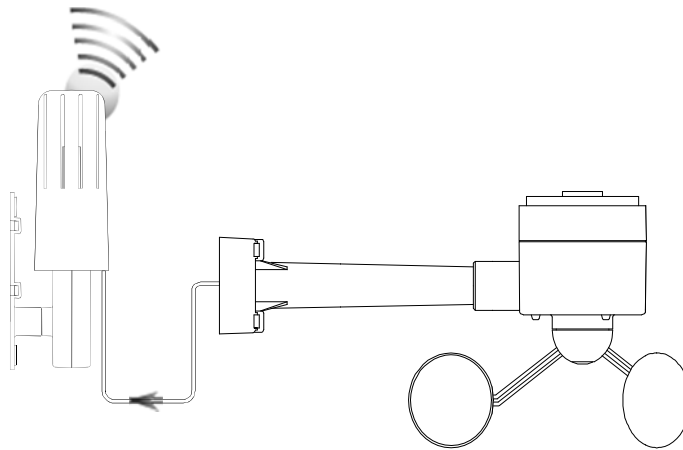
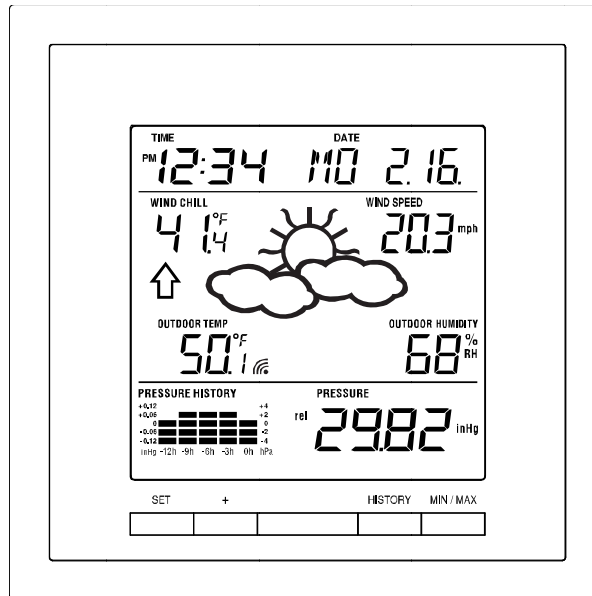

Congratulations on purchasing this state-of-the-art weather station as an example of excellent design and innovative measuring technique. Featuring time, date, calendar, weather forecast, wind gust and wind speed, indoor/outdoor temperature and outdoor humidity, air pressure and rainfall (optional), this weather station will provide you with various weather information and weather forecast. Pages after pages, you will discover that the operation of your weather station is simple!

This product offers:



**INSTANT TRANSMISSION** is the state-of-the-art new wireless transmission technology, exclusively designed and developed by LA CROSSE TECHNOLOGY. **INSTANT TRANSMISSION** offers you an immediate update (every 4.5 seconds!) (6.25 seconds for rain sensor - optional) of all your outdoor data measured from the transmitters: follow your climatic variations in real-time!

## INVENTORY OF CONTENTS

1. Wireless Weather Station WS-1913U-IT
2. Wireless Thermo-hygro Sensor (TX31U-IT) and Wind Sensor (TX55U-IT) with mounting bracket.
3. Instruction Manual

## FEATURES:

### The Weather Station

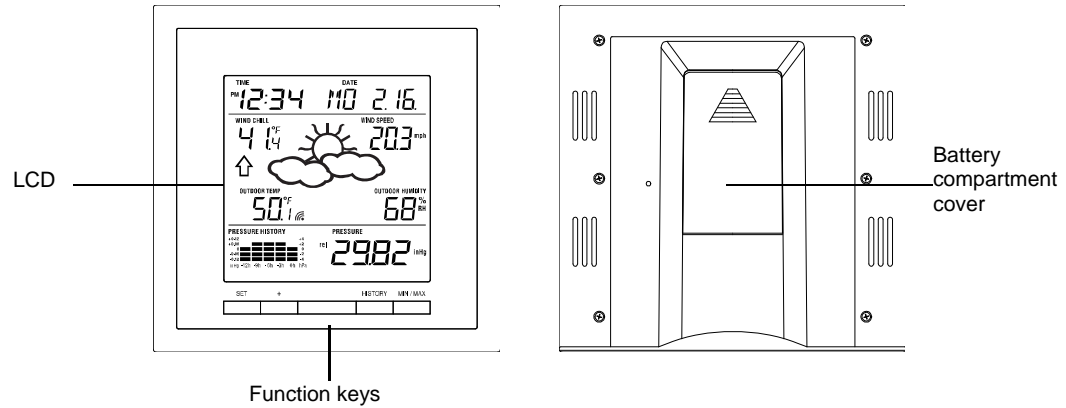

- Time display (manual setting)
- 12/24 hour time display
- Calendar display (weekday, date, month)
- Weather forecast icons and weather tendency indicator
- Indoor temperature display in °C/°F
- Outdoor temperature display in °C/°F
- Outdoor Humidity display as RH%
- Dew point displayed in °C or °F
- Wind chill displayed in °C or °F
- Wind gust displayed in km/h, mph or m/s
- Wind speed displayed in km/h, mph or m/s
- 24-hour and total rainfall displayed in mm or inch (optional)
- Display MIN/MAX value of outdoor temperature, outdoor humidity, dew point, wind chill, and relative air pressure, with time & date of recording
- Display MAX wind speed and gust with time & date of recording
- Relative air pressure displayed in hPa or inHg
- Air pressure tendency indicator for the past 12 hour (bar graph format)
- Manual reset of outdoor temperature/ humidity, pressure and wind chill data
- LCD contrast selectable
- Low battery indicator
- Storage of 140 sets of history weather data recorded in 3-hour intervals
- Wireless transmission at 915 MHz
- Transmission range up to 330 feet/100 meters

### The Thermo-hygro Transmitter

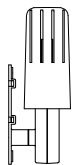

- Remote transmission of the outdoor temperature and humidity to the Weather Center at 915 MHz (open air)
- Rain resistant casing
- Wall mounting case (to be mounted vertically in a sheltered place. Avoid direct rain and sunshine)

### The Wind sensor

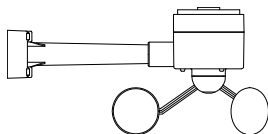

- Connected to the thermo-hygro transmitter by cable
- Can be installed onto a mast or a horizontal panel (with the cups on the bottom)

### The TX32U-IT rain sensor (optional- sold separately)



- Remote transmission of the rainfall data to the Weather Center at 915 MHz
- To be mounted onto a horizontal panel

### SET UP:

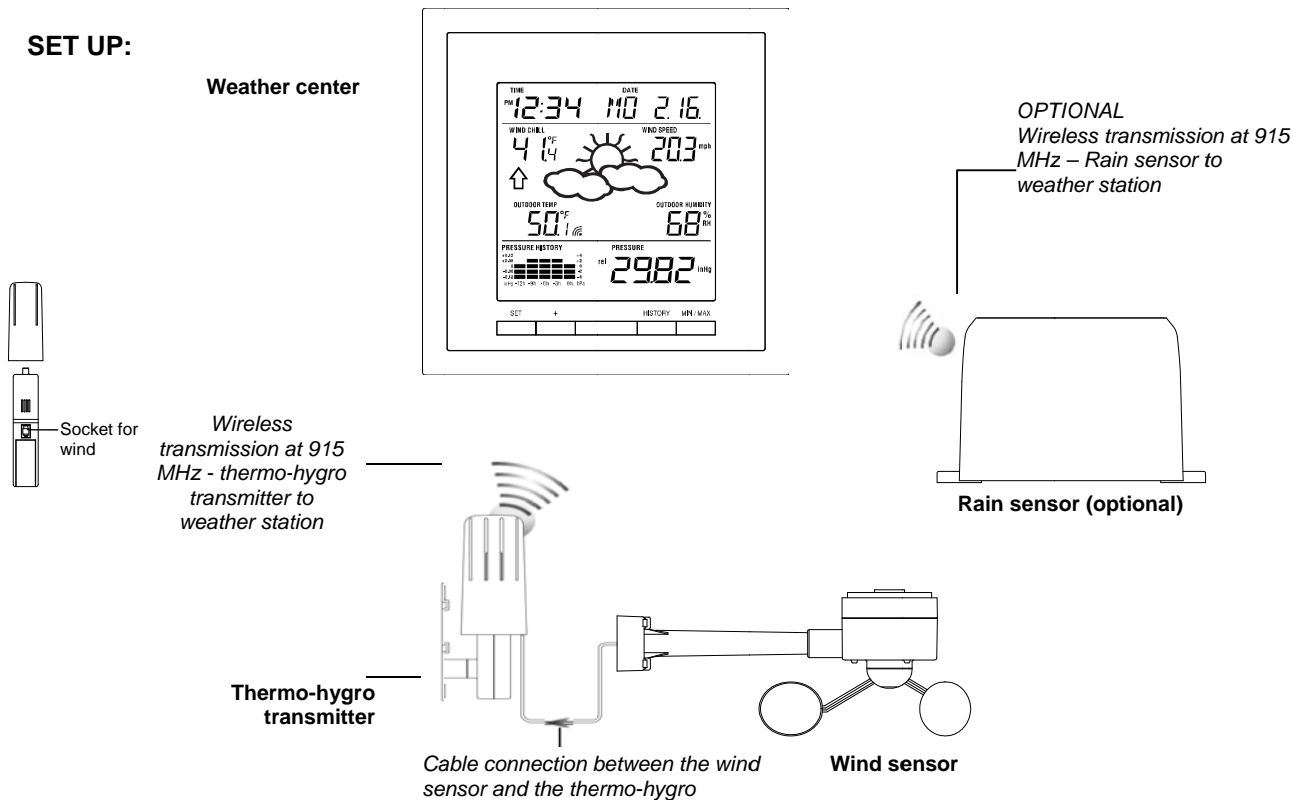

### IMPORTANT:

- Do Not Mix Old and New Batteries
- Do Not Mix Alkaline, Standard, or Rechargeable Batteries

### NOTE:

When first operating the Weather Station, it is important to completely set-up the wiring and the rest of the system in close proximity (e.g. on a table 5ft-10ft from display) and test all components for correct function before mounting them at their final destinations (See Positioning below) (Allow all sensors to sit with the display unit for 15 minutes before mounting)

1. First, unwind the cables of the Wind sensor. Connect the Wind sensor to the Thermo-hygro transmitter by plugging the connector head into the socket of the Thermo-hygro sensor. Be sure the cord "clicks" into place.
2. Next, insert the batteries into the Thermo-hygro sensor and Rain sensor (optional - purchased separately) See "**How to install and replace the batteries into the Thermo-hygro sensor**" and "**How to install and replace the batteries into the Rain sensor (optional)**" below.
3. Then insert the batteries into the Weather Center (See "**How to install and replace the batteries into the Weather Center**" below). Once the batteries are installed, all segments of the LCD will light up briefly. It will then display the time as 12:00, the date as 1.1.09, the weather icons, and air pressure value. "- - -" will be shown for outdoor data.
4. The Weather Center will start receiving data from the transmitter. The transmission reception icon will be blinking to indicate that the station is trying to get the thermo-hygro transmitter data. The outdoor temperature, humidity, wind data will be displayed on the Weather Center. If this does not happen after 135 seconds, remove the batteries from all units. You will have to start again from step 2.
5. The transmitter reception icon is now blinking again to indicate that the station is trying to get the rain sensor data. It will stop blinking once the rain sensor has been detected. If this does not happen after 135 seconds, you will need to start again from step 2. (optional rain gauge).

6. Check the cable for correct connection and test all the components for correct functionality by manually turning the wind-gauge; tilting the optional rain sensor to hear the impact of the internal moving seesaw, etc. (See **Positioning** below).
7. Time and date must be manually set (See **Manual Setting** below).
8. After the Weather Center has been tested and found fit, the initial set up of the weather station system is finished and the mounting of the system components can take place. Ensure that all components work properly together at their chosen mounting or standing locations before permanent mounting.

For example, if there appears to be problems with the 915 MHz radio transmissions, they can often be overcome by slightly changing the mounting locations or turning the base station.

**NOTE:**

The radio communication between the receiver and the transmitters in the open field reaches distances of up to 330 feet/ 100 meters, provided there are no interfering obstacles such as buildings, trees, vehicles, high voltage lines, etc.

9. Radio interferences created by cordless phones, PC screens; radios or TV sets can in some cases entirely cut off radio communication. Please consider this when choosing standing or mounting locations.

**NOTE:**

- After batteries are installed in the transmitter, install the batteries in the weather center to receive the signal from the transmitters as soon as possible. If the weather center is powered more than 5 hours after the transmitter is powered, the weather center will never receive signal successfully from the transmitters. In this case, you will need to reinstall the batteries from all the transmitters to redo set-up procedure.
- After batteries are installed, there will be synchronization between Weather Center and the transmitters. At this time, the signal reception icon ☼ will be blinking. When the signal is successfully received by the Weather Center, the ☼ icon will be switched on (If it is not successful, the ☼ icon will not be shown).
- The short blinking of the icon shows that a reception is in progress.

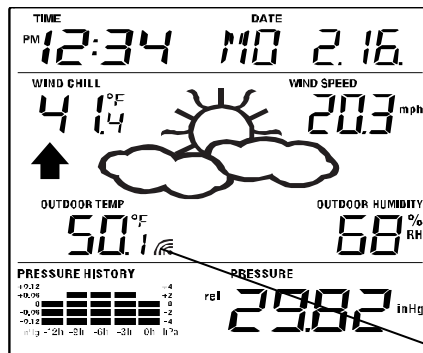

Transmitter signal reception icon

- If the signal reception is not successful on the first frequency (915MHz) for 45 seconds, the frequency is changed to 920MHz and the learning is tried another 45 seconds. If still not successful, the reception is tried for 45 seconds on 910MHz. This will also be done for re-synchronization.

**HOW TO INSTALL AND REPLACE THE BATTERIES INTO THE THERMO-HYGRO TRANSMITTER**

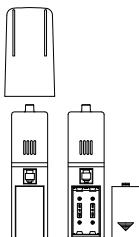

The outdoor Thermo-hygro transmitter works with 2 x AA IEC LR6, 1.5V batteries. To install and replace the batteries, please follow the steps below:

1. Remove the airflow cover of the transmitter.
2. Remove the battery compartment cover.
3. Insert the batteries, observing the correct polarity (see the marking in the battery compartment).
4. Replace the battery cover and the airflow cover onto the unit.

### NOTE:

When changing batteries in any of the units, all units need to be reset by following the setting up procedures. This is because the thermo-hygro sensor at start-up assigns a random security code and this code must be received and stored by the Weather Center in the first several minutes of power being supplied to it.

### HOW TO INSTALL AND REPLACE THE BATTERIES INTO THE WEATHER STATION

The Weather Station works with 2 x C, IEC LR14 1.5V batteries. When the batteries need to be replaced, the low battery symbol will appear on the LCD.

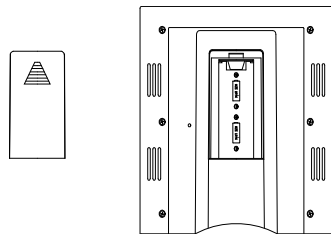

To install and replace the batteries, please follow the steps below:

1. Remove the battery compartment cover.
2. Insert the batteries observing the correct polarity (see the marking in the battery compartment).
3. Replace the battery cover.

### HOW TO INSTALL AND REPLACE BATTERIES INTO THE RAIN SENSOR (OPTIONAL; SOLD SEPERATELY)

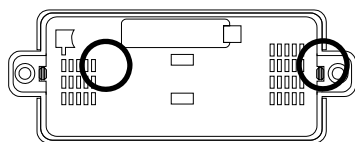

Figure 1

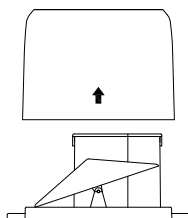

Figure 2

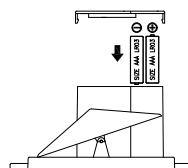

Figure 3

1. Unlock the main cover from the rain sensor base and remove the cover.
2. Remove the battery cover at the top of the rain sensor.
3. Insert 2 x AAA IEC LR3 1.5V batteries into the battery compartment, observing the correct polarity.
4. Replace the battery cover and the main cover on the unit.

### NOTE:

When changing batteries in any of the units, all units need to be reset by following the setting up procedures. This is because the transmitter and rain sensor (optional) assign a random security code at start-up and these codes must be received and stored by the Weather Station in the first 90 seconds of power being supplied to it.

### BATTERY CHANGE:

It is recommended to replace the batteries in all units regularly to ensure optimum accuracy of these units. (For battery life information, see the Specifications section)



**Please participate in the preservation of the environment. Return used batteries to an authorised depot.**

**- Do Not Mix Old and New Batteries**

**- Do Not Mix Alkaline, Standard, or Rechargeable Batteries**

### NOTE:

The stored History record is lost when a battery change is completed on the weather station.

### FUNCTION KEYS:

#### Weather Station:

The Weather Station has 4 easy-to-use function keys.



## SET key

- Press and hold to enter manual setting modes: LCD contrast, Manual time setting, 12/24 hour time display, Calendar setting, °C/ °F temperature unit, Wind speed unit, Rainfall unit, Pressure unit, Relative pressure reference setting, Weather tendency threshold, Storm threshold setting
- Press to toggle between Mode 1 and Mode 2:
  - Mode1: "Wind speed + outdoor temp + rel. pressure"
  - Mode 2: "Gust + Dew Point temp + rainfall data (only if there is a rain sensor- optional)" (Mode 2 is shown for 30 seconds. Then it returns to the normal display)
- Press to activate the reset mode when MAX or MIN record is shown

## + key

- In display Mode 1, press to toggle between the display of date, weekday + date, Indoor temp, or second
- In display Mode 2, press to toggle between the display of Relative Pressure, 24 hour rainfall and Total rainfall (only if there is a rain sensor- optional).
- Press to adjust (increase) the level of different settings
- Press to confirm to reset the MIN/MAX record

## HISTORY key

- Press to display the weather data history records
- Press to exit manual setting mode

## MIN/MAX key

- Press to display MIN/MAX records of various weather data
- Press to adjust (decrease) the level of different settings

## LCD SCREEN

The LCD screen is split into 3 sections displaying the following information:

1. Time and date/ indoor temp/ second
2. Wind data, outdoor temperature and humidity, dew point, weather forecast icon and tendency indicator
3. Air pressure history, relative air pressure, rainfall data (optional)

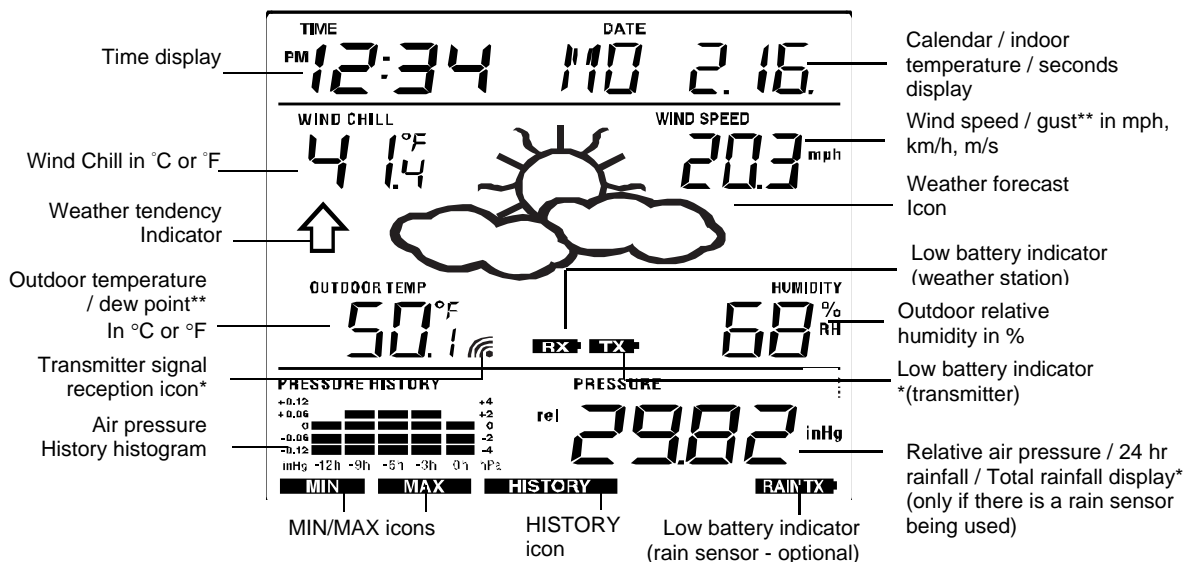

\* When the signal from the transmitter/ or rain sensor (optional) is successfully received by the Weather Station, this icon will be switched on. (If not successful, the icon will not be shown on the LCD). User can therefore easily see whether the last reception was successful ("ON" icon) or not ("OFF" icon). On the other hand, the short blinking of the icon shows that a reception is being done at that time.

\*\* In normal display mode, user may press the SET key to toggle between Mode1 and Mode 2 display:  
**Mode 1:** Wind speed, outdoor temperature, relative air pressure are shown.

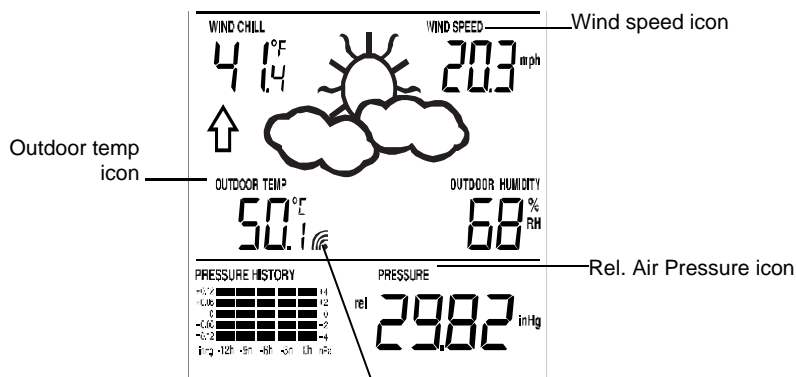

In Mode 1, this reception icon is showing the condition of the reception of the signal from Thermo-hygro transmitter

**Mode 2:** Wind gust, dew point, and rainfall (optional) reading are shown.

**Note:** To view the rainfall data, press the + key after entering Mode 2 display.

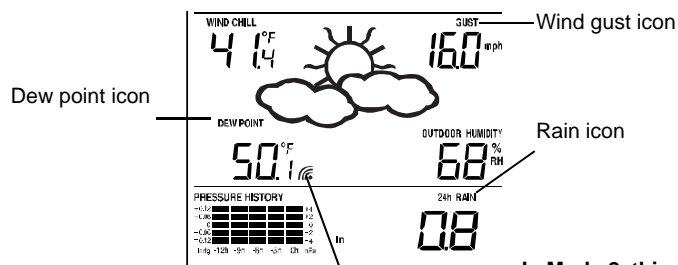

In Mode 2, this reception icon is showing the condition of the reception of the signal from Rain sensor (only if a rain sensor is being used).

**Note:** if no rain sensor is used, the reception icon will always be displayed in Mode 2.

### MANUAL SETTINGS:

The following manual settings can be changed once the SET key is pressed and held for about 3 seconds:

- LCD contrast setting
- Manual time setting
- 12/24 hour time display
- Calendar setting
- °C/ °F temperature unit setting
- Wind speed unit
- Rainfall unit setting
- Air pressure unit setting
- Relative pressure reference value setting
- Weather tendency threshold value
- Storm warning threshold value

### LCD CONTRAST SETTING

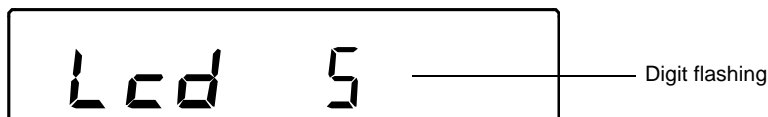

The LCD contrast has 8 levels, from "LCD 1" to "LCD8" (default setting is LCD 5):

1. Press the SET key, the contrast level digit will flash.
2. Use the + or MIN/MAX key to adjust the level of contrast.
3. Confirm with the SET key and enter the **MANUAL TIME SETTING**.

### MANUAL TIME SETTING:

You then may manually set the time by following the steps below:

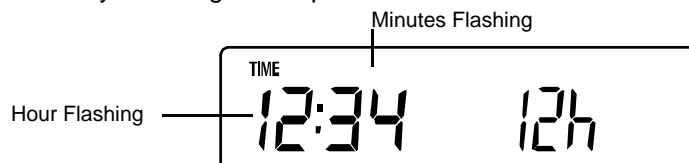

1. The hour digit will flash.
2. Use the + or MIN/MAX key to set the hour.
3. Press the SET key to switch to the minutes. The minute digit will flash.
4. Use the + or MIN/MAX key to set the minutes (holding of the key will forward the digit by 5).
5. Confirm the time with the SET key and enter the **12/24-HOUR TIME DISPLAY SETTING**.

### 12/24 HOUR TIME DISPLAY SETTING:

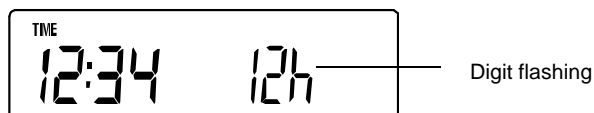

The time can be set to view as 12-hour or 24-hour format. The default time display mode is "12h". To set to "24h" time display:

1. Use the + or MIN/MAX key to toggle the value.
2. Confirm with the SET key and enter the **CALENDAR SETTING**.

### CALENDAR SETTING:

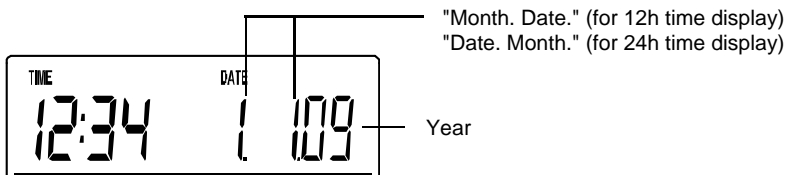

The date default of the Weather Station is 1. 1. of year 2009. The date can be set manually by proceeding as follows.

1. The year digit will flash.
2. Use the + or MIN/MAX key to set the year (pressing and holding the key will forward the digit by 5). The range runs from "00" (2000) to "99" (2099).
3. Press the SET key to confirm the year and enter the month setting. The month digit will flash.
4. Use the + or MIN/MAX key to set the month.
5. Press the SET key to confirm the month and enter the date setting mode. The date digit will flash.
6. Use the + or MIN/MAX key to set the date.
7. Confirm all calendar settings with the SET key and enter the **°C/°F TEMPERATURE UNIT SETTING**.

### °C/°F TEMPERATURE UNIT SETTING

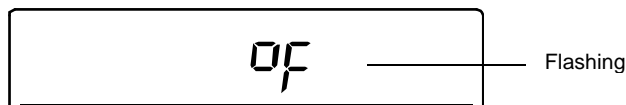

The temperature display can be selected to show temperature data in °F or °C. (Default °F)

1. The temperature unit is flashing
2. Use the + or MIN/MAX key to toggle between "°F" or "°C".
3. Confirm with the SET key and enter the **WIND SPEED UNIT SETTING**

### WIND SPEED UNIT SETTING

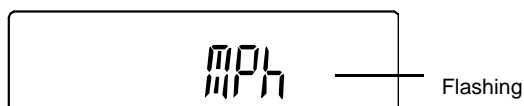



The wind speed unit can be set as mph (mile per hour), km/h (Kilometer per hour), or m/s (meter per second). The default unit is mph.

1. Use the + or MIN/MAX key to toggle between the unit "mph", "km/h", or "m/s"
2. Confirm with the SET key and enter the **RAINFALL UNIT SETTING**.

### RAINFALL UNIT SETTING (OPTIONAL)

Note: the rain unit setting is only available if there is a rain sensor. Skip this setting by pressing the SET key again to enter the Relative Air Pressure Unit Setting.



The total rainfall unit can be set as inch or mm. The default unit is inch.

1. Use the + or MIN/MAX key to toggle between the unit "mm" or "Inch"
2. Confirm the unit with the SET key and enter the **RELATIVE AIR PRESSURE UNIT SETTING**

### RELATIVE AIR PRESSURE UNIT SETTING



The relative air pressure can be set as hPa or inHg. The default unit is inHg.

1. Use the + or MIN/MAX key to toggle between the unit "hPa" or "inHg"
2. Confirm the unit with the SET key and enter the **RELATIVE PRESSURE REFERENCE VALUE SETTING**.

### RELATIVE PRESSURE REFERENCE VALUE SETTING

#### NOTE:

The default reference pressure value of the barometer is 29.91inHg (1013 hPa) when batteries are first inserted. **For an exact measurement, it is necessary to first adjust the barometer to your local relative air pressure (related to elevation above sea level).** Ask for the current atmospheric pressure of your home area (Local weather service, www, calibrated instruments in public buildings, airport).

The relative air pressure can be manually set to another value within the range of 27.14 to 31.90 inHg (919 to 1080 hPa) for a better reference.



1. The current relative pressure value will flash.
2. Use the + or MIN/MAX key to increase or decrease the value. Keep holding the key will allow the value to increase faster.
3. Confirm with the SET key and enter the **WEATHER TENDENCY THRESHOLD VALUE SETTING**.

#### NOTE:

This calibration facility is useful for those users living at various elevations above sea level, but wanting their air pressure display to be based on sea level elevation.

### WEATHER TENDENCY THRESHOLD VALUE SETTING

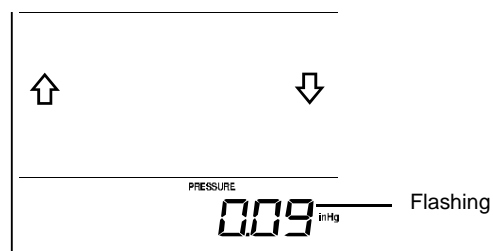

You may select a definite switching sensitivity value, .06, .09, or .12 inHg (2-4 hPa) for the change in the display of weather icons. This represents the "sensitivity" of the weather forecast (the smaller the value selected, the more sensitive the weather forecast). The default value is 0.09 inHg (3 hPa).

1. The threshold value will flash.
2. Use the + or MIN/MAX key to select the value.
3. Confirm with the SET key and enter the **STORM WARNING THRESHOLD VALUE SETTING**.

#### STORM WARNING THRESHOLD VALUE SETTING

You may also define a switching sensitivity value for the Storm warning display at a decrease of air pressure from .09 inHg to .27 inHg (3-9 hPa) over 6 hours (Default 0.15 inHg (5 hPa)).

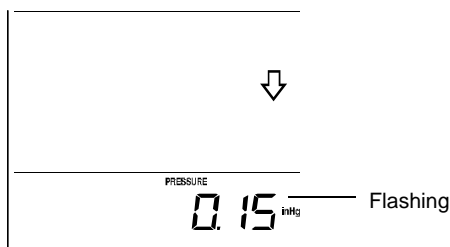

1. The threshold value will flash.
2. Use the + or MIN/MAX key to select the value.
3. Confirm with the SET key and enter the **STORM ALARM ON/ OFF SETTING**.

#### STORM ALARM ON/ OFF SETTING

**Note: the storm alarm ON/OFF setting is not available on this model. Skip and exit this setting by pressing the SET key.**

#### TO EXIT THE MANUAL SETTING MODE

To exit the manual setting anytime during the manual setting modes, press the HISTORY key anytime or wait for the automatic timeout. The mode will return to the normal time display.

**STORM WARNING ICON:** When the storm-warning threshold is reached, you will see the cloud with rain icon and the down arrow will flash. There is not an audible alarm.



#### WEATHER FORECAST AND WEATHER TENDENCY

##### WEATHER FORECASTING ICONS

Weather icons in the third section of LCD can be displayed in any of the following combinations:



Sunny



Cloudy with sunny intervals



Rainy

For every sudden or significant change in the air pressure, the weather icons will update accordingly to represent the change in weather. If the icons do not change, then it means either the air pressure has not changed or the change has been too slow for the Weather station to register. However, if the icon displayed is a sun or raining cloud, there will be no change of icon if the weather gets any better (with sunny icon) or worse (with rainy icon) since the icons are already at their extremes.

The icons displayed forecasts the weather in terms of getting better or worse and not necessarily sunny or rainy as each icon indicates. For example, if the current weather is cloudy and the rainy icon is displayed, it does not mean that the product is faulty because it is not raining. It simply means that the air pressure has dropped and the weather is expected to get worse but not necessarily rainy.

**NOTE:**

After set up, readings for weather forecasts should be disregarded for the next 48-60 hours. This will allow sufficient time for the Weather station to collect air pressure data at a constant altitude and therefore result in a more accurate forecast.

Common to weather forecasting, absolute accuracy cannot be guaranteed. The weather forecasting feature is estimated to have an accuracy level of about 75% due to the varying areas the Weather station has been designed for use. In areas that experience sudden changes in weather (for example from sunny to rain), the Weather station will be more accurate compared to use in areas where the weather is stagnant most of the time (for example mostly sunny).

If the Weather station is moved to another location significantly higher or lower than its initial standing point (for example from the ground floor to the upper floors of a house), discard the weather forecast for the next 48-60 hours. By doing this, the Weather Station will not mistake the new location as being a possible change in air-pressure when really it is due to the slight change of altitude.

**WEATHER TENDENCY INDICATOR**

Working together with the weather icons is the weather tendency indicators (located on the left and right sides of the weather icons). When the indicator points upwards, it means that the air-pressure is increasing and the weather is expected to improve, but when indicator points downwards, the air-pressure is dropping and the weather is expected to become worse.

Taking this into account, one can see how the weather has changed and is expected to change. For example, if the indicator is pointing downwards together with cloud and sun icons, then the last noticeable change in the weather was when it was sunny (the sun icon only). Therefore, the next change in the weather will be cloud with rain icons since the indicator is pointing downwards.

**NOTE:**

Once the weather tendency indicator has registered a change in air pressure, it will remain permanently visualized on the LCD.

**AIR PRESSURE HISTORY (ELECTRONIC BAROMETER WITH BAROMETRIC PRESSURE TREND)**

The bottom section of the LCD also shows the relative air pressure value and the air pressure history.

The bar graph of the electronic barometer shows the air pressure history of the past 12 hours in five 3-hour steps.



The horizontal axis represents the last 12 hours air pressure recording (-12, -9, -6, -3 and 0 hour). The bars are plotted at each of the 5 steps and give the trend over the recorded period. The scale on the right compares the result. The "0" in the middle of this scale determines the current air pressure.

The vertical axis represents the air pressure changes in inHg (+0.12, +0.06, 0, -0.06, -0.12. The "0" represents the current air pressure). The newly measured pressure was compared to the previously recorded pressure reading. The pressure change is expressed by the difference between the current ("0h") and the past readings in division of  $\pm 2$  hPa or  $\pm 0.06$  inHg. If the bars are rising it indicates that the weather is getting better due to an increase in air pressure. If the bars go down it indicates a drop of the air pressure and the weather is expected to get worse from the present time "0".

At every full hour, the current air pressure is used as a basis for the display of a new graph bar. The existing graph is then moved one column to the left.

### NOTE:

For accurate barometric pressure trend, the Weather Center should operate at the same altitude. For example, it should not be moved. Should the unit be moved, for instance from the ground to the second floor of the house, the readings for the next 48-60 hours shall be discarded..

### WIND SPEED MEASUREMENT

In normal display mode, the second section of the LCD shows the following wind data.

- Wind chill in °F or °C
- Wind Speed in km/h, mph or m/s
- Gust in km/h, mph or m/s (displayed when in Mode 2, by pressing the SET key shortly)

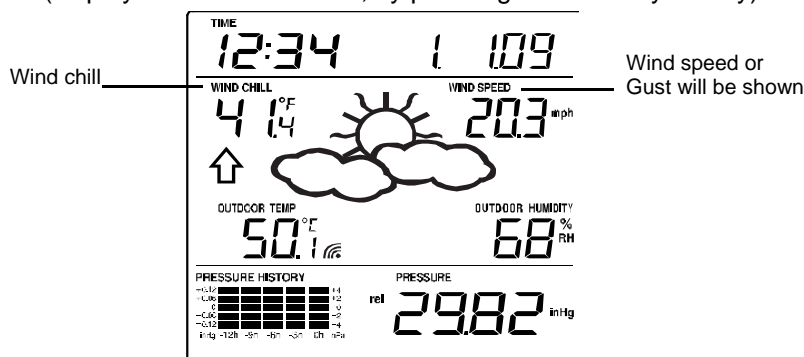

### RAINFALL MEASUREMENT (OPTIONAL)

The total rainfall and 24 hour rainfall measurement is displayed in the last section of the LCD (where pressure is normally displayed), in the unit of mm or inch.

**To View the 24-hour rainfall or the Total rainfall reading:**

1. In normal display, press SET key once and the display will shift to Mode 2.
2. Press + key consecutively key to toggle between the 24-hour rainfall, Total rainfall and Rel. pressure reading.

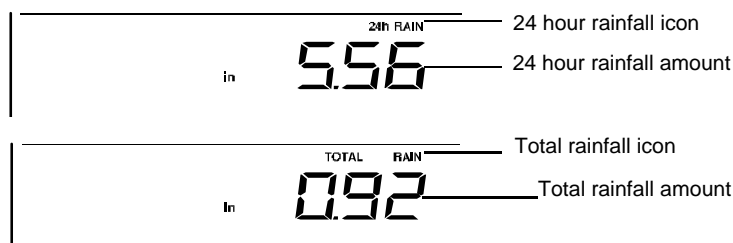

### VIEW THE HISTORY DATA

The weather station can store up to 140 sets of weather data which are recorded automatically at 3-hour intervals after the weather station is powered up, at the nearest time of 0:00, 03:00, 06:00, 09:00, 12:00, 15:00, 18:00 and 21:00. For instance, if user has manually set the time as 14:52 after installing batteries, the first history record will be made at the coming 15:00 automatically. Then the second record will be on 18:00 and so on.

Each weather record includes the Wind direction, Wind speed/ gust, Wind chill temperature, wind speed/gust, dew point, Outdoor temp and humidity, relative pressure, 24-hour rainfall and total rainfall, pressure history and weather tendency. Also, the time and date of recording will be displayed.

### NOTE:

In order to acquire the correct time of recording of the history records, you shall manually set the current time as soon as installing batteries to the weather station. Afterwards, you should avoid changing the pre-set time as it will also alter the recorded "time of recording" of each history record, which may lead to confusion.

**To view the weather history:**

1. In normal display, press the HISTORY key. The latest weather record will be shown with the date and time of recording. The "HISTORY" icon will be displayed at the bottom of the LCD.
2. When viewing History records, user may shift to see the Mode 1 or Mode 2 data by pressing the SET key.

**Mode 1:** with wind speed + outdoor Temp + Rel. pressure;

**Mode 2:** with wind gust + Dew point + rainfall data (optional)

**NOTE:** To view total rainfall or 24-hour rainfall in history records, first, in normal display mode, choose to show the particular rainfall data, then press the History key followed by the SET key to view the particular rainfall data in History records. (rain data information only available if a rain sensor is being used-optional).

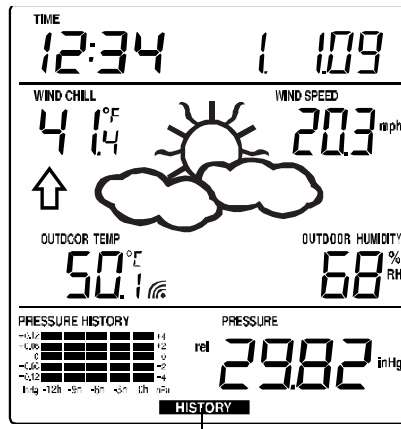

HISTORY icon

- When viewing History records, press MIN/ MAX to view older records. (Press MIN/MAX and + key to view "Previous" and "Next" record respectively. The records are made at 3-hour intervals)

**NOTE:**

- The stored history records will be lost after battery change or whenever battery is removed.
- The total rainfall value will be exhibited in whole number (no decimal place) in the history record.

**VIEW THE MAXIMUM/MINIMUM WEATHER DATA**

The weather station will record the minimum and maximum value of the various weather data with time and date of recording automatically. The following stored maximum and minimum weather data can be viewed by pressing the MIN/MAX key in normal display mode.

**1. MIN outdoor temperature with the date and time of recording**

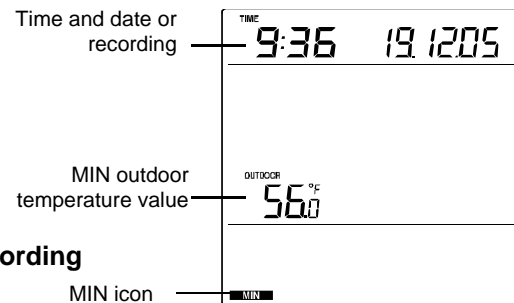

**2. MAX outdoor temperature with the date and time of recording**

**3. MIN dew point temperature**

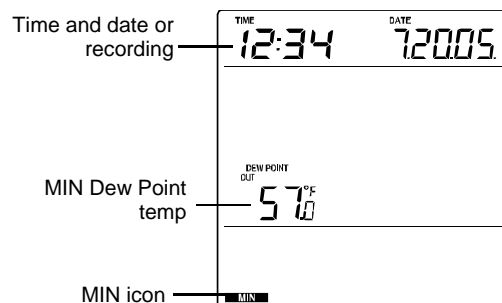

4. MAX dew point temperature

5. MIN outdoor humidity with the date and time of recording

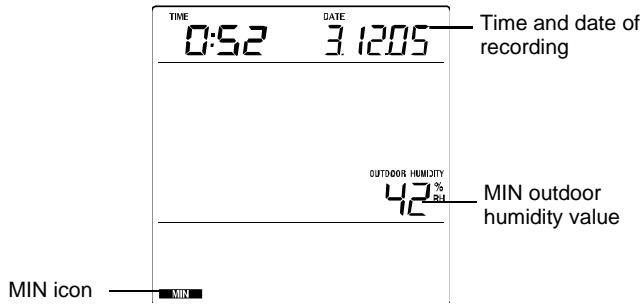

6. MAX outdoor humidity with the date and time of recording

7. MIN Wind chill temperature with the date and time of recording

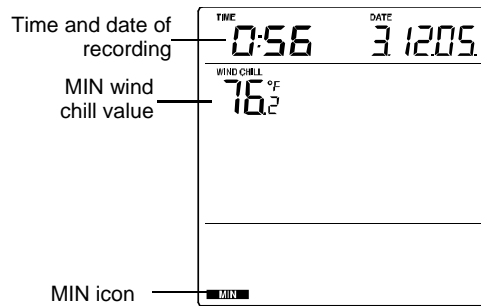

8. MAX Wind chill temperature with the date and time of recording

9. MIN Relative pressure with the date and time of recording

10. MAX Relative pressure with the date and time of recording

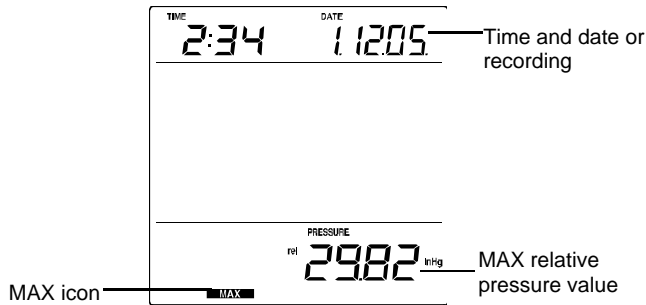

11. MAX wind speed with the date and time of recording

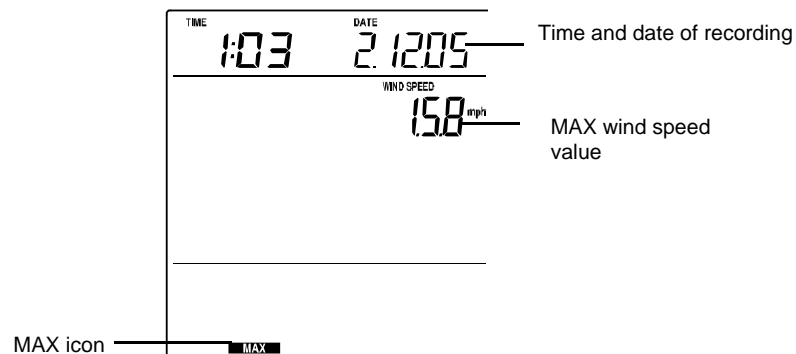

## 12. MAX Gust with the date and time of recording

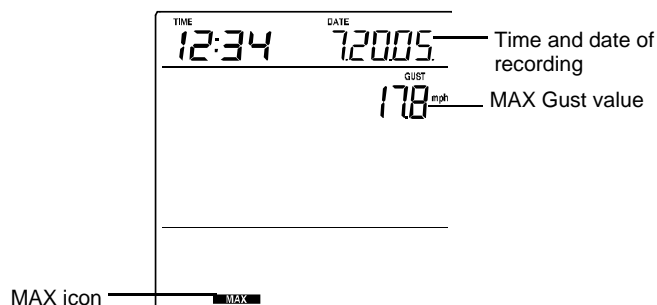

## 13. MAX 24 hour rainfall (optional) with the date and time of recording

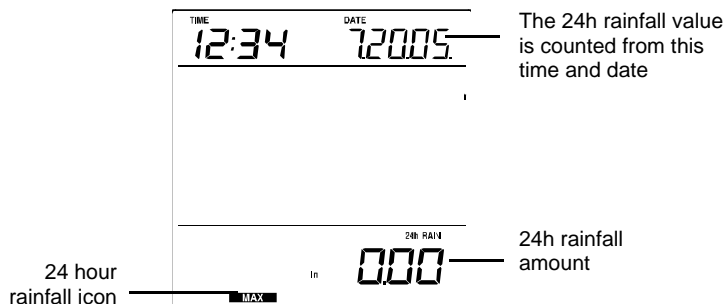

## RESET MAXIMUM AND MINIMUM WEATHER DATA

To reset the maximum or minimum weather data 1 to 13, you will need to reset each of the data independently.

1. Press MIN/MAX key to show the desired weather data. For instance, if you want to reset the minimum humidity, in the normal display you shall press the MIN/MAX key three times to show the min humidity value.
2. Press and hold the SET key for about 2 seconds, then the "RESET" icon will appear at the bottom part of the LCD.
3. Press the + key once, then the stored value will be reset to the current value and current time.
4. Press the HISTORY key to return to normal display mode.

## Total rainfall amount (optional) with the date and time of recording

The total rainfall measurement is displayed in the last section of the LCD, in the unit of mm or inch. It shows the total rainfall accumulated since last reset of the weather station.

In normal display mode, press the MIN/MAX key fourteen times to show the total rainfall value. The "RESET" icon will also be shown at the same time.

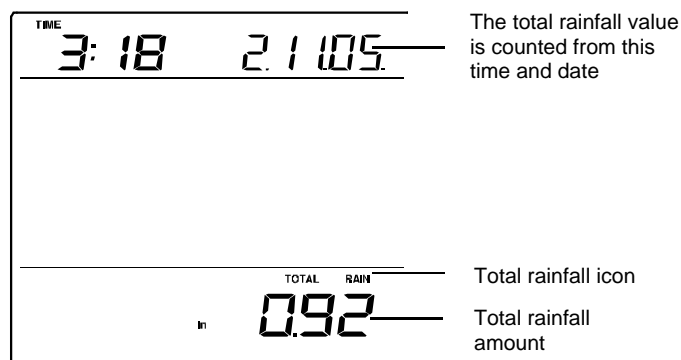

### To reset the rainfall reading:

- Press the + key once when the Rainfall value and Reset icon are shown.
- Then the total rainfall amount will be reset to 0, and the time updated to current time.

### NOTE:

After power up, the time and date and total rainfall are displayed as "- - -". After time is adjusted manually, the set time will be shown.

### LOW BATTERY INDICATOR

The low battery indicator of the weather station and the transmitter will be displayed in the second section, and the low battery icon for the rain sensor (optional) will be shown on the last section of the LCD respectively when the battery power is low. It is recommended to replace the batteries in all units on an annual basis to ensure optimum accuracy of the system.

### NOTE:

- After battery change, both the Weather Station and the transmitters need to be reset (see note "Set up")
- The History data record will be clear after the battery change.

### OUTDOOR TRANSMITTER 915 MHz RECEPTION CHECK

The outdoor temperature, humidity, wind data are transmitted from thermo-hygro transmitter every 4.5 seconds; the rainfall data are transmitted from the rain sensor (optional) every 6.25 seconds. The receiver will synchronize to the thermo-hygro transmitter and rain sensor (optional) then. The transmission range (up to about 330 feet /100 meters in open air) of the thermo-hygro transmitter/ rain sensor may be affected by the ambient temperature. At cold temperatures, the transmitting distance may decrease. Please keep this in mind when placing the transmitter and the rain sensor.

If (1) the outdoor data is not being received within first several minutes after set up; (2) the outdoor display always shows "- - -" on the outdoor display; or (3) the reception icon of thermo-hygro transmitter (Mode 1) and rain sensor (optional) (Mode 2) is not displayed on the display, check the following things:

1. The distance of the Weather Station or transmitter/ rain sensor should be at least 5 to 6.5 feet (1.5 to 2 meters) away from any interfering sources such as computer monitors or TV sets.
2. Avoid positioning the Weather Center onto or in the immediate proximity of metal doors or window frames.
3. Using other electrical products such as headphones or speakers operating on the same signal frequency (915 MHz) may prevent correct signal transmission and reception.
4. Neighbors using electrical devices operating on the 915 MHz signal frequency can also cause interference.

### NOTE:

When the 915 MHz signal is received, do not re-open the battery compartment cover of the transmitter/ rain sensor or Weather station, as the batteries may spring free from the contacts and force a false reset. Should this happen accidentally then reset all units (see **Set up** above) otherwise transmission problems may occur.

During normal operation, after the outdoor display shows "- - -", the weather station will change to receive the outdoor data every 15 minutes, until the data is read. Then the reception period for thermo-hygro transmitter will return to 4.5 seconds (6.25 seconds for rain sensor - optional).

If no reception is possible despite the observation of these factors, all system units have to be reset (see **Set up**).

### POSITIONING:

Prior to permanently mounting any of the units, please ensure the following points are considered:

- Cable lengths of the units meet with your distance requirements at the point of fixing
- Signals from the sensors can be received by the base station at points of mounting

### La Crosse Technology Sensor Extension Cable

You can purchase a La Crosse Technology Extension Cable if you require additional length to properly mount your sensor. The extension cable is 32 feet in length and comes with the appropriate connector



attached. Please visit your local retailer or [www.lacrossetechnology.com](http://www.lacrossetechnology.com) and click on the Buy button to locate an online dealer or other retailers.

Using phone cables or connections may damage your sensors because phone cables and connections have more resistance than the La Crosse Technology extension cable. Phone cables or connections are not recommended for use.

**NOTE:** Using extension cables will shorten battery life.

**Warning:** Never cut, splice, shorten or modify your sensor cables or extension cables. Doing so may damage your sensors and will void your warranty.

### The Weather Station

The Weather Station is designed to be free standing only.

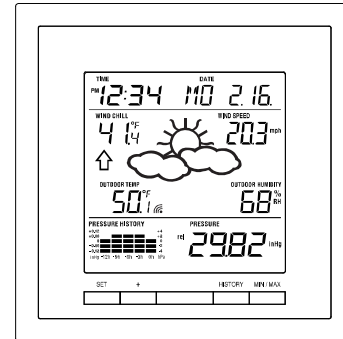

### The Thermo-hygro Sensor

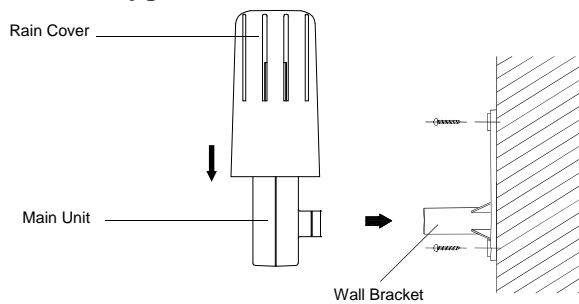

An ideal mounting place for the thermo-hygro sensor would be the outer wall beneath the extension of a roof, as this will protect the sensor from direct sunlight and other extreme weather conditions. Be sure to mount vertically.

To wall mount, use the 2 screws to affix the wall bracket to the desired wall, plug in the thermo-hygro sensor to the bracket and secure both parts by the use of the supplied screw and ensure that the cable from the wind sensor is correctly plugged in otherwise data transmission errors could occur.

### The Wind Sensor

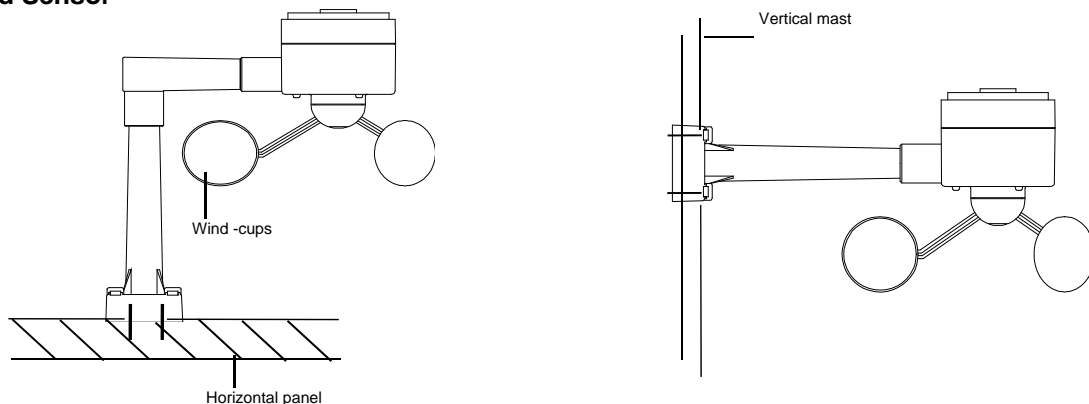

Check that the wind-cups can rotate freely before fixing the unit. For correct and accurate readings, it is important to mount the sensor with the cups on the bottom. The wind sensor should now be mounted using the screw or cable tie provided onto a solid wall/ panel mast or mast to allows the wind to travel around the sensor unhindered from all directions (ideal mast size should be from diameter 0.62" to 1.29" (16mm to 33mm). Do not over tighten the mounting bracket

Once the wind sensor is fixed onto the mast, connect the cable to the corresponding thermo-hygro sensor socket so that operating power supply can be received and data can be transmitted to the base station. Secure cord from blowing. Do not use staples. Using PVC pipe or metal as a mast may cause static. Wood is recommended.

### The Rain Sensor (optional)

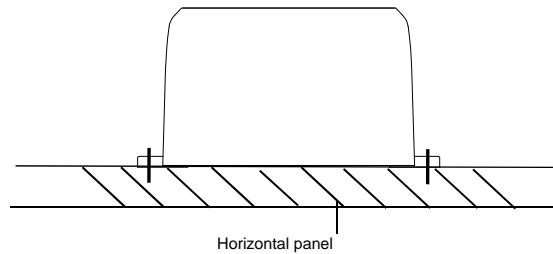

For best results, the rain sensor should be securely mounted onto a horizontal surface about 39.37" (1 meter) above the ground (or higher) and in an open area away from trees or other coverings where rainfall may be reduced causing inaccurate readings.

When securing into place, check that rain excess will not collect and store at the base of the unit but can flow out between the base and the mounting surface (test by pouring clean water). Do not tighten screws past just snug.

After mounting the rain sensor and placing battery, the rain sensor is now operable. For testing purposes, very slowly pour a small amount of clean water into the rain sensor funnel. The water will act as rainfall and will be received and displayed at the base station i.e. when the reading interval is reached.

### CARE AND MAINTENANCE:

- **Do Not Mix Old and New Batteries**
- **Do Not Mix Alkaline, Standard, or Rechargeable Batteries**
- Extreme temperatures, vibration and shock should be avoided as these may cause damage to the unit and give inaccurate forecasts and readings.
- Precautions shall be taken when handling the batteries. Injuries, burns, or property damage may be resulted if the batteries are in contact with conducting materials, heat, corrosive materials or explosives. The batteries shall be taken out from the unit before the product is to be stored for a long period of time.
- Immediately remove all low powered batteries to avoid leakage and damage. Replace only with new batteries of the recommended type.
- When cleaning the display and casings, use a soft damp cloth only. Do not use solvents or scouring agents as they may mark the LCD and casings.
- Do not submerge the unit in water.
- Special care shall be taken when handling a damaged LCD display. The liquid crystals can be harmful to user's health.
- Do not make any repair attempts to the unit. Return them to their original point of purchase for repair by a qualified engineer. Opening and tampering with the unit may invalidate their guarantee.
- Never touch the exposed electronic circuitry of the device, as there is danger of electric shock, should it become exposed.
- Do not expose the units to extreme and sudden temperature changes, this may lead to rapid changes in forecasts and readings and thereby reduce their accuracy.

### SPECIFICATIONS:

#### Temperature measuring range:

Indoor: 32° F to +139.8° F with 0.2° F resolution  
0° C to +59.9° C with 0.1° C resolution  
(Displays "OF.L" if outside this range)

**Outdoor / dew point:** -40° F to +139.8°F with 0.2° F resolution  
-40° C to +59.9° C with 0.1° C resolution  
(Displays "OF.L" if outside this range)

**Relative humidity measuring range:**

Outdoor: 1% to 99% with 1% resolution  
(Displays “-” if < 1%, “99” Displays if ≥ 99%)

**Wind speed/ gust:** 0 to 111.8 mph (0 to 180km/h; 0 to 50 m/s)  
(Displays "OF.L" when > 111.8 mph; 180 km/h; 50m/s)

**Wind chill/ dew point:** -40°F to +139.8° F with 0.2° F resolution  
-40°C to +59.9° C with 0.1° C resolution  
("OF.L" displayed if outside this range)

**Relative pressure pre-set range:** 27.14 to 31.90 inHg (919 to 1080 hPa)

**24h rainfall:** 0" to 39.3" with 0.01" resolution  
0 to 999.9 mm with 0.1mm resolution

**Total rainfall:** 0" to 393.7" with 0.01" resolution  
0 to 9999 mm with 0.1mm resolution  
(Displays "OF.L" when > 9999mm)  
When the total rainfall is higher than 1000mm (for mm unit only),  
the resolution is changed to 1mm)

**Outdoor data reception:** Every 4.5 seconds (from thermo-hygro transmitter)  
Every 6.25 seconds (from rain sensor-optional)

**Air pressure checking interval:** Every 15 seconds  
**Transmission range:** Up to 330 feet (100 meters) in open space

**Power consumption:**

Weather Center: 2 x C, IEC LR14, 1.5V  
Thermo-hygro transmitter: 2 x AA, IEC LR6, 1.5V  
Rain sensor(optional) : 2 x AAA, IEC LR3, 1.5V  
Battery life: Approximately 24 months (Alkaline batteries recommended)

**Dimensions (L x W x H):**

Weather Center: 5.83" x 5.83" x 2.0" / 148 x 148 x 50.8mm  
Thermo-hygro transmitter: 2.25" x 2.44" x 6.17" / 57.3 x 62 x 157mm  
Wind sensor: 9.8" x 5.7" x 7.5" / 250 x 145.9 x 191.4mm  
Rain sensor (optional): 5.67" x 2.15" x 3.46" / 144 x 54.6 x 88mm

**LIABILITY DISCLAIMER**

- The electrical and electronic wastes contain hazardous substances. Disposal of electronic waste in wild country and/or in unauthorized grounds strongly damages the environment.
- Please contact your local or/and regional authorities to retrieve the addresses of legal dumping grounds with selective collection.
- All electronic instruments must from now on be recycled. User shall take an active part in the reuse, recycling and recovery of the electrical and electronic waste.
- The unrestricted disposal of electronic waste may do harm on public health and the quality of environment.
- As stated on the gift box and labelled on the product, reading the “User manual” is highly recommended for the benefit of the user. This product must however not be thrown in general rubbish collection points.
- The manufacturer and supplier cannot accept any responsibility for any incorrect readings and any consequences that occur should an inaccurate reading take place.
- This product is designed for use in the home only as indication of the temperature.
- This product is not to be used for medical purposes or for public information.
- The specifications of this product may change without prior notice.
- This product is not a toy. Keep out of the reach of children.
- No part of this manual may be reproduced without written authorization of the manufacturer.

## WARRANTY INFORMATION

La Crosse Technology, Ltd provides a 1-year limited warranty on this product against manufacturing defects in materials and workmanship.

This limited warranty begins on the original date of purchase, is valid only on products purchased and used in North America and only to the original purchaser of this product. To receive warranty service, the purchaser must contact La Crosse Technology, Ltd for problem determination and service procedures. Warranty service can only be performed by a La Crosse Technology, Ltd authorized service center. The original dated bill of sale must be presented upon request as proof of purchase to La Crosse Technology, Ltd or La Crosse Technology, Ltd's authorized service center.

La Crosse Technology, Ltd will repair or replace this product, at our option and at no charge as stipulated herein, with new or reconditioned parts or products if found to be defective during the limited warranty period specified above. All replaced parts and products become the property of La Crosse Technology, Ltd and must be returned to La Crosse Technology, Ltd. Replacement parts and products assume the remaining original warranty, or ninety (90) days, whichever is longer. La Crosse Technology, Ltd will pay all expenses for labor and materials for all repairs covered by this warranty. If necessary repairs are not covered by this warranty, or if a product is examined which is not in need of repair, you will be charged for the repairs or examination. The owner must pay any shipping charges incurred in getting your La Crosse Technology, Ltd product to a La Crosse Technology, Ltd authorized service center. La Crosse Technology, Ltd will pay ground return shipping charges to the owner of the product to a USA address only.

Your La Crosse Technology, Ltd warranty covers all defects in material and workmanship with the following specified exceptions: (1) damage caused by accident, unreasonable use or neglect (including the lack of reasonable and necessary maintenance); (2) damage occurring during shipment (claims must be presented to the carrier); (3) damage to, or deterioration of, any accessory or decorative surface; (4) damage resulting from failure to follow instructions contained in your owner's manual; (5) damage resulting from the performance of repairs or alterations by someone other than an authorized La Crosse Technology, Ltd authorized service center; (6) units used for other than home use (7) applications and uses that this product was not intended or (8) the products inability to receive a signal due to any source of interference.. This warranty covers only actual defects within the product itself, and does not cover the cost of installation or removal from a fixed installation, normal set-up or adjustments, claims based on misrepresentation by the seller or performance variations resulting from installation-related circumstances.

LA CROSSE TECHNOLOGY, LTD WILL NOT ASSUME LIABILITY FOR INCIDENTAL, CONSEQUENTIAL, PUNITIVE, OR OTHER SIMILAR DAMAGES ASSOCIATED WITH THE OPERATION OR MALFUNCTION OF THIS PRODUCT. THIS PRODUCT IS NOT TO BE USED FOR MEDICAL PURPOSES OR FOR PUBLIC INFORMATION. THIS PRODUCT IS NOT A TOY. KEEP OUT OF CHILDREN'S REACH.

This warranty gives you specific legal rights. You may also have other rights specific to your State. Some States do not allow the exclusion of consequential or incidental damages therefore the above exclusion of limitation may not apply to you.

For warranty work, technical support, or information contact:

La Crosse Technology, Ltd  
2817 Losey Blvd. S.  
La Crosse, WI 54601  
Phone: 608.782.1610  
Fax: 608.796.1020

e-mail: <http://www.lacrossetechnology.com/support/home.php> (warranty work)

**Contact Support: 1-608-782-1610**

**Product Registration: [www.lacrossetechnology.com/support/register.php](http://www.lacrossetechnology.com/support/register.php)**

[www.lacrossetechnology.com](http://www.lacrossetechnology.com)

For more information, please visit:  
<http://www.lacrossetechnology.com/1913twc/>

All rights reserved. This handbook must not be reproduced in any form, even in excerpts, or duplicated or processed using electronic, mechanical or chemical procedures without written permission of the publisher.

This handbook may contain mistakes and printing errors. The information in this handbook is regularly checked and corrections made in the next issue. We accept no liability for technical mistakes or printing errors, or their consequences.

All trademarks and patents are acknowledged.

## Free Manuals Download Website

<http://myh66.com>

<http://usermanuals.us>

<http://www.somanuals.com>

<http://www.4manuals.cc>

<http://www.manual-lib.com>

<http://www.404manual.com>

<http://www.luxmanual.com>

<http://aubethermostatmanual.com>

Golf course search by state

<http://golfingnear.com>

Email search by domain

<http://emailbydomain.com>

Auto manuals search

<http://auto.somanuals.com>

TV manuals search

<http://tv.somanuals.com>