

Tiros	63 TG 51 - 100 MT
Ibiza-SF	63 TG 62 - 100 MT
Morea-S	70 TG 65 - 100 MT
Crystal	70 TG 53 - 100 MT
Linea <i>de luxe</i> - SF	72 TG 67 - 100 MT

Operating instructions



# Hints for use of the Operating Instructions

Do not be put off by the size of the Operating Instructions. Initially, it is sufficient to read the instructions in Sections 1.1, 2 and 4.

In order to familiarise yourself with the TV set and its many functions, we recommend that you read the Operating Instructions step by step, carrying out the described actions on your TV set as you do so.

This method, often called "learning by doing", is the easiest way of learning how to execute the various functions.

Do not be afraid to change the settings in the various menus (the TV menu, the TV station table, programming of the function keys, etc.). If you make any changes to these settings, the TV set reacts immediately, but the changes are not yet stored. After each change in a menu, a red box is displayed at the bottom right of the screen, asking if you want to save the changes.

- If you want to save the changes, press the **OK** key to do so.
- If you are not sure, or if you do not want to save a changed setting, press the **MENU** key and then the **TV** key to exit from the menu without saving the new settings.

We have made every effort to provide a detailed table of contents and a comprehensive index to help you to find the information you need. The Section "Glossary" contains explanations of various technical terms used in the manual.

In the descriptions of the various functions, the left-hand column shows which keys you must press in order to see the screen display given in the centre column. Do not press the keys too quickly. It may occur that the TV set will not recognise the next key you press and may therefore not display the menu shown in the centre column but something completely different. The right-hand column of the function description provides additional information which may be useful but is not absolutely necessary for execution of the function.

*If you comply with these hints, you should have no problems in the operation of your TV set.*

Your Metz-Werke

## Contents

Remote control handset RB11 .....	3	<b>10. Hi Text .....</b>	<b>30</b>
<b>1. Setting up and connecting .....</b>	<b>4</b>	Basic functions .....	30
1.1 Turning the TV on and off .....	5	Multiple pages .....	32
1.2 Language selection in the TV menu .....	5	Page selection by cursor .....	33
<b>2. Programme selection .....</b>	<b>6</b>	Direct page selection .....	33
Programme position management .....	6	Return to last index page .....	33
Back to last programme .....	7	Topical or news-flash pages .....	33
2.1 TV menu and operator help .....	7	Doubling the font size .....	34
<b>3. Presetting TV stations .....</b>	<b>8</b>	Setting marks .....	35
Colour and transmission standards .....	8	Infotext .....	37
Direct channel entry/station search .....	9	Erasing marks .....	38
Autostore function .....	10	Subtitles .....	39
3.1 Sorting stations .....	11	Riddle solutions key .....	39
3.2 Fine tuning .....	12	<b>11. Special picture effects .....</b>	<b>40</b>
3.3 Allocating a station logo .....	13	Variable zoom .....	40
<b>4. Changing individual picture settings .....</b>	<b>14</b>	Still picture .....	41
4.1 Changing individual sound settings .....	14	<b>12. Operation without remote control .....</b>	<b>41</b>
4.2 Adjusting the video and audio standard values .....	15	<b>13. Remote control handset for video recorders .....</b>	<b>42</b>
<b>5. Equipment configuration .....</b>	<b>16</b>	<b>14. Connecting peripheral equipment .....</b>	<b>43</b>
Assigning the function keys .....	16	Camcorder, videorecorder .....	43
Settings for programme change .....	18	Connecting peripheral equipment .....	43
<b>6. Volume adjustment and forced mono .....</b>	<b>19</b>	Connecting external devices .....	44
6.1 Correcting picture deviations .....	20	Connecting video recorders .....	45
Noise reduction and CTI function .....	20	Video recorders, video signal .....	46
<b>7. AV recording .....</b>	<b>22</b>	Connecting a Pay-TV decoder (e.g. Premiere) .....	47
Camcorder < video recorder .....	22	Video signal for Pay-TV decoder .....	48
Video recorder < video recorder .....	23	<b>15. Technical data .....</b>	<b>49</b>
<b>8. Time settings .....</b>	<b>24</b>	15.1 Upgrade kits .....	49
Switch-on/off and reminder time .....	25	15.2 Guarantee .....	49
8.1 Childlock .....	26	<b>16. Glossary .....</b>	<b>50</b>
Switching on .....	26	<b>17. Data Logic .....</b>	<b>51</b>
Permitted programmes .....	26	Automatic transfer of station information .....	51
8.2 Recording with the timer .....	28	<b>18. Index .....</b>	<b>52</b>
<b>9. Connecting headphones .....</b>	<b>29</b>	Troubleshooting and care of the set .....	53
Adjusting the headphones volume .....	29		

# Remote control handset RB 11

The remote control sends commands to the TV set with the aid of infrared light. For this reason, you should always point the remote control at the TV set for reliable operation. Use of the remote control may interfere with the operation of other devices or systems controlled which use infrared light (such as infrared headphones).

The television must be switched on or in standby mode (ON/OFF key depressed) when it is to be operated by remote control. Always point the remote control in the direction of the TV for operation. A **pilot lamp** starts to flash as soon as a key on the remote control handset is pressed.

## Nota:

For explanation of the video level for the remote control of video recorders, please refer to Section 13, page 42.



**Do not point the remote control unit into your eyes and press a key on it !**  
**Do not use rechargeable batteries in the remote control unit.**

- Switch between the TV and radio functions (radio only if a SAT upgrade kit is installed)

- Change the setting
- HiText - select page of a multiple-page subject (page 32)

- Basic picture and sound settings (page 15)
- Hi-Text - display the page (page 33)

- Return to TV picture from menu or from Hi Text

- Call TV menu (page 7)
- Within a menu, move back one step

- Operator Help

- Function keys, depending on programming (page 16)

- Clear key in various menus

- Return to the last programme (page 7)

- Changeover from spoken to music broadcasts

- Change of format (variable zoom) (page 40)

- Still picture (page 41)

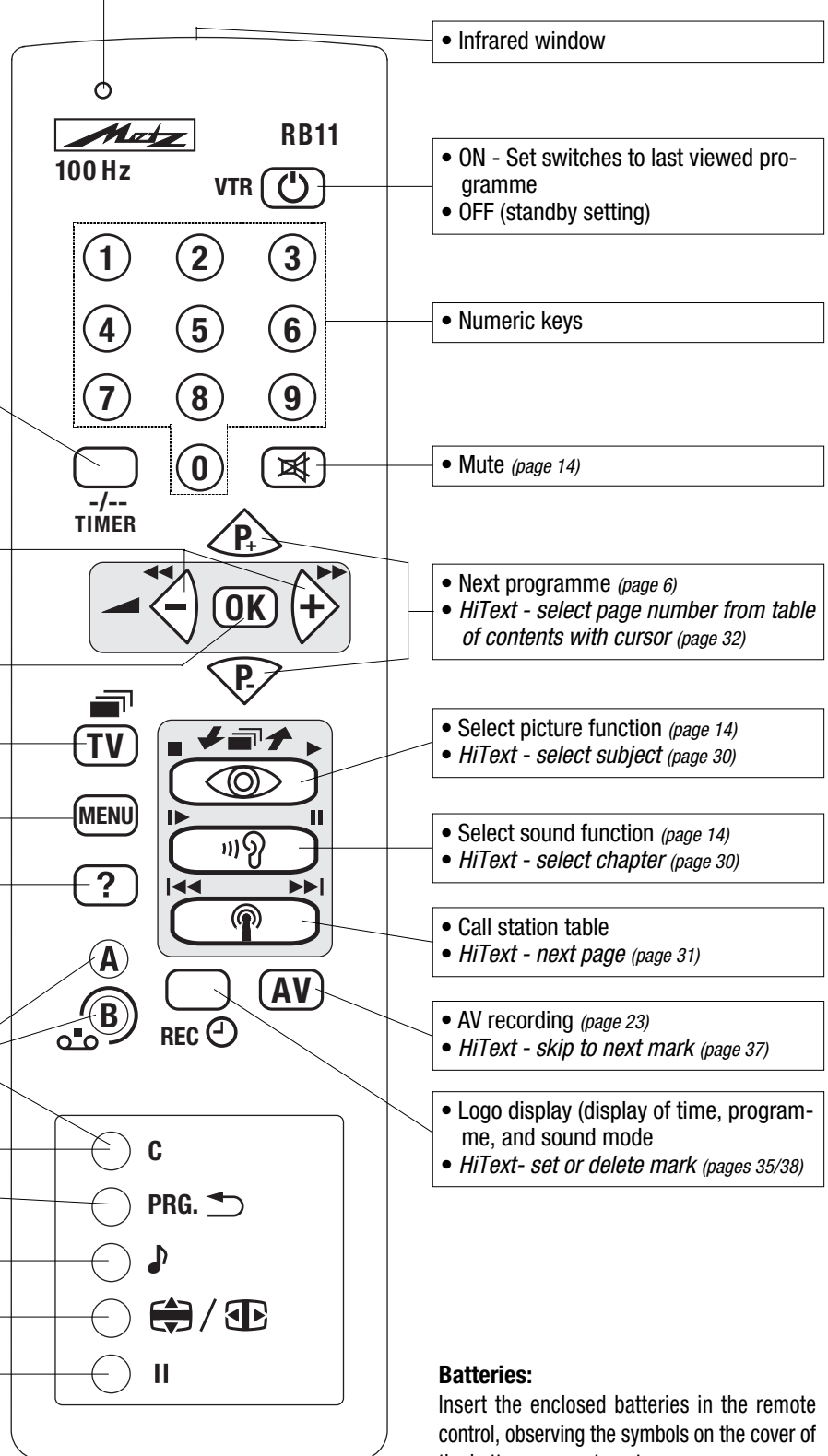

• Infrared window

• ON - Set switches to last viewed programme  
 • OFF (standby setting)

• Numeric keys

• Mute (page 14)

• Next programme (page 6)  
 • HiText - select page number from table of contents with cursor (page 32)

• Select picture function (page 14)  
 • HiText - select subject (page 30)

• Select sound function (page 14)  
 • HiText - select chapter (page 30)

• Call station table  
 • HiText - next page (page 31)

• AV recording (page 23)  
 • HiText - skip to next mark (page 37)

• Logo display (display of time, programme, and sound mode)  
 • HiText - set or delete mark (pages 35/38)

## Batteries:

Insert the enclosed batteries in the remote control, observing the symbols on the cover of the battery compartment.

Remove exhausted batteries from the remote control and return them to your dealer or to an authorised battery collection point.

## Disposal of batteries

**Do not dispose of spent batteries with domestic rubbish.**

**Please return spent batteries to collecting points should they exist in your country !**

# 1. Setting up and connecting

## Setting up

When selecting a suitable place for the TV, be sure that no bright light or sunlight falls on the screen. Light may cause reflections and impair the brilliance of the image.

The best viewing distance is five times the picture tube diagonal, e.g. about 3.5 m for TV sets with a 70 cm screen.

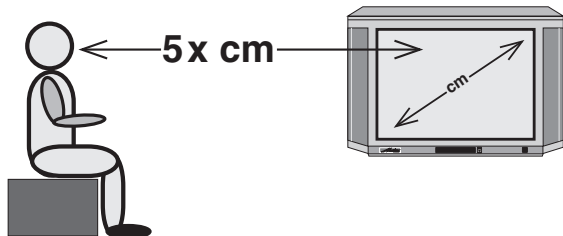

**!** TV sets require adequate ventilation. The ventilation slots at the rear of the set should therefore never be covered by curtains, doilies, newspapers or similar objects. Likewise, all slots at the bottom of the set must be freely accessible so that the intake of air is not impaired in any way

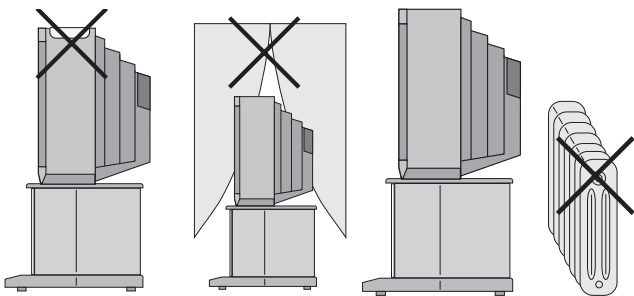

**!** Do not set up the TV near a radiator as this would impair adequate cooling.

**!** Do not place  
- burning candles or  
- flower vases filled with water  
on top of the TV set.  
Hot wax and liquids destroy the electrical components and jeopardize the electrical safety of the set

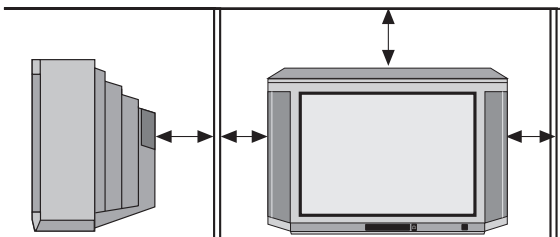

**!** If you place the set in a wall unit, leave sufficient space on all sides so that the air can circulate freely.

**!** Your TV set is intended for use in dry rooms. If you wish to use it occasionally outdoors, be sure to protect it against any kind of moisture (rain, splashes, dew, etc.).

## Connecting the aerial

Standard SAT and terrestrial station aerial sockets are fitted at the rear of the TV.

Thunderstorms represent a danger for all electrical appliances! If lightning strikes the power line or the aerial, the TV may be damaged even if it is switched off. Therefore, always unplug the mains lead AND aerial during thunderstorms.

If the TV is not going to be used for an extended period of time, for instance when on holiday, then disconnect the set both from the mains and the aerial.

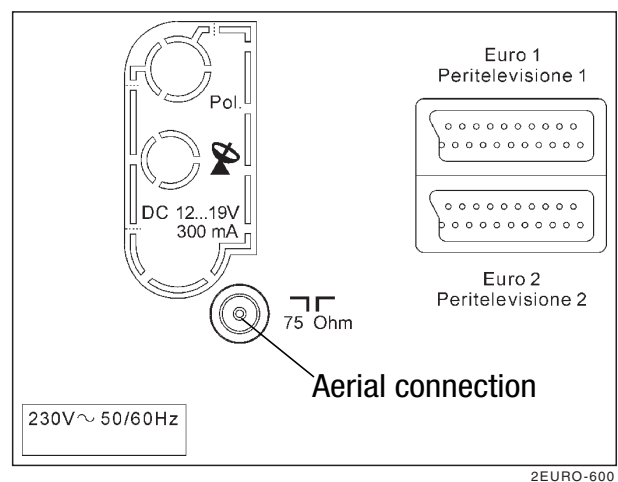

## Mains voltage

Plug the mains lead into a wall outlet. The TV set is equipped for 230 V ac (Australia 240 V ac).

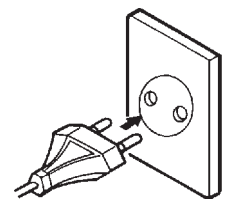

# 1.1 Turning the TV on and off

## Turning on with the ON/OFF key

**!** Before turning on a cold TV in a warm room, first allow any condensation mist that may have formed on the screen to evaporate.

### Press the ON/OFF key.

Programme position 1 is then selected. Depending on the assignments made, the following information will appear in the screen box:



The programme position is also shown on the permanent display.

## Turning on with the remote control

The programmes can be directly selected with the 0-9 keys when the television is in standby mode.

The last programme watched before the television was switched off can be set with the key.

The television is automatically set to standby mode ten minutes after station closedown. However, this is not the case if the station starts to transmit a test card within these ten minutes.

## Turning off with the remote control

Press the key to switch the TV to standby mode. The standby status is indicated by the red lamp.

## Turning off with the ON/OFF key

Press the ON/OFF key. The television is now disconnected from the mains. You are advised to turn off the TV with the ON/OFF key after station closedown and when it is not going to be used for an extended period of time.

# 1.2 The TV menu

Press this key on the remote control....	The screen displays	Explanation
<p><b>1. Call the Equipm. Configuration menu</b></p> <p> — red — green</p> <p><b>2. Adjust the language</b></p> <p> — </p> <p><b>3. Store the selected language</b></p> <p></p> <p></p>	<p style="text-align: center;"><b>TV picture</b></p>	<p>The desired language for the entire TV menu is adjusted in the „Equipm.Configuration“ menu.</p> <p>Select the desired language with the   keys when the submenu for the language is displayed on a green background.</p> <p>Press the  key to confirm and store the selection made. The complete text in the TV menu is then displayed in the selected language.</p>







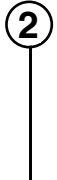

# 2. Programme selection

## Programme position management

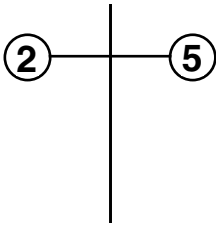
This TV set can manage up to 225 TV programme positions. If you are connected to a cable network or use a terrestrial aerial, you will not need all of these positions at the moment. If, however, you have a SAT upgrade kit installed, the number of programmes can increase drastically. We do not know how many programmes will be available in the future. For this reason, we have provided plenty of programme positions in reserve. For selection of the desired programme position, we have invented a simple input method which saves you having to enter three digits for each position.

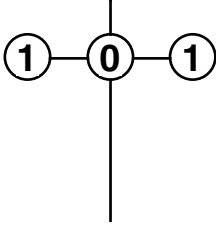
**The first digit you enter is normally the hundreds digit. If, however, you have less than 100 programmes stored, this digit automatically moves to the tens position. If you have less than ten programmes stored, it moves to the units position.**

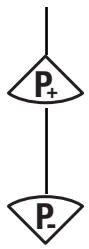
**Example:** you have stored programmes in positions 1 to 35 and you want to select position 3. Press the keys **0** and **3** or simply **3** and confirm with **OK**. Programme position 4 can be selected by simply entering **4**, since there are no programme positions higher than 39. Further examples are shown in the following text.

Press this key on the remote control....	The screen displays	Explanation
<p><b>1. Select programme position 2 (only the first 9 programme positions in the station table are occupied)</b></p> 		<p>Only the programme positions 0-9 in the station table may be occupied if a programme is to be selected by pressing one numeric key.</p> <p><b>Pressing the numeric key opens a time-delay window* which waits for 3 seconds for the input of further digits. If no further numeric key is pressed, the TV set switches to the programme position selected with the first digit.</b></p> <p>* The operating mode of this time delay window can be changed: see page 18, item 5, „PC time out“.</p>
<p><b>2. Select programme position 25 (only the first 99 programme positions in the station table are occupied)</b></p> 		<p>Only the programme positions 0-99 in the station table may be occupied if a programme is to be selected by pressing two numeric keys.</p> <p>After a programme has been selected successfully, a box containing the programme position number, the time and the current sound mode (e.g. stereo) is displayed on the screen.</p> <p>To select a programme position with only a single-digit number, you must enter <b>0</b> before the related digit, e.g. <b>0</b> and <b>2</b>; alternatively, you can press <b>2</b> and then press <b>OK</b>.</p>
<p><b>3. Select programme position 101 (more than 100 programme positions in the station table are occupied)</b></p> 		<p>In this case, <u>more than</u> 100 programme positions in the station table are occupied, which means that you have to press three numeric keys.</p> <p>After a programme has been selected successfully, a box containing the programme position number, the time and the current sound mode (e.g. stereo) is displayed on the screen.</p> <p>To select a programme positions with a single-digit or two-digit number, you must enter <b>0</b> before the related digit(s), e.g. <b>0 0</b> and <b>2</b>; alternatively, you can press <b>2</b> and then press <b>OK</b>.</p>
<p><b>4. Next programme</b></p> 		<p>You can step sequentially through the programme positions with the <b>P+</b> <b>P-</b> keys. If either of these keys is held down for more than two seconds, a programme box for selection of the desired programme is displayed on the screen. Release the <b>P+</b> or <b>P-</b> key as soon as the desired logo is highlighted in white: this programme position will then be selected.</p>

## 2. Programme selection

Press this key on the remote control....	The screen displays	Explanation
<p><b>Last programme</b></p> <p>PRG. ↶</p>		<p>With this key, you can switch back and forth between the last two programme positions you selected.</p> <p><i>Example:</i> You are watching a programme on ITN; during the commercials, you switch to BBC with the aid of the numeric keys <b>0</b> . <b>9</b></p> <p>You can now switch back and forth between ITN and BBC by pressing the PRG. ↶ key.</p>

## 2.1 TV menu and operator help

Menu control of the TV, and the versatility of the system, ensure that supposed complicated settings and entries are made easily and clearly comprehensible for everyone. Operator Help can be called with the **[?]** key when in TV mode. Operator Help indicates the functions of the individual keys.

All settings are entered by way of different submenus. Simply call Operator Help with the **[?]** key should you encounter difficulties in entering the different equipment configurations or if problems arise in operating the TV. Operator Help is specifically matched to the corresponding menu and functions as a reminder when settings are entered or programmed.

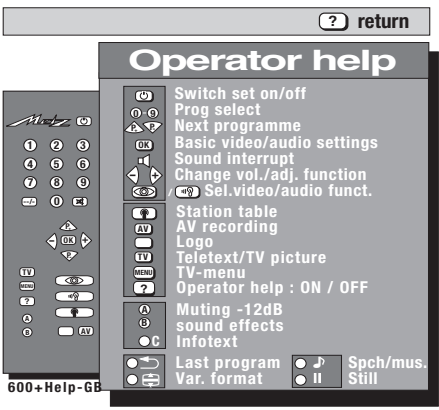
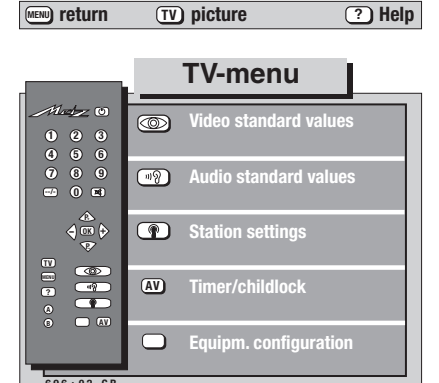



Press this key on the remote control....	The screen displays	Explanation
<p><b>Operator Help: Call/exit</b></p> <p><b>[?]</b></p>		<p>Operator Help shows the functions of the individual keys when in TV mode.</p> <p>The <b>A</b>, <b>B</b>, and <b>C</b> function keys can be programmed by the user. Consequently their functions can differ to those shown in the adjoining picture.</p> <p>Operator Help can be called for each menu displayed on the screen. (Example: Operator Help with displayed TV menu).</p>
<p><b>TV menu: Call/exit</b></p> <p><b>[MENU]</b></p>		<p>The individual menu lines are selected with the coloured keys of the remote control, to open the corresponding submenu. Keys not enhanced in white or colour on the displayed menu have no function in the current operating state.</p> <div style="border: 1px solid black; padding: 5px;"> <p><b>Settings in the submenus can be changed with the <b>[Left/Right]</b> keys.</b></p> <p><b>Press the <b>[OK]</b> key to confirm and store the new setting.</b></p> <p><b>Press the <b>[MENU]</b> key to move back by one step within the TV menu.</b></p> </div>

# 3. Presetting TV stations Colour and transmission standards

In the sub-menu **Standard**, you can select the colour and/or the transmission standard. The TV set normally recognises the colour standards (PAL, SECAM, NTSC) automatically, but the transmission standard must always be set manually. The multi-standard upgrade kit is required for the additional transmission standards L, I, D/K and NTSC 4.43. In exceptional cases, the colour standard may not be recognised; if this happens, you must set it as described below.

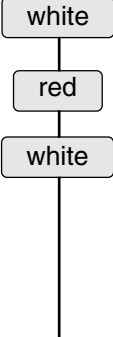
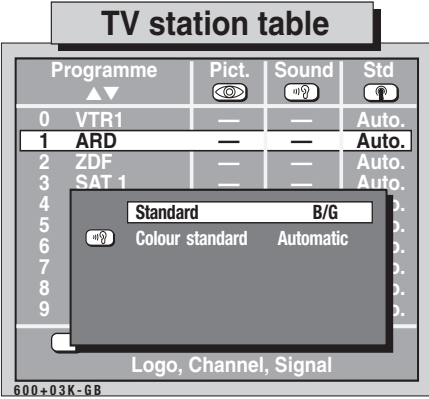
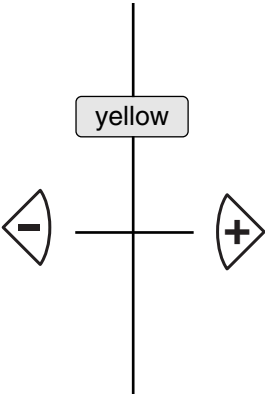
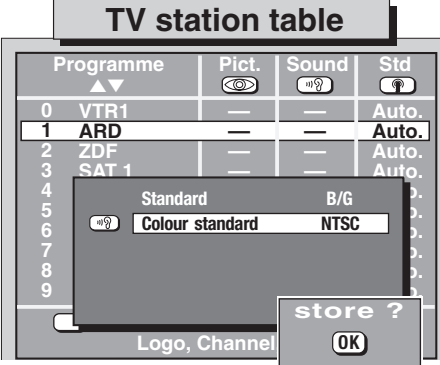
**Example:**

The colour standard „NTSC“ is to be set.

Press this key on the remote control....	The screen displays	Explanation
<p><b>1. Call submenu „Standard“</b></p> 		<p>The automatic function of the submenu „Standard“ is preset in the factory.</p> <p>The settings PAL, SECAM and NTSC need to be selected manually only if the automatic detection function does not recognize the colour standard correctly.</p>
<p><b>2. Select the transmission standard or colour standard (e.g. standard I)</b></p> 		<p><b>The transmission standard must always be set manually.</b></p> <p>The various standards can be selected with the  keys.</p> <p>In this example, the transmission standard NTSC is selected.</p> <p>The multi-standard upgrade kit 031 NC 1030 (optional extra) is required for the reception of the transmission standards L, I, D/K and NTSC 3,58.</p>
<p><b>3. Store the settings and return to the TV picture</b></p> 		



# 3. Presetting TV stations

## Direct channel entry/ station search

When the TV set leaves the factory, there are no stations programmed. Depending on where you live, the stations have different channel numbers. There are three possible ways of programming the stations:

- a) Direct channel input
- b) Station search
- c) the Autostore function

Press this key on the remote control....

The screen displays

Explanation

### 1. Call the station table and channel type survey

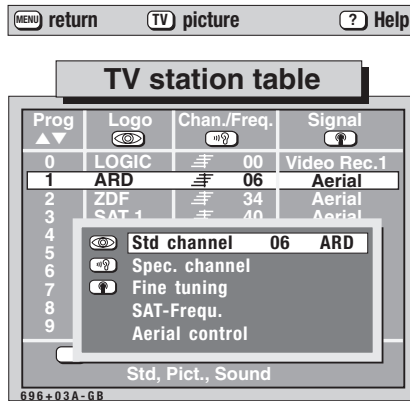
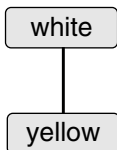

With **direct channel entry** it is necessary to know the type of channel and the channel number.

If type and number of channel are not known, you can scan through the entire reception range with the **search function** to locate stations.

The station table lists all the preset stations.

These stations can be changed at any time.

The cursor always highlights the type of channel currently preset in the given programme position.

For the **search function** it is advisable to switch to a vacant programme position.

### 2. Select the type of channel (e.g. standard channel)

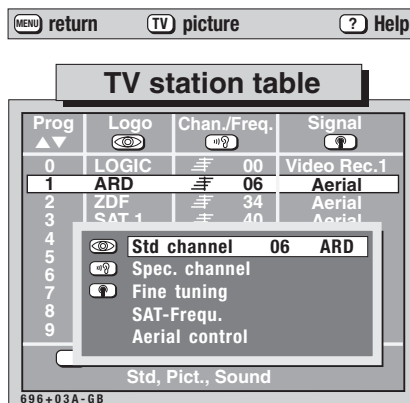
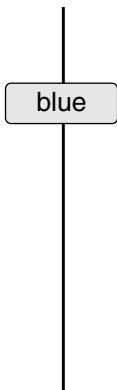

Two types of channels are offered in the box with the yellow frame. Select the desired channel type with the related coloured keys.

Once the channel type has been selected, a channel number is displayed for the highlighted item if a station is stored in this programme position. If no station is stored, two dashes are displayed.

„SAT freq.“ and „Aerial control“ can be selected only if a SAT upgrade kit is installed in the TV set.

### 3. Enter the channel number (Example: Standard channel 06) or start station search

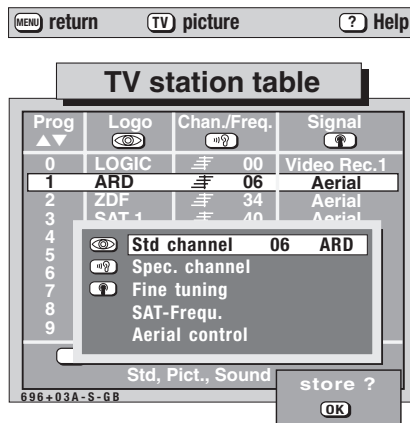
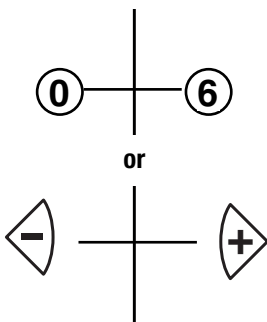

With **direct channel entry**, the station table is briefly faded out when the channel number is entered, and the selected station is displayed.

The **station search** proceeds from the displayed channel number in a forward sequence with the  $\blacktriangleright$  key, and in a reverse sequence with the  $\blacktriangleleft$  key. Search proceeds from the lower channel area upwards or downwards when two lines are displayed. The search stops when a station has been found.

Proceed as described in step 4 if the located station is to be stored.

Press the  $\blacktriangleright$  or  $\blacktriangleleft$  key if the located station is not to be stored so that the search can be continued.

Complete fine tuning if station reception is not clear (see Section 3.2).

### 4. Store the setting and return to TV picture

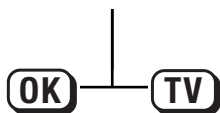

TV picture

# 3. Presetting TV stations

**Autostore function,  
sorted to countries**

The **autostore function** automatically scans through the entire reception range to locate stations. The located stations are presented in the station table and can then be stored by way of the **OK** key.

If you do not like the order in which the stations appear in the station table, you can sort the stations to match your own requirements as described on the next page.

Press this key on the remote control....	The screen displays	Explanation
--	---------------------	-------------

## 1. Call the menu „Station settings“

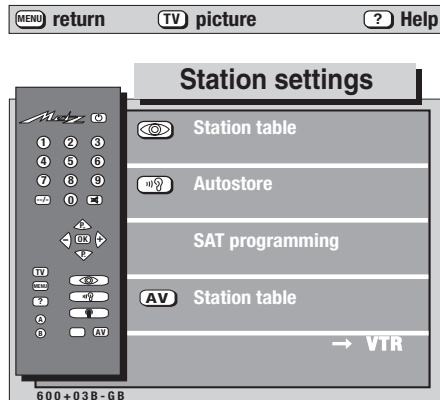
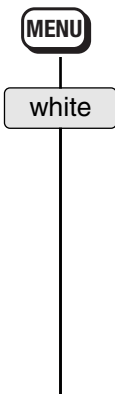

## 2. Call and start the autostore function

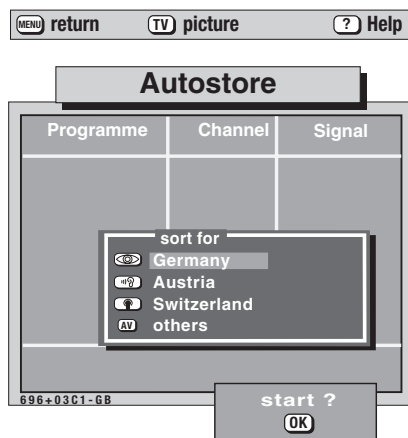

Press the yellow key to call the autostore function.

The coloured keys can now be used to select the country so that the stations which are detected are stored in a logical order for this country.

Press the **OK** key to start the station search. The TV set now scans through the entire reception range.

This function can be cancelled by pressing the **TV** key.

## 3. Edit and store the station list

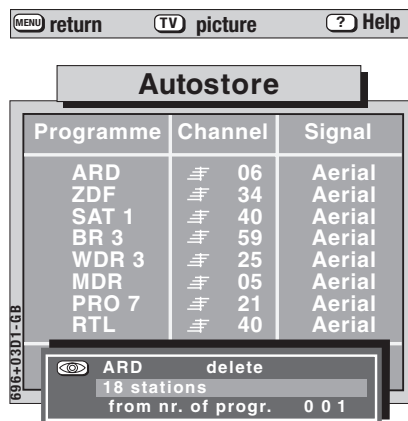
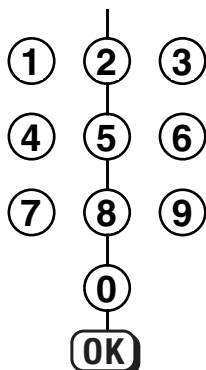

When all available stations have been found, a station list is displayed on the screen.

The channel number and an automatic logo are displayed. The auto logo only appears for stations which transmit a VPS signal.

You can now delete stations which are not wanted, or which are received only poorly, by pressing the blue key.

Enter the number of the programme position at which storage of the detected stations is to start.

Now proceed as described in Section 3.1 **Sorting station.**

# 3.1 Sorting stations

In the „Sort“ submenu you can move, exchange, copy, or delete the stations stored in the programme positions. The „Sort“ submenu is displayed automatically after the autostore function has found all available stations.

This menu can also be called at any time from the station table display for subsequent modification of the station programming.

Press this key on the remote control....	The screen displays	Explanation
<p><b>1. Call the „Sort“ submenu and move the station</b></p> <p>either automatically after autostore or</p> <p style="text-align: center;">white</p> <p style="text-align: center;">A</p>		<p>When the „Sort“ submenu is displayed, the function „Move“ is preset. The station displayed for the currently selected programme position can be stored or moved to any other programme position.</p> <p>For a move, exchange or copy operation, the three-digit number of the destination programme position must be entered with the numeric keys. The blinking hyphen on the right of the sub-menu is the prompt for input of a programme position number.</p> <p>If you inadvertently delete a station you wanted to keep, you can restore it with the <b>B</b> key.</p> <p>An incorrectly entered programme position number can be deleted with the <b>C</b> key.</p>
<p><b>2. Exchanging two programme positions</b></p> <p style="text-align: center;">yellow</p> <p style="text-align: center;">1 2 3 4 5 6 7 8 9 0</p>		<p>You can swap the contents of two programme positions by pressing the yellow key and entering the digits.</p>
<p><b>3. Store the settings</b></p> <p style="text-align: center;">OK</p>		<p>After the contents of a programme position have been moved, exchanged, copied or deleted, a red store box is displayed to ask if you want to store the new settings.</p> <p>Press the <b>OK</b> key to store the new settings or press the <b>TV</b> key to abort the operation.</p>
<p><b>4. Return to TV picture</b></p> <p style="text-align: center;">TV</p>		

## 3.2 Fine tuning

The individual channels are automatically tuned to channel centre for station tuning. As a rule, this automatic tuning will be sufficient. Apply manual fine tuning if automatic tuning does not produce satisfactory results.

Select the programme number at which fine tuning is to be completed.

Press this key on the remote control....

The screen displays

Explanation

### 1. Select the fine tuning function

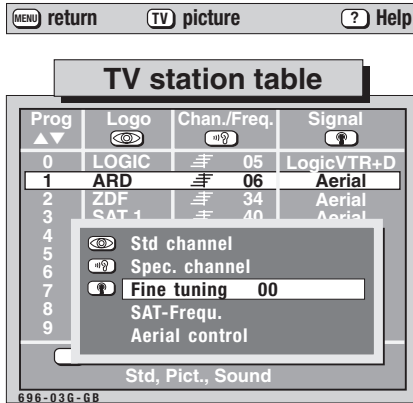
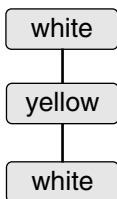

The „Fine tuning“ function is only activated when the corresponding line is highlighted.

### 2. Adjust the fine tuning

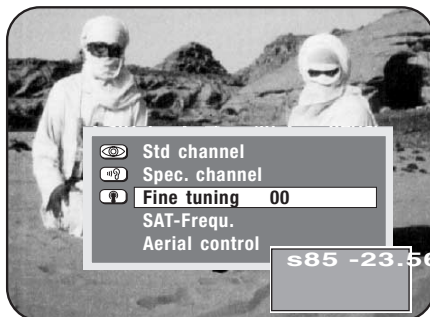
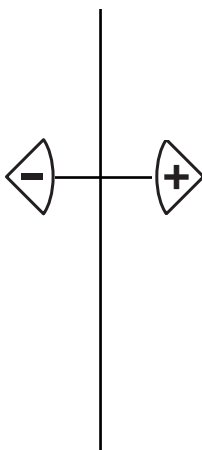

Adjust fine tuning within the range of -99 to +99 with the  $\leftarrow$   $\rightarrow$  keys.

The station table is blanked out for better picture assessment.



### 3. Store the fine tuning and return to TV picture



Once the station is correctly tuned, press the **OK** key to store the new setting.

# 3.3 Allocating a station logo

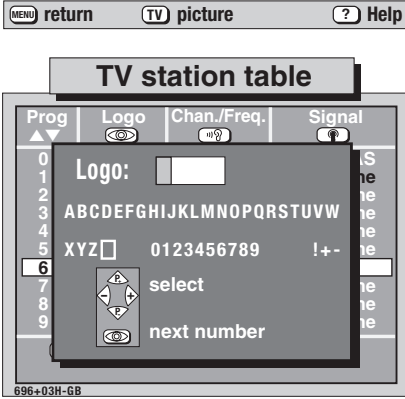
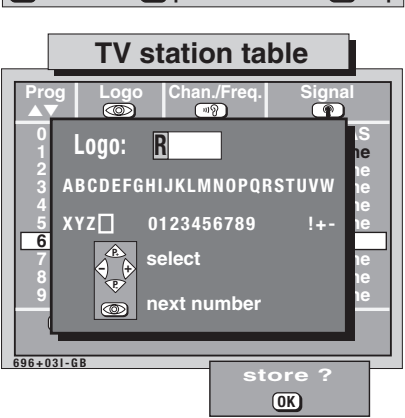

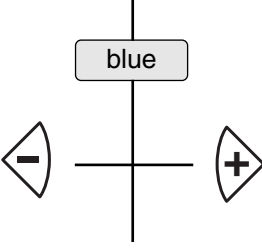
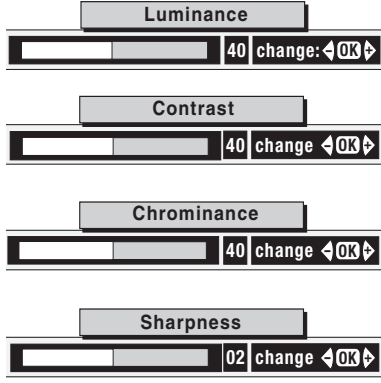
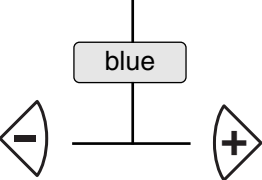

A logo of up to 8 characters is provided for each station via the VPS signal. The station RTL 2, for example, receives the logo RTL 2. Manual logo allocation is not necessary with most stations. The corresponding station logo appears a few seconds after the picture when a station is selected by direct channel entry. However, an automatic logo only appears for stations which transmit a VPS signal.

Press this key on the remote control....	The screen displays	Explanation
<p><b>1. Call the logo menu</b></p> <p>white</p> <p>blue</p>		<p>The logo is automatically displayed if the selected programme position already has a logo. The field remains blank if a logo has not yet been allocated.</p> <p><b>Automatically identified logos may consist of up to 8 characters. Manually allocated logos are limited to 5 characters.</b></p> <p>Any existing logo will be overwritten.</p>
<p><b>2. Select the first character</b></p> <p>P+</p> <p>-</p> <p>+</p> <p>P-</p>		<p>Select the desired character (in our example the letter <b>R</b>) with the keys <math>\leftarrow</math>, <math>\rightarrow</math>, <math>\uparrow</math>, <math>\downarrow</math>.</p> <p>This will overwrite any existing logo.</p>
<p><b>3. Move the cursor to the second position and select the second character</b></p> <p>blue</p> <p>P+</p> <p>-</p> <p>+</p> <p>P-</p>		<p>The cursor is moved within the logo field with the blue key.</p> <p>Select the desired character (in our example the letter <b>T</b>) with the keys <math>\leftarrow</math>, <math>\rightarrow</math>, <math>\uparrow</math>, <math>\downarrow</math>.</p> <p>Repeat this procedure to enter the entire logo.</p>
<p><b>4. Store the setting and return to TV picture</b></p> <p>OK</p> <p>TV</p> <p><b>TV picture</b></p>		<p>After input of the desired logo, press the <b>OK</b> key to store it.</p> <p>The programmed logo automatically appears in the station table.</p>

## 4. Changing individual picture settings

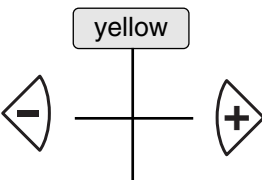
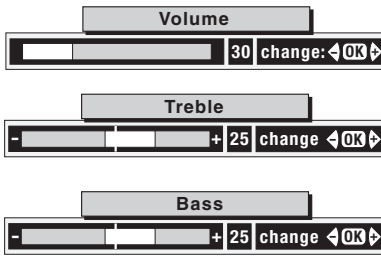
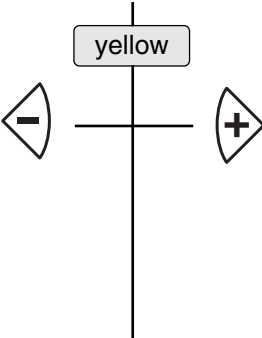
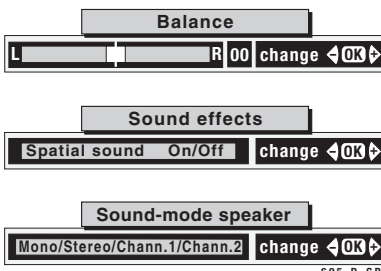
Press this key on the remote control....	The screen displays	Explanation
<p><b>1. Adjusting the luminance</b></p> 		<p>Press the blue key to display the last adjusted function.</p> <p>Continue pressing the blue key until the picture setting value to be changed (e.g. <b>luminance</b>) is displayed.</p> <p>You can now adjust the <b>contrast</b> with the <math>\leftarrow \rightarrow</math> keys. Set the desired value with the <math>\leftarrow \rightarrow</math> keys.</p> <p><b>Chrominance</b> and <b>sharpness</b> are adjusted in the same manner.</p>
<p><b>2. Adjusting the contrast</b></p> 		

## 4.1 Changing individual sound settings

Press this key on the remote control....	The screen displays	Explanation
<p><b>1. Adjusting the volume</b></p> 		<p>Press the yellow key to display the last adjusted function.</p> <p>Continue pressing the yellow key until the volume field is displayed on the screen.</p> <p>Set the desired value with the <math>\leftarrow \rightarrow</math> keys.</p>
<p><b>2. Adjusting the treble setting</b></p> 		<p>Press the yellow key a number of times until the treble field is displayed on the screen.</p> <p>Set the desired value with the <math>\leftarrow \rightarrow</math> keys.</p> <p>Bass, balance, sound effects and speaker sound-mode settings are adjusted in the same manner.</p>
<p><b>3. Sound mute</b></p> 		<p>Press the  key to mute the sound.</p> <p>Renewed depression of the  key resets the sound to the previously adjusted volume.</p>

**Note:**

All settings modified in this menu can be stored by calling the „Video standard values“ or „Audio standard values“ menu respectively and pressing the  $\text{OK}$  key. The stored values can be recalled at any time with the  $\text{OK}$  key.

# 4.2 Adjusting the video and audio standard values

Press this key on the remote control....

The screen displays

Explanation

## 1. Call the TV menu

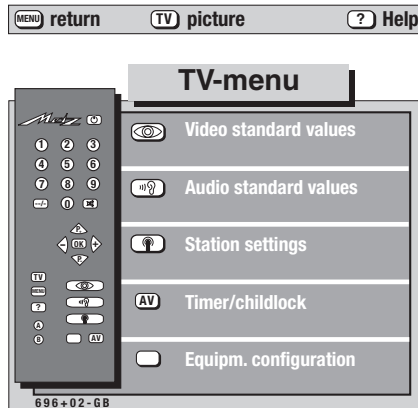

Press any coloured key to step through the submenus. Pressing the blue key selects the „Video standard values“ submenu, pressing the yellow key selects the „Audio standard values“ submenu

## 2. Example 1: Call the „Video standard values“ submenu. Adjust and store the sharpness.

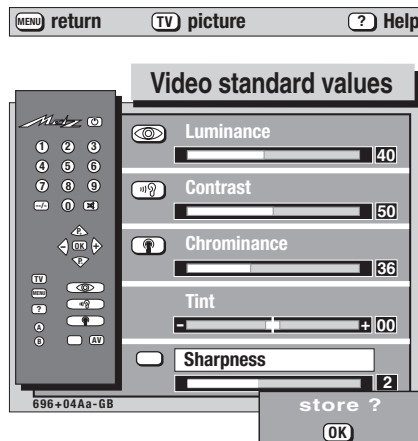
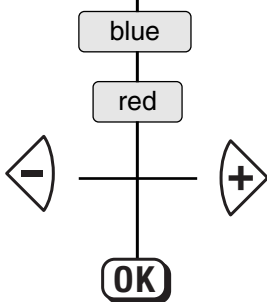

Luminance, contrast, chrominance, tint \* and sharpness can be adjusted in the „Video standard values“ submenu. Select the menu line with the value to be changed by pressing the assigned colour keys.

The picture sharpness can be set as the standard value for all programme positions in the menu „Video standard values“. The new value can be saved by pressing the **OK** key.

The volume, treble, bass and balance settings, as well as the headphones volume, can be adjusted in a similar manner in the „Audio standard values“ submenu.

The menu item „colour balance“ is displayed only when receiving from an NTSC station.

Adjust the desired value with the **←** **→** keys.

If no other video standard values or audio standard values are to be changed, then press the **OK** key to store the new setting.

## 3. Example 2: Call the „Audio standard values“ submenu. Adjust and store the volume.

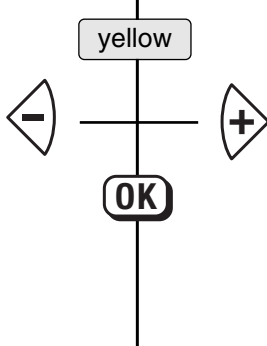

The red store box disappears when the **OK** key is pressed.

**The value set in this manner remains stored even if the TV is switched off with the main power switch.**

## 4. Return to TV picture



# 5. Equipment configuration

## Assigning the function keys

The remote control handset has three factory programmed function keys **A**, **B** and **C**. Press the **[?]** key in normal television mode to reveal the factory programming. The displayed Operator Help text describes the current programming in the last-but-one paragraph. This programming can be changed according to your requirements in conformity with the displayed selection. This choice is described in the „Glossary“ chapter.

**Example of programming function key B:** In TV mode, the **B** key is to activate the „subtitles“ function; in Hi Text mode, you can use it for the „page stop“ function.

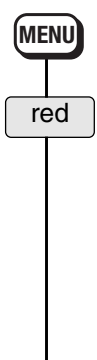
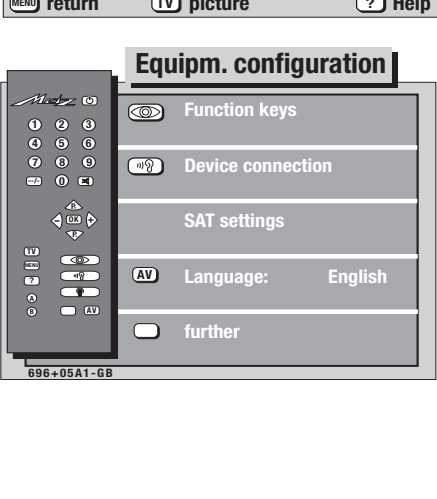
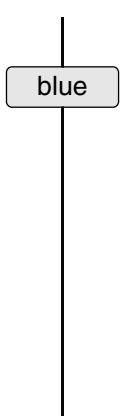
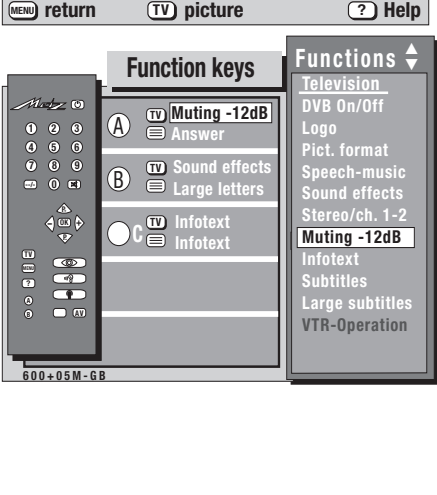
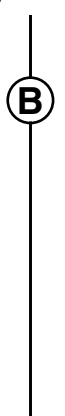
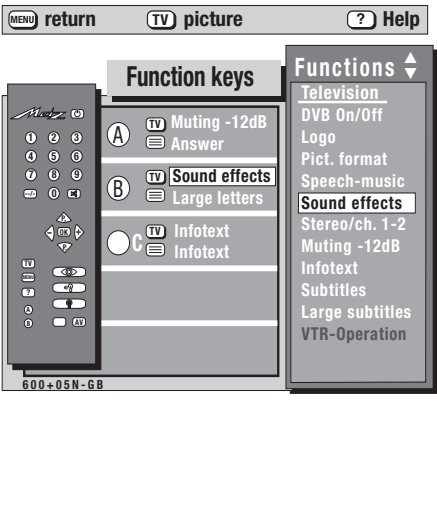
Press this key on the remote control....	The screen displays	Explanation
<p><b>1. Call the „Equipment configuration“ menu</b></p> 		
<p><b>2. Call the „Function keys“ menu</b></p> 		<p>The left-hand side of this menu shows the currently valid programming of the function keys.</p> <p>The window on the right-hand side indicates the selection that can be programmed.</p> <p><i>The individual functions are explained in detail in the „Glossary“ on page 50.</i></p>
<p><b>3. Press the function key to be programmed (in this example: B key)</b></p> 		<p>Two functions can be programmed for function key <b>B</b>. The upper line indicates the function programmed for TV mode, the lower line the function programmed for Hi Text mode.</p> <p>Press the <b>[TV]</b> key to switch between the two lines. Press the <b>B</b> key to display the currently programmed function.</p>



# 5. Equipment configuration

## Assigning the function keys

Press this key on the remote control....

The screen displays

Explanation

4. Select the function for TV mode (in this example „Subtitles“)

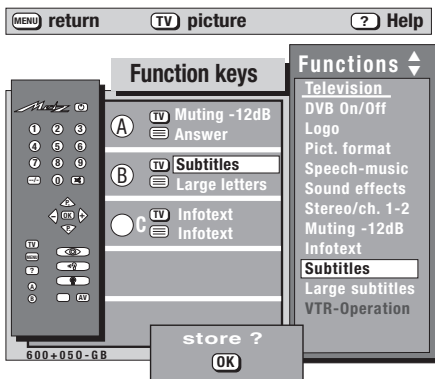
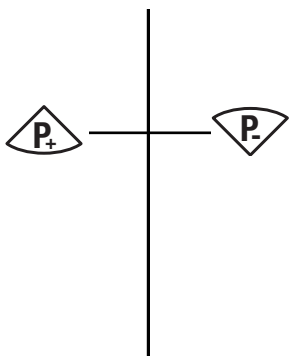

Select the function in the right-hand field with the  $\triangle$  or  $\nabla$  key. The text on the left-hand side changes as soon as the cursor (a white bar) is moved.

If the function „Subtitles“ has been programmed for key B, the subtitles will be displayed when the TV set is switched, if subtitles are actually transmitted with the programme.

5. Switch to Hi Text mode and program the function keys

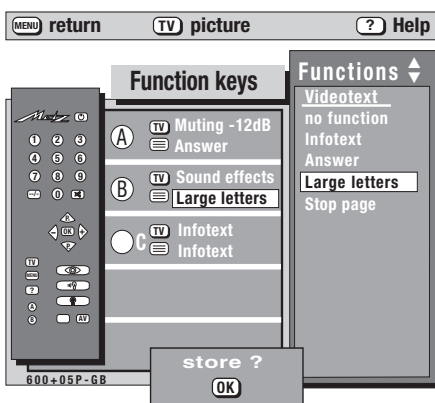
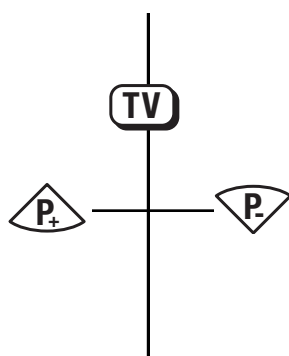

The cursor (a white bar) is now located in the second line, on the currently programmed function.

The desired Hi Text functions can now be programmed in the sequence described in steps 3 and 4, above.

6. Store the assignments and return to the „Equipment Configuration“ menu

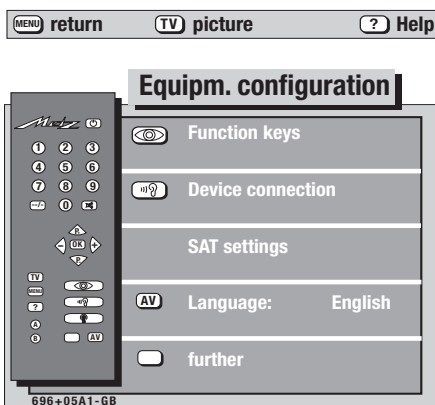

7. Return to TV picture



# 5. Equipment configuration

## Settings for programme change

Press this key on the remote control....

The screen displays

Explanation

### 1. Call the „Equipment configuration“ menu

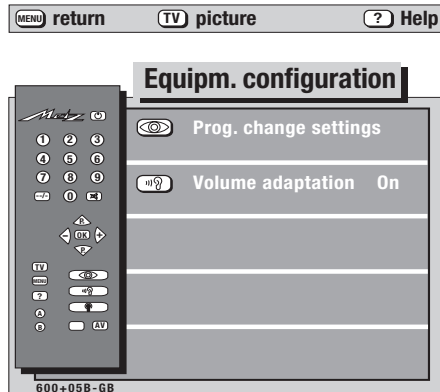
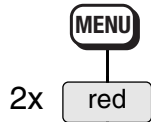

The various TV stations transmit the sound at different volumes. Some stations, for example, are always louder than others, and some stations increase the volume during the commercials.

If volume adaptation is active, these volume variations are smoothed out.

The setting selected here applies to all programme positions.

### 2. Call the settings for programme change

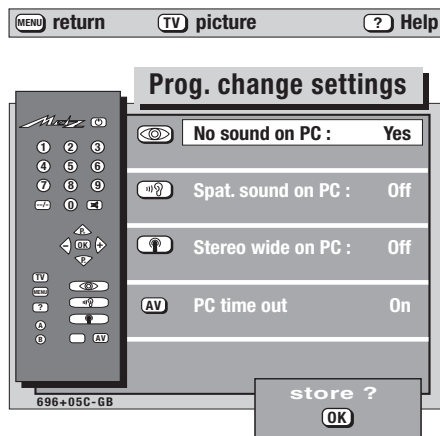
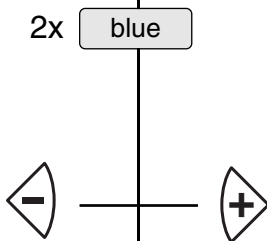

In this menu you can define the sound functions for a programme change.

In the first line of the menu, use the  $\leftarrow$   $\rightarrow$  keys to select whether the mute function is to be retained („Yes“) or to be cancelled („No“) when you change programmes.

The new settings can be stored by pressing the **OK** key.

### 3. Set spatial sound when changing programmes

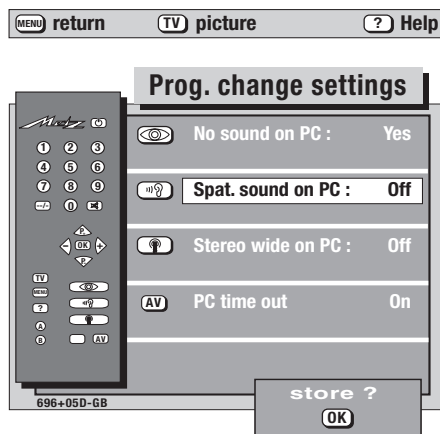
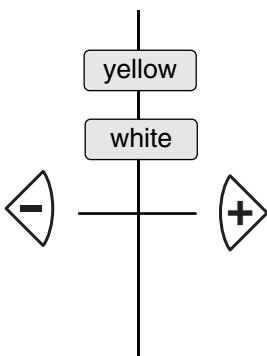

Use the  $\leftarrow$   $\rightarrow$  keys in this menu line to define whether the spatial sound is to be switched on or off when the programme is changed to a monaural station.

When in mono mode, you can change over to spatial sound by pressing a self-defined function key (sound effects).

If no other values are to be changed, then press the **OK** key to store the new setting.

The term „spatial sound“ is explained in the section „Glossary“ on page 50.

### 4. Set the PC „time out“

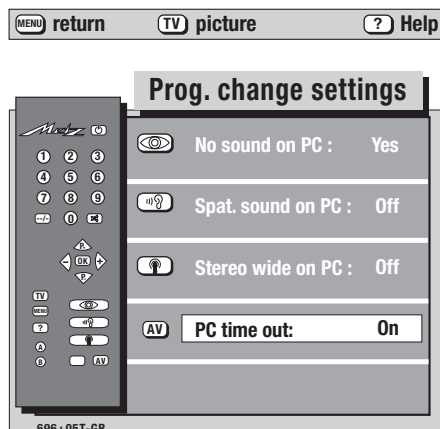
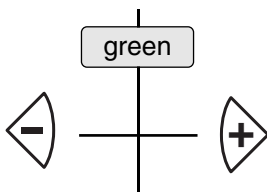

The programme change „time out“ can be set to On or Off.

**On** = the programme position changes three seconds after input of the first digit.

**Off** = after input of the first digit, further digits must be entered or the **OK** key must be pressed to change the programme position.

Select the setting **On** or **Off** with the  $\leftarrow$   $\rightarrow$  keys.

Store the new settings with the **OK** key

### 5. Store the settings and return to the TV picture

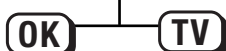





# 6. Volume adjustment and forced mono

It is possible for TV stations to be received at different volume levels although the volume level settings on the individual programme positions are identical. To overcome this problem, you can set a volume correction factor for each programme position.

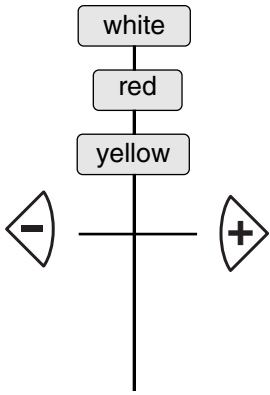
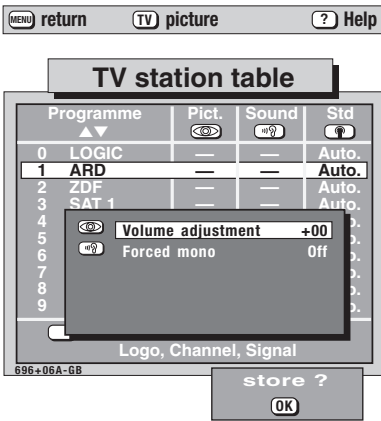
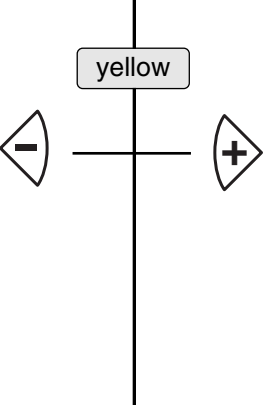

**Example:**

Programme 1 is soft: volume value 40. Programme 3 is loud: volume value 40. Programme 1 is to be adjusted to the same volume as Programme 3. **Switch over to programme position 1.**

Press this key on the remote control....	The screen displays	Explanation
<p><b>1. Call the sound submenu and adjust the volume</b></p> 		<p>In this submenu, you can assign a volume correction factor to a programme position and, if necessary, activate forced mono sound mode.</p> <p>A volume correction factor can be set with the <math>\leftarrow \rightarrow</math> keys when the text is displayed on a blue background.</p> <p>Press the <math>\rightarrow</math> key to enter a positive correction factor which is added to the standard volume value (increasing the volume). Press the <math>\leftarrow</math> key to enter a negative correction factor which is subtracted from the standard volume value (decreasing the volume).</p> <p><b>In our example:</b> Press the <math>\rightarrow</math> key and increase the volume until it is the same as the volume on Programme 3. The resulting correction factor could, for example, be displayed as 05.</p>
<p><b>2. Set forced mono</b></p> 		<p><b>It may happen that the TV set inadvertently switches from mono to stereo during a transmission, although no stereo programme is being received. This usually depends upon the prevailing reception conditions.</b></p> <p>Use the <math>\leftarrow \rightarrow</math> keys to select forced mono.</p> <p>If this setting is stored, all transmissions received in this programme position will always be reproduced in mono.</p>
<p><b>3. Store the setting and return to TV picture</b></p> 		<p>All changed settings are stored.</p>

# 6.1 Correcting picture deviations

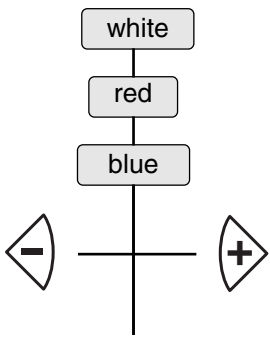
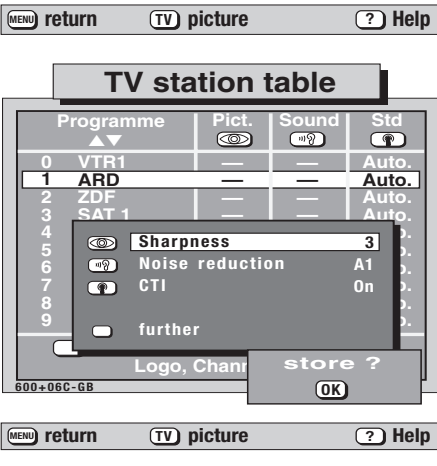
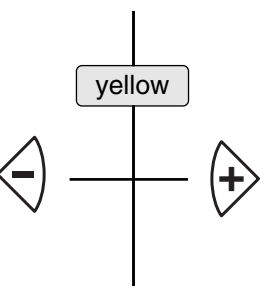
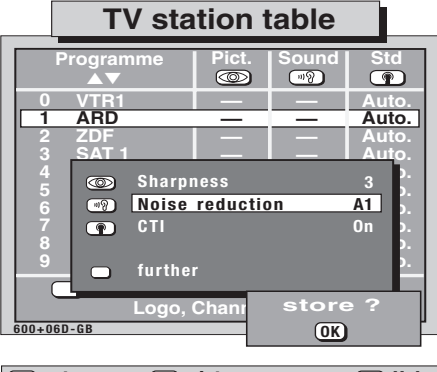
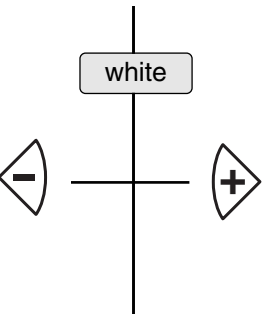
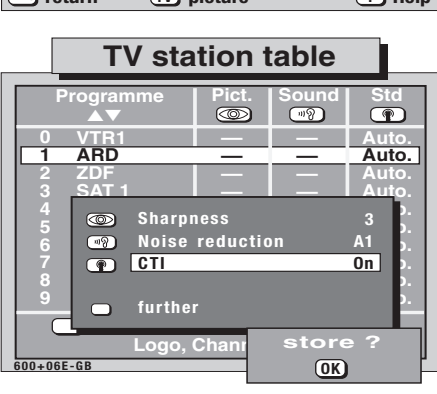
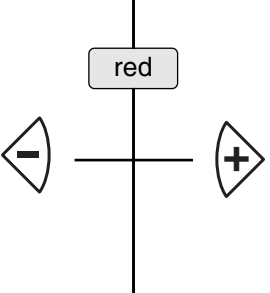
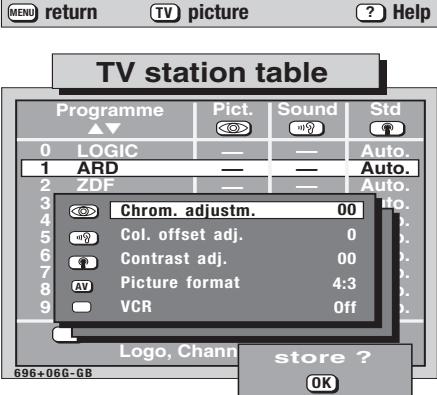
It is possible for stations to be received with differing levels of chrominance, picture sharpness and contrast, even though the settings on the individual programme positions are identical. For this reason, your TV set enables you to correct the value for each programme position and/or to select a picture correction function (CTI, noise reduction).

Press this key on the remote control....	The screen displays	Explanation
<p><b>1. Call the first picture menu in the station table and correct the picture sharpness</b></p> 		<p>The picture menu contains all settings which can change the picture.</p> <p>The picture sharpness can be adjusted separately for each station in the station table. This setting overrides the standard setting.</p> <p>The new value can be saved by pressing the <b>OK</b> key.</p> <p>The value set in this manner remains stored even if the TV is switched off with the main power switch.</p>
<p><b>2. Switch on the noise reduction</b></p> 		<p>This TV set is equipped with a special noise-reduction function for use where the picture contains „snow“ or is unclear. The noise reduction function can be set to</p> <p><b>A1:</b> automatic motion compensation, slight noise reduction</p> <p><b>A2:</b> automatic motion compensation, high noise reduction,</p> <p><b>A3:</b> no motion compensation, slight noise reduction),</p> <p>or <b>OFF</b>.</p>
<p><b>3. Switch on the CTI function</b></p> 		<p>CTI stands for Colour Transient Improvement and improves the transitions between different coloured areas of the picture, making the picture appear much sharper. The CTI function is effective for both transmissions received by way of the aerial input and for signals received via the AV sockets. CTI also provides a visible improvement when playing back from a video recorder.</p> <p>However, in certain applications (such as playing back from an S-VHS video recorder), the CTI function may just have the opposite effect.</p> <p>When playing back from such recorders, CTI can result in a lower-quality picture. For this reason, this menu permits you to switch off the CTI function for specific programme positions.</p>
<p><b>4. Call the second picture menu and adjust the chrominance</b></p> 		<p>In this second picture menu, the chrominance, colour offset and contrast can be corrected individually for each programme position.</p> <p>In our example, the chrominance of Programme 1 is to be diminished. Hold down the  key until the colour intensity is the same as in programme position 3.</p> <p>The chrominance adjustment range is -15 to +15.</p> <p>If no other values are to be changed, then press the <b>OK</b> key to store the new setting.</p>

# 6.1 Correcting picture deviations

Press this key on the remote control....

The screen displays

Explanation

## 5. Adjust the colour offset or contrast

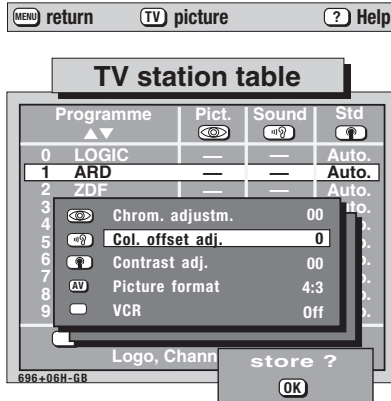
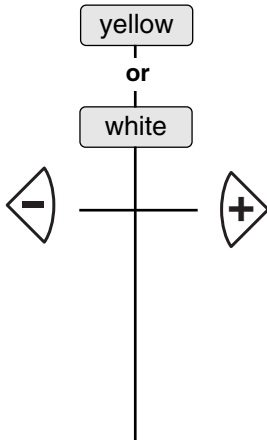

Normally, it is not necessary to adjust the colour offset.

However, if external units are connected it is possible that colour and black-and-white pictures are not accurately superimposed. A similar effect is sometimes encountered in journals when the black-and-white and colour impressions do not register, with the result that the contours are blurred. The colour offset adjustment has no effect on an RGB input.

The contrast adjustment range is -15 to +15.

If no other values are to be changed, then press the **OK** key to store the new settings.

## 6. Change the picture format

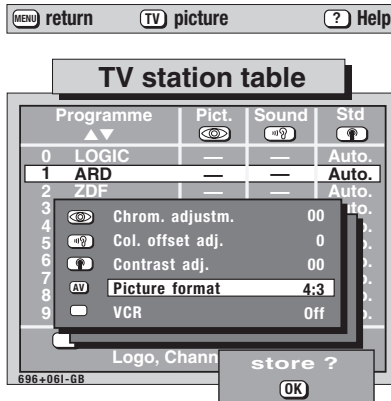
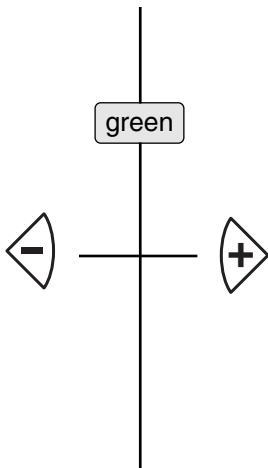

The picture format of a normal TV set is 4:3. If an input signal in 16:9 format is applied to the EURO socket, the picture format is changed automatically. If a 16:9 input signal is applied to the phono (cinch) sockets or the mini-DIN (YC) socket, the picture format must be changed manually.

An external switching voltage of 4-7 V at the EURO socket automatically switches the TV to 16:9 format, provided that the signal type was stored under the heading „...controls AV operation“ in the menu „Equipm. configuration, device connection“.

## 7. Store all settings and return to TV picture

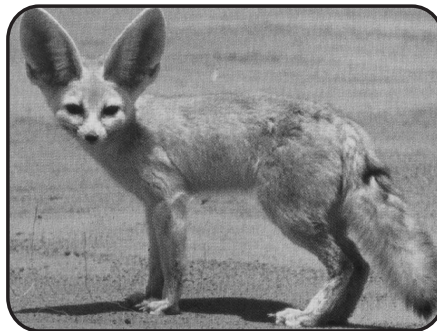
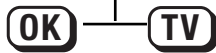

# 7. AV recording

Camcorder → video recorder

In the „AV recording“ menu, you can define which of the connected peripheral AV devices are to be used for copying a recording.

**AV device** is a generic term for all external video units, such as video recorders, camcorders, video disk players, photo CD players, etc which can be connected to a TV.

**Example:** You wish to copy a film recorded with an S-VHS/Hi8 camcorder to an LogicVTR video recorder which is also connected to the TV set.

Press this key on the remote control....	The screen displays	Explanation
1. Call the AV menu		<p>In the „AV recording“ menu , you can select how the AV devices connected to your TV set (see Section 14, „Equipment configuration/Connecting external devices“) are to be used for copying a recording.</p> <p>The left side of the menu (Input) shows the devices which supply picture and sound for the copy operation. Selection of an input for a programme is meaningful only for SAT or decoder operation.</p> <p>The right side of the menu (Output) shows the devices capable of recording the picture and sound.</p>
2. Select the desired AV devices (in this example: Camcorder and LogicVTR)		<p>After calling this menu, you must first select the input device, i.e. the device which is to supply the picture.</p> <p>After selection of an input, the menu automatically returns to the output page, where the AV device for recording is selected.</p> <p><b>Back to the example:</b> You want to copy the film from the camcorder to Logic VTR. Press the blue key to display the signal from the camcorder on the screen.</p>
3. Store the settings and clear the menu		<p>The copy operation with the selected devices is now active.</p> <p>If any subsequent switching operations could interfere with copying, a warning box with the text „AV recording“ will be displayed and the requested switching operation will not be executed.</p>
4. Terminate or abort the copy operation		<p>To check the progress of the operation, press the (AV) key to display the picture from the input device on the screen.</p> <p>If you wish to execute the copy operation <b>in standby mode</b>, you can switch the TV set to this mode by pressing the (TV) key.</p> <p>If this setting is not stored, the programme position must be selected again in order to display the TV programme.</p>

# 7. AV recording Video recorder → video recorder

**Example:**

You want to play back a film from the logic video recorder connected to the EURO 2 socket and record it on the video recorder 2 connected to the EURO 1 socket.

Press this key on the remote control....	The screen displays	Explanation
--	---------------------	-------------

1. Call the AV menu

AV



2. Select the desired AV device (in this example: LogicVTR)

yellow

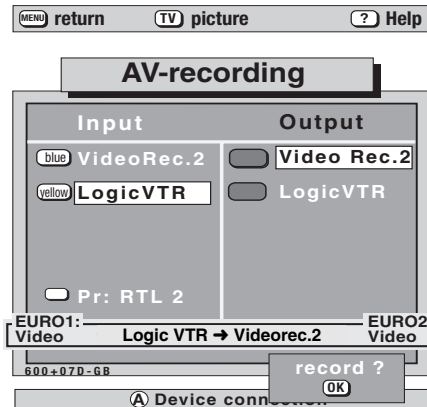

After calling the menu, you must first select the input device which is to supply the picture. In our example, you select Logic VTR by pressing the yellow key.

Once you have done this, the cursor moves to the output side of the menu and the logic video recorder is selected automatically, since there is no other choice.

3. Store the settings and clear the menu

OK

TV



The copy operation with the selected devices is now active.

If any subsequent switching operation could interfere with copying, a warning box with the text „AV recording“ will be displayed and the requested switching operation will not be executed.

To check the progress of the operation, press the AV key to display the picture from the input device on the screen.

4. Terminate or abort the copy operation

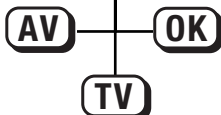

TV picture

If you wish to execute the **copy operation in standby mode**, you can switch the TV set to this mode by pressing the TV key.

# 8. Time settings









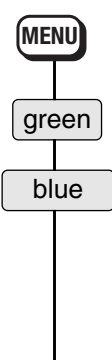
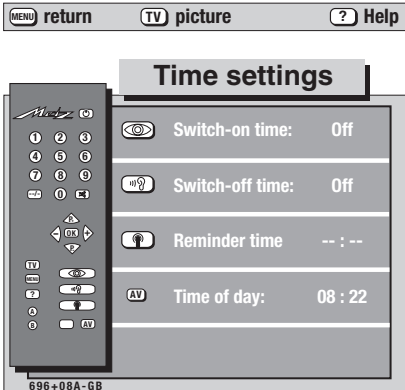
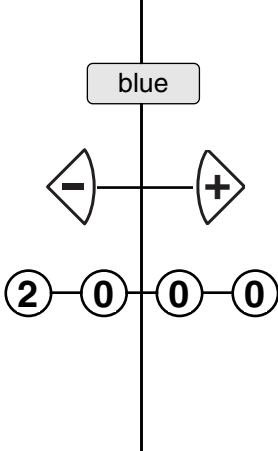

Switch-on/off and reminder time

In the „Time settings“ menu, you can enter settings which will instruct the TV to switch itself on or off, and to display a reminder at a given time.

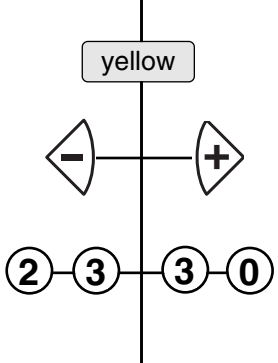
**Switching from summer time to winter time and vice versa is carried out automatically by the teletext clock or when the set is switched from standby mode to programme position 1.**

The switch-on time function will automatically turn on the TV at the preset time if the television is in standby mode. The switch-off time function will automatically switch it off as desired. The reminder service is intended to help you remember things which you have to do later on, for instance a telephone call. All three settings can be jointly programmed.

**Example:** The TV is to switch itself on at 20:00 hr, remind you of something at 21:45 hr, and switch itself off at 23.30 hr.

Press this key on the remote control....	The screen displays	Explanation
<p><b>1. Call the „Time settings“ menu</b></p> 		<p>The adjoining picture shows the appearance of the „Time settings“ menu when no times have been programmed.</p>
<p><b>2. Enter the switch-on time (Example: 20.00 hr)</b></p> 		<p>First press the blue key and then press the  or the  key to switch on the function.</p> <p>Enter the desired switch-on time with the numeric keys. The function is activated after input of the last digit. Henceforth the TV set will switch itself on every day at the preprogrammed time.</p> <p>When switched on, the TV displays the programme position which was selected when it was last switched off. The screen displays <b>On - -</b>.</p> <div style="border: 1px solid black; padding: 5px; margin-top: 10px;"> <p><b>When the set has switched itself on automatically, you must press any key you choose on the remote control, otherwise the set will return to standby mode after about 10 min. This is a safety precaution to ensure that the television does not stay on if you are not at home.</b></p> </div>
<p><b>3. Enter the switch-off time (Example: 23.30 hr)</b></p> 		<p>If you press the yellow key, the text in the second line is displayed on a yellow background.</p> <p>Now press the  or the  key to switch on the function.</p> <p>Enter the desired switch-off time with the numeric keys. The function is activated after input of the last digit.</p> <p>The switch-on/switch-off times can be deleted with the   keys (function <b>OFF</b>).</p>



# 8. Time settings

## Switch-on/off and reminder time

Press this key on the remote control....

The screen displays

Explanation

### 4. Enter the reminder time (Example: 21.45 hr)

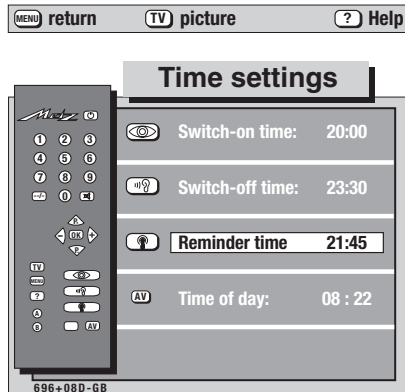
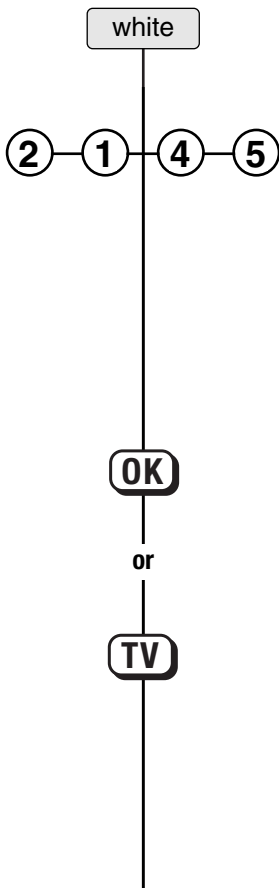

If you press the white key, the text in the third line is displayed on a white background.

Enter the desired reminder time with the numeric keys. The function is activated after input of the last digit.

From the standby mode, the TV set will switch itself on at 20.00 hr, remind you of the telephone call you wish to make at 21.45 hr, and switch back to standby mode at 23.30 hours.

The reminder time can be deleted with the **C** key.



At the programmed time, a box with the text „Hallo“ is displayed on the screen if the TV set is switched on.

This box disappears if you press the **OK** or **TV** key or switch to a different programme position.

### 5. Enter the time manually (Example: 14.24 hr)

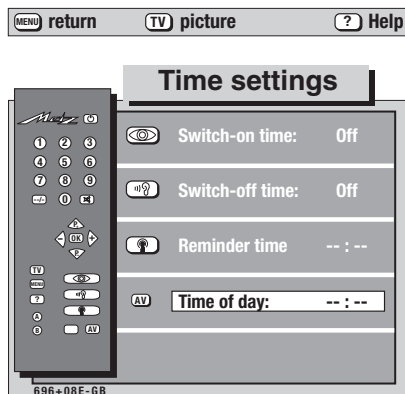
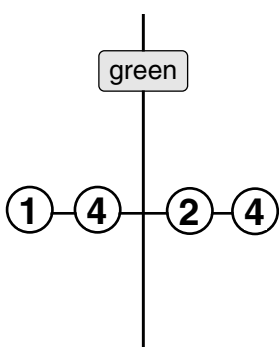

If you switch to a programme position in which teletext has been stored, the current time automatically appears in this menu ..

To set the clock manually, simply enter the time with four digits.

### 6. Switch to standby mode



**TV picture**



# 8.1 Childlock

## Switching on

Your TV set can be protected against unauthorized use. It is possible to prevent any use of the television at all or to permit viewing of up to five specific programmes. Consequently, the childlock can be set to prevent a child from seeing violent films, yet still provide access to children's programmes on selected channels. Access to such permitted programmes can be provided in general or within a specified period of time.

### Example:

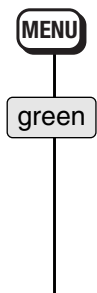
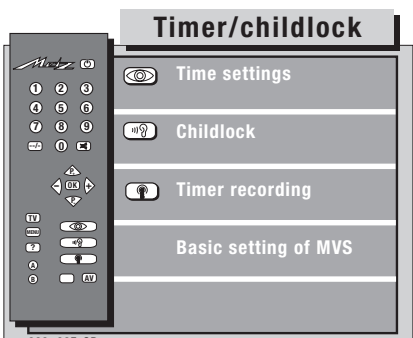
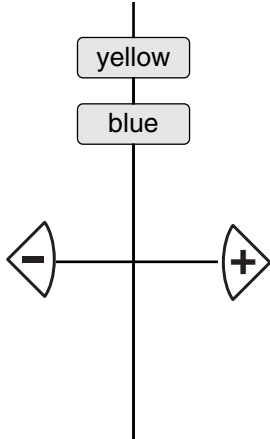
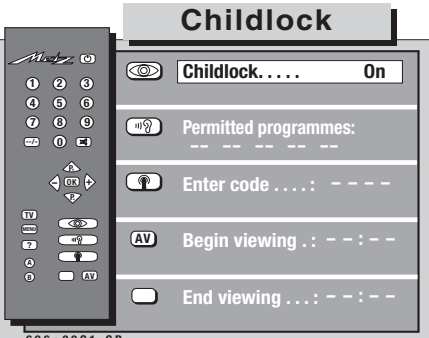
The children shall only be allowed to watch programmes on the programme positions 01, 02 and 05 from 14.00 to 18.00 hr. Access to all other programme positions shall be excluded.

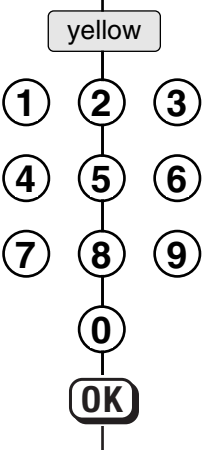
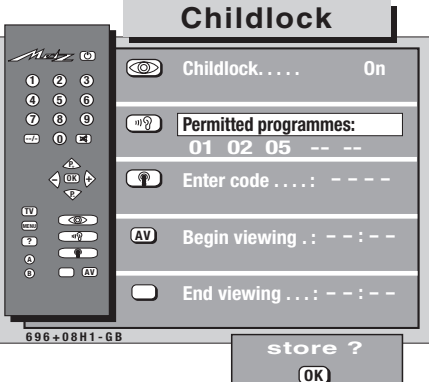
Press this key on the remote control....	The screen displays	Explanation
<p><b>1. Call the „Timer/childlock“ menu</b></p> 		
<p><b>2. Call the „Childlock“ submenu and switch on the childlock</b></p> 		<p>The childlock can be switched on and off with the  keys.</p> <p>If you set the childlock to „ON“, you must also enter a 4-digit personal code number.</p> <p>The TV set can now still be switched on, but programmes will not be shown on the screen. Instead the „Childlock“ menu will be displayed with the cursor on the „Enter code“ line.</p> <p>The childlock can be turned off again by entering the 4-digit personal code number.</p> <p>The TV is automatically switched to standby mode after approx. 10 minutes if it has not been switched off manually in the meantime.</p>
<p><b>3. Select and store permitted programmes</b></p> 		<p>A maximum of 5 programme positions can be entered to which access is permitted.</p> <p>These programme positions are entered with the numeric keys; all entries can be erased with the <b>C</b> key.</p> <p><b>Back to the example:</b></p> <p>Enter the programme positions which are to be accessible. In this example, the programme positions 01, 02 and 05 have been entered.</p> <p>Before continuing with the next programming steps, the permitted programme positions entered above must be stored; otherwise the entries will be lost.</p>

# 8.1 Childlock

Switching on

Press this key on the remote control....

The screen displays

Explanation

## 4. Enter your personal code

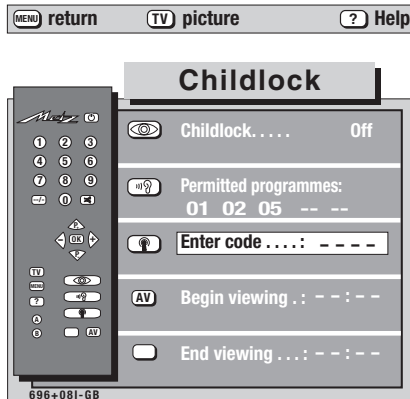
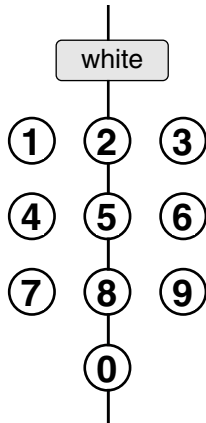

Enter your personal 4-digit code at this point.

The digits are entered with the numeric keys. The entered code number is NOT displayed!

**Ask your local dealer for help if you have forgotten your personal code number.**

## 5. Enter the beginning and end of the viewing period

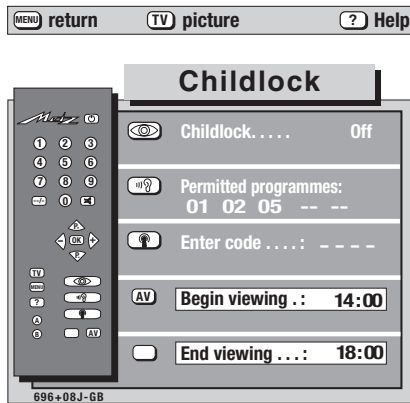
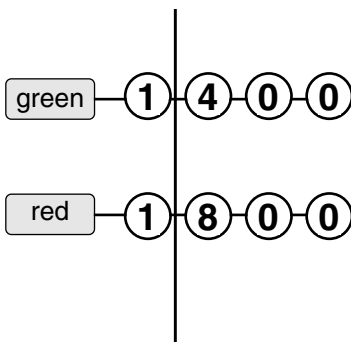

Here you can enter the times between which viewing of the permitted programmes is allowed.

The TV is not automatically switched on at the beginning of this period; it is, however, automatically switched off at the end of it.

If no permitted programmes have been entered all TV transmissions within this period can be viewed.

## 6. Activate the childlock

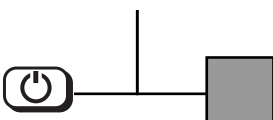

The childlock is activated when the set is switched off with the key or with the ON/OFF key.

# 8.1 Childlock

Switching off

Call the TV menu and enter your personal code

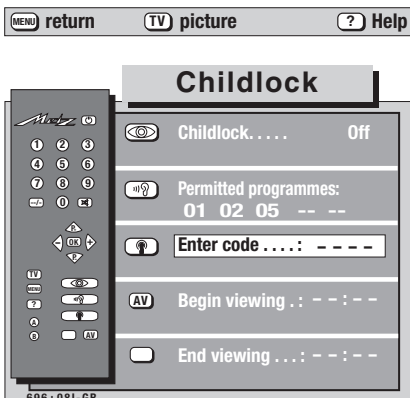
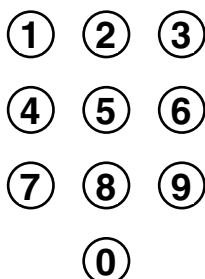

Entry of the personal code number switches off the childlock and the selected programme is displayed on the screen.

**Ask your local dealer for help if you have forgotten your personal code number.**

## 8.2 Recording with the timer

The menu "Timer recording" is intended primarily for recording Pay-TV programmes (e.g. Premiere). When using a Metz video recorder with „Data Logic“ you can also record SAT programmes\* with this menu. For this purpose, the video recorder must be connected to the EURO 2 socket.

\*only if a SAT upgrade kit is fitted

**8 timers can be programmed up to 2 months in advance.**

**Example:** A VHS video recorder with Data Logic is connected to the EURO 2 socket of the TV, while a Pay-TV decoder (e.g. Premiere) is connected to the EURO 1 socket. You now wish to record a film running on a Pay TV channel.

Press this key on the remote control....	The screen displays	Explanation
<p><b>1. Call the „Timer recording“ menu</b></p> <p>MENU green white</p>		<p>If no timers have been programmed before, the table in the menu is empty. If you have previously programmed timer recordings, these will be displayed in the table.</p> <p>The current time of day and the current date are needed for programming in the timer menu. The time is normally obtained from the Hi Text function and the date from the VPS signal. Note that some stations do not transmit VPS signals and/or Hi Text.</p> <p><b>If the time and/or date are not detected automatically, you must enter them manually.</b></p>
<p><b>2. Enter the date and time of the film to be recorded (see example)</b></p> <p>1 2 3 4 5 6 7 8 9 0</p>		<p><b>Timer recordings are not possible if the childlock is switched on.</b></p> <p>The month, the day, the hours and the minutes must each be entered in the form of two digits, e.g. 01.09 for September 1 and 09:00 for 9 AM.</p> <p>If you make a mistake when entering the date and time, you can delete the entry in the current column or the entire line by pressing the <b>C</b> key. The entire line can be deleted only if the key symbols at the top of the menu are displayed in colour.</p> <p>In the column "VTR", which can be selected only if a video recorder with "Data Logic" is connected, one of the following settings can be selected with key <b>A</b>:</p> <ul style="list-style-type: none"> <li>— No timer data are transferred to the video recorder. The video recorder must be programmed manually.</li> <li>LV <sup>1)</sup> If a "Data Logic" video recorder is connected.</li> </ul> <p><sup>1)</sup> A "Data Logic" video recorder will not function automatically without "LV" and must be programmed manually.</p>
<p><b>3. Store the programmed data and return to the TV picture or standby mode</b></p> <p>OK TV or [Power]</p>		<p><b>The recording can be aborted at any time by pressing the keys AV, OK and TV sequentially, in this order, or by pressing the C key with the timer menu displayed.</b></p> <p><b><i>This does not apply to video recorders with data transfer!</i></b></p> <p>The same data must also be entered on the AV programme position of the video recorder or on a programme position where the video recorder does not receive a station.</p>

# 9. Connecting headphones

Headphones can be connected to the TV by way of the connecting socket underneath the fascia cover at the front. The socket will only accept headphones with a 3.5 mm jack plug.

We recommend the use of headphones with an impedance of at least 32 Ohms. Headphones of a lower impedance (down to approx. 8 Ohms) will impair the sound quality.

The headphones volume can be stored as a standard value. The headphones and the TV speakers can be used together.

In the event of 2-channel sound transmissions it is possible to listen to either channel 1 or 2 on the headphones, irrespective of the channel set for the TV speakers.

## 9. Headphones

### Volume

Press this key on the remote control....

The screen displays

Explanation

1. Switch off the TV speakers and adjust the headphones volume

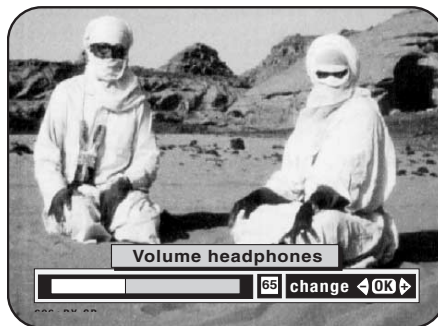
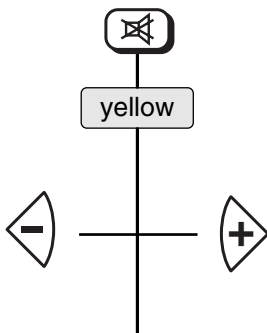

It is advisable to switch off the TV speakers with the key when adjusting the volume for the headphones.

Press the yellow key to display the bar for the headphones volume.

Adjust the volume with the keys.

2. Store the headphones volume as a standard value

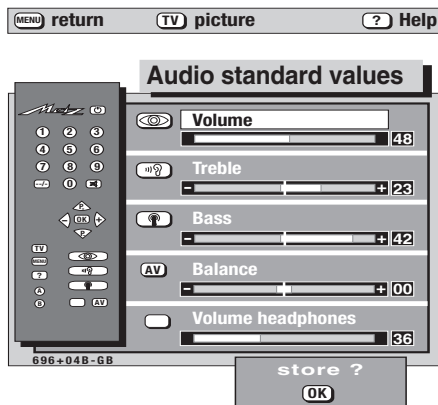
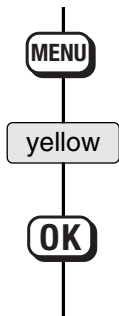

The standard value for the headphones volume can only be stored by way of the TV menu.

All standard values can be stored in the „Audio standard values“ submenu.

The volume has already been adjusted (see step 1).

It is now only necessary to press the key to store the headphones volume.

3. Return to TV picture



TV picture

Sound mode selection for headphones

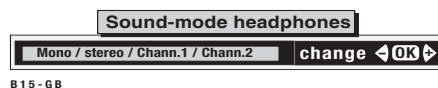

With two-channel sound transmissions it is possible to select either channel 1 or channel 2.

If headphones are connected, it is possible to listen, for example, to the English sound track on the speakers (channel 1) and to the other language on the headphones (channel 2).

This setting can also be called with the sound mute active by pressing the yellow key. The desired channel can then be selected with the .

# 10. Hi Text



## Basic functions

Hi Text permits broadcasting stations to improve the display of information and graphics. In the past, there were only eight colours available; with Hi Text, there are 4096 possibilities.

Furthermore, the introduction of so-called pixel graphics makes it possible to present the information pictorially. The broadcasting stations are currently in the process of adopting these innovations.

We have implemented Hi Text in your TV set in such a manner that you can switch it on and off as desired. Pressing the **-/--** key switches from Hi Text to Megatext or vice versa.

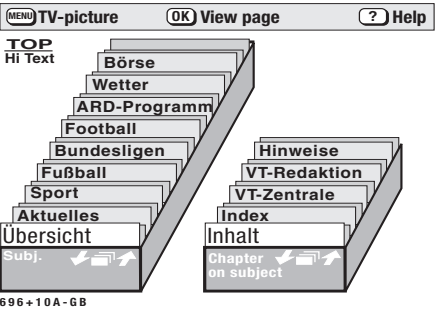
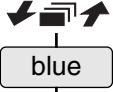
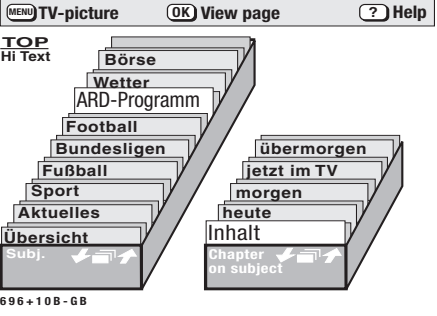
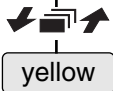
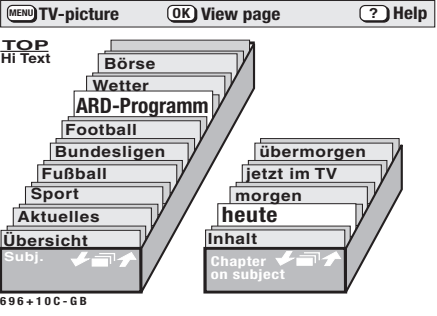
The currently selected mode („Megatext“ or „Hi Text“) is displayed at the top of each page.

Press this key on the remote control....	The screen displays	Explanation
<p><b>1. Call Hi Text</b></p> 		<p>The Hi Text file displays all the subjects available on a specific programme position and the chapters belonging to the currently selected subject.</p> <p>The range of subjects and chapters depend on the transmitting station and can therefore be completely different in each programme position.</p> <p>For some stations, for example, only numbers, rather than the header lines, appear in the Hi Text file.</p>
<p><b>2. Select a subject</b></p> 		<p>Each time the blue key is pressed, the next subject is selected and the corresponding file card is raised. Prolonged depression of the blue key raises all of the subjects sequentially.</p> <p>Press the right side of the key to step backwards through the subjects, or the left side of the key to step forwards.</p> <p>The displayed choice of chapters is adapted to the currently selected subject.</p>
<p><b>3. Select a chapter</b></p> 		<p>Each time the yellow key is pressed, the next chapter is selected and the corresponding file card is raised.</p> <p>Press the right side of the key to step backwards, or the left side of the key to step forwards.</p> <p>Prolonged depression of the yellow key raises all the chapters sequentially.</p>
<p><b>4. Open the first page of the chapter</b></p> 		<p>The first page of the selected subject and chapter is displayed.</p> <p>File symbols with arrows in the bottom line indicate that the corresponding coloured keys will activate subject-by-subject, chapter-by-chapter or page-by-page leafing.</p> <p>The blue text window shows the name of the currently selected subject, while the yellow shows the name of the currently selected chapter.</p>

# 10. Hi Text

## Basic functions

Press this key on the remote control....

The screen displays

Explanation

### 5. Page-by-page paging

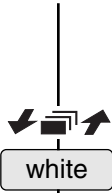

This function enables you to run through the individual pages. Just as in a book, you can leaf forwards or backwards from the displayed page.

Press the right side of the key to step backwards, and the left side of the key to step forwards.

### 6. Chapter-by-chapter paging



This function enables you to run through the individual chapters.

Each time you press the yellow key, the first page of the next or previous chapter is opened.

Press the right side of the key to step backwards, and the left side of the key to step forwards.

### 7. Subject-by-subject paging



Each time you press the blue key, the first page of the next or previous subject is opened. In most cases, this will be an index page.

Press the right side of the key to step backwards, and press the left side of the key to step forwards.

# 10. Hi Text

## Multiple pages

Press this key on the remote control....

The screen displays

Explanation

### 1. Recognizing multiple pages



Multiple pages are indicated by a dark bar with the subpage numbers on the left-hand side of the displayed page.

The bright numbers indicate the number of subpages contained in this multiple page. The number of subpages is transmitted by the stations at intervals of 20 seconds. Consequently, it may take some time until all subpage numbers are displayed.

If there are more than 5 subpages, the cursor (white bar) can be moved to the right with the  $\blacktriangleright$  key to display the next group of subpage numbers (for example 01 to 11).

Some stations do not provide multiple page identification; in this case, the subpages are displayed sequentially. To stop a page for reading, one of the **A** or **B** function keys must be programmed with the „Stop page“ function in Hi Text mode. Renewed depression of the „Stop page“ function advances to another subpage (the one the station is currently transmitting).

### 2. Selecting subpages

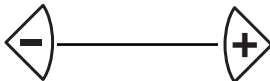

Use the  $\blacktriangleleft$   $\blacktriangleright$  keys to move the cursor (coloured bar) upwards and downwards through the page numbers. The page number highlighted by the cursor can be called directly with the **OK** key.

# 10. Hi Text

## Page selection by cursor

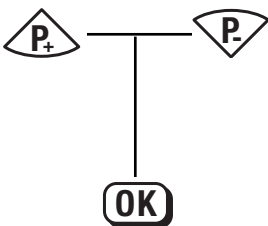

The cursor (coloured bar) can be moved up and down with the  $\blacktriangleup$  and  $\blacktriangledown$  keys. The page number on which the cursor is located can be called directly by pressing the **OK** key.



# 10. Hi Text

## Direct page selection

Press this key on the remote control....

The screen displays

Explanation

1. Enter the page number  
e.g. page 589

5 8 9



After depression of the first numeric key, the number of this key, followed by two hyphens, appears at the top left of the screen. Enter the complete 3-digit number. A green line with the text „Wait for page ...“ is displayed at the top of the screen after the last digit has been entered. A red line with the message „Page is not transmitted“ is displayed if the entered page number does not exist. Otherwise the TV searches for the specified page and displays it as soon as it is located.

# 10. Hi Text

## Return to last index page

Return to last index page

0



Press the 0 key to return to the last index page.

The adjoining picture shows the index page of the ARD channel as an example.

# 10. Hi Text

## Topical or news-flash pages

Suppressing news-flash pages

white

TV



Some stations transmit Teletext pages with news flashes, general information, football results, etc.

Once you have selected such a page and hidden it by pressing the TV key, the page will be displayed again whenever it is updated by the TV station.

# 10. Hi Text

## Doubling the font size

Press this key on the remote control....

The screen displays

Explanation

1. Select double font size, e.g. press the B\* key

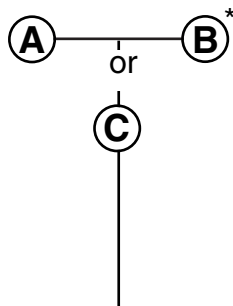

When the B\* key is pressed for the first time, the upper part of the selected page is displayed with the font size doubled.

You can scroll slowly through the page by holding down the key.

\* The B key was programmed in the factory for this function, but this programming can be changed (see Section „Equipment configuration - Assigning the function keys“).

2. Scroll the page upwards, e.g. press the B\* key

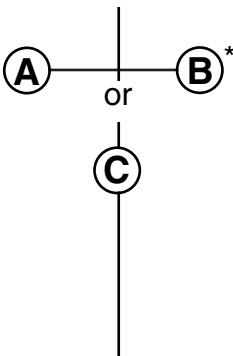

When the B\* key is pressed for the second time, the displayed page is scrolled upwards.

3. Scroll the page further, e.g. press the B\* key

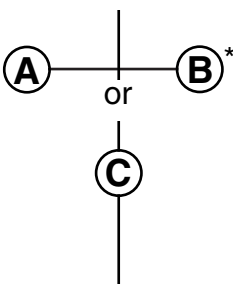

When the B\* key is pressed for the third time, the displayed page is scrolled further, and so on.

4. Return to normal font size

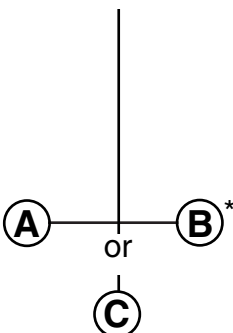

Press the B\* key for a fifth time to return to normal font size.

\* Depending on the assignment of the function keys. The factory setting is B.



# 10. Hi Text

## Setting marks

There will be certain Hi Text pages, e.g. stock market, news, weather forecast, etc., that you will want to read repeatedly. We have programmed a way of making it easier to read such pages: Hi Text pages can be flagged with the aid of marks (similar to tabs in a file).

**We provide a total of 100 marks. Up to 10 marks may be assigned to each programme position, as long as the total number of marks assigned does not exceed 100.**

You can set the marks on any desired pages and you can delete them again when they are no longer needed. If marks are set on a page, you can page from one to another by pressing the **green key** when HiText is active.

Press this key on the remote control....	The screen displays	Explanation
<p><b>1. Call the desired page</b> e.g. page 400</p> <p>④ ① ①</p>		
<p><b>2. Set the first mark</b></p> <p>red</p>		<p>If marks have not yet been set in this programme position, then press the key to set the 1st mark.</p> <p>„MARK 1“ is displayed at the top lefthand corner of the screen.</p>
<p><b>3. Select the next page</b> e.g. 589</p> <p>⑤ ⑧ ⑨</p>		<p>In the ARD channel, for example, page 589 is a multiple page.</p> <p>On multiple pages, marks are always set on the main page.</p>

# 10. Hi Text

## Setting marks

Press this key on the remote control....

The screen displays

Explanation

### 4. Set the second mark

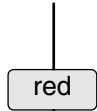

When the required page is displayed (in our example page 589), press the red key again to set the second mark.

„MARK 2“ is now displayed at the top left-hand corner of the screen.

### 5. Set further marks e.g. page 500

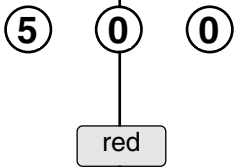

10 marks can be set on each programme position, as long as the total number of marks assigned does not exceed 100. See steps 1 - 4.

**If all of the 100 available marks have been used, the red dot in the title line of the menu changes to grey.**

### 6. Return to TV picture

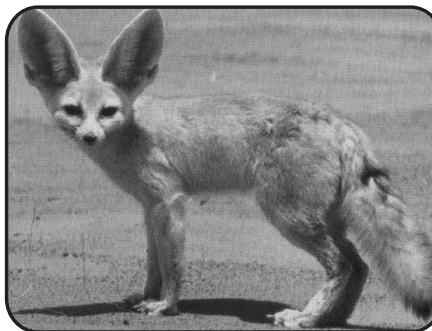





# 10. Hi Text

## Infotext (Mark by mark paging)

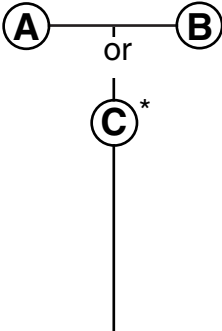
The basic idea of Infotext is that you can quickly retrieve and read pages which have previously been marked as described on the two previous pages of this manual. Once marks have been set, you can page through the related pages at any time by pressing a programmed function key

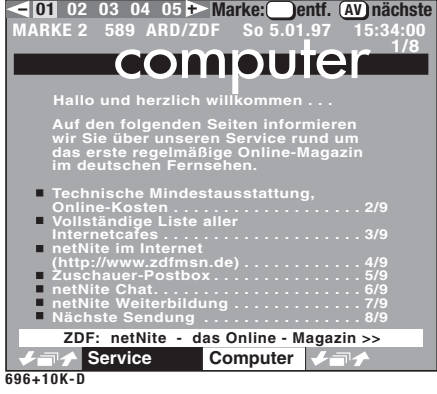
Once the marks have been set, you can step through all of the marked pages from the current TV programme by pressing a programmed key (key **C** is programmed in the factory for this purpose).

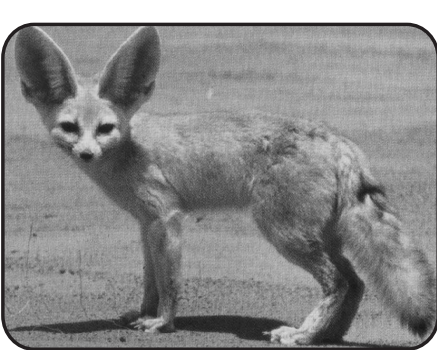
Press this key on the remote control....	The screen displays	Explanation
<p><b>1. From TV picture to the first mark</b></p> 		<p>After the C key has been pressed, a panel with „Mark 1“ will be displayed.</p> <p>On programme positions without a mark, a white field will be displayed with the text „No mark“.</p>
<p><b>2. Step forward to the next mark</b></p> 		<p>Each time the green key is pressed, you advance to the next mark. In this manner you can run through all pages on which marks are set.</p>
<p><b>3. Return to TV picture</b></p> 		<p>The <b>C</b> key will return you to the TV picture after having run through <u>all</u> marks.</p> <p>Press the <b>(TV)</b> key to return directly to the TV picture without having to page through all the marks.</p>

\* Depending on how the function keys are programmed. The factory setting is **C**.

# 10. Hi Text

## Erasing marks

Press this key on the remote control....

The screen displays

Explanation

1. Call the desired page  
e.g. page 400

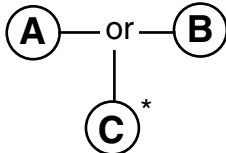

Press the C key to call the page where the mark is to be erased.

\* Depending on how the function keys are programmed. The factory setting is C.

2. Erase the mark

red

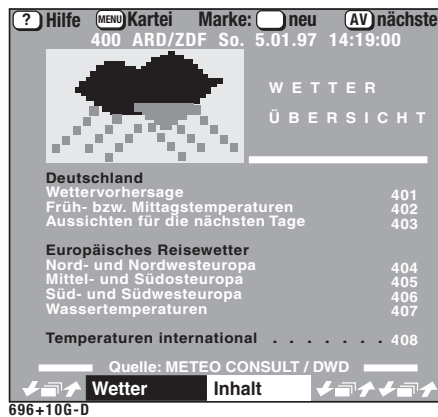

Erasure of the mark on the current text page changes the sequence of the remaining marks.

Example:

3 marks have been set in the current programme position:

- Mark 1 on text page 400
- **Mark 2 on text page 500**
- Mark 3 on text page 589

You now erase the mark 1 on text page 400.

The sequence of the remaining marks is immediately re-arranged and is now:

- Mark 1 on text page 500
- **Mark 2 on text page 589**

3. Return to TV picture

TV





# 10. Hi Text

## Subtitles

This TV enables you to display programme subtitles automatically.

For this purpose one of the three A, B or C function keys must be programmed on the remote control handset. Please refer to Section „**Equipment configuration - Assigning the function keys**“ for programming. The subtitles will only be displayed automatically after a function key has been programmed accordingly.

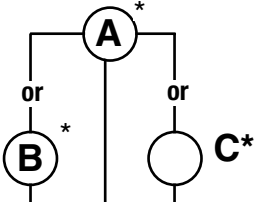
**Example:** You wish to watch the news with its subtitles. Program a function key with the „Subtitle“ function.

Press this key on the remote control....	The screen displays	Explanation
<p><b>1. Display of subtitles in the current programme</b></p> <p>automatic</p>		<p>The teletext transmitted by the station is superimposed on the picture at the bottom of the screen.</p> <p>The subtitle function can be activated or deactivated with the A*, B* or C* function key.</p>
<p><b>2. Blank out the subtitles*</b></p> 		<p>The subtitle function can be switched off and on again with the correspondingly programmed function key.</p> <p><b>Note:</b> If the subtitle function is programmed for one of the function keys, it will automatically be activated when the TV set is switched on.</p>

\* Depending on the assignment of the function keys

# 10. Hi Text

## Riddle solutions key

### Access to riddle solutions

Hi Text contains riddles with hidden answers.

The solutions to these riddles can be displayed with the A\*, B\* or C\* function key.

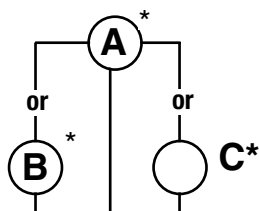

\* Depending on the assignment of the function keys.

# 11. Special picture effects

## Variable Zoom

All programmes that are not transmitted in the traditional 4:3 screen format, such as cinema films in Cinemascope or Super-Cinemascope or 16:9 format, have black bars at the top and bottom of the screen.

With the zoom function, you can increase the size of the picture and make the black bars disappear. Although this also causes part of the picture to move off the screen at each side, the resulting loss of information is slight and less disturbing than the black bars.

Press this key on the remote control....

The screen displays

Explanation

### 1. Switch on the zoom function and enlarge the picture





Press the  button until the black bars at the top and bottom of the screen have disappeared. The entire picture is enlarged uniformly.

The selected enlargement factor is automatically stored for this programme position as long as the TV set is not switched off. Switching to another station will restore the picture to its normal size. If you return to the station for which you activated the zoom function, the picture will be automatically enlarged if **the same programme** is still running.

### 2. Call the zoom function for the current programme position



If you wish to use the selected enlargement also for other programmes, press the  key again after setting the zoom factor with the  key. This returns the picture to its normal size, but stores the current enlargement factor for subsequent use.

### 3. Switch off the zoom function



If the TV set has been switched off with the remote control or the main switch, the stored enlargement factor can be recalled by pressing the  key twice.



# 11. Special picture effects

Still picture

Press this key on the remote control....

The screen displays

Explanation

## 1. Activate the still picture function

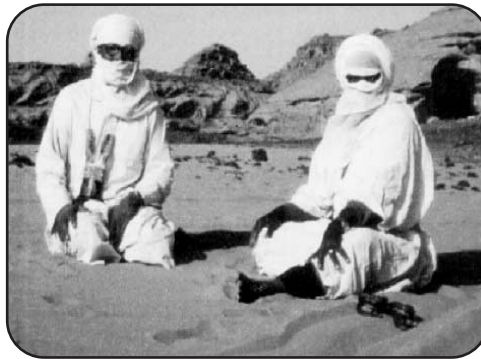

The current frame is „frozen“ on the screen when you press the II key. The TV programme (or the video film) continues to run in the background.

## 2. Deactivate the still picture function



Pressing the II key again switches back to the current programme (or video film).

# 12. Operation without remote control

This mode is only intended for an emergency when the battery in the remote control handset is flat, or if the remote control is not available.

**The TV controls are underneath a cover at the front of the set.**

You can control the following functions on the TV without the remote control handset. The function remains preselected for 10 seconds.

### Programme selection:

Press the - + keys.

### Volume:

Hold down the preselect key **F** until the bar display for the volume appears on the screen. Now press the - + keys to adjust the volume.

### Contrast:

Hold down the preselect key **F** until the bar display for contrast appears on the screen. Then press the - + keys to adjust the contrast.

# 13. Remote control handset for video recorders

Some of the basic functions of Metz video recorders can be controlled with the remote control unit. Point the remote control handset towards the video recorder when using it.

**!** In order to permit control of a video recorder, function key B for the TV level must be programmed to „VTR operation“ in the menu „Equipment configuration/Assigning the function keys“ on the TV set.

Whenever a key is pressed, an indicator on the remote control unit blinks.

**Nota:**

**!** Do not point the remote control unit into your eyes and press a key on it !

Do not use rechargeable batteries in the remote control unit.

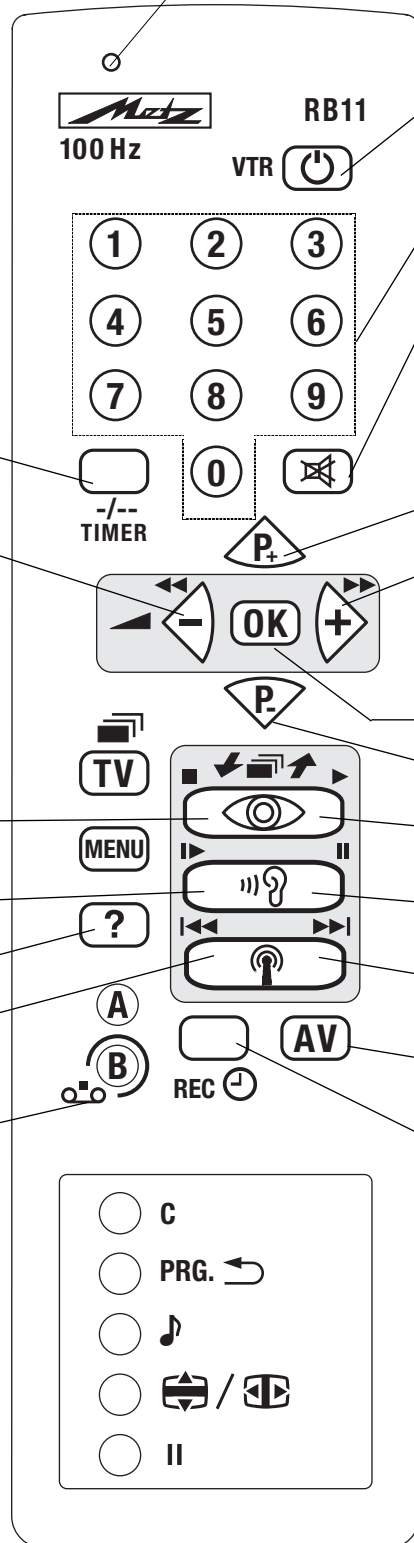

• Video recorder timer ON/OFF

• REW (rewind)  
From STOP: fast rewind  
From PLAY: picture search reverse

• Stop - Terminates playback or recording

• Slow-motion playback

• Operator help for video rec. operation

• Index - Video index search reverse

• To switch the remote control to video recorder mode:  
**Press and hold this key and press the desired function key.**

In order to permit control of a video recorder, function key B for the TV level must be programmed to „VTR operation“ in the menu „Equipment configuration/Assigning the function keys“ on the TV set.

• Video recorder On/OFF

• Programme position selection

• On video recorders with the data transfer facility, immediate recording of the programme currently displayed on the screen

1) Press the keys B and [VTR] together.

2) Press the keys B and [TV-REC] together.

• Next programme

• FF (fast forward)  
From STOP: fast forward  
From PLAY: picture search forward

• Stop

• Next programme

• Play - Start playback

• Still - Pause

• Index - Video index search forward

• Switch to AV mode AV 1, AV 2, ....

• REC - Start recording

**Batteries:**

Insert the enclosed batteries in the remote control, observing the symbols on the cover of the battery compartment. Remove exhausted batteries from the remote control and return them to your dealer or to an authorised battery collection point.

# 14. Connecting peripheral equipment

**Video recorders** can be connected to the TV set via the antenna socket or one of the EURO sockets. We recommend that you use one of the EURO (Scart) sockets for this purpose, since only the EURO sockets have separate inputs and outputs for picture and sound signals.

**Camcorders** can be connected to the TV set with special cables (available from your dealer). The following connection diagram applies in principle to all of our products, although the various sockets may be located in different positions on different units.

TV set, rear view

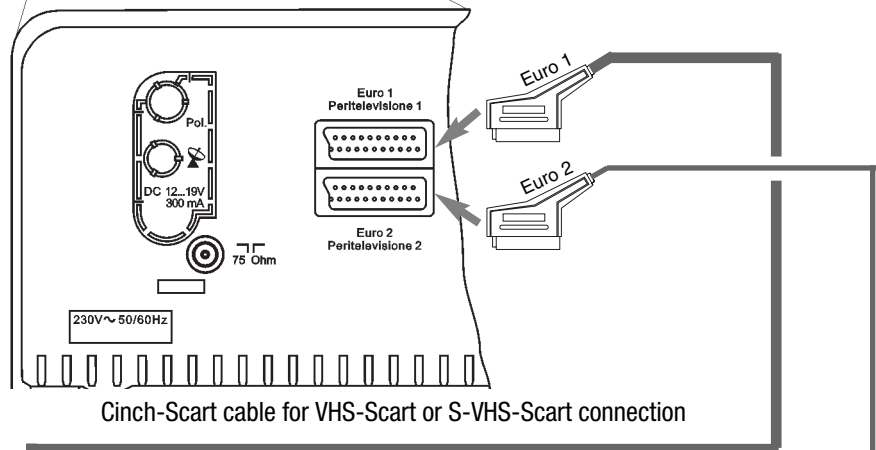
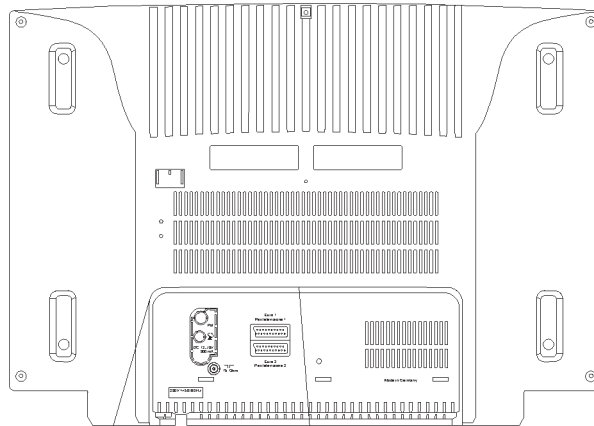

Cinch-Scart cable for VHS-Scart or S-VHS-Scart connection

e.g. hama no. 42387 or hama no. 42394

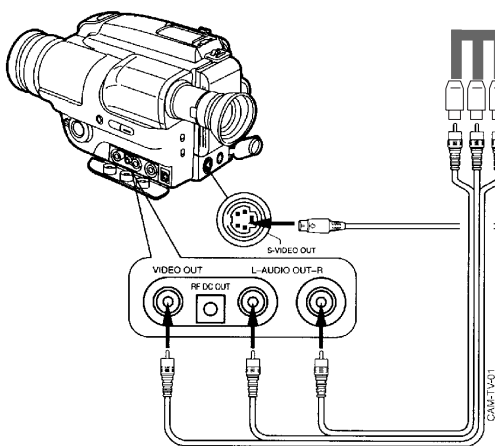

Camcorder (video camera)

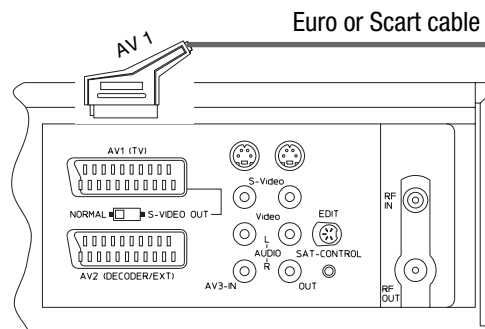

Video recorder, rear view

Videa

# 14. Connecting peripheral equipment

## Connecting external devices

In the menu „Device connection“, you can define which AV devices are connected to the various sockets on the TV set. The box „Devices“ contains a list of common AV devices. Only certain devices can be connected to the FRONT sockets.

**Wherever possible, the AV devices should be connected to specific EURO sockets, namely:**

**EURO 1:** VHS PC, games console (e.g. Nintendo, photo CD, SAT receiver, Pay-TV decoder, DVD, S-VHS playback unit).

**EURO 2:** S-VHS/Hi8 video recorder, S-VHS/Hi8 video recorder + Pay-TV decoder, VHS video recorder, SAT receiver, SVHS/Hi8-videorecorder+Pay-TV-Decoder, SAT-receiver.

The connections are pre-programmed in the factory as shown in the picture for step 1.

Press this key on the remote control....	The screen displays	Explanation																								
<p><b>1. Call the „Device connection“ menu</b></p>		<p>In the „Device connection“ menu, you can assign one of the defined AV devices to each of the EURO sockets.</p> <p><b>The abbreviations in the box on the right have the following meanings:</b></p> <p><b>Video rec.</b> = video recorder (up to 2 may be connected). Video rec. 1 is the video recorder which is always connected; Video rec. 2 is used for copying from one recorder to another.</p> <p><b>Logic VTR</b> = video recorder with data transfer to/from the TV set (e.g. DataLogic, QLink, EasyLink, Megalogic)</p> <p><b>VTR+Dec.</b> = video recorder and Pay-TV decoder (e.g. Premiere), where the decoder is connected only to the video recorder.</p> <p><b>Camcorder</b> = video camera</p> <p><b>Decoder</b> = Pay-TV decoder (e.g. Premiere)</p> <p><b>SAT</b> = external satellite receiver</p> <p><b>Game</b> = games console</p>																								
<p><b>2. Change the device connections</b></p>		<p>The default settings can be modified to meet your own requirements. You should, however, note the following input and output signal allocations when doing this.</p> <table border="1"> <thead> <tr> <th></th> <th colspan="2">S-VHS / Hi8 (= Y/C =S-Video)</th> <th colspan="2">VHS (= Video)</th> <th>RGB</th> </tr> <tr> <th></th> <th>Input</th> <th>Output</th> <th>Input</th> <th>Output</th> <th>Input</th> </tr> </thead> <tbody> <tr> <td>EURO 1</td> <td>Yes</td> <td>Yes</td> <td>Yes</td> <td>Yes</td> <td>Yes</td> </tr> <tr> <td>EURO 2</td> <td>Yes</td> <td>No</td> <td>Yes</td> <td>Yes</td> <td>Yes</td> </tr> </tbody> </table>		S-VHS / Hi8 (= Y/C =S-Video)		VHS (= Video)		RGB		Input	Output	Input	Output	Input	EURO 1	Yes	Yes	Yes	Yes	Yes	EURO 2	Yes	No	Yes	Yes	Yes
	S-VHS / Hi8 (= Y/C =S-Video)		VHS (= Video)		RGB																					
	Input	Output	Input	Output	Input																					
EURO 1	Yes	Yes	Yes	Yes	Yes																					
EURO 2	Yes	No	Yes	Yes	Yes																					
<p><b>3. Change the signal type</b></p>		<p>To change the settings, select the appropriate EURO socket with the coloured keys and then select the device to be connected with the <math>\triangle</math> and <math>\nabla</math> keys.</p> <p>When the devices are selected, the signal type is always set to „video“. Pressing the red key displays a box for selection of the signal type.</p> <p><b>Differences between the signal types:</b></p> <ul style="list-style-type: none"> <li><b>continuous AV operation:</b> the screen displays the picture provided by the AV device. The channel setting of the TV set has no effect.</li> <li><b>... controls AV operation:</b> if the AV device is set to „play“, the screen displays the picture provided by the AV device; if the AV device is set to „stop“, the screen displays the picture of the selected TV programme position.</li> </ul>																								
<p><b>4. Store the settings and return to TV picture</b></p>	<p><b>TV picture</b></p>																									

# 14. Connecting peripheral equipment Video recorders

## Connecting a video recorder via the aerial socket





- Connect the aerial output (RF-out) of the video recorder to the aerial socket of your TV by means of the aerial cable.
- Load a recorded video cassette in the video recorder.
- Start playback or switch on the test pattern of the video recorder. The test pattern of most video recorders is located within the standard channels Ch 30 to Ch 40 (see operating instructions of the video recorder).
- Execute a station search, beginning with standard channel 25. See Section 3. **Presetting TV stations, station search.**
- If the playback picture or the test pattern of the video recorder is displayed on the screen, then this channel can be stored. See Section 3. **Presetting TV stations.**
- In order to ensure optimum picture quality at all times, select the option „VCR 1“. To do so, proceed as described below.

Press this key on the remote control....	The screen displays	Explanation																																												
<p><b>1. Select the station table and call the picture submenu</b></p> <div style="margin-left: 20px;"> <div style="border: 1px solid black; padding: 2px; width: 60px; text-align: center; margin-bottom: 5px;">white</div> <div style="border: 1px solid black; padding: 2px; width: 60px; text-align: center; margin-bottom: 5px;">red</div> <div style="border: 1px solid black; padding: 2px; width: 60px; text-align: center; margin-bottom: 5px;">blue</div> <div style="border-left: 1px solid black; border-right: 1px solid black; border-bottom: 1px solid black; width: 100px; margin-left: 20px; margin-top: 20px; position: relative;"> <div style="position: absolute; top: -5px; left: 50%; transform: translate(-50%, -50%);">-</div> <div style="position: absolute; top: -5px; right: 50%; transform: translate(50%, -50%);">+</div> <div style="border: 1px solid black; border-radius: 50%; width: 30px; height: 30px; margin: 5px auto; text-align: center; line-height: 30px;">OK</div> </div> </div>	<div style="border: 1px solid black; padding: 5px; text-align: center; margin-bottom: 5px;"> <span>return</span> <span>TV picture</span> <span>Help</span> </div> <div style="border: 1px solid black; padding: 5px; text-align: center; margin-bottom: 5px;"> <b>TV station table</b> </div> <table border="1" style="width: 100%; border-collapse: collapse; font-size: small;"> <thead> <tr> <th>Programme</th> <th>Pict.</th> <th>Sound</th> <th>Std</th> </tr> </thead> <tbody> <tr><td>0 VTR1</td><td>—</td><td>—</td><td>Auto.</td></tr> <tr><td>1 <b>ARD</b></td><td>—</td><td>—</td><td><b>Auto.</b></td></tr> <tr><td>2 ZDF</td><td>—</td><td>—</td><td>Auto.</td></tr> <tr><td>3 SAT 1</td><td>—</td><td>—</td><td>Auto.</td></tr> <tr><td>4</td><td></td><td></td><td></td></tr> <tr><td>5</td><td></td><td></td><td></td></tr> <tr><td>6</td><td></td><td></td><td></td></tr> <tr><td>7</td><td></td><td></td><td></td></tr> <tr><td>8</td><td></td><td></td><td></td></tr> <tr><td>9</td><td></td><td></td><td></td></tr> </tbody> </table> <div style="border: 1px solid black; padding: 5px; margin: 5px auto; width: 80%; text-align: center;"> <p><b>Sharpness</b> 3</p> <p>Noise reduction A1</p> <p>CTI 0n</p> <p>— further</p> </div> <p style="text-align: center; font-size: x-small;">Logo, Channel, Signal</p> <p style="font-size: x-small;">600+06C1-GB</p>	Programme	Pict.	Sound	Std	0 VTR1	—	—	Auto.	1 <b>ARD</b>	—	—	<b>Auto.</b>	2 ZDF	—	—	Auto.	3 SAT 1	—	—	Auto.	4				5				6				7				8				9				<p>The picture quality of a video film can be improved in a terrestrial programme position with a standard channel.</p> <p><b>The video signal for this programme position must be set to „Aerial“.</b></p>
Programme	Pict.	Sound	Std																																											
0 VTR1	—	—	Auto.																																											
1 <b>ARD</b>	—	—	<b>Auto.</b>																																											
2 ZDF	—	—	Auto.																																											
3 SAT 1	—	—	Auto.																																											
4																																														
5																																														
6																																														
7																																														
8																																														
9																																														
<p><b>2. Call the second picture submenu and adjust VCR</b></p> <div style="margin-left: 20px;"> <div style="border: 1px solid black; padding: 2px; width: 60px; text-align: center; margin-bottom: 5px;">red</div> <div style="border: 1px solid black; padding: 2px; width: 60px; text-align: center; margin-bottom: 5px;">red</div> <div style="border-left: 1px solid black; border-right: 1px solid black; border-bottom: 1px solid black; width: 100px; margin-left: 20px; margin-top: 20px; position: relative;"> <div style="position: absolute; top: -5px; left: 50%; transform: translate(-50%, -50%);">-</div> <div style="position: absolute; top: -5px; right: 50%; transform: translate(50%, -50%);">+</div> <div style="border: 1px solid black; border-radius: 50%; width: 30px; height: 30px; margin: 5px auto; text-align: center; line-height: 30px;">OK</div> </div> </div>	<div style="border: 1px solid black; padding: 5px; text-align: center; margin-bottom: 5px;"> <span>return</span> <span>TV picture</span> <span>Help</span> </div> <div style="border: 1px solid black; padding: 5px; text-align: center; margin-bottom: 5px;"> <b>TV station table</b> </div> <table border="1" style="width: 100%; border-collapse: collapse; font-size: small;"> <thead> <tr> <th>Programme</th> <th>Pict.</th> <th>Sound</th> <th>Std</th> </tr> </thead> <tbody> <tr><td>0 LOGIC</td><td>—</td><td>—</td><td>Auto.</td></tr> <tr><td>1 <b>ARD</b></td><td>—</td><td>—</td><td><b>Auto.</b></td></tr> <tr><td>2 ZDF</td><td>—</td><td>—</td><td>Auto.</td></tr> <tr><td>3</td><td></td><td></td><td></td></tr> <tr><td>4</td><td></td><td></td><td></td></tr> <tr><td>5</td><td></td><td></td><td></td></tr> <tr><td>6</td><td></td><td></td><td></td></tr> <tr><td>7</td><td></td><td></td><td></td></tr> <tr><td>8</td><td></td><td></td><td></td></tr> <tr><td>9</td><td></td><td></td><td></td></tr> </tbody> </table> <div style="border: 1px solid black; padding: 5px; margin: 5px auto; width: 80%; text-align: center;"> <p>Chrom. adjustm. 00</p> <p>Col. offset adj. 0</p> <p>Contrast adj. 00</p> <p>Picture format 4:3</p> <p>— <b>VCR</b> 1</p> </div> <p style="text-align: center; font-size: x-small;">Logo, Channel, Signal</p> <p style="font-size: x-small;">600+06J-GB</p>	Programme	Pict.	Sound	Std	0 LOGIC	—	—	Auto.	1 <b>ARD</b>	—	—	<b>Auto.</b>	2 ZDF	—	—	Auto.	3				4				5				6				7				8				9				<p>To ensure optimum picture quality the „VCR“ function must be switched on.</p> <p>Set the „VCR“ function to „1“ with the <math>\leftarrow</math> <math>\rightarrow</math> keys and press the <b>OK</b> key to store the setting in the programme position.</p> <p>Press the <b>TV</b> key to return to the TV picture.</p> <p>If setting 1 does not result in a satisfactory picture quality, you can switch to setting 2.</p>
Programme	Pict.	Sound	Std																																											
0 LOGIC	—	—	Auto.																																											
1 <b>ARD</b>	—	—	<b>Auto.</b>																																											
2 ZDF	—	—	Auto.																																											
3																																														
4																																														
5																																														
6																																														
7																																														
8																																														
9																																														

# 14. Connecting peripheral equipment

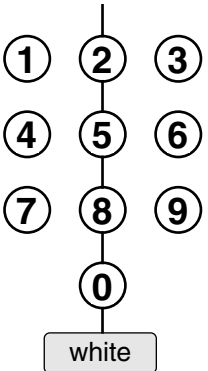
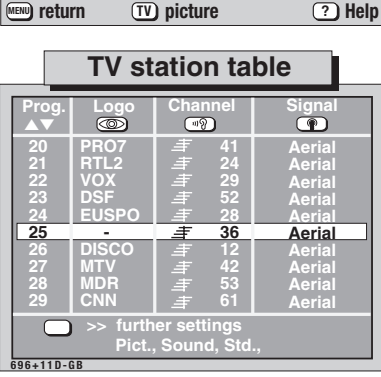
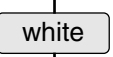
In the following example, logic video recorder 1 is to be connected to the EURO 1 socket.

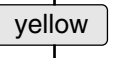
**Example:** Connect video recorder 1 to the EURO 1 socket.

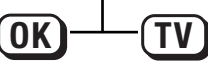
Press this key on the remote control....	The screen displays	Explanation
<p><b>1. Select any desired programme position and call the station table</b></p> 		<p>Select any desired programme position (in this example: position 25).</p>
<p><b>2. Call the submenu „Video signal“</b></p> 		<p>The video signal is normally supplied directly by the aerial.</p>
<p><b>3. Select the video signal EURO 1: „Video Rec.1“</b></p> 		<p>In order to display the picture from the video cassette on the screen, the video signal must be set to „EURO1“.</p> <p>In the case of a connection via a EURO cable, you should also set the function „VCR“ to „1“ (see also page 45).</p>
<p><b>4. Store the setting and return to the TV picture</b></p> 	<p><b>TV picture</b></p>	

# 14. Connecting peripheral equipment

Pay-TV decoder

This Pay-TV decoder decodes the scrambled signals of a Pay-TV station (e.g. Premiere) so that they can be displayed on the screen of the TV set. For connection of a Pay-TV decoder, you need a EURO (=Scart) cable in which all 21 pins are assigned.

If you want to record Pay-TV programmes with a video recorder, we recommend that you connect the Pay-TV decoder directly to the video recorder. If this is not possible, the Pay-TV decoder can be connected to the EURO 1 or EURO 2 socket (see also „Connecting external devices“ on page 44).

The following diagram shows two different connections of a Premiere decoder Typ G2

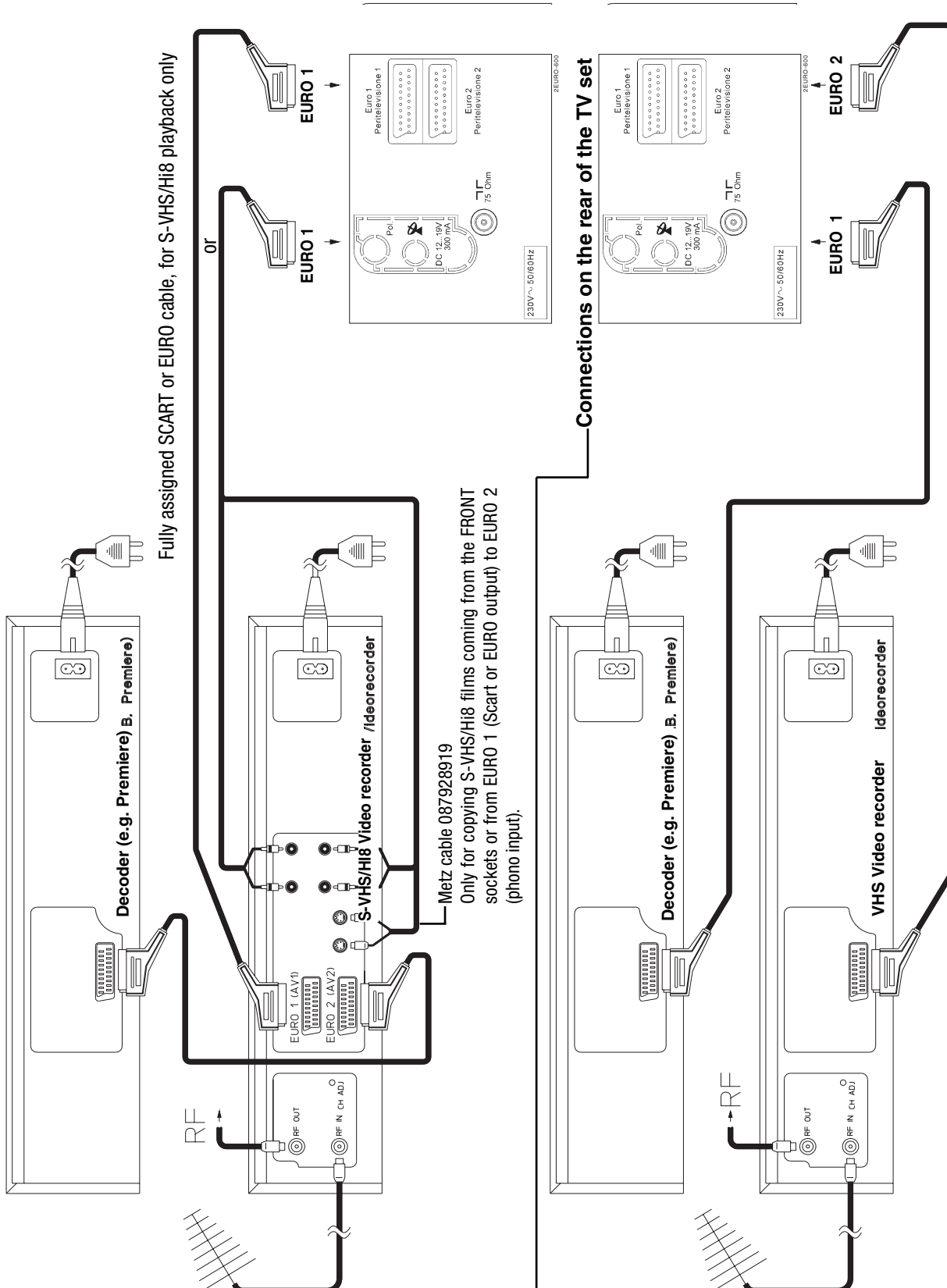

Fully assigned SCART or EURO cable, for S-VHS/Hi8 playback only

Connections on the rear of the TV set

Metz cable 087928919  
Only for copying S-VHS/Hi8 films coming from the FRONT sockets or from EURO 1 (Scart or EURO output) to EURO 2 (phono input).

# 14. Connecting peripheral equipment

Pay-TV decoder  
Video signal

For the following explanation it is assumed that the Pay-TV decoder A (Premiere) is connected to the EURO 1 socket.  
The following settings must be made on the TV set:

Press this key on the remote control....

The screen displays

Explanation

1. Select the Pay-TV program position and call the station table

white

MENU return TV picture ? Help

Station table			
Prog.	Logo	Channel	Signal
20	PRO7	41	Aerial
21	RTL2	24	Aerial
22	VOX	29	Aerial
23	DSF	52	Aerial
24	EUSPO	28	Aerial
25	PREMI	46	Aerial
26	DISCO	12	Aerial
27	MTV	42	Aerial
28	MDR	53	Aerial
29	CNN	61	Aerial

red >> further settings  
Std., Pict., Sound

698-11A-G-B

Connect the decoder as shown in the figure on page 47.  
Call the **Device connection** menu on the TV set (see page 44):

Assign the connection configuration, such as Decoder A" or „VTR+DEC (1)“, depending on how the decoder is connected, to one of the EURO sockets.

2. Call the submenu „Signal“

white

MENU return TV picture ? Help

TV station table			
Prog.	Logo	Channel	Signal
20	PRO7	41	Aerial
21	RTL2	24	Aerial
22	VOX	29	Aerial
23	DSF	52	Aerial

Aerial direct	
EURO1: Decoder A	
EURO2: LogicVTR	

Pict., Sound, Std.

600+14D-GB

The video signal is normally supplied directly from the aerial.

3. Select video signal „via decoder“



MENU return TV picture ? Help

TV station table			
Prog.	Logo	Channel	Signal
20	PRO7	41	Aerial
21	RTL2	24	Aerial
22	VOX	29	Aerial
23	DSF	52	Aerial

Aerial via decoder A	
EURO1: Decoder A	
EURO2: LogicVTR	

Pict., Sig, S store ?

OK

600+14D1-GB

A Pay-TV signal must always be unscrambled in a **decoder** before it can be displayed on the screen.

You can switch between „Aerial direct“ and „Aerial via decoder“ with the aid of the left and right arrow keys.

4. Store the setting and return to TV picture





## 15. Technical data

**Mains voltage:** 230 V AC 50/60 Hz

**Power consumption:**

	Power consumption (to GENELEC/TC 59 X):	Music power output to DIN 45324 at 4 Ohms and 1 kHz (sine output)
Linea	115 W env.	2 x 12 W (2 x 8 W)
Morea Crystal Tiros Ibiza	110 W env.	2 x 12 W (2 x 18 W)

**Power consumption/h**

Linea	115 Wh
Morea	110 Wh
Crystal	110 Wh
Tiros	110 Wh
Ibiza	110 Wh

**Standby (all sets):** ca. 1.5 W

**Aerial input:** 75 Ohms, asymmetric DIN 45325

**Channel coverage:** Standard channels 2...12, 21...69  
Special channels S1...S20, S21...S41  
S42...S46 (Belgian OIR channels)

## Guarantee

When you purchase the television, ensure that your dealer includes the completed TV „passport“. It must specify the date, the dealer's stamp and signature.

Keep this document in a safe place, together with the invoice. Any claims under the warranty will only be accepted if these documents are submitted. Keep your TV clean and handle it with care.

## 15.1 Upgrade kits

- **SAT upgrade kit 081 NB 1010**  
For satellite reception without an additional receiver.
- **SAT upgrade kit 083 NB 1018**  
A SAT receiver. Can also receive uncoded ADR (Astra Digital Radio) transmissions.
- **DVB-S upgrade kit 020 NG 101A**  
For reception of analog and digital TV and radio satellite stations, including Astra Digital (ADR), without additional receiver.

Ask your dealer for additional upgrade kits.

# 16. Glossary

## 2-channel sound transmission:

Separate reproduction of 2 sound channels, e.g. 2 different languages.

## Audio

Latin for „I hear“ - The sound frequency range audible to the human ear is between 60 to 20,000 Hz approx.

## Camcorder

A video camera with integrated video recorder.

## Cinch (phono)

Single-pole plug connector for separate audio and/or video copying.

## Data Logic

Until now, your TV set and your video recorder were two separate and independent devices. With the new "Data Logic", we have created a dialogue system with which the TV set and the video recorder can exchange data.

## Decoder

An electronic circuit that decodes TV signals; required to receive coded TV transmissions, such as Premiere.

## Dual-Band LNC

An LNC that can simultaneously process two transponder frequency ranges (11 GHz and 12 GHz)

## FBAS = CVBS

**C** = composite, **V** = video, **B** = blanking, **S** = signal

## Function keys - Television:

- *No function*  
No function has been assigned to this key.
- *Logo*  
The display of the station logo is meaningful only if a PIP upgrade kit has been installed.
- *Picture format (variable zoom)*  
Changes from 4:3 to 16:9 in the presence of a switching voltage.
- *Speech - music*  
The treble and bass boost settings are reduced in the position „Speech“.
- *Sound effects*  
Activates or de-activates spatial sound or base width.
- *Stereo/Sound 1-2*  
Switches to mono when a stereo programme is being received. To select channel 1 or 2 for two-language transmissions.
- *Muting -12 dB*  
Reduces the sound volume by 12 dB.
- *Infotext*  
Switches from the TV picture to the user defined marks 1, 2, etc.
- *Subtitles*  
Displays the subtitle with corresponding transmissions.
- *Large subtitles*  
100% enlarged subtitles are displayed with corresponding programmes.

## Function keys - Teletext

- *No function*  
No function has been assigned to this key.
- *Answer or Riddle solutions*  
Display of the hidden answers to riddles
- *Large font*  
Doubles the font size in teletext.
- *Stop page*  
Running through multiple pages consisting of more than 15 sub-pages is automatic. This can be stopped at any page with the „Stop page“ key so that „leafing“ can be continued manually.

## Noise reduction

Can be switched on to enhance the picture quality.

## OSD (On Screen Display)

Convenient display of all functions to adjust the television. They are superimposed on the current programme.

## Phono (cinch)

Single-pole plug connector for separate audio and/or video copying.

## RGB control

**R** = red, **G** = green, **B** = blue. Indicates separate colour signal processing.

## Spatial sound

Mono transmissions can be reproduced with an artificial stereo effect.

## Standard channels

02-12 and 21-69 can be received by way of the aerial and cable system.

## Standby mode

The TV has been switched off with the remote control, or it has switched itself off.

## Stereo wide

For stereo broadcasts, the distance between the speakers can be increased artificially to achieve a wider stereo effect.

## Timer

Used to program automatic recording, or to switch a video recorder or TV automatically on and off at a preset time.

# 17. Data Logic

## What is Data Logic?

Until now, your TV set and your video recorder were two separate and independent devices.

With the new "Data Logic", we have created a dialogue system with which the TV set and the video recorder can exchange data.

### Video recorders with Data Logic offer the following functions:

- Automatic transfer of station information for terrestrial or cable reception.
- Direct TV recording: the video recorder records the programme currently displayed on the TV screen, regardless of whether this comes from a terrestrial antenna, a cable system or a satellite.
- Direct control of recording: with the menu "AV recording" or "Timer recording".
- Status messages (such as "Timer recording started") are sent from the video recorder to the TV set and displayed there. (Not available on VC Series)
- Automatic switching to the AV programme position (Not available on VC Series).
- Automatic power-off of the video recorder if the TV set is switched to standby mode. (Not available on VC Series)

Video recorders of the Metz VC series, in combination with a Metz TV set with SAT facility, offer you the tremendous advantage of problemfree recording of SAT programmes.

## 1. Connecting a Data Logic video recorder to your TV set

Connect the AV-1 socket of the video recorder to the Euro-2 socket of your TV set, using a fully connected Scart cable.

**⚠ Data Logic will work only if there is a connection from the AV-1 socket to the Euro-2 socket.**

- Switch on the video recorder.

## 2. Setting the TV set for Data Logic

- Select programme position 0 on the TV set.

The TV set has been programmed in the factory for video recorder operation on programme position 0.

In order to check this, press the white key to display the station table with programme position 0 selected. The picture signal for this programme position must be set to "EURO2: LogicVTR" or "EURO2: LogicVTR+D".

TV station table			
Prog	Logo	Chan./Freq.	Signal
0	LOGIC	05	LogicVTR+D
1	ARD	06	Aerial
2	ZDF	34	Aerial

If the picture signal is set otherwise, you must set it to EURO 2 "LogicVTR" or "LogicVTR+D" in the menu "Device connection" (see Page 44 of the Operating Instructions).



## Automatic transfer of station information

for terrestrial or cable reception only !

The automatic transfer of station information saves you the tedious procedure of programming the tuner in your video recorder. After transfer of the information, timer recordings can also be programmed with the video recorder.

Press this key on the remote control:	The screen displays:	Explanation
<p>1. Call the menu "Station settings" on the TV set</p>		<p>Select video programme position (factory setting: Pr. 0) on the TV set!</p> <p>Station table → VTR</p> <p>This menu item can be selected only if there is a fully connected Scart cable between TV and VTR.</p> <p>If no stations have been set on the video recorder, the TV station table can be transferred to the video recorder.</p> <p>To transfer the station information:</p> <ul style="list-style-type: none"> <li>• Switch on the video recorder.</li> <li>• Select the menu item "Station table → VTR".</li> <li>• Confirm this selection by pressing <b>OK</b> - the main menu of the video recorder appears in the background.</li> <li>• After transfer of the station information, a blue menu of the video recorder appears in the background.</li> <li>• Close the menu "Station settings" by pressing <b>TV</b>.</li> <li>• Set and save the date and time on the video recorder.</li> </ul>
<p>2. Close the menu and set the date and time on the video recorder.</p>		

# 18. Index

- A**ccess to riddle solution (Hi Text) . . . . . 39
- Aerial connection . . . . . 4
- Allocating a station logo . . . . . 13
- Audio standard values . . . . . 15
- Autostore function . . . . . 10
- AV equipment, connecting . . . . . 43 - 48
- AV recording . . . . . 22
  
- Balance . . . . . 14, 15
- Bass . . . . . 14, 15
- Brightness, luminance . . . . . 14, 15
  
- C**amcorder, connecting . . . . . 43
- Channel entry . . . . . 9
- Childlock . . . . . 27
- Chrominance, colour intensity . . . . . 14, 15, 20
- Cleaning . . . . . 53
- Code . . . . . 27
- Connecting peripheral equipment . . . . . 43 - 48
- Contrast . . . . . 14, 15
- Cooling . . . . . 4
- Colour standard . . . . . 8
- Copying (programme positions) . . . . . 11
- CTI function . . . . . 20
  
- D**ata Logic . . . . . 51
- Decoder, connecting . . . . . 47 - 48
- Deleting programme positions . . . . . 11
- Direct page selection . . . . . 33
  
- E**ntering the time manually . . . . . 27
- Erasing marks . . . . . 38
  
- F**BAS (CVBS) . . . . . 50
- Fine tuning . . . . . 12
- Forced mono . . . . . 19
- Function keys . . . . . 17, 50
  
- G**lossary . . . . . 50
- Guarantee . . . . . 49
  
- H**eadphones, sound channel selection . . . . . 29
- Hi Text (Teletext) . . . . . 30 - 38
  
- I**nfotext (Mark by mark paging) . . . . . 37
  
- L**anguage selection (for TV menu) . . . . . 5
- Logo . . . . . 13
  
- Mains connection . . . . . 4
- Mark-by-mark advance . . . . . 37
- Moving stations . . . . . 11
- Multiple pages . . . . . 32
  
- Noise reduction . . . . . 20
  
- O**perator help . . . . . 7
  
- P**age selection by cursor . . . . . 32
- Peripheral equipment . . . . . 43 - 48
- Picture format (video recorder) . . . . . 21
- Picture settings . . . . . 14
  
- Picture sharpness . . . . . 14, 20
- Premiere decoder . . . . . 47
- Presetting stations . . . . . 9
- Programme selection . . . . . 6
  
- Remote control . . . . . 3
- Riddle solutions key . . . . . 39
  
- S**etting marks . . . . . 36
- Sorting stations . . . . . 11
- Sound channels 1/2 . . . . . 29
- Sound effects . . . . . 14
- Sound mute . . . . . 3, 14, 16
- Spatial sound . . . . . 18, 50
- Standby . . . . . 5
- Station closedown . . . . . 5
- Station search (see also Autostore) . . . . . 10
- Stereo wide . . . . . 18, 50
- Still picture . . . . . 3, 40
- Stop page . . . . . 50
- Summer time/winter time . . . . . 24
- Subtitles . . . . . 39
- Switch ON/OFF time . . . . . 24
  
- T**eletext (see Hi Text) . . . . . 30 - 38
- Thunderstorms . . . . . 5
- Time settings . . . . . 24
- Timer . . . . . 28
- Transmission standard . . . . . 8
- Treble . . . . . 14, 15
- TV menu . . . . . 5, 7
  
- U**ppgrade kits . . . . . 49
  
- V**ariable zoom . . . . . 40
- Video camera . . . . . 43
- Video recorder, connecting . . . . . 43
- Video standard values . . . . . 15
- Volume . . . . . 14, 15
- Volume adjustment . . . . . 19
  
- Z**oom . . . . . 40

Subject to changes as a result of technical advances. Errors and omissions excepted.

# Troubleshooting and care of the set

## Repairs

The TV should only be opened and repaired by qualified service personnel!



**CAUTION! DANGER!**

**Consult your dealer when repairs are necessary.**

If there is a technical fault in your TV set, the complete lamp assembly must be replaced by a trained technician!

The TV set may be opened and repaired only by a trained technician.

Any unauthorized attempts to open or repair the TV may result in the guarantee becoming null and void.

Adequate shielding is provided against X-ray radiation (see approval certificate on the rear panel of the TV).

Changing the high voltage or fitting a different type of picture tube may cause an increased amount of X-ray radiation. Televisions modified in such a manner are no longer in keeping with this approval certificate and must not be used!

## Cleaning the set



**Always switch off the TV with the ON/OFF key before you clean it!**

## Cleaning notes for glossy surfaces

### **Cleaning:**

- Clean with a soft, antistatic cloth or
- with a damp cloth and a mild detergent.

### **Polishing:**

- Polish with a soft cloth and furniture polish.
- Minor scratches can be removed with car polish (type for as-new paintwork without abrasives).



**Quality – A matter of principle.**

With the trend-setting Metz technology you will always make the correct choice.

See your Metz dealer.

He will be happy to demonstrate the current Metz range.



Metz-Werke GmbH & Co KG  
Postfach 1267, D-90506 Zirndorf

**Internet:** [www.metz.de](http://www.metz.de)  
**E-Mail:** [info@metz.de](mailto:info@metz.de)

Availability and technical details  
subject to change without notice.



Videorecorder



Camcorder



DVD



Audio



mecablitz

## Free Manuals Download Website

<http://myh66.com>

<http://usermanuals.us>

<http://www.somanuals.com>

<http://www.4manuals.cc>

<http://www.manual-lib.com>

<http://www.404manual.com>

<http://www.luxmanual.com>

<http://aubethermostatmanual.com>

Golf course search by state

<http://golfingnear.com>

Email search by domain

<http://emailbydomain.com>

Auto manuals search

<http://auto.somanuals.com>

TV manuals search

<http://tv.somanuals.com>