

70-440BP

UHF Handheld Transceiver

User's Manual

Copyright © 2002 by Midland Radio; all rights reserved.

In this book...

IN THIS BOOK.....	2
WARNING NOTES	3
FCC LICENSING INFORMATION.....	3
SAFETY	3
CONVENTIONS AND SYMBOLS IN THIS BOOK	5
PART NAMES AND THEIR FUNCTIONS	6
TOP	6
FRONT.....	6
SIDE (LEFT AND RIGHT)	7
DISPLAY.....	7
SETUP.....	8
UNPACKING	8
FITTING AND REMOVING THE ANTENNA.....	9
INSTALLING AND REMOVING THE BATTERY PACK	9
INSTALLING/REMOVING THE BELT CLIP	10
CHARGING THE BATTERY PACK.....	10
BASIC OPERATIONS	11
SWITCHING THE RADIO ON AND OFF	11
ADJUSTING VOLUME	12
CHANNEL SELECTION.....	12
RECEIVING	12
MONITOR BUTTON.....	13
TRANSMITTING	13
ADJUSTING TRANSMIT POWER.....	13
SCANNING CHANNELS	14
RADIO LOCK.....	15
ADVANCED OPERATIONS	16
HANDSFREE TRANSMIT (VOX).....	16
PAGING CALL.....	16
ROGER BEEP	17
KEY BEEP	17
BATTERY PACKS	17
RADIO MAINTENANCE.....	18
OPTIONAL ACCESSORIES	19
QUICK REFERENCE	21
OPERATION REFERENCE	21
INDEX.....	22

Introduction

Congratulations. 70-440BP is an advanced Professional Radio. Its rugged design allows it to be your reliable partner even during hard working days. Its LCD as well as user friendly controls make the 70-440BP easy to use.

To extend the flexibility of the radio, a “**VOX**” (Voice Operated Transmit) function has been added which allows switching the transmission just by talking in full hands free condition (with optional headset).

Transceiver's specifications provided in 70-440BP are compliant with EIA/TIA 603 and ETS 300 086, The 70-440BP top level design and resistance are compliant with IEC529 level IP54 and MIL STD 810 C,D,E.

Midland Radio is committed to continuous quality improvements, for this reason specifications may vary without prior notice.

Warning notes

Every effort has been made to ensure that the information in this document is complete, accurate, and up-to-date. Midland Radio assumes no responsibility for the results of errors beyond its control. The manufacturer of this equipment also cannot guarantee that changes in the equipment made by non authorized people will not affect the applicability of the information in it.

FCC Licensing Information

This Midland model 70-440BP radio operates on frequencies which require a license from the Federal Communications Commission (FCC) for business, personal, and recreational use.

For questions concerning licensing, contact the FCC at **1-888-CALL-FCC** (1-888-225-5322), or go to <http://www.fcc.gov>.

Safety

Your 70-440BP handheld transceiver has been carefully designed to give you years of safe, reliable performance. As with all electrical equipment, however, there are a few basic precautions you should take to avoid hurting yourself or damaging the radio:

- Read the instructions in this handbook carefully. Be sure to save it for future reference.
- Read and follow all warning and instruction labels on the radio itself.
- **Do not carry the transceiver by the antenna.** This may damage the antenna or antenna terminal. Grasp it by its base (not the tip!) when you need to place or remove it.
- **Do not keep the radio with the antenna very close** to, or touching exposed parts of the body, while transmitting. The radio will perform best if the microphone is 5-10 cm away from the mouth and the radio is vertical.
- Be sure the “PTT” key is not pressed when you do not need to transmit.
- Do not operate the radio near unshielded electrical blasting caps or in an explosive atmosphere.
- **Do not transmit without the antenna fitted on the radio.** Though it is provided with a protection, it may damage the TX output final stage.

- **Respect the environment conditions.** The radio is designed to be used in heavy environments, however avoid exposing it to extremely hot or cold temperature (out of the range between -30 to $+60^{\circ}\text{C}$). Do not expose the transceiver to excessive vibrations as well as dusty or rainy places.
- **Never try to disassemble or service the radio by yourself** (aside from the routine maintenance described in this handbook). It will immediately void the warranty and you may cause damage requiring extensive repair work. Always contact your local dealer for assistance.
- **Use only authorized accessories.** Non original ones could seriously damage your handheld transceiver.
- **Do Not spill liquid of any kind into your radio.** If the transceiver gets wet, immediately dry it by a soft and clean cloth.
- **Switch the radio off before you clean it.** Strictly follow the directions described in the paragraph "Care and maintenance".
- **Handle the battery properly.** Strictly follow the directions reported in "Care and maintenance".
- Be certain that your power source matches the rating listed for the supplied battery charger (AC adapter). If you are not sure, check with your dealer.
- To avoid damaging the power cable of the battery charger, do not put anything on it or place it where it will be walked on.

This product complies with the requirements of the Council Directives 89/336/EEC and 73/23/EEC on the approximation of the laws of the member states relating to electromagnetic compatibility and low voltage.

WARNING

Your wireless hand-held portable transceiver contains a low power transmitter. When the Push-to-Talk (PTT) button is pressed it sends out radio frequency (RF) signals. The device is authorized to operate at a duty factor not to exceed 50%. In August 1996, the Federal Communications Commission (FCC) adopted RF exposure guidelines with safety levels for hand-held wireless devices.

To maintain compliance with the FCC's RF exposure guidelines, this transmitter and its antenna must maintain a separation distance of at least 2 inches (5 centimeters) from your face. Speak in a normal voice, with the antenna pointed up and away from the face at the required separation distance. The beltclip is for storage purposes only. **DO NOT TRANSMIT WHILE USING THE BELT CLIP.** To transmit, hold the device away from your body and ensure the antenna is at least 2 inches (5 centimeters) from your body when transmitting.

Conventions and Symbols in this Book

 This symbol marks a 'note'. Notes are hints or tips which offer additional information to help you.

 **This symbol marks a 'caution'. Cautions are special notices, which you should read and follow carefully to avoid possible damage to your equipment and to avoid potential danger to yourself or other people.**

Key names will be highlighted in **bold**.

Important sentences and words are highlighted in *Italic*.

Part Names and their functions

Please have a look at the following parts description in order to familiarize yourself with the transceiver's main parts and controls. Numbers in brackets refer to the illustration.

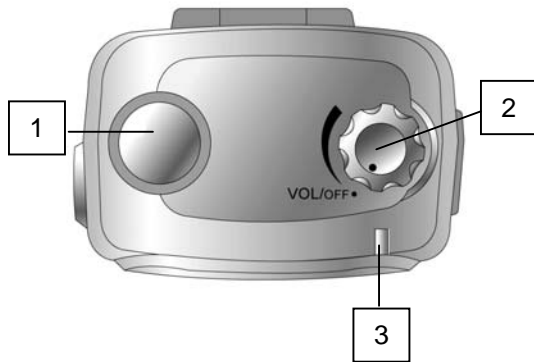

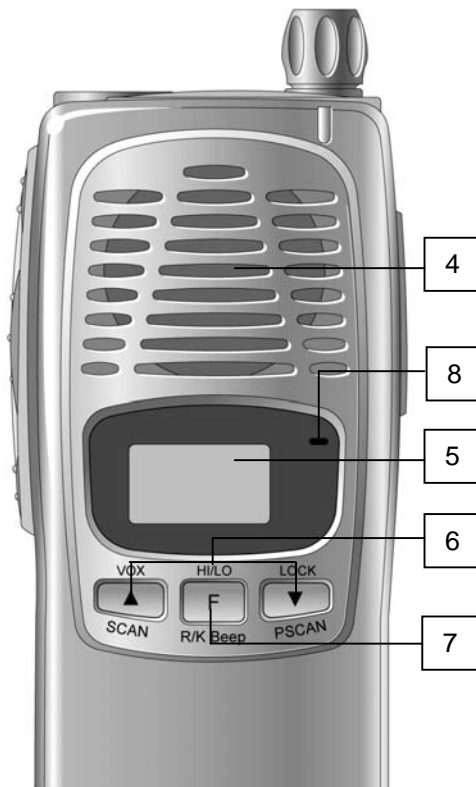

Top

- [1] **Antenna connector.** Fit the antenna to this connector (MX thread type).
- [2] **Power ON/OFF knob.** Rotate this knob to turn the transceiver on and off.
- [3] **Status LED.** Glows in different colors to show the radio's current status.



Front

- [4] **Speaker.** The built in speaker located in this point emits the received sound.
- [5] **LCD display.** Shows the radio's parameters (channel number etc.). Icon and symbols are further explained in the paragraph "Display". Whenever any key or button is pressed, the display is automatically backlit for few seconds.
- [6]  (Up) and  (down) buttons. For scrolling forward and backward through the channel list and for changing **function** values.
- [7] **"FUNC"** button. Allows changing **function** values.
- [8] **Microphone.** Your voice is detected by the microphone located in this place

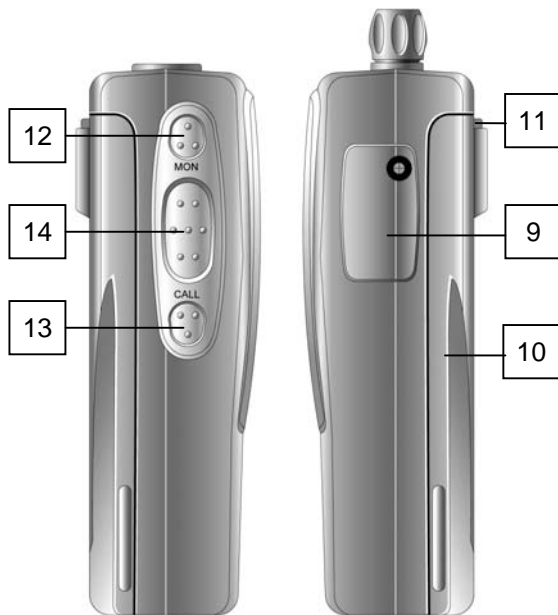

Side (left and right)

- [9] **Microphone connector**. For remote speaker/microphone, headsets for VOX use and other accessories. It must be protected with the supplied plastic cap when not in use. For the related pin connections please see to "Microphone connection".
- [10] **Battery pack**. This NiMH battery pack supplies energy to your radio.
- [11] **Release button** (located on the battery's body). Allows to remove the battery pack
- [12] **MON** (monitor) button. Enables the loudspeaker for monitoring of the tuned channel when CTCSS/DCS is enabled.
- [13] **"CALL"** button. Sends a paging **"CALL"** (if enabled)
- [14] **"PTT"** (Push To Talk) button. When pressed switches the transceiver from receive to transmit.

Display

This section explains the meaning of the various indications that may appear on the LCD of your 70-440BP handheld transceiver:

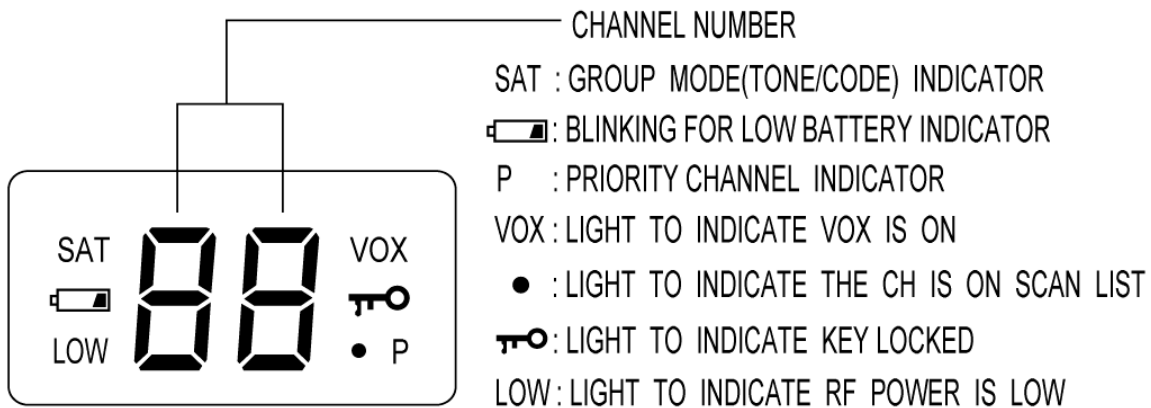

Setup

Unpacking

The following items are in the package:

- (a) Transceiver's main body
- (b) Flexible antenna
- (c) Battery pack NiMH 1,300 mA/h
- (d) Belt clip
- (e) Users guide (this book!)

If something is missing please promptly advise your supplier.

Fitting and removing the Antenna

To fit the antenna:

- 1) Locate the antenna terminal (thread MX type) on transceiver's top.
- 2) Hold the transceiver with one hand and the base (the thicker part) of the antenna with the other.
- 3) Attach the included rubber duck antenna to the antenna terminal by turning it clockwise until it is firmly locked. Do not overtighten.

To remove the antenna do the same described procedure. At step 3 turn the antenna base counterclockwise.

 **Always have the antenna attached to the radio. You can not communicate without it. Transmitting without the antenna will damage the TX output final stage. For the same reason use only the supplied antenna.**

Installing and removing the battery pack

To install the battery pack:

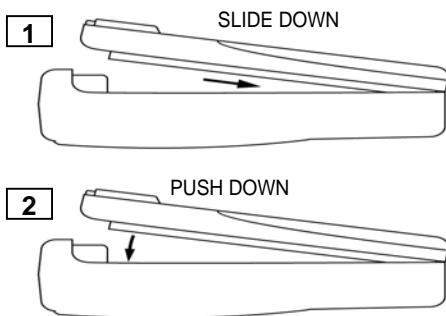

- 1) Hold the transceiver's body with one hand and the battery pack with the other. Put the bottom edge of the battery pack onto the bottom of the transceiver.
- 2) Gently push the battery pack toward the transceiver's body until the battery latches.

To remove the battery pack:

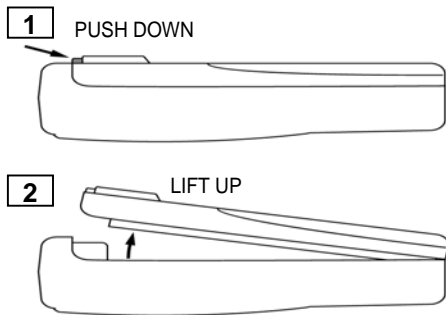

- 1) Press the battery release button located in the top of the battery pack.
- 2) Keep the button pressed and gently pull the battery pack away from the transceivers body.
- 3) Remove the battery pack by separating it from the transceiver's body.

Installing/removing the belt clip

The supplied belt clip allows you to hang the transceiver on your belt or jacket when you are not using the radio.

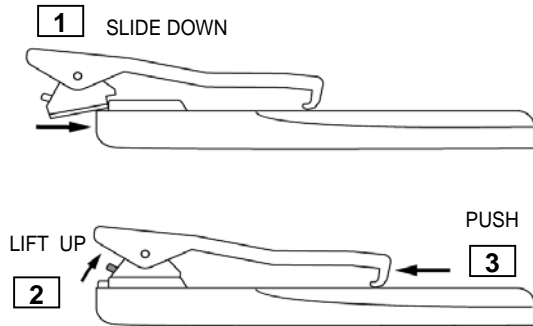

To fit the belt clip onto the transceiver's body:

- 1) Gently slide the clip into the appropriate guides located on the transceiver's battery pack until it firmly locks.

To remove the belt clip:

- 2) Gently move the latch located between the top of the belt clip and the battery pack towards the belt clip
- 3) Slide the belt clip off the radio.

Charging the battery pack

To charge the supplied battery pack you have to setup the charger and connect the radio as follows:

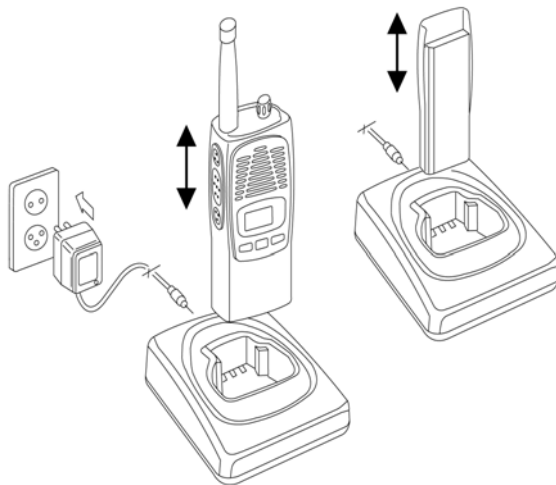

- 1) Connect the jack coming from the AC adapter to the cradle's socket.
- 3) Connect the AC plug of the AC adapter's power cable into a grounded AC power outlet.
- 4) Ensure that the radio is switched off.
- 5) Insert the radio into the cradle with the keypad toward you (the three metallic contacts of the battery pack must touch with the three contacts inside the cradle).
- 6) Wait 10-12 hours with the standard charger 2 hours with the rapid charger and remove the radio..

 *Do not remove the radio before the specified time, otherwise the battery's duty could be temporarily reduced.*

 **Do not forget to remove the radio from slow charger after 10 to 12 hours.**

 **The battery charger is for indoor use only.**

 **For the next charges, best duty and battery life please see the chapter "Battery Packs".**

Basic Operations

Switching the radio ON and OFF

To switch the radio on:

1) Rotate the “**PWR/VOL**” knob clockwise until the radio is switched on. The CPU will start an auto test as follows:

- LED will glow GREEN, then RED and turn OFF.
- LCD will display all segments and icons. The letters “**PS**”(“PASS”) will be displayed followed by a long beep.
- LCD will display the last operating mode.

 *The self-test goes very fast.*

2) After the auto test has been carried out LCD will show the following data:

- The *channel number*. (2 numeric characters).

 **NOTE:** *About 0.5 second after you select a new channel or change operation mode, the last status is automatically saved. When the Radio is turned on, the most recently used channel is displayed.*

 **NOTE:** *the following icons will be displayed depending on the operating mode.*

- The currently selected TX output power: **LOW** for low or nothing for high in the lower left corner of the LCD.
- A small “•” is displayed in the lower right corner of the LCD if the channel is in the SCAN list. (if enabled)
- A “**P**” is displayed to show that the channel is in the priority Scan list. (if enabled)
- “**SAT**” in the upper left corner indicates that the channel is a GROUP CHANNEL (for CTCSS or DCS tone if enabled).
- “**Battery**” icon when visible indicates battery is low.
- “**VOX**” is displayed when “**VOX**” function is enabled.
- A “**Key**” icon to indicate that the keypad is locked.

 **NOTE:** When “VOX” is enabled, “PTT” button is not working.

 **NOTE:** When keypad is locked; only “PTT” button is enabled (with exception of VOX enabled).

To switch the radio off, rotate the PWR/VOL knob counterclockwise.

Adjusting volume

The **PWR/VOL** knob is used to adjust the RX volume: turn it clockwise to increase or counterclockwise to reduce it.

Channel selection

Each channel is identified by 2 numeric digits.

Channel	Freq. MHz.	Channel	Freq. MHz.	Channel	Freq. MHz.

To select a channel:

- 1) Press the  key to increase the channel number or the  key to decrease it.

Receiving

Your radio can be programmed to work, channel by channel, in “Open traffic” or “GROUP MODE (CTCSS/DCS)”. Group mode prevents other users of a channel from being heard on your radio. See “Setting Group Mode Codes” for programming instructions.

- **OPEN TRAFFIC:** in this case you will hear all communication which will be transmitted on the selected channel. When a message is received your squelch will un-mute, you will see the status LED glowing green and you will hear the message.
- **GROUP MODE:**
 - **CTCSS/DCS (Continuous Tone Code Squelch System / Digital Coded Squelch):** are systems which use particular TX signaling as an access “key” to work a repeater (encoder) or to unlock the party’s signaling sensitive squelch. This last condition allows more radio networks to share the same frequency. In this case you will receive only messages coming from parties sending a proper TX signaling. During “**CTCSS/DCS**” operation, the radio may be set-up so that the appropriate **CTCSS/DCS** decoder enables the speaker.



CTCSS/DCS If more than one station is transmitting at the same time, this will cause interference! Do not transmit if the status LED is glowing. Wait until the channel is clear before transmitting.

Monitor Button

The Monitor button can enable or disable “**GROUP MODE (CTCSS/DCS)**” if programmed for that channel.

- 1) **To enable “GROUP MODE”**. Press and release the “**MON**” button: “**SAT**” icon is displayed. A Sub Audible Tone mutes your speaker.
- 2) **To Disable “GROUP MODE”**. Press the “**MON**” button: “**SAT**” icon is **not** displayed. You are now working in “**Open Traffic**”.

 **NOTE:** if “**SAT**” icon is never displayed, “**CTCSS/DCS**” tone is not programmed. “**GROUP MODE**” function is not available.

- 3) Press and Hold “**MON**” button for three seconds, internal squelch will be disabled and your speaker is un-muted. Press and release the “**MON**” button to restore the squelch to normal operating condition.

Transmitting

- 1) **Ensure that the channel is not busy** otherwise you will create interference.
- 2) Press the “**PTT**” button, the status LED will glow red.
- 3) Start talking at a **normal voice level** at approximately 2.5 inches from the microphone (keep the “**PTT**” button pressed).
- 4) When you have finished talking, release the “**PTT**” button.

 **Do not shout!** *It will not increase the distance you can transmit, but rather will make you heard distorted.*

 *Do not release the “**PTT**” button before your message is over or start talking before pressing “**PTT**”, otherwise your message will be “chopped”.*

 *A handheld radio does not allow you to talk and receive simultaneously, for this reason make your messages short. When you are talking the other parties can not use the channel! Use common sense.*

 *Your radio is programmed with a **timeout timer** which will automatically turn off the transmitter if you talk longer than 90 seconds. In this case release the “**PTT**” and wait for few seconds, the radio TX features will be automatically restored.*

Adjusting Transmit Power

Your 70-440BP can transmit with two power levels according to the distance of your party’s station(s). We do recommend, when possible, to use the Low power setting. This will increase the battery life and will reduce the risk of interference with other stations not in your radio network that may be sharing the same channel with you.

- 1) To change the channel's Power Output level from high (2 Watts) to Low (0.5 Watt), or vice versa, Press and Hold “**FUNC**” key for about 2 seconds. A small “**LOW**” will appear in the lower left corner of the display to indicate “**Low Power**”. High Power has no indicator.

- ☰ If the battery icon is "**blinking**" (Low Battery indication), the Unit will automatically switch to **Low Power** when transmitting in order to help prolong the Battery's operational life. In this case, two short beeps will be heard when you press the "**PTT**" key before the radio transmits.

Scanning channels

Your 70-440BP has three types of scanning available. The most used is **Normal Scan**. This allows you to scan all the channels you have designated in your scan list (see Creating Scan List). The next is scan with a **Priority** channel. This scan allows you to select a channel that will be monitored more often than the other channels while scanning (for this scan to work properly you must have at least 6 channels in the scan list). The next scan is **Dual Watch**. This allows you to scan only two channels of your choice. You must have more than one channel programmed in the scan list in order for your 70-440BP to scan them. The advanced scan function of the radio allows optionally looking for carrier or carrier with "**CTCSS**" or "**DCS**."



Creating the Scan-List.





- 1) Scroll the channel list, channels which show the "•" icon, are in the "**SCAN**" list.
- 2) Select the channel, which is to be added or deleted from the "**Scan**" list.

☰ Adding and removing channels from the Scan list is not available during scanning.

- 3) Press "**CALL**" + "**MON**" button, the "•" icon will appear or disappear. (See step 1 above.)

Activating, Deactivating Normal Scan

- 1) Press the "**CALL**" button +  key. You will see the channel numbers cycling continuously.
- 2) To stop scanning press the "**CALL**" button +  key.

☞ If when deactivating **Normal** scan you press the "**CALL**" button +  key by accident, the radio will be in **Priority** scan. If you press the "**CALL**" button +  key to deactivate the **Normal** scan the radio will now be in **Dual Watch** (as described later). In this case to deactivate both scans you must first press the "**CALL**" button +  then press the correct buttons "**CALL**" button +  key.

☰ **NOTE:** If the Scan List has no channels, a low tone (error beep) will be heard when the "**CALL**" +  key is pressed, no channel will be scrolled in the display. At least two channels must be in the Scan List for the Unit to be put in the **SCAN** Mode.

☰ When a signal is received on a channel, the radio will stop scanning and the speaker will become un-muted. When the activity on that channel ceases, the unit will automatically resume scanning.





☰ If CTCSS/DCS have been previously programmed, the scanning will stop only if the received carrier has the appropriate signaling.

☰ If "**PTT**" is pressed during scanning, the radio will transmit on the first vacant channel. In case of no activity, the Unit will automatically resume scanning.

Selecting a Priority Channel

One channel can be assigned as a "**Priority Channel**". The scanning will look back at the priority channel most frequently.

☰ Current radio version only allows for PC programming of another priority channel.

- 1) To activate Priority channel, press the “**CALL**” +  key. A "P" will be displayed in the lower right corner of the display to confirm your selection.
- 2) Activate scan by pressing “**Call**” +  key.
- 3) Deactivate scan by pressing “**Call**” +  to remove the Priority channel then press “**Call**” +  to stop the scan.

Selecting Dual Watch

1. Choose the second channel you wish to use. Press the “**CALL**” +  key to activate the Priority channel. A "P" will be displayed in the lower right corner of the display to confirm your selection.
2. The radio will scan the chosen channel and the priority channel.

Radio lock

Your 70-440BP has been provided with a security function, which protects it against accidental activation of commands. You can lock the radio as follows:

To lock the radio:

- 1) Press the “**FUNC**” key +  key.

To unlock the radio:

- 1) Press the “**FUNC**” key +  key.



 *When the radio is locked only the “**PTT**” button is enabled.*

Advanced Operations

In this section we'll describe some advanced operation which you can do with your handheld transceiver:

Handsfree Transmit (VOX)

VOX (Voice Operated Transmit) is an automatic system, which allows you to automatically switch the transmission in hands free mode just by speaking in the built-in microphone of a headset (not provided with the unit). Please ensure that the headset is suitable for your transceiver as reported in the paragraph "Microphone connection".

- 1) **Connect the optional headset** with built-in microphone to the microphone connector located on the transceiver's side. Be sure the headset is equipped for "**VOX**" operation.
- 2) **To activate "VOX"**: Turn the radio off. Press and hold the "**FUNC**" +  keys turn the radio on. "**VOX**" icon will be displayed.
- 3) Ensure that the headset's built-in microphone is located close to the side of your mouth.
- 4) Press the "**FUNC**" key +  key to adjust the "**VOX**" sensitivity in order to ensure a stable transmission when speaking with a normal voice level.

 "**VOX**" icon will flash when **LOW** sensitivity is selected and on steady when **HIGH** sensitivity is selected.

 **We recommend setting the "VOX" for minimum sensitivity. Sensitivity set too high could cause accidental transmissions, especially in high noise environments.**

 "**PTT**" button is disabled during **VOX**.

- 5) **To DEACTIVATE "VOX"**: Turn off the radio. Press and hold the "**FUNC**" +  keys. Turn the radio on. The "**VOX**" icon will no longer be displayed. The "**VOX**" is now off.

Paging Call

User can alert radios of his fleet by pressing the "**CALL**" button. The other parties will hear a ringer type sound.

To send an automatic "**CALL**":

- 1) Press the "**CALL**" key for about 2-sec. to alert all the radios in your fleet.
- 2) A ringer type sound will advise the other parties about the incoming message.
- 3) Press the "PTT" and Speak with a normal voice level to send the message.

Roger Beep

A roger beep will be heard by the other party when "PTT" button is released.

To enable or disable Roger Beep "**FUNC**":

Press the "**FUNC**" + **CALL**" keys.

Key Beep

A beep is heard by the user when any key is pressed with the exception of the "PTT" button.

To enable or disable Key Beep:

Press the "**FUNC**" key + "**MON**" button.

Battery Packs

Information on rechargeable batteries

- When the battery pack is new it will not provide 100% of its efficiency. To reach the full battery run time you have to "run-in" the battery with at least 3-4 deep charging/discharging cycles. After that it will reach its maximum capacity. Please see "Proper charging of battery packs" for further details.
- When you properly use the battery pack, you will obtain about 400 charge/discharge cycles (300 with the optional rapid charger). The battery "run time" will progressively reduce after 2/3 of its life (approx.).
- Rechargeable battery packs lose their charge with time if left unused (self-discharge), this is normal. A NiMH (Nickel Metal Hydride) battery can reduce 10 to 20% of its stored energy in few days.

Proper charging of battery packs

- 1) Ensure that the radio is switched off,
- 2) Insert the radio into the cradle as explained in the paragraph "Charging the battery pack"
- 3) Wait the necessary time to provide a full charge. If the pack isn't completely discharged you will need less than 8 hours. (Battery icon does not indicate battery charging progress.)



Do not overcharge the battery: always remember to remove the radio after the necessary time.



The battery charger is for indoor use only.



When possible, charge the battery only when it is fully discharged or, at least, you have used it for the major part of the day, otherwise the battery's "run time" could be temporarily reduced.













Do not remove the radio before the necessary time, otherwise the battery's "run time" could be temporarily reduced.

- When possible charge battery packs only when they are completely discharged, i.e. when the “low battery” icon flashes steadily.
- Do not remove the battery from the charger before the necessary time to provide a full charge.
- Provide at least two deep charge/discharge cycles per month.

Warnings for battery and chargers use

Please use these cautions to avoid damaging battery packs or the transceiver:

-  **Before using the battery charger carefully read any related warning or caution.**
-  **Do not short battery terminals: this may cause fire, burns or explosions.**
-  **Never dispose batteries into fire they may explode causing fire, burns or explosions. Strictly follow any disposal regulation of your Country.**
-  **Use only authorized batteries and chargers. The use of non-authorized accessories may cause burns, fire or explosions causing serious damages to the radio/battery or serious injuries to people.**
-  **Battery chargers are for indoor use only.**
-  **Be certain that your power source matches the rating listed for the supplied battery charger (AC Adapter). If you are not sure, check with your dealer or with your local power company.**
-  **To avoid damaging the power cable of the battery charger, do not put anything on it or place it where it will be walked on. Insert the plug in socket provided with earth connection.**
-  **Avoid strong shocks. Do not use the charger if it received a strong shock, has fallen down or it appears damaged; immediately contact an authorized service station.**
-  **Never try to disassemble or service the charger by yourself. Always contact your local dealer for assistance.**
-  **To reduce the risk of electric shocks disconnect the plug before providing any cleaning or maintenance. Grasp the plug (not the cable) to remove the plug from the socket. The use of non-suitable extension can cause fire or electric shocks.**
-  **Do not expose batteries directly to temperatures below -20°C (-4°F) or greater than 35°C (95°F) during their use and do not charge them outside the range of +5 to +55°C.**

Radio maintenance

Cleaning battery packs

Wipe the battery contacts with a clean and lint free cloth to remove dirt, grease or any other material that may prevent a good electrical contact. If contacts are very dirty you can also wipe them using a *soft pencil rubber* (not hard erasers for ink!). If you feel that battery contacts aren't still working properly, please contact your authorized dealer.

-  **Do not use liquid, alcohol or aerosol cleaners.**

Cleaning the radio

- Wipe the radio with a clean and lint free cloth to remove dust. If it is very dirty, you can use a damp (*slightly* moistened with *water*) cloth.

 **Do not use liquid, alcohol or aerosol cleaners.**

 *If you normally use your radio in dusty or hard environments, we do recommend using the optional carrying case. Please see "Optional accessories".*

Connectors

When the connectors are not being used, they should be fitted with the supplied cover caps.

 **Only suitable accessories must be connected to the related connectors.**

Optional accessories

These optional accessories can be used to improve the transceiver's performances:

- Spare battery pack number **81B02**. It extends the duty time.
- Rapid charger number **18-388**. Recharges the battery packs in 1 hour and provides trickle charge when they reached their full charge.
- Carrying case. Protects your radio against small shocks and scratches the best for use in hard environments.

WARNING, RF exposure

Your wireless hand-held portable transceiver contains a low power transmitter. When the Push-to-Talk (PTT) button is pressed sends out radio frequency (RF) signals. The device is authorized to operate at a duty cycle factor not to exceed 50%. In august 1996, the Federal Communications Commissions (FCC) adopted RF exposure guidelines with safety levels for hand-held wireless devices. The FCC has issued the following warning,

To maintain compliance with the FCC's RF exposure guidelines, this transmitter and its antenna must maintain a separation distance of at least 2 inches (5 centimeters) from your face. Speak in a normal voice, with the antenna pointed up and away from the head at the required separation distance. The belt clip is for storage only. **DO NOT TRANSMIT WHILE USING THE BELT CLIP.** To transmit, hold the device away from your body and ensure the antenna is at least 2 inches (5 centimeters) from your body when transmitting.

Microphone connector

The microphone connector is designed for the connection of two basic accessories (not supplied as standard):

- **External speaker/microphone:** Allows you to use the radio secured to your belt by means of the

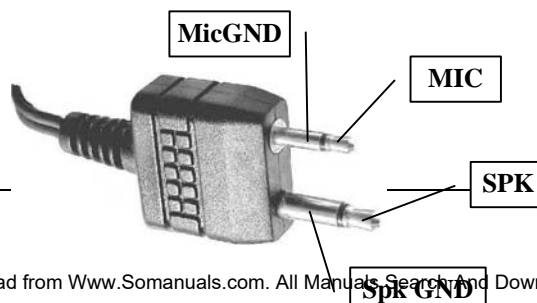

supplied belt clip.

- **Headset with built-in microphone:** Will additionally add the VOX facility, For further details please see "Hands free transmission (VOX)".

Any kind of accessory for the above stated purposes can be connected to the microphone connector, provided that they meet the following requirements:

- Jack connectors for Speaker (SPK) and Microphone (MIC) must be respectively standard type 3.5 mm and 2.5 mm. and connected as follows:

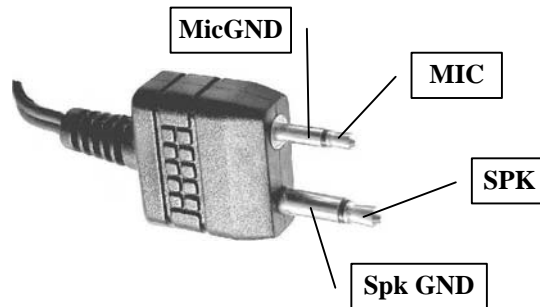







- The suggested speaker input impedance is 8 Ohms
- The microphone should be condenser low-impedance type.
- All accessories should be hi-quality suitable for professional use.

 **Please do not connect any accessory that you are not sure meet the above stated requirements. You could cause serious damage to your radio. In if your not sure please contact your authorized dealer.**

Quick reference

Operation reference

- 1) **Output Power:** Press the “**FUNC**” key to set High or Low Power output. “**LOW**” icon is displayed to show that you set Low Power output. (high output has no indication)
 - 2) **Group Mode:** Press the “**MON**” button to enable/disable GROUP MODE. “**SAT**” icon is displayed.
 - 3) **Squelch:** Press and Hold “**MON**” button to enable/disable the squelch.
 - 4) **Scan:** Press the “**CALL**” button + the  key to enter the SCAN.
 - 5) **Scan List:** Press the “**CALL**” button + “**MON**” key to change the channel in the scan list. The “•” icon will be displayed if the channel is in the scan list.
 - 6) **Priority:** Press the “**CALL**” button + the  key to activate the programmed priority channel. A “**P**” icon will be displayed.
 - 7) **Lock:** Press the “**FUNC**” + the  keys to lock/unlock the radio. Only “**PTT**” button will function when the unit is locked (VOX is disabled).
 - 8) “**VOX**” Press the “**FUNC**” + the  keys while turning on the radio to enable/disable “**VOX**”. “**VOX**” icon will be displayed. (“**PTT**” button is disabled)
 - 9) When “**VOX**” function is enabled, Press the “**FUNC**” + the  key to set **HIGH** or **LOW** “**VOX**” sensitivity. VOX icon blinks to show LOW sensitivity.
 - 10) Press the “**CALL**” Button for about 2 seconds to send an alert with a ringer type tone to all the users in the fleet. (ringer will also be heard from the speaker when activated)
 - 11) Press the “**FUNC**” + “**CALL**” keys to enable / disable roger beep at the end of the transmission.
 - 12) Press “**FUNC**” + “**MON**” keys to enable/disable key beep.
-  **Press the “FUNC” + the  key and switch on the unit. UP will be displayed and unit enters the PROGRAMMING MODE. This operation is only allowed to authorized person.**

Index

A

Adjusting

Transmission Power	13
Volume	12

Antenna

fitting/removing	9
------------------------	---

B

Battery charger

rapid (optional).....	19
standard	10

Battery pack

Charging	10
----------------	----

Battery packs

cleaning	18
Information on rechargeable batteries.....	17
Proper changing	17
Warnings for battery and chargers use.....	18

Belt clip	10
-----------------	----

C

Carrying case.....	19
--------------------	----

Channel selection	12
-------------------------	----

Charger.....	See Battery charger
--------------	---------------------

Cleaning the radio	19
--------------------------	----

Connectors	19
------------------	----

Conventions and Symbols.....	5
------------------------------	---

D

Display	7
---------------	---

H

Handsfree transmission (VOX).....	16
-----------------------------------	----

K

KEY BEEP.....	17
---------------	----

M

Microphone connector	19
-----------------------------------	----

O

Optional accessories.....	19
---------------------------	----

Carrying case.....	19
--------------------	----

Rapid charger	19
---------------------	----

Spare battery pack	19
Output power	
Adjusting	13
P	
PAGING	16
Power	
button	11
ON/OFF	11
TX output adjustment	13
Q	
Quick reference	21
Operation resume	21
R	
Radio lock	15
Radio maintenance	18
Rapid charger	19
Reception	12, 13
ROGER BEEP	17
S	
Safety	3
Scanning channels	14
Setup	
Battery pack	9
Belt clip	10
Charging the battery pack	10
Fitting antenna	9
Package contents	8
Unpacking	8
Switching the radio ON/OFF	11
T	
Transmission	13
Transmission Power	13
V	
VOX	16
W	
Warning notes	3
Warnings for battery and chargers use	18

Midland Radio Corporation
1120 Clay St.
North Kansas City, Mo. 64116

E-mail: mail@midlandradio.com

URL: www.midlandradio.com

Free Manuals Download Website

<http://myh66.com>

<http://usermanuals.us>

<http://www.somanuals.com>

<http://www.4manuals.cc>

<http://www.manual-lib.com>

<http://www.404manual.com>

<http://www.luxmanual.com>

<http://aubethermostatmanual.com>

Golf course search by state

<http://golfingnear.com>

Email search by domain

<http://emailbydomain.com>

Auto manuals search

<http://auto.somanuals.com>

TV manuals search

<http://tv.somanuals.com>