

PROFESSIONAL 19" LCD OBSERVATION SYSTEM WITH BUILT-IN 8 CHANNEL DIGITAL VIDEO RECORDER

Instruction Manual

English Version 5.0



MODEL:
L19LD800 Series



www.lorexcctv.com



Copyright © 2007 Lorex Technology Inc.

Thank you for purchasing the LCD / 8 Channel DVR Combo. Lorex is committed to providing our customers with a high quality, reliable security product.

This system offers a whole new level of security surveillance to the consumer market. Combining the latest word in LCD displays, Digital Video Recording and CCTV Camera design, the system does more than simply provide the sharpest video imaging (under any condition), large capacity video storage and unparalleled ease of system control – it's also made to provide the longest trouble free service with an array of built-in diagnostics and commercial grade CCTV component design.

To learn more about the LCD / 8 Channel DVR Combo, and to learn about our complete range of accessory products, please visit our website at:

<http://www.lorexcctv.com>

	CAUTION RISK OF ELECTRIC SHOCK DO NOT OPEN	
CAUTION: TO REDUCE THE RISK OF ELECTRIC SHOCK DO NOT REMOVE COVER (OR BACK). NO USER SERVICABLE PARTS INSIDE. REFER SERVICING TO QUALIFIED SERVICE PERSONNEL.		



The lightning flash with arrowhead symbol, within an equilateral triangle, is intended to alert the user to the presence of uninsulated "dangerous voltage" within the products ' enclosure that may be of sufficient magnitude to constitute a risk of electric shock



The exclamation point within an equilateral triangle, is intended to alert the user to the presence of important operating and maintenance (servicing) instructions in the literature accompanying the appliance.

WARNING: TO PREVENT FIRE OR SHOCK HAZARD, DO NOT EXPOSE THIS UNIT TO RAIN OR MOISTURE.

CAUTION: TO PREVENT ELECTRIC SHOCK, MATCH WIDE BLADE OF THE PLUG TO THE WIDE SLOT AND FULLY INSERT.

Please visit us on the web for the most current Manuals, Quick Start Guides and Firmware.
Additional Language Manuals are also available at:

<http://www.lorexcctv.com>

Important Safeguards

In addition to the careful attention devoted to quality standards in the manufacture process of your video product, safety is a major factor in the design of every instrument. However, safety is your responsibility too. This sheet lists important information that will help to assure your enjoyment and proper use of the video product and accessory equipment. Please read them carefully before operating and using your video product.

Installation

1. **Read and Follow Instructions** - All the safety and operating instructions should be read before the video product is operated. Follow all operating instructions.
2. **Retain Instructions** - The safety and operating instructions should be retained for future reference.
3. **Heed Warnings** - Comply with all warnings on the video product and in the operating instructions.
4. **Polarization** - Do not defeat the safety purpose of the polarized or grounding-type plug.
 - o A polarized plug has two blades with one wider than the other.
 - o A grounding type plug has two blades and a third grounding prong.
 - o The wide blade or the third prong is provided for your safety.
 - o If the provided plug does not fit into your outlet, consult an electrician for replacement of the obsolete outlet.
5. **Power Sources** - This video product should be operated only from the type of power source indicated on the marking label. If you are not sure of the type of power supply to your location, consult your video dealer or local power company. For video products intended to operate from battery power, or other sources, refer to the operating instructions.
6. **Overloading** - Do not overload wall outlets of extension cords as this can result in the risk of fire or electric shock. Overloaded AC outlets, extension cords, frayed power cords, damaged or cracked wire insulation, and broken plugs are dangerous. They may result in a shock or fire hazard. Periodically examine the cord, and if its appearance indicates damage or deteriorated insulation, have it replaced by your service technician.
7. **Power-Cord Protection** - Power supply cords should be routed so that they are not likely to be walked on or pinched by items placed upon or against them, paying particular attention to cords at plugs, convenience receptacles, and the point where they exit from the video product.
8. **Ventilation** - Slots and openings in the case are provided for ventilation to ensure reliable operation of the video product and to protect it from overheating. These openings must not be blocked or covered. The openings should never be blocked by placing the video equipment on a bed, sofa, rug, or other similar surface. This video product should never be placed near or over a radiator or heat register. This video product should not be placed in a built-in installation such as a bookcase or rack unless proper ventilation is provided or the video product manufacturer's instructions have been followed.
9. **Attachments** - Do not use attachments unless recommended by the video product manufacturer as they may cause a hazard.
10. **Water and Moisture** - Do not use this video product near water. For example, near a bath tub, wash bowl, kitchen sink or laundry tub, in a wet basement, near a swimming pool and the like.

Caution: Maintain electrical safety. Power line operated equipment or accessories connected to this unit should bear the UL listing mark of CSA certification mark on the accessory itself and should not be modified so as to defeat the safety features. This will help avoid any potential hazard from electrical shock or fire. If in doubt, contact qualified service personnel.
11. **Accessories** - Do not place this video equipment on an unstable cart, stand, tripod, or table.

The video equipment may fall, causing serious damage to the video product. Use this video product only with a cart, stand, tripod, bracket, or table recommended by the manufacturer or sold with the video product.

Any mounting of the product should follow the manufacturer's instructions and use a mounting accessory recommended by the manufacturer.



Service

12. **Servicing** - Do not attempt to service this video equipment yourself as opening or removing covers may expose you to dangerous voltage or other hazards. Refer all servicing to qualified service personnel.
13. **Conditions Requiring Service** - Unplug this video product from the wall outlet and refer servicing to qualified service personnel under the following conditions.
 - A. When the power supply cord or plug is damaged.
 - B. If liquid has been spilled or objects have fallen into the video product.
 - C. If the video product has been exposed to rain or water.
 - D. If the video product does not operate normally by following the operating instructions. Adjust only those controls that are covered by the operating instructions. Improper adjustment of other controls may result in damage and will often require extensive work by a qualified technician to restore the video product to its normal operation.
 - E. If the video product has been dropped or the cabinet has been damaged.
 - F. When the video product exhibits a distinct change in performance. This indicates a need for service.
14. **Replacement Parts** - When replacement parts are required, have the service technician verify that the replacements used have the same safety characteristics as the original parts. Use of replacements specified by the video product manufacturer can prevent fire, electric shock or other hazards.
15. **Safety Check** - Upon completion of any service or repairs to this video product, ask the service technician to perform safety checks recommended by the manufacturer to determine that the video product is in safe operating condition.
16. **Wall or Ceiling Mounting** - The cameras provided with this system should be mounted to a wall or ceiling only as instructed in this guide, using the provided mounting brackets.
17. **Heat** - The product should be situated away from heat sources such as radiators, heat registers, stoves, or other products (including amplifiers) that produce heat.

Use

18. **Cleaning** - Unplug the video product from the wall outlet before cleaning. Do not use liquid cleaners or aerosol cleaners. Use a damp cloth for cleaning.
19. **Product and Cart Combination** - Video and cart combination should be moved with care. Quick stops, excessive force, and uneven surfaces may cause the video product and cart combination to overturn.
20. **Object and Liquid Entry** - Never push objects for any kind into this video product through openings as they may touch dangerous voltage points or "short-out" parts that could result in a fire or electric shock. Never spill liquid of any kind on the video product.
21. **Lightning** - For added protection for this video product during a lightning storm, or when it is left unattended and unused for long periods of time, unplug it from the wall outlet and disconnect the antenna or cable system. This will prevent damage to the video product due to lightning and power line surges. The manufacturer's instructions and use a mounting accessory recommended by the manufacturer.

General Precautions

1. All warnings and instructions of this manual should be followed
2. Remove the plug from the outlet before cleaning. Do not use liquid aerosol detergents. Use a water dampened cloth for cleaning
3. Do not use this unit in humid or wet places
4. Keep enough space around the unit for ventilation. Slots and openings in the storage cabinet should not be blocked
5. During lightning storms, or when the unit is not used for a long time, disconnect the power supply, antenna, and cables to protect the unit from electrical surge

FCC CLASS B NOTICE

Note:

This equipment has been tested and found to comply with the limits for a Class B digital device, pursuant to Part 15 of the FCC Rules. These limits are designed to provide reasonable protection against harmful interference in a residential installation. This equipment generates, uses, and can radiate radio frequency energy and, if not in-stalled and used in accordance with the instruction, may cause harmful interference to radio communications.

However, there is no guarantee that interference will not occur in a particular installation. If this equipment does cause harmful interference to radio or television reception (which can be determined by turning the equipment on and off), the user is encouraged to try to correct the interference by one or more of the following measures:

- Reorient or relocate the receiving antenna
- Increase the separation between the equipment and receiver
- Connect the equipment into an outlet on a circuit different from that to which the receiver is connected
- Consult the dealer or an experienced radio or television technician for assistance

This equipment has been certified and found to comply with the limits regulated by FCC, EMC, and LVD. Therefore, it is designated to provide reasonable protection against interference and will not cause interference with other appliance usage.

However, it is imperative that the user follows this manuals guidelines to avoid improper usage which may result in damage to the unit, electrical shock and fire hazard injury

In order to improve the feature functions and quality of this product, the specifications are subject to change without notice from time to time.

LOREX TECHNOLOGY INC.

<http://www.lorexctv.com>

L19LD800 Series Features

- Internet Remote Viewing*, Backup and Control utilizing a web browser or client software (included)
- 'True' 8 Camera digital video system with Triplex operation allows you to View, Playback and Record video simultaneously
- Thin design 19" LCD surveillance display features ultra-fast refresh rate with mouse driven navigation and multi-lingual on screen display
- High Reliability Surveillance Hard Disk Drive with MPEG4 video compression**
- Hard Drive mirroring feature for backup and redundancy
- High end esoteric, design and finish with a robust LCD stand
- Tri-lingual on screen display (English , French and Spanish)
- 100 ft. (30m) extension cable included per camera

* Requires a high speed internet connection and router – not included

** Recording capacity may vary based on recording resolution & quality, lighting conditions and movement in the scene

Table of Contents

Getting Started	9
L19LD800 Series - Front.....	10
L19LD800 Series - Back	14
Cable Channel & VESA Standard Stand	14
Remote Control	16
Camera Installation	16
Camera Installation	17
Installation Warnings:	17
Camera Stand Installation:	17
Connecting DIN Cameras	17
Connecting BNC Cameras.....	18
Camera Connection Diagram	19
Connecting a Mouse	20
Mouse Controls	20
Display Modes.....	21
Initial Loading Sequence	21
General Display Overview	21
Onscreen Icons – Legend	22
Camera Display Modes	23
Menu Navigation Controls & Tips	24
Menu Navigation Controls	24
Virtual Keyboard Control	24
Active Option Indicator	24
System Setup Controls	25
Setup Menu - Options.....	25
System Menu Tree	26
System Menu	27
Date / Time	27
Language Setup	28
User Setup.....	28
User Setup (cont.)	29
HDD Management.....	29
HDD Management (cont..)	30
System Information.....	30
Setup & System Update Manager.....	31
System Log.....	31
Screen Save Setup.....	32
Event Menu	33
Alarm-In Setup.....	33
Motion Setup	34
Video Loss.....	35
Text-In Setup	35
System Event Setup	36
Record Menu.....	38
Schedule Setup	38
Pre-Event Setup	38

Table of Contents

Archive Menu	39
Camera Menu	40
Display Setup Menu	40
SEQUENCE Control	41
PTZ Setup Menu	41
Using the PTZ Camera Controls	42
Network Setup Menu	45
LAN Setup	45
Serial Setup	46
DDNS Setup	46
Notification Setup	47
SITE Setup	48
Additional Key Functions	49
Key Add Function	49
Playing Recorded Video	51
Video Search	53
GO TO THE FIRST	53
GO TO THE LAST	53
GO TO THE DATE/TIME	53
CALENDAR SEARCH	54
EVENT LOG SEARCH	55
TEXT-IN SEARCH	57
BOOKMARK SEARCH	58
Observation System Specifications - Appendix #1	59
Connecting Motion / Alarm Device - Appendix #2	61
Installing a Sensor	61
Connecting RS-485 & RS-232 Devices - Appendix #3	62
Installing a PTZ (RS-485 Type) PTZ Camera:	62
Installing a PTZ (RS-232 Type) PTZ Camera:	62
Full Connectivity Diagram – Appendix #4	63
Hard Drive Replacement - Appendix #5	63
Hard Drive Replacement - Appendix #5	64
Removing the Back Cover and Installed Drive	64
Setting the New Drive to Master	64
Hard Drive Replacement (cont ...)	65
Installing the New Drive	65
New Hard Drive Format	65
Troubleshooting – Appendix #6	66
Troubleshooting (cont ...)	67
Factory Default Settings - Appendix #7	68
System Log & Messages – Appendix #8	70
System Log	70
Event Log	70
Pop-Up Messages	71
Optional Accessories	73

Getting Started

The system comes with the following components:



**1 x LCD & DVR COMBO UNIT
WITH PRE-INSTALLED HDD**



1 x POWER ADAPTOR



1 x 10' ETHERNET CABLE



REMOTE CONTROL



**1 x HARDWARE MANUAL
1 x SOFTWARE MANUAL
1 x QUICK START GUIDE
1 x INSTALL CD**

CHECK YOUR PACKAGE TO CONFIRM THAT YOU HAVE RECEIVED THE COMPLETE SYSTEM, INCLUDING ALL COMPONENTS SHOWN ABOVE.

L19LD800 Series - Front

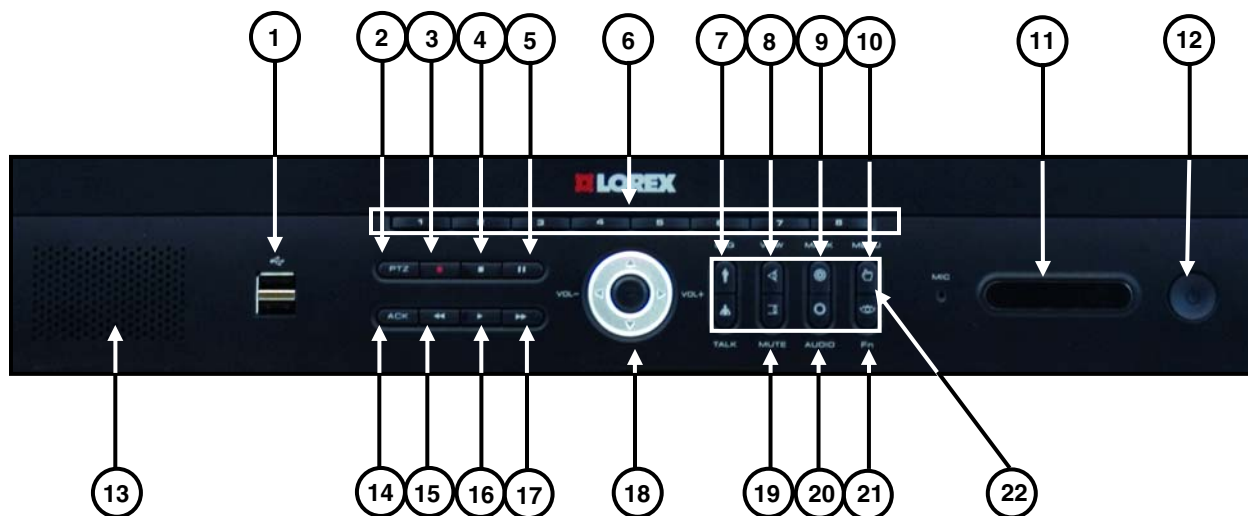

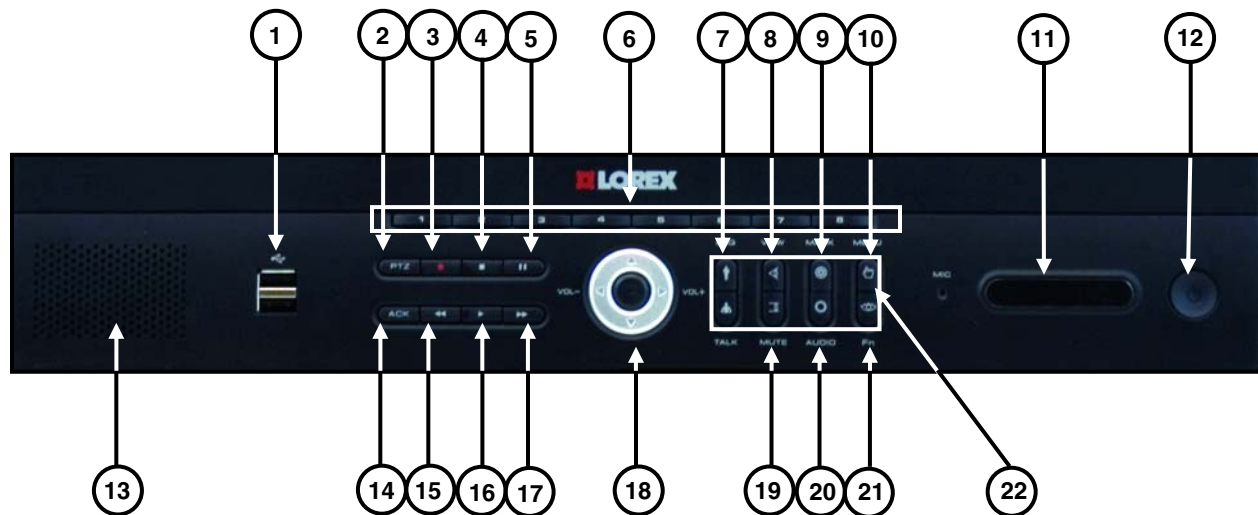

1. **USB** - Two USB 2.0 ports are provided to connect external hard disk drives, optical drives (CDRW / DVDRW) or USB memory stick for archiving video.
2. **PTZ** - Press the PTZ key to enter the PTZ control mode.
3. **RECORD** ● - Press the key to start scheduled recording. Pressing the key again toggles stop and start.
4. **STOP** ■ - Press the key to return to the live screen mode while in the playback mode.
5. **PAUSE** ■■ - Press the key to freeze the video on the screen in the playback mode.
6. **CAMERA NUMBER** - Pressing a numbered button will display the corresponding camera in full screen mode.
7. **SEQ** - Press the SEQ key to start/stop Sequence viewing mode.
8. **VIEW** - Press the VIEW key to change the onscreen view to QUAD or 3x3 Multi-Screen.
9. **MARK** - Press the MARK key to set a bookmark in the playback mode.
NOTE: A bookmark is used to flag a certain event to easily locate it again.
10. **MENU** - Press the MENU key to enter or exit the system Setup Mode.

L19LD800 Series - Front







11. STATUS INDICATOR LEDs - LEDs will illuminate when the following occur:

- **IR RECEIVER** (does not illuminate) - Receives the signal from the IR transmitter on the Remote Control.
- **RECORD LED**  - Illuminates when the unit is in Record Mode.
- **NETWORK LED**  - Illuminates when a remote user is connected to the unit (Network Access).
- **POWER LED**  - The Power LED illuminates when the unit is receiving power. The Power Indicator will be ON when the Monitor display is OFF, but will not be illuminated when the monitor display is ON.





12. **POWER**  - Press to turn the monitor display ON. Press key again to turn the monitor display OFF.

13. **SPEAKER** – Transmits sound from the cameras.

14. **ACK** - Press the Acknowledge key to reset the alarm output.

15. **REWIND**  - Press the  key to play video in reverse at regular speed. Pressing the key again toggles the playback speed between , ,  and . Pressing this key when playback is paused will step reverse one frame.

16. **PLAY**  - Pressing the  key plays video forward at regular speed.

17. **FAST FORWARD**  - Press the  key to play video forward at high speed. Pressing the button again toggles the playback speed between ,  and .

L19LD800 Series - Front

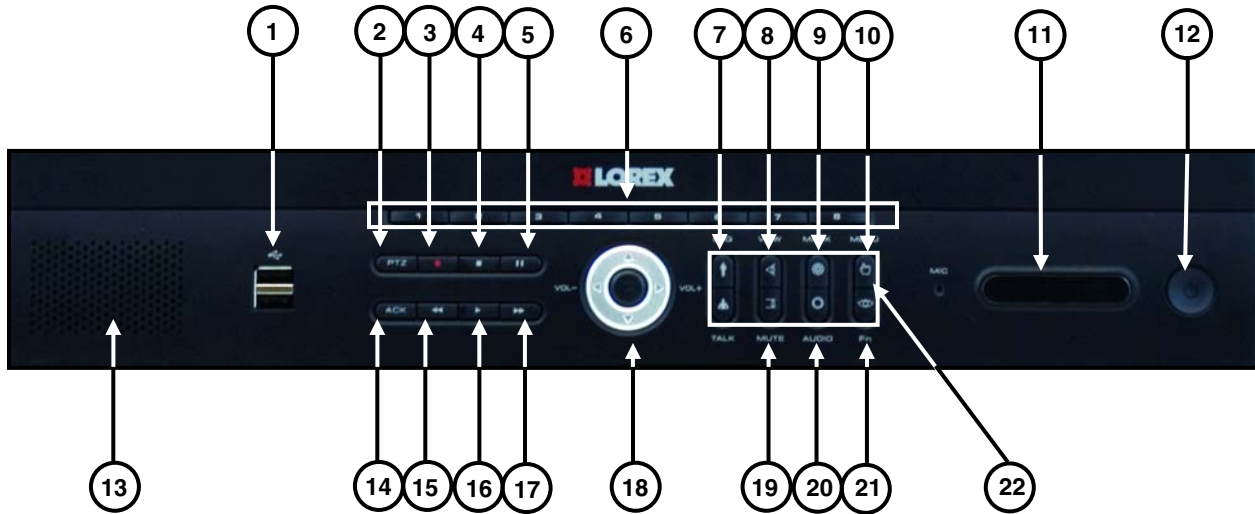

18. NAVIGATION & VOLUME CONTROLS – The Volume Controls are used in Live Viewing &

Playback Modes:

- **VOL + (RIGHT)** Press the VOL + (Volume UP) key to increase the volume level in the live screen 16 mode.
- **VOL- (LEFT)** Press the VOL- (Volume DOWN) key to decrease the volume level in the live screen mode.



Navigation controls are used in Menu and PTZ Modes:

- **MENU MODE** - The Up ▲ and Down ▼ Arrow keys are used to move the active selection to each menu or field. Pressing the Left◀ and Right ▶ arrow keys in a configuration menu changes the value of a selected item.
- **PTZ MODE** - The ▲▼◀▶ Arrow keys can be used to pan or tilt a PTZ camera in the PTZ mode
- **ENTER** ↵- The ↵ key is used to select a submenu or menu items, or save selections made in menus. Pressing this key while the live monitoring mode displays the system information.

19. **MUTE** - Press the MUTE button to set the audio level to the minimum level.

20. **AUDIO** - Press the AUDIO key to change the listen-in audio between cameras 1~4 (when in Multi-screen display mode).

21. **FN (FUNCTION)** - Press the FN key to enter the function mode.

L19LD800 Series - Front

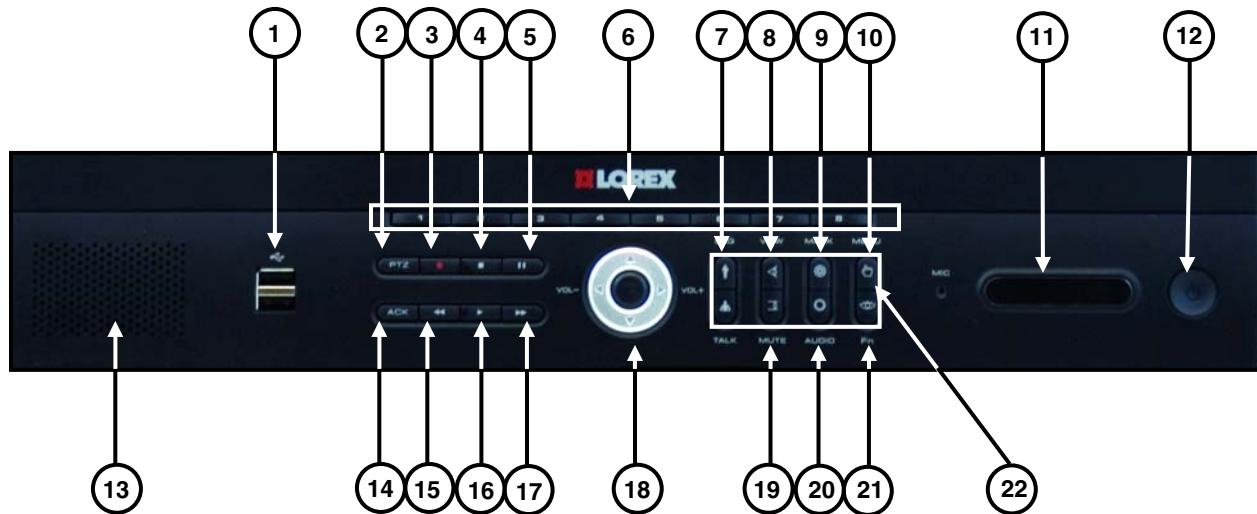

22. PTZ - ALTERNATE FUNCTIONS – The following buttons are used in PTZ Mode:

- **ZOOM IN** - Press to zoom in.
- **ZOOM OUT** - Press to zoom out.
- **FOCUS NEAR** - Press to control the focus (near).
- **FOCUS FAR** - Press to control the focus (far).
- **IRIS CLOSE** - Press to control the iris close.
- **IRIS OPEN** - Press to control the iris open.
- **SET** - Press to store the preset while.
- **RUN** - Press to recall the preset.

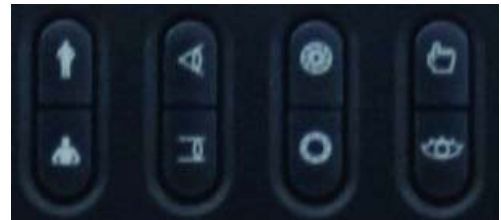

USB Connection

The Two USB ports on the front panel provide a convenient connection point for External Hard Drives , Optical Drives (CDRW / DVDRW) and Flash Drives, which allow the user to copy video clips or update the system firmware. A USB mouse (not supplied) can also be connected to one of the ports, and is used to navigate through the screens and menu (not included).

Note: Position external drives close enough to the system so that you can make the cable connections, usually less than 6 feet. Use the USB cable provided with the hard disk drive to connect it to the system.

Supports USB Ver. 2.0 and 480Mbps (also compatible with Ver. 1.1)

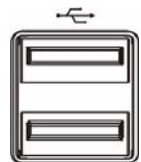

L19LD800 Series - Back

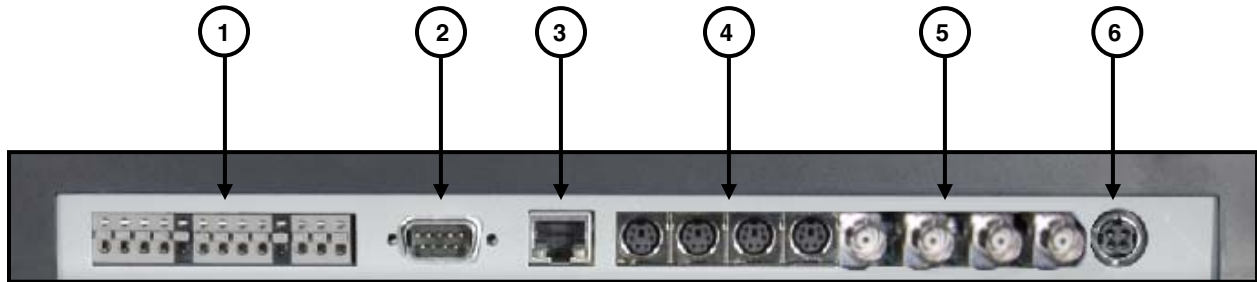

- 1. ALARM I/O & RS-485 TERMINAL** – Connection point for external devices:
 - The Alarm Block is used to connect devices such as a motion sensor, door/alarm sensor, or time lapse VCR for Alarm Recording. Refer to appendices for Alarm Block Configuration. Alarm devices are not included.
 - The RS-485 Block is used to connect devices such as a keyboard or a PTZ (Pan/Tilt/Zoom) Camera. Keyboards and PTZ Cameras are not included.
- 2. RS-232** - Connects to devices such as a keyboard and a POS device (not included).
- 3. ETHERNET (LAN) PORT** - Connects the monitor to a router for connection to the internet. Refer to appendices for Remote Connection setup.
- 4. 6-PIN DIN CAMERA INPUTS** - Channel 1~4 Camera inputs (for cameras with 6 Pin DIN connections).

Cameras with 6 Pin DIN connections draw power from the System - additional power adaptors are not needed.
- 5. BNC VIDEO INPUTS** - Channel 5~8 camera inputs (used to connect Cameras with BNC connection type). Cameras with BNC connections require an additional power adapter.
- 6. POWER INPUT** - Connect the AC power using the power cord provided with the unit from the monitor to an electrical outlet

Rear Ports with Labels:



Cable Channel & VESA Standard Stand

The L19LD800 Series stand comes with a built in cable channel to easily organize and conceal wiring. The stand can be removed to mount the monitor directly to other VESA standard mounting brackets.

Connect the Power Cable, Cameras, Ethernet Cable and any Alarm Devices to the System by running the cables through the hole in the stand before connecting to the Observation System.

DEVICE CONNECTIONS (Stand Removed)



DEVICE CONNECTIONS (Stand Connected, wires routed through Cable Channel).



Remote Control

Listed below is a quick reference for the Remote Control. All Buttons described above function the same as the Front Panel buttons.

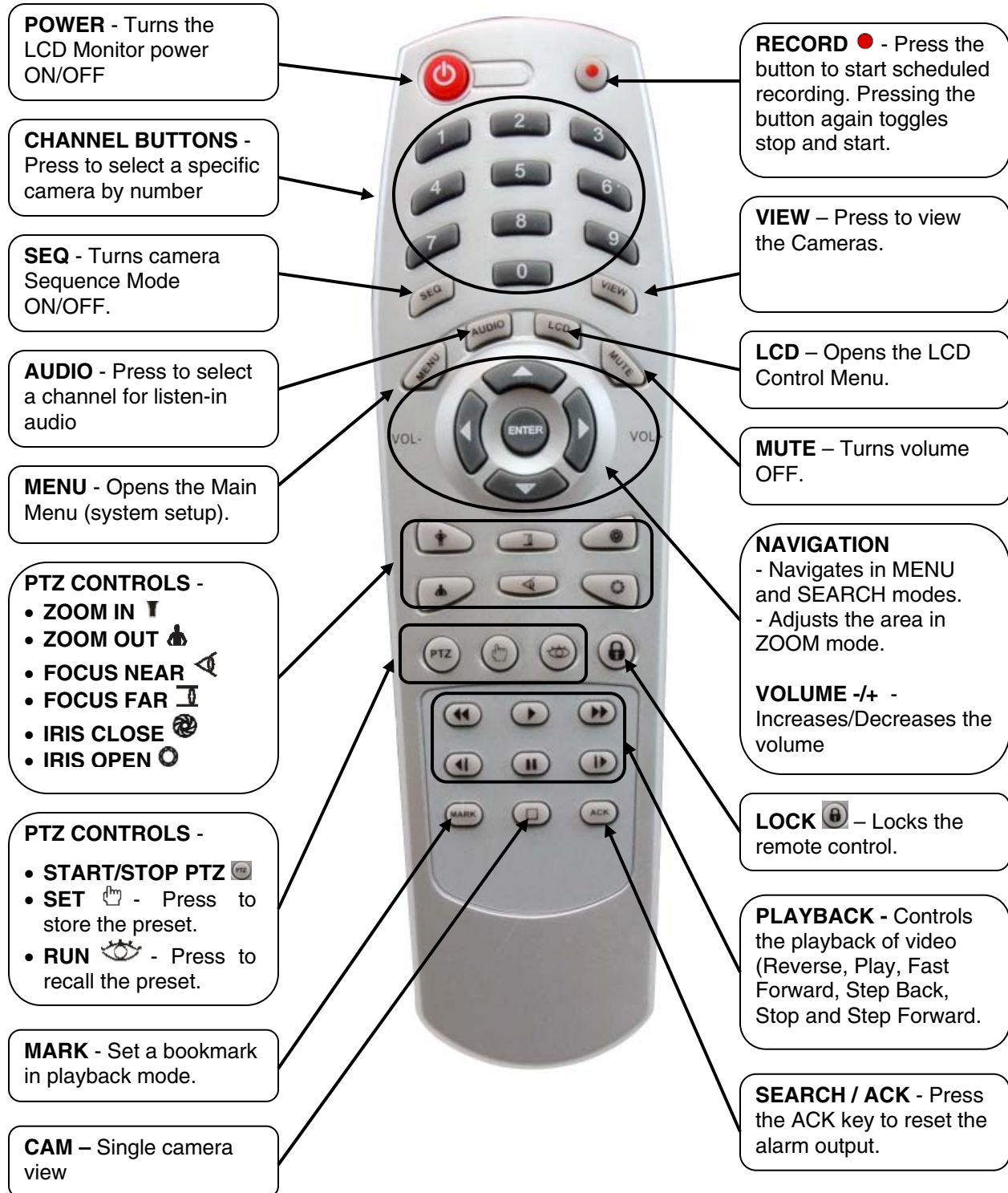

Camera Installation

Before you install the camera*, carefully plan where and how it will be positioned, and where you will route the cable that connects the camera to the System.

Installation Warnings:

- Select a location for the camera that provides a clear view of the area you want to monitor, which is free from dust, and is not in line-of-sight to a strong light source or direct sunlight.
- Plan the cables' route so that it is not close to power or telephone lines, transformers, microwave ovens or other electrical equipment that could interfere with the system.
- Select a location for the camera that has an ambient temperature between 14°F~113°F (-10°C~45°C)
- If you plan to install the camera in a location that has conditions not recommended in this manual, consult with a professional installer and consider use of a separate camera cover or housing
- Before starting permanent installation, have another person hold the camera for you while you verify its performance by observing the image on the monitor.

Camera Stand Installation:

1. Attach the pedestal to the ceiling, wall or other surface by the base using the provided screws.
2. The mounting bracket must be attached to a structural device such as a wall stud or ceiling rafter using the supplied screws.
3. Attach the camera to the pedestal. Adjust the angle of the camera, and tighten the thumbscrew to set the position

NOTE: The Camera can be attached to the stand using the screw point on the top or the bottom (to maintain proper camera alignment). This prevents the image from becoming inverted.



* Camera may not be exactly as shown

Connecting DIN Cameras

1. Connect the female end of the supplied extension cable to the camera.



NOTE: Confirm that the arrows on the DIN Camera Cable and the DIN Extension cable are pointed together when connecting the cable. If the pins in the DIN Cable are bent, the Camera will NOT function.



2. Connect the male end of the supplied 100' extension cable to an open DIN camera input (CAM 1~4) on the back of the System. Continue connecting additional DIN cameras.

NOTE: The arrow on the DIN Camera should be facing up when connecting the DIN Extension Cable to the Observation System.

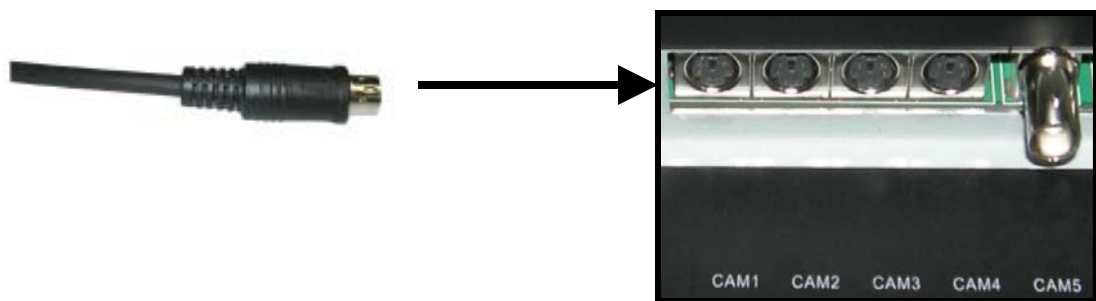

Connecting BNC Cameras

1. Connect the 60ft Extension cable to the Camera and Observation System:

- A. Connect the Barrel Power connector to a power adaptor.
- B. Connect the BNC connector to an available BNC Port (CAM 5~8) on the monitor
- C. Connect the Male Power connector to the Camera.
- D. Connect the BNC connector to the Camera.

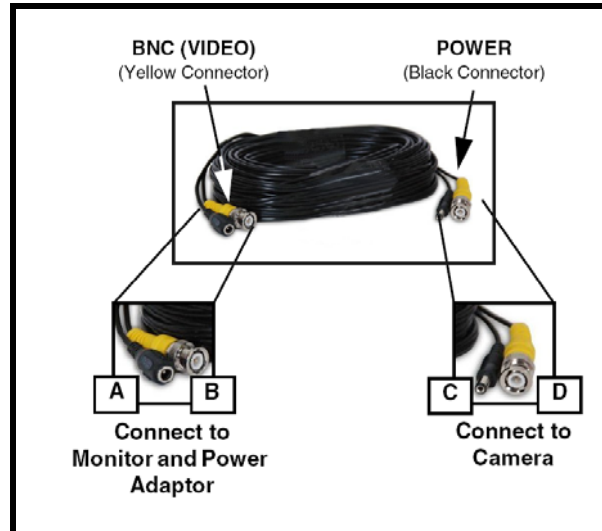

2. Connect the Power Adaptor to a wall outlet.

IMPORTANT NOTE: The ends of the extension cable are NOT the same - one end has a Male power port, and the other has a Female power port. Before permanently running the Camera Extension Cable, make sure that the cable has been oriented between the Camera and the unit correctly.



Male Power Port - The male power port end of the Extension cable connects to the Camera.



Female Power Port - The female power port end of the Extension cable connects to the Power Adaptor.

Camera Connection Diagram

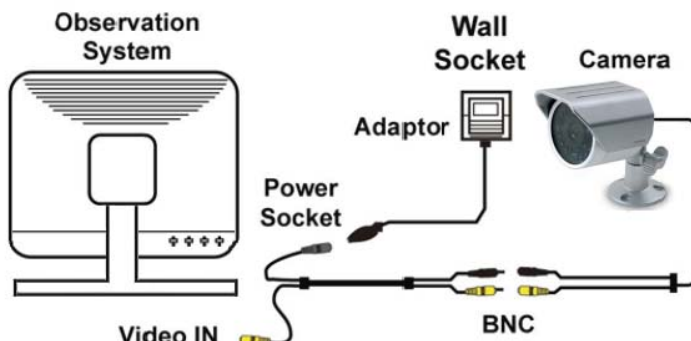

Connecting a Mouse

Connect a mouse to one of the USB ports located on the front of the unit.

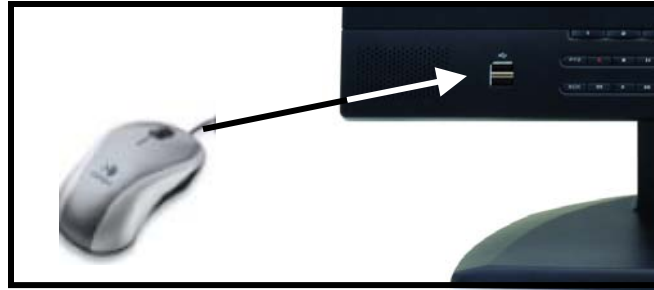

Mouse Controls

The mouse behaves in the same way as a PC mouse - using Left Click, Right Click and Wheel Rotation:

Left Click:

- Click the left mouse button to select an item.
- When in one of the multi-view formats (i.e. 2x2 or 3x3 view), clicking the mouse button on a camera image switches that camera to full screen. Clicking the mouse button again returns to the previous multi-view format.

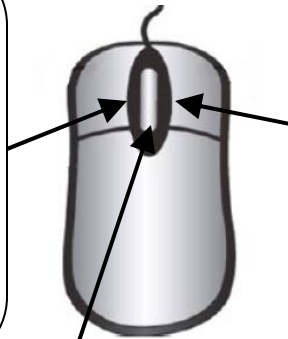

Mouse Wheel Rotation:

- In a full screen mode, you can change the live viewing channel number by rotating the mouse wheel.
- In a Menu Setup mode, you can change a value by rotating the mouse wheel.

Right Click:

- Clicking the right mouse button during live monitoring displays a Quick Links Menu.

SETUP MENU
KEY ADD FUNCTION
SEQUENCE
MUTE
AUDIO
PTZ
SCHEDULE RECORD
SEARCH

- Selecting the **SETUP MENU** option accesses the System Configuration menu (same as pressing the **MENU** button).
- Selecting all other options **ADD KEY FUNCTION ~ PTZ** behave in the same way as pressing the **[Fn]~ [PTZ]** keys (as shown in on the front panel button descriptions).
- Clicking the right mouse button again during a live menu screen returns to the previous menu screen.

NOTE: A three button mouse is required for the full range of mouse functionality to be available.

Display Modes

Initial Loading Sequence

The unit will automatically begin loading when power is connected to the system.

1. The System will perform a Hard Drive and Firmware check. During the loading sequence, the System will perform a Hard Drive and Firmware Check. During the loading sequence, the screen will display the message **SYSTEM CHECK**.
2. Once the system checks are completed, the screen will display the text message **INITIALIZING SYSTEM** before completing the loading process.
3. The unit will initially load to a split screen view, displaying all 8 cameras (if available) and a system legend in a 3x3 Screen View.

NOTE: Pressing the **POWER** button located on the front panel of the Observation System turns the Monitor ON/OFF only, and does not affect the actual power state of the System.



NOTE: If a new **HARD DRIVE** is detected, the system will prompt you to **FORMAT** the drive. If you do not choose to format the **HARD DRIVE**, the drive will not be detected by the system.

If you choose to **FORMAT** a drive in this way, the drive will no longer be readable by a regular PC without using the **HARD DRIVE VIEWER** software included on the CD provided with this unit

Press **ENTER** to choose the **OK** option and proceed with the format.

WARNING

NEW HDD FOUND IN
INTERNAL. YOU MUST
FORMAT IT TO RECORD.

OK

General Display Overview

1. TITLE & RECORDING STATUS – Displays the Title of the Camera (set in the System Menu), and the Recording Status:

- ●: Actively Recording
- E: Event
- C: Continuous
- +: Continuous & Event

2. CAMERA STATUS – Displays the current status of the camera. See below for details.

3. ONSCREEN LEGEND – Displays the Recording Legend for the Cameras.

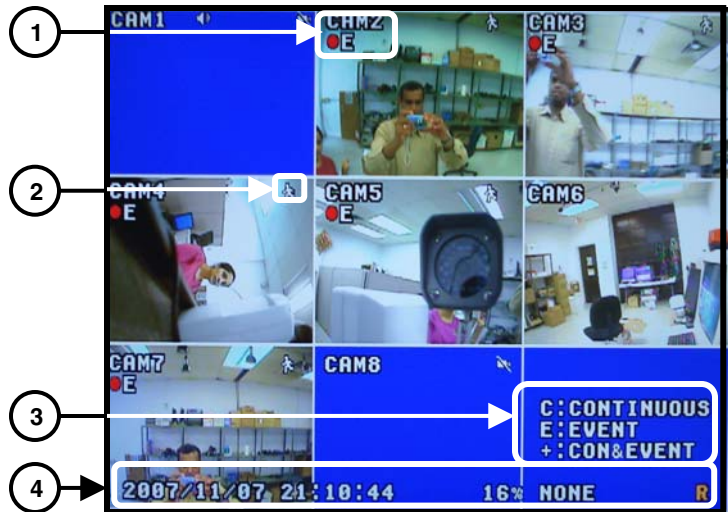

4. SYSTEM STATUS BAR – Displays the System status for:

- Date & Time – Set in the System Menu.
- HDD Full Status – Displays the amount of HDD used, or displays OVER when drive is full and overwriting.
- Logged in User: Displays the Logged in User Name (Displays NONE if a user is not logged into the system).
- R – Recording

Onscreen Icons – Legend

The following Icons may occasionally appear onscreen on each channel:



Alarm Input – Indicates that the corresponding Channel has an Alarm input connection (i.e. Door Sensor, Window Sensor, Motion Sensor).



Audio – The channel displaying this icon is the current Listen-In Audio channel.



Motion – Indicates that the channel is detecting Motion.



Network – Indicates that a remote connection has been made to the System.



PTZ – The channel is in PTZ control mode.



Sequence – Indicates that the system is currently sequencing between available channels.



Video Loss – The current channel does not have a camera connected / is not recognizing a camera is connected.



Mute – The Audio for the current channel is OFF.

Camera Display Modes

Cameras can be displayed in several different modes by pressing the **VIEW** Button on the front panel of the system, or by pressing the **VIEW** Button on the Remote Control. To view a single camera, press the corresponding number key on the Front Panel or Remote Control.

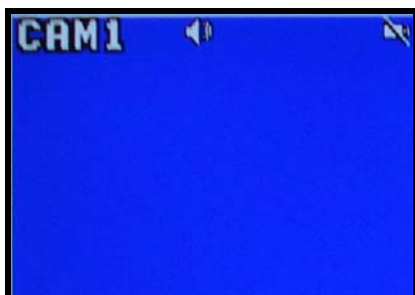

SINGLE CHANNEL VIEW – Press the corresponding Channel Number to view.



QUAD CHANNEL VIEW CAM 1-4 – Press the VIEW button to display the Quad View.



QUAD CHANNEL VIEW CAM 5-8 – Press the VIEW button to display the Quad View.



3x3 CHANNEL VIEW – Press the VIEW button to display all channels and legend.

Menu Navigation Controls & Tips

Menu Navigation Controls



- MENU Button – Accesses the setup menu, and returns to previous menu options.



- Navigation Controls - Move Up/Down/Left/Right.
- Enter Button - Press this button to select and change the values in a menu option.

Virtual Keyboard Control

The Virtual Keyboard control becomes available when keyboard input is needed for entering information such as Camera Names, Network Information, etc.

- Includes a~z, A~Z, 0~9, Symbols : < > = ? @ ! \ % & ' () * + , - _ . / and SPACE.
- Use the ← for backspace, and the X for delete.
- Navigate using the arrow keys on the Front Panel, Remote Control or Mouse.
- Use the ENTER key to choose the letters, numbers and symbols.
- Select the OK button once the setup is completed, or click CANCEL to exit without changing.



Active Option Indicator

Setup Menu

- Use the ARROW keys to move the YELLOW highlight. Press ENTER to select the option.



Changing Settings

- Use the ARROW keys to move the ORANGE highlight. Press ENTER to select the option.
- Use the ARROW keys to change the value (or access the Virtual Keyboard). The option will appear in RED when actively being changed. Press ENTER to accept the change.



System Setup Controls

- Enter the **MENU** screen by pressing the **MENU** button. Enter the password (if required) to display the graphical Menu Selection Screen. The Default password is <blank> - press **ENTER**.
- Scroll through the 8 options by pressing the **UP**, **DOWN**, **LEFT** and **RIGHT** buttons on the Front Panel or Remote Control.
- To enter a sub-menu, navigate to the option and press the **ENTER** button. To exit a **SUBMENU**, press the **MENU** button.
- To exit the MAIN MENU, press the **MENU** button.

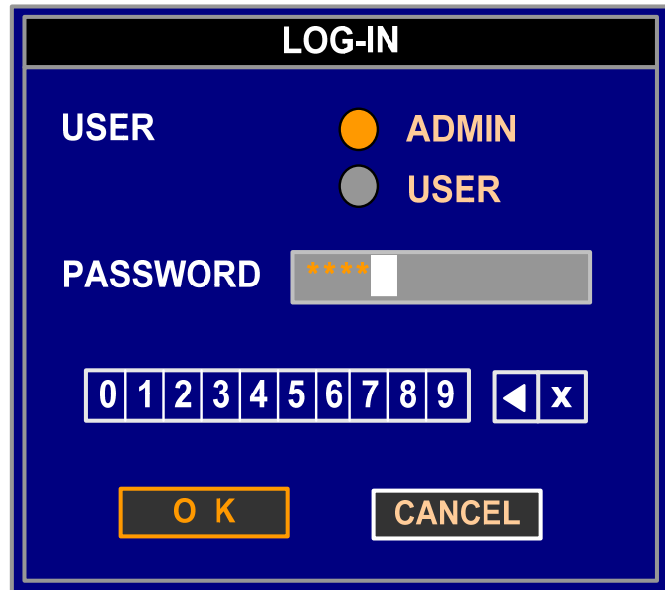

Setup Menu - Options

The Setup Menu has 8 icons representing each menu selection:

- **SYSTEM** - The system menu contains basic configuration settings, such as Time/Date, Language, User, Disk Management, Information, Factory Default, S/W Update, System Log and Screen Save.
- **EVENT** - This menu contains the event options such as Alarm-In, Motion, Video Loss, Text-in, System Event, and Action.
- **RECORD** - This menu contains the recording settings such as Resolution, Speed, Quality, and Schedule.
- **ARCHIVE** - Controls all archive devices (to archive recorded data).
- **CAMERA** - You can configure settings for the input and output of the system.
- **DISPLAY** - You can change configurations of information to be displayed on the screen
- **PTZ** - This menu enables PTZ-camera-related configurations such as controlling the direction, zoom, and iris. Controls the setup of PTZ Cameras (not included).
- **NETWORK** - You can configure settings for TCP/IP, the serial communication, DDNS, Notification, and Site.



System Menu Tree

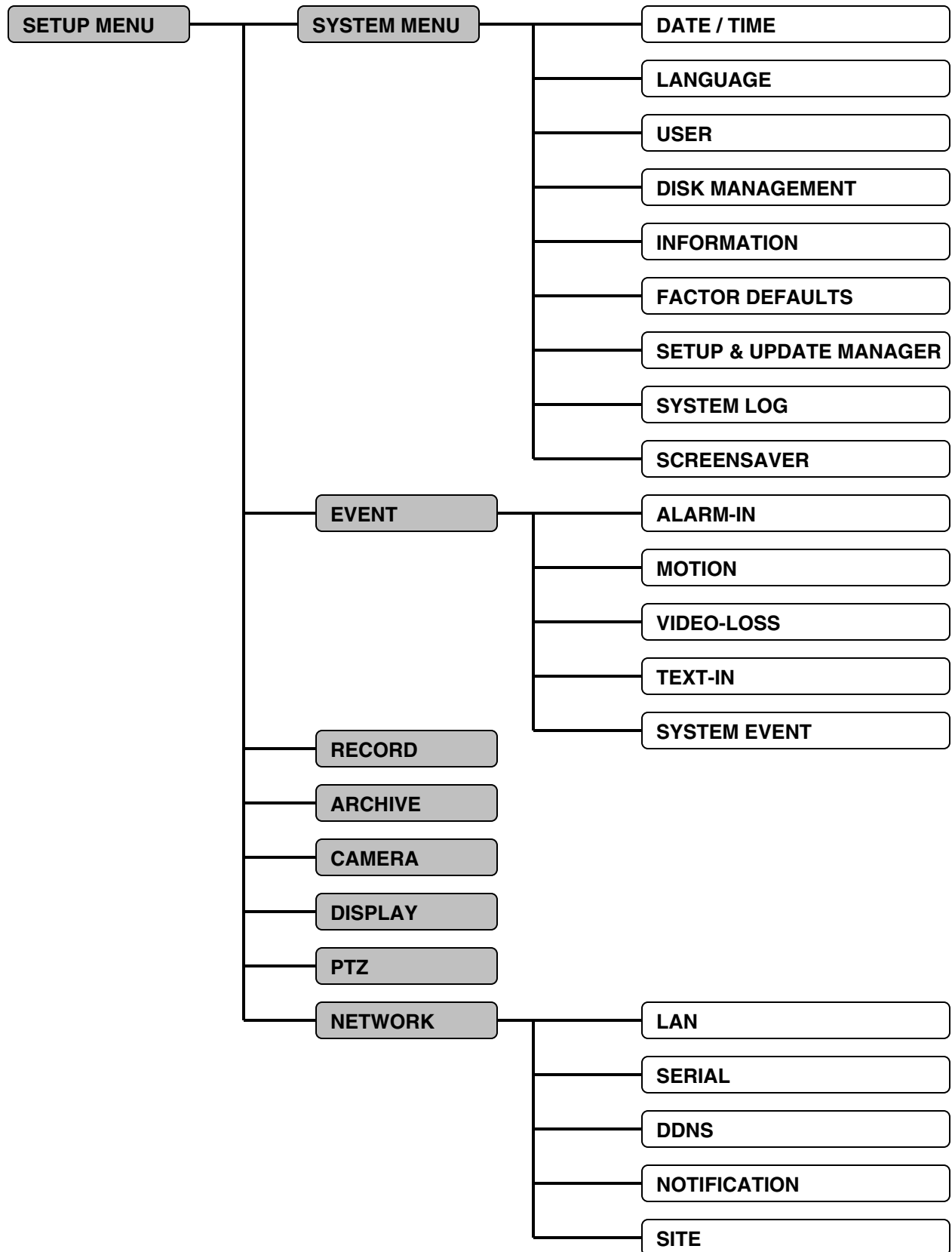

System Menu

- Date / Time – Set the Date and Time for the system.
- Language – Select the GUI Language display
- User – Configure the system users
- Disk Management – Controls the overwrite and format of the drive
- Information – Displays the System information
- Factory Default – Restores the unit to factory presets.
- Setup & System Update Manager – Updates the system firmware.
- System Log – Displays a log of events.
- Screen Saver – Configures the Screen Saver feature.

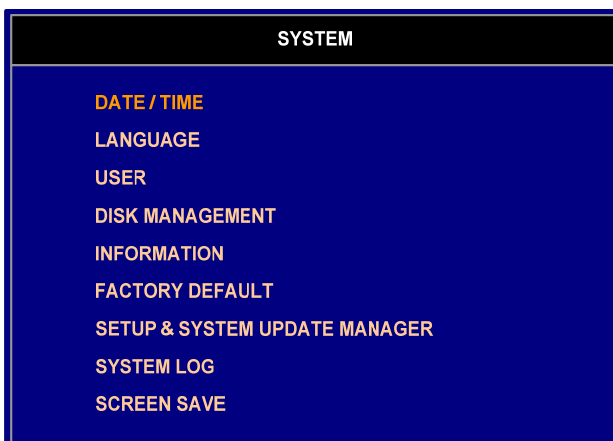

Date / Time

Set the System Date, Time and Format.

- SETUP – Contains the date configurations for the system:
 - Date: Set the Year / Month / Day
 - Time: Set the Time in either 12 or 24 hour format (set in the Format Section)
 - Time Zone: Set the Time Zone local to the System (GMT = 0)
 - DST ON/OFF: Turns Daylight Savings time ON or OFF.
- FORMAT – Sets the display format for the Date and Time:
 - Date: Set the Date format to YYYY/MM/DD, MM/DD/YYYY or DD/MM/YYYY
 - Time: Set the Time to a 12 or 24 hour clock.
- TIME SYNC – Configures a Time Server to synchronize the Date and Time on the System:
 - Interval: Set the Interval to OFF (not using a Time Server), or set the Time Server Check time to 1 hour, 2 hour, 3 hour, 6 hour, 12 hour or one day.
 - Server: Enter the Address of the Network Time Server using the Virtual Keyboard.

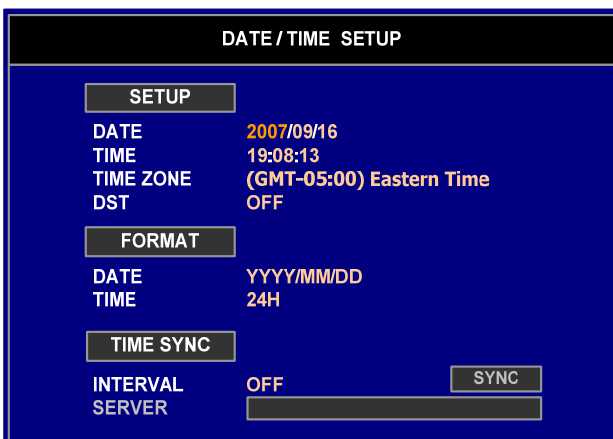

Language Setup

Set the onscreen GUI language display to English, French or Spanish.



User Setup

Configure users for the Local System and for Remote Access.

- **ADMIN** – The Admin login has full permissions to the system. Select the **PASSWORD SET (Figure 1)** option to change the password.
- **USER** – The User login has variable permissions to the system. Select the **PASSWORD SET (Figure 1)** and **ACCESS SET (Figure 2)** options to configure the user.

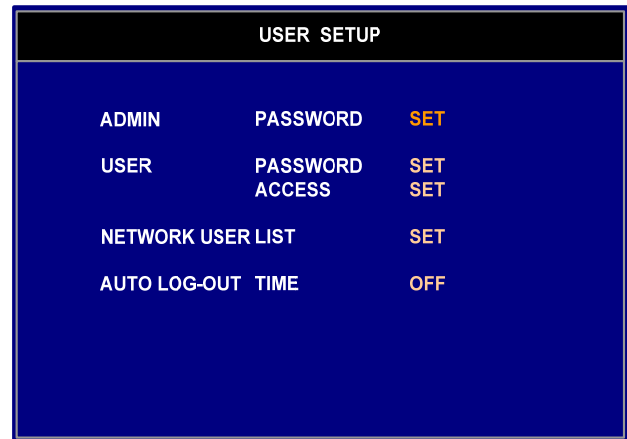

Figure 1.

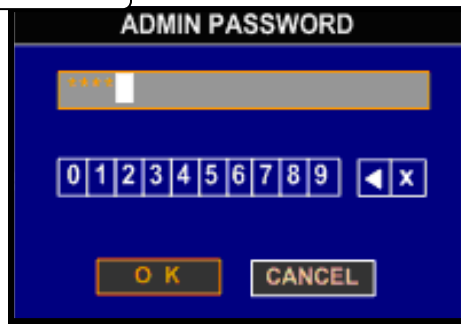
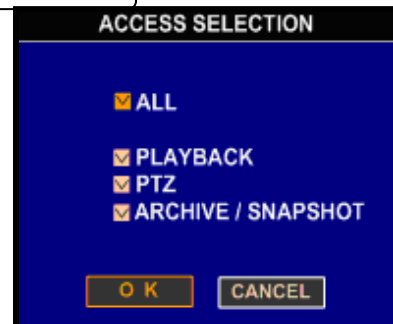

Figure 2.



NOTE: The Password Window and Access Window will look the same for all User Setups (Admin, User and Network Users).

User Setup (cont.)

- **NETWORK USER LIST** – The Network List allows for 10 Users to be added to the system. Each user has variable permissions to the system.
 - **ID:** Enter an ID for the User, using the Virtual Keyboard.
 - Select the **PASSWORD SET** (Figure 1) to set the user password.
 - Select the **ACCESS SET** (Figure 2) options to configure the users.
 - Use the **NEXT** button to switch between Users 1~5 and 6~10.
- **AUTO LOGOUT TIME** – Set the length of time that it will take for the logged in user to expire. Set to 1 min, 3 min., 5 min., 10 min., 30 min., 60 min. or OFF (A login password is always required).

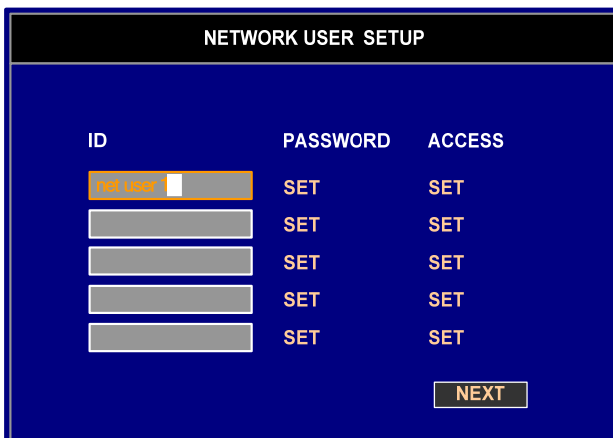

Disk Management

Recorded data is saved to the installed Hard Drive, and can be backed up to a USB storage device.

The Disk Management section displays the name and basic hardware information of each device.

- **RECORD MODE** – Sets the system to either:
 - **OVERWRITE** old data once the drive is full
 - **STOP** recording once the drive is full.
- If the Record Mode setting is set to **STOP**, additional settings are available:
 - **DISK FULL WARNING:** Set the percentage of disk space to be used before displaying a DISK FULL warning (OFF, 80~99%)
 - **DISK FULL ACTION:** Sets the system to display a Message when the drive is nearing full capacity.
- **MIRROR** – Turns real time data mirroring (backup to a second drive) to ON or OFF.

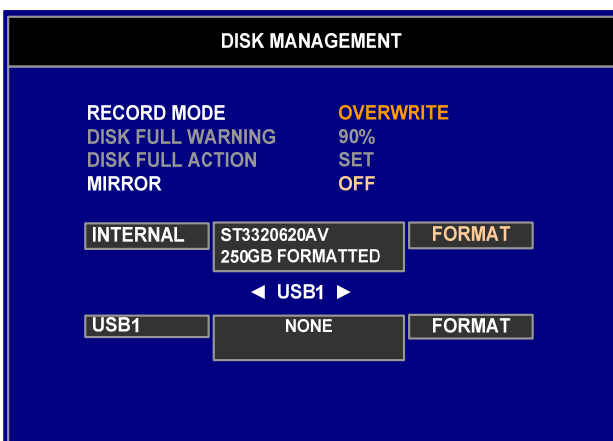

NOTE: Mirroring means that the system will record video to the local drive and automatically copy it to an external disk. The capacity of the external drive should be greater than or equal to the size of the internal hard disk.

Disk Management (cont...)

The Disk Management section also displays information about the Internal and USB drives including:

- Device Name
- Disk Size
- Format Button – Formats the drive. All data on the drive is erased.



NOTE: If you disconnect the USB cable connected to the USB port or the power from the USB device while mirroring, the system display a warning message and execute an e-mail notification. If the USB cable is disconnected while mirroring, mirrored data might be lost.

System Information

Displays details about the System and System Setup. This information is View only, and cannot be changed from this screen.

NOTE: Pressing the ENTER button from the Camera View screen will also display the System Information screen.

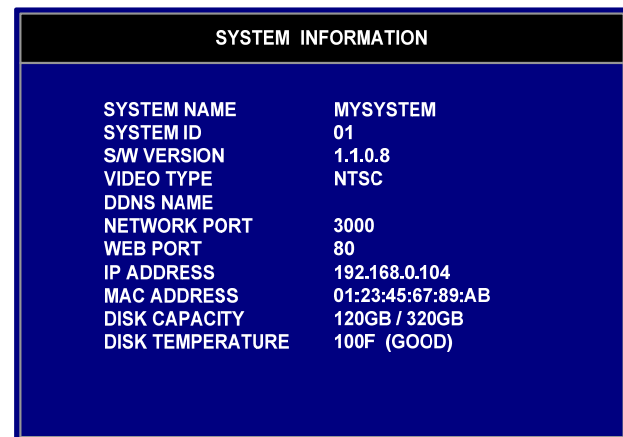

System Information

Resets the system to Factory Defaults.

NOTE: All settings will be erased.

Check SETUP to reset the system settings, and/or check SYSTEM LOG to clear the system log.

Press OK to reset, or CANCEL to exit with no change.

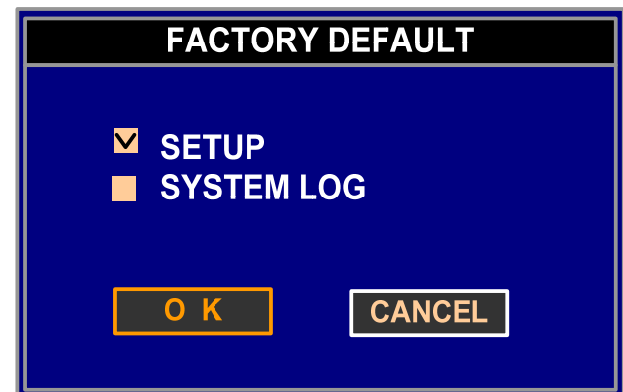

Setup & System Update Manager

The Setup & System Setup menu allows the user to create a backup of the system settings, import the system settings, and update the Firmware.

To make a backup copy of the System Settings, connect a USB memory stick to the System and select EXPORT. Enter a name for the backup, and select OK.

To import previously saved settings, choose the IMPORT option. Select the OK button to load the settings.

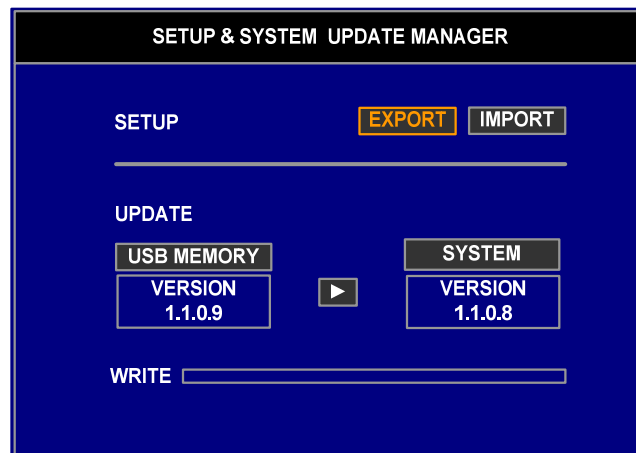

To update the System Firmware, first download the most up to date version from the web at <http://www.lorexctv.com> and save the file to a USB Memory Stick.

Once the Memory stick is connected to the system, select the Update version, and select OK.

NOTE: All previous settings will be lost.



System Log

The System Log displays a listing of events that occurred in the System.

Select the OPTION button to set the Search Criteria to display the list of System Events.

OPTION Settings include:

- **FROM** – Set the start date
- **TO** – Set the end date
- **TYPE** – Set the search criteria:
- **All:** Select All Events
- **Single Settings:** Choose from
 - Start Up
 - Setup Begin
 - Setup End
 - Record ON
 - Record OFF
 - Remote Setup Write
 - Remote Setup Read
 - Backup Begin

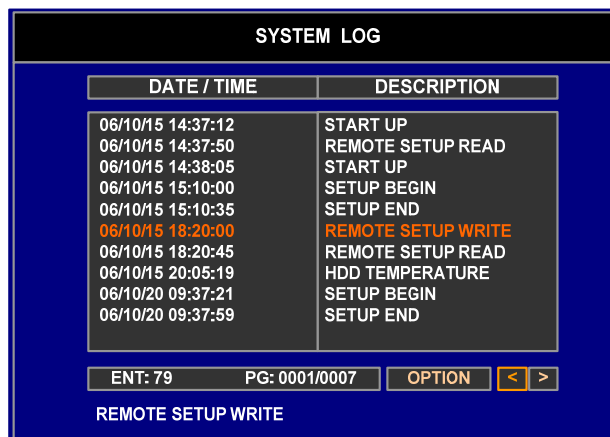

- Backup End
- Backup Fail
- Backup Cancel
- Setup Change
- Time Change (User)
- Time Change (NTP)
- Time Change (RTC)
- Zone Change
- Clip-Copy Begin
- Clip-Copy End
- Clip-Copy Fail
- Clip-Copy Cancel
- Disk Hot
- Format (Internal)
- Format (USB)
- System Update
- Factory Default
- Disk Full
- Email Send fail
- Disk Smart Bad
- Mirror Fail

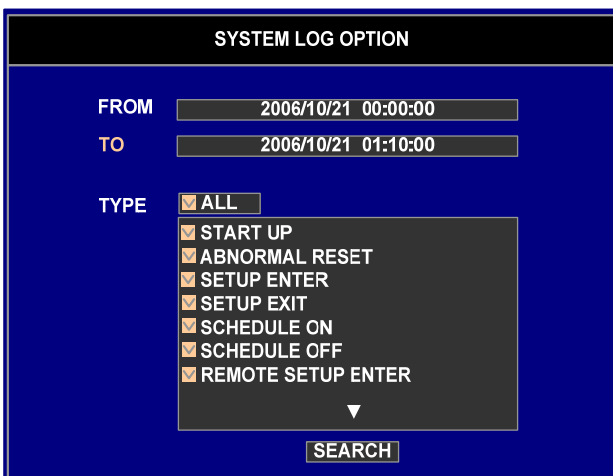

NOTE: Up to 20,000 events are recorded.

Screen Save Setup

The Screen Save feature will turn the monitor screen ON/OFF automatically.

NOTE: The DVR will continue recording when the Monitor is OFF.

- **ON/OFF** – Turns the Screen Save feature ON or OFF. Other menu items are available when set to ON.
TYPE – Set the screen save type to TIME (Time specific setting becomes available) or AUTO (automatic setting becomes available).
- **TIME** – Set the SCREEN ON and SCREEN OFF times (in 24hr clock). The monitor will automatically turn on and off at the specified times.
- **AUTO** – Set the screen saver timeout to 1 min, 5 min, 10 min, 30 min or 1 hour.

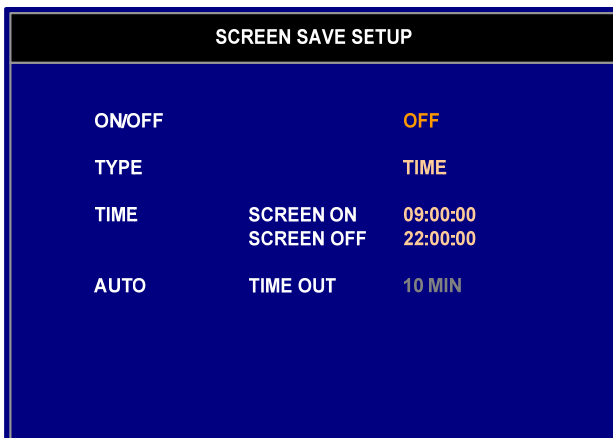

Event Menu

- Alarm-In – Sets the system notifications and controls when an event is triggered on an Alarm IN device.
- Motion – Sets the options for Motion Detection and notification.
- Video Loss - Sets the system notifications when a Video Loss event is detected.
- Text-In – Sets the options for processing Text-In (i.e. from a Point of Sale machine).
- System Event – Sets the notifications for system events.



Setup

Sets the system notifications and controls when an event is triggered on an Alarm IN device.

- **HOLD TIME** – Set the length of time that the event action will occur (i.e. Buzzer, Onscreen display, etc.)
- **ALM1~8** – Sets the alarm for each channel to ON or OFF.
- **TYPE** – Set the Type of Alarm to Normally Open (NO) or Normally Closed (NC)
- **ACTION** – Set the behavior for the system when an event is detected on the specified channel:
 - **All:** All actions occur
 - **Relay:** A relay output will occur to the Alarm-Out function
 - **Buzzer:** An audible buzzer will sound when an event is detected.
 - **Email:** An email will be sent (based on user and LAN settings)
 - **Network:** An alert will be sent to the remote client (based on LAN settings).
- **RECORD** – Select the cameras to record when an event is detected. Select ALL Cameras, each camera separately or a combination of individual cameras.

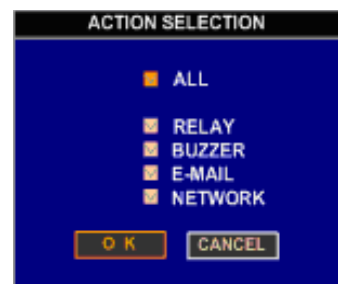
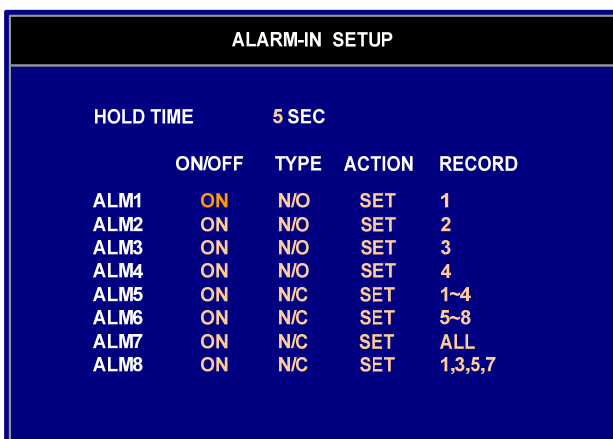

Motion Setup

Controls the actions when Pixel-based motion is detected on a Channel.

- **HOLD TIME** – Set the length of time that the event action will occur (i.e. Buzzer, Onscreen display, etc.)
- **CH1~CH8** – Sets the alarm for each channel to ON or OFF.

- **ZONE** – Set the Motion Detection Area for each camera:
 - **Grid:** Select blocks in the grid to turn the motion detection area ON or OFF. (Clear = ON, Pink = OFF).
 - **Set All:** Turns on all sections
 - **Clear All:** Turns off all sections
 - **Inverse:** Reverses the current setup
 - **Test:** Test the motion detection on that camera. Detected fields are highlighted.

- **ACTION** – Set the behavior for the system when an event is detected on the specified channel:
 - **All:** All actions occur
 - **Relay:** A relay output will occur to the Alarm-Out function
 - **Buzzer:** An audible buzzer will sound when an event is detected.
 - **Email:** An email will be sent (based on user and LAN settings)
 - **Network:** An alert will be sent to the remote client (based on LAN settings).

- **RECORD** – Select the cameras to record when an event is detected. Select ALL Cameras, each camera separately or a combination of individual cameras.

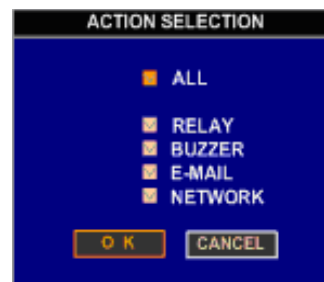
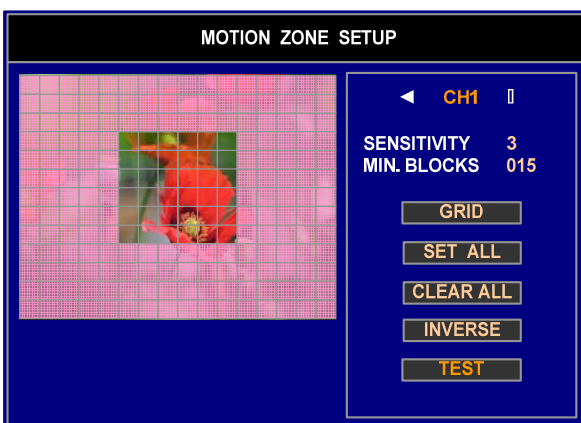
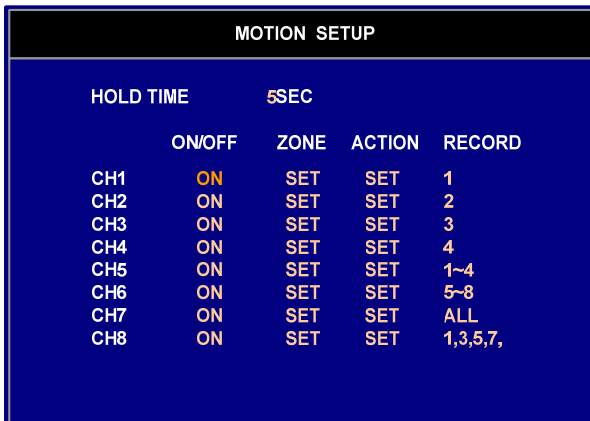

Video Loss

Controls the actions when a video loss is detected on a Channel.

- **HOLD TIME** – Set the length of time that the event action will occur (i.e. Buzzer, Onscreen display, etc.)
- **CH1~CH8** – Sets the alarm for each channel to ON or OFF.
- **ACTION** – Set the behavior for the system when an event is detected on the specified channel:
 - **All:** All actions occur
 - **Relay:** A relay output will occur to the Alarm-Out function
 - **Buzzer:** An audible buzzer will sound when an event is detected.
 - **Email:** An email will be sent (based on user and LAN settings)
 - **Network:** An alert will be sent to the remote client (based on LAN settings).
- **RECORD** – Select the cameras to record when an event is detected. Select ALL Cameras, each camera separately or a combination of individual cameras.

VIDEO LOSS SETUP			
HOLD TIME	5SEC		
	ON/OFF	ACTION	RECORD
CH1	ON	SET	1
CH2	ON	SET	2
CH3	ON	SET	3
CH4	ON	SET	4
CH5	ON	SET	1~4
CH6	ON	SET	5~8
CH7	ON	SET	ALL
CH8	ON	SET	1,3,5,7,

Text-In Setup

Controls the Text-In setup for text overlay on the Video Image from another device (i.e. Point of Sale).

Select each camera to record when Text IN is detected. A pop-up window will appear for each channel selected in this way.

- **ON/OFF DISPLAY** – Turns the Text-IN option ON or OFF. Check the Display box to display the text onscreen.
- **HOLD TIME** – Sets the event hold time from the first detection of the event.
- **ACTION** – Set the behavior for the system when an event is detected on the specified channel:
 - **All:** All actions occur
 - **Relay:** A relay output will occur to the Alarm-Out function
 - **Buzzer:** An audible buzzer will sound when an event is detected.
 - **Email:** An email will be sent (based on user and LAN settings)
 - **Network:** An alert will be sent to the remote client (based on LAN settings).
- **RECORD** – Select the cameras to record when an event is detected. Select ALL Cameras, each camera separately or a combination of individual cameras.
- **PRODUCT TYPE** – Sets the detection type to Generic Text input.

TEXT-IN SETUP	
ON/OFF	ON <input checked="" type="checkbox"/> DISPLAY
HOLD TIME	5SEC
ACTION	SET
RECORD	ALL
PRODUCT TYPE	GENERIC TEXT
TRANSACTION	
START	POS
END	END
DELIMETER	
IGNORE	

- **TRANSACTION** – Set the text-in detection fields:
 - **Start:** Set the word or characters that indicate the start of a POS transaction.
 - **End:** Set the word or characters that indicate the end of a POS transaction.
 - **Delimiter:** sets the End of line character. If not entered, the System assumes that “Enter and Line Feed” is the next line.
 - **Ignore:** Set any text to be excluded from onscreen display.

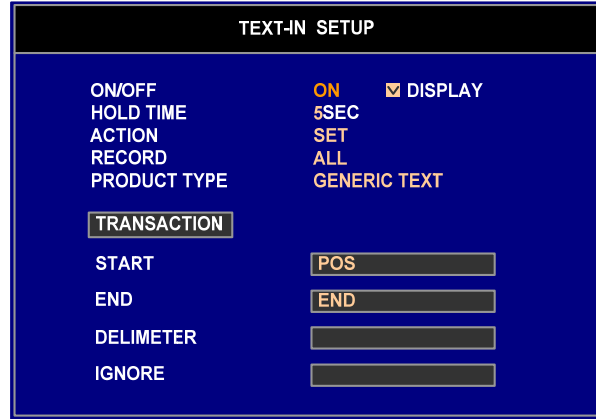

System Event Setup

The System Event menu controls the actions the system takes when specific events are detected.

Disk Temperature

Set the actions to take when the system temperature is too high.

- **ON/OFF**– Turns the Temperature detection ON or OFF.
- **TYPE** – Set to Fahrenheit or Celsius
- **LIMIT** – Set the upper temperature limit. Once this limit has been reached, the system notification will occur.
- **HOLD TIME** – Sets the event hold time from the first detection of the event.
- **ACTION** – Set the behavior for the system when an event is detected on the specified channel:
 - **All:** All actions occur
 - **Relay:** A relay output will occur to the Alarm-Out function
 - **Buzzer:** An audible buzzer will sound when an event is detected.
 - **Email:** An email will be sent (based on user and LAN settings)
 - **Network:** An alert will be sent to the remote client (based on LAN settings).

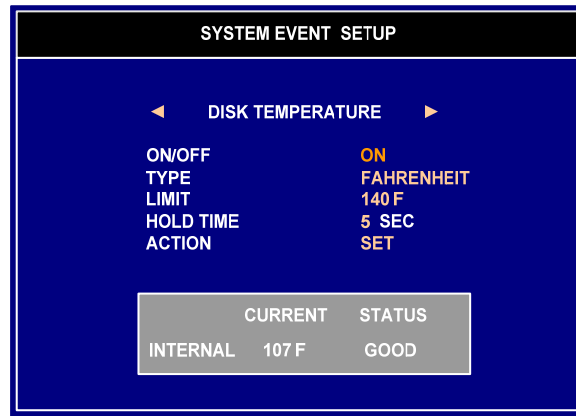

Disk S.M.A.R.T

If the IDE hard disk installed in the system supports S.M.A.R.T. (Self-Monitoring Analysis and Reporting Technology), the status of the installed IDE hard disk is displayed.

- **ON/OFF**– Turns the Temperature detection ON or OFF.
- **HOLD TIME** – Sets the event hold time from the first detection of the event.
- **ACTION** – Set the behavior for the system when an event is detected on the specified channel:
 - **All**: All actions occur
 - **Relay**: A relay output will occur to the Alarm-Out function
 - **Buzzer**: An audible buzzer will sound when an event is detected.
 - **Email**: An email will be sent (based on user and LAN settings)
 - **Network**: An alert will be sent to the remote client (based on LAN settings).

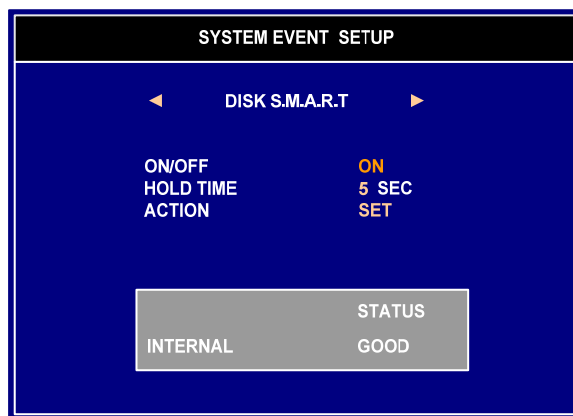

Record Menu

The recording menu controls the settings for each camera for basic and scheduled recording.

- **SCHEDULE** – See below.
- **RESOLUTION** – Set the size of the recorded images to 704 x 480, 704 x 240, or 352 x 240.
- **PRE-EVENT** – See below.
- **CH1~CH8 VIDEO** – Turns the recording for each channel to ON or OFF.
- **CH1~CH4 AUDIO** – Turns the audio recording ON or OFF for channels 1~4 only.
- **SPEED C/E** – Set the recording frames per second (FPS) when in Continuous Recording or in Event recording (for each channel)
- **QUALITY C/E** – Set the recording quality (Low, Normal, High or Best) when in Continuous or Event recording (for each channel).

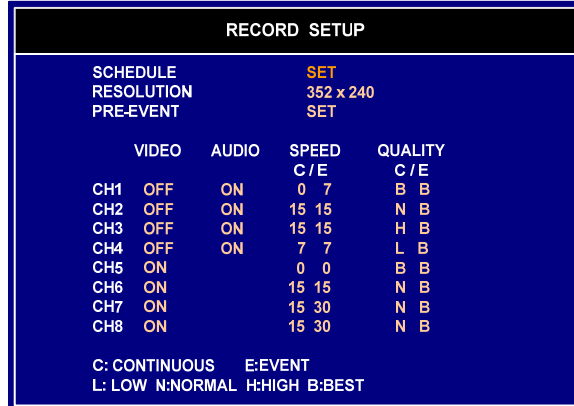

Schedule Setup

Set the daily recording schedule for each channel.

NOTE: Pressing the FN key on the front panel will apply the specific settings to all channels.

Set each block in the 24hour grid to C (Continuous), E (Event) or + (Both Continuous and Event).

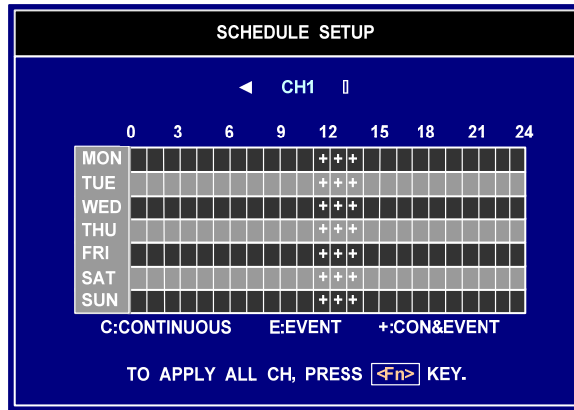

Pre-Event Setup

Set the pre-recording time for each channel. Pre-recording will add video to the beginning of the recorded data when an event is detected.

- **CH1~CH8** – Turns the pre-recording for each channel to ON or OFF.
- **DWELL TIME** – Set the dwell time between 5~30 seconds.



Archive Menu

The archive menu allows the user to backup data to a USB Memory Stick or Hard drive, CD-RW or DVD-RW Drive.

Note: You can enter the ARCHIVE menu directly from Live monitoring mode by pressing the COPY key on the front panel.

- **TYPE** – Set the archive type to Backup (backup all data for a specific date range) or Clip Copy (select individual video clips).
- **STORAGE** – Select the connected backup media device (Note: The device will only display in the list when connected to the system).
- **FROM** – Set the backup start date.
- **TO** – Set the backup end date.
- **CHANNEL** –Click to select individual channels, or all channels. Click the checkbox to backup audio.
- **ESTIMATE BUTTON** – Click to determine the total drive space needed for the selected backup.
- **FILE NAME** – Enter a file name for the backup using the virtual keyboard
- **WRITE STATUS BAR** – Displays the status of the backup.
- **UPDATE BUTTON** – Refreshes the backup status
- **START BUTTON** – Starts the backup

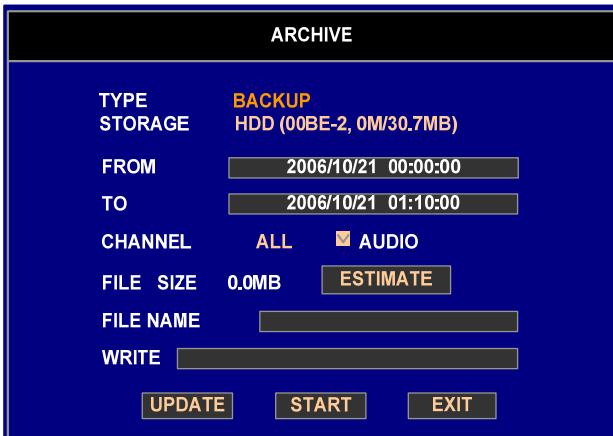

Note: The maximum data size to be copied for CLIP-COPY is limited to 2GB, and the copied clip data can be played by the Lorex Player on a windows PC.

Caution: Removing a connected backup device during the backup process may result in serious damage to the system.

The LCD Combo DVR supports multi-session recording for CD-R/W, allowing the system to execute a clip-copy multiple times (i.e. If you have 750MB CD and an estimated file size for clip-copy is 100MB you can copy clips 7 times.)

The System has Lorex’s unique file system - the files stored in the internal storage or backup files cannot be played without using the System or Lorex Software.

1. The capacity of HDD for the Mirror or Backup should be bigger than or equal to one of internal hard disk.
2. Available CD(DVD) media: CD–R, CD–RW, DVD–R, DVD+R and DVD–RW
3. The capacity of USB stick should be greater than or equal to 128MB

ITEM	ARCHIVE		MIRROR
	BACKUP	CLIP-COPY	
Description	Clips a video segment already stored in the storage and saves it to the external storage.		Records a video to the internal storage and copies it to the external storage at the same time.
Available Media	USB HDD ¹	USB CD-RW USB DVD-RW ² USB STICK ³	USB HDD ¹
Maximum File Size (per 1 times)	300GB	2GB	-
Playback	Windows	X	o
	DVR Combo	o	X

Camera Menu

Controls the settings for individual cameras.

- **COVERT** – Turns the onscreen display of the camera ON or OFF. The camera remains recording when in Covert.
- **NAME** – Use the virtual keyboard to set a camera description.
- **BRIGHTNESS / CONTRAST / HUE / SATURATION** – Set camera display settings using the slider bars.
- **RESET** – Resets the camera to default settings.



Display Setup Menu

Controls the settings for the Onscreen Display.

- **SEQUENCE DWELL TIME** – Sets the time that each camera is displayed onscreen when in Sequence Mode. Set between 1~99 seconds.
- **EVENT SCREEN MODE** – Set the mode to CHANGED to allow the system to switch to a channel when an event is detected.
- **OSD**– Set the items to display on the main video display screen:
 - **Date/Time**
 - **Disk Size**
 - **Audio Output**
 - **User**
 - **Event Mark**
 - **Cam Name**
 - **Network Connection**
 - **PTZ Control**

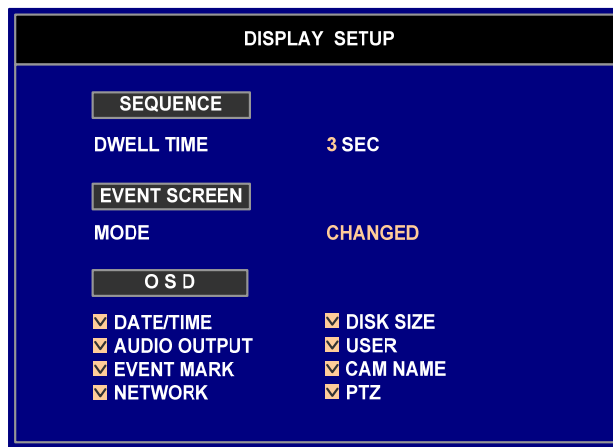

SEQUENCE Control

Pressing the **SEQ** key in the live view mode causes the system to display live channels sequentially.

In full screen mode, the system sequences through the cameras and displays them full screen. In the multi screen mode, the system displays the 2x2 live screens sequentially.

For example, if the system is in the full screen mode or the 3x3 screen, the onscreen display will appear in sequence as:

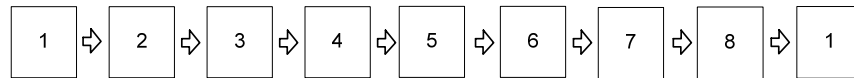

If the system is in the 2x2 screen mode (Quad), the onscreen display will appear in sequence as:

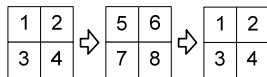

Press the **SEQ** key to exit the sequence mode.

PTZ Setup Menu

Setup controls for a PTZ Camera (Not included).

- **CH1~CH8 PTZ** – Sets the channel to ON or OFF for PTZ Camera use.
- **PROTOCOL** – Set the protocol for use with the camera. Refer to the specific camera guide for information.
- **ID**– Set the ID for use with the camera between 0~255. Refer to the specific camera guide for information.

PTZ SETUP			
	PTZ	PROTOCOL	ID
CH1	ON	Fastrack-II	00
CH2	OFF	Fastrack-II	00
CH3	OFF	Fastrack-II	00
CH4	OFF	Fastrack-II	00
CH5	OFF	Fastrack-II	00
CH6	OFF	Fastrack-II	00
CH7	OFF	Fastrack-II	00
CH8	OFF	Fastrack-II	00

Using the PTZ Camera Controls

The system can control cameras with Pan / Tilt /Zoom capabilities. Press the **PTZ** key on the front panel to enter the PTZ mode and press the button again to exit the PTZ mode. The camera is controlled using the front panel directional control buttons.



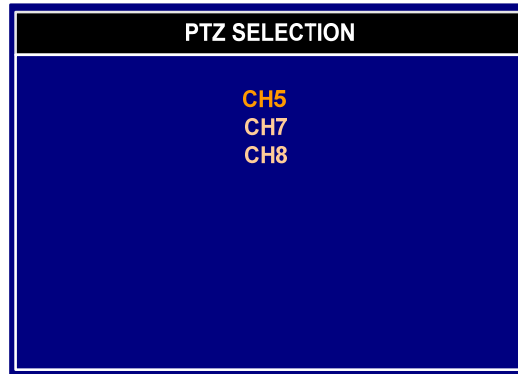

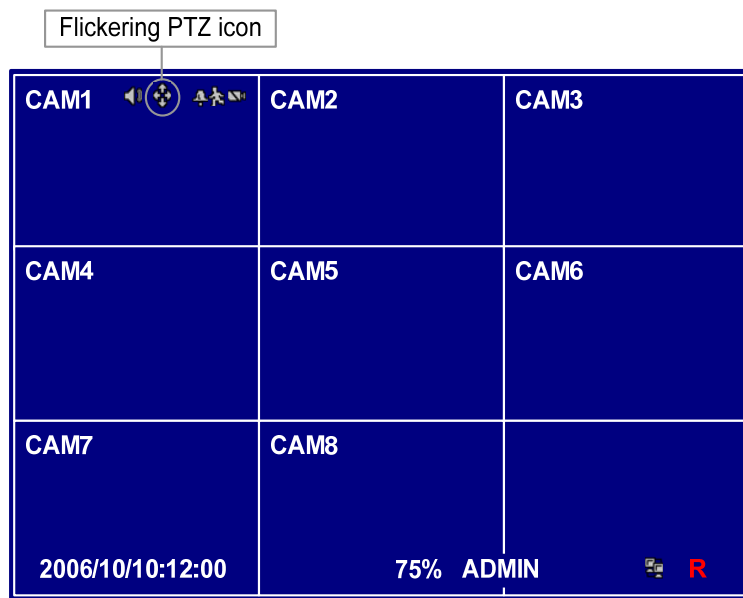

Press the **PTZ** key on the front panel. A pop-up channel select window for the PTZ cameras will be displayed. Select the PTZ camera to control by selecting it from the menu.



The PTZ icon  flickers on the PTZ camera screen. That means a live screen mode is converted to PTZ control mode.



To use the front panel buttons:

- Press the Left and Right arrow buttons to pan left and right.
- Press the Up and Down arrow buttons to tilt the camera Up and Down.
- Press the  button to zoom in, and press the  button to zoom out.
- Use the  and  buttons to focus the image.
- Press the  and  buttons to control the PTZ iris.

Preset positions can be set for the PTZ cameras. Press the  to establish Presets and enter a preset number. Press the **OK** button to save new settings or the **CANCEL** button to cancel new settings.

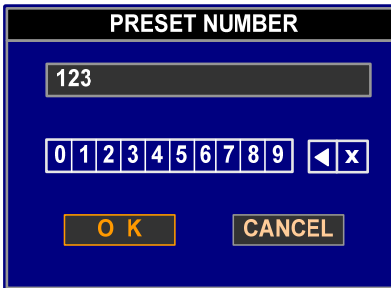

You can quickly move a PTZ camera to Preset position. Press the  to view an established camera Preset position and enter a preset number.

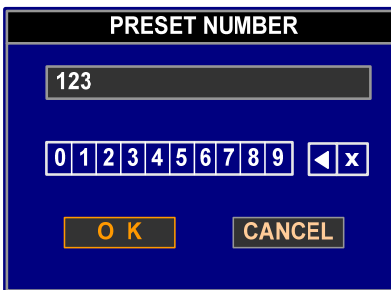

A Mouse can be used for easier PTZ control. Position the mouse pointer at the bottom of the screen in PTZ mode, and the following PTZ toolbar will display.

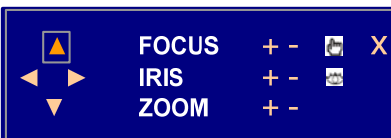

Clicking the **X** on the right side exits the toolbar. To display the toolbar again, position the mouse pointer at the bottom of the screen. Use the arrow buttons on the toolbar to pan or tilt the camera to the desired direction, and other individual controls on the toolbar perform Focus, Iris, Zoom, Set and Run.

Pressing the **PTZ** key on the front panel when in PTZ mode will display the PTZ function window as shown below. Expanded PTZ features are controlled in this mode.

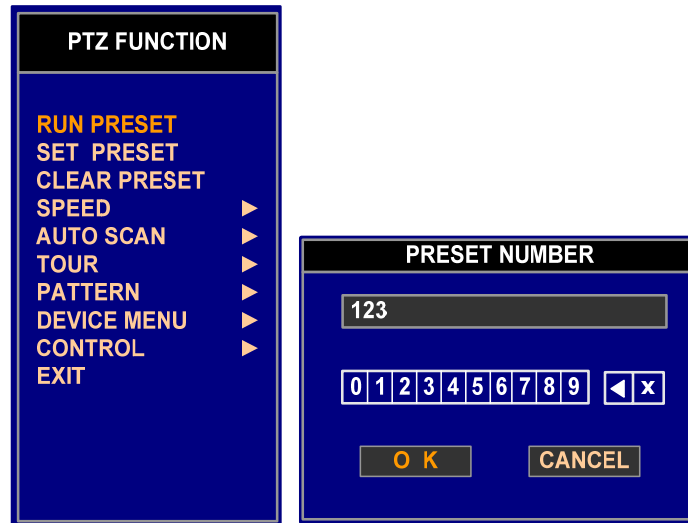

The Presets for PTZ can be configured or run in this window. The PRESET field enables PTZ camera related configurations such as controlling the direction, zoom, and iris. A maximum of 999 presets can be saved. Enter a preset number then, press the **OK** button. After that, if you select the RUN PRESET, the PTZ camera will move to the preset position and exit the PTZ function window.

Set the feature you wish to control by selecting it from the menu. Refer to the camera manufacturer's instructions for the proper settings.

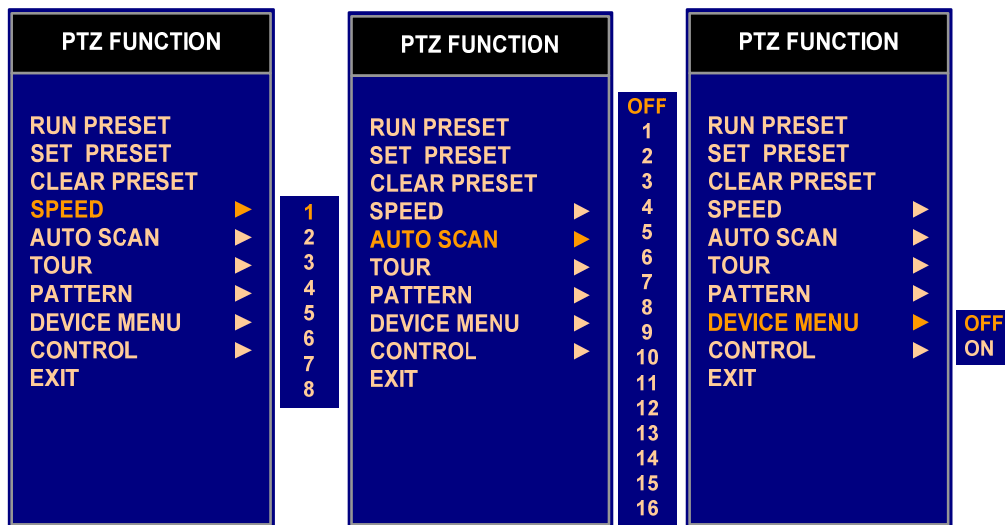

Select EXIT to exit the PTZ control mode.

NOTES:

- You will not be able to use Text-In if you are using the Serial port for PTZ control.
- Settings related to PTZ such as a product and brand name, ID, and serial information, should be predefined for the proper operation.

Network Setup Menu

Controls the network settings for:

- **LAN** – Network settings for the System
- **SERIAL** – Controls for serial devices (i.e. POS input).
- **DDNS** – Settings for remote access over the internet
- **NOTIFICATIONS** – Automatic email or network notification when an event occurs
- **SITE** – Controls the site specific settings.

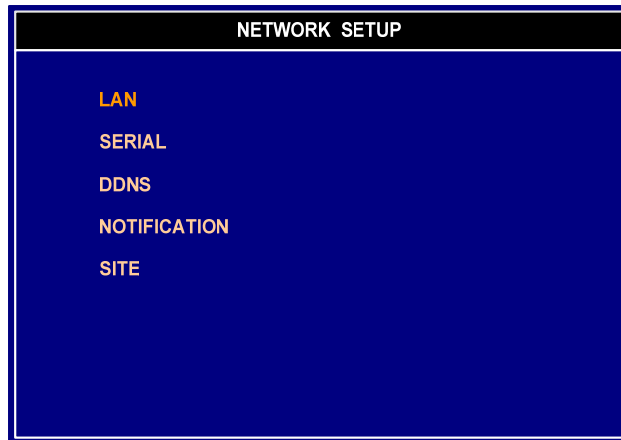

LAN Setup

Controls for the System network settings

- **TYPE** – Set the network setting detection to Manual or DHCP. If set to DHCP, the network information will be assigned by the network router.
- **TCPIP** – Setup for the system's network settings. IF set to DHCP, the settings will not be accessible. If set to Manual, the settings will need to be manually entered:
 - **IP Address**
 - **Subnet Mask**
 - **Gateway**
 - **DNS Server** – Is set in the system by default to point to the Lorex DDNS server. Do not change this unless advised by a technical support representative.
 - **Port** – Setup for the System Ports for remote connection.

NOTE: These ports will need to be changed if using multiple systems at one location.

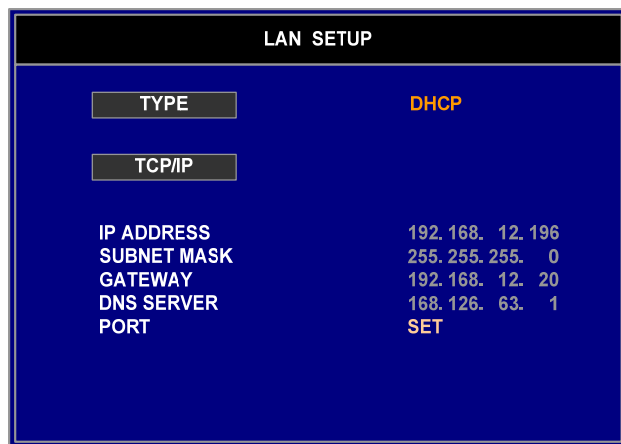

Serial Setup

Controls for the Serial setup for PTZ, Specialty Keyboard or Point of Sale (POS) system.

- **USE** – Set the device connected to the serial port to PTZ, Keyboard or POS.
- **PORT** – Contains the port specific settings. Please refer to the manual for the specific device for details:
 - **Baud Rate**
 - **Parity**
 - **Data Bit**
 - **Stop Bit**

SERIAL SETUP

USE

PTZ KEYBOARD POS

PORT

BAUD RATE (BPS)	9600
PARITY	NONE
DATA BIT	1
STOP BIT	1

NOTE: If you select PTZ (RS-485), you can't use POS or REMOTE (RS-232).

DDNS Setup

Controls for the settings for DDNS Remote connection.

- **ON/OFF** – Turn DDNS ON or OFF.
- **DOMAIN NAME / USER NAME / PASSWORD** - Enter the Domain Name, User Name and Password information received in email during the DDNS setup process at <http://ddns.strategicvista.net>
- Click the **CHECK** button to test the connection. A successful Connection message should appear.

DDNS SETUP

ON/OFF **ON**

DOMAIN NAME MYURL

USER NAME TOMSMITH1

PASSWORD *****

DDNS STATUS UNCHECKED **CHECK**

NOTE: You must restart the system to apply new setup about the DDNS.

Notification Setup

This menu enables notification of event information to Email or Network when an event occurs.

- **EMAIL SENDER** – Set the email address to appear as the Sender when an email is received.
- **RECEIPIENTS** – Set the list of email addresses to receive an email when an event occurs.
- **INTERVAL** – Set the notification interval between emails
- **LIMIT**- Set the maximum number of emails to be sent for a particular event.
- **NETWORK SITES SET** – Set the list of sites to receive emails when an event occurs.

NOTIFICATION SETUP

E-MAIL

SENDER: testmail@hanmail.net

RECIPIENTS: SET

INTERVAL: 10 SEC

LIMIT: 50

NETWORK

SITES: SET

Email Notifications:

The **E-MAIL** section allows the sending of an email to a designated address when an event occurs. Configure correct settings of SENDER and RECIPIENTS. You can register the e-mail address of recipients up to 5. Press the CHECK button to test the e-mail setup. The system displays the status result of connection test for each e-mail address.

Note: A correct address for both SENDER and RECIPIENT must be configured. The e-mail address must include the “@” character to be a valid address. You can use up to 40 characters including spaces.

Press the EXIT button to exit the e-mail notification window. Information about the time of event occurrence is sent along with the title and event content when an event occurs.

E-MAIL NOTIFICATION

SEND	STATUS	E-MAIL ADDRESS
ON	GOOD	user1@hanmail.net
ON	GOOD	user2@hanmail.net
ON	FAIL	user3
OFF	FAIL	
OFF	FAIL	

CHECK EXIT

For example, if a motion event occurs, an e-mail as below will be sent.

Subject: Event Notification, 2006/11/03 00:00:00

Contents:

2006/08/22 09:32:07 PM Motion 3

=====
 System ID : 0
 System Name: Home
 =====

Web Viewer: http://192.168.12.188

The “INTERVAL” represents the frequency of the e-mail notification when an event occurs. The “LIMIT” shows the maximum number of emails sent within each interval.

Network Notification:

The Network Notification feature sends an alert from the System to the remote client software (up to 5 instances of the Software Client). This feature is designed to work on the Local Area Network.

1. Run IPCONFIG on the PC with the installed Software Client to get the IP Address.
2. Set the IP Address location of the Lorex Client Software (The PC to receive the event notification) on the Network Notification screen.

These sites are part of the **NETWORK** section.

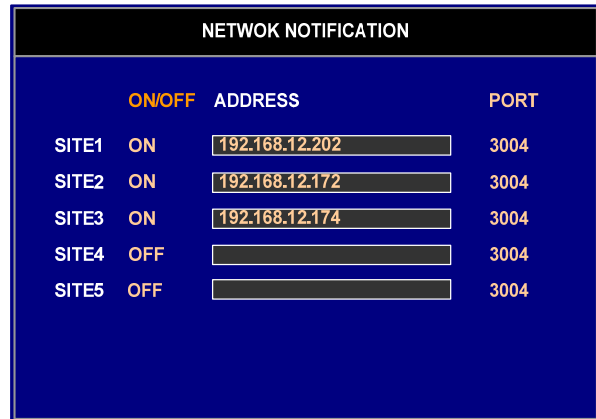

	ON/OFF	ADDRESS	PORT
SITE1	ON	192.168.12.202	3004
SITE2	ON	192.168.12.172	3004
SITE3	ON	192.168.12.174	3004
SITE4	OFF		3004
SITE5	OFF		3004

The Lorex Client Software (PCs) configured here can receive real-time information about events that occur on the system (when the software application is running). When ON/OFF is set to ON, events will be sent using the NETWORK notification.

SITE Setup

Configure the System Name and System ID in this menu. Use the Virtual Keyboard to assign a name to the System.

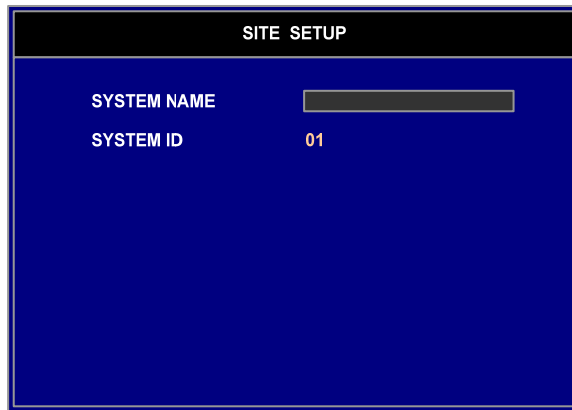

SYSTEM NAME	<input type="text"/>
SYSTEM ID	01

Additional Key Functions

Key Add Function

Pressing the **Fn** key on the front panel will display the key add function window.

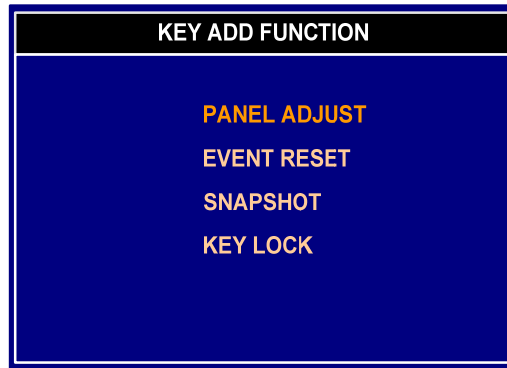

PANEL ADJUST

You can configure the brightness and contrast of the LCD panel. Pressing the SET item displays a control bar at the bottom of the live screen as follows.

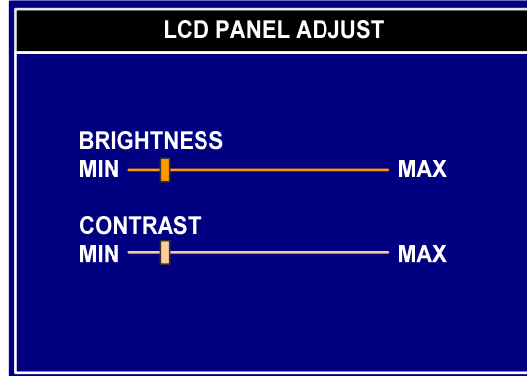

Press the **MENU** or **Fn** key to exit the LCD adjust mode.

EVENT RESET

Selecting "EVENT RESET" in the function screen causes the system to reset both the Alarm Output signal and the internal buzzer. This function is same as the one of the **ACK** key on the front panel.

SNAPSHOT

You can capture and save a still cut in the pause mode during the playback. First, insert the USB memory stick to the USB port in the front panel. Then, play a video and set screen mode to full screen for the channel you want to capture. After that, press the pause button in the capture position of video. Finally, Select SNAPSHOT in KEY ADD FUNCTION menu to capture and save a still cut.

This function is inactivated in the live monitoring mode or multi-screen playback mode.

Note: You can see a captured file in the clip player only.

KEY LOCK



Selecting “KEY LOCK” in the function screen causes the system to lock the buttons on the front panel from functioning.

6.2 AUDIO Control

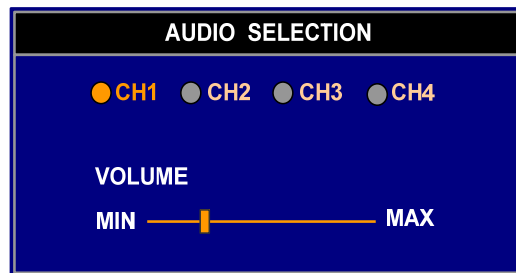
Pressing the **AUDIO** key on the front panel will display the audio window.



You can select an audio channel you want to connect. An audio icon,  will appear in the corner of a multi-screen to indicate audio is available on a particular channel.

Note: Pressing the **MUTE** key on the front panel causes the system to set the audio level to the minimum level. The system displays mute icon,  instead audio icon, . Pressing the button again toggles the mute between on and off

Increases or decreases the audio volume using the slider bar. To use the front panel buttons, press the Left and Right arrow keys to control the audio volume.

Playing Recorded Video

If a user with Search authority logs into the system, the user can view recorded video. Once video has been recorded, you can view it by pressing the **PLAY**, ► key on the front panel.

- When playing video for the first time, the system will display the most recently recorded video.
- When playing video any other time, the system will start playing video from the last image.

Recorded audio will be played while the system displays the camera with recorded audio.

PLAY Button

Pressing the ► button plays video forward at regular speed.

RW (Rewind) Button

Pressing the ◀◀ button plays video backward at regular speed. Pressing the button again toggles the playback speed between ◀, ◀◀, ◀◀◀ and ◀◀◀◀. The screen displays ◀, ◀◀, ◀◀◀ and ◀◀◀◀ respectively.

FF (Fast Forward) Button

Pressing the ►► button plays video forward at high speed. Pressing the button again toggles the playback speed between ►►, ►►► and ►►►►. The screen displays ►►, ►►► and ►►►► respectively.

PAUSE Button

Pressing the ■■ button freezes the video on the screen.

STOP Button

Pressing the ■ button while in the playback mode returns the system to the live screen mode.

Step Forward Button

Pressing the ►►► button plays step forward one frame in the pause mode.

Step Reverse Button

Pressing the ◀◀◀ button plays step reverse one frame in the pause mode.

Camera Button (1 to 8)

Pressing a camera button will display that camera full screen.

VIEW Button

Pressing the **VIEW** button will cycle the display through the different screen layouts. The display modes are: full, 2x2, 3x3.









Mouse Usage

The mouse can be used for easy playback control. Position the mouse pointer at the bottom of the playback screen, and the following search toolbar will display.



Clicking **X** on the left side exits the toolbar. To display the toolbar again, position the mouse pointer at the bottom of the playback screen.

The individual controls on the toolbar perform the following functions:

-  Go to the first image
-  Fast backward play
-  Play video backward at regular speed
-  Step backward one frame
-  Pause
-  Step forward one frame
-  Play video forward at regular speed
-  Fast forward play
-  Go to the last image

Clicking the right mouse button during playback displays the following menu:

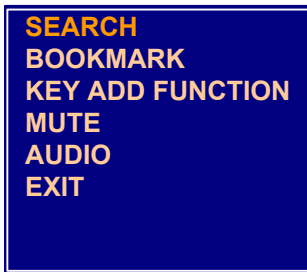

Selecting BOOKMARK, ADD KEY FUNCTION... and AUDIO... is the same as pressing the **MARK**, **Fn** and **AUDIO** keys as described in “2.2. Key Function”. Selecting SEARCH causes the system to enter the Search mode. Select EXIT to exit the playback mode.

Video Search

Pressing the **SEARCH** key on the front panel or the remote control enters the Search mode while in the Live monitoring mode or in the Playback mode. The Search function window will be displayed.

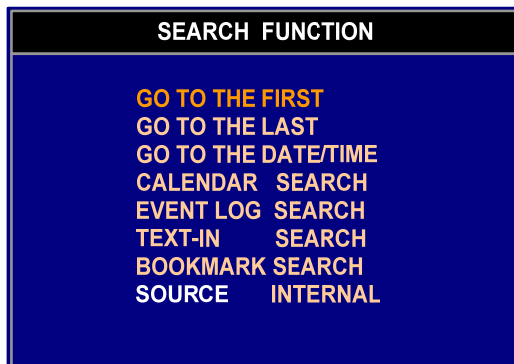

Select SOURCE to search from the beginning.

GO TO THE FIRST

Select "GO TO THE FIRST" in the search function menu. This function displays the first recorded image.

GO TO THE LAST

Select "GO TO THE LAST" in the search function menu. This function displays the last recorded image.

GO TO THE DATE/TIME

Select "GO TO THE DATE/TIME" in the search function menu. This function searches a recorded video by date and time you want. Go to the Time/Date window is shown below.

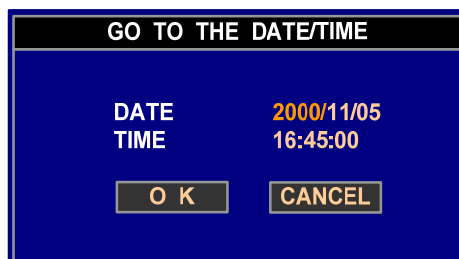

Select the year, month, day, hour, minute and seconds you want to search for video. Use the arrow (up/down) key on the front panel to change the date and time.

CALENDAR SEARCH

Select the "CALENDAR SEARCH" option in the search function menu. A basic search screen will be displayed as shown below.

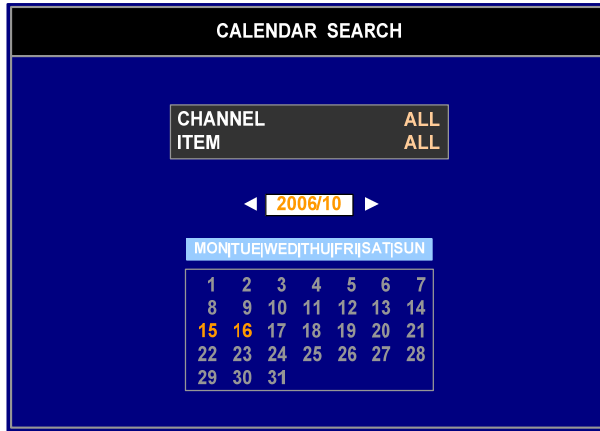

- Select the CHANNEL, ITEM and MONTH to search.
- Days with recorded video display on the calendar with red numbers.
- Highlight the days with recorded video by using the arrow buttons.
- Once a day has been highlighted, press the **ENTER**, **↵** key to select, and a time table window will be displayed as shown below.

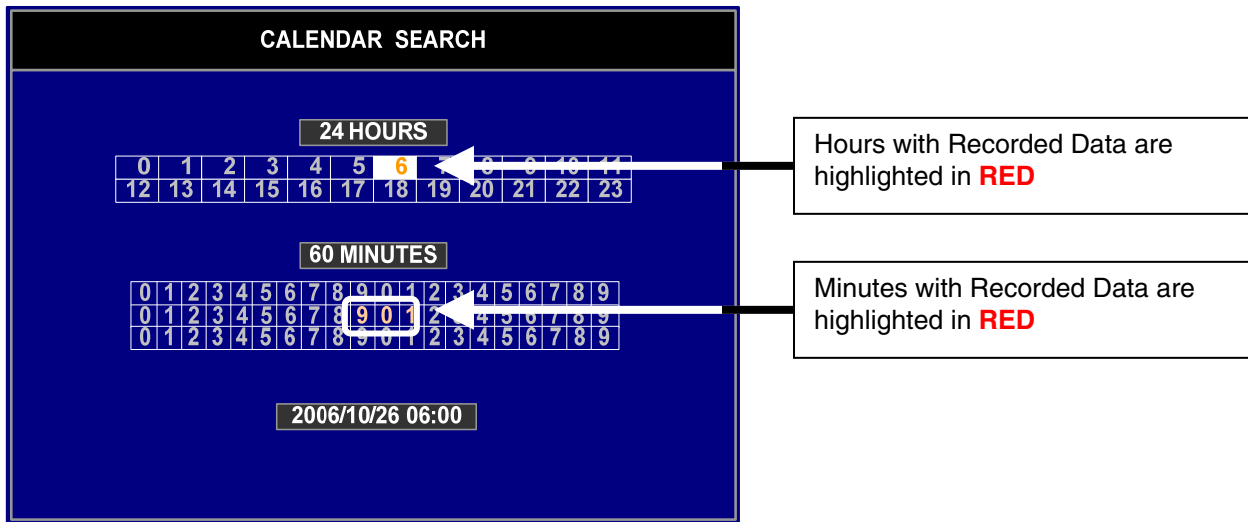

- Hours in which video was recorded will be highlighted with red.
- Highlight the hours with recorded video by using the arrow buttons.
- Once an hour has been highlighted, press the **ENTER**, **↵** key to select.
- Minutes in which video was recorded will be highlighted with red.
- Once minutes are highlighted, press the **ENTER**, **↵** key to select.
- The playback will be started at the time selected.

NOTE: The 24 hours time table has 24 one-hour segments. Each segment consists of 24-numeric blocks which are ranged from 0 to 23. If a number is highlighted in Red, it means that video was recorded during that hour. However, it does NOT mean video was recorded for the entire hour.

NOTE: The 60 minutes time table has six 10-minute segments. Each segment consists of 10-numeric blocks which range from 0 to 9. If a number is highlighted in Red, it means that video was recorded during that 10-minute time block. However, it does NOT mean video was recorded for the entire hour.



EVENT LOG SEARCH

Select the "EVENT LOG SEARCH" in the search function menu. A basic search screen will be displayed as shown below.

EVENT LOG SEARCH	
DATE / TIME	EVENT
06/10/15 14:37:12	MOT 1~3, 7
06/10/15 14:37:50	ALM 2,5,8
06/10/15 14:38:05	TXT
06/10/15 15:10:00	VLS 4,8
06/10/15 15:10:35	ALM 1,5,7,8

ENT: 79 PG: 0001/0007 OPTION < >

The system maintains a log of each time the Alarm Input port is activated. The Event Log Search screen displays this list. Use the arrow buttons to select the event to display the corresponding video.

- Pressing the **ENTER**,  key will extract the event video and display the first image of the event.
- Pressing the **PLAY**,  key will start playing the “event” video segment.
- Pressing the **STOP**,  key causes the system to return to live monitoring mode.
- The Event Search can be further refined by selecting the **OPTION** button and setting up the new search condition.

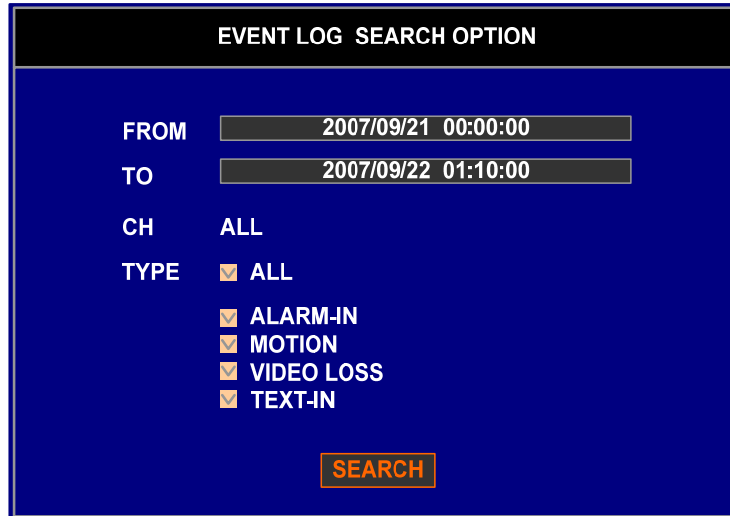

EVENT LOG SEARCH OPTION

FROM

TO

CH ALL

TYPE ALL

ALARM-IN

MOTION

VIDEO LOSS

TEXT-IN

SEARCH

- The Video can be searched from the first to last recorded images, or by using the start and stop times and dates.
- Selecting the “FROM” and “TO” fields will allow the user to manually change the time to be searched.
- Select the cameras to search in the CH field and Highlight the box beside each event source in the TYPE field.
- Select the events to search by.
- Once the desired search conditions have been set, select the **SEARCH** button to display the search results.

TEXT-IN SEARCH

The Text-In Search allows the user to search for a recorded video initiated by a Text-In input (such as a POS device).

- Select TEXT-IN SEARCH in the search function menu to display a Text-In search window as below.
- Selecting an event in the list will play a video of the chosen date and time.
- Selecting the FROM and TO field will allow the user to manually change the time to be searched.

If the KEYWORD fields are blank, all the Text-In events are searched. You can enter a maximum of 5 items to be search by, and any Text-In event containing any of the typed words will be searched.

Press the **SEARCH** button in Text-In Search window. The Text-in Search screen displays a list of text-in events and extracts the video associated with the text-in event.

- Use the arrow buttons to highlight the event to display the corresponding video.
- Selecting a particular event in the list will play a video of the chosen date and time.
- In this time, the playback screen is placed inside of the rectangle border line. The video will be played during recorded time for that event.

- Press the **DETAIL** button to overlay the text-in data on the video during the Text-In playback.
- Pressing the **MENU** key while in the On-Screen Text-In playback mode returns the system to the Text-In search mode.
- Pressing the **PLAY**, ► key while in the Text-In search mode returns the system to the Playback mode and exits the Text-In Search mode.
- Press the **MENU** key to exit the Text-In search mode.

NOTE: The video in the Text-In playback mode is played at regular speed.

BOOKMARK SEARCH

Select the “BOOKMARK SEARCH” in the search function menu to display a bookmark search window as shown below.

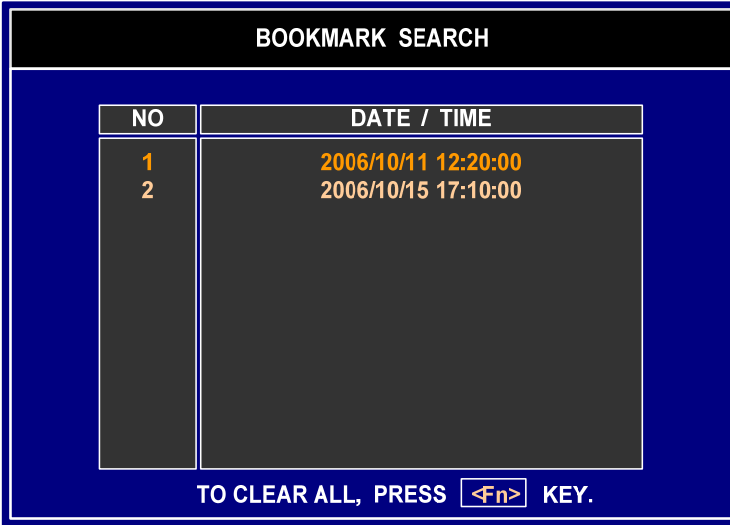

NO	DATE / TIME
1	2006/10/11 12:20:00
2	2006/10/15 17:10:00

TO CLEAR ALL, PRESS **<Fn>** KEY.

- The Bookmark Search screen displays a list of the video associated with the bookmarks set in the recording mode.
- Use the arrow buttons to highlight the video from the list. Selecting a particular item in the list will play a video of the chosen date and time.

NOTE: Use the **MARK** key on the front panel to mark the point of the bookmark search when playing video. A maximum of 16 points can be saved for a bookmark.

Observation System Specifications - Appendix #1

SYSTEM

Operating System	Embedded Linux (Built-In Flash Memory)
Language	English (Multi Languages will be available)
Storage	One HDD
Data Export Medium	USB (HDD, Flash Drive, CD-RW)
Data Backup	Archiving (USB HDD), Clip-Copy (CD-RW, USB Flash Drive)
Disk Management	Temperature Check, SMART Diagnosis, Auto Recovery, Auto Deletion

VIDEO

Video Source	NTSC or PAL (Auto Detect)
Video Input	Composite: 8, 6pin 4 DIN & 4 BNC inputs, 1 Vp-p, 75 Ohms
Video Resolution	720x480 (NTSC), 720x576 (PAL)
Display Rate	Real-Time Display

RECORD & PLAYBACK

Compression Method	MPEG-4
Recording Rate	120 IPS (NTSC) @ 352x240 / all cameras 60 IPS (NTSC) @ 704x240 / all cameras 30 IPS (NTSC) @ 704x480 / all cameras
Playback Rate	Same as Recording Rate
Recording Mode	Time-Lapse, Event, Pre-Event (up to 30 sec regardless of IPS), Text-In
Search Mode	Calendar, Time/Date, Event Log, Text-In, Bookmark

NETWORK

Connection	10/100 Mbps Ethernet (RJ-45)
Protocols	Static IP, DHCP, DDNS
Remote Software	Monitoring, Playback, Setup, Upgrade, System Status Check, image Capture & Print, Clip Player

INPUTS/OUTPUTS

Alarm Input	8 TTL, Terminal Block, programmable as NC or NO
Alarm Output	1 Relay Out, Terminal Block, NC & NO, 5A @ 125VAC/30VDC, 3A @ 250VAC
Audio In / Out	4(CAM1,2,3,4 fixed & Built-in MIC)/1(Built-in Speaker)
IR Port	1 Remote Control
User Interface	Remote control, Mouse, IR Remote Control, Front Buttons
USB Port	2 (USB 2.0)
RS232C Serial Port	DSUB9
RS485 Serial Port	2 Connector Terminal Block

LCD

LCD Panel	19" TFT LCD Panel
Active Display Area (Diagonal)	19.0 Inches
Pixel format	1280(H) X 1024 (V), RGB Vertical Stripe

Pixel Pitch	0.294mm X 0.294mm
Color Depths	16.7M Colors
Contrast Ratio	1000 : 1 (Typical)
Brightness	300cd / m2
Viewing Angles (Left/Right/Up/Down)	80° / 80° / 80° / 80° (Typical)
Light Source / Lifetime	4CCFT / 50,000 Hours (Minimum)
Response Time (Tr / Tf)	1.5/3.5ms (Rising / Falling)

GENERAL

Dimensions (W x H x D)	568 mm x 638 mm x 310 mm (Including Packing Ass'y)
Weight	19.5 Kg / 43 lbs
Operation Environment	Temperature: 0 ~ 40 °C, Humidity: 0 ~ 80 %
Power (AC input)	100V ~ 240V, 50/60 Hz, 80 Watts max
Approval	FCC, CSA, UL

Connecting Motion / Alarm Device - Appendix #2

Motion detection and Alarm controls are enabled through the Menu system on the Observation System. Additional motion sensor devices can be connected to the system (Motion Sensors, Door/Window Sensors).

A motion detection or sensor unit can be used to send a signal to the Observation System to begin camera viewing on the matching Video Channel (when enabled in the "Setup Menu – Event - Motion" submenu).

- Example: A Window sensor unit has been installed on Alarm Block port #4. When this sensor is activated, the camera on port #4 will become active (if enabled in the MENU on the Observation System)

Installing a Sensor

1. Connect the GROUND Cable to the GND port on the Alarm Block on the Observation System
2. Connect the SIGNAL Cable to a numbered port (1-8).

To start ALARM RECORDING on the System, refer to the "Setup Menu – Event – Alarm-In" submenu for menu configuration.

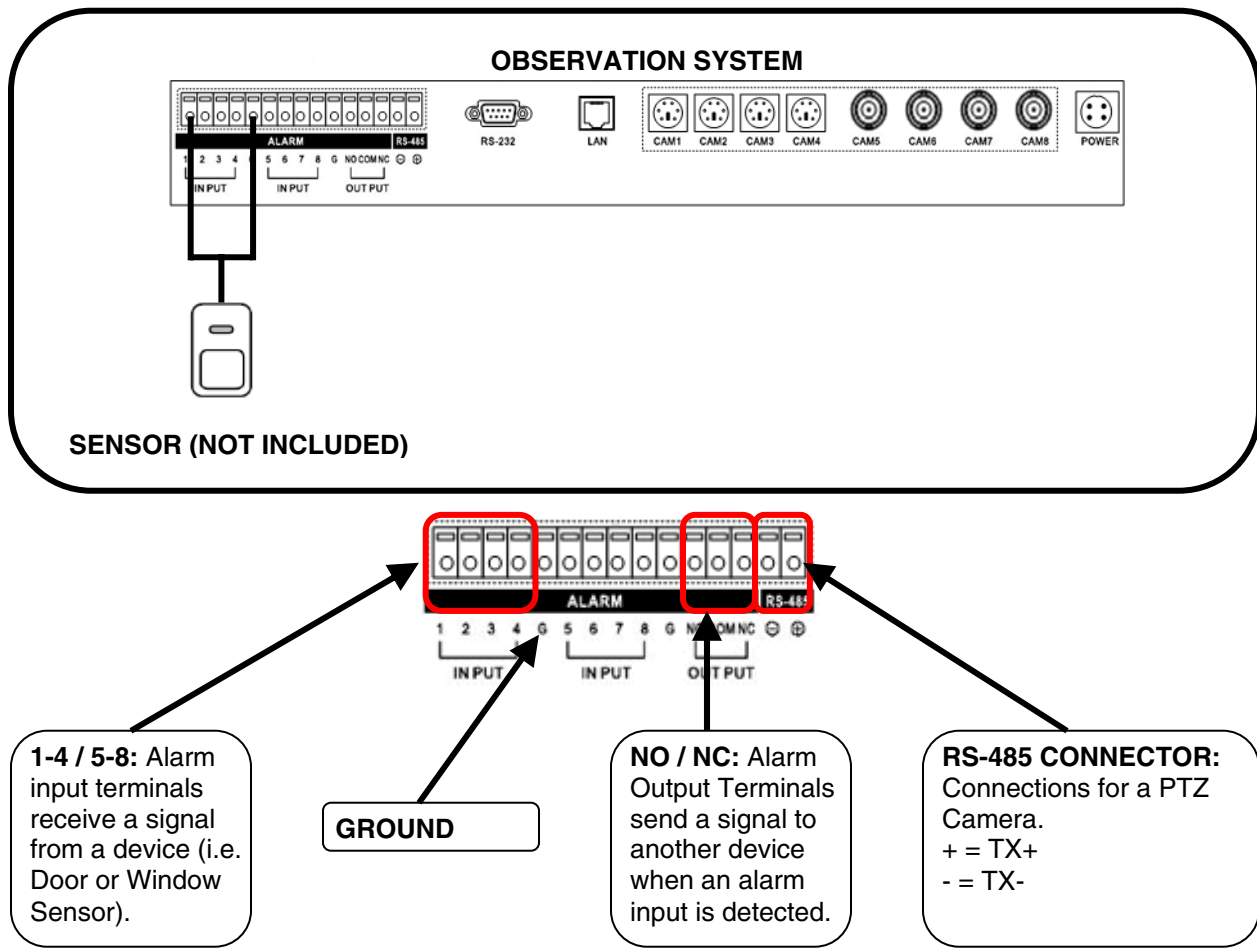

Connecting RS-485 & RS-232 Devices - Appendix #3

PTZ Cameras (not included with this system) can be connected to the PTZ Control Block on the back panel of the System. The PTZ Controls are enabled through the Menu system on the Observation System. Additional PTZ Cameras are available at <http://www.lorexcctv.com>

Installing a PTZ (RS-485 Type) PTZ Camera:

1. Connect the Transmit Cable to the + port on the PTZ Control Block on the Observation System.
2. Connect the Receive Cable to the - port on the PTZ Control Block on the Observation System.
3. Connect the Camera to the desired BNC Channel (DIN Channel 1 must be empty).
4. Configure PTZ Menu options. The PTZ Camera Settings will depend on the Type of Camera - refer to the specific Camera Manual for your brand and model of PTZ Camera.

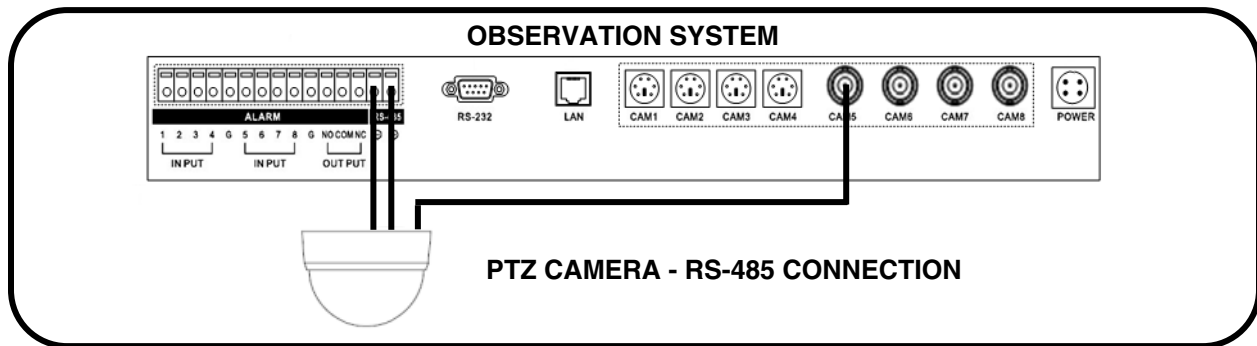

Installing an RS-232 Type Device:

The RS-232 port can also be used to connect an external device or control system, such as a POS (Point of Sale Cash Register) or a remote keyboard. Use the POS manufacturer's recommended settings when configuring the RS232 ports.

1. Connect the RS-232 Device to the RS-232 Block on the Observation System.
2. Configure the appropriate Menu options. The Settings will depend on the Type of RS-232 Device - refer to the specific Device Manual for settings.

Full Connectivity Diagram – Appendix #4

The following diagram outlines a general set of connections available with the Observation System.

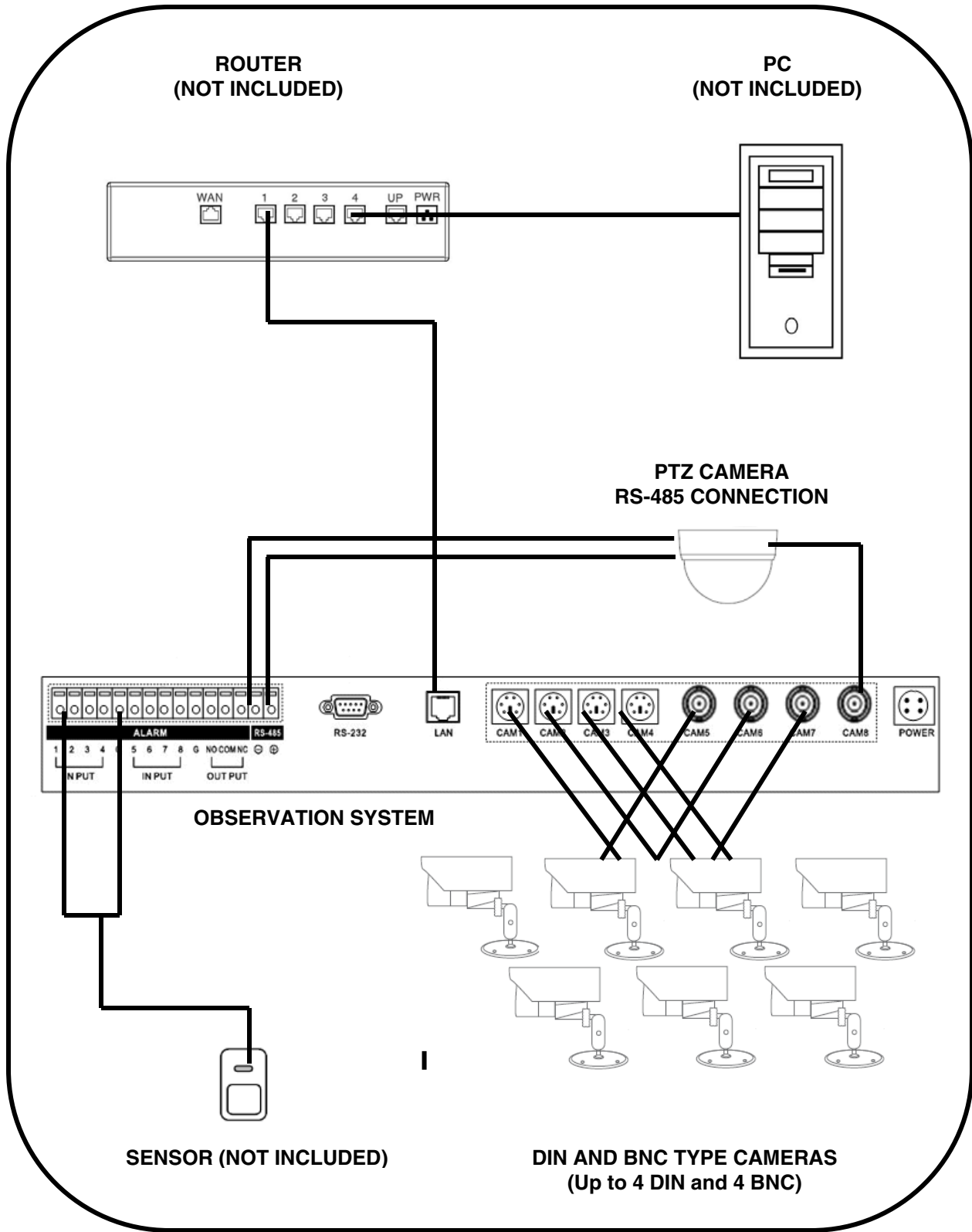

Hard Drive Replacement - Appendix #5

The System comes with a pre-installed Hard Drive; however the unit will work with a replacement single IDE Hard Drive (up to 750GB).

NOTE: Make sure that the System is OFF and the power cable has been disconnected before changing the Hard Drive.

Removing the Back Cover and Installed Drive

1. Remove the two screws on the back hard drive cover panel. Remove the panel.
2. Unscrew the two screws on the Hard Drive bracket.
3. Remove all cables from the previously installed drive.
4. Remove the four screws from the bracket to remove the drive.

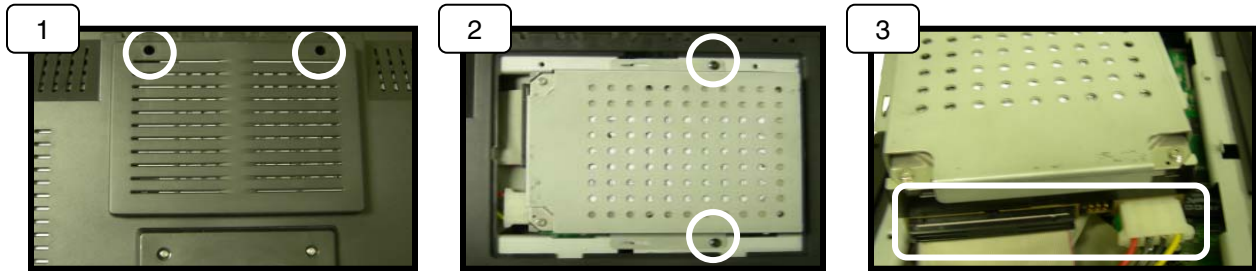

Setting the New Drive to Master

- Refer to the General Jumper Pin Setting on HDD Surface (generally located on a sticker on the top of the drive).
- Set the Jumper Pin Set to Master (1 Drive).

NOTE: Use an IDE Hard Drive.



Hard Drive Replacement (cont ...)

Installing the New Drive

- Insert the new drive, and reattach the holding screws.
- Reconnect the cables in the same way as connected to the previous drive.
 - Reconnect the IDE Cable. Confirm that the cable is connected securely within the System and to the Hard Drive.
 - Reconnect the Hard Drive power cable. Confirm the cable is securely connected to the Hard Drive.
- Replace the drive holding bracket, and reattach the screws.
- Replace the drive cover on the back of the System, and reattach with the screws.

New Hard Drive Format

The New Hard Drive MUST be formatted.

NOTE: If a new **HARD DRIVE** is detected, the system will prompt you to **FORMAT** the drive. If you do not choose to format the **HARD DRIVE**, the drive will not be detected by the system.

If you choose to **FORMAT** a drive in this way, the drive will no longer be readable by a regular PC without using the **HARD DRIVE VIEWER** software included on the CD provided with this unit

Press **ENTER** to choose the **OK** option and proceed with the format.

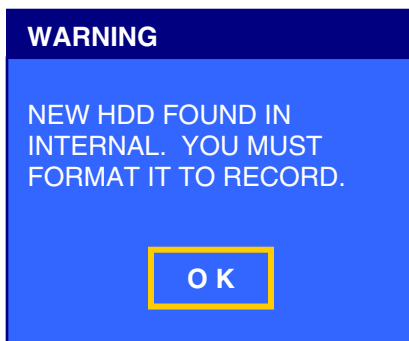

Troubleshooting – Appendix #6

When a malfunction occurs, it may not be serious and can be corrected easily. The following describes the most common problems and solutions. Please refer to the following before calling Lorex Technical Support:

Problem:

Observation System Unit is not receiving power, or is not powering up

Check:

- Confirm that all cables are connected correctly.
- Confirm that the power adapter is securely connected to the back of the unit.
- Confirm that there is power at the outlet by:
 - Connecting the power cable to another outlet
 - Testing the outlet with another plugged device (such as an electric calculator or phone charger)
- If the unit is connected through a power bar or surge protector, try bypassing the bar and connecting the power directly to the wall outlet.
- Confirm that the unit is powered on (LED indicators on the front should be ON).

Problem:

The Observation System is not responding when any of the buttons are pushed.

Check:

- Turn the master power OFF by removing the POWER CABLE. The LED indicators should be OFF.
- Wait for 1 minute – Reconnect the POWER CABLE.
- The unit will make an audible alert when powered back on

Problem:

The image on the Observation System is too dark or too bright

Check:

- Adjust the CONTRAST and BRIGHTNESS of the unit (Refer to the Menu section)

Problem:

The image on the Observation System does appear, but does not have sound.

Check:

- Check the VOLUME
- Check the CAMERA connection to the Observation System (DIN CONNECTION ONLY).
- Confirm that the Camera has sound capabilities (Refer to the manual for the camera model for further information on the Camera functionality)

Troubleshooting (cont...)

Problem:

The picture on the Observation System is poor, shrinks or flickers

Check:

- Check the camera video cable and connections
- Disconnect and reconnect the cable at the Observation System and at the Camera
- Clean the camera lens
- Adjust the CONTRAST and BRIGHTNESS settings in the Menu
- Check that the Camera is not in direct sunlight

Problem:

There is no picture appearing on a Channel / Camera is not displaying

Check:

- Check the camera video cable and connections
- Disconnect and reconnect the cable at the Observation System and at the Camera
- Try moving the camera to another channel or use another cable

Factory Default Settings - Appendix #7

Menu	Item	Parameter	Default Setting
SYSTEM	DATE / TIME	SETUP :	
		TIME ZONE	GMT-05:00
		DST ON/OFF	OFF
	LANGUAGE	FORMAT :	
		DATE	MM/DD/YYYY
		TIME	24H
	DISK MANAGEMENT	TIME SYNC :	
		INTERVAL	OFF
		ENGLISH/FRENCH....	ENGLISH
		RECORD MODE	OVERWRITE
		DISK FULL WARNING	90%
		DISK FULL ACTION	BUZZER,LAN
	SCREEN SAVE	MIRROR	OFF
		ON/OFF	OFF
		TYPE	AUTO
	ALARM-IN	TIME	O N: 09:00:00 OFF: 17:00:00
		AUTO	5 MIN
		HOLD TIME	5SEC
ON/OFF		ON	
TYPE		N/O	
ACTION		RELAY,BUZZER,LAN	
RECORD		Current Channel	
HOLD TIME		5SEC	
ON/OFF		ON	
SENSITIVITY		3	
MOTION	BLOCKS	1	
	AREA	All Block	
	ACTION	LAN	
	RECORD	Current Channel	
	HOLD TIME	5SEC	
	ON/OFF	ON	
VIDEO LOSS	ACTION	LAN	
	RECORD	None	
	ON/OFF	ON	
	DISPLAY	ON	
	HOLD TIME	5SEC	
	ACTION	LAN	
TEXT-IN	RECORD	ALL	
	PRODUCT TYPE	GENERIC TEXT	
	DISK TEMPERATURE:		
	ON/OFF	ON	
	TYPE	FAHRENHEIT	
	LIMIT	140F	
SYSTEM EVENT	HOLD TIME	5SEC	
	ACTION	BUZZER,LAN	
	DISK S.M.A.R.T		
	ON/OFF	OFF	
	HOLD TIME	5SEC	
	ACTION	BUZZER,LAN	
RECORD	SCHEDULE	CONTINUOUS	
	RESOLUTION	352 x 240	
	PRE-EVENT: ON/OFF	ON	

CAMERA		DWELL TIME	5SEC
		VIDEO	1~8:ON
		AUDIO	1~4:ON, 5~8:OFF
		SPEED (T/E)	15/15
		QUALITY (T/E)	B/B
		NAME (CH1~CH8)	CAM1 ~ CAM9
		COVERT	OFF
		SEQUENCE:	
		DWELL TIME	3SEC
		EVENT SCREEN MODE	UNCHANGED
DISPLAY		OSD:	
		DATE/TIME	ON
		AUDIO OUTPUT	ON
		EVENT MARK	ON
		NETWORK	ON
		DISK SIZE	ON
		USER	ON
		CAM NAME	ON
		PTZ	ON
		ON/OFF	OFF
PTZ		PROTOCOL	CDC2400 (DYNA..)
		ID	0
		TYPE	DHCP
		TCP/IP :	
		IP ADDRESS	0:0:0:0
		SUBNET MASK	0:0:0:0
		GATEWAY	0:0:0:0
		DNS SERVER	0:0:0:0
		PORT	SETUP : 3000
			LIVE : 3001
NETWORK			PLAYBACK :3002
			DOWNLOAD : 3003
			WEB : 80
		USE	PTZ
		PORT:	
	RS232 / RS485	BAUD RATE (BPS)	9600
		PARITY	NONE
		DATA BIT	1
		STOP BIT	1
	DDNS	ON/OFF	OFF
	ROUTER	ON	
	E-MAIL:		
	RECIPIENTS SEND	OFF	
NOTIFICATION	LAN:		
	SITES ON/OFF	OFF	
	PORT	3004	
SITE	SYSTEM ID	1	

System Log & Messages – Appendix #8

System Log

Log Message	Log Option	Description
START UP	START UP	System power on start
SETUP BEGIN	SETUP BEGIN	System setup began at the local site
SETUP END	SETUP END	System setup ended at the local site
SETUP CHANGE	SETUP CHANGE	System setup changed at the local site
RECORD ON	RECORD ON	Schedule recording began
RECORD OFF	RECORD OFF	Schedule recording ended
RMT SETUP WR	RMT SETUP WRITE	System setup saved at the remote site
RMT SETUP RD	RMT SETUP READ	System setup read at the remote site
BACKUP BEGIN	BACKUP BEGIN	System backup began
BACKUP END	BACKUP END	System backup ended
BACKUP FAIL	BACKUP FAIL	System backup failed
BACKUP CANCEL	BACKUP CANCEL	System backup canceled
TIME CHG(USER)	TIME CHANGE(USER)	System time changed by USER
TIME CHG(NTP)	TIME CHANGE(NTP)	System time changed by NTP
TIME CHG(RTC)	TIME CHANGE(RTC)	System time changed by RTC
ZONE CHANGE	ZONE CHANGE	System time zone changed
CLIP BEGIN	CLIP-COPY BEGIN	System Clip-Copy began
CLIP END	CLIP-COPY END	System Clip-Copy ended
CLIP FAIL	CLIP-COPY FAIL	System Clip-Copy failed
CLIP CANCEL	CLIP-COPY CANCEL	System Clip-Copy canceled
DISK HOT	DISK HOT	DISK high temperature
FORMAT(IN)	FORMAT(INTERNAL)	Internal DISK format began
FORMAT(USB)	FORMAT(USB)	External USB HDD format began
UPDATE	SYSTEM UPDATE	System upgraded
FACTORY	FACTORY DEFAULT	Factory default began
DISK FULL	DISK FULL	DISK is full
E-MAIL FAIL	E-MAIL SEND FAIL	E-mail sending failed
SMART FAIL	S.M.A.R.T. FAIL	S.M.A.R.T. is bad
MIRROR FAIL	MIRROR FAIL	Mirror failed

Event Log

Log Message	Description
MOT All	Motion event detected from all channels.
MOT 1~2,4,7~8	Motion event detected from channel 1,2,4,7 and 8
VLS All	Video Loss detected from all channels.
VLS 1~2,4,7~8	Video Loss detected from channel 1,2,4,7 and 8
TXT All	Text-In event detected and forced all the channel to be recorded
TXT 1~2,4,7	Text-In event detected and forced channel 1,2,4,7 to be recorded
ALM All	Alarm-In event detected from all channels.
ALM 1~2,4,7~8	Alarm-In event detected from channel 1,2,4,7 and 8

Pop-Up Messages

Classification	Message	Description
Displays the status of an instantaneous operation (disappeared automatically after completion)	PLEASE WAIT...	Waiting for internal operation.
	DETECTING USB DEVICE...	Detecting the USB device.
	SNAPSHOT IS EXECUTING. PLEASE WAIT...	Waiting for the Snap Shot operation.
	TO APPLY NEW S/W, YOU SHOULD RESTART THE SYSTEM. NOW REBOOTING...	The system restarts after succeeding in the System Update.
	THE DISK IS FULL !! NO OVERWRITE MODE.	The DISK was full
	THE DISK IS ALMOST FULL, NO OVERWRITE MODE.	The DISK is almost full
	OLD FILESYSTEM FOUND IN INTERNAL1. FORMAT NEEDED FOR RECORDING.	The system found the DISK a different version of file system was applied.
	OTHER SYSTEM'S DISK FOUND IN INTERNAL1. FORMAT NEEDED FOR RECORDING.	The system found the DISK a different file system was applied.
	NEW DISK FOUND IN INTERNAL1. FORMAT NEEDED FOR RECORD.	The system found a new DISK
	BACKUP/CLIP-COPY COMPLETED.	The Backup or Clip-Copy was completed.
Displays the status of event, error and operation (disappeared in case only user press the OK button)	BACKUP/CLIP-COPY STOPPED.	The Backup or Clip-Copy was stopped.
	BACKUP/CLIP-COPY FAILED.	The Backup or Clip-Copy was failed.
	FORMAT FAILED. CHECK DISK STATUS AND TRY AGAIN.	The DISK Format was failed.
	UPDATE FAILED.	The System Update failed.
	MIRROR HALTED! CHECK YOUR USB DEVICE OR USB CABLE.	Mirror was halted while mirroring.
	BOOKMARK FAILED.	Bookmark failed.
	THE CURRENT PLAYBACK TIME IS BOOKMARKED.	Bookmark succeeded.
	ABC FILE SAVED.	Snapshot succeeded. (in case that filename is ABC)
	INVALID PRESET NUMBER !	The DVR user tried to use wrong preset number in the PTZ Setup mode.
	USB DEVICE ATTACHED.	The system found a new USB device.
Displays the status of user handle, device detection and instantaneous operation. (disappeared automatically after 2 seconds)	USB DEVICE DETACHED.	The USB device was extracted from the system.
	ACCESS DENIED	User had no access authority.
	THIS CAMERA IS NOT PTZ CAMERA.	User tried to use PTZ function for the channel not to be defined as a PTZ.
	CHECK YOUR PASSWORD AND TRY AGAIN.	User entered a wrong password.
	NO INPUT !	User needed to enter numeric.
	INVALID RANGE! ENTER CORRECT RANGE.	A selected time range is wrong
	NO RECORD DATA.	The system can't find record data in the Bookmark Search mode.
	SITE1 ADDRESS IS AN INVALID FORMAT.	User entered a wrong site address in the Notification Setup mode.
	SCREEN ON TIME AND SCREEN OFF TIME IS SAME.	The value of Screen On and Off is same in the Screen Setup mode.
	RS232 PORT IS BEING USED BY KEYBOARD. SET UP THE RS232 PORT.	User tried to change from Remote Keyboard to PTZ in the Serial Setup mode.
Displays the status of user handle, device detection and instantaneous operation. (disappeared automatically after 2 seconds)	RS232 PORT IS BEING USED BY POS. SET UP THE RS233 PORT.	User tried to change from POS to PTZ in the Serial Setup mode.
	PTZ MODE IS BEING USED BY CLIENT.	User tried to handle same PTZ while the remote client controls a PTZ camera.
	MAIN MENU IS BEING USED BY CLIENT.	User tried to enter the setup mode during the remote setup
	NO INPUT FILE NAME! ENTER THE FILE NAME.	User tried to start without filename in the Clip-Copy mode.
	TOO BIG FILE SIZE. LIMITED TO 2GB.	The file size selected by user was bigger than 2GB in the Clip-Copy mode
	THE SAME FILE IS IN YOUR STORAGE. ENTER DIFFERENT FILE NAME.	User entered the filename already existed in the storage in the Clip-Copy mode.
	SAME ID EXISTED.	User tried to select the ID already existed in the PTZ Setup mode.

Classification	Message	Description
Displays the status of user handle, device detection	INVALID DOMAIN NAME. ENTER CORRECT DOMAIN NAME.	User entered an invalid domain name in the DDNS Setup mode.

and instantaneous operation.
(disappeared automatically after 2 seconds)

DOMAIN NAME IS TOO LONG.
SAME PORTS EXISTED.
ADMIN IS NOT ALLOWED. ENTER DIFFERENT ID.
USER IS NOT ALLOWED. ENTER DIFFERENT ID.
SAME ID EXISTED. ENTER DIFFERENT ID.
INVALID ADDRESS
SERVICE FAILED.
ADDRESS1 IS NOT AN E-MAIL FORMAT.
SENDER ADDRESS IS NOT AN E-MAIL FORMAT.
SAME VERSION
NO AUDIO !!

The domain name is too long in the DDNS Setup mode.
User tried to select the Port Number already existed in the Port Setup mode.
User entered ADMIN as an ID in the Notification Setup mode.
User entered USER as an ID in the Notification Setup mode.
User tried to select the ID already existed Notification Setup mode.
The system has an invalid NTP server address during the NTP checking.
The system can't connect to the NTP server during the NTP checking.
User tried to use an invalid format of e-mail address in the Notification Setup mode.
User tried to use an invalid format of e-mail address in the Notification Setup mode.
The firmware version for the upgrade is same as old one.
User tried to control volume for channel 5, 6, 7 and 8

Optional Accessories

The following accessories are available to add to your existing system

**DIN
CAMERAS**



**BNC
CAMERAS**



**PTZ TYPE
CAMERAS**



**CAMERA
EXTENSION
CABLES**



**NIGHT VISION
ACCESSORIES**



**CAMERA
ADAPTOR
CABLES**



To order these accessory items, or for a complete listing of available products, please visit us on the web at:

WWW.LOREXCCTV.COM

It's all on the web

 **Product Information**

 **Specification Sheets**

 **User Manuals**

 **Software Upgrades**

 **Quick Start Guides**

 **Firmware Upgrades**



VISIT
www.lorexcctv.com

www.lorexcctv.com

Lorex Technology Inc.

Free Manuals Download Website

<http://myh66.com>

<http://usermanuals.us>

<http://www.somanuals.com>

<http://www.4manuals.cc>

<http://www.manual-lib.com>

<http://www.404manual.com>

<http://www.luxmanual.com>

<http://aubethermostatmanual.com>

Golf course search by state

<http://golfingnear.com>

Email search by domain

<http://emailbydomain.com>

Auto manuals search

<http://auto.somanuals.com>

TV manuals search

<http://tv.somanuals.com>