

CE

Mantis®



# Hedge Trimmer E System Taille-haie E-System E-System-Heckenscherer



**Owners manual and safety instructions  
Manuel d'utilisation et consignes de sécurité  
Benutzerhandbuch und Sicherheitshinweise**

© 2006 Mantis, Div. of Schiller-Pfeiffer Inc. All Rights Reserved.  
© 2006 Mantis, Division de Schiller Pfeiffer Inc. Tous droits réservés.  
© 2006 Mantis, Division von Schiller Pfeiffer Inc. Alle Rechte vorbehalten.

## Table of contents

### Important information

Introduction .....	1
Special safety information .....	1

### Safety and warnings

Safety labels .....	2
General safety rules .....	3

Assembly instructions .....	5
-----------------------------	---

Operation .....	6
-----------------	---

Maintenance .....	8
-------------------	---

Warranties policy .....	Back cover
-------------------------	------------

## Important information

### A. Introduction

This attachment is fitted with double edged reciprocating blades, intended to be used to trim hedges and shrubs.

### B. Specification

MODEL	SHAFT LENGTH	TOTAL WEIGHT
330105	62 cm	2.7 kg

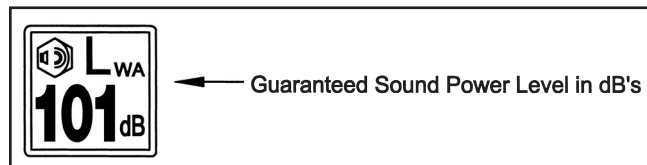

### C. Contents of the package

**⚠ WARNING ⚠ DANGER ⚠**  
**BLADES ARE EXTREMELY SHARP! TO AVOID INJURY WHEN UNPACKING THE HEDGE TRIMMER, DO NOT GRASP THE BLADES.**

1. Hedge trimmer attachment assembly
2. Plastic blade guard

### D. Service information contact

If you have questions about any topic in this manual, contact your local authorised Mantis dealer.

### E. Special safety information

**⚠ WARNING ⚠ DANGER ⚠**  
**ATTENTION: THIS SYMBOL POINTS OUT IMPORTANT SAFETY INSTRUCTIONS.**  
**⚠ WHEN YOU SEE THIS SYMBOL ⚠**  
**HEED ITS WARNING! STAY ALERT!**

**⚠ WARNING ⚠ DANGER ⚠**  
**READ & UNDERSTAND THIS MANUAL BEFORE ATTEMPTING TO OPERATE THIS MACHINE.**  
**TO REDUCE THE POTENTIAL FOR ACCIDENTS, COMPLY WITH THE SAFETY INSTRUCTIONS IN THIS MANUAL. FAILURE TO COMPLY MAY RESULT IN SERIOUS PERSONAL INJURY AND OR EQUIPMENT AND PROPERTY DAMAGE.**

# Safety and warnings

## A. Safety labels

Please pay particular attention to the warning and information labels found on various parts of this hedge trimmer attachment unit. They are an important part of the safety system. These labels must be replaced in time due to abrasion, etc. It is your responsibility to replace the labels when they become hard to read. The location of these labels and their part numbers for ordering are shown below.

**⚠ WARNING - DANGER ⚠**

**IMPROPER USE OR CARE OF THIS HEDGE TRIMMER, OR FAILURE TO WEAR PROPER PROTECTION CAN RESULT IN SERIOUS INJURY.**

**READ AND UNDERSTAND THE RULES FOR SAFE OPERATION AND ALL INSTRUCTIONS IN THIS MANUAL.**

**WEAR EYE AND HEARING PROTECTION, AND PROPER CLOTHING.**



READ AND UNDERSTAND OPERATOR'S MANUAL BEFORE USING! KEEP IN SAFE PLACE!

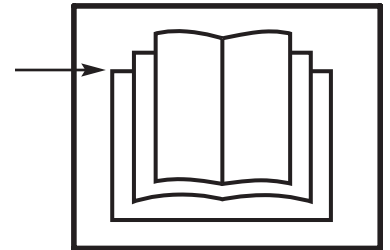

WARNING!

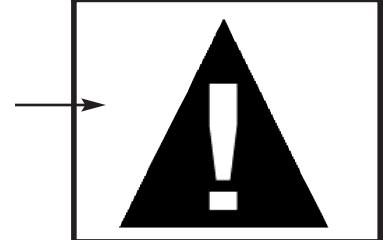

WEAR EYE AND EAR PROTECTION



WARNING! WEAR SLIP-RESISTANT FOOTWEAR. MAINTAIN FOOTING AND BALANCE AT ALL TIMES. DO NOT STAND ON SLIPPERY, UNEVEN OR UNSTABLE SURFACES. DO NOT WORK IN ODD POSITIONS OR ON LADDER. DO NOT OVER REACH.



KEEP BYSTANDERS AT A SAFE DISTANCE DANGER ZONE SURROUNDING THE OPERATOR. ONLY THE OPERATOR SHOULD BE IN THE DANGER ZONE!

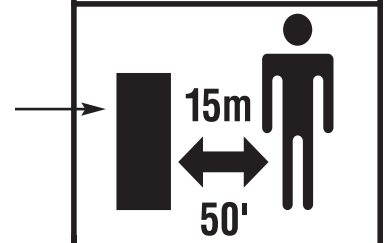

THROWN OBJECTS

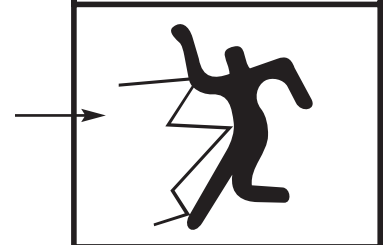

P/N 331179



WARNING!

CUTTING HAZARD! KEEP BOTH HANDS ON HANDLES AND AWAY FROM BLADES!

P/N 330600

## General safety rules

### ⚠ WARNING – DANGER ⚠

**THE BLADES COAST AFTER SWITCH TRIGGER IS RELEASED AND MOTOR IS SWITCHED OFF. MAKE SURE BLADES HAVE COME TO A COMPLETE STOP AND ENGINE IS OFF BEFORE RELEASING A HANDLE.**

### ⚠ WARNING – DANGER ⚠

**IF TRIMMER IS USED IMPROPERLY OR SAFETY PRECAUTIONS ARE NOT FOLLOWED, THE USER RISKS SERIOUS INJURY TO THEMSELVES AND OTHERS.**

**READ AND UNDERSTAND THE FOLLOWING BEFORE ATTEMPTING TO OPERATE THIS HEDGE TRIMMER.**

**Don't** ever grasp cutting blades for any reason.

**Don't** attempt to clear cut material while blades are moving, and the motor is running. Never try to remove jammed material or adjust the blade angle before switching the motor off and making sure the blades have stopped completely.

**Don't** hold the cutter blades when making any adjustments to the blade or loop handle positions.

**Always** make sure that the blades are in the correct working position that you want before starting the motor.

**Always** stop the motor before adjusting the working position of the cutting device.

### ⚠ WARNING ⚠

**WHEN USING ELECTRIC TOOLS, BASIC SAFETY PRECAUTIONS, INCLUDING THE FOLLOWING, SHOULD ALWAYS BE FOLLOWED TO REDUCE THE RISK OF FIRE, ELECTRIC SHOCK AND PERSONAL INJURY.**

Pay particular attention to all sections regarding safety.

Read and understand all these instructions before operating this product and save these instructions. Be familiar with the controls and the proper use of equipment.

#### For safe operations:

1. Keep work area clean.

Cluttered areas and benches invite injuries.

2. Consider work area environment.

Do not expose power tools to rain. Do not use power tools in damp or wet locations. Keep work area well lit. Do not use power tools where there is risk of fire or explosion.

3. Guard against electric shock.

Avoid body contact with earthed or grounded surfaces, e.g. pipes, radiators, stoves, ovens, refrigerators.

4. Keep children away.

Do not let visitors touch the tool or extension cord. All visitors should be kept away from area. Local regulations may restrict the age of the operator.

5. Store idle tools.

When not in use, tools should be stored in a dry, high or locked up place, out of reach of children.

6. Do not force the tool.

It will do the job better and safer at the rate for which it was intended. Walk, never run.

7. Use the right tool.

Do not force small tools or attachments to do the job of a heavy duty tool. Do not use tools for purposes not intended; for example, do not use chain saw attachment to cut tree limbs or logs.

8. Dress properly.

Do not wear loose clothing or jewellery that can be caught in moving parts. Long trousers, non-slip gloves and sturdy work shoes with non-skid soles are recommended when working outdoors. Wear protective hair covering to contain long hair.

9. Use protective equipment.

To avoid injury, wear ear, eye protection, face or dust mask if the operation is dusty. To avoid injury from falling branches, wear helmet. Eye protection must meet applicable CE requirements.

10. Do not abuse the cord.

Never carry the tool by the cord or yank it to disconnect it from the socket. Keep the cord away from heat, oil and sharp edges.

11. Maintain tool with care.

Keep cutting tools sharp and clean for better and safer performance. Follow instructions for lubrication and changing accessories. Inspect tool cord periodically and if damaged, have it repaired by an authorised service facility. Inspect extension cords periodically and replace, if damaged. Keep handles dry, clean and free from oil and grease.

12. Disconnect tools.

When not in use, before servicing and when changing accessories such as blades, bits and cutters.

13. Remove adjusting keys and wrenches.

Form the habit of checking to see that keys and adjusting

wrenches are removed from the tool before turning it on.

14. Avoid unintentional starting.  
Do not carry a plugged in tool with a finger on the switch trigger. Ensure switch is off when plugging in.
15. Use outdoor extension leads.  
When tool is used outdoors, use only extension cords intended for outdoor use.
16. Important extension cord information:
  - a. Make sure the extension cords are in good condition before use.
  - b. Based on the total length of cord that you are going to use, check the chart to make sure the cord meets the correct minimum cord gauge (AWG) requirements.

### IMPORTANT NOTE:

Using an undersized cord or a larger number cord gauge (AWG) than recommended in the chart, will cause a loss in power and overheating of the unit. Using a smaller number cord gauge (AWG) than recommended in the chart, is acceptable.

### Extension cord chart (minimum cord gauge (AWG))

Length (metres)	.3 to 7.8	7.9 to 15.5	15.6 to 30.6	30.7 to 45.7
Cord gauge (AWG)	18	16	14	12

17. Stay alert.  
Watch what you are doing. Use common sense. Do not operate tool when you are tired, ill or under the influence of alcohol or other drugs.
18. Check damaged parts.  
Before further use of the tool, a guard or other part that is damaged should be carefully checked to determine that it will operate properly and perform its intended function. Check for alignment of moving parts, free running of moving parts, breakage of parts, mounting and any other conditions that may affect its operation. A guard or other part that is damaged should be properly repaired or replaced by an authorised service centre unless otherwise indicated in this instruction manual. Have defective switches replaced by an authorised service facility. Do not use the tool if the switch does not turn it on and off.

**Don't** operate the machine with a damaged or excessively worn cutting device.

### ⚠ WARNING – DANGER ⚠

**LITTLE WONDER WILL NOT BE RESPONSIBLE FOR THE FAILURE OF CUTTING DEVICES OR ACCESSORIES THAT HAVE NOT BEEN TESTED AND APPROVED FOR USE WITH THIS UNIT. USE ONLY MANUFACTURER-RECOMMENDED REPLACEMENT PARTS.**

19. The use of any accessory or attachment, other than those recommended in this instruction manual, may present a risk of personal injury.
20. Have your tool repaired by a qualified person.  
This electric tool conforms to relevant safety requirements. Repairs should only be carried out by qualified persons using original spare parts, otherwise this may result in considerable danger to the user.
21. Keep in mind that the operator or user is responsible for accidents or hazards occurring to other people or their property.
22. Work only in daylight or in good artificial light.
23. Keep all guards attached at all times when unit is operated.
24. Always use the shoulder strap.  
Adjust the strap for comfort before starting the engine.
25. Secure unit during transport to prevent damage or injury.
26. **Machine should not be used in any position that causes any part to come within 3 metres of overhead electrical lines.** Always be aware of overhead power lines.
27. **Always** keep a firm grip on both handles when motor is running: one hand grasps the front “loop” handle while the other hand grasps the rear handle. Severe injuries can result if you try to use this machine with only one hand or with an insecure grip.
28. **Thoroughly** inspect the area where equipment is to be used and removed all objects, which can be thrown by the machine.
29. **Always** keep area clear of children, pets, and bystanders.
30. **Always** inspect your unit before each use and ensure that all handles, guards and fasteners are secure, operating, and in place. Be sure that all electrical cords are not damaged or broken.
31. **Always** maintain and examine your attachments with care. Follow maintenance instructions given in manual.
32. **Don't** attempt to repair any part of the extended reach “E” system. Have repairs made by a qualified repairman. See that only original “Mantis” parts are used.
33. Maintain a firm footing and good balance, do not overreach while trimming. Before you start to trim, check

the work area for obstacles that might cause you to lose your footing, balance or control of the machine. While operating the machine always be sure of a safe and secure operating position especially when using steps or a ladder. Always be sure of your footing on slopes.

**⚠ WARNING – DANGER ⚠**

**IMPROPER ASSEMBLY OF THIS EQUIPMENT CAN RESULT IN SERIOUS INJURY. MAKE SURE TO FOLLOW ALL INSTRUCTIONS CAREFULLY. IF YOU HAVE ANY QUESTIONS, CONTACT YOUR LOCAL AUTHORISED MANTIS DEALER.**

34. Always disconnect power cord from power source:
  - a. Before cleaning blockages.
  - b. Before checking, cleaning or working on the cutting portion of the unit.
  - c. After striking a foreign object: inspect the cutting part for damage and make repairs before restarting and operating the unit.
  - d. If machine starts to vibrate abnormally (check immediately).
  - e. Whenever you leave the unit.
35. Securing the extension cord.

Bend the extension cord about 40cm from the plug end. Push that bend through the oblong opening, then loop the bend under the cord retaining clips as shown. This will prevent the extension cord from detaching from the hedge trimmer plug.



## Attaching the Hedge Trimmer

*No tools are required to attach the Hedge Trimmer to the power head.*

1. Pull the spring pin up on the adapter of the power head shaft assembly.
2. Carefully fit hedge trimmer drive shaft into adapter, making sure that male spline of the inner drive shaft engages into the female spline socket of the power head shaft. (Picture 1)
3. When the drive shaft is properly aligned, the spring pin will drop into the hole on the shaft of the hedge trimmer attachment. A click should be heard when completed.
4. Insure two shaft parts are fully engaged by twisting them. Full engagement will prevent shaft rotation.
5. Secure assembly by tightening the knob. (Picture 2)
6. Unit handles can be re-adjusted to the operator's preference by simply loosening the screws and sliding handles up or down the shaft.



Picture 1



Picture 2

## Balancing the Unit

Check the balance of the assembled unit. The handles and shoulder harness have been assembled at the factory and set according to the average size person. This can be adjusted to the operator's preference by simply loosening the screws and sliding the handle up or down the shaft. Make sure to retighten the screws before operating hedge trimmer.

## Trimming

**⚠ WARNING ⚠ DANGER ⚠**

**BLADES COAST AFTER RELEASING THROTTLE OR STOPPING MOTOR.**

**KEEP A FIRM GRIP WITH BOTH HANDS WHILE BLADES ARE MOVING AND/OR MOTOR IS RUNNING.**

**KEEP A SURE FOOTING. DO NOT OVERREACH.**

**IF YOUR TRIMMER BECOMES JAMMED, RELEASE SWITCH AND STOP MOTOR. MAKE SURE BLADES HAVE STOPPED COMPLETELY.**

**UNPLUG THE UNIT, THEN REMOVE THE OBSTRUCTION.**

1. Do not start the motor until you are familiar with your hedge trimmer and all of its controls and functions.
2. Plug in the unit and grasp the handles securely. One hand grasps the front loop handle, while the other hand grasps the switch handle. With both hands on the handles, push lockout trigger button with your thumb and then squeeze trigger to engage the blades. Start cutting when motor runs at full RPM.

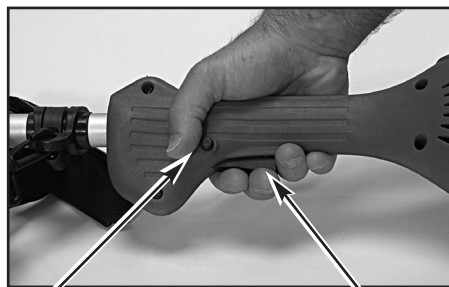
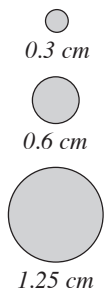

Lockout trigger button      Trigger

3. Tilt the trimmer so the cutting teeth are angled slightly toward the hedge or shrub and proceed to cut. Use overlapping sweeping motions away from your body to achieve a safe and even cut.
4. This unit is designed to cut any type of hedge or shrub with a branch thickness under 1/2" in (13 mm) diameter (see below). The depth of each cut depends on the hardness of the wood.

**THICKNESS OF CUT SHOULD NOT EXCEED  
13mm (1/2 inch) IN DIAMETRE.**

*Misuse of this hedge trimmer will void the warranty, i.e.: Cutting hedges or shrubs over 13mm (1/2") diameter or foreign objects such as wires, rocks or fences. Before trimming, check work area for foreign objects such as wires, cords, glass, fences, or rocks. Be sure to remove any foreign objects from the work area. Failure to properly maintain this hedge trimmer will void the warranty.*

## Adjusting the blade angle

**⚠ WARNING - DANGER ⚠**

**SWITCH OFF THE MOTOR AND UNPLUG THE UNIT BEFORE LUBRICATING OR ADJUSTING THE BLADES.**

1. To adjust the blade angle, first shut off the motor. Next, grip the blade adjustment handle. Then move the quick release lever from the tight position, at the right angle, so that it is pointing straight out.

**⚠ WARNING - DANGER ⚠**

**DO NOT ADJUST BLADE ANGLE BY GRASPING THE BLADES. BLADES ARE SHARP AND YOU RISK INJURY TO YOURSELF.**

2. The blade will now adjust freely to any position up to 180°.
3. Use the adjustment handle located beneath the assembly to move the blade to the desired angle position.
4. Once the desired angle has been achieved, simply move the quick release lever back to the tight position.

**⚠ WARNING - DANGER ⚠**

**DO NOT OPERATE UNIT UNLESS QUICK RELEASE LEVER IS IN THE "TIGHTENED" POSITION.**

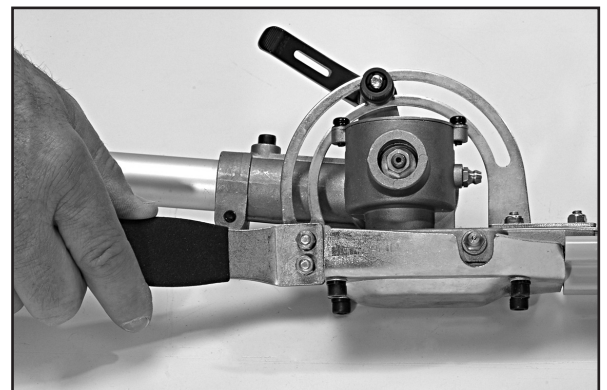
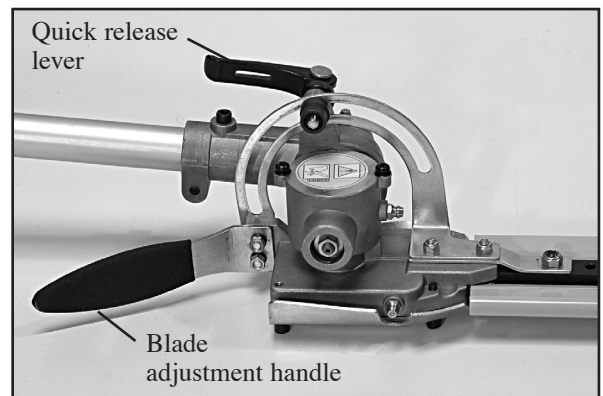





## Maintenance

**⚠ WARNING – DANGER ⚠**  
**UNPLUG THE UNIT BEFORE LUBRICATING  
 OR ADJUSTING THE BLADES.**

### A. Lubrication

1. A few drops of light No. 10 oil should be placed on the back edge of each adjusting screw head approximately after every 4 hours of normal operation.
2. To obtain trouble free trimming, it is necessary to keep the blades lubricated and clean. The gum that collects and builds up on the blades can be removed with a 50-50 mixture of kerosene and No. 10 oil. As petroleum products can shorten the life of some plastics, it is necessary to remove excess oil-kerosene mixture from the plastic parts.
3. When blades are replaced, or any other time that the bottom cover plate is removed, the grease level should be

checked for proper amount (approximately 1/2 full in the area of the gears) and a new gasket should be used to insure proper seating of the cover plate. Grease should be added every 25 hours of use. Use EP2 white lithium grease in the gear housing.

4. Lubricate male spline part of the drive shaft with EP2 White Lithium grease.

### B. Storage

1. Store your trimmer in a dry and dust free space, out of the reach of children.
2. Clean the blades thoroughly and coat them with No. 10 oil to prevent rust.
3. Perform all required maintenance and service found in this manual.
4. Use blades cover.

## Service maintenance guide

Area	Maintenance	Before use	Every 25 hours	Every 50 hours	Every 100 hours	Note
Cutting parts	Replace if something is wrong	✓				
Gear case	Grease		✓			Use EP2 white Lithium grease
Screws, nuts bolts	Tighten, replace	✓			✓	Not adjusting screws
Spline (male)	Lubricate	✓				Use EP2 white Lithium grease
Blades	Oiling	✓				Light #10 oil

**IMPORTANT:** Time intervals shown are maximum. Actual use and your experience will determine the frequency of required maintenance.

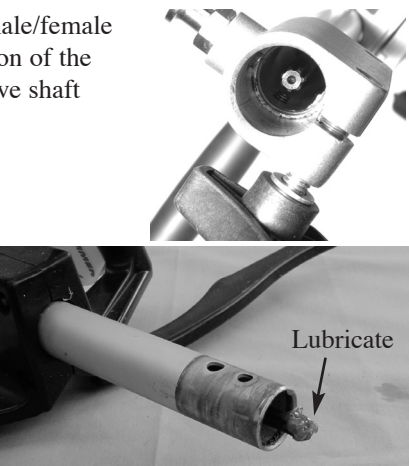
Area	Maintenance procedure	Frequency
Spline male/female connection of the inner drive shaft 	Inspect/lubricate <ol style="list-style-type: none"> <li>1. Remove the side screw, and loosen up other three as shown on the diagram (left).</li> <li>2. Pull the shaft from the gear housing.</li> <li>3. Pull and clean internal shaft.</li> <li>4. Lubricate.</li> <li>5. Re-install the drive shaft.</li> <li>6. Do not allow any dirt and dust on the internal drive shaft</li> <li>7. Do not allow any dirt and dust entering into the gear case</li> </ol>	20-25 hrs

# Hedge trimmer E System exploded view

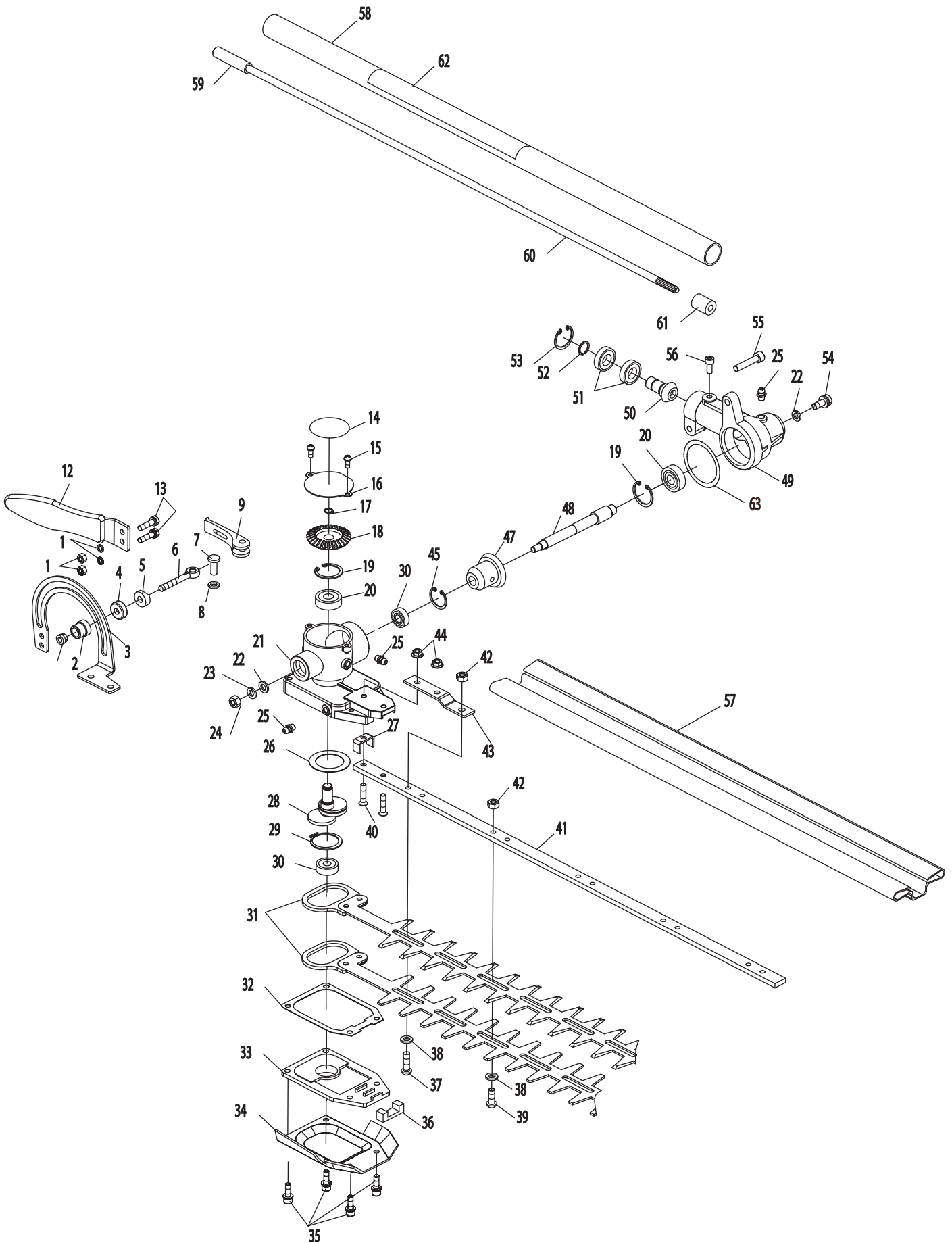

## Hedge trimmer E System parts list

KEY #	DESCRIPTION	PART #	QTY	KEY #	DESCRIPTION	PART #	QTY
1	LOCKNUT INSERT	331534	1	32	GASKET	331233	1
2	LOCKING KNOB	331218	1	33	GEAR CASE BOTTOM COVER	331234	1
3	ADJUSTMENT BRACKET	331217	1	34	PROTECTIVE COVER	331235	1
4	CLAMPING PAD	331535	1	35	BOLT M5X18	331547	4
5	PLASTIC LOCKING SPACER	331218	5	36	FELT	331236	1
6	ROTATE BOLT	331536	1	37	SCREW M6X20	331548	1
7	RIVET	331537	1	38	WASHER	331549	5
8	FLAT WASHER	331538	1	39	SCREW M6X18	331550	4
9	CLAMPING LEVER	331219	1	40	FRAME BAR SCREW	331551	2
10	NUT M5	331539	2	41	FRAME BAR	331237	1
11	LOCK WASHER	331540	2	42	NUT M6	331545	5
12	HANDLE	331220	1	43	FRAME BAR BRACE	331238	1
13	BOLT M5X20	331541	2	44	NUT M5	331539	2
14	CUTTING HAZARD LABEL	330600	1	45	SNAP RING	331552	1
15	SCREW M4X8	331542	2	47	DUAL GEAR	331240	1
16	GEAR CASE TOP COVER	331221	1	48	DRIVE SHAFT	331241	1
17	SNAP RING	331222	1	49	GEAR CASE (B)	331242	1
18	GEAR	331223	1	50	PINION GEAR	331243	1
19	SNAP RING	331224	1	51	BEARING 619017	331244	2
20	BEARING 6000-2Z	331225	1	52	SNAP RING	331245	1
21	GEAR CASE (A)	331226	1	53	SNAP RING	331246	1
22	FLAT WASHER	331543	2	54	BOLT M6X14	331553	1
23	LOCK WASHER	331544	1	55	BOLT M6X30	331554	1
24	NUT M6	331545	1	56	BOLT M5X12	331555	1
25	GREASE FITTING	331227	3	57	BLADE COVER	331247	1
26	HARDENED SHIM	331228	1	58	OUTER SHAFT 24X623MM	331248	1
27	PLATE	331229	1	59	INTERNAL SHAFT ADAPTER	331249	1
28	CRANK SHAFT	331230	1	60	INTERNAL SHAFT 628X7MM	331250	1
29	SNAP RING	331546	1	61	SPACER	331251	1
30	BEARING 608-2Z	331231	2	62	WARNING LABEL	331179	1
31	BLADE ASSEMBLY	331232	2	63	O-RING		1

**2 YEAR LIMITED SERVICE & WARRANTY POLICY  
FOR ELECTRIC HEDGE TRIMMER**

MANTIS extends this limited warranty against defects in material and workmanship for a period of two years from the date of purchase, to the first retail purchaser and each subsequent owner during the warranty period. This warranty covers all portions of the MANTIS "E" System Hedge Trimmer.

MANTIS will repair or replace, at its option, any part or parts of the product proven to be defective in material or workmanship under normal usage during the warranty period. Warranty repairs and replacements will be made without charge for parts or labor. All parts replaced under warranty will be considered as part of the original product, and any warranty on the replaced parts will expire coincident with the original product warranty. In the event of a defect or malfunction, the purchaser must send the product, postage paid to:

Mantis  
2800 Turnpike Dr.  
Suite #1  
2800 Commerce Center  
Hatboro, PA 19040

MANTIS assumes no responsibility in the event that the product was assembled or used in noncompliance with any assembly, care, safety, or operating instructions contained in the Owner's Manual; was not used with reasonable care; or was misused, used for other than normal or intended purposes. This warranty does not extend to parts affected or damaged by normal wear and tear.

MANTIS MAKES NO EXPRESS OR IMPLIED WARRANTIES OR REPRESENTATIONS EXCEPT THOSE CONTAINED HEREIN. THE DURATION OF ANY IMPLIED WARRANTY, INCLUDING MERCHANTABILITY AND FITNESS FOR A PARTICULAR PURPOSE, IS LIMITED TO THE DURATION OF THIS WRITTEN LIMITED WARRANTY. MANTIS DISCLAIMS ALL LIABILITY FOR INDIRECT AND/OR CONSEQUENTIAL DAMAGES. SOME STATES DO NOT ALLOW LIMITATIONS ON HOW LONG AN IMPLIED WARRANTY LASTS AND/OR DO NOT ALLOW THE EXCLUSION OR LIMITATION OF INCIDENTAL OR CONSEQUENTIAL DAMAGES, SO THAT ABOVE LIMITATIONS AND EXCLUSIONS MAY NOT APPLY TO YOU. THIS WARRANTY GIVES YOU SPECIFIC LEGAL RIGHTS, AND YOU MAY ALSO HAVE OTHER RIGHTS WHICH VARY FROM STATE TO STATE.

**MANTIS**  
**1028 Street Road**  
**Southampton , PA 18966**  
**+ (215) 355-9700**



**MANTIS**  
**1028 Street Road**  
**Southampton , PA 18966**  
**+ (215) 355-9700**

P/N 331708  
7/06 REV B

## Free Manuals Download Website

<http://myh66.com>

<http://usermanuals.us>

<http://www.somanuals.com>

<http://www.4manuals.cc>

<http://www.manual-lib.com>

<http://www.404manual.com>

<http://www.luxmanual.com>

<http://aubethermostatmanual.com>

Golf course search by state

<http://golfingnear.com>

Email search by domain

<http://emailbydomain.com>

Auto manuals search

<http://auto.somanuals.com>

TV manuals search

<http://tv.somanuals.com>