

# MODEL SA-1 TECHNICAL SPECIFICATIONS

	Super Audio CD	CD
<b>Audio Characteristics</b>		
Channels	2channels	2channels
Frequency range	2Hz — 100kHz	2Hz — 20kHz
Frequency characteristics	2Hz — 50kHz (-3dB)	2Hz — 20kHz
Dynamic range	109dB	98dB
THD (1kHz)	0.0012%	0.0015%
wow & flutter	Precision of quartz	Precision of quartz
Analog output		
output level (unbalanced)	2.2V	2.4V
output level (balanced)	4.4V	4.8V
Digital output		
output level (cinch JACK)	—	0.5Vp-p (75Ω)
output level (optical)	—	-19dBm
<b>Optical Readout System</b>		
Laser	AlGaAs	AlGaAs
Wave length	650nm	780nm
<b>Sampling frequency</b>	2.8224MHz	44.1kHz

## Power Supply

U version .....	AC 120V 60Hz
Power Consumption .....	33W

## Cabinet, etc.

Dimensions (Width × Height × Depth) .....	458 × 133 × 365mm
Net weight .....	17.7kg
Operating temperatures .....	+5°C ~ +35°C
Operating humidity .....	5 ~ 90% (without dew)

## Accessories

• Remote control unit .....	1
Dimensions (Width × Height × Depth) .....	44 × 17.5 × 239mm
Net weight (without Batteries) .....	175g
• AAA (R03) Batteries .....	2
• Stereo audio cable with cinch pins .....	1
• AC Power Cord .....	1
• User's Guide .....	1

Specifications subject to change without prior notice.

# MODEL SA-1

## FRONT VIEW

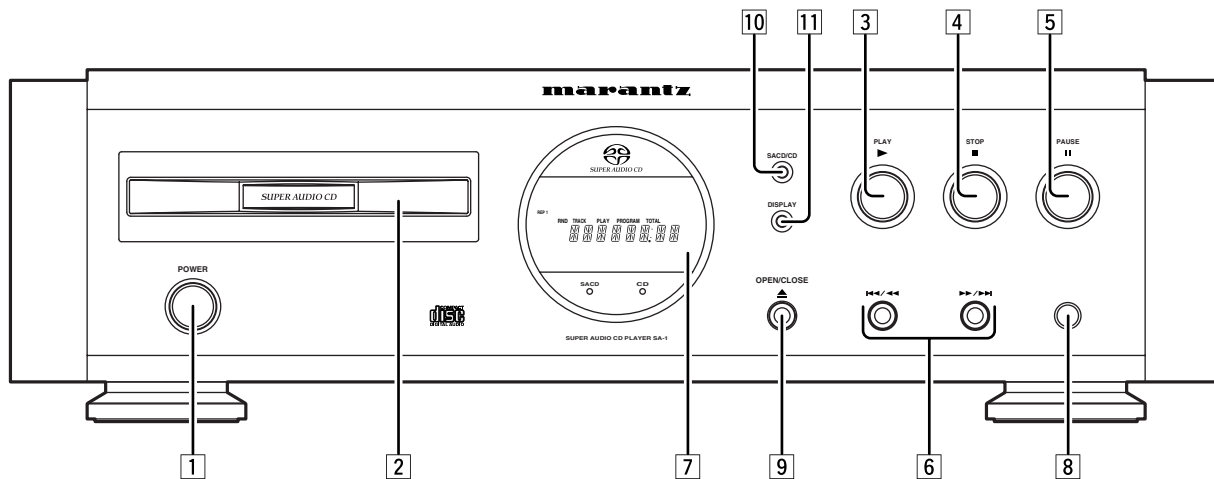

## REAR VIEW

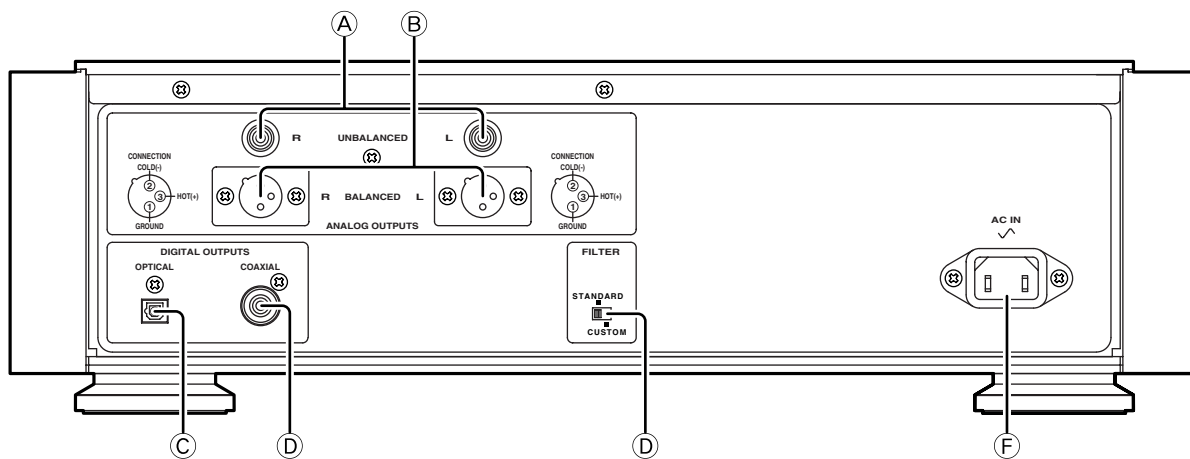

## INTRODUCTION

Thank you for selecting the Marantz SA-1 Super Audio CD Player for your A / V system.

This Compact Disc Player incorporates a number of features designed to enhance the listening of your favorite audio sources.

Please read these operating instructions carefully. We recommend that you read the entire user guide before you attempt to connect or operate the player.

After you have reviewed the contents of this manual, we suggest that you make all system connections before you attempt to operate the unit.

Refer to the figures on the pages at the back of this user's guide. The callout numbers on the figures correspond to those found in the text.

## INSTALLATION

Remember the following important points when installing the player:

- Do not expose the player to rain or moisture, as this may cause damage to the player.
- All players produce some heat during operation and this heat must be allowed to disperse freely. Do not close any ventilation openings and insure that there is adequate ventilation space behind, beside and above the player.
- Prevent extra heat from reaching the unit. Never put the player in the full glare of the sun or near a heat source.

## PRECAUTIONS

The following precautions should be taken when operating the equipment.

## GENERAL PRECAUTIONS

When installing the equipment ensure that:

- the ventilation holes are not covered.
- air is allowed to circulate freely around the equipment.
- it is placed on a vibration-free surface.
- it will not be exposed to excessive heat, cold, moisture or dust.
- it will not be exposed to direct sunlight.
- it will not be exposed to electrostatic discharges.

In addition, never place heavy objects on the equipment.

If a foreign object or water does enter the equipment, contact your nearest dealer or service center.

Do not pull out the plug by pulling on the mains lead; grasp the plug. It is advisable when leaving the house for an extended period, or during a thunderstorm, to disconnect the equipment from the mains supply.

## PRODUCT FEATURES

This is the first Super Audio CD Player to be released on the market after some thoroughgoing preparations made by Phillips and Marantz who are the developers of Super Audio CDs. It is a showpiece model which is designed to achieve a sophisticated reproduction of the sound performance inherent to Super Audio CDs. The main features of this unit include:

- A D/A converter which directly converts the DSD signals into analog signals with a high sound quality by means of DAC7 (TDA 1547 x 4)
- A DF7 digital filter (TDA 1307) with 8X oversampling (during CD playback)
- A low noise distortion circuitry featuring a differential configuration HDAM
- Audio circuitry kept free from noise by using a super ring toroidal transformer, featuring a large capacity and low leakage flux and shielded by a copper-plated cover, for the main power transformer and by employing a separate transformer for the exclusive use of the display tube
- A high-rigidity, high-precision zinc diecast mechanism chassis and aluminum diecast disc tray firmly anchored by a double-bottom chassis constructed with two layers of 3.2 mm thick copper-plated steel plates
- An elegant design with a luxury look achieved by the extravagant use of aluminum block and thick aluminum sheet materials
- A stylish remote control unit made of aluminum top plate

## ABOUT SUPER AUDIO

Super Audio CD is the next-generation audio disc format. It has been jointly developed and standardized by Sony and Phillips of the Netherlands which are CD licensers. Compared with the Pulse Code Modulation (PCM) system used for digital audio recording as typified by conventional CDs, the Super Audio CDs are recorded using the Direct Stream Digital (DSD) system which has about 4 times more information per unit time. The system theoretically achieves a dynamic range of 120 dB within the audible frequency band and a wide playback frequency band that exceeds 100 kHz. It is capable of recording a maximum of 255 programs for up to 109 minutes.

## ABOUT THE DISCS WHICH CAN BE PLAYED BY THIS UNIT

This unit can play the following 4 kinds of discs.  
(As seen with the label surface facing up)

### 1. Super Audio CDs (single-layer discs)

Super Audio CDs feature a 2-layer construction, and the layer on which the Super Audio CD signals are recorded is called the high-density (HD) layer. Only Super Audio CD signals are recorded on single-layer discs.

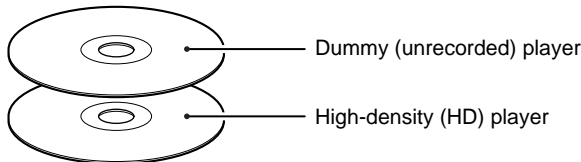

### 2. Super Audio CDs (dual-layer discs)

These discs have two HD layers to enable prolonged playback. They are made with a semi-transparent film so that both layers can be played without having to flip the disc over. Switching between the two playback layers is done automatically.

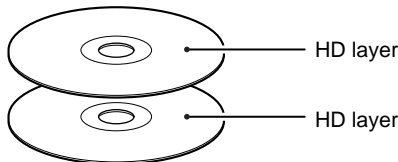

### 3. CD/CD-R discs (recorded in the CD-DA format) (Conventional music CDs)

These are the music CDs available in stores today.

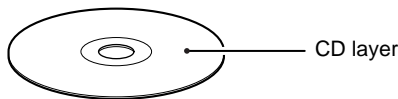

### 4. Hybrid discs (Super Audio CD + CD)

These feature a combination of the CD layer of conventional discs and one HD layer of the Super Audio CDs.

When one of these discs is read by this unit, priority is given to playing the HD layer of the Super Audio CD. To play the CD layer, switch over to this layer by pressing the **[SACD/CD]** button on the main unit or on the remote control unit while the unit has stopped operating.

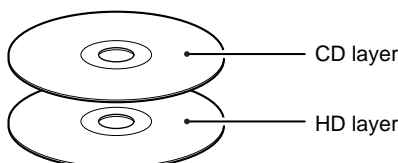

## COMPACT DISCS

The glossy side shining like a rainbow is the front side of the disc, and the side on which the label is printed is the back. Unlike conventional turntables for playing analog discs, the SA-1 Super Audio CD Player reads the information recorded on the disc from underneath without contacting it using a beam of laser light. Therefore, the performance of a compact disc will not degrade like conventional analog records.

Handle discs carefully so as not to damage or scratch the front side. To protect the disc, avoid placing it in the following locations:

- In direct sunlight or near a source of heat like a heater.
- In a place which is damp or dirty.
- In a place which could be exposed to rain, such as near a window.

Always keep the disc surface clean.

Up to six billion data units are recorded on the front side of the disc. When cleaning the disc surface, always be sure to use a special compact disc cleaner and wipe as shown below.

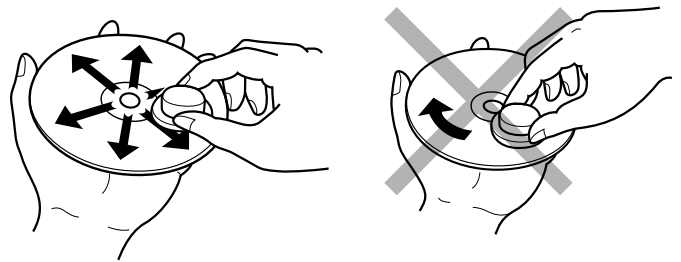

Wipe in a radial direction. Do not wipe in circumferential direction.

- Do not use conventional record cleaner for analog records, as this will adversely affect the disc surface.  
Store discs properly by placing them in their disc cases.
- Do not attach a piece of paper or sticker on the label side of disc. When a disc has a piece of plastic tape or rental CD label with paste protruded from the edge or when a disc has a trace of such a sticky object, do not attempt to play the disc. If such a disc is played on the CD player, impossibility of taking out the disc or other malfunction may result.

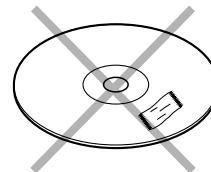

- Do not use a disc with a special shape. Do not attempt to play a disc with a special shape such as a heart-shaped disc or octagonal disc. Otherwise the equipment malfunction may result.

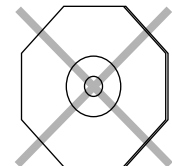
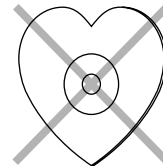

## WARNINGS FOR LASER RADIATION

**CAUTION:** INVISIBLE LASER RADIATION WHEN OPEN. DO NOT STARE INTO BEAM.

**DANGER:** INVISIBLE LASER RADIATION WHEN OPEN. AVOID DIRECT EXPOSURE TO BEAM.

# CONNECTIONS

**NOTE**

For protection of the components and the speakers, be sure to turn off the power before making connections.

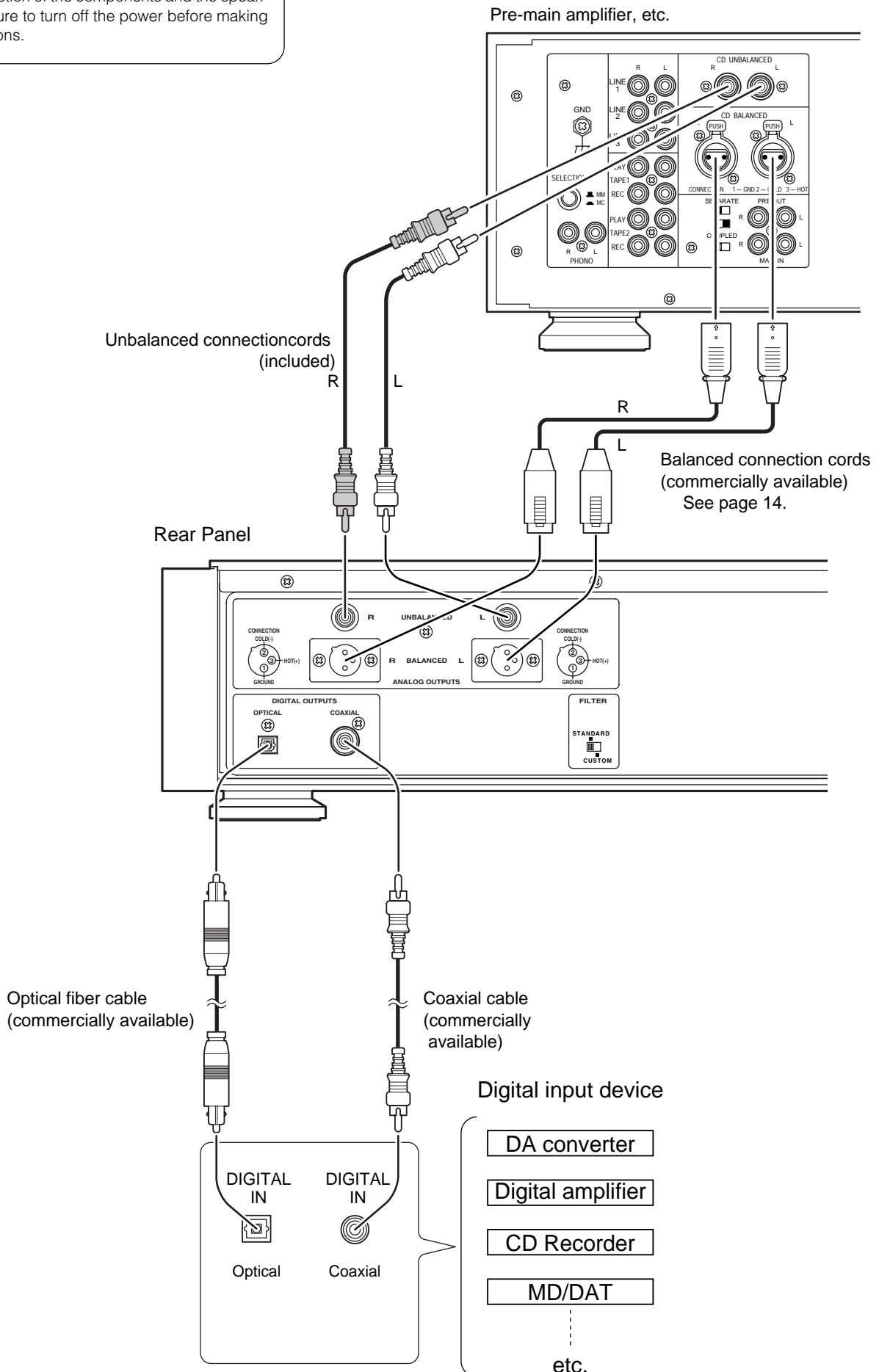

# CONTROLS, CONNECTIONS AND INDICATORS

Please read the following instructions referring to the illustration on page 28.

Some of the operations described in this user's guide can only be operated from the remote control unit. In the description of controls, the names of the buttons which are available on both the main unit and the remote control unit are enclosed in  , and the names of the buttons which are available only on the remote control unit are enclosed in  .

## FRONT

### 1 POWER switch

Press to switch power ON, and press again to switch OFF.

### 2 DISC TRAY

Place a disc with the label side up.

### 3 ▶ PLAY button

Press to start playback.

### 4 ■ STOP button

Press to stop playback. This button is also used for deleting a program.

### 5 || PAUSE button

Press to interrupt playback temporarily. When pressed again, the indicator goes out and playback resumes from the same position.

### 6 ◀◀ / ▶▶ (Track Skip/Search) buttons

These serve as both the track skip buttons and search buttons for the main unit only.

▶▶▶▶ : The same number of tracks as the number of times the button is pressed are skipped in the forward direction. When the button is held down, tracks are searched (fast forward).

◀◀◀◀ : When this button is pressed, play returns to the start of the track now being played. The same number of tracks as the number of times the button is pressed can be skipped in the reverse direction. When the button is held down, tracks are searched (fast backward).

### 7 Display

Shows information such as the power ON/OFF state, track number, playing time and current operation mode.

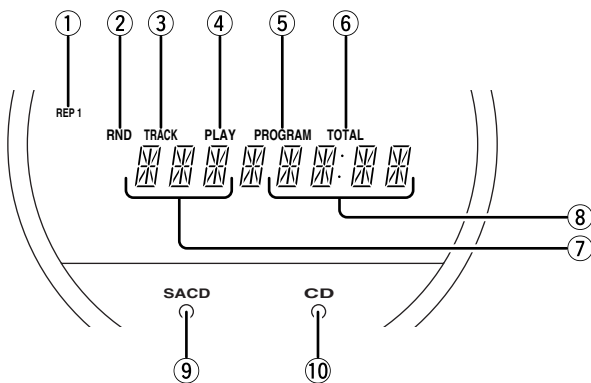

### 1 REP (Repeat) indicators

REP: Lights up during all-track repeat mode, which plays all the tracks on the disc repeatedly.

REP 1: Lights up during 1-track repeat mode, which repeatedly plays a single track repeatedly.

### 2 RND (Random) indicator

Lights up in the random play mode.

### 3 TRACK indicator

Lights up when the track number being played is displayed.

### 4 PLAY indicator

Light up during Disc playback.

### 5 PROGRAM indicator

Lights up in the programming mode.

### 6 TOTAL indicator

Indicates the remaining playing time of the entire disc. In program mode, this indicator shows the remaining playing of the current program.

### 7 Track number indicator

Indicates the total number of the tracks on the disc when the unit has stopped operating. During play, it indicates the number of the track which is now playing.

### 8 TIME indicator

Indicates the total playing time of the disc when the unit has stopped operating. During play, it indicates the playing time which has elapsed for the track which is now playing.

### 9 SACD indicator

Lights when a Super Audio CD is read.

\* In the case of a hybrid disc (see page 6), priority is given to playing the HD layer of the Super Audio CD.

### 10 CD indicator

Lights when a conventional music CD is read. It also lights when the CD layer on a hybrid disc is read.

### 8 REMOTE SENSOR

This window receives signals transmitted from the remote control unit.

### 9 ▲ OPEN/CLOSE button

Pressing the ▲ OPEN/CLOSE button opens the disc tray. Place a compact disc on the tray with the label side facing up. Gently press the front of the disc tray to close.

### 10 SACD/CD button

Press to change the layer to be played on a hybrid disc. (See page 6)

\* The layer can be changed only when the unit has stopped operating. It cannot be changed during play.

### 11 DISPLAY button

Turns the display window lighting on and off.

## REAR

### A ANALOG OUTPUT jacks (Unbalanced jack)

Connect to the CD or AUX input jacks of a preamplifier.

#### Connection method:

Connect to the CD or AUX input jacks of the amplifier. Be sure to connect the red jack to the R (right) input jack and the white jack to the L (left) input jack.

\* Never connect these jacks to the PHONO input jacks of the amplifier.

### B ANALOG OUTPUT jacks (Balanced jack)

Connect to the CD or AUX input jacks of a preamplifier.

#### Connection method:

Connect to a component equipped with balanced input connector.

### C DIGITAL OUTPUT OPTICAL output jack

The digital signal can be transmitted in the form of light through an optical fiber cable and photocoupler. The optical signal transmission features low signal loss due to cables and complete isolation of the ground loop so that the very high quality can be reproduced without any digital noise.

#### Connection method:

Connect this jack to a D/A converter, digital sound processor or an amplifier equipped with a Digital Optical input jack. Remove the caps from the DIGITAL OUTPUT OPTICAL jack and the Optical input jack of the connected component and connect the two jacks through an optical fiber cable.

\* Do not bend the optical fiber cable.

\* Leave the cap attached when the OPTICAL jack is not used.

\* Only the CD signals are output from the DIGITAL OUTPUT OPTICAL jack. No Super Audio CD signals are output.

### D DIGITAL OUTPUT COAXIAL output jack

By connecting this jack to a digital audio component (D/A converter, digital sound processor, etc.), digital signals from compact discs can be transmitted directly from the player without first being converted to analog.

\* Only the CD signals are output from the DIGITAL OUTPUT COAXIAL jack. No Super Audio CD signals are output.

### E FILTER (STANDARD/CUSTOM) switch

This is set to STANDARD or CUSTOM depending on the amplifier or speakers which are to be connected. For details, refer to the section on the filter switch on page 14.

### F AC POWER INPUT jack

Using the provided AC cord, connect to a household AC power outlet.

## USING THE REMOTE CONTROL UNIT

### 1. Remote control

Operate the remote control unit (RC-1SA) within a distance of approx. 5 m from the infrared signal reception window (remote sensor) on the front of the SACD player.

Remote control operation may not be possible if the remote control unit's transmitter is not pointing in the direction of the remote sensor or if there is an obstruction between the transmitter and the remote sensor.

#### Remote control operating range

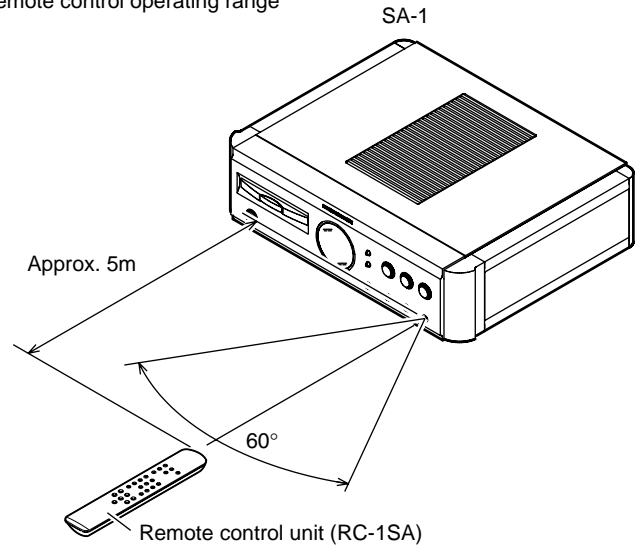

### 2. Loading batteries

Batteries in this remote control unit have a life of approximately 1 year under normal operating conditions. If the remote control unit is not going to be used for an extended period of time, remove the batteries. Also, if you notice that the batteries are starting to run down, replace them as soon as possible.

#### ① Remove the battery cover.

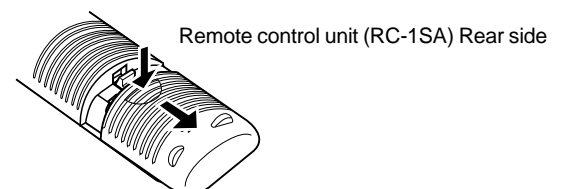

#### ② Insert the batteries with correct +/- orientation.

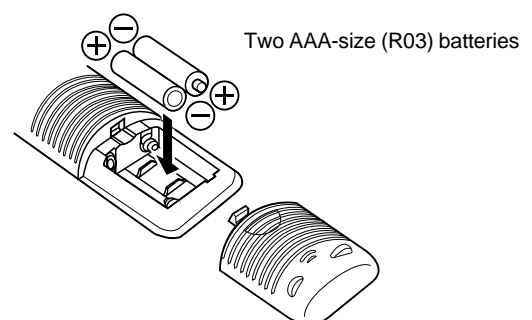

#### ③ Close the battery cover until it clicks shut.

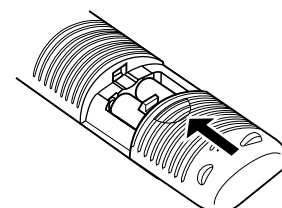

# REMOTE CONTROL UNIT RC-1SA

When the power to the SACD player is ON and a disc is loaded on the disc tray, the remote control unit (RC-1SA) can be used to operate the player's various functions.

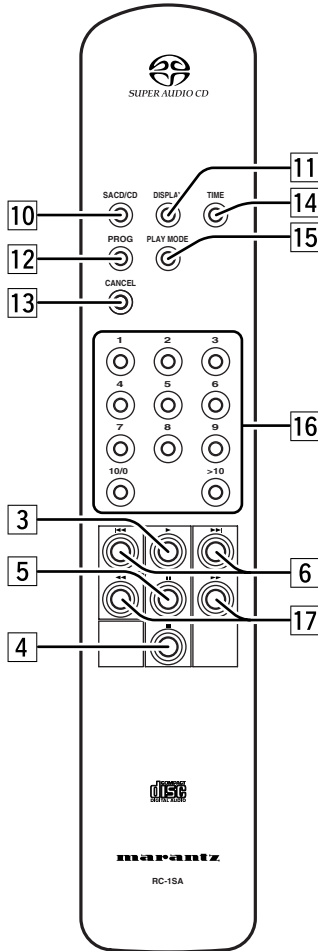

**3** **▶PLAY** button

**4** **■STOP** button

**5** **⏸PAUSE** button

**10** **SACD/CD** button

**11** **DISPLAY** button

These buttons have the same functions as the buttons with the same names on the main unit front panel. See the corresponding descriptions on page 8.

**6** **⏮, ⏭ (Track Skip/Search) buttons**

**⏭** : The same number of tracks as the number of times the button is pressed are skipped in the forward direction.

**⏮** : When this button is pressed, play returns to the start of the track now being played. The same number of tracks as the number of times the button is pressed can be skipped in the reverse direction.

\* These buttons are provided on the remote control unit separately from the search buttons. For searches, use the **17** search buttons.

**12** **PROG** button

Press to activate program play, so that only the selected tracks from the disc loaded on the disc tray will be played.

**13** **CANCEL** button

Used to delete specified track numbers from a program.

**14** **TIME** button

Switches the time shown on the display to the remaining time of the current track or the remaining time of the entire disc.

**15** **PLAY MODE** button

Press for repeat play or random play. Each time it is pressed, one mode is selected in the following cycle: "All-track repeat" → "1-track repeat" → "Random play" → "Release" (see page 12)

**16** **Numeric ( 1 to 9, 10/0, >10 ) buttons**

When used during playback, these buttons allow you to specify the number of another track you want to play.

When used during stop mode, these buttons allow you to specify the number of a track from which to start playback.

These buttons are also used to select tracks for programming.

**17** **⏪, ⏩ (Search Reverse/Forward) buttons**

**⏪** : When pressed during playback, this button fast-reverses the play position.

**⏩** : When pressed during playback, this button fast-forwards the play position.

ENGLISH



# NORMAL PLAYBACK OPERATION

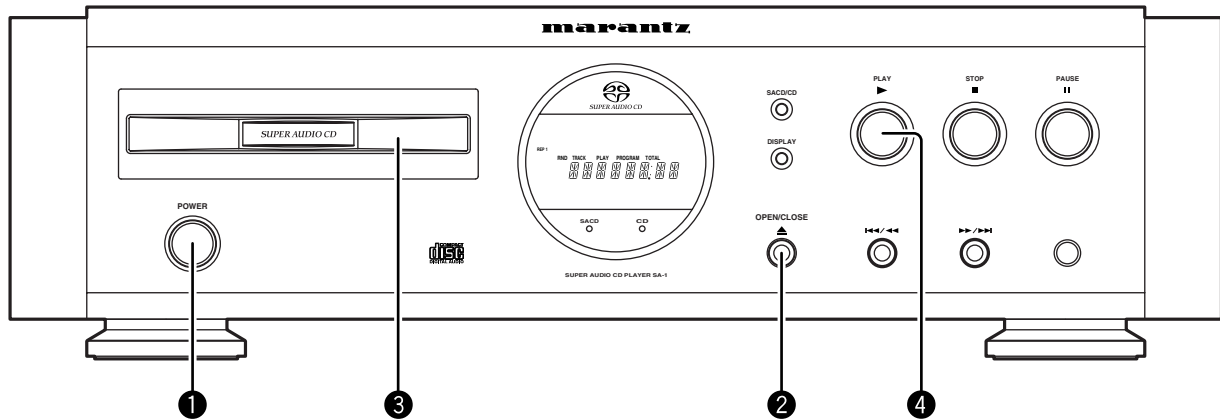

- 1 Press the **POWER** switch to turn on the power.

Display indications

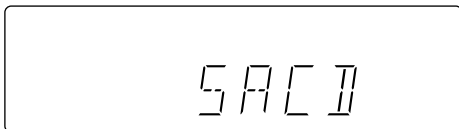

- 2 Press the **OPEN/CLOSE** button.  
When the disc tray opens, place a disc on the tray with the label side up.
- 3 Gently press the front of the disc tray or press the **OPEN/CLOSE** button to close the tray.
- 4 Press the **PLAY** button.  
When the button is pressed, the **PLAY** indicator lights up.  
While the disc is playing, the display shows the track number and elapsed playing time of the track currently playing, along with the numbers of the tracks still to be played or playing.

\* In the case of an SACD/CD hybrid disc, priority is given to playing the SACD layer. To play the CD layer, first stop the unit's operation, and use the **SACD/CD** button to switch to the CD layer.

(Example: When 2 minutes and 17 seconds of track 5 have already been played)

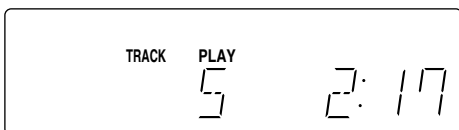

To stop playback:  
Press the **STOP** button.

To remove the disc:  
Open the disc tray by pressing the **OPEN/CLOSE** button, remove the disc, then close the tray by lightly pressing its front edge. Always keep the disc tray closed even when the CD player is not being used.

To pause playback:  
Press the **PAUSE** button.  
The PAUSE indicator lights up and playback pauses at the position where the button was pressed. To resume playback from the pause position, press the **PAUSE** or **PLAY** button again.

To switch the time display:  
Press the **TIME** button.  
Each time the **TIME** button is pressed, the time display changes in the following order: Elapsed playing time of the currently playing track → Remaining playing time of the current track → Total remaining time in the disc → Elapsed playing time of the current track.

- Elapsed playing time  
(Example: When 0 minutes and 36 seconds of track 3 have already been played)

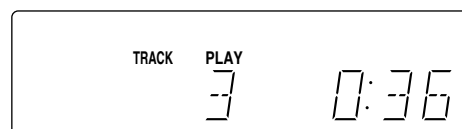

- Remaining playing time of a track  
(Example: Track 3 is playing, and 6 minutes and 20 seconds of the track's playing time remain)

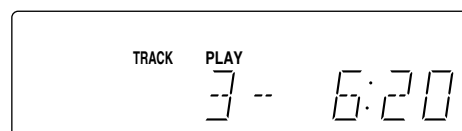

- Total remaining playing time of disc  
(Example: Track 3 is playing, and 48 minutes and 38 seconds of the disc's playing time remain)

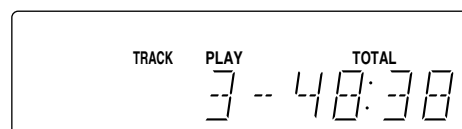

## SEARCHING/SKIPPING

### Direct search (specifying a desired track number)

Specify the track number using numeric buttons ( **1** - **9** ), **10/0**, **>10** ).

- With tracks 1 to 10, specify directly which track is to be played, and immediately the track is searched and its play is commenced.

Example : Track 3 → Press **3**.

Track 10 → Press **10/0**.

- With tracks 11 and following, first press **>10**, and then specify the track number to be played.

Example : Track 12 → Press **>10**. Then press **1** and **2**.

- With tracks 100 and following, first press **>10** twice, and then specify the track number to be played.

Example : Track 123 → Press **>10** twice. Then press **1**, **2** and **3**.

\* If 10 seconds are allowed to elapse before the next button is pressed after **>10** or **1**, the original status will be restored.

### Track Skip

#### Next (skipping to a desired track located after the currently playing track)

Press the **▶▶** button the necessary number of times to skip to the desired track.

#### Previous (skipping to a desired track located after the currently playing track)

When the **◀◀** button is once pressed during play, play moves to the start of the track now playing. Press this button for the same number of times as the number of tracks to be skipped in the reverse direction.

\* If the **◀◀** button has been pressed within 2 or so seconds from the start of the track now playing, play moves to the previous track.

\* In All-track repeat mode, pressing the **◀◀** button twice in the middle of the first track in a disc skips to the last track, and pressing the **▶▶** button in the middle of the last track skips to the first track.

## REPEAT PLAY

### All-track repeat (repeated playback of all tracks on the disc)

During playback, press the **PLAY MODE** button once.

The "REP" indicator lights up and all the tracks on the disc are played repeatedly.

Even if the **PLAY MODE** button is pressed in stop mode, playback will start and repeat playback will be carried out.

To resume normal playback:

Press the **PLAY MODE** button third. The "REP" indicator goes out, repeat mode is cancelled and normal playback resumes.

### 1-track repeat

#### (repeated playback of one track only)

While the track you want to repeat is playing, press the **PLAY MODE** button twice.

The "REP" and "1" indicators light up and the current track will be played repeatedly.

To cancel 1-track repeat play:

Press the **PLAY MODE** button twice.

## RANDOM PLAY

In this mode, the CD player automatically selects and plays tracks in random order. All tracks are played once.

Press the **PLAY MODE** button third.

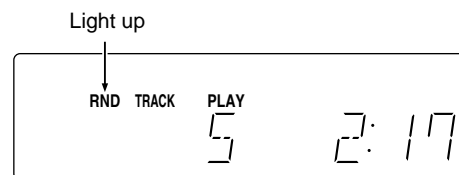

- To stop random playback and resume normal playback: Press the **PLAY MODE** button again.

- If the **▶▶** button is pressed during random playback:

Each time one of these buttons is pressed, the CD player selects a track at random and starts playing that track.

# PROGRAM PLAY

## Programming (To play the desired tracks in a certain order)

(Example: To program track No. 6 first, then track No. 14.)

- 1 Press the **PROG** button in stop mode. The PROGRAM indicator flashes.

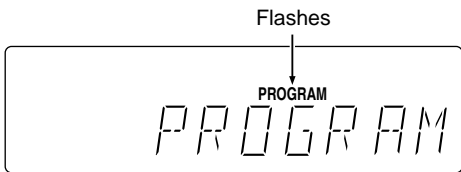

\* If the operations in step 1 and following are not performed within 30 seconds in this mode, the unit will automatically return to the stop mode.

- 2 Specify the first track to be programmed using the numeric buttons.

(Display example: The first programmed track is track number 6.)

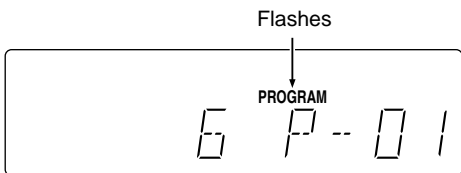

- 3 Then program another track by repeating the procedure in step 2 above. Up to 20 tracks can be programmed in this way.

(Display example: The second programmed track is track No. 14.)

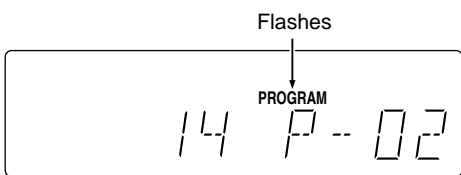

- 4 After having programmed all the desired tracks, press the **STOP** button.

The PROGRAM indicator status changes from flashing to continuously lit, indicating that the program is completed.

\* When performing steps 2 to 4, the program will be automatically entered unless the next operation is performed within 10 seconds.

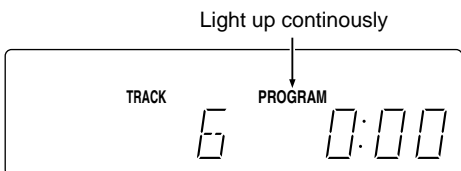

- 5 Press the **PLAY** button. The programmed tracks will be played in the programmed order.

## To check the program contents

Press the **▶▶** button while the unit has stopped operating. The programmed tracks (track numbers) will appear one after the other in the sequence in which they were programmed.

## To add programs

Press the **PROG** button in the stop mode. The PROGRAM indicator will flash, indicating that programs can now be added.

## To delete programmed tracks

- 1 If the program has already been entered, press the **PROG** button to establish the program input mode.
- 2 Then press the **CANCEL** button to delete the tracks in sequence starting with the one programmed last.

### Q&A

- How many tracks is it possible to program?  
Up to 20 tracks can be included in the program. With delete programming, up to 20 tracks can be omitted from the program.
- How do you play programmed tracks repeatedly?  
Press the **PLAY MODE** button once. The REP indicator lights up and the program playback will be repeated.
- How do you play programmed tracks in a random order?  
No.

## ABOUT BALANCED JACKS

- ① The balanced output connector uses a XLR connector.
- ② The XLR connector for professional use is internally wired in either of the following two systems.

1. USA system (Pin 2 = COLD, Pin 3 = HOT)

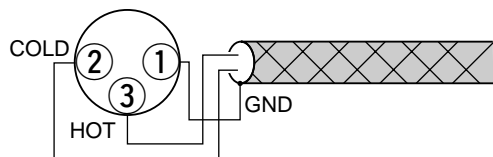

2. European system (Pin 2 = HOT, Pin 3 = COLD)

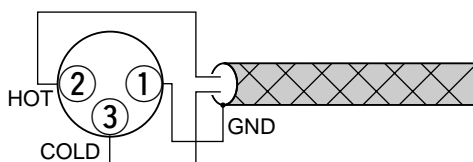

- ③ The SA-1 uses the USA system of 1.

When a preamp or main amplifier adopting the European system is connected using a cable with XLR balanced connectors, the reproduced signal may be inverted of phase.

In this case, correct the wiring of the one of the XLR connectors on the extremities of the cable to the USA system by exchanging the connections of pins 2 and 3. This will make it possible to play the signal with the correct phase.

## ABOUT THE FILTER

Super Audio CDs have a wide playback frequency band of about 100 kHz that is beyond the audible range: this means that their signals contain ultra-high-range components that conventional CDs do not have. A conventional amplifier is often not built to reproduce signals containing these components, and when Super Audio CD signals are output in their original state, noise may be generated, the amplifier's protection circuits may be activated and/or the speakers may be damaged.

To prevent this sort of trouble from occurring, the unit incorporates a filter for attenuating the ultra-high-range components, and the filter can be set STANDARD or CUSTOM using a switch on the rear panel. (This switch is set to STANDARD when the unit is shipped from the manufacturing plant.)

When the unit is to be connected with a next-generation amplifier that supports Super Audio CDs, loosen the screws at the side of the switch, release the protector, and set the switch to CUSTOM for use. This will ensure play with a wider frequency range.

\* Use the switch at the STANDARD position if the unit is to be used with a regular amplifier. Otherwise, the amplifier and/or speakers may be damaged.

\* Even when the unit has been connected with an amplifier that supports Super Audio CDs, change the switch to the STANDARD position when recording Super Audio CD sound on a tape deck, for instance.

## TROUBLE SHOOTING

If you think a malfunction has occurred, first check the points listed below. The problem is likely to have been caused by a simple operational error or a connection problem. If the problem cannot be corrected even after carrying out the following checks, consult your dealer or nearest Marantz sales office or service counter.

- **The disc fails to rotate.**

1. Is the mains lead plugged in properly?
2. Is the POWER switch ON?
3. Is the disc placed in the correct position on the disc tray?
4. Is the disc placed properly with the label side facing up?
5. Is the disc dirty?
6. Is the disc scratched?
7. Is the disc warped?

- **The disc is rotating but no sound is heard.**

1. Are the amplifier and speakers connected properly?
2. Is the amplifier switch ON?
3. Is the amplifier's volume control set at the minimum level?
4. Is the amplifier's selector switch set to the correct input ("CD" or "AUX", whichever corresponds to the input jacks the SACD player is connected to)?

- **The disc stops in mid-operation.**

1. Is the disc dirty?
2. Is the disc scratched?
3. Is the disc warped?

- **The sound drops out or noise is heard.**

1. Is the disc dirty?
2. Is the disc scratched?
3. Is the disc warped?

- **Remote control operation is not possible.**

1. Is the remote control unit's transmitter pointed correctly at the remote sensor on the front of the SACD player?  
Or is there an obstruction between the transmitter and the remote sensor?
2. Are the batteries in the remote control unit exhausted?
3. Is there another strong light (from a window, etc.) striking the SACD player's remote sensor?

- **A CD-R disc cannot be played.**

1. Is the disc placed upside down?
2. Is the disc contains properly written TOC?

## OPERATING PRECAUTIONS

- In the winter you may notice that condensation forms on the window of a well-heated room.  
Condensation may also occur inside the SACD player in the following situations:
  - When the listening room is first heated.
  - When the humidity in the room is high.
  - When the unit is moved from a cold environment to a warm room.
- If condensation occurs, the number of tracks cannot be read and the SACD player may not function properly. If this happens, leave the power ON and wait for about 30 minutes before operating the unit.
- The SACD player may interfere with the reception of your tuner or TV set. If this occurs, place the SACD player farther away from the tuner or TV.
- The SACD player features very little noise compared to analog records, and the noise before actual playback begins is almost inaudible. Therefore, be careful not to set the volume control of the amplifier too high, otherwise other audio components such as the speakers may be damaged when actual playback starts.

## CLEANING OF EXTERIOR SURFACES

With proper care and cleaning, the exterior finish of your equipment will last indefinitely. Never use scouring pads, steel wool, scouring powders or harsh chemical agents (e.g. lye solution), alcohol, thinners, benzene, insecticide or other volatile substances, as these will mar the finish of the cabinet. Likewise, never use cloths containing chemical substances. If the equipment becomes dirty, wipe the external surfaces with a soft, lint-free cloth.

If the cabinet becomes heavily soiled:

- dilute some washing-up liquid in water, in a ratio of one part detergent to six parts water;
- dip a soft, lint-free cloth in the solution and wring the cloth out until it is damp;
- wipe the equipment with the damp cloth;
- dry the equipment by wiping it with a dry cloth.

## REPAIRS

Only the most competent and qualified service technicians should be allowed to service the equipment. The Marantz company and its factory-trained warranty station personnel have the knowledge and special facilities needed for the repair and calibration of this precision equipment. After the warranty period has expired, repairs will be performed for a charge if the equipment can be restored to normal operation. In the event of difficulty, consult your dealer or write directly to the nearest location to you that is listed on the Marantz Authorized Service Station list. Please quote the model and serial number of the equipment and give a full description of what you think is abnormal about the equipment's behaviour.

## Free Manuals Download Website

<http://myh66.com>

<http://usermanuals.us>

<http://www.somanuals.com>

<http://www.4manuals.cc>

<http://www.manual-lib.com>

<http://www.404manual.com>

<http://www.luxmanual.com>

<http://aubethermostatmanual.com>

Golf course search by state

<http://golfingnear.com>

Email search by domain

<http://emailbydomain.com>

Auto manuals search

<http://auto.somanuals.com>

TV manuals search

<http://tv.somanuals.com>