

# marantz®

## **Model NA-11S1 Getting Started**

---

Network Audio Player

# Welcome

Thank you for choosing a Marantz network audio player. This guide provides step-by-step instructions for setting up your network audio player.

## **If you have setup problems:**

If you need additional help in solving problems, contact Marantz customer service in your area.

# Before You Begin

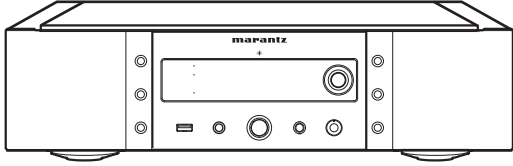
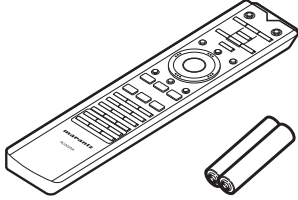
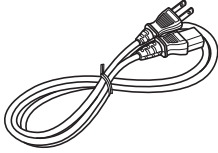
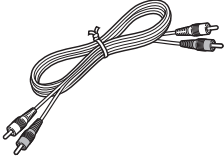
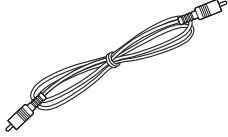
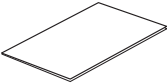
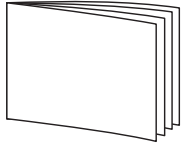
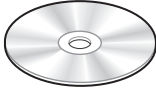

## What's In the Box

 <p>Network audio player</p>	 <p>Remote control unit and Batteries</p>	
 <p>Power cord</p>	 <p>Audio cable</p>	 <p>Remote connector cable</p>
 <p>Safety Instructions</p>	 <p>Getting Started</p>	 <p>Owner's Manual</p>

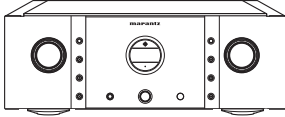
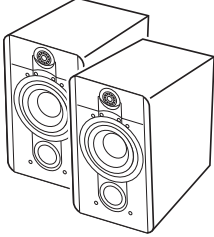
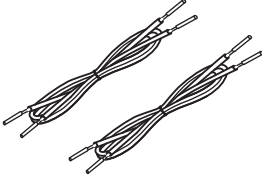

## Required for Basic connections

 <p>Amplifier</p>	 <p>Speaker systems</p>	 <p>Speaker cables</p>
--	--	---

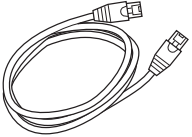
## Required for Network connections

 <p>Modem</p>	 <p>Router</p>	 <p>LAN cable</p>
--	---	--

## Required for PC Audio connections

 <p>Computer</p>	 <p>USB cable</p>
---	--



These drawings are for illustrative purposes only and may not represent the actual product(s).

# Setup Steps

There are five steps to the setup process.

- 1** Before using the remote control unit
- 2** Connect to the amplifier
- 3** Enjoying music using Network
- 4** Enjoying music using PC
- 5** Enjoying music using Apple AirPlay®

# 1 Before using the remote control unit

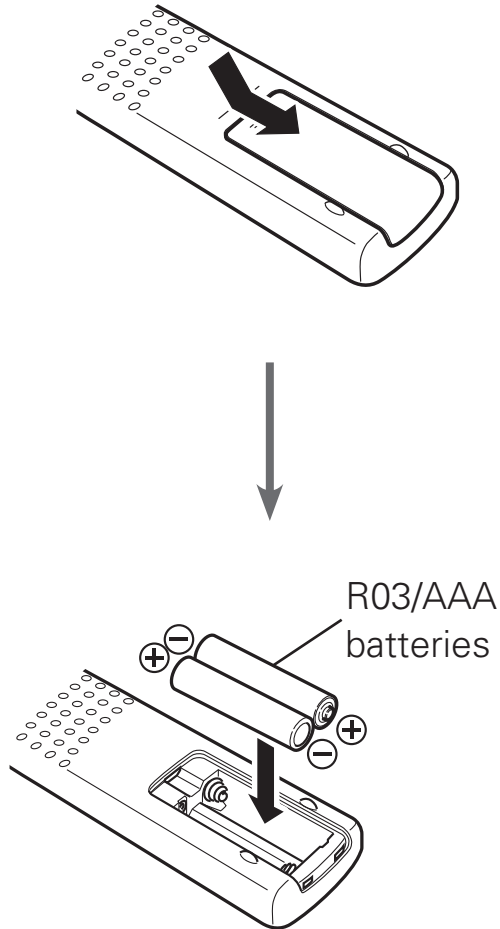

# 2 Connect to the amplifier

NA-11S1 (Rear panel)

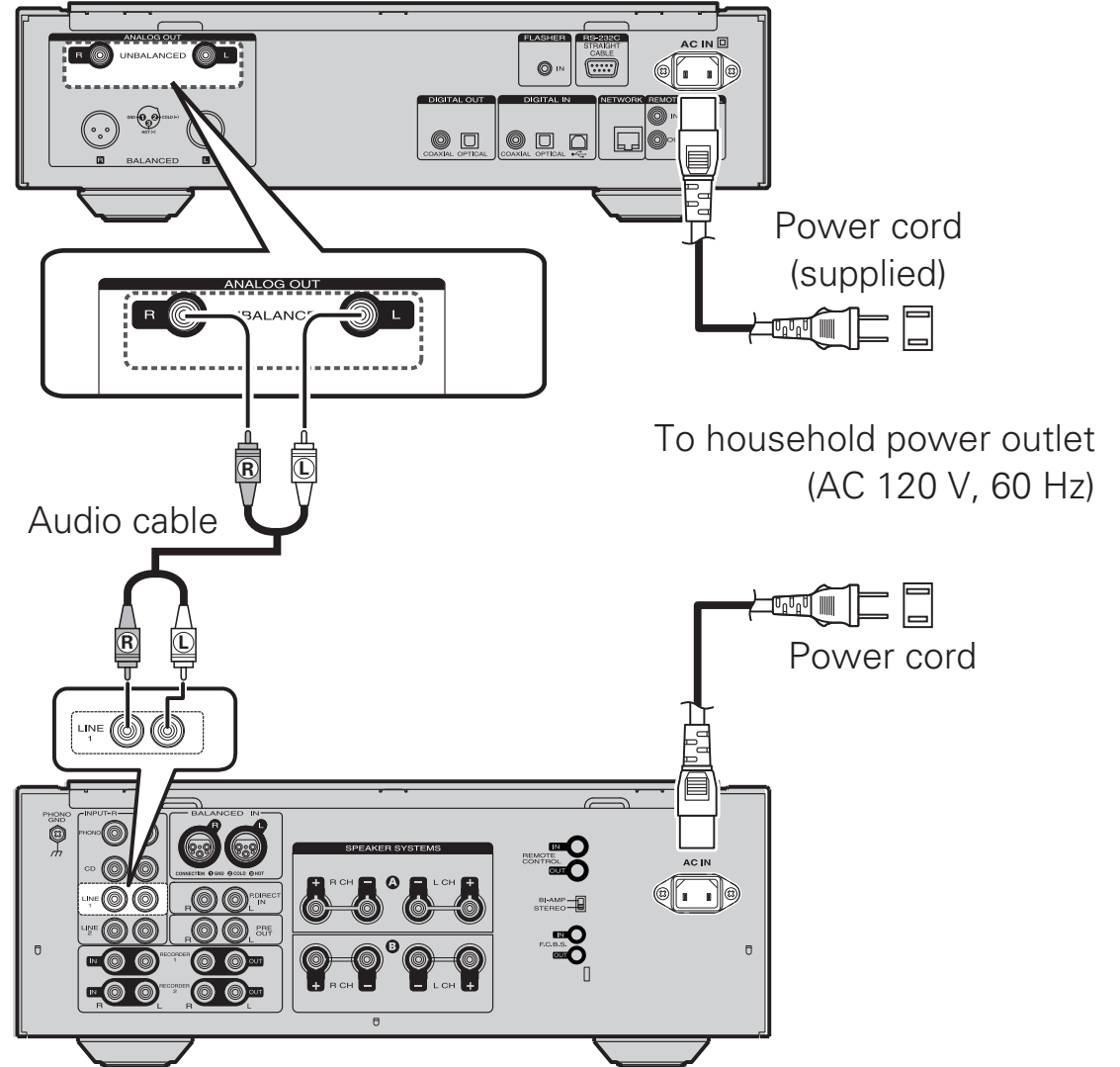

Amplifier (Rear panel)

# 3 Enjoying music using Network

## □ Connect to Network

- 1** Connect a LAN Cable between the NA-11S1 and your router.

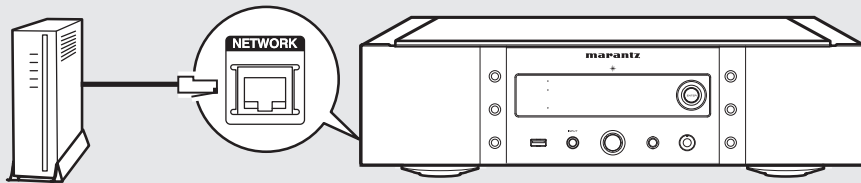

- 2** Power on.

- 3** Select language.

[Select Language]  
 ◆ English  
 ⚡ :select    🗨 :enter

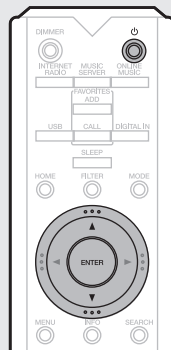

- 4** Select Network Control.

[Network Control]  
 ◆ On  
 Select to use the ...

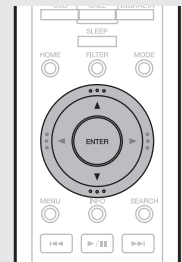

- Select "ON" to control NA-11S1 from your smartphone, use Apple AirPlay® and maintain constant network access.  
Power consumption during standby power will be slightly higher.
- Select "OFF" to reduce power consumption during standby.  
You can not turn on NA-11S1 or use Apple AirPlay from your smartphone until NA-11S1 is powered on manually and then connects to your network.

- 5** Setup is complete.

Setup Complete!

## ☐ Listen to Internet Radio

- 1** Press **INTERNET RADIO**.
- 2** Select the item, then press **ENTER**.
- 3** Repeat step **2** to select the station, then press **ENTER**.



You can play back music files stored on a PC or NAS within the same network. For instructions on how to play back these files, see "Playing files stored on a PC and NAS" in the Owner's Manual.

# 4 Enjoying music using PC

## □ Connect to PC

- 1 **Download the driver for this unit from the Marantz web site and install it on your PC.**

Operation will not occur correctly if connected to the computer before the dedicated driver has been installed.

- 2 **Connect to PC.**

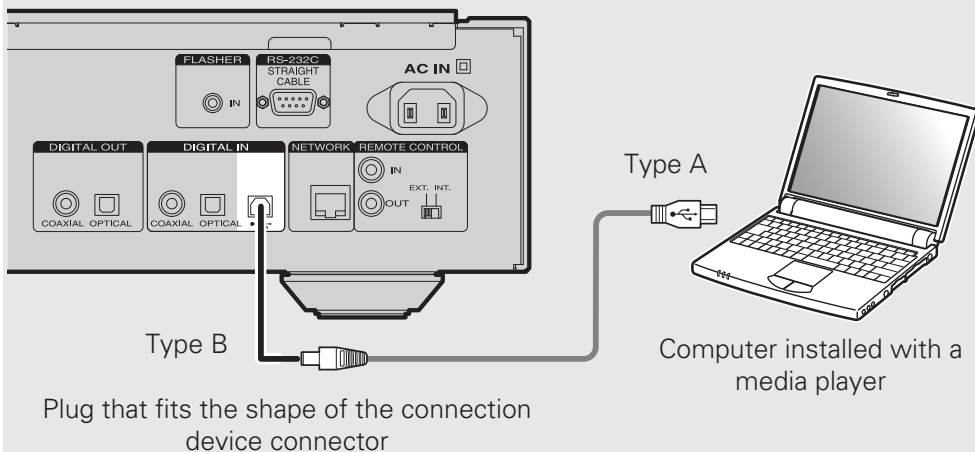

- 3 **Power on.**

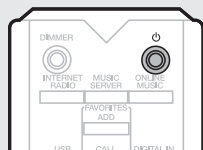

When you turn on the power of this unit for the first time, the Quick Setup menu is displayed. Perform settings according to the instructions shown on the display.

## □ Listen to PC Audio

- 1 **Press DIGITAL IN to change the input source to “PC”.**

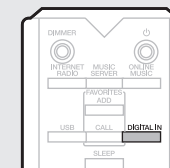

- 2 **Play back a music file with music playback software such as Windows Media Player and iTunes.**

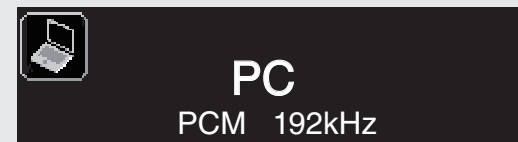

The type and sampling frequency of the music file are displayed.



Please refer to the Owner's manual about the required specifications of suiting Computer.



## 5 Enjoying music using Apple AirPlay®

- 1 Tap the AirPlay icon from within any music app that supports AirPlay.
- 2 Select the “Marantz NA-11S1” from the AirPlay Device list.

### NOTE

- When using AirPlay, a router with the Wi-Fi function is required.
- Make sure your iOS device is on the same network as the NA-11S1.

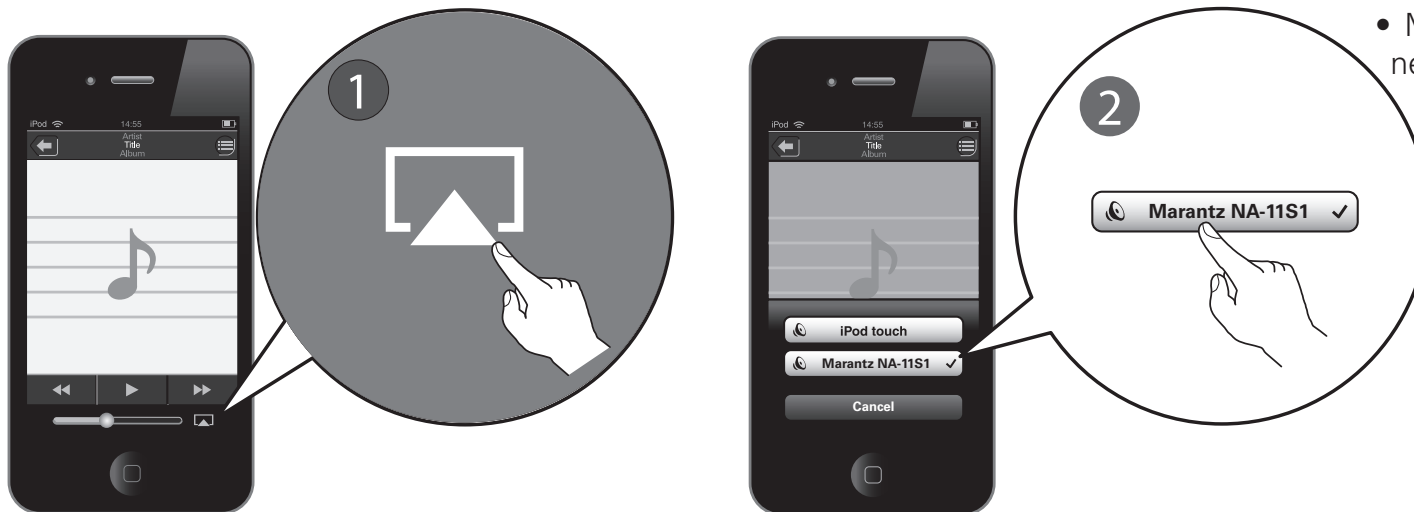

# Owner's Manual

The included CD-ROM contains an Adobe PDF version of the full owner's manual for the network audio player. Please reference this manual for more details about the setup and operation of the network audio player and its features.

## 1 Insert the disc into your PC.

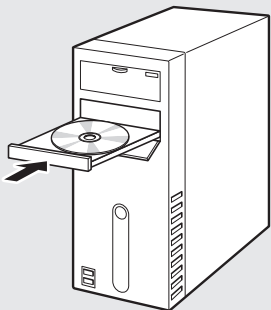

## 2 Follow the screen or double click on the PDF file.

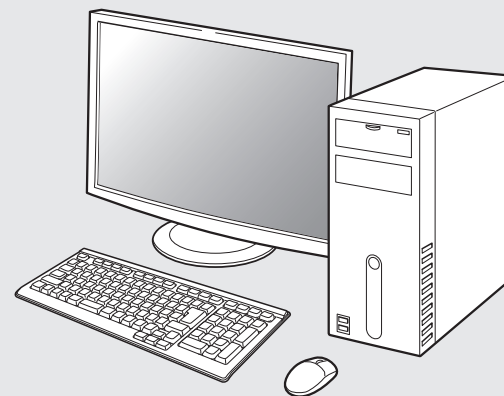

Product Name : Network Audio Player  
Model Number : NA-11S1

**[www.marantz.com](http://www.marantz.com)**

You can find your nearest authorized distributor or dealer on our website.

**marantz**<sup>®</sup> is a registered trademark.

## Free Manuals Download Website

<http://myh66.com>

<http://usermanuals.us>

<http://www.somanuals.com>

<http://www.4manuals.cc>

<http://www.manual-lib.com>

<http://www.404manual.com>

<http://www.luxmanual.com>

<http://aubethermostatmanual.com>

Golf course search by state

<http://golfingnear.com>

Email search by domain

<http://emailbydomain.com>

Auto manuals search

<http://auto.somanuals.com>

TV manuals search

<http://tv.somanuals.com>