

marantz
PROFESSIONAL

Model PMD661 User Guide

Handheld Solid State Recorder

| | | |
|------------------------------------------------------------------------------------------------------------------------------------------------------------------------------------|-----------------------------------------------------------------------|----------------------------------------------------------------------------------|
|  | CAUTION RISK OF ELECTRIC SHOCK DO NOT OPEN |  |
| CAUTION: TO REDUCE THE RISK OF ELECTRIC SHOCK, DO NOT REMOVE COVER (OR BACK). NO USER-SERVICEABLE PARTS INSIDE. REFER SERVICING TO QUALIFIED SERVICE PERSONNEL. | | |



The lightning flash with arrowhead symbol within an equilateral triangle is intended to alert the user to the presence of uninsulated "dangerous voltage" within the product's enclosure that may be of sufficient magnitude to constitute a risk of electric shock to persons.



The exclamation point within an equilateral triangle is intended to alert the user to the presence of important operating and maintenance (servicing) instructions in the literature accompanying the product.

WARNING

**TO REDUCE THE RISK OF FIRE OR ELECTRIC SHOCK,
DO NOT EXPOSE THIS APPLIANCE TO RAIN OR MOISTURE.**

CAUTION:

**USE OF CONTROLS OR ADJUSTMENTS OR PERFORMANCE
OF PROCEDURE OTHER THAN THOSE SPECIFIED HEREIN
MAY RESULT IN HAZARDOUS RADIATION EXPOSURE.**

Copyright

Recording and playback of any material may require consent. For further information refer to the following US ordinances:

- Copyright act of 1956
- Dramatic and Musical Performance Act 1958
- Performers Protection Acts 1963 and 1972
- Any subsequent statutory enactments and orders

IMPORTANT SAFETY INSTRUCTIONS

READ BEFORE OPERATING EQUIPMENT

This product was designed and manufactured to meet strict quality and safety standards. There are, however, some installation and operation precautions which you should be particularly aware of.

1. Read these instructions.
2. Keep these instructions.
3. Heed all warnings.
4. Follow all instructions.
5. Do not use this apparatus near water.
6. Clean only with dry cloth.
7. Do not block any ventilation openings. Install in accordance with the manufacturer's instructions.
8. Do not install near any heat sources such as radiators, heat registers, stoves, or other apparatus (including amplifiers) that produce heat.
9. Do not defeat the safety purpose of the polarized or grounding-type plug. A polarized plug has two blades with one wider than the other. A grounding type plug has two blades and a third grounding prong. The wide blade or the third prong are provided for your safety. If the provided plug does not fit into your outlet, consult an electrician for replacement of the obsolete outlet.
10. Protect the power cord from being walked on or pinched particularly at plugs, convenience receptacles, and the point where they exit from the apparatus.



11. Only use attachments/accessories specified by the manufacturer.
12. Use only with the cart, stand, tripod, bracket, or table specified by the manufacturer, or sold with the apparatus. When a cart is used, use caution when moving the cart/apparatus combination to avoid injury from tip-over.
13. Unplug this apparatus during lightning storms or when unused for long periods of time.
14. Refer all servicing to qualified service personnel. Servicing is required when the apparatus has been damaged in any way, such as power-supply cord or plug is damaged, liquid has been spilled or objects have fallen into the apparatus, the apparatus has been exposed to rain or moisture, does not operate normally, or has been dropped.

Additional Safety Information!

- This product should not be placed in a built-in installation such as a bookcase or rack unless proper ventilation is provided or the manufacturer's instructions have been adhered to.
- Apparatus shall not be exposed to dripping or splashing and that no objects filled with liquids, such as vases, shall be placed on the apparatus.
- The AC adaptor shall be installed near the Socket-Outlet and shall be easily accessible.

NOTE:

This equipment has been tested and found to comply with the limits for a Class B digital device, pursuant to Part 15 of the FCC Rules. These limits are designed to provide reasonable protection against harmful interference in a residential installation. This equipment generates, uses and can radiate radio frequency energy and, if not installed and used in accordance with the instructions, may cause harmful interference to radio communications. However, there is no guarantee that interference will not occur in a particular installation. If this equipment does cause harmful interference to radio or television reception, which can be determined by turning the equipment off and on, the user is encouraged to try to correct the interference by one or more of the following measures:

- Reorient or relocate the receiving antenna.
- Increase the separation between the equipment and receiver.
- Connect the equipment into an outlet on a circuit different from that to which the receiver is connected.
- Consult the dealer or an experienced radio/TV technician for help.

NOTE:

Changes or modifications may cause this unit to fail to comply with Part 15 of the FCC Rules and may void the user's authority to operate the equipment.

This Class B digital apparatus complies with Canadian ICES-003.

Cet appareil numérique de la Classe B est conforme á la norme NMB-003 du Canada.

Declaration of Conformity

- English**
We declare under our sole responsibility that this product, to which this declaration relates, is in conformity with the following standards:
EN55022, EN55024, EN61000-3-2 and EN61000-3-3 Following the provisions of 2004/108/EC Directive.
- Français**
Nous déclarons, sous notre responsabilité exclusive que ce produit, auquel cette déclaration se rapporte, est conforme aux normes suivantes :
EN55022, EN55024, EN61000-3-2 et EN61000-3-3 suivant les prescriptions de la directive 2004/108/EC.
- Español**
Declaramos bajo nuestra responsabilidad que el producto al que se refiere esta declaración cumple con las siguientes normas:
EN55022, EN55024, EN61000-3-2 y EN61000-3-3, siguiendo las disposiciones de la Directiva 2004/108/CE.
- Deutsch**
Wir erklären in alleiniger Verantwortung, dass dieses Produkt, auf das sich diese Erklärung bezieht, mit den folgenden Normen übereinstimmt:
EN55022, EN55024, EN61000-3-2 und EN61000-3-3 Gemäß den Bestimmungen der Richtlinie 2004/108/EG.
- Italiano**
Il produttore dichiara, sotto la propria esclusiva responsabilità, che il presente prodotto, al quale la dichiarazione fa riferimento, è conforme ai seguenti standard:
EN55022, EN55024, EN61000-3-2 e EN61000-3-3 secondo le disposizioni della Direttiva 2004/108/EC.
- Português**
Declaramos sob nossa total responsabilidade que este produto, com o qual a presente declaração está relacionada, está em conformidade com as seguintes normas :
EN55022, EN55024, EN61000-3-2 e EN61000-3-3 de acordo com as disposições da Directiva 2004/108/EC.
- Svenska**
Vi förkunnar under vårt egna ansvar att denna produkt, för vilken detta tillkännagivande gäller, överrensstämmer med följande normer:
EN55022, EN55024, EN61000-3-2 and EN61000-3-3 Enligt villkor i direktiv 2004/108/EC.
- Nederlands**
Wij verklaren uitsluitend op onze verantwoordelijkheid dat dit product, waarop deze verklaring betrekking heeft, in overeenstemming is met de volgende normen:
EN55022, EN55024, EN61000-3-2 en EN61000-3-3. Volgens de bepalingen van Richtlijn 2004/108/EC.

DMi D&M Installation Europe

Kingsbridge House, Padbury Oaks Longford
Middlesex UB7 0EH UK

English

WARNINGS

Do not handle the AC adaptor with wet hands.

Do not cover the ventilation with any items such as tablecloths, newspapers, curtains, etc.

No naked flame sources, such as lighted candles, should be placed on the equipment.

When disposing of used batteries, please comply with governmental regulations or environmental public instruction's rules that apply in your country or area.

Make a space of about 0.1 meter around the unit.

No objects filled with liquids, such as vases, shall be placed on the apparatus.

When the switch is in the OFF position, the equipment is not completely switched off from MAINS.

To completely disconnect this product from the mains, disconnect the plug from the wall socket outlet.

When setting up this product, make sure that the AC outlet you are using is easily acceptable.

Do not expose batteries to excessive heat such as sunshine, fire or the like.

Français

AVERTISSEMENTS

Ne manipulez pas l'adaptateur AC avec les mains mouillées.

Ne pas recouvrir les ouïes de ventilation avec un objet quelconque comme une nappe, un journal, un rideau, etc.

Ne placer aucune source de flamme nue, comme une bougie allumée, sur l'appareil. Pour mettre au rebut les piles usées, respecter les lois gouvernementales ou les règlements officiels concernant l'environnement qui s'appliquent à votre pays ou région.

Veiller à ce qu'aucun objet ne soit à moins de 0,1 mètre des côtés de l'appareil. Aucun objet rempli de liquide, un vase par exemple, ne doit être placé sur l'appareil.

Lorsque l'interrupteur est sur la position OFF, l'appareil n'est pas complètement déconnecté du SECTEUR (MAINS).

Pour déconnecter complètement ce produit du courant secteur, débranchez la prise de la prise murale.

Lors de l'installation de ce produit, assurez-vous que la prise CA que vous utilisez est compatible.

N'exposez pas les piles à une source de chaleur excessive, aux rayons du soleil ou à une flamme par exemple.

Español

ADVERTENCIAS

No manipule el adaptador de CA si tiene las manos mojadas.

No cubra la ventilación con objetos como manteles, periódicos, cortinas, etc.

No deben colocarse sobre el equipo elementos con fuego, por ejemplo velas encendidas.

Cuando se eliminen baterías usadas, deben cumplirse las reglamentaciones oficiales o las normas de protección medioambiental aplicables en su país o en su zona.

Deje un espacio de unos 0,1 metro alrededor de la unidad.

No se deben colocar sobre el aparato recipientes que contengan líquidos, como por ejemplo jarrones.

Cuando el interruptor está en la posición OFF, el equipo no está completamente desconectado de la alimentación MAINS.

Para desconectar completamente este producto de la alimentación eléctrica, desconecte el enchufe del enchufe de la pared.

Al ajustar este producto, asegúrese de que la toma de salida de CA que esté utilizando sea fácilmente aceptable.

No exponga las pilas a calor excesivo, como a la luz solar directa, el fuego, etc.

Deutsch

WARNHINWEISE

Fassen Sie das Netzgerät nicht mit nassen Händen an.

Decken Sie die Lüftungsöffnungen nicht mit einem Tischtuch, einer Zeitung, einem Vorhang usw. ab.

Es dürfen keine Gegenstände mit offener Flamme, wie etwa brennende Kerzen, auf dem Gerät aufgestellt werden.

Beachten Sie bei der Entsorgung der verbrauchten Batterien allegeltenden lokalen und überregionalen Regelungen.

Auf allen Geräteseiten muß ein Zwischenraum von ungefähr 0,1 meter vorhanden sein.

Auf das Gerät dürfen keine mit Flüssigkeiten gefüllte Behälter, wie etwa eine Vase, gestellt werden.

Wenn der Schalter ausgeschaltet ist (OFF-Position), ist das Gerät nicht vollständig vom Stromnetz (MAINS) abgetrennt.

Um dieses Gerät vollständig von der Stromversorgung abzutrennen, ziehen Sie bitte den Netzstecker von der Wandsteckdose ab.

Stellen Sie bei der Aufstellung des Gerätes sicher, dass die zu verwendende Wechselstrom-Steckdose leicht zugänglich ist.

Die Batterien dürfen nicht extremer Hitze wie direkter Sonneneinstrahlung, Feuer o.ä. ausgesetzt werden.

Italiano

AVVERTENZE

Non maneggiare l'adattatore CA con le mani umide.
Non coprire le fessure di ventilazione con tovaglie, giornali, tende od oggetti analoghi.
Non posare sull'apparecchio sorgenti di fiamme scoperte qualicandele accese.
Smaltire le pile usate in conformità alle norme governative od disposizioni ambientali vigenti nel proprio paese o zona.
Lasciare 0,1 metro liberi tutto intorno l'unità.
Non mettere sull'apparecchiatura alcun contenitore di liquido, come ad esempio dei vasi.
Quando l'interruttore è nella posizione OFF, l'apparecchiatura non è completamente scollegata da MAINS.
Per scollegare definitivamente questo prodotto dalla rete di alimentazione elettrica, togliere la spina dalla relativa presa.
Durante l'installazione, assicurarsi che la presa in CA utilizzata sia facilmente raggiungibile.
Non esporre le batterie a fonti di calore eccessivo, ad esempio alla luce diretta del sole, in prossimità del fuoco o simili.

Português

ADVERTÊNCIAS

Não toque no adaptador de AC com as mãos molhadas.
Não cobrir os orifícios de ventilação com objectos tais como toalhas de mesa, jornais, cortinas, etc.
Não colocar chamas abertas tais como velas acesas, sobre o aparelho.
Ao deitar fora as pilhas usadas, favor observar os regulamentos governamentais ou as regras com respeito ao meio ambiente que se aplicam no seu país ou área de residência.
Deixar um espaço de cerca de 0,1 metro ao redor do aparelho.
Não colocar recipientes com água, tal como vasos, sobre o aparelho.
Quando o interruptor está na posição OFF, o equipamento não fica totalmente desligado de MAINS.
Para desligar totalmente este produto da corrente, desligue a ficha da tomada de parede.
Quando instalar este produto, certifique-se de que a tomada AC que está a utilizar pode ser facilmente acedida.
Não exponha as pilhas a calor excessivo como luz do sol, incêndio ou afins.

Svenska

VARNINGAR

Hantera inte nätadaptern med våta händer.
Täck inte för ventilationsöppningarna med några föremål som till exempel bordsdukar, dagstidningar, gardiner e.d.
Inga föremål med öppen låga, som till exempel tända stearinljus, bör placeras på utrustningen.
Följ de lagar och miljöskyddsråd som gäller i det land eller områdedär du bor när du gör dig av med batterier.
Se till att det finns omkring 0,1 meter fri plats runt omkring enheten.
Inga objekt som är fyllda med någon vätska, till exempel blomstervaser, bör placeras på apparaten.
Även om strömbrytaren står i det avstängda läget OFF, så är utrustningen inte helt bortkopplad från det elektriska nätet (MAINS).
Koppla loss stickproppen från eluttaget för att helt skilja produkten från nätet.
Vid installationen av produkten ska du se till att eluttaget den ansluts till är nära utrustningen.
Utsätt inte batterierna för stark värme som solsken, eld eller liknande.

Nederlands

WAARSCHUWINGEN

Raak de netspanningsadapter niet met natte handen aan.
Bedeck de ventilatieopening niet met enige voorwerpen, zoals tafelkleden, kranten, gordijnen, enz.
Plaats geen brandende voorwerpen, zoals kaarsen, op het apparaat.
Volg bij het weggooien van verbruikte batterijen de overheidswetgeving of milieuvorschriften op die van kracht zijn in het land of de regio waarin u zich bevindt.
Zorg dat er 0,1 meter vrije ruimte rond het toestel is.
Plaats geen voorwerpen met een vloeistof erin, zoals een bloemenvaas, op het apparaat.
Als de schakelaar op OFF staat, is het apparaat niet volledig losgekoppeld van de netspanning (MAINS).
Om de voeding van dit product volledig te onderbreken moet de stekker uit het stopcontact worden getrokken.
Let er bij het plaatsen van dit product op dat het te gebruiken stopcontact goed bereikbaar is.
Stel de batterijen niet bloot aan overmatige warmtebronnen, zoals zonlicht of vuur.

A NOTE ABOUT RECYCLING:

This product's packaging materials are recyclable and can be reused. Please dispose of any materials in accordance with the local recycling regulations.

When discarding the unit, comply with local rules or regulations.

Batteries should never be thrown away or incinerated but disposed of in accordance with the local regulations concerning chemical waste.

This product and the accessories packed together constitute the applicable product according to the WEEE directive except batteries.

English



UNE REMARQUE CONCERNANT LE RECYCLAGE:

Les matériaux d'emballage de ce produit sont recyclables et peuvent être réutilisés. Veuillez disposer de tout matériau conformément aux règlements de recyclage locaux.

Lorsque vous mettez cet appareil au rebut, respectez les lois ou réglementations locales.

Les piles ne doivent jamais être jetées ou incinérées, mais mises au rebut conformément aux règlements locaux concernant les déchets chimiques.

Ce produit et les accessoires emballés ensemble sont des produits conformes à la directive DEEE sauf pour les piles.

Français



ACERCA DEL RECICLAJE:

Los materiales de embalaje de este producto son reciclables y se pueden volver a utilizar. Disponga de estos materiales siguiendo los reglamentos de reciclaje de su localidad.

Cuando se deshaga de la unidad, cumpla con las reglas o reglamentos locales.

Las pilas nunca deberán tirarse ni incinerarse. Deberá disponer de ellas siguiendo los reglamentos de su localidad relacionados con los desperdicios químicos.

Este producto junto con los accesorios empaquetados es el producto aplicable a la directiva RAEE excepto pilas.

Español



HINWEIS ZUM RECYCLING:

Das Verpackungsmaterial dieses Produktes ist für zum Recyceln geeignet und kann wieder verwendet werden. Bitte entsorgen Sie alle Materialien entsprechend der örtlichen Recycling-Vorschriften.

Beachten Sie bei der Entsorgung des Gerätes die örtlichen Vorschriften und Bestimmungen.

Die Batterien dürfen nicht in den Hausmüll geworfen oder verbrannt werden; bitte geben Sie die Batterien gemäß örtlichen Bestimmungen an den Sammelstellen oder Sondermüllplätzen ab.

Dieses Produkt zusammen mit den Zubehörteilen ist das geltende Produkt der WEEE-Direktive, davon ausgenommen sind die Batterien.

Deutsch



NOTA RELATIVA AL RICICLAGGIO:

I materiali di imballaggio di questo prodotto sono riutilizzabili e riciclabili. Smaltire i materiali conformemente alle normative locali sul riciclaggio.

Per smaltire l'unità, osservare la normativa in vigore nel luogo di utilizzo.

Non gettare le batterie, né incenerirle, ma smaltirle conformemente alla normativa locale sui rifiuti chimici.

Questo prodotto e gli accessori inclusi nell'imballaggio sono applicabili alla direttiva RAEE, ad eccezione delle batterie.

Italiano



UMA NOTA SOBRE A RECICLAGEM:

Os materiais de embalagem deste produto são recicláveis e podem ser reutilizados. Elimine quaisquer materiais de acordo com as normas de reciclagem locais.

Quando eliminar a unidade, obedeça às regras ou normas locais.

As pilhas nunca devem ser deitadas fora ou incineradas, mas sim eliminadas de acordo com as normas locais relativas aos resíduos químicos.

Este produto e os respectivos acessórios embalados em conjunto constituem o produto aplicável de acordo com a directiva WEEE, excepto as pilhas.

Português



EN KOMMENTAR OM ÅTERVINNING:

Produktens emballage är återvinningsbart och kan återanvändas. Kassera det enligt lokala återvinningsbestämmelser.

När du kasserar enheten ska du göra det i överensstämmelse med lokala regler och bestämmelser.

Batterier får absolut inte kastas i soporna eller brännas. Kassera dem enligt lokala bestämmelser för kemisktavfall.

Denna apparat och de tillbehör som levereras med den är de som uppfyller gällande WEEE-direktiv, med undantag av batterierna.

Svenska



EEN AANTEKENING WAT BETREFT HET RECYCLEREN:

Het inpakmateriaal van dit product is recycleerbaar en kan opnieuw gebruikt worden. Er wordt verzocht om zich van elk afvalmateriaal te ontdoen volgens de plaatselijke voorschriften.

Volg voor het wegdoen van desperser de voorschriften voor de verwijdering van wit- en bruingoed op.

Batterijen mogen nooit worden weggegooid of verbrand, maar moeten volgens de plaatselijke voorschriften betreffende chemisch afval worden verwijderd.

Op dit product en de meegeleverde accessoires, m.u.v. de batterijen is de richtlijn voor afgedankte elektrische en elektronische apparaten (WEEE) van toepassing.

Nederlands

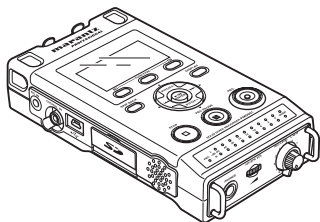

Table of Contents

| | | | | | |
|----------------------------------------|-----------|---------------------------------------|-----------|-------------------------------|-----------|
| Package Contents | 2 | Basic Playback Operation | 21 | Menu | 37 |
| Introduction | 3 | Connection Diagram | 21 | Menu Structure..... | 37 |
| Features | 3 | Playback Procedure | 21 | Top Menu | 38 |
| Quick Start Guide | 4 | Access from File List..... | 22 | Preset Menu..... | 39 |
| Names and Functions | 6 | Search..... | 23 | Display Menu | 48 |
| Top | 6 | Skip Back | 23 | Utility Menu | 50 |
| Right Side..... | 8 | Advanced Features | 24 | File List Menu..... | 56 |
| Left Side..... | 8 | Microphone(s) | 24 | Folder List Menu | 59 |
| Front..... | 9 | Pre Record..... | 25 | Troubleshooting | 62 |
| Back | 9 | Audio Filter..... | 25 | Error Message | 63 |
| Bottom..... | 10 | Silent Skip | 25 | Specifications | 64 |
| Display | 10 | Manual Track..... | 25 | Limited Warranty | 65 |
| Preparation Before Use | 11 | Auto Track..... | 26 | | |
| Installing the carry strap..... | 11 | Copy Segment | 26 | | |
| Installing batteries | 11 | File Divide | 27 | | |
| Removing batteries | 12 | Marking | 28 | | |
| Installing a memory card..... | 13 | Pitch Control..... | 28 | | |
| Removing a memory card..... | 13 | Additional Features | 29 | | |
| Clock Setting | 14 | Key Lock | 29 | | |
| Language | 15 | Remote..... | 30 | | |
| Basic Recording Operation | 16 | Extended Remote Jack..... | 31 | | |
| Connection Diagram | 16 | Display Control | 32 | | |
| Recording Procedure | 16 | USB Mode | 35 | | |
| Audio Input for Recording | 18 | Computer compatible | 35 | | |
| Recording Time Chart | 19 | How to connect via the USB port | 35 | | |
| Recording Level Control..... | 20 | Diagram of file structure | 36 | | |

Package Contents

- PMD661



- Audio cable



- USB cable

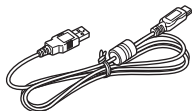

- AC adapter



- User guide

- CD-ROM

- Carry strap

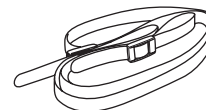

- Customer registration document (US only)

- SD card



Introduction

Thank you for selecting the Marantz Professional PMD661 Portable Solid State Recorder.

The PMD661 is an audio recorder that records in digital audio formats onto an SD (Secure Digital) card.

SD cards, also used in digital cameras, are widely available at consumer electronics retailers and computer resellers.

Features

- Stereo (2 channels) and mono (1 channel) audio recording and playback.
- Audio inputs maybe from :
 - the built-in microphone(s),
 - condenser or dynamic microphone(s) connected to the XLR stereo jacks, or
 - line level audio sources connected to the XLR jacks or LINE 2 jack.
- Audio outputs may be from :
 - the built-in speakers,
 - headphones connected to the PHONES jack, or
 - analog audio devices such as an amplifier or other devices connected to the LINE OUT jack.
- Records onto various types of SD cards.
- Computer compatible
The PMD661 records directly onto SD cards. Recordings can be transferred to your desktop or laptop computer by removing the SD card from the PMD661 or by connecting the PMD661 to your computer via the USB port. Audio recorded in the

popular MP3 compression format is directly available for intranet or internet file sharing.

- Easy one control recording
Simply push the **REC** button.
- Automatic recording
The PMD661 can be set to stop recording when there is silence (Silent Skip) and automatically start when sound resumes.
- Manual and automatic record level control (ALC).
- Two different recording formats :
 - Compressed recording using MP3 (MPEG1 Layer III) mono and stereo. MP3 compressed at 64/128/192/256/320 kbps.
 - Uncompressed recording using 16/24-bit linear Pulse Code Modulation (PCM).
- Copy Segment
Copy Segment works just like the copy and paste function of your standard word processing program. It allows you to “highlight” a section of a file by setting an in point and an out point, and then paste that section into a new file without destroying the original file(s).
- Timer Recording/Playback
Record start time and duration can be scheduled. Playback start time can be scheduled. (P.51)
- Data secured
The recorded audio data until the recording stops is kept even if the power is interrupted suddenly during recording.

Quick Start Guide

Follow the instructions on this page to Quick Start your new PMD661 Solid State Recorder and begin recording. The PMD661 comes with factory preset defaults for MP3 recording using internal microphones.

1. Unpack the AC adapter and the PMD661.
2. Setup the power supply.
 - Use either the provided AC adapter or batteries.
 - You can use 4 AA type batteries of Alkaline, or Nickel-Metal Hydride.

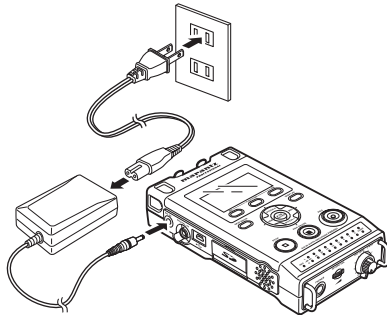

3. Slide and hold the **POWER** switch.



4. Press the **REC** button to start recording.

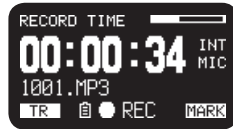
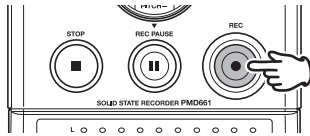

5. Press the **STOP** button to stop recording.

6. Press the **▶/||/ENTER** button to play the just recorded file via headphones or speaker.

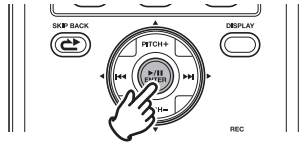

7. Press the **▶/||/ENTER** button again to pause playback.

8. Press the **STOP** button to stop playback.

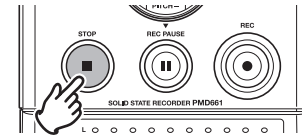

- For other recording condition, see P.41.
- For the clock setting, see P.14.

Names and Functions

Top

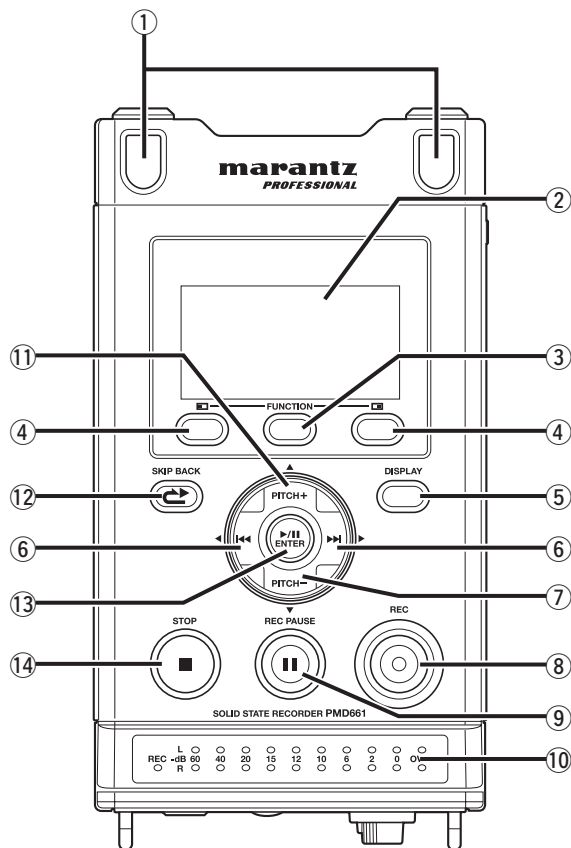

- ① **Internal Microphones**
Stereo condenser microphones.
- ② **DISPLAY**
The display shows the information of the PMD661. (☞ P.10)
- ③ **FUNCTION button**
Press the **FUNCTION** button to change the functions on **F1** and **F2** buttons with toggle operation. The functions are different depending on each operation mode.
- ④ **F1/F2 buttons**
The functions of the **F1** and **F2** buttons depend on each operation mode and the **FUNCTION** button. Function (F1/F2) is indicated on the bottom corner of the display. The functions change automatically when the status changes. The 2nd or 3rd function in the same status can be selected by pressing the **FUNCTION** button.

Functions of F1/F2 buttons

| Operation mode | F1 function | F2 function |
|-------------------------------|-------------------------|-------------------------|
| Stop | 1. MENU | 1. LIST (File List) |
| Record or Rec-Pause | 1. TR (Manual Track) | 1. MARK |
| | 2. UNDO (Record Undo) | 2. MARK |
| Stop after Record or Playback | 1. MENU | 1. LIST (File List) |
| | 2. MK- (Mark Search -) | 2. MK+ (Mark Search +) |
| Playback or Play-Pause | 1. COPY (Copy Segment) | 1. MARK |
| | 2. DIV (Divide) | 2. LIST (File List) |
| | 3. MK- (Mark Search -) | 3. MK+ (Mark Search +) |

⑤ **DISPLAY button**

Press the **DISPLAY** button to change the display contents like the time information with toggle operation. The content is different depending on each operation mode.

⑥ **◀◀ / ▶▶ button**

- While in Stop, Playback, or Play-Pause mode, press this button to choose the file (Jump to previous/next file).
- In Play-Pause mode, press and hold this for high speed Reverse/Forward searching without audio. (Search -/Search +)
- In Playback mode, press and hold this to "rewind"/"fast forward" and do a 2X speed search. (Audible Search -/Search +)

⑦ **PITCH- button**

Press this button to make a speed down of playback.
During menu mode, this button is used to change item.

⑧ **REC button**

Press this button to start recording from Stop or Rec-Pause mode.

⑨ **REC PAUSE button**

Press this button to enter the Rec-Pause mode from Stop or Record mode.

⑩ **Level LED (Green, Orange, Red)**

When a sound is input during Record, Rec-Pause or Playabck mode, it turns on.

⑪ **PITCH+ button**

Press this button to make a speed up of playback.
During menu mode, this button is used to change item.

⑫ **SKIP BACK button**

Press the **SKIP BACK** button to skip back during playback or Play-Pause.

⑬ **▶/II/ENTER button**

Toggles Playback and Play Pause.
During Menu mode, this is used to decide the choice.

⑭ **STOP button**

Press this button to stop the playback or recording and to release the Play-Pause or Rec-Pause mode.
During menu mode, press this button to exit menu mode without to store memory.

Right Side

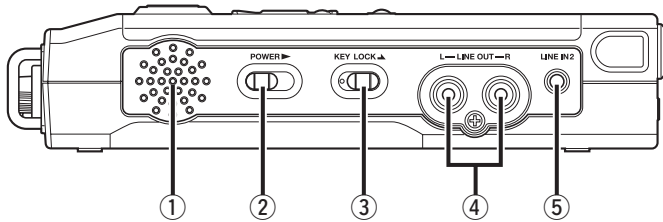

- 1 Speaker**
Internal speaker of R channel.
- 2 POWER slide switch**
Slide and hold for a little time to turn power On.
Slide to turn power Off. During Record and Rec-Pause mode, the **POWER** switch is invalid.
- 3 KEY LOCK slide switch**
Slide switch for the Key Lock On and Off control.
- 4 LINE OUT Jacks**
Insert an audio cable plug connected to an external audio device into these jacks to output audio signals to an external device (amp, etc.)
- 5 LINE IN 2 Jack**
Insert an audio cable plug connected to an external audio device into this jack to input the signals output from the external device into the recorder.

Left Side

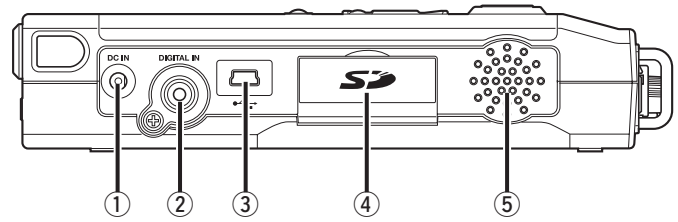

- 1 DC IN Jack**
Insert the provided AC adapter plug.
If the AC adapter plug is inserted while using the recorder on battery power, the recorder will automatically switch to adapter power. Also, if the AC adapter plug is removed, the recorder will automatically switch to battery power.
- 2 DIGITAL IN Jack**
Connect a digital audio cable with an RCA jack from an external device providing SPDIF digital output.
- 3 USB port (mini-B)**
The USB mode is started by connecting a USB cable while stopped.
- 4 Card compartment**
Pull the lid to access an SD card.
- 5 Speaker**
Internal speaker of L channel.

Front

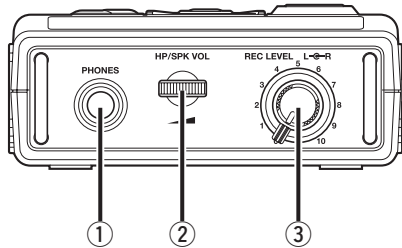

① PHONES Jack

For monitoring and private listening, you can connect your headphones to this jack.

② HP/SPK VOL Control

Use this to adjust the output level of the headphones or internal speakers.

Warning!

When using headphones, take care not to turn the volume too high. Listening at high volumes for extended periods of time may result in permanent hearing damage.

③ REC LEVEL Control

Turn to adjust the record level when the "Level Cont." of preset menu is "Manual".

The inside control (Right channel) and outside control (Left channel) turn together, unless you hold one while turning the other.

The optimum record level is when the level meter goes as close to 0dB as possible but does not go OVER.

Back

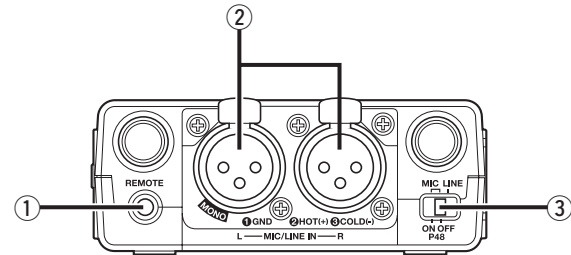

① REMOTE Control Jack

The Jack for the optional remote RC600PMD and the external remote controller.

② MIC/LINE IN Jacks

XLR stereo for MIC/LINE level.

③ PHANTOM/MIC slide switch

3 position slide switch. Phantom on, off or line. Phantom works to supply +48V to external microphones.

Bottom

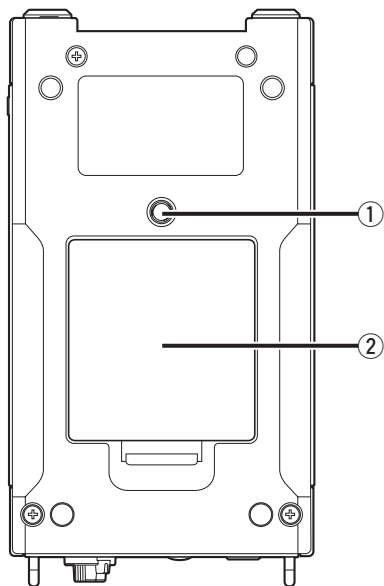

① Tripod Hole

Threaded screw hole for Tripod mount.

② Battery compartment

For 4 AA alkaline or rechargeable Ni-MH batteries.

Display

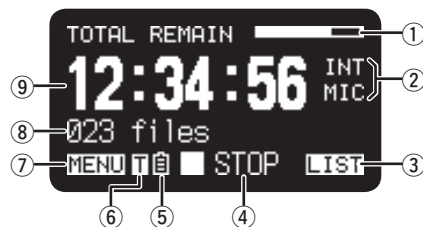

① Remaining space of the card

② Input source

③ F2 function

④ Status

⑤ Battery icon

⑥ Timer icon

This icon appears if the Timer Record/Playback is set. During the Timer Record/Playback, it blinks.

⑦ F1 function

⑧ Number of files

⑨ Total remain time

Preparation Before Use

Installing the carry strap

1. Put the carry strap through the shaft of the PMD661.

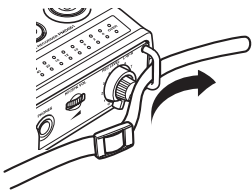

2. Put the carry strap through the stopper of the PMD661.

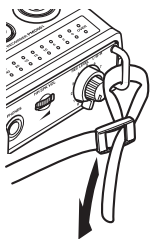

3. Secure the carry strap by putting it through the second stopper.



Installing batteries

1. Remove the battery compartment cover.

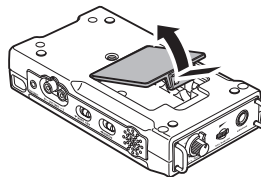

2. Insert the new batteries (AA type) with correct +/- polarity.

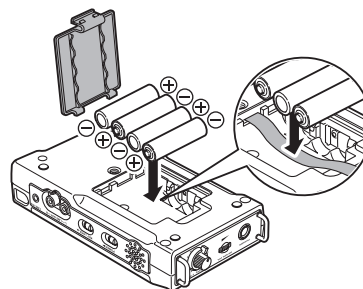

3. Close the battery compartment.

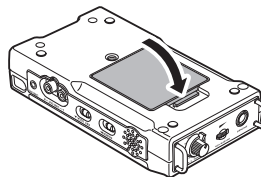

Removing batteries

Battery compartment is located in the bottom of the unit.

1. Remove the battery compartment door.
2. Remove four AA type batteries.
3. Close the battery compartment door.





Safety cautions on handling batteries

Always follow the points below when using batteries to avoid electrolyte leakage, overheating, fire, rupturing, ingestion, etc.

- Electrolyte leakage or corrosion may occur if batteries are kept inside the recorder for prolonged periods of time. If the recorder is not to be used for a prolonged period, remove the batteries to prevent electrolyte leakage.
- Make sure that the + and – markings on the batteries are aligned with the corresponding markings in the battery case and the battery holder.
- Do not insert old or exhausted batteries into the recorder.
- Do not mix the type of battery, and do not use both old and new batteries together.
- If the recorder does not operate correctly, replace the old batteries with new ones.
- If electrolyte has leaked, thoroughly wipe the inside of the battery holder, and then insert new batteries.

Battery remaining indicator

The recorder operates using commercially available AA size alkaline or Ni-MH batteries. During operation, the battery remaining indicator is as follows.

| Indicator | Meaning |
|-----------------------------------------------------------------------------------|--------------------------------------------------------------------------------------------------------------------------------------------------------------------------------------------------------------------------------------------------------------------------------------|
|  | There is still ample battery power remaining. |
|  | The amount of battery power remaining has decreased to approximately half. |
|  | Only a small amount of battery power remaining. |
|  | There is not enough battery power remaining to record or playback. Either replace the batteries with new ones, or recharge the rechargeable batteries. If you continue recording while this indicator is flashing, recording/playback will stop, and the recorder will shut down. |
|  | The AC adapter is being used. The adapter power supply is valid. |

Installing a memory card

The PMD661 records onto various types of SD cards.

1. Check that the power is turned off.
2. Pull the SD card lid.

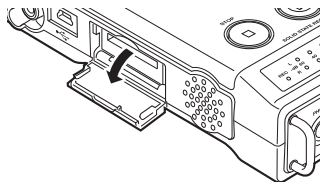

3. Fully insert the SD card.

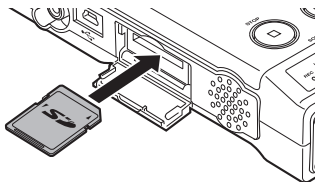

4. Close the SD card lid.

Removing a memory card

1. Check that the power is turned off.
2. Pull the SD card lid.
3. Push the card, then pull it to remove it.

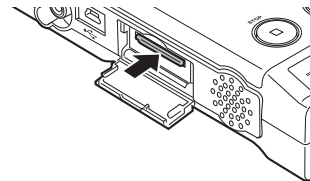

4. Close the SD card lid.

Note:

If the SD card lid opens while the power is on, “Door Open” message is displayed.

While recording is in progress, opening the SD card lid automatically stops recording and writes critical file information to properly close the file.

Clock Setting

The date and time are written on each audio track (file) when the track is started. When an audio track is viewed on a computer, this date and time appears as when the file was 'modified'.

1. From Stop, press the  (F1: MENU) button.

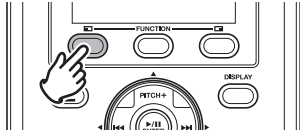

2. Press the **PITCH +** or **PITCH -** button to select "Time/Date".



3. Press the **▶/||/ENTER** button to enter the Time/Date setting.

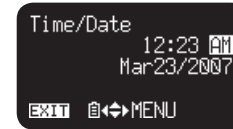

- Press the **STOP** button to cancel.
 - Press the **◀◀** or **▶▶** button to select the item.
 - When the hour is set, press the **◀◀** button to return to the Top Menu.
 - When the year is selected, the **▶▶** button is invalid.
 - Press the **PITCH +** or **PITCH -** button to select the value.
4. Press the  (F1: EXIT) button.
 - "Store?" appears on the display.
 - Select "Yes" and press the **▶/||/ENTER** button to write on the Real Time Clock.

Note:

If it happens to be the date which does not exist such as Feb. 31, it gets revised as back to Feb. 28.

Language

The Language menu item allows you to choose a display language (English, French, Spanish, German, Italian and Swedish).

1. From Stop, press the  (F1: MENU) button.

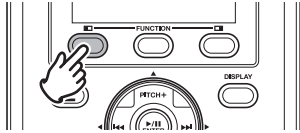



2. Press the **PITCH +** or **PITCH –** button to select “Language”.

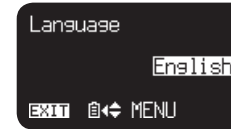

3. Press the /ENTER button to enter the Language setting.



- Press the **STOP** button to cancel.
 - Press the **PITCH +** or **PITCH –** button to select the item.
 - When “English” is selected, press the **PITCH +** button to select “Swedish”.
 - When “Swedish” is selected, press the **PITCH –** button to select “English”.
 - Press the  button to return to the Top Menu.
4. Press the  (F1: EXIT) button.
 - “Store?” appears on the display.
 - Select “Yes” and press the /ENTER button to store the change.

Basic Recording Operation

Connection Diagram

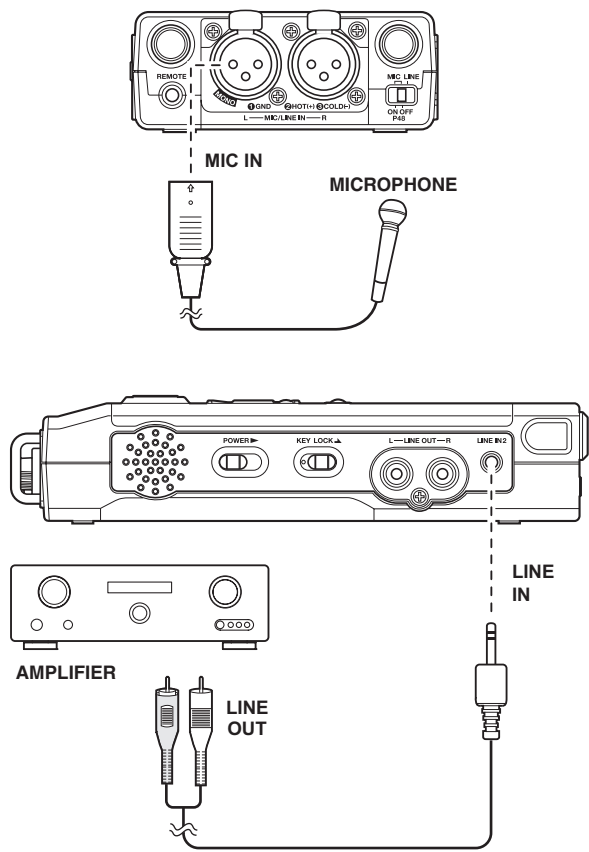

Recording Procedure

1. Slide and hold the **POWER** switch to turn on.



2. Press the **REC** button to begin recording.

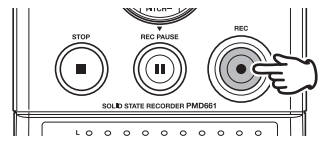

- The Rec indicator will be lit and steady while recording.
- The display will show the information display of recording.

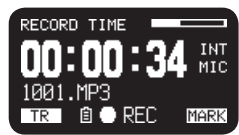

3. Press the **REC PAUSE** button to pause recording.
4. Press the **STOP** button to stop recording and end the file (close the audio file).

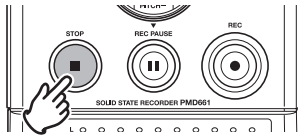

You can press the **▶/||/ENTER** button to play the just recorded file or press the **STOP** button again to enter the Stop mode. Then pressing the **▶/||/ENTER** button will play the beginning of the first audio file.

Audio Input for Recording

The audio input for recording can be set from the “Input” menu. (🔍 P.43)

Set the “Rec Channel” menu to “stereo” to create a stereo (2-channel) sound file. Or set it to “D.Mono” to create a stereo sound file. The left channel input is recorded in both left and right channels. Or set it to “mono” to create a monaural (1-channel) sound file. The monaural file will be almost half the size of the stereo file.

Set the PHANTOM/MIC switch to “ON” to select the microphone level sensitivity with phantom power 48 volts. Or set it to “OFF” to select the microphone level sensitivity without phantom power. Or set it to “LINE” to select the line level sensitivity.

| # | INPUT | Rec Channel | PHANTOM/MIC switch | Description |
|----|----------|-------------|-------------------------------------------------------------------------------------------------------------------------------------------------------|-----------------------------------------------------------------------------------------------------------------------------------------------------------------------------------------------------------------------------|
| 1 | INT MIC | Stereo | Invalid | Left/Right channel stereo recording. |
| 2 | | D.Mono | | Left/Left channel stereo recording. The Right channel is attenuated by 20dB. • The Left channel input is recorded in both Left and Right channels. |
| 3 | | Mono | | Left channel monaural recording. |
| 4 | MIC/LINE | Stereo | ON | Left/Right channel microphone level stereo recording. 48 volt phantom power is supplied for XLR inputs. |
| 5 | | | OFF | Left/Right channel microphone level stereo recording. |
| 6 | | | LINE | Left/Right channel line level stereo recording. |
| 7 | | D.Mono | ON | Left/Left channel microphone level stereo recording. • The Left channel input is recorded in both Left and Right channels. The Right channel is attenuated by 20dB. 48 volt phantom power is supplied for XLR inputs. |
| 8 | | | OFF | Left/Left channel microphone level stereo recording. • The Left channel input is recorded in both Left and Right channels. The Right channel is attenuated by 20dB. |
| 9 | | | LINE | Left/Left channel line level stereo recording. • The Left channel input is recorded in both Left and Right channels. The Right channel is attenuated by 20dB. |
| 10 | | Mono | ON | Left channel microphone level monaural recording. 48 volt phantom power is supplied for XLR inputs. |
| 11 | | | OFF | Left channel microphone level stereo recording. |
| 12 | | | LINE | Left channel line level monaural recording. |
| 13 | | LINE2 | Stereo | Invalid |
| 14 | D.Mono | | Left/Left channel stereo recording. The Right channel is attenuated by 20dB. • The Left channel input is recorded in both Left and Right channels. | |
| 15 | Mono | | Left channel monaural recording. | |
| 16 | D.IN | Stereo | Invalid | Left/Right channel stereo recording. |
| 17 | | D.Mono | | Left/Left channel stereo recording. • The Left channel input is recorded in both Left and Right channels. |
| 18 | | Mono | | Left channel monaural recording. |

Recording Time Chart

All times are approximated record times.

Different media manufacturers allow more or less space for error correction and the like on their respective products.

Recording Time

Stereo channel

| Settings | Bitrates | Recording Times (hours : minutes) | | | | |
|------------------|-----------|-----------------------------------|-------|-------|-------|--------|
| | | 256MB | 512MB | 1GB | 2GB | 4GB |
| PCM-16 (44.1KHz) | 1411 kbps | 0:24 | 0:48 | 1:36 | 3:12 | 6:24 |
| PCM-16 (48KHz) | 1536 kbps | 0:22 | 0:44 | 1:28 | 2:56 | 5:52 |
| PCM-16 (96kHz) | 3072 kbps | 0:11 | 0:22 | 0:44 | 1:28 | 2:56 |
| PCM-24 (44.1KHz) | 2117 kbps | 0:16 | 0:32 | 1:04 | 2:08 | 4:16 |
| PCM-24 (48KHz) | 2304 kbps | 0:14 | 0:28 | 0:56 | 1:52 | 3:44 |
| PCM-24 (96KHz) | 4608 kbps | 0:07 | 0:14 | 0:28 | 0:56 | 1:52 |
| MP3-320 | 320 kbps | 1:46 | 3:33 | 7:06 | 14:12 | 28:24 |
| MP3-256 | 256 kbps | 2:13 | 4:26 | 8:52 | 17:44 | 35:28 |
| MP3-192 | 192 kbps | 2:57 | 5:54 | 11:48 | 23:36 | 47:12 |
| MP3-128 | 128 kbps | 4:26 | 8:52 | 17:44 | 35:28 | 70:58 |
| MP3-64 | 64 kbps | 8:52 | 17:44 | 35:28 | 70:56 | 141:52 |

Monaural channel

| Settings | Bitrates | Recording Times (hours : minutes) | | | | |
|------------------|-----------|-----------------------------------|-------|-------|--------|--------|
| | | 256MB | 512MB | 1GB | 2GB | 4GB |
| PCM-16 (44.1KHz) | 705 kbps | 0:48 | 1:36 | 3:12 | 6:24 | 12:48 |
| PCM-16 (48KHz) | 768 kbps | 0:44 | 1:28 | 2:56 | 5:52 | 11:04 |
| PCM-16 (96kHz) | 1536 kbps | 0:22 | 0:44 | 1:28 | 2:56 | 5:52 |
| PCM-24 (44.1KHz) | 1058 kbps | 0:32 | 1:04 | 2:08 | 4:16 | 8:32 |
| PCM-24 (48KHz) | 1152 kbps | 0:28 | 0:56 | 1:52 | 3:44 | 7:28 |
| PCM-24 (96KHz) | 2304 kbps | 0:14 | 0:28 | 0:56 | 1:52 | 3:44 |
| MP3-320 | 160 kbps | 3:33 | 7:06 | 14:12 | 28:24 | 56:48 |
| MP3-256 | 128 kbps | 4:26 | 8:52 | 17:44 | 35:28 | 70:56 |
| MP3-192 | 96 kbps | 5:54 | 11:48 | 23:36 | 47:12 | 94:24 |
| MP3-128 | 64 kbps | 8:52 | 17:44 | 35:28 | 70:56 | 141:52 |
| MP3-64 | 32 kbps | 17:44 | 35:28 | 70:56 | 141:52 | 283:44 |

Recording Level Control

The recording level control lets you select the type of input level Control.

– At the Manual Level Control

When Manual is set in the Level Control setting, adjust the **REC LEVEL** Control on the front panel of the PMD661 to control the audio input level. The optimum record level is when the level meter goes as close to 0dB as possible but does not go OVER.

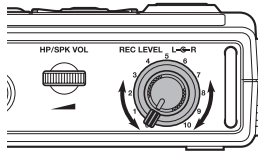

– At ALC (Automatic Level Control)

The PMD661 automatically responds to changes in input level. The **REC LEVEL** control does not work when the ALC is selected. Set the Level Control of the preset menu “ALC” (P.44).

Basic Playback Operation

Connection Diagram

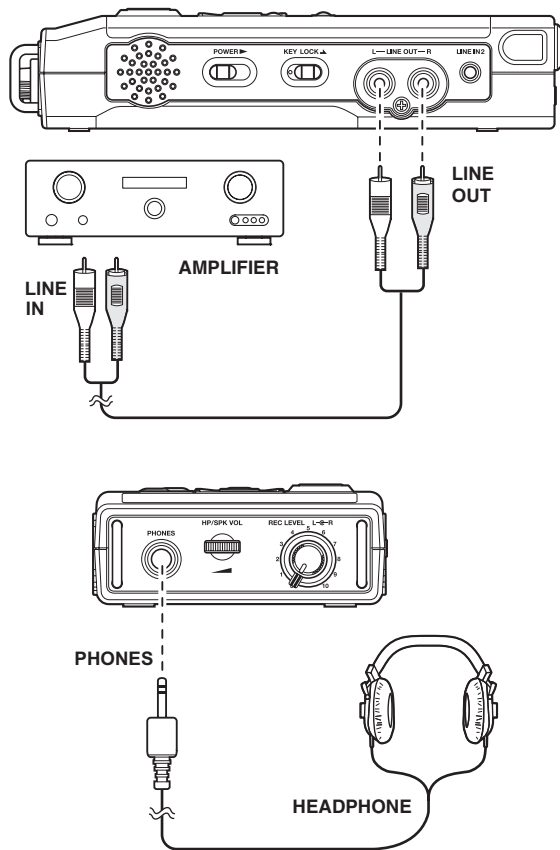

Playback Procedure

1. Slide and hold the **POWER** switch to turn on.
2. Press the **◀◀** or **▶▶** button to choose the file you wish to play.

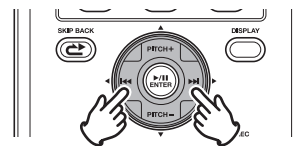

3. Press the **▶/||/ENTER** button to begin playback.

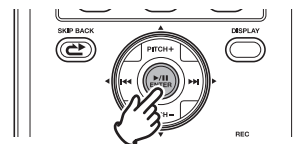

4. Press the **▶/||/ENTER** button again to pause playback.

5. Press the **STOP** button to stop playback.

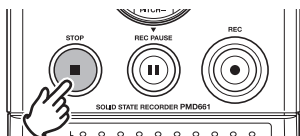

You can press the ►/||/ENTER button to play the just played file, or press the **STOP** button again to enter the Stop mode. Then pressing the ►/||/ENTER button will play the beginning of the first audio file.

Note:

The file sort order can be changed using the preset “File Sort”. (☞ P.49)
When set to Alphabet, files are sorted in order of symbol, number, and alphabet. When set to “Time/Date”, audio files are sorted into the order in which they were created.

Access from File List

There are two ways to select the file you want to play. Either use the ◀◀ or ▶▶ buttons during Stop mode, or select the files from the File List.

1. From Stop, press the  (**F2: LIST**) button.

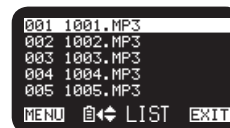

The file list appears on the display.

2. Press the **PITCH +** or **PITCH –** button to select the audio file. Then press the ►/||/ENTER button to enter the File list Menu.

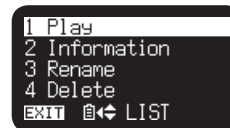

3. Press the **PITCH +** or **PITCH –** button to select “Play”. Then press the ►/||/ENTER button to begin playback.
- During playback, press the **STOP** button to return to the File list.

For accessing the files of other folder. (☞ P.59)

Search

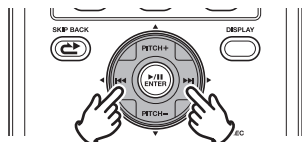

In Play-Pause mode, press and hold the **◀◀** or **▶▶** button for high speed searching without audio. 10X searching speed from 1 second to 4 seconds, and 140X speed over 4 seconds until release the button. When you release the button, the recorder returns to playback paused.

If the end of the file is passed with **▶▶** button still held down, search moves to the next file and continues searching in the forward direction.

If the tip of the file is passed with **◀◀** button still held down, search moves to the previous file and continues searching in the reverse direction.

During playback, press and hold the **◀◀** button to “rewind” and do a 2X speed audible search in the reverse direction. During playback, press and hold the **▶▶** button to “fast forward” and do a 2X speed audible search in the forward direction. Release to return to normal forward playback.

Skip Back

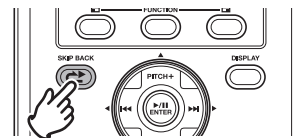

Press the **SKIP BACK** button during playback or pause to return the amount of time set in the preset Skip Back from the current playback or pause point. (🔊 P.45)

Advanced Features

Microphone(s)

– Attenuator

The microphone attenuation switch permits the direct use of microphones that differ in sensitivity.

- 0dB : No microphone attenuation.
- -6dB : Input from a microphone(s) connected to the MIC jack is cut by 6dB.
- -12dB : Input from a microphone(s) connected to the MIC jack is cut by 12dB.
- -18dB : Input from a microphone(s) connected to the MIC jack is cut by 18dB.

Setup the “Mic Atten.” of the preset menu. (🔧 P.45)

– Phantom Power

Slide the PHANTOM/MIC switch to on to provide +48V of power for a condenser microphone(s).

ON : +48V is supplied to power condenser microphone(s).

OFF : No microphone power is supplied.

Microphone recommendations

Professional condenser microphone(s) (which require additional power from either the PMD661's phantom power or from another source) are recommended because they provide greater sensitivity and higher quality audio recording.

Dynamic microphone(s) can be used, but they do not yield optimum audio quality recordings in some applications.

Consult with your local dealer to select the appropriate microphone(s) for your specific application. In many cases, they can demonstrate the various performances and characteristics of microphones for your use.

Pre Record

When PreRecord is on and the PMD661 is in record pause, it listens to the selected audio input(s) and continuously buffers 2 seconds of audio. Then, when record is started, the PMD661 writes the previously buffered 2 seconds of audio to the card and continues to record from there.

Setup the “PreRecord” of the preset menu. (🔍 P.44)

Audio Filter

Low Cut Filter

The bass region of the input audio is cut as the audio is recorded.

Set to On to reduce noise, such as the sound of the wind when recording outdoors.

Setup the “Low Cut” of the preset menu. (🔍 P.45)

High Cut Filter

The treble region of the input audio is cut as the audio is recorded.

Set to On to reduce high frequency noise from the ambient environment.

Setup the “High Cut” of the preset menu. (🔍 P.45)

Silent Skip

The Silent Skip automatically pauses recording when there is a period of silence and resumes recording when sound resumes.

“Silent Skip” menu setting permits:

- Adjusting the margin sound level that defines silence in Off, -60dB, -54dB, -38dB, -20dB.

Setup the “Silent Skip” of the preset menu. (🔍 P.45)

Manual Track

When the Manual Track (Manual Track incrementing) is on during recording, press the **FUNCTION** button until “TR” appears on the display, then press the  (**F1: TR**) button to increment the audio file. A new audio file is created at that point. The continuity of sound is not guaranteed and depends on the speed of a card or the audio file size.

Auto Track

With the Auto Track (Automatic Track incrementing) On, a new audio file is begun automatically at specified intervals of recording time. The Auto Track can be set to increment every 1, 5, 10, 15 or 30 minutes, or every 1, 2, 6, 8, 12 or 24 hours. The Auto Track makes finding a particular point in a recording easier. For example, if a new audio file begins every minute during playback, the Auto Track makes finding a particular passage easier because of the relationship between file numbers and time. During playback, you can select file number 3 to play approximately the 3rd minute of recording. To go directly to the beginning of the 10th minute, select file number 10, etc.

| # | Recording time minutes : seconds |
|----------|-------------------------------------|
| 001..... | 0:00 – 0:59 |
| 002..... | 1:00 – 1:59 |
| 003..... | 2:00 – 2:59 |

The continuity of sound is not guaranteed and depends on the speed of a card or the file size.

Setup the “Auto Track” of the preset menu. (P.44)

Note:

New audio file starts automatically when the recorded file size reaches 4GB.

Copy Segment

Copy Segment physically turns your “highlighted” section into a new and separate file, without destroying the original source file(s).

1. “COPY” is displayed during playback. Press the  (F1: COPY) button when the audio reaches your desired IN-point.

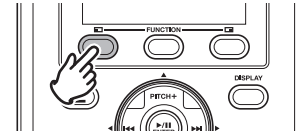

“Set as IN?” is displayed.

2. Press the /II/ENTER button to store the IN-point. “IN-” will flash on the display to indicate the IN-point has been stored and playback of the file resumes.

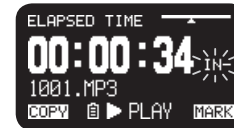
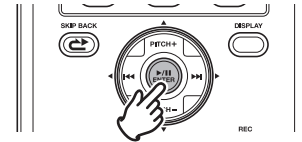

3. Continue to let the PMD661 play to your desired OUT-point, or use the standard transport controls like the ◀◀ or ▶▶ button to span greater time lengths.
4. When you have reached your desired OUT-point, press the **FUNCTION** (F1: COPY) button.

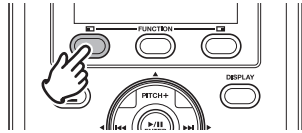

“Set as OUT?” is displayed.

5. Press the **▶/||/ENTER** button to store the OUT-point.
“Copy Segment?” is displayed.
6. Press the **▶/||/ENTER** button to start the Copy process.

“Executing...” will be shown on the display. When the copy procedure is completed, the display will show “Completed” for one second and then returns to stop mode with your new file as the current file.

Notes:

- When a copy area spans across two or more files, a file is connected and copied.
- When the copy area spans across files of different “Rec Format” or “Rec Channel” setting, it cannot be copied.
- The copy area cannot exceed 80 minutes.

File Divide

The File divide allows you to divide a file at the position you want to divide.

1. During playback, press the **FUNCTION** button until “DIV” appears on the display. Then press the **FUNCTION** (F1: DIV) button.
 - “Divide?” appears on the display.
 - Select “No” and press the **▶/||/ENTER** button to pause the playback.
2. Select “Yes” and press the **▶/||/ENTER** button to start Divide process.
“Executing...” will be shown on the display. When the divide process is completed, the display will show “Completed” for one second and the unit stops at the beginning of the second file of the divided files.

Notes:

- “_A” is added to the end of the file name of the first new file.
(For example; the original file=“aaa.mp3”, the first new file=“aaa_A.mp3”)
- “_B” is added to the end of the file name of the second new file.
- If the length of the file name with extension is already 63 or more, Divide process cannot be executed. “Long Title” message appears on the display and the playback is paused at the position you press the **▶/||/ENTER** button.

Marking

Marks can be added during recording or playback manually or automatically. The marking information is stored as an ID3 tag (Ver 2) in MP3 file or chunk in WAVE file. Marks help you find specific points in the recording.

- During playback, you can instantly locate marks.
- Up to 30 marks can be added to a file.
- Marks are numbered consecutively starting at one.
- During recording or playback, you can manually add a mark by pressing the **MARK** (F2: MARK) button.

Add a mark manually

During recording or playback, press the **FUNCTION** button until "MARK" appears on the display. Then press the **MARK** (F2: MARK) button to add a mark manually.

Add a mark automatically

The Auto Mark Menu item turns the automatic marking feature off or on. (P.44)

- If Auto Mark is on and the machine is in Rec - Pause, when recording is resumed a mark will be added.
- If Auto Mark is on and the PMD661 is recording audio below the sound threshold for more than three seconds, audio that crosses the threshold will cause a mark to be added.

The Auto Mark Menu setting permits:

- Turning Auto Mark on or off.
- Adjusting the margin sound level that defines silence in -60dB, -54dB, -38dB or -20dB.

Setup the "Auto Mark" of the preset menu. (P.44)

Search the marks

During play-pause or playback, press the **FUNCTION** button until "MK-" and "MK+" appear on the display. Then press the **MARK** (F1: MK-) or **MARK** (F2: MK+) button to select the mark you wish to access. The PMD661 is paused at the mark you selected.

To start playback, press the **PLAY/ENTER** button.

Pitch Control

The Pitch Control enables the playback speed (pitch) to be varied over a -40% to +20% ranges.



During playback, press the **PITCH +** button to increase the playback speed by 5%. The playback speed is increased up to +20%. Or press the **PITCH -** button to reduce the playback speed by 5%. The playback speed is reduced to -40%.

Additional Features

Key Lock

Slide the **KEY LOCK** switch to lock the keys.

The key lock secures the PMD661 in the state it is in during recording, playback or stop.

During Record and Rec-Pause mode, the **POWER** switch is always invalid.

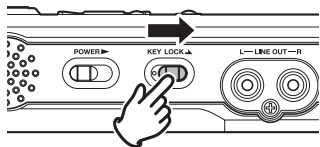

Notes:

- If “Key Lock” setting is “All”, only the optional remote controller RC600PMD is accepted.
- If “Key Lock” setting is “Partial”, the **REC**, **REC PAUSE** and **STOP** buttons on the panel, and RC600PMD are accepted.

Setup the “Key Lock” of the preset menu. (P.45)

- “Key Locked” is displayed for one second when the key is pressed during key lock.



Remote

The PMD661 allows you to use an optional remote controller RC600PMD. (sold separately). The RC600PMD is designed for microphone interviews. It attaches to your microphone.

The remote's five feet cord with a four contact mini plug, plugs into the PMD661. The RC600PMD does not require any menu changes for use.

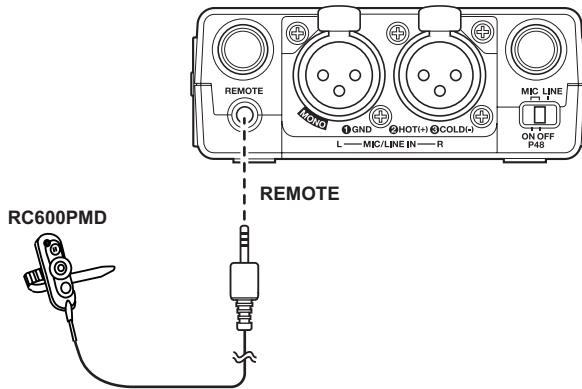

The RC600PMD includes:

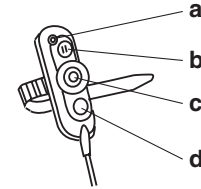

a An indicator light:

- (green) lit and steady during standby or stop
- (red) lit and steady while recording
- (flashing red) during Rec-Pause mode
- (orange) flashes for 1/2 second when an over peak level signal is input during Record or Rec-Pause mode, then it goes back to red.

b Press to pause recording

c Press to start/resume recording and to manually increment files

d Press to add a marking while Record or Playback.

Extended Remote Jack

The PLAY, FF and REW keys can be added to the remote control functions by using the equivalent circuit showing below.

Circuit diagram:

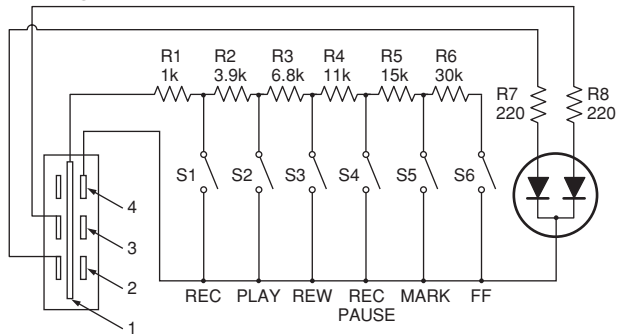

Notes:

- The PMD661 plays during closing and holding the PLAY switch, and skip back then pause at the point when it opened.
- Resistance error - Within 5%.
- Never apply external voltage. Doing so will result in malfunction.
- Insulate the circuit so that it cannot be touched directly. Use a structure that protects the circuit from static electricity, which will cause malfunction.
- Do not operate the switches at the same time as the buttons on the unit.
- D&M professional accepts no responsibility whatsoever for any damages or infringements of patents or other rights resulting from the use of the circuits.
- This does not sanction patents or other rights of D&M professional or third parties.
- It is strictly forbidden to reprint or reproduce the circuit diagrams in part or in whole.

Plug Type (1/8" T-R-R-S Mini Plug)

ø3.5/4P (TMP-B66)

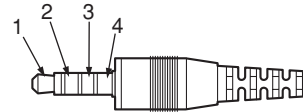

- 1: Tip
- 2: Ring
- 3: Ring
- 4: Sleeve

Display Control

Press the **DISPLAY** button to alternate information displays. Displays are slightly different in Stop, Record and Playback mode.

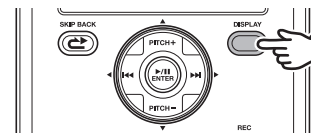

During Stop mode:

① Total Remain



② Current Time/Date



③ Record Setup



① Total Remain (Default display)

Remaining space of the card

Total remain time — 12:34:56

Input source — INT MIC

Number of files — 023 files

F1 function — MENU

F2 function — LIST

Current time — 01:23AM

Current date — Mar23/2007

Input source — INT MIC

F1 function — MENU

F2 function — LIST

REC SETUP (Preset-1)

Input source — INT MIC Stereo

Rec channel — Stereo

Rec format — MP3-192 192kbps

MP3 bitrate — 192kbps

Quantization — 16bit 44.1kHz

Sample rate — 44.1kHz

ALC icon — ALC AUTO TRK

F1 function — MENU

F2 function — LIST

During Record mode:

① Record Time



② Total Remain Time

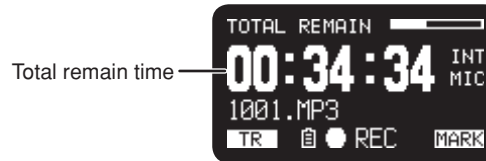

③ Record Level



④ Record Setup



① Record Time (Default display)

During Playback mode:

① Elapsed Time



② Remain Time

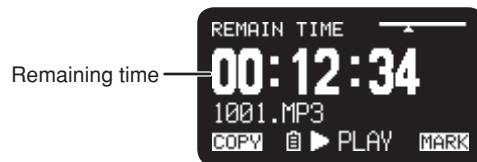

③ Output Level



④ File Properties

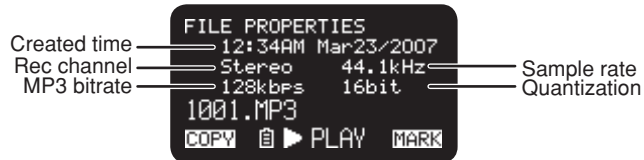

① Elapsed Time (Default display)

USB Mode

The PMD661 records directly onto SD cards.

Recordings can then be transferred to your desktop or laptop computer by removing the SD card from the PMD661, or by connecting the PMD661 to your computer via the USB port.

Audio recorded in the popular MP3 compression format is directly available for intranet or internet file sharing.

Computer compatible

On your computer you can then:

- log and archive audio files
- play audio files
- save audio files to your drive

How to connect via the USB port

The SD card in the PMD661 appears as an external drive on a connected computer.

1. Power up the computer.
2. Insert an SD card.
3. Power up the PMD661.
4. During Stop mode, connect the cable to the PMD661 and your computer.

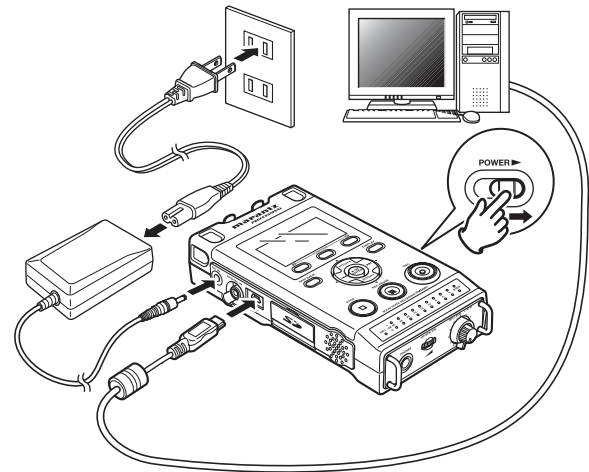

- While USB is on, a set screen is displayed.



- The SD card in the PMD661 appears as a removable device on your computer.

Notes:

- Check the operating system of your computer.
Windows Me, 2000, XP, Vista, MAC OS 10
- USB Bus Power activates this function even no service of AC adapter or batteries.
- No buttons other than the **POWER** switch function.

Caution:

- Do not remove the SD card during USB mode. The Data and the SD card may be damaged.
- During recording and playback, do not connect the cable to the PMD661 and your computer. The PMD661 may turn itself off or stop, by the USB Bus Power condition.

Diagram of file structure

A folder (directory) titled MPGLANG1 (Default) will appear on your computer. Files within the MPGLANG1 folder are numbered from aaaaa001 through the number of files recorded to a maximum of aaaaa999. (“aaaaa” depends on the Machine ID parameter.) The default setting of the Machine ID is “1”. The file extension will be .MP3 or .WAV depending on the “Rec Format” parameter that is set for the recording.

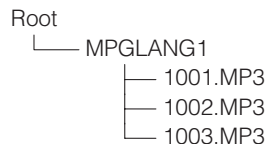

Changes made to file names or structures on your computer will prevent file recognition and playback in the PMD661.

Machine ID

An audio file created by the PMD661 has Machine ID information. The information is included in a file name. For example, if the Machine ID is “1”, the first file is numbered “1001.WAV” or “1001.MP3”. Setup the “Machine ID” of the preset menu. (P.47)

Menu

Menu Structure

| | | | | |
|-----------------|-----------------|----------------|-------------|-------------------|
| 1 Presets | | Preset-1 | 1 Select | |
| 2 Display..... | 01 Brightness | Preset-2 | 2 Edit..... | 01 Input |
| 3 Time/Date | 02 Timer | Preset-3 | 3 Rename | 02 Rec Format |
| 4 Utility..... | 1 Record Timer | | | 03 Rec Channel |
| 5 Language | 2 Play Timer1 | | | 04 Sample Rate |
| 6 F/W Version | 3 Play Timer2 | | | 05 PreRecord |
| | 4 Play Timer3 | | | 06 Level Cont. |
| | 5 Load Settings | | | 07 Auto Track |
| | 6 Save Settings | | | 08 Auto Mark |
| | 7 Card Format | | | 09 Silent Skip |
| | | | | 10 Mic Atten. |
| | | | | 11 Low Cut |
| | | | | 12 High Cut |
| | | | | 13 Skip Back |
| | | | | 14 Key Lock |
| | | | | 15 Battery |
| | | | | 16 Auto Power Off |
| | | | | 17 Beep |
| | | | | 18 SP Mute |
| | | | | 19 Play Mode |
| | | | | 20 Machine ID |
| | | | | 21 Preset Default |

Top Menu

1. From Stop, press the  (F1: MENU) button.



- The menu list appears on the display.
 - The selected item is highlighted.
 - When the first item is selected, press the **PITCH +** button to jump to the last item.
 - When the last item is selected, press the **PITCH –** button to jump to the first item.
2. Press the **PITCH +** or **PITCH –** button to select the item.

3. Press the **▶/II/ENTER** button to confirm or execute the selected item.

Items and functions

| # | Display | Description |
|---|-------------|-------------------------------|
| 1 | Presets | Go to the Preset Menu. |
| 2 | Display | Go to the Display Menu. |
| 3 | Time/Date | Adjust the date and time. |
| 4 | Utility | Go to the Utility Menu. |
| 5 | Language | Choose the display language. |
| 6 | F/W Version | Display the software version. |

Preset Menu

You can store 3 detailed presets on the recorder for such settings as recording input, recording format, playback mode, etc. There are 20 setting items in the preset menu, and 3 presets can be set with the desired conditions.

“Preset Select” allows you to select a preset number.

1. From Stop, press the  (F1: MENU) button.
2. Press the **PITCH +** or **PITCH –** button to select “Presets”. Then press the **▶/||/ENTER** button.

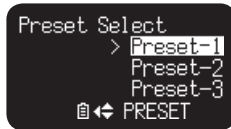

3. Press the **PITCH +** or **PITCH –** button to select Preset 1, 2, 3 or renamed Preset.

4. Press the **▶/||/ENTER** button to accept the selected Preset.

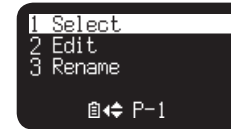

- Action Menu appears on the display.
- Select “Select” item and press the **▶/||/ENTER** button to store the settings of the selected preset.
- Select “Edit” item and press the **▶/||/ENTER** button to set or change the selected preset.
- Select “Rename” item and press the **▶/||/ENTER** button to change the name of the selected preset.

Action Menu Functions

| # | Display | Description |
|---|---------|--------------------------------------------|
| 1 | Select | Store the settings of the selected preset. |
| 2 | Edit | Set or change the selected preset. |
| 3 | Rename | Change the title of the selected preset. |

Preset Rename

1. From Stop, press the  (F1: MENU) button.
2. Press the **PITCH +** or **PITCH –** button to select Preset Menu. Then press the **►/II/ENTER** button to accept.
3. Press the **PITCH +** or **PITCH –** button to select Preset 1, 2, 3 or renamed Preset.
Then press the **►/II/ENTER** button to accept the selected Preset.
4. Press the **PITCH +** or **PITCH –** button to select “Rename” and press the **►/II/ENTER** button to accept.

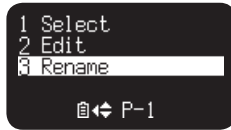

5. Rename the preset title.
Text can be changed and deleted. Press the **◀◀** or **▶▶** button to move the cursor to the place you wish to change text or delete text from.

To change the letter

Press the **PITCH +** or **PITCH –** button to select the character you want to change.

To insert a letter

Press the  (F1: INS) button. A character is inserted into the left of the highlighted character and then it will be highlighted.

To delete the letter

Press the  (F2: DEL) button to delete the selected character.

6. Press the **►/II/ENTER** button to store the changes.
Press the **◀◀** button to go back the previous page without store the changes when the first letter of the preset title is highlighted.

Notes:

- If the last letter of the preset title is Space(SP) character, the changed title does not include the last letter.
- The maximum length of a preset title is limited to 8 letters. When the 9th letter is inserted the last letter is deleted.
- The characters which you can insert are A B C D E F G H I J K L M N O P Q R S T U V W X Y Z a b c d e f g h i j k l m n o p q r s t u v w x y z (Space) ! “ # \$ % & ’ () + , - . ; = @ [] ^ _ ` { } ~ 0 1 2 3 4 5 6 7 8 9.

Preset Menu List

| # | Display | Selectable Value |
|----|----------------|------------------------------------------------------------------------------------------------------------------------------------------------------------------------------------------------------------------------------------------------|
| 1 | Input | INT MIC / MIC/LINE / LINE2 / D.IN |
| 2 | Rec Format | MP3-320 / MP3-256 / MP3-192 / MP3-128 / MP3-64 / PCM-16 / PCM-24 |
| 3 | Rec Channel | Stereo / Mono / D.Mono |
| 4 | Sample Rate | 44.1k / 48k / 96k |
| 5 | PreRecord | On / Off |
| 6 | Level Cont. | Manual / ALC |
| 7 | Auto Track | Off / 1min / 5min / 10min / 15min / 30min / 1hour / 2hour / 6hour / 8hour / 12hour / 24hour |
| 8 | Auto Mark | Off / -60dB / -54dB / -38dB / -20dB |
| 9 | Silent Skip | Off / -60dB / -54dB / -38dB / -20dB |
| 10 | Mic Atten. | 0dB / -6dB / -12dB / -18dB |
| 11 | Low Cut | On / Off |
| 12 | High Cut | On / Off |
| 13 | Skip Back | 0.5sec / 1sec / 1.5sec / 2sec / 2.5sec / 3sec / 3.5sec / 4sec / 4.5sec / 5sec / 5.5sec / 6sec / 6.5sec / 7sec / 7.5sec / 8sec / 8.5sec / 9sec / 9.5sec / 10sec / 15sec / 20sec / 25sec / 30sec / 35sec / 40sec / 45sec / 50sec / 55sec / 60sec |
| 14 | Key Lock | All / Partial |
| 15 | Battery | Alkaline / Ni-MH |
| 16 | Auto Power Off | Off / 5m / 15m / 30m / 60m |
| 17 | Beep | On / Off |
| 18 | SP Mute | On / Off |
| 19 | Play Mode | Single / Cont. |
| 20 | MachineID | Max 8 letters |
| 21 | Preset Default | |

Default Value List

| # | Display | Preset-1 | Preset-2 | Preset-3 |
|----|----------------|--------------------|------------------|------------------------------|
| 1 | Input | INT MIC | INT MIC | INT MIC |
| 2 | Rec Format | MP3-128 | MP3-320 | PCM-24 |
| 3 | Rec Channel | Stereo | Stereo | Stereo |
| 4 | Sample Rate | 44.1k | 44.1k | 96k |
| 5 | PreRecord | On | Off | Off |
| 6 | Level Cont. | ALC | Manual | Manual |
| 7 | Auto Track | Off | Off | Off |
| 8 | Auto Mark | Off | Off | Off |
| 9 | Silent Skip | Off | Off | Off |
| 10 | Mic Atten. | 0dB | 0dB | 0dB |
| 11 | Low Cut | On | Off | Off |
| 12 | High Cut | On | Off | Off |
| 13 | Skip Back | 3sec | 3sec | 3sec |
| 14 | Key Lock | All | All | All |
| 15 | Battery | Alkaline | Alkaline | Alkaline |
| 16 | Auto Power Off | 15m | 15m | 15m |
| 17 | Beep | On | On | On |
| 18 | SP Mute | Off | Off | Off |
| 19 | Play Mode | Cont. | Cont. | Cont. |
| 20 | MachineID | 1 | 1 | 1 |
| 21 | Preset Default | Meeting Compressed | Music Compressed | Highest Quality Uncompressed |

General Procedure in the edit mode

1. In the Preset Action Menu, press the **PITCH+** or **PITCH-** button to select “Edit” then press the **►/II/ENTER** button.
 - Action Menu list appears on the display.
2. Press the **PITCH+** or **PITCH-** button to select the menu item. Then press the **◀◀** or **▶▶** button to select the input choices.
3. When changing the preset is completed, press the **◻ (F1: EXIT)** button.
 - “Store?” appears on the display.
4. Select “Yes” and press the **►/II/ENTER** button to store the changes or select “No” and press the **►/II/ENTER** button to exit Menu Mode without storing any changes.

1) Input

Use this menu to select the audio input for recording.

| Set Value | Description |
|-----------|----------------------------------------|
| INT MIC | Internal stereo microphones |
| MIC/LINE | External microphone(s) (MIC/LINE Jack) |
| LINE2 | Line Level Input (LINE 2 Jack) |
| D.IN | Digital Input |

2) Rec Format

The “Rec Format” allows you to select the record audio format MP3 compression or high-fidelity PCM, the bitrate of the MP3 (320, 256, 192, 128 or 64 kbps) and the quantization of the PCM (16-bits or 24-bits).

| Set Value | Description |
|------------------------------------------------|--------------------------------------------------------------------------------|
| MP3-320 / MP3-256 / MP3-192 / MP3-128 / MP3-64 | (MP3) Mono : 160, 128, 96, 64, 32kbps Stereo: 320, 256, 192, 128, 64kbps |
| PCM-16 / PCM-24 | (PCM) Quantization: 16bits, 24bits |

3) Rec Channel

The “Rec channel” allows you to select the record channel(s) from stereo 2-channel or monaural 1-channel or stereo 2-channel with dual mono.

| Set Value | Description |
|-----------|-----------------------------------------------------------------------------------|
| Stereo | Stereo 2-channel audio file |
| Mono | Monaural audio file |
| D.Mono | Stereo 2-channel audio file. The left channel input is recorded in both channels. |

4) Sample Rate

The "Sample Rate" allows you to select the sampling frequency of the recording.

| Set Value | Description |
|-----------|------------------------------------------|
| 44.1k | Sampling frequency for both PCM and MP3. |
| 48k | Sampling frequency for both PCM and MP3. |
| 96k | Sampling frequency for PCM. |

5) PreRecord

The "PreRecord" allows you to turn on or off the pre record function.

| Set Value | Description |
|-----------|------------------------|
| On | Set the PreRecord on. |
| Off | Set the PreRecord off. |

6) Level Cont. (Level Control)

The "Level Cont." allows you to select the type of recording level control, Manual or ALC.

| Set Value | Description |
|-----------|-------------------------|
| Manual | Manual Level Control |
| ALC | Automatic Level Control |

7) Auto Track

The "Auto Track" allows you to set the Auto Track function off or on and select a time interval to create a new track automatically.

| Set Value | Description |
|---------------------------------------------------------------------------------------|----------------------------------------------------------------------------|
| Off | Set the Auto Track function off. |
| 1min / 5min / 10min / 15min / 30min / 1hour / 2hour / 6hour / 8hour / 12hour / 24hour | Set the Auto Track function on and the time interval to create a new file. |

8) Auto Mark

The "Auto Mark" menu item allows you to turn the auto mark function on and set the silent level or turn the auto mark feature Off. The Mark is automatically added after the end of the silent period of which the input level is below the preset value -60, -54, -38 or -20 (dB) for more than 3 seconds.

| Set Value | Description |
|-------------------------------|-------------------------|
| Off | Auto mark function off. |
| -60dB / -54dB / -38dB / -20dB | Silent level |

9) Silent Skip

The “Silent Skip” menu item allows you to turn the silent skip feature on and set the silent level or turn the silent skip feature Off. While the silent skip feature is on, the record is automatically paused when the input level is below the preset value -60, -54, -38 or -20 (dB) for more than 3 seconds.

| Set Value | Description |
|-------------------------------|-------------------------------------------------------------|
| Off | Set the Silent Skip feature off. |
| -60dB / -54dB / -38dB / -20dB | Set the Silent Skip feature on and select the silent level. |

10) Mic Atten. (Mic Attenuator)

The “Mic Atten.” menu item allows you to select the level of the Microphone Attenuator.

| Set Value | Description |
|----------------------|-------------------------------------|
| 0dB | Set the Mic Attenuator feature off. |
| -6dB / -12dB / -18dB | Set the Mic Attenuator. |

11) Low Cut

The “Low Cut” menu item turns the low cut feature Off or On.

| Set Value | Description |
|-----------|---------------------|
| Off | Low cut filter off. |
| On | Low cut filter on. |

12) High Cut

The “High Cut” menu item turns the high cut feature Off or On.

| Set Value | Description |
|-----------|----------------------|
| Off | High cut filter off. |
| On | High cut filter on. |

13) Skip Back

The “Skip Back” menu item allows you to select the skip back time from 0.5 second to 60 seconds.

| Set Value |
|------------------------------------------------------------------------------------------------------------------------------------------------------------------------------------------------------------------------------------------------|
| 0.5sec / 1sec / 1.5sec / 2sec / 2.5sec / 3sec / 3.5sec / 4sec / 4.5sec / 5sec / 5.5sec / 6sec / 6.5sec / 7sec / 7.5sec / 8sec / 8.5sec / 9sec / 9.5sec / 10sec / 15sec / 20sec / 25sec / 30sec / 35sec / 40sec / 45sec / 50sec / 55sec / 60sec |

14) Key Lock

The key lock secures the PMD661 in the state it is in during Record, Playback or Stop.

| Set Value | Description |
|-----------|-------------------------------------------------------------------------------------------------------------|
| All | All buttons are invalid. |
| Partial | All buttons are invalid. But the REC , REC PAUSE and STOP/CANCEL buttons are accepted. |

15) Battery

The "Battery" menu item allows you to set the battery type. The PMD661 operates on 4 standard AA sizes Alkaline or Ni-MH batteries. The Battery setting is used for the battery remaining indicator in the display and "Low Battery" warning. If the setting does not match installed batteries the PMD661 will not show the appropriate battery status.

| Set Value | Description |
|-----------|-------------------------------------------------------|
| Alkaline | Set the battery type to Alkaline battery. |
| Ni-MH | Set the battery type to Nickel-Metal Hydride battery. |

16) Auto Power Off

If the PMD661 is not operated for a long period of time during Stop or Play-Pause mode, the power can be automatically shut off to conserve battery life.

| Set Value | Description |
|----------------------|----------------------------------------------------------------------------------------|
| Off | Set the auto power off feature off. |
| 5m / 15m / 30m / 60m | Set the feature on and select the time until the PMD661 turns power off automatically. |

17) Beep

The "Beep" menu item allows you to turn the Beep alarm feature On or Off. While the feature is on, the unit beeps when the battery power becomes low (low battery) or recording space is not remained in the SD card.

| Set Value | Description |
|-----------|---------------------------|
| On | Set the Beep feature on. |
| Off | Set the Beep feature off. |

18) SP Mute

The "SP Mute" allows you to select speaker mute function On or Off. When "SP Mute" is set to On, the sound being recorded is not output from the speaker. When set to Off, the sound is output from the speaker except when the sound is being recorded by the built-in microphone.

| Set Value | Description |
|-----------|-------------------|
| On | Speaker Mute On. |
| Off | Speaker Mute Off. |

19) Play Mode

The “Play Mode” menu item allows you to select the single playback mode or continuous playback mode.

| Set Value | Description |
|-----------|--------------------------|
| Single | Single playback mode |
| Cont. | Continuous playback mode |

20) Machine ID

An audio file created by the PMD661 has Machine ID information. The information is included in the file name.

For example, if the Machine ID is “aaaaa”, the first file is numbered “aaaaa001.wav” or “aaaaa001.mp3”.

The Machine ID setting applies to all three presets.

1. In the preset edit mode, press the **PITCH +** or **PITCH –** button to select the “MachineID” item. Then press the **▶/||/ENTER** button to rename.
2. Rename the Machine ID.
Refer to the procedure of the “Preset Rename” (🔍 P. 40).
3. Press the **▶/||/ENTER** button to return to the preset select menu then press the **🔍 (F1: EXIT)** button to store the changes.

Notes:

- If Last letter of the Machine ID is Space(SP) character, the changed ID does not include the last letter.
- If number of letter is more than 8, last letter is deleted when a new letter is added.

21) Preset Default

The “Preset Default” allows you to return the settings of the selected preset to default.

🔍 Page 42 for a table of menu defaults.

1. In the preset edit mode, press the **PITCH +** or **PITCH –** button to select the “Preset Default” item. Then press the **▶/||/ENTER** button to initialize.
2. While “Default?” message is displayed, select “Yes” and then press the **▶/||/ENTER** button. Preset value returns to the default and the PMD661 starts writing on non-volatile memory.

Display Menu

You can store presets on the display menu for such settings as Brightness, Timer, LED, Time form, Date form and File sort.

1. From Stop, press the **⏏ (F1: MENU)** button.
 - Menu list appears on the display.
 - The selected item is highlighted.
 - When the first item is selected, press the **PITCH +** button to jump to the last item.
 - When the last item is selected, press the **PITCH –** button to jump to the first item.
2. Press the **PITCH +** or **PITCH –** button to select “Display”.



3. Press the **▶/||/ENTER** button.
 - The number of a selected item blinks.
 - The choice of the selected item is highlighted.
 - During display menu mode, press the **STOP** button to return to the stop mode.

4. Press the **PITCH +** or **PITCH –** button to select an item. Then press the **◀◀** or **▶▶** button to tab through the choices.
5. Press the **PITCH +** or **PITCH –** button to select other menu choices. When changing the display menu is complete, press the **⏏ (F1: EXIT)** button to store the changes, or press the **STOP** button to exit menu mode without storing any changes.
6. While “Store?” is displayed, select “Yes” and press the **▶/||/ENTER** button to store the changes or select “No” and press the **▶/||/ENTER** button to return to top menu without storing any changes.

Display Menu Functions

| # | Display | Selection items | Default |
|---|------------|-----------------------|-----------|
| 1 | Brightness | 1 to 8 | 5 |
| 2 | Timer | Off/30sec/60sec/90sec | Off |
| 3 | LED | On/Off | On |
| 4 | Time Form | 12H/24H | 12H |
| 5 | Date Form | M/D/Y, D/M/Y | M/D/Y |
| 6 | File Sort | Alphabet, Time/Date | Time/Date |
| 7 | Default | -- | -- |

* Factory default of “Date Form” setting for Europe is “D/M/Y”.

1) Brightness

The "Brightness" menu choice allows you to adjust the brightness of the OLED (Organic Light-Emitting Diode) display on the PMD661.

| Set Value | Description |
|------------------------|-----------------------|
| 1, 2, 3, 4, 5, 6, 7, 8 | (Dark) 1 – 8 (Bright) |

2) Timer

The "Timer" menu item allows you to set the timer function off or on with preset time. While the Timer is on, the part of display items will be turned off automatically when no button is pressed for preset time (30, 60 or 90 seconds). The battery life will be extended if it is on.

| Set Value | Description |
|-------------------|----------------------------|
| Off | Set the Timer Off. |
| 30sec/60sec/90sec | Set the Timer On and time. |

3) LED

The "LED" menu choice allows you to turn on or off the light of all LEDs.

| Set Value | Description |
|-----------|-------------------|
| On | Turn the LED On. |
| Off | Turn the LED Off. |

4) Time Form

The "Time Form" item allows you to select the format of the current time, 12-hour format with AM/PM (12H) or 24-hour format (24H).

| Set Value | Description |
|-----------|------------------------------------|
| 12H | 12-hour format (12:00AM – 11:59PM) |
| 24H | 24-hour format (00:00 – 23:59) |

5) Date Form

The "Date Form" item allows you to set the date order month/day/year (M/D/Y) or day/month/year (D/M/Y).

| Set Value | Description |
|-----------|------------------|
| M/D/Y | Month /Day /Year |
| D/M/Y | Day /Month /Year |

6) File Sort

The "File Sort" menu choice allows you to select the file order in the list by name (Alphabet) or time (Time/Date).

| Set Value | Description |
|-----------|-------------|
| Alphabet | |
| Time/Date | |

7) Default

The “Default” menu item allows you to return the settings of the Display Menu to the default.

See the table of Display Menu Functions.

1. From Stop, press the  (**F1: MENU**) button.
2. Press the **PITCH +** or **PITCH –** button to select Display Menu. Then press the **▶/||/ENTER** button to accept.
3. Press the **PITCH +** or **PITCH –** button to select the Default item. Then press the **▶/||/ENTER** button to initialize.
4. While “Default?” message is displayed, select “Yes” and then press the **▶/||/ENTER** button, then preset value returns to the default and to start writing on non-volatile memory.

Utility Menu

The “Utility” menu lets you set the time of recording or playback, load settings, save settings and format an SD Card.

1. From Stop, press the  (**F1: MENU**) button.
2. Press the **PITCH +** or **PITCH –** button to select “Utility”.



3. Press the **▶/||/ENTER** button.
 - During Utility menu mode, press the **STOP** button to return to the stop mode.
4. Press the **PITCH +** or **PITCH –** button to select the menu item. Press the **▶/||/ENTER** button to enter the menu item.

Utility Functions

| # | Display | Description |
|---|---------------|--------------------------------------------------|
| 1 | Record Timer | Set a start time and the duration for recording. |
| 2 | Play Timer 1 | Set a start time of playback 1. |
| 3 | Play Timer 2 | Set a start time of playback 2. |
| 4 | Play Timer 3 | Set a start time of playback 3. |
| 5 | Load Settings | Load setting data from an SD card |
| 6 | Save Settings | Save setting data to an SD card |
| 7 | Card Format | Delete all files. |

1) Record Timer

The Record Timer menu allows you to set or change a recording start time and the duration.

1. Select the Record Timer menu.

- When in stop, press the  (**F1: MENU**) button.
- Press the **PITCH +** or **PITCH -** button until “Utility” appears, then press the **▶/||/ENTER** button.
- Press the **PITCH +** or **PITCH -** button until “Record Timer” appears, then press the **▶/||/ENTER** button.

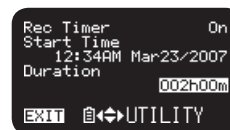

2. Set the Record Timer On or Off.

- Press the **PITCH +** or **PITCH -** button until “On” or “Off” is highlighted. Then press the **◀◀** or **▶▶** button until “On” is highlighted to turn on the Record Timer function. Press the **◀◀** or **▶▶** button until “Off” is highlighted to turn off the Record Timer function.
- Press the **PITCH +** or **PITCH -** button to move to the other item. The selected item is highlighted.

3. Set the start time.

- While the “Start Time” is highlighted, press the ►/||/ENTER button.
- Press the ◀◀ or ▶▶ button to select the item.
- Press the **PITCH +** or **PITCH –** button to select the value.
- Press the **ENTER** button to finish setting the time.

4. Set the duration.

- While the “Duration” is highlighted, press the ►/||/ENTER button.
- Press the ◀◀ or ▶▶ button to select the hour or minute.
- While the hour is highlighted press the **PITCH +** or **PITCH –** button to select the hour from 000 to 999.
- While the minute is highlighted press the **PITCH +** or **PITCH –** button to select the minute from 00 to 59.

5. Store the changes.

- During setting, press the **EXIT** (F1: EXIT) button. “Store?” appears on the display. Select “Yes” to store the setting and return to Utility menu. Or select “No” to return to the Utility menu without storing any changes.
- During setting, press the **STOP** button to return to the stop mode without storing any changes.
- While the timer is set, “T” icon appears on the display.



“T” icon

2/3/4) Play Timer (1/2/3)

The “Play Timer” menu allows you to set or change a start time for playback and the filename of the playback file.

1. Select the Play Timer menu.

- When in stop, press the **EXIT** (F1: MENU) button.
- Press the **PITCH +** or **PITCH –** button until “Utility” appears, then press the ►/||/ENTER button.
- Press the **PITCH +** or **PITCH –** button until “Play Timer 1 (or 2 or 3)” appears and then press the ►/||/ENTER button.

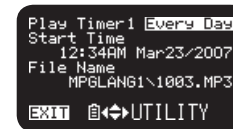

2. Set the Play Timer.

- Press the **PITCH +** or **PITCH –** button until “Everyday”, “Weekday” or “Weekend” is highlighted.
- Press the ◀◀ or ▶▶ button until “Weekday” is highlighted to set the playback from Monday to Friday.
- Press the ◀◀ or ▶▶ button until “Weekend” is highlighted to set the playback on Saturday and Sunday.
- Press the **PITCH +** or **PITCH –** button to move to the other item. The selected item is highlighted.

3. Set the start time.

- While the “Start Time” is highlighted, press the ►/II/ENTER button.
- Press the ◀◀ or ▶▶ button to select AM/PM, hour or minute.
- Press the ◀◀ or ▶▶ button to select the item.
- Press the **PITCH +** or **PITCH –** button to select the value.
- Press the **ENTER** button to finish setting the time.

4. Select the file.

- While the “File Name” is highlighted, press the ►/II/ENTER button.



- The file list appears on the display.
- Press the **PITCH +** or **PITCH –** button to select the file you wish to play. Then press the ►/II/ENTER button.

5. Store the changes.

- During setting, press the  (**F1: EXIT**) button. “Store?” appears on the display. Select “Yes” to store the setting and return to Utility menu. Or select “No” to return to the Utility menu without storing any changes.
- During setting, press the **STOP** button to return to the stop mode without storing any changes.

5) Load Settings

The “Load Settings” menu allows you to load all of the preset value from an SD card in the PMD661.

When performing load settings, use an SD card in which the preset contents from Save Settings are stored.

This function is particularly useful when setting multiple PMD661s with the same settings.

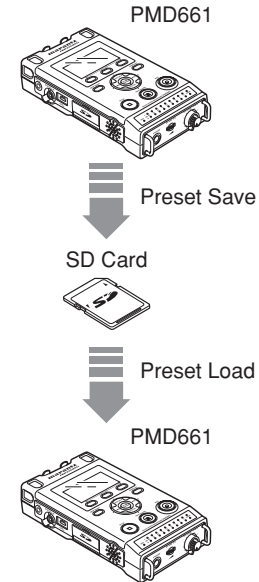

1. From Stop, press the  (**F1: MENU**) button.
2. Press the **PITCH +** or **PITCH –** button to select “Utility”.
Then press the **▶/||/ENTER** button to accept.
3. Press the **PITCH +** or **PITCH –** button to select “Load Settings”.
4. Press the **▶/||/ENTER** button. “Load?” message is displayed.
 - Press the **STOP** button to cancel loading items and return to the stop mode.
5. While “Load?” message is displayed, select “Yes” and press the **▶/||/ENTER** button to load the setting value in text format from the file in a route folder on card. The title of the file load is “661preset.txt”. During load settings, it displays “Executing...”. After the file load is completed, “Completed” is displayed for one second and returns to Stop mode.

6) Save Settings

“Save Settings” saves all of the preset values onto the SD card. To set the saved files onto the PMD661, perform Load Settings.

1. From Stop, press the  (**F1: MENU**) button.
2. Press the **PITCH +** or **PITCH –** button to select “Utility”.
Then press the **▶/||/ENTER** button to accept.
3. Press the **PITCH +** or **PITCH –** button to select “Save Settings”.
4. Press the **▶/||/ENTER** button. “Save?” message is displayed.
 - Press the **STOP/CANCEL** button to cancel saving item and return to the stop mode.
5. While “Save?” message is displayed, select “Yes” and press **▶/||/ENTER** button to output preset value in text format into the file in a route folder on card. The title of the file output is “661preset.txt”. During preset output, “Executing...” is displayed. After the file output is completed, “Completed” is displayed for one second and returns to Stop mode.

7) Card Format

1. From Stop, press the  (F1: MENU) button.
2. Press the **PITCH +** or **PITCH –** button to select “Utility”.
Then press the **►/II/ENTER** button.
3. Press the **PITCH +** or **PITCH –** button to select “Card Format”.
Then press the **►/II/ENTER** button.
 - “Card Format?” message is displayed.
 - Press the **STOP** button to cancel a Card Format item and return to STOP.
4. While “Card Format?” message is displayed, select “Yes” and press the **►/II/ENTER** button to format the SD card.
During formatting, “Executing...” is displayed. After displaying “Completed” for a second, PMD661 return to the stop mode.

File format of the 661preset.txt

| Item | Separator | Set Value | Break |
|------------|-----------|-------------|------------|
| [Preset-1] | | Fixed value | 0D0Ah |
| Name | = | | 0D0Ah |
| Input | = | | 0D0Ah |
| ⋮ | ⋮ | ⋮ | ⋮ |
| Play Mode | = | | 0D0A0D0A h |
| [Preset-2] | | Fixed value | 0D0Ah |
| Name | | | 0D0Ah |
| Input | = | | 0D0Ah |
| ⋮ | ⋮ | ⋮ | ⋮ |
| Play Mode | = | | 0D0A0D0A h |
| [Preset-3] | | Fixed value | 0D0Ah |
| Name | | | 0D0Ah |
| Input | = | | 0D0Ah |
| ⋮ | ⋮ | ⋮ | ⋮ |
| Play Mode | = | | 0D0A0D0A h |
| [Display] | | Fixed value | 0D0Ah |
| Brightness | | | 0D0Ah |
| ⋮ | ⋮ | ⋮ | ⋮ |
| File Sort | | | 0D0A0D0A h |
| [Common] | | Fixed value | 0D0Ah |
| Machine ID | = | | 0D0Ah |
| Version | = | | 0D0Ah |

File List Menu

The file list displays a list of file titles, MP3 and WAV in 'MPGLANG1' or other folders. The list can be used to play, rename or delete the selected file or check the information of the file.

1. From Stop, press the  (F2: LIST) button.



- The file list appears on the display.
- The selected item is highlighted.
- When the first item is selected, press the **PITCH +** button to jump to the last item.
- When the last item is selected, press the **PITCH –** button to jump to the first item.
- Press the  to enter the Folder list.

2. Press the **PITCH +** or **PITCH –** button to select the file you want to access. Then press the /ENTER button to enter the File list Menu.



- During file list menu mode, press the **STOP** button to return to the stop mode.

File List Menu Functions

| # | Display | Description |
|---|--------------|-----------------------------------------------------|
| 1 | Play | Play the file. |
| 2 | Information | Display information of the file. |
| 3 | Rename | Rename the file title. |
| 4 | Delete | Delete the file. |
| 5 | Copy | Make a copy of a file in another folder. |
| 6 | Move | Move the from the current folder to another folder. |
| 7 | Delete Marks | Delete mark(s) in the selected file. |

1) Play

The “Play” menu item allows you to play the selected file.

1. In the file list menu, press the **PITCH +** or **PITCH –** button to select “Play”.



2. Press the **▶/||/ENTER** button to start playback.
 - Press the **STOP** button to stop playback and return to File List.

2) Information

The “Information” menu item allows you to display the information of the selected file.

1. In the file list menu, press the **PITCH +** or **PITCH –** button to select “Information”.



2. Press the **▶/||/ENTER** button to display the information.

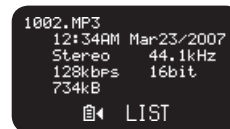

- Press the **◀◀** button to return to the File list Menu.
- Press the **STOP** button to return to the stop mode.

3) File Rename

The “Rename” menu item allows you to change the file name of the selected file.

1. In the file list menu, press the **PITCH +** or **PITCH –** button to select “Rename”.

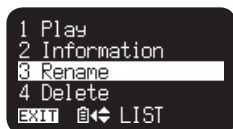

2. Press the **►/II/ENTER** button to access the rename window.
3. Rename the file title.
Refer to the procedure of the “Preset Rename (P. 40).
4. Press the **►/II/ENTER** button to store the changes.
Press the **◀◀** button to go back the previous page without store the changes when the first letter of the file title is highlighted.

Notes:

- If the last letter of the file name is Space(SP) character, the file name does not include the last letter.
- If number of letter is more than 60, last letter is deleted when a new letter is added.

4) Delete

The “Delete” menu item allows you to delete the selected file.

1. In the file list menu, press the **PITCH +** or **PITCH –** button to select “Delete”. Then press the **►/II/ENTER** button.
 - “File Delete?” appears on the display.
 - Select “Yes” and press the **►/II/ENTER** button to delete the file.
 - Select “No” and press the **►/II/ENTER** button to return to File List Menu.
 - Press the **STOP** button to return to the stop mode.

5) Copy

The “Copy” menu item allows you to make a copy of a file from the current folder to another folder.

1. In the file list menu, press the **PITCH +** or **PITCH –** button to select “Copy”. Then press the **►/II/ENTER** button.
 - The folder list appears on the display.
2. Press the **PITCH +** or **PITCH –** button to select the folder you wish to copy to. Then press the **►/II/ENTER** button.
 - The copy starts. “Executing...” appear during copy process.
 - Press the **STOP** button to return to the stop mode.

6) Move

The “Move” menu item allows you to move a file from the current folder to another folder.

1. In the file list menu, press the **PITCH +** or **PITCH –** button to select “Move”. Then press the **▶/||/ENTER** button.
 - The folder list appears on the display.
2. Press the **PITCH +** or **PITCH –** button to select the folder you wish to move to. Then press the **▶/||/ENTER** button.
 - The move starts. “Executing...” appear during moving.
 - Press the **STOP** button to return to the stop mode.

7) Delete Marks

The “Delete Marks” menu item allows you to delete all marks in the selected file.

1. In the file list menu, press the **PITCH +** or **PITCH –** button to select “Delete Marks”. Then press the **▶/||/ENTER** button.
 - “MARK Delete?” message appears on the display.
 - Select “Yes” and press the **▶/||/ENTER** button to delete marks.
 - Select “No” and press the **▶/||/ENTER** button to return to the File List Menu.
 - Press the **STOP** button to return to the stop mode.

Folder List Menu

The folder list menu item allows you to display a list of folder titles. And you can set the selected folder as a current directory, change the folder title, delete the folder and create a new folder.

1. While the file list is displayed in the “LIST” status, press the **◀◀** button.

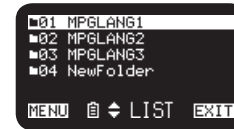

- The folder list appears on the display.
- The selected item is highlighted.
- When the first item is selected, press the **PITCH +** button to jump to the last item.
- When the last item is selected, press the **PITCH –** button to jump to the first item.

2. Press the **PITCH +** or **PITCH –** button to select the folder you want to access. Then press the **▶/||/ENTER** button or the **⏏ (F1: MENU)** button to enter the Folder list Menu.

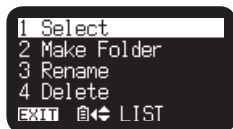

- Press the **◀◀** or **⏏ (F1: EXIT)** button to return to the Folder list.
 - During Folder list Menu mode, press the **STOP** button to return to the stop mode.
3. Press the **PITCH +** or **PITCH –** button to select the item to access. Then press the **▶/||/ENTER** button to jump to the item or execute.

Folder list Menu Functions

| # | Display | Description |
|---|-------------|------------------------------------------------|
| 1 | Select | Set the selected folder as the current folder. |
| 2 | Make Folder | Create a new folder. |
| 3 | Rename | Change the selected folder title. |
| 4 | Delete | Delete the selected folder. |

1) Select

The “Select” menu item allows you to set the selected folder as the current folder.

1. In the folder list menu, press the **PITCH +** or **PITCH –** button to choose “Select”.



2. Press the **▶/||/ENTER** button to set the selected folder to the current folder.

2) Make Folder

The “Make Folder” menu item allows you to create a new folder.

1. In the folder list menu, press the **PITCH +** or **PITCH –** button to select “Make Folder”. Then press the **▶/||/ENTER** button.
 - A new folder titled “NewFolder” is created.
 - The folder list appears and the new folder is highlighted.

Notes:

- If the “NewFolder” already exists, “Already Exists” message appears for one second.
- If the number of folders is already 32, “Full Folder” message appears for one second.

3) Rename

1. In the folder list menu, press the **PITCH +** or **PITCH –** button to select “Rename”.
2. Press the **▶/||/ENTER** button to access the rename window.
3. Rename the file title.
Refer to the procedure of the “Preset Rename” (P. 40).
4. Press the **▶/||/ENTER** button to return to the folder list menu.
Press the **◀◀** button to go back to the previous page without store the changes when the first letter of the folder title is highlighted.

Notes:

- If the Last letter of the folder name is Space(SP) character, the folder name does not include the last letter.
- If the number of letter exceeds the limit of 32, last letter is deleted when a new letter is added.

4) Delete

The “Delete” menu item allows you to delete the selected folder.

1. In the folder list menu, press the **PITCH +** or **PITCH –** button to select “Delete”. Then press the **▶/||/ENTER** button.
 - “Delete?” message appears on the display.
 - Select “Yes” and press the **▶/||/ENTER** button to delete the folder.
 - Select “No” and press the **▶/||/ENTER** button to return to the folder list menu.
 - Press the **STOP** button to return to the stop mode.

Note:

You cannot delete the last folder remained in an SD card. When the last folder remains, “Can not...” appears for one second.

Troubleshooting

Should problems occur, it is often unnecessary to consult your dealer or technical service department. On the basis of the following checks, you may be able to rectify a number of conditions yourself without difficulty. If the condition cannot be remedied after the following check, please consult your dealer.

The PMD661 does not turn on.

- Install fresh batteries.
- Check AC adapter connections.

The PMD661 turns on then turns itself off.

- Install fresh batteries.

The PMD661 seems to record, but there is no sound on playback.

- Check input settings.
(For example, if LINE input is selected and no input is connected to the LINE jack, the PMD661 will record silence. The PMD661 will not playback.)

There is no audio playback through headphones or internal speaker.

- Check VOL+/- control setting.
- Check a different audio file or the card.

The PMD661 will not record.

- Check that the maximum of 999 files have not been recorded.
- Check that the PMD661 acknowledges the card.

No signal from microphone input.

- Check input selection.
- Check REC LEVEL control settings.
- Check if microphone(s) require(s) Phantom power.

There is excessive noise on the PMD661.

- Check cable connections and/or replace cable.
- Check for proper gain levels.

Playback on a PC results in poor sound.

- Check quality of PC sound card and program.
- Check frequency conversion program.*

* The PMD661 records audio files with a sampling frequency of 48kHz. Some PC programs convert the files to 44.1kHz (using a sample rate converter). Only high quality sample rate converters should be used.

PC cannot read files

- Check the capability of the PC program. Some playback and editing programs do not support MP3 or Broadcast Wave (.wav) formats.

If the PMD661 exhibits erratic behavior, the microprocessor can be reset by powering off, disconnecting AC power and removing batteries.

Care and Maintenance

Use a soft cloth slightly moistened with mild detergent solution. Media cards that are heavily used should be occasionally reformatted to avoid audio problems due to fragmentation.

Error Message

Details of error processing

| Display | Description |
|------------------------------------|-------------------------------------------------------------|
| No Card | Card cannot be found |
| Unformat | Format other than FAT16/32, or card format error |
| Full Card | Memory is not enough |
| Full 999 | Number of files is already 999 (maximum) |
| Full MARK | Number of marks in the current file is already 30 (maximum) |
| No File | No file found |
| Key Locked | Operation during Key Lock |
| Card Locked | Prohibition of writing into the card |
| VBR | FWD or RWD of VBR file |
| Can not... | Command is invalid |
| Need DC IN | No DC input |
| Low Battery (flashing highlighted) | Remaining battery is below set value |
| Low Battery | Automatic power down in low battery level last time. |
| No PresetFile | No preset setting file is found |
| ErrPresetFile | File contents of preset setting has errors |
| ErrUpdateFile | Version up file or file system does not function normally |
| Door Open | SD card door is open |
| Err Format | Error in file format of MP3 or PCM |
| Already Exists | Same file title is found |
| Limit 80m | Over 80 minutes in copy segment process |
| Long Title | File title exceeds 64 Bytes |
| Err Card | Error is found in the card |
| Err RTC | Error is found in RTC |
| Err SRAM | Error is found in SRAM |
| Err FlashROM | Error is found in Flash ROM |
| Need Update | Update is not completed |
| Unmatched | Setting of the preset is not correct |

Specifications

Digital Audio System

| | |
|-----------------------------|-----------------------------|
| System | Solid State Recorder |
| Usable media..... | SD/SDHC cards |
| Recording format | |
| MP3..... | MPEG1 Layer III Compression |
| WAV..... | 16/24 bit linear PCM |
| Recording MP3 bit-rate..... | 320/256/192/128/64 kbps |
| Sample rate..... | 44.1/48/96 kHz |
| Number of channels..... | 2 (Stereo)/1 (Mono) |

Audio Performance

| | |
|-----------------------------------|-----------------------------|
| Frequency response..... | 20 Hz - 24 kHz (\pm 1dB) |
| S/N ratio IEC-A weighted | |
| MIC | 65 dB |
| LINE..... | 85 dB |
| Total harmonic distortion at 0 VU | |
| MIC | 0.08% |
| LINE..... | 0.02% |
| Dynamic range..... | 85 dB |

Inputs

| | |
|-------------------------|---------------------|
| External MIC | |
| Type | XLR stereo jack |
| Input sensitivity | 1.2 mVrms/4.2 kohms |
| LINE | |
| Type | XLR stereo jack |
| Input sensitivity | 0 dBu/4.2 kohms |
| LINE2 | |
| Type | 1/8" stereo jack |
| Input sensitivity | .500 mVrms/20 kohms |

Outputs

| | |
|---------------------|------------------|
| LINE | |
| Type | RCA stereo jack |
| Standard level..... | 2.0 V/10 kohms |
| Headphone | |
| Type | 1/4" stereo jack |
| Standard level..... | 16 mW/32 ohms |
| Speaker | |
| Standard level..... | 450 mW/8 ohms |

General

| | |
|-------------------------------|----------------------------------------------------------------------------------------|
| Power consumption | |
| Recording/Playback | 4.2 W (DC) |
| Battery life (Alkaline)..... | .5 hours (Typical) |
| Phantom power..... | 48V, 10mA (Max.) |
| Power | |
| AC adaptor | DA620PMD included |
| Batteries..... | 4 x AA type alkaline dry cell batteries or 4 x AA type Ni-MH rechargeable batteries |
| Backup battery | Lithium battery for real-time clock |
| Environmental conditions | |
| Operational temperature..... | 0 - 40°C (32 - 104°F) |
| Operational humidity..... | 25 - 85% (no condensation) |
| Storage temperature..... | -20 - 60°C (-4 - 140°F) |
| Dimensions | |
| Width..... | 93 mm (3.7") |
| Height | 165 mm (6.5") |
| Depth | 36 mm (1.4") |
| Weight (Excl. batteries)..... | 410 g (14 oz) |

Included Accessories

| |
|------------------------------------------|
| Audio cable (RCA – 1/8" stereo type) |
| USB cable (Type mini-B – Type A) |
| AC adapter (DA620PMD) |
| User guide |
| CD-ROM |
| Carry strap |
| Customer Registration Document (US only) |
| SD card |

- Specifications are subject to change without notice.

Limited Warranty

Your Marantz Professional product is warranted against manufacturer defects in material and workmanship for a period of one year parts and labor.

Except as specified below, this warranty covers defects in material and workmanship. The following are not covered under warranty:

1. Damage, deterioration, malfunction or failure to meet performance specifications resulting from:
 - a) Accidents, acts of nature, misuse, abuse, neglect or unauthorized product modification.
 - b) Improper installation, removal or maintenance, or failure to follow supplied instructions.
 - c) Repair or attempted repair by a non-Marantz authorized agent.
 - d) Any shipment (claims must be presented to the carrier).
 - e) Any cause other than a defect of manufacturing.
2. Cleaning, check-ups with no fault found or changes incurred for installation, removal or reinstallation of the product.
3. Any serialized product on which the serial number has been defaced, modified or removed.
4. Batteries and battery chargers.
5. Accessories, including but not limited to: cables, mounting hardware and brackets, cleaning accessories, power cords and adapters, and carry cases.

Non-transferable warranty

This Warranty may be enforced only by the original purchaser.

What We Will Pay For

We will pay for all labor and material expenses for items covered by the warranty.

How You Can Get Service (Americas only)

1. If your unit needs service in the USA, contact our service referral at the appropriate telephone number indicated below. We will advise you of the name and location of one or more authorized service centers from which service may be obtained. Please do not return the unit directly to us.
2. You must pay any shipping charges if it is necessary to ship the product for service. If the necessary repairs are covered by the warranty, we will pay return shipping charges to your location anywhere in the United States or its territories.
3. Whenever warranty service is required, you must present the original dated sales receipt or other proof of date purchased.

Limitation of Implied Warranties

All implied warranties, including warranties of merchantability and fitness for a particular purpose, are limited in duration to the length of this warranty.

Exclusion of Damages (Americas only)

Liability for any defective product is limited to repair or replacement of the product at manufacturer's option. Manufacturer shall not be liable for damage to other products caused by any defects in Marantz products, damages based on inconvenience or loss of use of the product, or any other damages, whether incidental, consequential, or otherwise.

Some States do not allow limitations on how long an implied warranty lasts and/or do not allow the exclusion or limitation of incidental or consequential damages, so the above limitations and exclusions may not apply to you.

How State Law Relates to the Warranty (Americas only)

This warranty gives you specific legal rights, and you may have other rights which may vary from State to State.

Marantz Professional Service Number (Americas only):

Marantz Professional Factory Service (630) 741-0330

Products purchased outside of the United States, its possessions or territories.

This warranty is enforceable only in the United States and its possessions or territories.

Marantz Professional products Sales Office Site:

For inquiries or information on repair service of Marantz Professional Products, please contact our Sales Office or Tech Support Centre near you which are listed in D&M Professional website below.

AMERICA

D&M Professional America <http://www.d-mpro.com>

EUROPE

D&M Professional Europe <http://www.d-mpro.eu.com>

ASIA/OTHERS

D&M Professional Asia <http://www.d-mproasia.com>

D&M Holdings Inc.
PROFESSIONAL BUSINESS COMPANY



Free Manuals Download Website

<http://myh66.com>

<http://usermanuals.us>

<http://www.somanuals.com>

<http://www.4manuals.cc>

<http://www.manual-lib.com>

<http://www.404manual.com>

<http://www.luxmanual.com>

<http://aubethermostatmanual.com>

Golf course search by state

<http://golfingnear.com>

Email search by domain

<http://emailbydomain.com>

Auto manuals search

<http://auto.somanuals.com>

TV manuals search

<http://tv.somanuals.com>