



### **Regulatory Approval**

- FCC Class A
- UL 1950
- CSA C22.2 Number 950
- EN60950
- CE
  - EN55022 Class A
  - EN55024

### **Canadian EMI Notice**

This Class A digital apparatus meets all the requirements of the Canadian Interference-Causing Equipment Regulations.

Cet appareil numérique de la classe A respecte toutes les exigences du Règlement sur le matériel brouilleur du Canada.

### **European Notice**

Products with the CE Marking comply with both the EMC Directive (89/336/EEC) and the Low Voltage Directive (73/23/EEC) issued by the commission of the European Community. Compliance with these directives implies conformity to the following European Norms:

- EN55022 (CISPR 22) - Radio Frequency Interference
- EN61000-X - Electromagnetic Immunity
- EN60950 (IEC950) - Product Safety

#### **Five-Year Limited Warranty**

MiLAN Technology warrants to the original consumer or purchaser that each of its products, and all components thereof, will be free from defects in material and/or workmanship for a period of five years from the original factory shipment date. Any warranty hereunder is extended to the original consumer or purchaser and is not assignable.

MiLAN Technology makes no express or implied warranties including, but not limited to, any implied warranty of merchantability or fitness for a particular purpose, except as expressly set forth in this warranty. In no event shall MiLAN Technology be liable for incidental or consequential damages, costs, or expenses arising out of or in connection with the performance of the product delivered hereunder. MiLAN Technology will in no case cover damages arising out of the product being used in a negligent fashion or manner.

### **Trademarks**

© 2000 MiLAN, the MiLAN logo and MiLAN Technology are either trademarks or registered trademarks of Digi International, Inc. in the United States and/or other countries. All other trademarks are the property of their respective holders.

### **To Contact MiLAN Technology**

For prompt response when calling for service information, have the following information ready:

- Product serial number and revision
- Date of purchase
- Vendor or place of purchase

You can reach MiLAN Technology technical support at:

E-mail: [support@milan.com](mailto:support@milan.com)  
Telephone: +1.408.744.2751  
Fax: +1.408.744.2771

MiLAN Technology  
1299 Orleans Drive  
Sunnyvale, CA 94089-1138  
United States of America

Telephone: +1.408.744.2775  
Fax: +1.408.744.2793

<http://www.milan.com>  
info @ milan.com

© Copyright 2000 MiLAN Technology P/N: 90000363\_A

# Contents

---

<b>1. Introduction</b>	<b>1</b>
Features	2
Package Contents	2
<b>2. Hardware Description</b>	<b>4</b>
Front Panel	4
MIL-S801XX 9 port switch with SC fiber port	4
MIL-S801XX 9 port switch with SC (Single-mode) fiber port	5
MIL-S801XX 9 port switch with ST fiber port	5
MIL-S801XX 9 port switch with MT-RJ fiber port	6
MIL-S801XX 9 port switch with VF-45 fiber port	7
Rear Panel	7
Desktop Installation	8
<b>3. Network Application</b>	<b>10</b>
Desktop Application	10
Segment Application	11
<b>4. Trouble Shooting</b>	<b>10</b>
Diagnosing LED Indicator	13
Power	13
Transmission Mode	14
<b>5. Technical Specifications</b>	<b>15</b>

# 1. Introduction

---

MiLAN's MIL-S801XX switch with a fiber port is a compact desktop size switch, which is an ideal solution for many network users. It provides wire-speed, Fast Ethernet switching function that allows high-performance, low-cost connections.



**Figure 1. The MIL-S801XX**

The MIL-S801XX nine port switch provides 8 switched auto-sensing 10/100 Mbps RJ-45 Ethernet ports and one 100BASE-FX fiber port.

The switch combines both 10BASE-T and high-speed 100BASE-TX support in one device. The switch automatically senses the speed of the connected end device (either 10 or 100 Mbps) and transfers the data at the appropriate speed. The MIL-S801 features store-and-forward switching for data and auto-learning of addresses which is stored in a 4,000 entry MAC address table.

The fiber connector on the switch has four different possible options: SC, ST, VF-45 and MT-RJ. These connector options are all available in multi-mode with a maximum distance of 2 Km. There is one connection option in single-mode. The SC connector provided by the fiber distance of 15Km, 40Km and 60Km.

# Features

- Eight 10/100Mbps Fast Ethernet UTP switch ports
- One 100Mbps multi-mode port (SC, ST, MT-RJ, VF-45) or single-mode SC port
- One DIP-switch to select fiber port full-duplex or half-duplex mode
- Auto-negotiation for full or half duplex
- Store-and-forward switching architecture for packet filtering
- Full wire speed forwarding rate
- 4K-entry MAC address table
- 256KB memory buffer sharing
- LED-indicators for power, 100M, LK/ACT, FD/COL statuses
- Compact size
- Eight auto-sensing MDI/MDIX ports

# Package Contents

- MIL-S801XX switch
- Power Cord
- Four Rubber Feet with adhesive pads
- User's Manual



**MIL-S801XX switch**



**Figure 1-2. Package Contents**

Compare the contents of your switch package with the standard checklist above. If any item is missing or damaged, please contact your sales person.

## 2. Hardware Description

This Section mainly describes the hardware of the MIL-S801XX switch. The switch is compact (10 inches) with eight 10/100BASE-TX UTP ports plus one 100BASE-FX fiber port.

**The physical dimensions of the MIL-S801XX switch are: 250mmx 132mmx 37mm (L 9.8"x W 5.2"x H 1.5")**

### Front Panel

The Front Panel of the MIL-S801XX switch consists of eight 10/100 UTP switch ports (automatic MDI/MDIX), one 100BASE-FX fiber port and one DIP-switch to select fiber port for full-duplex or half-duplex mode. The LED indicators are also located on the front panel of the switch.

#### MIL-S801XX switch with SC fiber port

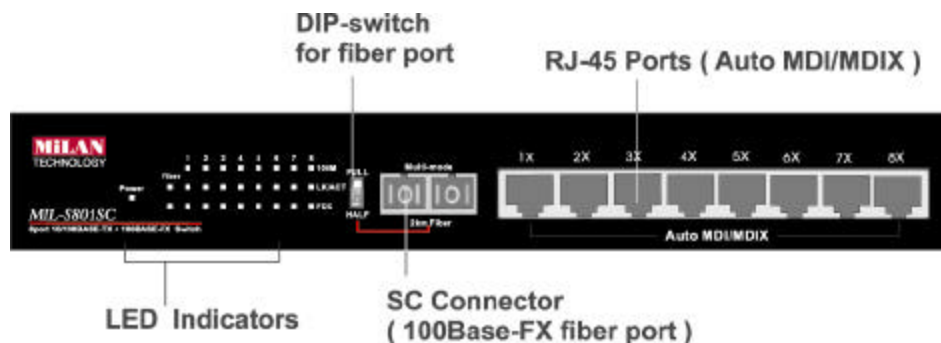

**Figure 2-1. The Front Panel of the MIL-S801XX switch with SC fiber port**

The Front Panel of the MIL-S801XX switch is displayed as above and below. There are four types of fiber connectors in multi-mode. These fiber connectors are SC, ST, MT-RJ and VF-45. The single-mode version is only available with SC connectors.

#### MIL-S801XX switch with SC (Single-mode) fiber port

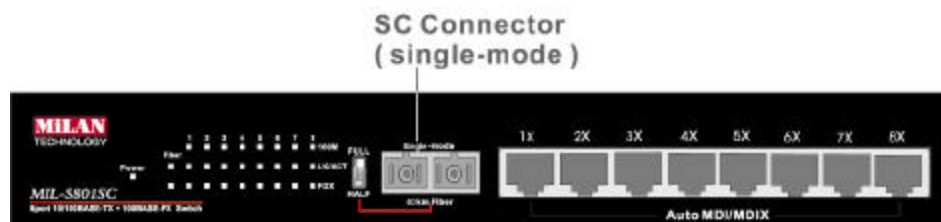

**Figure 2-2. The Front Panel of the MIL-S801XX switch with SC (single mode) fiber port**

### MIL-S801XX switch with ST fiber port

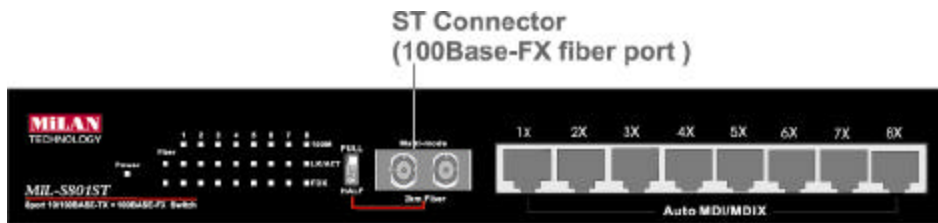

Figure 2-3. The Front Panel of the MIL-S801XX switch with ST fiber port

### MIL-S801XX switch with MT-RJ fiber port

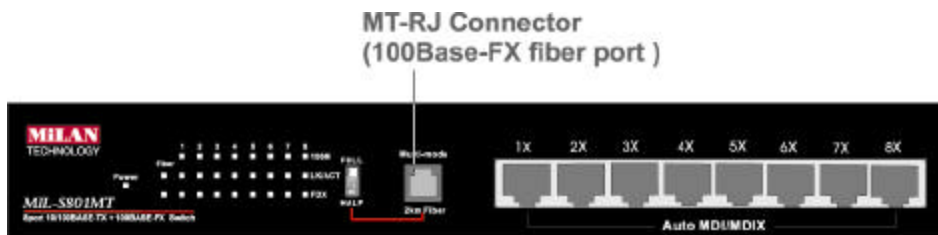

Figure 2-4. The Front Panel of the MIL-S801XX switch with MT-RJ fiber port

### MIL-S801XX switch with VF-45 fiber port

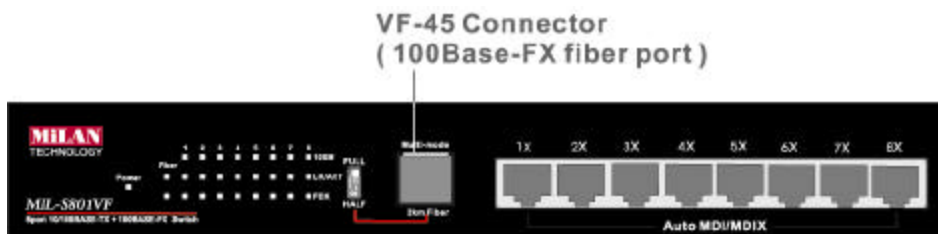

Figure 2-5. The Front Panel of the MIL-S801XX switch with VF-45 fiber port

**RJ-45 Ports (Auto MDI/MDIX):** Eight auto-sensing for 10BASE-T or 100BASE-TX connections.

In general, **MDI** means connecting to another Hub or switch while **MDIX** means connecting to a workstation or PC. Therefore, **Auto MDI/MDIX** means that you can connect to another switch or workstation without changing cabling.

**100BASE-FX Port:** There are 4 types of fiber connectors available for the MIL-S801XX switch as shown above. The distance for multi-mode fiber cabling can be extended up to 2 kilometers. However, the distance for SC single-mode fiber port is from 15 to 60 kilometers.

**DIP-switch:** the DIP-switch is to select Full-Duplex or Half-Duplex mode for fiber port.

## LED Indicators

The following table provides descriptions of the LED statuses and meaning. They provide a real-time indication of systematic operation status.

LED	Status	Color	Description
<b>Power</b>	On	Green	Power On
<b>100M</b>	On	Green	The port is operating at the speed of 100 Mbps.
	Off		In 10 Mbps mode or no device attached
<b>LNK / ACT</b>	On	Green	The port is successfully connecting with the device.
	Blinks		The port is receiving or transmitting data.
	Off		No device attached.
<b>FDX / COL</b>	On	Yellow	The port is operating in full-duplex mode.
	Blinks		Collision of packets is occurring on the port.
	Off		Half-duplex mode or no device attached.

**Table 2-1. The description of LED Indicator**



## Rear Panel

The 3-pronged power plug is located at the Rear Panel of the 9-Port switch as shown in Figure 2-6. The switch will work with AC in the range 100-240V AC, 50-60Hz.



Figure 2-6 The Rear Panel of the MIL-S801XX switch

## Desktop Installation

Set the switch on a sufficiently large flat space with a power outlet nearby. The surface where you put your switch should be clean, smooth, level, and sturdy.

Make sure there is enough clearance around the switch to allow attachment of cables, power cord and air circulation.

### Attaching Rubber Feet

- A. Make sure mounting surface on the bottom of the switch is grease and dust free.
- B. Remove adhesive backing from your Rubber Feet.
- C. Apply the Rubber Feet to each corner on the bottom of the switch. These footpads can prevent the switch from shock/vibration.



Figure 2-3. Attaching Rubber Feet to each corner on the bottom of the switch

### Power On

Connect the power cord to the power socket on the rear panel of the switch. The other side of power cord connect to the power outlet. The internal power supply in the switch works with AC in the voltage range 100-240VAC, frequency 50~60Hz. Check the power indicator on the front panel to see if power is properly supplied.

## 3. Network Application

---

This section provides two samples of network topology in which the switch is used. In general, the MIL-S801XX switch is configured for use as a desktop or segment switch.

The MIL-S801XX switch networks PCs, workstations, and servers to each other by connecting these devices directly to the switch. It automatically learns node address, which are subsequently used to filter and forward all traffic based on the destination address.

### Desktop Application

The MIL-S801XX switch is an ideal solution for small workgroups. The switch can be used as a standalone switch to which personal computers, servers, and printer servers are directly connected to form a small workgroup.

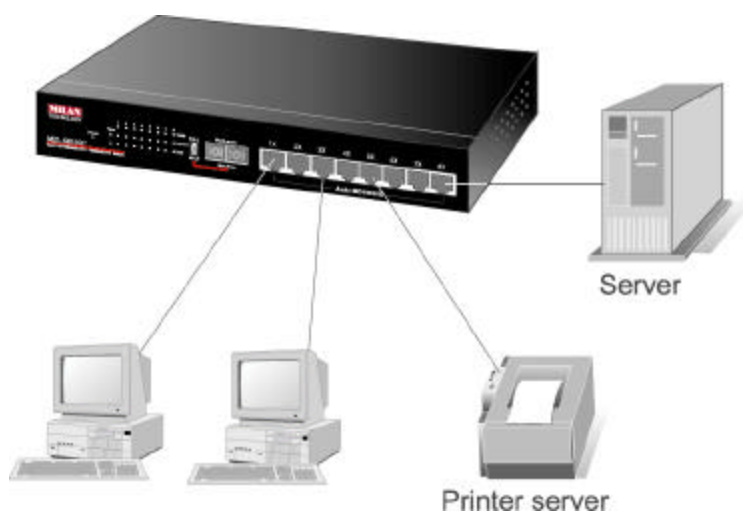

**Figure 3-1. Desktop Application**

## Segment Application

Any of the RJ-45 ports on the MIL-S801XX switch can connect with other switches or Hubs to interconnect small workgroups to form larger switched networks. You can also use fiber ports to connect switches. The distance between two switches via fiber cable can be up to 2Km or up to 60Km (SC single-mode fiber connector).

For enterprise networks where large data broadcast are constantly processed, this switch is suitable for a department connection to the corporate backbone.

In the following illustration, two MIL-S801XX switches are used to interconnect two small workgroups. All the devices in this network can communicate with each other. Connecting servers to the switch allow other users to access the server's data.

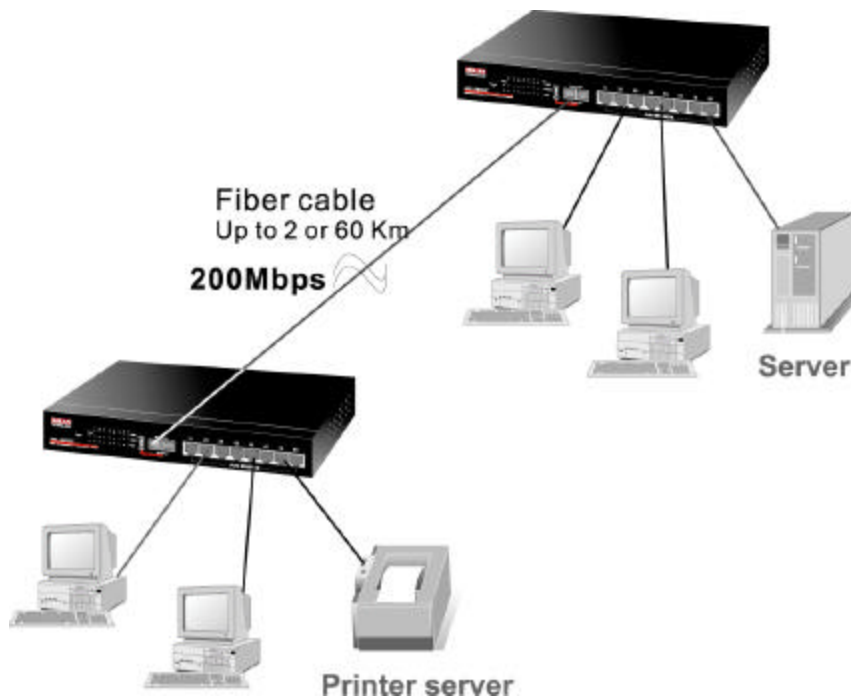

**Figure 3-2 Segment Application**

## 4. Trouble Shooting

---

This troubleshooting section is intended to help you solve the most common problems on the MIL-S801XX switch.

The switch can be easily monitored through panel indicators to assist in identifying problems. This section describes common problems you may encounter and where you can find possible solutions.

### Diagnosing LED Indicator

If the Link indicator does not light up after making a connection, you should check the network interface (e.g., a network adapter card on the attached device), device to see if it is powered on or defective. Be sure the cable is plugged into both the switch and corresponding device. Verified the proper cable type is used and its length does not exceed specified limits.

### Power

If the power indicator does not turn on when the power cord is plugged in, you may have a problem with power outlet, or power cord. However, if the switch powers off after running for a while check for loose power connections, power losses or surges at power outlet. If you still cannot resolve the problem, contact your local dealer for assistance.

### Transmission Mode

Verify that each port is set to the same transmission mode used by the attached device (i.e., half or full duplex). The RJ-45 port use auto-negotiation to set the transmission mode. If the attached device operates at half duplex, which is the default when auto-negotiation fails, then it does not have to support auto-negotiation.

### Cabling

RJ-45 ports: Use unshielded twisted-pair (UTP) or shield twisted-pair (STP) cable for RJ-45 connections: 1000 cable for 10Mbps connections. See cable specifications on next page. Twisted-pair cabling can not exceed 100 meters (328 feet).

100BASE-FX fiber port: multi-mode must be 62.5/125 um fiber cable. You can connect two devices over a 2-kilometer distance with multi-mode fiber. Single-mode must use 9/125 um single- mode fiber cable. You can connect two devices up to 60- kilometers running full duplex.

## 5. Technical Specifications

---

This section provides the specifications for the MIL-S801XX switch

### Specifications

Standards Compliance	IEEE 802.3 10BASE-T Ethernet, IEEE 802.3u 100BASE-TX/FX Fast Ethernet ANSI/IEEE 802.3 Auto-negotiation
Protocol	CSMA/CD
Max Forwarding Rate and Max Filtering Rate	14,880 pps per Ethernet port, 148,800 pps per Fast Ethernet port
LED Indicators	Per Port: 8 port: 100M, LK/ACT, FD/COL (3 LEDs) Fiber Port : LK/ACT, FD/COL (2 LEDs) Per Unit: Power
Network Cables	10BASE-T: 2-pair UTP Cat. 3, 4, 5 cable (100m), EIA/TIA-568 100-ohm STP (100m)  100BASE-TX: 2-pair UTP Cat. 5 cable (100m), EIA/TIA-568 100-ohm STP (100m)  100BASE-FX: 50, 62.5/125 micron multi-mode fiber-optics (2Km) 8,9/125 micron single-mode fiber-optics (15, 40, 60Km)
Fiber Link Max. Distance	ST/SC/MT-RJ/VF-45 Multi-mode: Full-duplex- 2Km, Half-duplex- 412m  SC Single-mode: Full-duplex- from 15Km to 60Km Half-duplex- 412m
Dimensions	250mm x 132mm x 37mm (9.8 x 5.2 x 1.5)
Operational Temperature	0°C to 45°C (32°F to 113°F)
Operational Humidity	10% to 90% (Non-condensing)
Internal Power Supply	3.3V, 3A
EMI	FCC Class B, CE Mark
Safety	UL, TUV, CSA



A Division of Digi International

## Free Manuals Download Website

<http://myh66.com>

<http://usermanuals.us>

<http://www.somanuals.com>

<http://www.4manuals.cc>

<http://www.manual-lib.com>

<http://www.404manual.com>

<http://www.luxmanual.com>

<http://aubethermostatmanual.com>

Golf course search by state

<http://golfingnear.com>

Email search by domain

<http://emailbydomain.com>

Auto manuals search

<http://auto.somanuals.com>

TV manuals search

<http://tv.somanuals.com>