



network

Flashlink User Manual

ASI-IP-GTW

DVB-ASI to IP Gateway

network-electronics.com

Rev. 2.10.0

This page is intentionally left blank

Important notice:

Network Electronics ASA reserve the right to make corrections, modifications, enhancements, improvements and other changes to its products or services at any time and to discontinue any product or service without notice.

About this manual

This manual explains how to operate the ASI-IP-GTW IP to ASI Video Gateway. It is shown how to install and maintain the unit. In addition, the functionality of the unit is described in detail.

This manual should be kept in a safe place for reference for the life time of the equipment. Further copies of this manual can be ordered from Network. If passing the equipment to a third party, please ensure to pass all relevant documentation including this manual.

Issues of this manual are listed below:

Rev.	Date	SW ver.	Comment
1.1	July 2005	0.11.4	Initial release
2.0	September 2005	1.1.0	Release with FEC, VLAN and SFP interface
2.1	November 2005	1.1.5	Intermediate release with implementations on iterative FEC, more on alarms and other general improvements.
2.2	January 2006	1.2.2	Release with SNMP support as optional feature and support for UDP transmission mode
2.3	April 2006	1.3.x	Release with bi-directional operation, and IGMPv3 support.
2.3b	May 2006	1.3.x	Small patch on description of RTP sequence errors.
2.4	July 2006	1.3.11	Ping option (3.5.5), New clock options (3.5.2), Advanced tab on IPRX (3.7.4), Speed-/ duplex mode for management port (3.5.1)
2.5	Sept. 2006	1.3.18	Added support for GPS module.
2.6	Oct. 2006	1.3.22	Added support for User Security and RIPv2.
2.7	March 2007	1.3.33	SNMP tab, Burst/Spread mode, No lock mode, updated features list.
2.8	April 2007	1.4.0	Dual ASI, Increased FEC matrixes, VBR mode, new FEC alarm, password resetting.
2.9	November 2007	2.20.4	Data channel ping, ASI bitrate limiter, Static MAC
2.10	January 2008	2.22.0	204 byte MPEG-2 transport stream support

How to use this manual

Novice users unfamiliar with the Video Gateways from Network should read this manual starting with Chapter 1. Users familiar with the Network Video Gateways and operation of video over IP equipment may start with Chapter 2. Users which are more interested in the functionality offered by the ASI-IP-GTW may directly go to Chapter 3.

Table of Contents

1	Introduction	8
1.1	Purpose of this Manual	8
1.1.1	Who Should Use this Manual.....	8
1.1.2	Warnings, Cautions and Notes.....	8
1.2	Contact Information	9
1.2.1	What Equipment is Covered by this Manual	9
1.2.2	Software versions.....	10
1.3	Role of the ASI-IP-GTW in a Typical System.....	10
1.4	Summary of Features.....	10
1.5	Guided Tour	12
1.5.1	The User Interface	12
1.5.2	Front Panel Description	12
1.5.3	Rear Panel Description	12
1.5.4	Construction.....	13
1.5.5	Hardware Options.....	13
1.5.6	Software Options	14
2	Installing the Equipment	15
2.1	Introduction.....	15
2.1.1	Read this first!	15
2.1.2	To inspect package content.....	15
2.2	Installing the Equipment.....	15
2.2.1	Selecting a site for the equipment	15
2.2.2	To fix the equipment	16
2.2.3	To cable the equipment.....	16
2.2.4	Equipment access.....	16
2.2.5	Ventilation.....	16
2.2.6	To connect the equipment.....	17
2.3	Power	18
2.3.1	AC Power Supply	18
2.3.2	Power Cable and Protective Earth	18
2.3.3	Optional DC Power Supply.....	20
2.4	Signal Connections	21
2.4.1	Introduction.....	21
2.4.2	ASI ports	21
2.4.3	Ethernet data port	22
2.4.4	Ethernet management port.....	23
2.5	LEDs	23
2.6	Powering Up/Down	24
2.6.1	Before Powering up.....	24
2.6.2	Powering Up	24
2.6.3	Powering Down.....	24
3	Operating the Equipment.....	25
3.1	Introduction.....	25
3.2	Changing the IP address of the unit	25
3.3	Looking at the WEB interface	26
3.4	Status.....	28
3.5	Device Info.....	29
3.5.1	Network.....	30

3.5.2	Time settings	33
3.5.3	Alarms.....	34
3.5.4	SNMP	34
3.5.5	Ping.....	36
3.5.6	Security.....	38
3.6	IP TX	39
3.6.1	Main.....	39
3.6.2	FEC Settings.....	42
3.6.3	Ethernet Settings.....	44
3.6.4	Ping Settings	45
3.7	IP RX	46
3.7.1	Main.....	46
3.7.2	FEC Settings.....	48
3.7.3	Ethernet Settings.....	50
3.7.4	Ping Settings	51
3.7.5	Advanced Tab	52
3.8	Network	54
3.9	Save/Load	56
3.9.1	Saving a Configuration	56
3.9.2	Loading a Configuration	57
4	Options	58
4.1	1PPS/10MHz interface modules	58
4.1.1	Separate 10MHz/1PPS module	58
4.1.2	1PPS interface	58
4.1.3	Operating the 1PPS/10MHz interface module	59
4.1.4	LED descriptions	60
4.2	RIPv2 functionality.....	61
4.2.1	User interface	61
5	Equipment Description	63
5.1	Introduction.....	63
5.2	Functional Description.....	63
5.2.1	Introduction	63
5.2.2	IP Transmit Mode	63
5.2.3	IP Receive Mode.....	64
5.2.4	IP Bi-directional Mode.....	64
5.2.5	Management.....	64
5.2.6	Alarms.....	64
5.3	Overview of Video over IP	67
5.3.1	Protocol mapping.....	67
5.4	Data Flow Block Diagrams	68
5.4.1	Forward Error Correction (FEC)	68
6	Preventive Maintenance and Fault-finding.....	70
6.1	Introduction.....	70
6.2	Preventive Maintenance	70
6.2.1	Routine Inspection.....	70
6.2.2	Cleaning	70
6.2.3	Servicing.....	70
6.3	Maintenance	70
6.3.1	Warranty	70
6.4	Fault-finding.....	71
6.4.1	Fault finding Philosophy	71

6.4.2	Preliminary Checks.....	71
6.4.3	PSU LED Unlit / Power Supply Problem.....	72
6.4.4	Fan(s) Not Working / Overheating.....	73
6.4.5	Alarm LED lit / Alarm condition	73
6.5	Disposing of this Equipment	75
6.5.1	General.....	75
6.6	To return the unit	75
7	Appendix A: Glossary.....	76
8	Appendix B: Technical Specification	80
8.1	DVB ASI port	80
8.2	Ethernet data port	81
8.3	Ethernet management port	81
8.4	Alarm relay and maintenance port specification	81
8.5	AC Mains Input.....	82
8.6	DC Mains input	82
8.7	Physical Details	83
8.8	Environmental Conditions.....	84
8.9	Compliance.....	84
8.9.1	Safety	84
8.9.2	Electromagnetic Compatibility - EMC.....	84
8.9.3	CE Marking	85
8.9.4	Interface to “public telecommunication system”	85
9	Appendix C: References	86
10	Appendix D: Upgrade of Features	87
11	Appendix E: Upgrading Software	90
12	Appendix F: Quality of service – Setting Packet priority	92
12.1	MPLS	92
12.2	Layer 3 Routing	92
12.3	Layer 2 priority	93

1 Introduction

1.1 Purpose of this Manual

This manual describes how to operate the ASI to IP Gateway, hereafter referred to as the ASI-IP-GTW. It also describes how to install and maintain the unit. A detailed technical description of the functionality of the unit is given as part of this document.

The following topics are covered in this manual:

- o General introduction to the ASI-IP-GTW
- o Installation of the Unit
- o Functional description of the Unit
- o Fault finding and maintenance

1.1.1 Who Should Use this Manual

This manual is written for operators and users of the ASI-IP-GTW and is meant to provide necessary information for installation, operation and day-to-day maintenance of the unit.

Note: This manual does not include any maintenance information or procedures which require the removal of covers.

1.1.2 Warnings, Cautions and Notes

1.1.1.1 Heed Warnings

All warnings on the product and in the operating instructions should be adhered to. The manufacturer can not be held responsible for injuries or damages where warnings and cautions have been ignored or taken lightly.

1.1.1.2 Read Instructions

All the safety and operating instructions should be read before this product is operated.

1.1.1.3 Follow Instructions

All operating and use instructions should be followed.

1.1.1.4 Retain Information

The safety and operating instructions should be retained for future reference.

Warning: Warnings give information, if strictly observed, will prevent personal injury and death, or damage to personal property or the environment.

Caution: Cautions give information, if strictly followed, will prevent damage to equipment or other goods.

Note: Notes provides supplementary information. They are highlighted for emphasis, as in this example, and are placed immediately after the relevant text.

1.2 Contact Information

Our primary is to provide first class customer care that is tailored to your specific business and operational requirements.

Telephone: +47 33 48 99 99
Fax: +47 33 48 99 98
Email: support@network-electronics.com
Web: <http://www.network-electronics.com>
Service: +47 90 60 99 99

Mailing and visiting address:

Network Electronics ASA
Thorøya, P.O. Box 1020
N-3204 Sandefjord
Norway

This manual does not include any maintenance information or procedures which require the removal of covers.

1.2.1 What Equipment is Covered by this Manual

This manual covers the ASI to IP Gateway. Figure 1 shows the physical unit.



Figure 1. The product

The ASI-IP-GTW consists of a 1RU high rack-mounted enclosure with a DSP module (Master Module) and 1 or 2 ASI I/O boards. Optical Gigabit or a second electrical Gigabit port is provided by an optional SFP (Small Form-Factor Pluggable) slot.

1.2.2 Software versions

This manual covers the functionality of the software version 1.4.0 or later of the ASI-IP-GTW. This manual continues to be relevant to subsequent software versions where the functionality of the equipment has not changed. When a new software version changes the functionality of the product, a new version of this manual will be provided.

1.3 Role of the ASI-IP-GTW in a Typical System

The ASI-IP-GTW provides a bridge between the MPEG-2 world and the IP world. The unit provides an interface between MPEG-2 transport streams, via DVB-ASI interface, to the IP based Network. It provides the ability to carry up to 8 individual MPEG-2 transport streams over an IP network. Each individual MPEG-2 transport stream is carried on an individual UDP port. At the reception site, the unit de-concentrates the MPEG-2 transport streams from the IP network, back to individual MPEG-2 transport streams and out through the DVB-ASI connections.

Figure 2 provides an overview of the ASI-IP-GTW in transmit and receive mode.

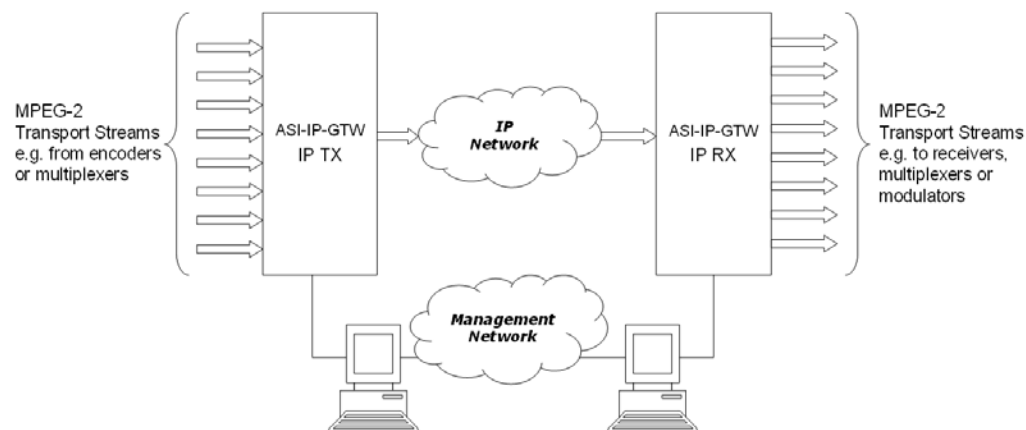

Figure 2. ASI-IP-GTW in a system

1.4 Summary of Features

Features of the ASI-IP-GTW include:

- o Transmission of MPEG-2 Transport Streams over Gigabit Ethernet.
- o MPTS/SPTS
- o Up to 8 DVB-ASI inputs/outputs
- o User configurable as transmitter or receiver
- o Flexible Forward Error Correction
 - o Increased robustness against network packet losses
- o End to end Quality of Service

- o Type of Service (TOS) field support for reliable end-to-end transmissions
- o User-friendly configuration and control
- o WEB/XML based remote control
- o Easy access to unit from any WEB browser
- o Easy integration to Network Management System (NMS) with SNMP Trap support

1.5 Guided Tour

1.5.1 The User Interface

All connectors are provided at the rear panel. Configuration and monitoring of the unit is performed via a FLASH-based WEB interface using a standard WEB browser such as Internet Explorer. The unit also supports configuration via file transfer of XML files. Once configured, the unit runs without the need for further intervention unless system configuration requirement change.

1.5.2 Front Panel Description

The front panel provides four LEDs per ASI-IP-GTW. Table 1 describes the meaning of the different LED indicators.

Table 1. Front panel LEDs

Indicator	Colour	Description
Power	Green	This LED is lit when power is being received by the unit.
Alarm	Red	This LED is lit when a failure is detected by the unit.
IP TX	Blue	This LED is lit when the unit is configured to transmit data to the IP Network.
IP RX	Yellow	This LED is lit when the unit is configured to receive data from the IP Network

1.5.3 Rear Panel Description

All connectors to the ASI-IP-GTW are provided at the rear panel. Figure 3 shows the rear panel of a ASI-IP-GTW equipped with 4 DVB-ASI connectors.

1. ASI. In IP TX mode, the connector provides a DVB-ASI input. In IP Rx mode, the connector provides a DVB-ASI output.

2. Management port. The ASI-IP-GTW provide one Ethernet port for control and management of the unit.

3. Ethernet data port. The ASI-IP-GTW provides one Ethernet data port for high speed signal transmission and reception.

4. Alarm/RS232 Connector. This 9-pin male D-SUB connector provides RS232 access and alarm information.

5. Technical Earth. The ASI-IP-GTW provide a Technical Earth.

6. Mains Power Connection. This is the Power Supply Connection.

Note: Some units are delivered to use 48 VDC power. These units have a 3-pin power D-SUB connector instead of the mains connector.

7. LEDs. The ASI-IP-GTW provides on the rear four LEDs related to the operation of the equipment. In addition, there are LEDs related to the ASI ports, the management port and the data port.

1.5.4 Construction

The ASI to IP Gateway consists of a main board and one or two ASI boards mounted horizontally in a screened, self-ventilated cabinet. The unit is 1RU high and two units can be mounted side-by-side in a 19 inch rack. All inputs and outputs are available at rear panel and there are no front panel keypads or display. Figure 3 shows the rear panel of the unit.

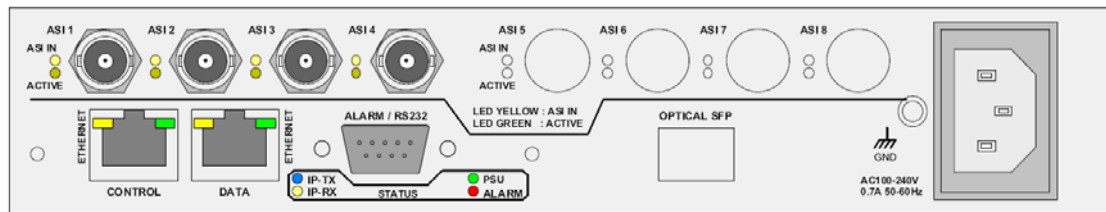

Figure 3. Rear view

1.5.5 Hardware Options

1.1.1.5 4 additional ASI ports

The ASI-IP-GTW is at least fitted with 4 ASI ports from factory. 1 to 4 of these inputs are enabled from factory. As an option, the unit can be fitted with an additional ASI module, providing 4 additional ASI ports, which gives a total of 8 ASI ports.

1.1.1.6 SFP Module

As a factory option, the ASI-IP-GTW can be equipped with an SFP slot to feature optical Gigabit or a second, redundant electrical Gigabit port. The SFP module itself is not provided.

1.1.1.7 GPS Module

As a factory option, the ASI-IP-GTW can be equipped with a sync signal input module. This module gives the ASI-IP-GTW the option to sync to either a 1pps or 10MHz signal.

1.1.1.8 SFP/GPS Module

As a factory option, the ASI-IP-GTW can be equipped with an SFP slot to feature optical Gigabit or a second, redundant electrical Gigabit port. The SFP module itself is not provided. This module also includes a 1pps input for use as a sync signal.

1.5.6 Software Options

The following table describes the features available as software option. Please refer to

Appendix D: Upgrade of Features for more information

Table 2. Functionality enabled through software licenses

Functionality	Max value	Description
Number of enabled ports	8	The number of ASI ports enabled. This can be different from the number of ports physically mounted.
Data port max. speed:	1000Mbit/s	The speed of the data port can be 100Mbit/s or 1000Mbit/s.
Connect Control	NA	Enabled supervision of the unit through the Connect software.
Forward Error Correction	NA	Pro-MPEG Forward Error Correction enabled for use on all streams.
Bi-directional operation	NA	Enables simultaneous transmission and reception of MPEG2 data on the Ethernet data interface.

2 Installing the Equipment

2.1 Introduction

2.1.1 Read this first!

The ASI-IP-GTW must be handled carefully and thoughtfully to prevent safety hazards and damage. Ensure that the personnel designated to install the unit have the appropriate skills and knowledge.

Follow the instructions for installation and only use installation accessories recommended by the manufacturer.

2.1.2 To inspect package content

- o Inspect the shipping container for damage. If your shipping container is damaged, keep the shipping container or cushioning material until you have inspected the contents of the shipment for completeness and have checked that the ASI-IP-GTW mechanically and electrically.
- o Verify that you received the following items and any optional accessories you may have ordered:
 - o ASI to IP Gateway
 - o Power cord
 - o User's manual

Note: 48V DC versions do not ship with a power cord, but a male Power D-SUB connector for soldering to the supply leads.

2.2 Installing the Equipment

2.2.1 Selecting a site for the equipment

The ASI-IP-GTW should not be placed where it will be a subject to extreme temperatures, humidity, or electromagnetic interference.

Specifically, the site you select should meet the following requirements:

- o The ambient temperature should be between 0 to 50 degrees Celsius (32 and 122 degrees Fahrenheit).
- o The relative humidity should be less than 90 percent, non-condensing. Do not install the unit in areas of high humidity or where there is danger of water ingress.
- o Surrounding electrical devices should not exceed the electromagnetic field (RFC) standards for IEC 801-3, Level 2 (3V/M) field strength.
- o Make sure that the equipment receives adequate ventilation. Do not block the ventilation holes on each side of the ASI-IP-GTW.
- o The power outlet should be within 1.8 meters (6 feet) of the ASI-IP-GTW.

- o Where appropriate ensure that this product has an adequate level of lightning protection. Alternatively, during a lightning storm or whenever it is left unattended and unused for long periods of time, unplug it from the supply outlet and disconnect the output equipment. This prevents damage to the product due to lightning and power-line surges.

Warning: If the Video Gateway has been subject to a lightning strike or the power surge which has stopped it working, disconnect the power immediately. Do not reapply power until it has been checked for safety. If in doubt, contact Network.

2.2.2 To fix the equipment

The ASI-IP-GTW is designed for stationary use. The ASI-IP-GTW is designed for installation in standard 19" racks. When installed in a rack, ensure that the unit is surely and safely installed and that the equipment has adequate through-flow of air.

2.2.3 To cable the equipment

Ensure that power supply cables are routed in such a way that they are not likely to be walked on or pinched by items placed upon or against them.

Do not run ac power cables and signal cables in the same duct.

2.2.4 Equipment access

The ASI-IP-GTW has connectors at the rear. When installing the unit, ensure that the unit is installed to allow easy access to the rear of the unit.

2.2.5 Ventilation

Warning: Never push objects of any kind into this equipment through openings as they may touch dangerous voltage points or short-out parts that could result in a fire or electric shock. Never spill liquid of any kind on or into the product.

Please observe the following:

1. Openings in the cabinet are provided for ventilation and to ensure reliable operation of the product and to protect it from overheating. These openings must not be blocked or covered. This product should never be placed near or over a radiator or heat register. This product should not be placed in a built-in installation such as a rack unless proper ventilation is provided or the instructions have been adhered to.
2. The fans contained in this unit are not fitted with dust/insect filter. Play particular attention to the environment in which it is to be used.
The ASI-IP-GTW should be installed to allow adequate flow of free-air. Ensure that the ventilation holes on each side of the ASI-IP-

GTW are not blocked and allow at least 50 mm free air-space at each side of the unit. The ASI-IP-GTW is designed to be stacked in 19"racks without ventilation panels between. In systems with stacked units, it may be required to use forced-air cooling to reduce the operating ambient temperature.

Figure 4 shows the air path through the unit.

There are two fans mounted,
at the left side of the unit seen from front

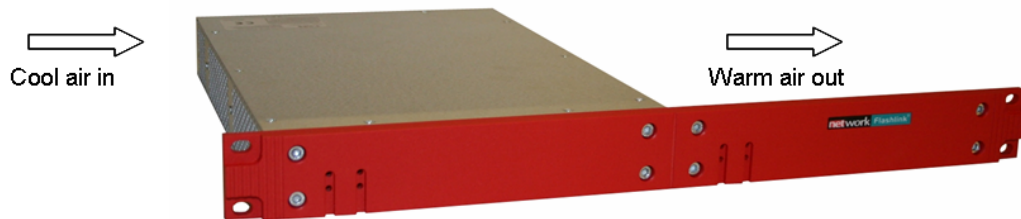

Figure 4. Air Path through the unit

2.2.6 To connect the equipment

Once the ASI-IP-GTW is installed in its intended operating position, it is ready to be connected to the rest of the system. The following figure shows the different equipment connections.

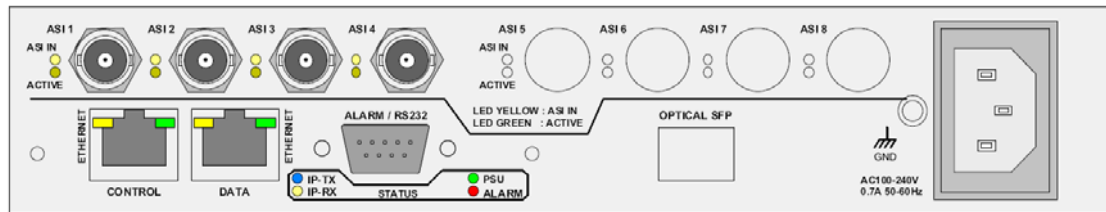

Figure 5. Signal connections

Remove mains supply previous to move or install the equipment. Ensure ESD precautions are observed whilst interconnecting equipment.

1.1.1.9 ASI port

The ASI-IP-GTW can be operated in three modes: IP Transmit, IP Receive, and IP bi-directional mode.

In IP transmit mode, the equipment receives up to 8 DVB-ASI streams and sends them to the IP network. In this mode, connect the individual DVB-ASI input signals to the connectors marked with ASI. If you have ordered the unit with less than 4 ASI ports, the enabled ports starts at number 1 up to the number of ports ordered.

In IP receive mode, the equipment receives an IP stream and sends the individual MPEG-2 transport streams out on the DVB-ASI connectors. In this mode, connect the DVB-ASI output to the input of the equipment to receive MEG-2 transport stream from the unit. If you

have ordered the unit with less than 4 ASI ports, the enabled ports starts at number 1 up to the number of ports ordered.

In IP bi-directional mode, half the DVB-ASI connectors are used as inputs, and the other half as DVB-ASI outputs. ASI connectors 1, 2, 5 and 6 are used as inputs, while ASI connectors 3, 4, 7 and 8 are used as outputs.

1.1.1.10 Ethernet data port

Connect the Ethernet data port to the network. In IP transmit mode, the ASI-IP-GTW will send an IP stream to the network. In IP receive mode, the ASI-IP-GTW will receive an IP stream from the network.

1.1.1.11 Power supply

Section 2.3 provides details of the power supply, protective earth and security. Read all these instructions, prior to connecting the unit to power mains.

1.1.1.12 Management port

The ASI-IP-GTW provides one Ethernet port for control and management. Connect the management port to the management network.

1.1.1.13 Technical Earth

Connect the Technical earth to a suitable earth point.

1.1.1.14 Alarm

The ASI-IP-GTW provides an alarm relay for connection to external alarm system.

2.3 Power

2.3.1 AC Power Supply

The ASI-IP-GTW provides a wide-ranging power supply covering a rate voltage range 100-240Vac, 50/60Hz. Please refer to

Appendix B: Technical Specification for a detailed specification of the AC power supply.

2.3.2 Power Cable and Protective Earth

Warning: This product should be operated only from the type of power source indicated on the marking label. Please consult a qualified electrical engineer or your local power company if you are not sure of the power supply to your business.

1.1.1.15 General

Ensure that the AC power cable is suitable for the country in which the unit is to be operated.

Warning: If the moulded plug fitted to the mains cable supplied with this unit is not required, please dispose of it safely. Failure to do this may endanger life as live ends may be exposed if the removed plug is inserted into a mains outlet.

Caution: Power supply cords should be routed so that they are not likely to be walked on or pinched by items placed upon or against them, paying particular attention to cords at plugs, convenience receptacles, and the point where they exit from the appliance.

The unit is supplied with a two meter detachable power supply cable equipped with the moulded plug suitable for Europe, UK or US.

The wires in the mains cable are coloured in accordance with the wire colour code shown in Table 3.

Table 3. Supply Cable wiring colours

	UK (BS 1363)	EUROPE (CEE 7/7)	USA (NEMA 5-15P)
Earth:	Green-and yellow	Green-and yellow	Green
Neutral:	Blue	Blue	White
Live:	Brown	Brown	Black

1.1.1.16 Protective Earth /Technical Earth

To achieve protection against earth faults in the installation, connected to the equipment by signal cables etc., the equipment should always be connected to protective earth. If the mains appliance coupler is disconnected while signal cables are connected to the equipment, earth connection should be achieved by connecting earth to the additional technical earth connection on the rear panel of the unit.

Warning: This unit must be correctly earthed through the moulded plug supplied. If the local mains supply does not have an earth conductor do not connect the unit.

Caution: Consult the supply requirements in

Appendix B: Technical Specification prior to connecting the unit to the supply.

The unit has a Technical Earth terminal located at the rear panel. Its use is recommended. This is *not* a Protective earth for electrical shock protection. The terminal is provided to:

1. Ensure all equipment chassis fixed in the rack are at the same Technical earth potential. To achieve this, connect a wire between the Technical earth terminal and a suitable point on the rack.
2. Eliminate the migration of stray charges when connecting between equipment.

Warning: If the terminal screw has to be replaced, use an M4x12mm long pozidrive panhead. Using a longer screw may cause a safety hazard.

1.1.1.17 Connecting the Video Gateway to the AC Power Supply

Warning: Do not overload wall outlets and extension cords as this can result in a risk of fire or electrical shock. As no power switch is fitted in this unit, ensure that the local ac power supply is switch off before connecting the supply cord. The unit is not fitted with an on/off switch. Ensure that the socket-outlet is installed near the equipment so that is easily accessible. Failure to isolate the equipment properly may cause a safety hazard.

To connect the unit to the local AC power supply:

1. Ensure that the local ac power supply is switch OFF.
2. Connect the ac power lead to the Video Gateway mains input connector and then the local mains supply.

2.3.3 Optional DC Power Supply

The ASI-IP-GTW can be delivered with a 48 VDC power supply for use in environments where this is required. The DC power can tolerate a voltage range of 36 – 72 VDC. Please refer to

Appendix B: Technical Specification for a detailed specification of the power supply.

Units delivered with DC power supply, has a 3-pin male power D-SUB connector in stead of the standard Mains Power Connector. Also a female 3-pin D-SUB connector is supplied.

The pin assignment is shown in Table 4.

Table 4 DC power connector pin assignment

Pin (placement)	Specification
1 (top)	+ (positive terminal)
2 (middle)	- (negative terminal)
3 (bottom)	Chassis Ground

To connect the unit to the local DC power supply:

1. Use a soldering tool to attach the supplied loose female power D-SUB connector to your power leads (not supplied).
2. Connect the power leads to your local power supply.
3. Connect the DC power connector, with attached power leads, to the Video Gateway power input connector.

2.4 Signal Connections

2.4.1 Introduction

All signal connectors are located at the rear of the ASI-IP-GTW. For detailed specifications of the different interfaces, please refer to Chapter 0. Please ensure that specified cables are used in order to ensure signal integrity and compliance with EMC requirements.

The following figure shows the back panel of the ASI-IP-GTW.

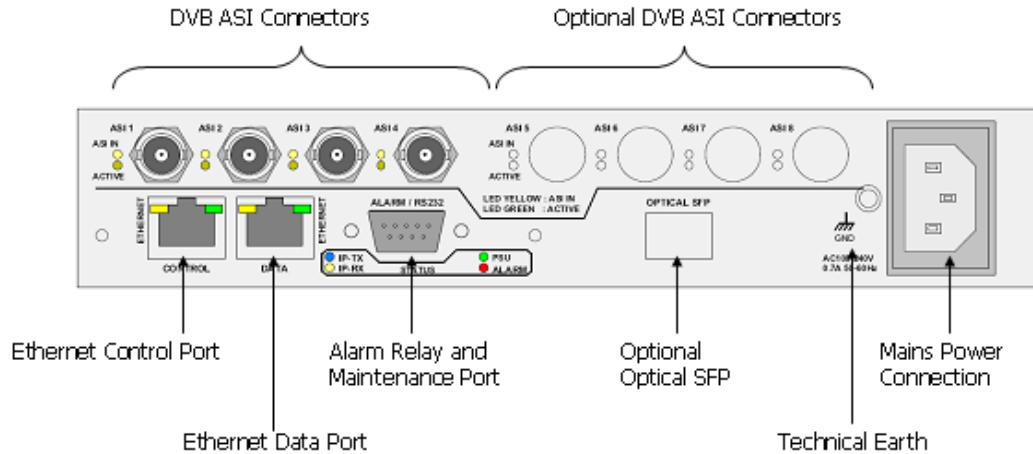

Figure 6. Rear panel connectors

2.4.2 ASI ports

The ASI-IP-GTW provides up to 8 DVB ASI ports. The unit can be delivered with 4 or 8 DVB ASI connectors. For the 4 ASI port version, 1, 2, 3 or all 4 ports can be enabled.

The operator can configure the unit as an IP transmitter, an IP receiver, or to IP bi-directional operation. In the IP transmitter mode, all enabled ASI ports are configured as DVB ASI inputs. In the IP receive mode, the ASI ports are configured as DVB ASI outputs. In IP bi-directional mode, half the DVB ASI ports are used as inputs, the other half as outputs (see 2.2.6)

Table 5. ASI ports

Item	Specification
Safety status	SELV
Type	Analogue
Connector name	ASI 1,2,3,..., 8
Connector type	BNC 75 ohm socket
Signal	Compliant with EN50083-9: 1998 Table B.1
Line rate	270Mbit/s
Data rate	0,1-213Mbit/s

1.1.1.18 DVB ASI input

Inputs connected to the DVB ASI ports should be on DVB compliant transport streams in asynchronous serial format.

Each DVB ASI connector has two LEDs associated with it; *ASI Rx* and *Active*. Both LEDs are lit when the ASI input is enabled and a DVB ASI stream is connected to the port. If the input is enabled, but no valid stream is connected to the port, only the ASI Rx LED is lit. If the ASI input is disabled none of the LEDs are lit.

1.1.1.19 DVB ASI output

When in IP receive mode, the ASI port will provide a DVB compliant transport stream. When no stream is received over the IP network, the output will be idle characters. If a stream is received, the output will be a combination of MPEG-2 transport stream data bytes and idle characters.

The ASI Rx is always unlit when the ASI port is configured as an ASI output. The LED, designated Active, is lit when the output is enabled and unlit when the output is disabled.

2.4.3 Ethernet data port

The Ethernet port provides an electrical Ethernet data port. The default interface is 100Base-T. As an option, the port can be operated as 1000Base-T. In this case the port can auto sense between 100 and 1000 Mbits/s. The operator is able to force the interface speed to fixed 100Mbit/s or fixed 1000Mbit/s. This is useful to minimize the synchronization time when reconnecting signal cables.

Table 6. Ethernet data port

Item	Specification
Type	10/100/1000Base-T
Connector type	RJ45

Two LEDs are associated with the Ethernet data port.

For flexibility, the ASI-IP-GTW provides an optional Small Form-Factor Pluggable (SFP) slot to carry a copper or optical SFP, allowing customers to use different SFPs for special distance, cost, existing infrastructure, and future expansion requirements. The ASI-IP-GTW is prepared for electrical (1000Base-T) or optical 1000BASE-SX and 1000BASE-LX SFP transceivers.

Table 7. Optional SFP Ethernet data port

Item	Specification
Type	Gigabit Ethernet, Small Form-Factor Pluggable (SFP) slot to carry copper or optical SFP, compatible with approved modules conforming to the Small Form-factor Pluggable Transceiver MultiSource agreements (Sept.14, 2000). Optical interface must comply with safety requirements IEC 60825 (Class 1) and 21 CFR 1040.10 & 1040.11 (Class 1).

Note: Please note that the optional SFP slot always provide Gigabit Ethernet. Other bitrates are not supported by the SFP slot.

Note: Please note that data will not be available simultaneously on the electrical Ethernet port and the SFP slot. Through the user interface the user selects on which port the data should be available.

2.4.4 Ethernet management port

The ASI-IP-GTW is provided with an Ethernet management port for configuration and control. The interface is 100Base-T. Please connect the management port to the appropriate LAN for configuration and control.

Table 8. Ethernet management port

Item	Specification
Safety status	SELV
Type	10/100Base-T
Connector type	RJ45

Two LEDs are associated with the Ethernet management port.

2.5 LEDs

The ASI-IP-GTW is equipped with 4 LEDs at the front. The following table describes the meaning of the front LEDs.

Table 9. Front panel LEDs

Indicator	Colour	Description
Power	Green	This LED is lit when power is being received by the unit.
Alarm	Red	This LED is lit when a failure is detected by the unit.
IP TX	Blue	This LED is lit when the unit is configured to transmit data to the IP Network.
IP RX	Yellow	This LED is lit when the unit is configured to receive data from the IP Network

The front LEDs are replicated at the rear panel.

Each ASI port has two LEDs associated with it.

Table 10. ASI port LEDs

Mode	ASI Rx	Active	Description
IP Tx	Unlit	Unlit	Input disabled (ASI input)
	Lit	Unlit	Input enabled, no ASI stream detected (not in sync)
	Lit	Lit	Input enabled, ASI stream detected (in sync)
IP Rx	Unlit	Unlit	Output disabled (ASI output)
	Unlit	Lit	Output enabled

Each Ethernet port (data and management) has two LEDs associated with it.

Table 11. Ethernet port LEDs

Traffic and link indicator	Description
Green	Lit when link
	Blinks when data is transmitted or received.
Speed indicator	Description
Unlit	10Mbit/s
Green	100Mbit/s
Yellow	1000Mbit/s

2.6 Powering Up/Down

2.6.1 Before Powering up

Before powering-up the unit, please check the following:

- o The unit is installed in a suitable location
- o The unit has been connected to external equipment as required

2.6.2 Powering Up

Power up the unit by inserting the power cable connected to a power source.

The cooling fans will start up in a full-speed mode. When the unit has finished the start-up procedure, the fans will run at normal speed. Please check that the all cooling fans are rotating. If they are not, switch of the unit immediately.

2.6.3 Powering Down

To power down the unit, remove the power supply connection at the rear of the unit.

3 Operating the Equipment

3.1 Introduction

The ASI-IP-GTW is configured and controlled locally and remotely through a flash-based WEB interface. The only application required on the computer to use this interface is a WEB browser (Internet Explorer, Mozilla or Opera) and FLASH player 7.0. In order to connect to the user interface of the ASI-IP-GTW only enter the IP address of the management data port. The default IP address of the management port is 10.0.0.10. Please refer to Section 3.2 for information about how to change the IP address of the management port using the RS232 connection.

Note: FLASH player 7.0 or newer is required to use the WEB interface of the ASI-IP-GTW.

If you don't have FLASH player 7.0 or newer installed on your computer, this will be detected and you will be informed to install this prior to configuring the ASI-IP-GTW.

Note: It is recommended to use Internet Explorer 6.0 or newer.

The ASI-IP-GTW can be configured to transmit MPEG2 transport stream data over an Ethernet link or receive data from an Ethernet interface. In IP transmit mode (IP TX), up to 8 DVB ASI inputs are provided. In IP receive mode (IP RX), up to 8 DVB ASI output streams are provided. An optional mode for bi-directional operation (IP-TXRX) is available, where half the DVB ASI ports are used as inputs, and the other half as outputs.

3.2 Changing the IP address of the unit

The ASI-IP-GTW is configured with IP address 10.0.0.10 for the management port. There are two ways to change the IP address of the management port:

1. Connect from a WEB browser and use WEB-interface to set IP address of management port (See section 3.5.1).
2. Connect via RS232 via HyperTerminal (115200kb/s, 8, N, 1, no flow control). Type the following command:

```
net ipconfig --ip (ip address) --mask (subnet mask) -  
-gw (gateway).
```

Example:

```
net ipconfig --ip 10.40.80.100 --mask 255.255.255.0 -  
-gw 10.40.80.1
```

This will result in the IP address 10.40.80.100. The subnet mask is set to 255.255.255.0 and the default gateway to 10.40.80.1.

3.3 Looking at the WEB interface

Figure 7 shows the Status page of the WEB-based user interface to the equipment.

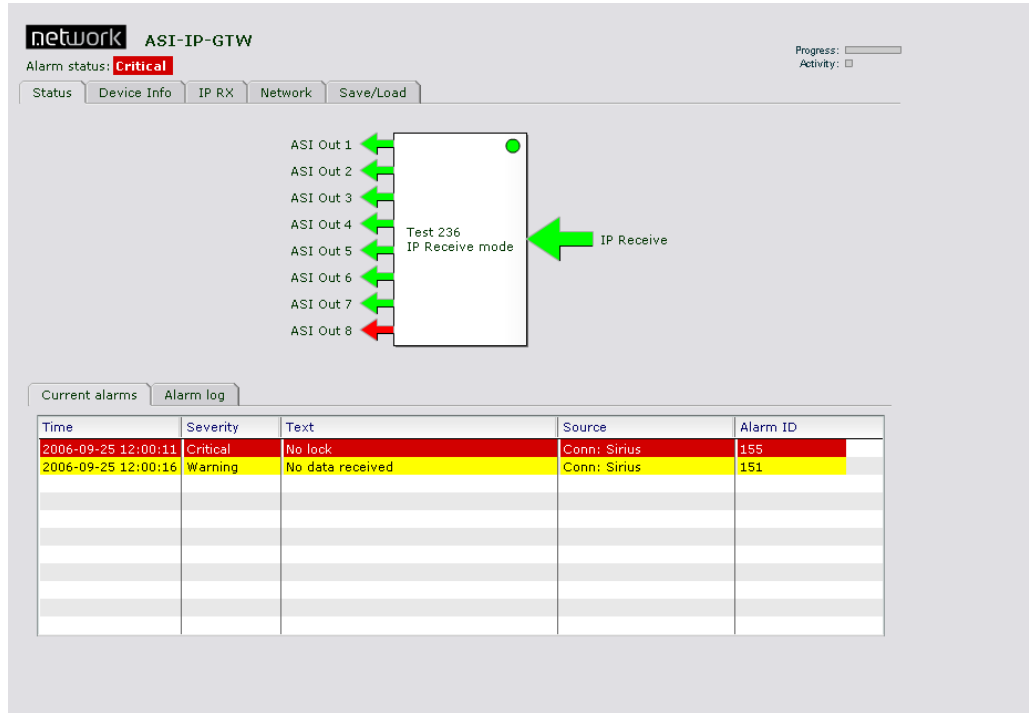

Figure 7. The overall status page

Overall status: The top part of the page is the same for all pages. The type name of the product is given. In the upper left corner two bars are presented. The first is the progress bar which will show the progress of an action started, e.g. the download of a new parameter set. The activity bar will light every time the computer is requesting or sending data to the ASI-IP-GTW. Under normal operation, the activity bar shall twinkle regularly.

Main menus: The WEB-based user interface of the ASI-IP-GTW consists of the following main pages: Status, Device Info, IP TX/IP RX, Network and Save/Load. Some of the main pages have a number of sub-pages. The following table gives an overview of the different pages.

Main tab (page)	Sub-tab	Description
Status	Current alarms	The current status of the unit is shown. The page shows pending alarms together with information about when the alarm appeared and the severity level of the alarm.
	Alarm log	The alarm log shows past alarms. Current alarms are not shown on alarm log.
Device Info		This gives information about the serial number and software version of the unit. In addition, the user can assign a name to the unit. The user can also change the operation mode (IP Transmit , IP Receive or both) or manually reset the device from this page.
	Network	This is where IP address, subnet mask and default gateway is defined for management interface and data interface. In addition, for the data interfaces, the Advanced tab provides configuration of in-band management. The SFP tab provides information about the SFP.
	Time settings	Set SNTP server address. Current time is shown if valid SNTP server is already defined.
	Alarms	Provides a list of all alarms and configuration of severity level for the alarm events.
	SNMP	Set Trap Destination Servers.
	Ping	A page offering an interface to check for connectivity by pinging a remote host.
	Security	Enable or disable password protection, and change password.
	RIP-2	Show status, and change parameters for the Routing Information Protocol
IP TX		This is where each input is configured
	Main	This is where the main parameters of each input are configured. In addition, status of each stream is shown.
	FEC	This is where the FEC parameters are configured.
	Ethernet	This is where VLAN tagging, and Static MAC is configured.
	Ping	This is where Ping parameters for the IP channel is configured.
IP RX		This is where the outputs are configured.
	Main	This is where the main parameters of the outputs are configured.
	FEC	This is where the FEC parameters are configured.
	Ethernet	This is where VLAN tagging, and Static MAC is configured.
	Ping	This is where Ping parameters for the IP channel is configured.
	Advanced	Advanced parameters related to buffer regulator.
Network		Overview of IP addresses UDP ports and bitrates.
Save/Load		Save and load of configurations.

To select a page, just click on the tab of the page you want to view.

In order to activate a change in a parameter, you need to click the Apply button. The refresh button, will read back all parameters on the page from the unit.

3.4 Status

Figure 7 shows the overall status of the unit. This view shows a unit in IP receive mode. In this view a block diagram of the unit with ASI outputs and IP port is shown. The unit name and the mode are illustrated.

Only licensed ASI ports are shown in the diagram. Each port is represented by an arrow indicating its direction, and the arrow is coloured depending on the status of the port: red on alarm, yellow on warning, green when OK and grey when the input is disabled from software. Each ASI port arrow is clickable, linking to the parameter sets for that port. The IP port arrow links to the Network page.

The small circle in the body of the diagram shows the highest alarm level for internal alarms, i.e. alarms that are not associated with an input or an output port.

The lower part of the page shows a current alarm table. Each line is associated with a current alarm condition. The line is coloured with the severity of the alarm; red when critical alarm and yellow for warning. The current alarm table contains the following information:

Time: The time when the alarm appeared.

Severity: The severity level of the alarm event. This can be Critical or Warning.

Text: This gives a description of the alarm condition.

Source: This parameter describes which module as created the alarm.

Alarm ID: Each alarm condition has an alarm ID associated. This is a number. A detailed overview of the alarm conditions is given in section 5.2.6.

3.5 Device Info

Figure 8 shows the Device Info page.

The screenshot displays the 'Device Info' page for an ASI-IP-GTW device. At the top, there is a 'network' logo and the device name 'ASI-IP-GTW'. Below this, the alarm status is 'OK'. There are tabs for 'Status', 'Device Info', 'IP RX', 'Network', and 'Save/Load'. The 'Device Info' tab is active. Below the tabs are 'Apply' and 'Refresh' buttons. The main content area is divided into two sections: 'Product Information' and 'Management Interface'. The 'Product Information' section includes fields for Name (Test 236), Internal temp. (58°C / 136°F), Mode of operation (ASI <-- IP), Product type (ASI-IP-GTW), Serial number (1220), Software version (1.3.17), and Software build time (2006-09-22 12:15:35). There is a 'Flash Power LED' button and a 'Reset Device' button. The 'Management Interface' section is further divided into 'Management Interface' and 'Data Interface'. The 'Management Interface' section includes fields for IP address (10.40.81.236), Subnet mask (255.255.255.0), Default gateway (10.40.81.1), Speed/duplex mode (Auto: 10/100 Mbps), and MAC address (00:14:57:00:01:26). The 'Data Interface' section has tabs for 'Main', 'Advanced', and 'SFP'. The 'Main' tab is active and includes fields for IP address (11.0.0.39), Subnet mask (255.255.255.0), Default gateway (11.0.0.2), Media select (Built-in RJ-45), Speed/duplex mode (Auto: 10/100/1000 Mbps), and MAC address (00:14:57:00:01:27).

Figure 8. The device info page

The upper part of the Device Info page contains product information. This includes the following parameters:

Name: The name of the unit configured by the user.

Product type: ASI-IP-GTW

Serial number: A number which uniquely identifies the unit.

Software version: The version number of the software running on the unit.

Software build time: The time and date when the software was compiled.

Internal temperature: The internal temperature of the unit shown in degrees Celsius and Fahrenheit.

Flash Power LED: When this button is pressed, the power LEDs on rear and front of unit will flash for a short period. This functionality can be used to identify a unit in a rack.

Mode of Operation: Select 'ASI --> IP' for *IP transmit mode*. In this mode the ASI connectors operate as inputs, and the MPEG2 transport streams on these can be transmitted on the Ethernet port.

Select 'ASI <-- IP' for *IP receive mode*. In this mode, the ASI connectors operate as outputs, and transport streams can be mapped from the Ethernet port to the ASI outputs.

When the bi-directional feature is enabled, a third option 'ASI <--> IP' is available to operate half of the ASI connectors as inputs and the other half as outputs.

Note that a mode switch requires a device re-boot, this is done automatically when pressing OK in the confirmation window that is displayed when a new mode is selected.

Reset device: Press this button to perform a soft reset of the device. An alert is displayed, with an option to cancel, before the reset message is sent to the box.

On the lower part of the Device info page, three sub-pages are available: Network, Time settings and Alarms.

3.5.1 Network

On Network sub-page the management interface and the Ethernet data interface is configured. For each of the interfaces the following information is configured:

1.1.1.20 Main

IP address: The IP address entered as four decimal triplets separated by decimal points (full stop/period) e.g. 10.40.81.120.

Sub mask: The subnet mask entered as four decimal triplets separated by decimal points (full stop/period) e.g. 255.255.255.0.

Default gateway: The IP address of the default gateway entered as four decimal triplets separated by decimal points (full stop/period) e.g. 255.255.255.0.

Speed/duplex mode: The speed and mode of the management interface: Auto 10/100Mbps, Auto 10Mbps, Fixed 100Mbps-full duplex, Fixed 10Mbps-full duplex, Fixed 100Mbps-half duplex and Fixed 10Mbps-half duplex.

Remark that switching to a mode that is not compatible with the peer side may cause you to loose connection with the device. Remark also that in the fixed modes, the auto straight-through or crossover cable detection is disabled, so you have to use the right type of cable.

MAC address: The MAC address is displayed.

For the Data interface the following is also possible to configure the following on the main tab:

Media select: This field is only shown if the unit is equipped with an optional SFP slot. Select "Built-in RJ-45" to use the data port marked Data for data traffic. Select "SFP" to use the SFP module for data traffic.

Speed/duplex mode: The speed of the data interface: Auto 10/100/1000Mbps, Auto 10/100Mbps, Auto 10Mbps, Fixed 1000Mbps-full duplex, Fixed 100Mbps-full duplex, Fixed 10Mbps-full duplex, Fixed 100Mbps-half duplex and Fixed 10Mbps-half duplex.

Furthermore the same remarks apply as for the management port.

1.1.1.21 Advanced

The advanced sub-tab of the Data interface allows configuration of in-band management.

The screenshot displays the web interface for an ASI-IP-GTW device. At the top, the 'network' logo and 'ASI-IP-GTW' title are visible. The 'Alarm status' is 'OK'. Below the title bar are tabs for 'Status', 'Device Info', 'IP RX', 'Network', and 'Save/Load'. The 'Network' tab is active, and the 'Data Interface' sub-tab is selected. The 'Data Interface' section is divided into 'Main' and 'Advanced' sub-tabs, with 'Advanced' currently selected. The 'Management Interface' section shows fields for IP address (10.40.81.236), Subnet mask (255.255.255.0), Default gateway (10.40.81.1), Speed/duplex mode (Auto: 10/100 Mbps), and MAC address (00:14:57:00:01:26). The 'Data Interface' section includes checkboxes for 'Allow ping response' (checked), 'Allow in-band management' (unchecked), and 'Use as default management interface' (unchecked). The IGMP version is set to 2. Other visible fields include Name (Test 236), Internal temp. (56°C / 133°F), Mode of operation (ASI <-- IP), Product type (ASI-IP-GTW), Serial number (1220), Software version (1.3.17), and Software build time (2006-09-22 12:15:35). Buttons for 'Apply', 'Refresh', 'Flash Power LED', and 'Reset Device' are also present.

Figure 9. The device info, network and advanced sub-page

Allow ping response: Tick this box to filter incoming ICMP messages. If this option is not enabled, the device will not answer to ping requests on the data port.

Allow in-band management: Tick this box to allow management traffic on the data port.

Use as default management interface: Tick this box to use the data port as the default management interface. Enabling this option will force management traffic to IP addresses not matching either of the sub-nets of the two interfaces, to the data interface. Note that this means you will only be able to reach the device through the management interface if you are located at its sub-net.

Multicast router: The IP address of the multicast router. The address here is used in conjunction with the “use multicast router” option on the IP TX page. (see chapter 3.6.1). This parameter is only showed on units configured for IP transmission.

IGMP version: The default IGMP version to use. This parameter is only showed on units configured for IP reception. There is limited support for IGMP version 2 and 3. IGMP version 3 is limited to INCLUDE mode, one source only per channel, with no automatic fallback to IGMP version 2.

1.1.1.22 SFP

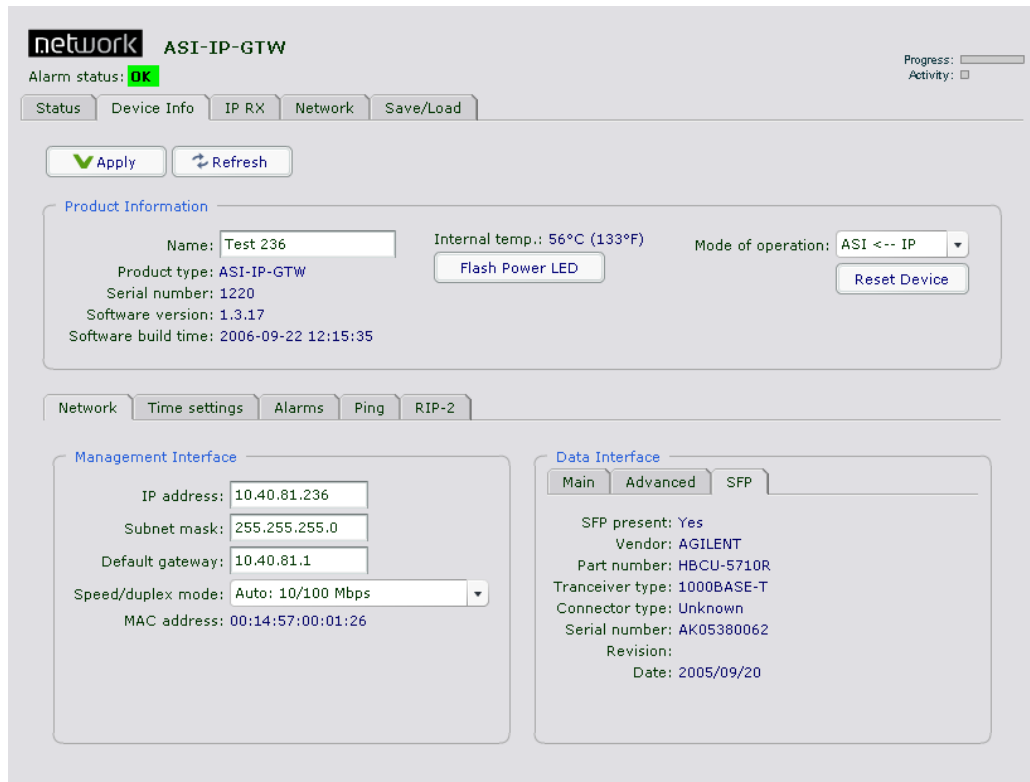

Figure 10. The device info page, Network and SFP sub-page

This sub-page is only shown if the unit is equipped with an SFP slot. The page displays information provided by the SFP module installed.

3.5.2 Time settings

Figure 11 shows the sub-page for time setting used for alarm reports.

The screenshot shows the 'Time settings' sub-page of the ASI-IP-GTW web interface. At the top, the 'network' logo and 'ASI-IP-GTW' title are visible. The 'Alarm status' is 'OK'. Below the title bar, there are tabs for 'Status', 'Device Info', 'IP RX', 'Network', and 'Save/Load'. The 'Network' tab is selected. There are 'Apply' and 'Refresh' buttons. The 'Product Information' section shows: Name: Test 236, Internal temp.: 56°C (133°F), Mode of operation: ASI <-- IP, Product type: ASI-IP-GTW, Serial number: 1220, Software version: 1.3.17, and Software build time: 2006-09-22 12:15:35. There are 'Flash Power LED' and 'Reset Device' buttons. Below this, there are tabs for 'Network', 'Time settings', 'Alarms', 'Ping', and 'RIP-2'. The 'Time settings' tab is selected. The 'Settings' section shows: Current time: 2006-09-25 15:01:52+02:00, Time zone: UTC+02:00, Clock source: SNTP, and SNTP server address: 10.1.6.11. At the bottom, there is a date and time display: Date: 25 Sep 2006, Time: 14 : 59 : 59, and a 'Manual Update' button.

Figure 11. Time setting sub-page

Current time: This shows the current time used by the unit. The time is displayed in local time with an indication of the local time zone relative to UTC.

Time zone: Here it is possible to configure the local time zone to operate in. The time zone is specified in hours offset to UTC. All time stamps in the GUI are displayed in local time. If you switch time zone during operation, the alarm log entries will also be updated to reflect the new time zone. The alarm log export option prints the time zone at the time of the export at the top of the log.

Clock source: Select the synchronizing source for the device real time clock. The options are *SNTP* and *Internal*. In *SNTP* mode the clock is retrieved from a specified server, in *Internal* mode the clock is maintained locally by the device. Remark that the clock value is not kept after a reboot when running in *Internal* mode. To synchronize the alarm logs on several devices it is recommended to use a *SNTP* server.

SNTP server address: The IP address of the *SNTP* server entered as four decimal triplets separated by decimal points (full stop/period) e.g. 10.40.81.10. An example on a *SNTP* server is the Windows Time Service built into the MS Windows operating system. The *SNTP* protocol runs on UDP port 123, which must be let through in eventual firewalls.

Manual Update: Enter the wanted date and time and press this button to set the clock manually. Remark that if you are running in SNTP mode and the device receives answers from the time server, the time value will be overwritten. The manual update button only updates the clock value, to configure time zone, clock source and SNTP server address you have to press the Apply button at the main tool bar.

3.5.3 Alarms

The alarm page contains a list of all alarm events that can be displayed by the unit.

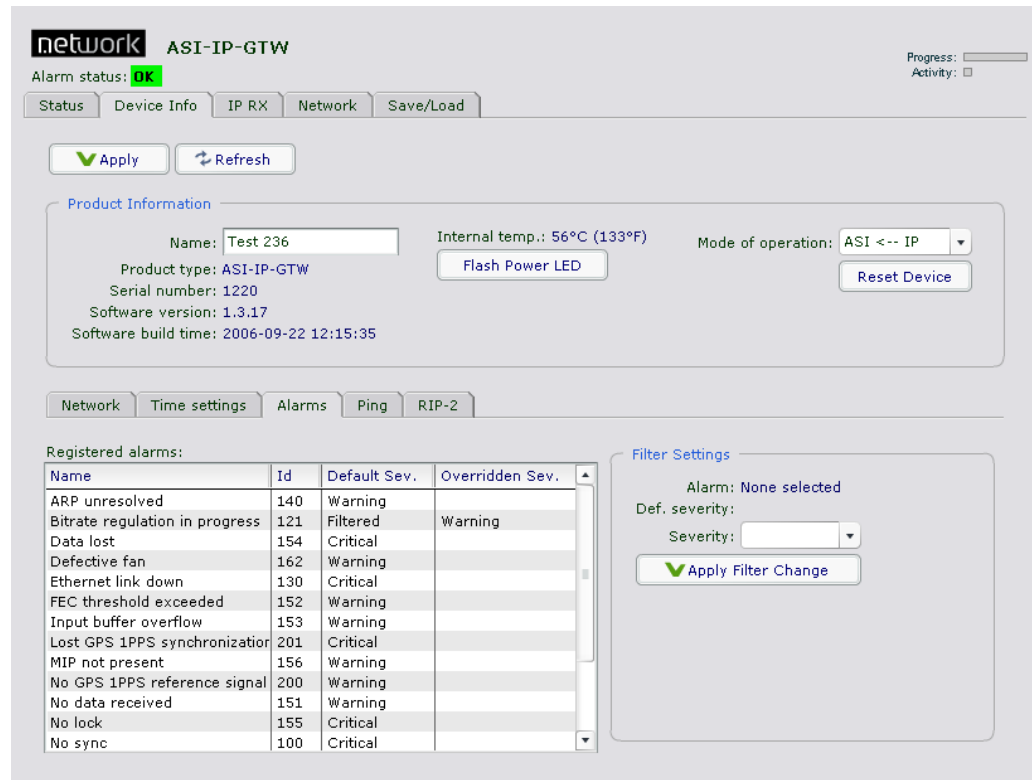

Figure 12. Alarm sub-page

In order to change the severity level of an alarm event, select the alarm event in the left table and the selected event will appear in the "Filter Settings" frame. Select the severity level (Filtered, Warning or Critical) from the list and press "Apply Filter Change" to change the severity level. The severity level is reflected in the user interface and in the SNMP traps sent by the unit.

The default severity level is shown in the "Default sev." column and the current severity level if different from default is shown in the "Overridden sev." column.

3.5.4 SNMP

The SNMP page allows configuration of the SNMP Trap Servers that the unit should send SNMP traps to.

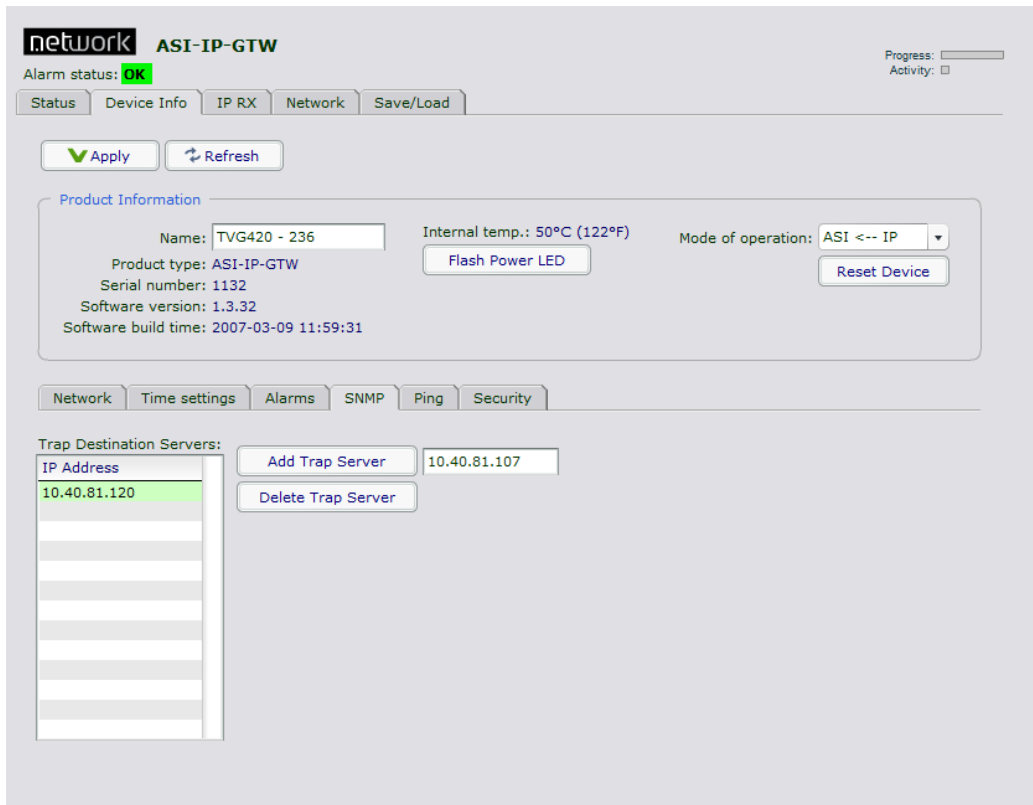

Figure 13 SNMP tab

Trap Destination Servers: A list containing the IP-addresses of all the current receivers of SNMP trap messages.

Add Trap Server: Clicking this button adds the IP-address from the neighbouring IP input field to the list of trap servers. If you haven't entered an address or if the IP-address is already in the list you will get an error message.

Delete Trap Server: This button is only enabled if you have selected a trap server in the "Trap Destination Servers" list. Clicking the button deletes the currently selected server from the list. A confirmation dialog will appear to make sure you really want to delete it. Clicking ok will confirm the deletion.

3.5.5 Ping

The ping page can be used to check for connectivity between devices. It is especially useful to ping the receiving data port from the IP transmitter to see if the receiver can be reached. Figure 14 shows the Ping page with its parameters.

Figure 14 Ping tab

IP destination: Enter the IP address to check for contact here. The ping messages will be routed to the matching Ethernet port, either data or management, or to the port configured as default management interface if the specified IP address does not match either of the two sub-nets. Remark that if you are pinging between data interfaces, the 'allow ping response' option on the network page advanced tab (see ch 3.5.1) must be enabled on both the transmitter and the receiver.

TTL (Time to live): Enter the Time to Live value for the ping messages here. The time to live value is a field in the IP protocol header that is decremented once for each router that the diagram passes. When the count reaches 0, the diagram is discarded. You can use this to check the number of routers from the transmitter to the receiver by starting with a low value and increment it until answers are received. TTL is also specified for each data channel on the IP transmitter, and must be high enough to reach the receiver. Values range from 1 to 255.

Ping count: The number of messages to send. The messages are transmitted with an interval of about 1 second.

Start: Press this button to start the ping sequence configured above. The status of the ping sequence is displayed in the status frame at the right side. Status values are reset on pressing the start button. After

pressing the start button the label switches to *Stop*, and the button can be pressed again to cancel the ping sequence.

OK responses: The number of successful answers received.

Timeouts: The number of ping requests that were not answered. If the timeout counter is incrementing while the OK responses counter is zero, there is no contact with the specified IP address.

Last: The round trip time measured for the last request in units of milliseconds.

Average: The average round trip time measured for the ping requests in this session. Value is reset every time the start button is pressed.

Min: The fastest round trip time registered for the ping requests in this session.

Max: The slowest round trip time measured for the ping requests in this session.

Remaining: The number of remaining ping requests in this session.

3.5.6 Security

Figure 11 shows the sub-page for user security (password protection).

The screenshot shows the web interface for the ASI-IP-GTW device. At the top, there is a header with the 'network' logo and 'ASI-IP-GTW'. Below this, the alarm status is shown as 'OK'. There are navigation tabs for 'Status', 'Device Info', 'IP TX', 'Network', 'GPS', and 'Save/Load'. The 'Security' tab is selected. The main content area is divided into two sections: 'Settings' and 'Change Password'. In the 'Settings' section, there is a checkbox for 'Enable password protection'. In the 'Change Password' section, there are input fields for 'Old password', 'New password', and 'Retype new password', along with a 'Change password' button. The 'Product Information' section shows details like 'Name: IP TX Boks', 'Internal temp.: 59°C (138°F)', 'Mode of operation: ASI --> IP', and a 'Reset Device' button.

Figure 15. Time setting sub-page

Enable Password Protection: Mark this to enable password protection. If password is not set, it will use the factory default password.

Factory default:

Administrator login: **admin**

Password: **salvador**

Old Password: To be able to set a new password, the user must know the old password.

New Password: Type the new password. Allowed length is 0 to 20 characters.

Retype New Password: Retype the new password as a security measure.

Change Password: Click this button to activate the new password.

Note: If you forget the password that has been configured, you will need to log on to the unit through the RS232 port. When you are logged on, type "userdb factory_defaults". This will reset the password to the factory defaults detailed above.

3.6 IP TX

Figure 16 shows the IP TX page. The purpose of this page is to provide an interface for configuring the different streams to be sent through the unit.

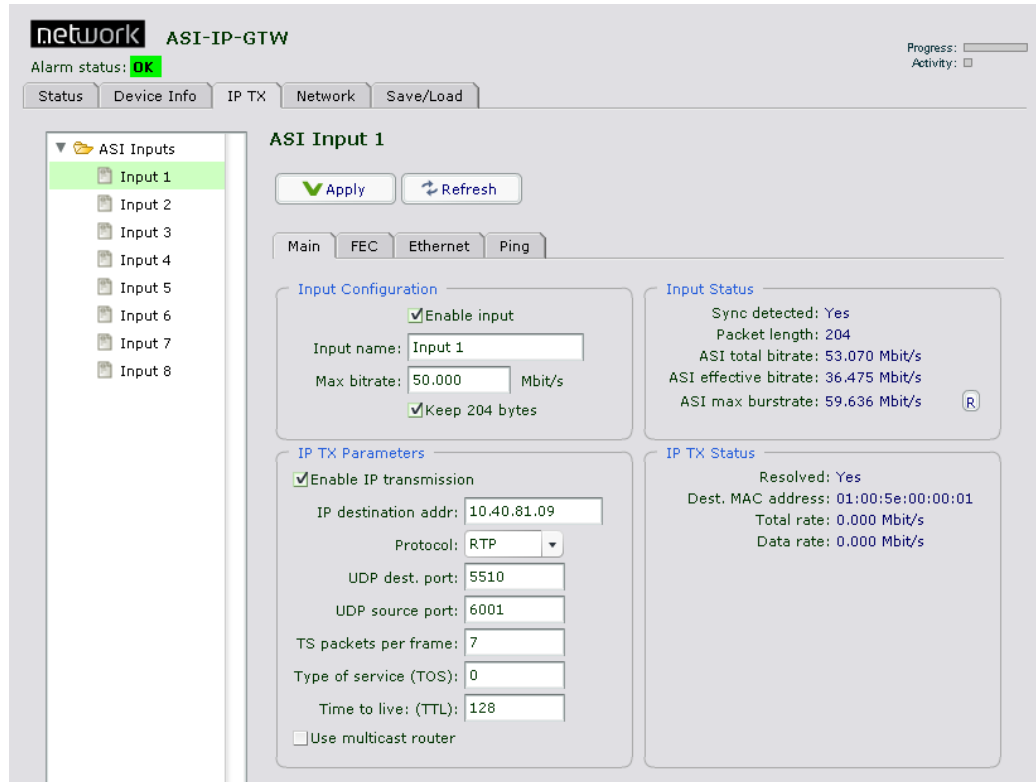

Figure 16. IP TX page

The left part of screen shows a tree containing all the DVB ASI input ports. To select a port, click that port. The information to the right of the page shows the IP transmission parameters for the selected port.

3.6.1 Main

The IP TX main sub-page is where you configure most of the parameters related to a stream to transmit over the IP network.

1.1.1.23 Input Configuration

Enable input: Tick this box to enable an input. If this is not ticked, you will not receive any MPEG-2 transport stream on this ASI input. The input port will be grey in the status view (See Section 3.4.)

Input name: Enter a name reference to an ASI input stream.

Max bitrate: Enter the maximum bitrate the ASI input stream is allowed to use. If the ASI input stream exceeds this bitrate, some data in this stream is discarded to keep its bitrate lower than the maximum bitrate setting. This prevents, when set correctly, one ASI stream from maxing out the IP channel, and thus disrupting all streams present on the IP channel. The sum of 'Max bitrate' for all active channels should not exceed the IP channel bandwidth.

Keep 204 bytes: Tick this box to transparently transmit all 204 bytes of the incoming ASI transport stream, if present. When only 188 byte packets are received or the box is unchecked, only 188 bytes of each transport stream packet is transmitted.

1.1.1.24 Input Status

Sync detected: Yes if the unit is receiving a valid DVB ASI stream on the ASI input interface. No if no DVB ASI stream is received.

Packet length: Shows the packet length of the MPEG2 transport stream packets received (188 or 204 bytes).

ASI total rate: Shows the bitrate of the MPEG2 transport stream on the input including NULL packets.

ASI effective rate: Shows the effective bitrate of the MPEG2 transport stream on the input i.e. bitrate excluding NULL packets.

1.1.1.25 IP TX Parameters

Enable IP transmission: Click this box to enable the MPEG-2 transport stream on the DVB ASI input to be sent through the IP network.

Protocol: Select UDP or RTP transmission mode. See 5.3.1 for more information on this

IP destination addr: Enter the destination IP address to use when transmitting data on the stream. The address may be either a unicast address or a multicast address.

UDP dest. port: Enter the UDP destination port to use when transmitting data on the stream. The UDP destination port is used by the receiver to separate one stream from another. UDP port numbers are in the range 1-65535.

Warning: Please ensure that there is no conflict in UDP ports in use. Pay special attention to the fact that FEC data are always sent on UDP port two higher than the media port and four higher than the media port, e.g., if UDP destination port is 5510, column FEC UDP port is 5512 and row FEC UDP port is 5514.

UDP source port: Enter the UDP source port to be used in the outgoing UDP frames for the current stream. UDP port numbers are in the range 1-65535. (Note that the ASI-IP-GTW receiver unit does not check this parameter when receiving streams)

FEC streams are transmitted with the same UDP source port as the media frames.

TS packets per frame: Enter the number of 188 byte MPEG-2 transport stream packets to map into each UDP frame. Valid values are between 1 and 7. We generally recommend using 7 when ASI-IP-GTW is used both at the sender and the receiver to reduce overhead. For very low bitrate streams, less than 7 packets per frame may be used to reduce the delay through the unit.

Type of service (TOS): Enter Type of Service parameter as a byte value to be set in the Type-of-Service (TOS) field in the IP header as specified in RFC-791. This parameter is used for Class-of-Service prioritization. It depends on the Routers honouring this field. Please refer to “Appendix F: Quality of service – Setting Packet priority” for further details.

Time to Live (TTL): Enter Time to Live parameter as a byte value to be set in the Time to Live (TTL) field in the IP header as specified in RFC-791.

Use multicast router: Click this box, to enable use of multicast router. The address of the multicast router is the same for the entire unit and is configured in the Network sub-page of the Device Info page. When this option is enabled, the MAC address used when configuring a multicast destination IP address, will be resolved to the IP address of the multicast router. If not using the multicast router option, multicast addresses automatically resolve to dedicated multicast MAC addresses.

1.1.1.26 IP TX Status

Resolved: Yes, when the MAC address of the configured IP destination address is resolved. The parameter is always yes, when multicast is used without using multicast router. No, when the MAC address is not yet resolved by ARP lookup.

Destination MAC address: Shows the destination MAC address used for the stream. This may be the MAC address of the receiving unit or the gateway if the receiving unit is on another network).

If using a multicast destination IP address without enabling multicast router, the field shows the multicast MAC address corresponding to the configured IP address. In the case of multicast router, the MAC address resolved for the multicast router is shown.

When the address is still not resolved this field displays the value 00:00:00:00:00:00.

Total bitrate: The bitrate of the IP frames containing this MPEG-2 transport stream and any FEC data related to this stream.

Data bitrate: The bitrate of the IP frames containing this MPEG-2 transport stream, excluding FEC information.

3.6.2 FEC Settings

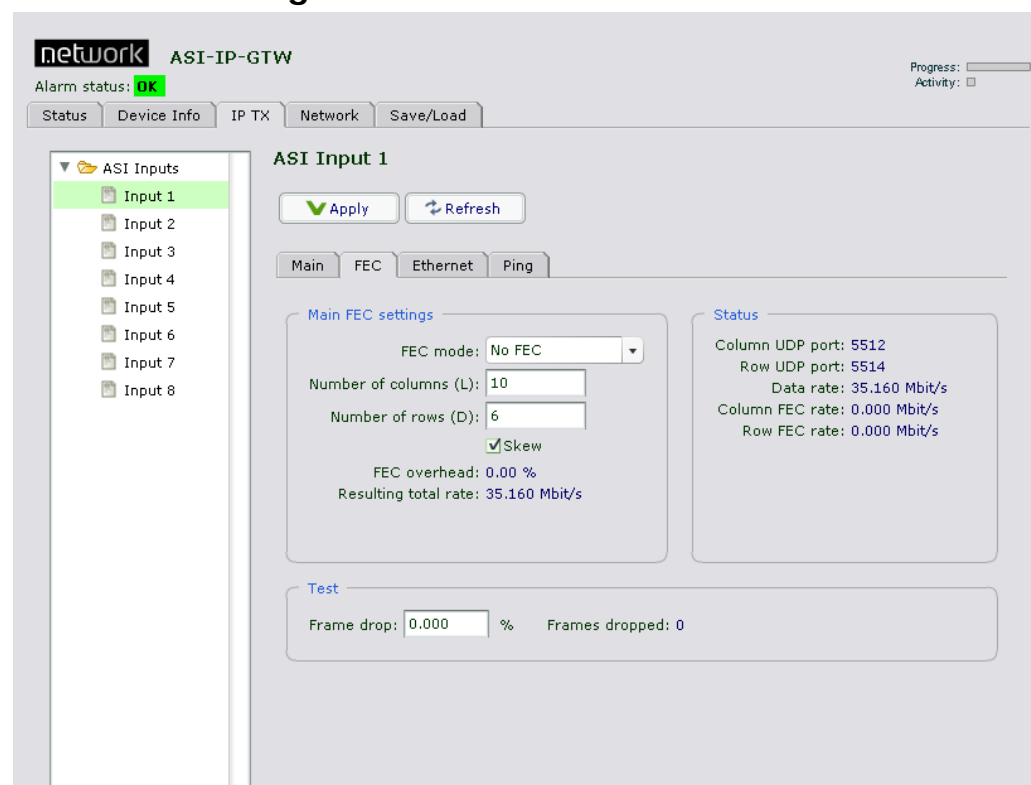

Figure 17. IP TX FEC page

This sub-page will only appear if the unit is enabled with FEC.

FEC Mode: Select "No FEC" to not calculate and send any FEC data. Select "Column only" to calculate and send one-dimensional FEC data. Select "Column and Row" to calculate and send two-dimensional FEC data.

Number of columns (L): Enter number of columns.

Number of rows (D): Enter number of rows.

Note: Please note that the maximum matrix size is 256 (L*D) and that D is in the range $4 \leq D \leq 32$. In column only mode L is in the range $1 \leq L \leq 32$, while in column and row mode $4 \leq L \leq 32$. L+D can not exceed 32.

Note: Please note that FEC column packets are transmitted on UDP port n+2 and FEC row packets are transmitted on UDP port n+4 where n is the UDP port of the media data. This is in accordance with Pro-MPEG CoP 3.

Skew: Controls whether to organize the column FEC with or without skew. When enabling skew, the delay required on the receiver is less than when transmitting straight columns.

FEC overhead: This number is the overhead in percent caused by the current FEC configuration.

Resulting total rate: This is the resulting total IP bitrate including FEC overhead for this channel. The Status frame contains status parameters related to the FEC setting.

Column UDP port: This parameter is the UDP port used for the column FEC data. The value is always Media UDP port + 2 which is in accordance with Pro-MPEG CoP 3.

Row UDP port: This parameter is the UDP port used for the row FEC data. The value is always Media UDP port + 4 which is in accordance with Pro-MPEG CoP 3.

Data rate: This parameter shows the IP data rate for this channel excluding FEC data.

Column FEC rate: This parameter shows the IP data rate for the column FEC data of this channel.

Row FEC rate: This parameter shows the IP data rate for the row FEC data of this channel.

In order to make it possible to demonstrate the function of the FEC engine, ASI-IP-GTW provides a mode to drop IP packets on the transmitter.

Frame drop: Enter the percentage of packets to be dropped from this channel. This value is not stored in the unit and must be entered after each power on.

Frames dropped: This counter shows the number of frames discarded at the output of the unit.

3.6.3 Ethernet Settings

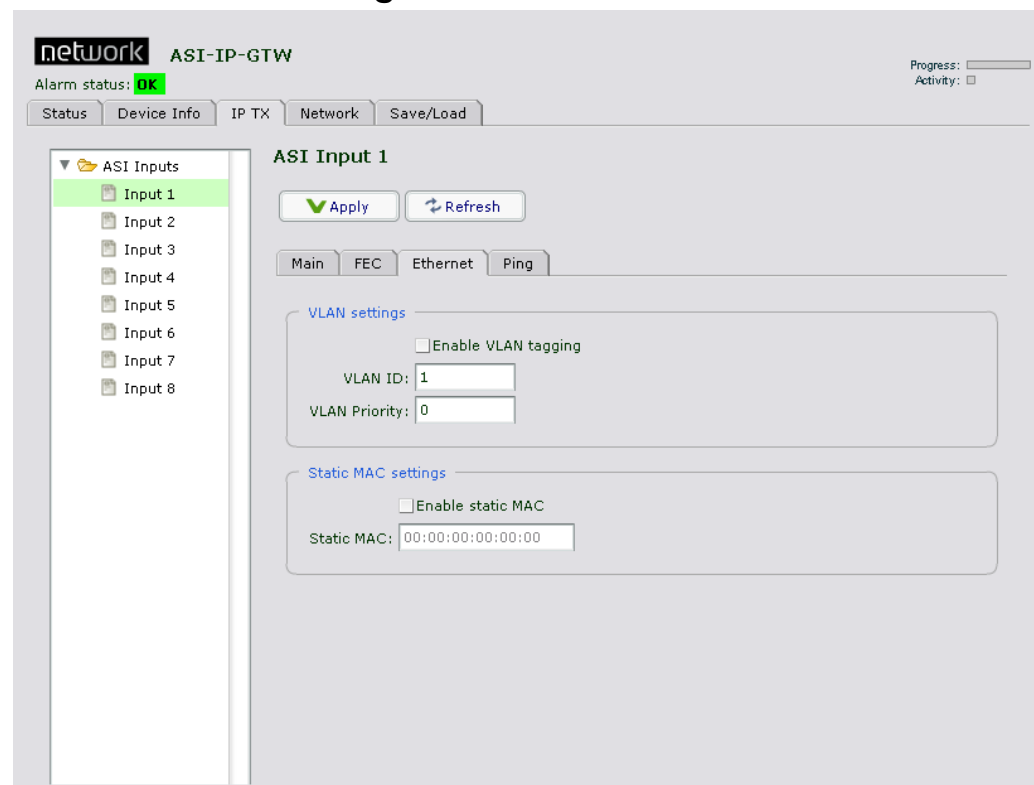

Figure 18. The Ethernet page of an IP transmitter

3.6.3.1 VLAN settings

By enabling VLAN tagging, IEEE802.1Q VLAN tags will be added to the outgoing streams. In effect, the video data Ethernet port will act as an 802.1Q VLAN trunk.

Enable VLAN tagging: Check this box to enable VLAN tagging.

VLAN ID: Enter VLAN ID in this field. This value shall be between 1 and 4094.

VLAN Priority: Enter VLAN priority in this field. This value shall be between 0 and 7.

3.6.3.2 Static MAC setting

Static MAC destinations address is used to specify a fixed MAC destination address in outgoing streams. This makes it possible to transmit to a destination host over a one-way link. The static MAC address setting then replaces the normal ARP lookup.

Enable static MAC: Check this box to enable insertion of the static MAC address.

Static MAC: Enter the destination MAC address.

3.6.4 Ping Settings

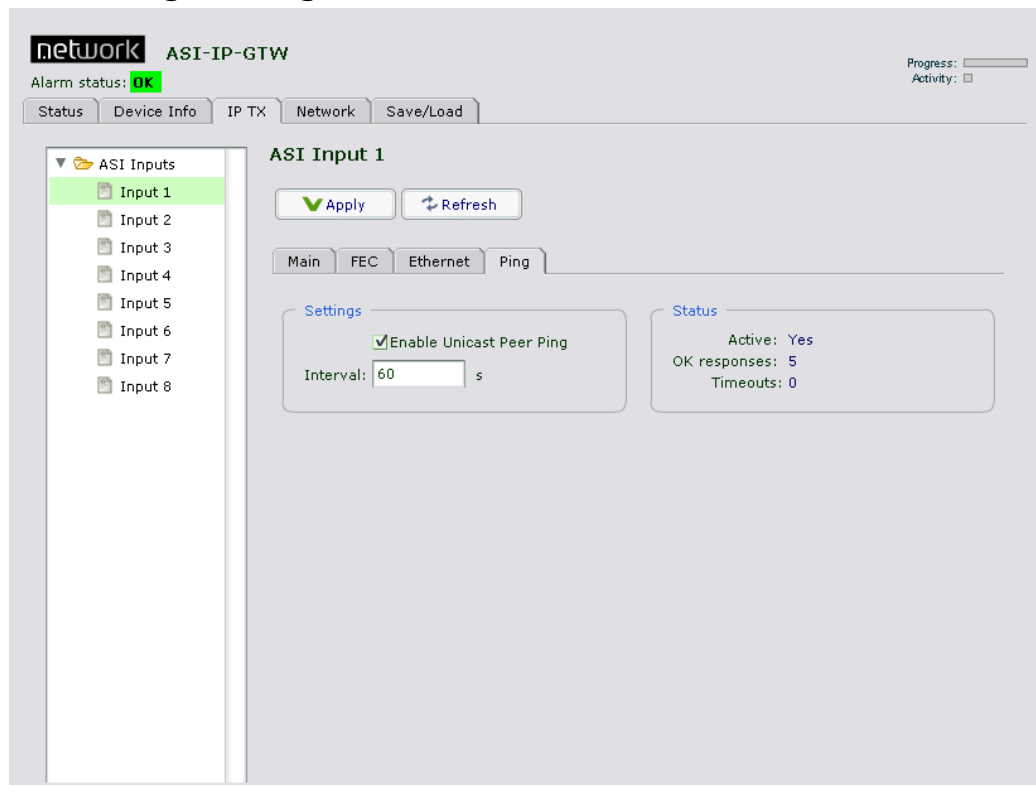

Figure 19. The Ping page of an IP transmitter

To resolve network problems, avoiding flooding, were the receiver or specific network components on the way to the receiver time out on there MAC address lookup. This feature solves this by pushing through a ping message regularly. This feature makes it also possible for the sender to know if there is an active recipient, or if it is down at the moment.

Enable Unicast Peer Ping: Check this box to enable regular pinging of the peer, e.g. the receiver of the stream. This will only have effect in unicast mode.

Interval: Set the interval in seconds between each Ping.

Active: Indicates if the channel is actively sending Ping.

OK responses: Indicates how many valid Ping responses have been received.

Timeouts: Indicates how many of the sent Ping messages timed out, without receiving a valid response.

3.7 IP RX

3.7.1 Main

Figure 20 shows the IP RX page. The purpose of this page is to provide an interface for configuring the different streams to be received by the unit.

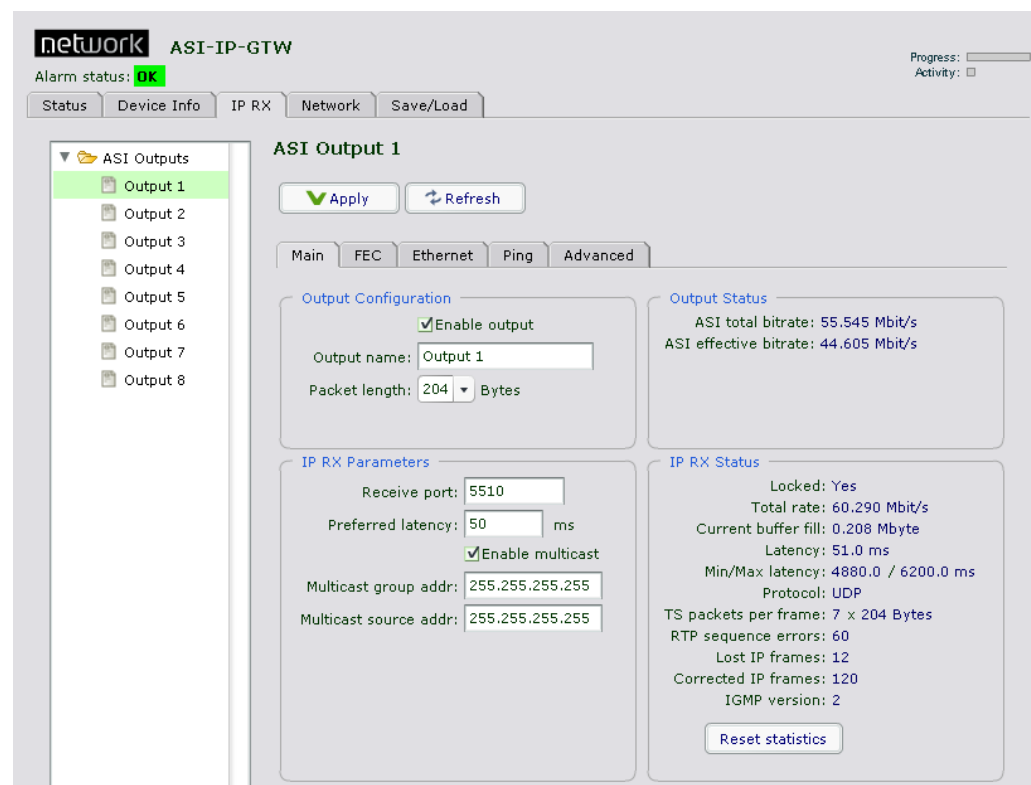

Figure 20. IP RX page

The left part of screen shows a three containing all the DVB ASI outputs port. To select a port, click that port. The information to the right of the page is related to the selected port.

1.1.1.27 Output Configuration

Enable output: Tick this box to enable an output. If this is not ticked, you will not send any MPEG-2 transport stream on this ASI output. The output port will be grey in the status view.

Packet length: This lets you configure the ASI output to transmit 188 or 204 byte transport stream packets. If incoming IP frames contain 204 byte MPEG-2 transport stream packets and the packet length is set to 188, the last 16 bytes of the 204 byte packets will be discarded. If incoming IP frames contain 188 byte MPEG-2 transport stream packets and the packet length is set to 204, the last 16 bytes of the 204 byte packets will contain the hexadecimal value FF.

Output name: Enter a name reference to an ASI output stream.

Copy of previous port: Every even numbered output includes this option. Selecting this option makes the port output exactly the same as the previous port, and no other IP RX options are used.

1.1.1.28 Output Status

ASI total rate: This shows the bitrate of the MPEG-2 transport stream on the output including NULL packets.

ASI effective rate: This shows the effective bitrate of the MPEG-2 transport stream on the output i.e. bitrate excluding NULL packets.

1.1.1.29 IP RX Parameters

Receive port: Enter the UDP port of this output. The UDP port together with the IP address uniquely identifies the stream to receive. UDP port numbers are in the range 1-65535. This field corresponds to the UDP destination port field of the transmitter.

Preferred latency: Enter the latency in units of milliseconds. This parameter is used together with the detected bitrate to set the size of the receive buffer. The receive buffer is used to remove network jitter, and to perform forward error correction.

Enable multicast: Click this box to use multicast.

Multicast group addr: This setting is only used when enable multicast is selected. Enter the multicast IP address of the incoming stream. When enabling multicast mode, the IGMP sub-module will be activated to join the multicast group and respond to membership queries.

Multicast source addr: This setting is applicable when using IGMP version 3 (see ch 3.5.1). The device will join a source specific multicast group, informing the router that it is interested in receiving data from a specific transmitter only.

1.1.1.30 IP RX Status

Lock: Yes, when the unit has locked to the input stream and has correctly estimated the bitrate of the input stream. No, when the unit has not been able to receive the input stream correctly.

Total rate: The total IP rate received on this channel.

Current buffer fill: Shows the number of megabytes currently in the buffer.

Latency: This parameter reflects the network jitter the unit can handle at the moment.

Min/Max Latency: This shows the minimum and maximum measured latency since the last statistics reset.

TS packets per frame: The number of transport stream packets per IP frame in the incoming stream.

RTP sequence errors: A counter showing the number of RTP sequence errors caused by lost packets or out-of-order packets. A value of zero indicates that all packets are received in order.

Lost IP frames: A counter showing the number of IP frames that is lost, i.e. lost and not corrected by the unit.

Corrected IP frames: A counter showing the number of IP frames corrected by the FEC engine.

IGMP version: Shows the IGMP version currently selected in the "Device Info" page under "Network", "Advanced" Settings.

Reset statistics: Press this button to reset the counters: RTP sequence errors, Lost IP frames and Corrected IP frames.

3.7.2 FEC Settings

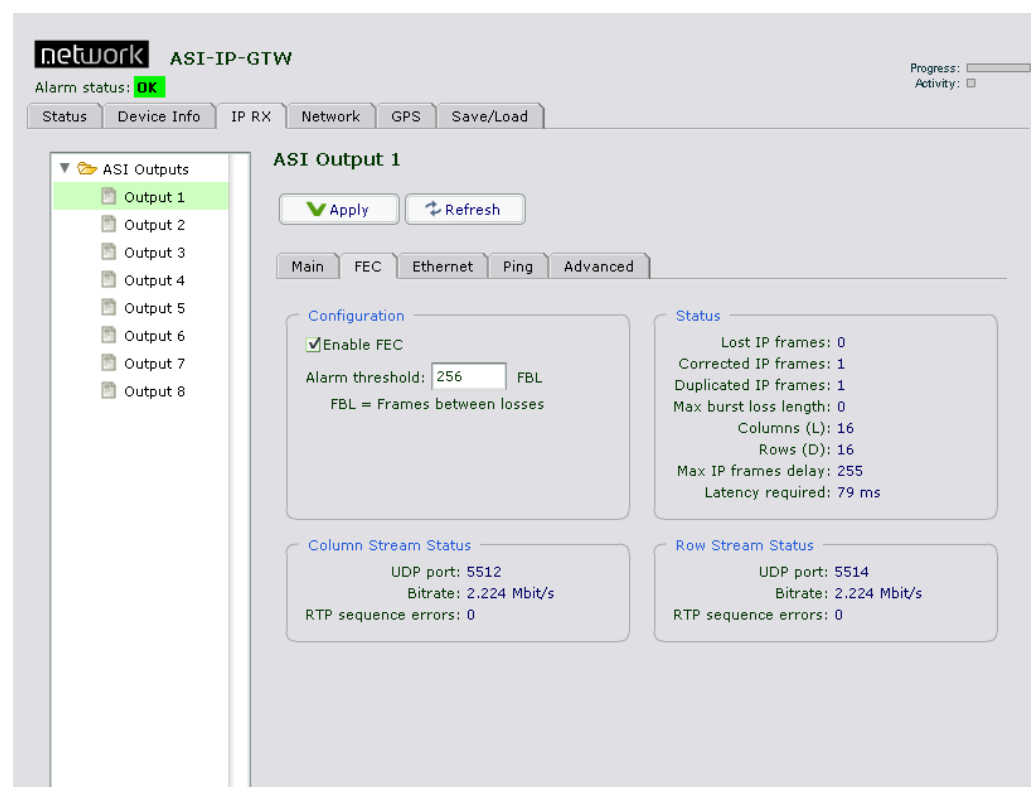

Figure 21. The FEC sub-page of an IP receiver

This sub-page will only appear if the unit is enabled with FEC.

Enable FEC: Tick this box to enable use of FEC.

Alarm threshold: This parameter controls the frequency of lost frames that should cause activation of the 'FEC Threshold Exceeded' alarm. The threshold is configured in the unit of frames between losses, causing the alarm to be activated if the number of frames received between two losses falls below the configured number.

In the Status frame the following parameters are shown:

Lost IP frames: This counter shows the number of lost IP frames. This means packets which remain uncorrected.

Corrected IP frames: This counter shows the number of IP frames corrected by the FEC engine.

Duplicated IP frames: This counter shows the number of duplicated IP frames received.

Columns (L): This shows the number of columns in the incoming FEC stream.

Rows (D): This shows the number of rows in the incoming FEC stream.

Max frames delay: This field shows the maximum number of frames delay measured for the FEC streams.

Latency required: This field is calculated from the 'Max frames delay' field and the current total bitrate to show the minimum delay needed by the FEC engine to fully utilize the incoming FEC streams.

When the delay displayed in the 'Latency' field of the 'IP RX Status' sub-page falls below the value of 'Latency required' field, the FEC engine may not be able to recover all lost frames that could have been corrected with a larger buffer.

For Column and Row the following status parameters are shown:

UDP port: The UDP port of the stream.

Bitrate: The bitrate of the incoming FEC stream.

RTP sequence error: This counter shows the RTP sequence errors in the incoming stream caused by lost IP frames or out-of-order packets.

3.7.3 Ethernet Settings

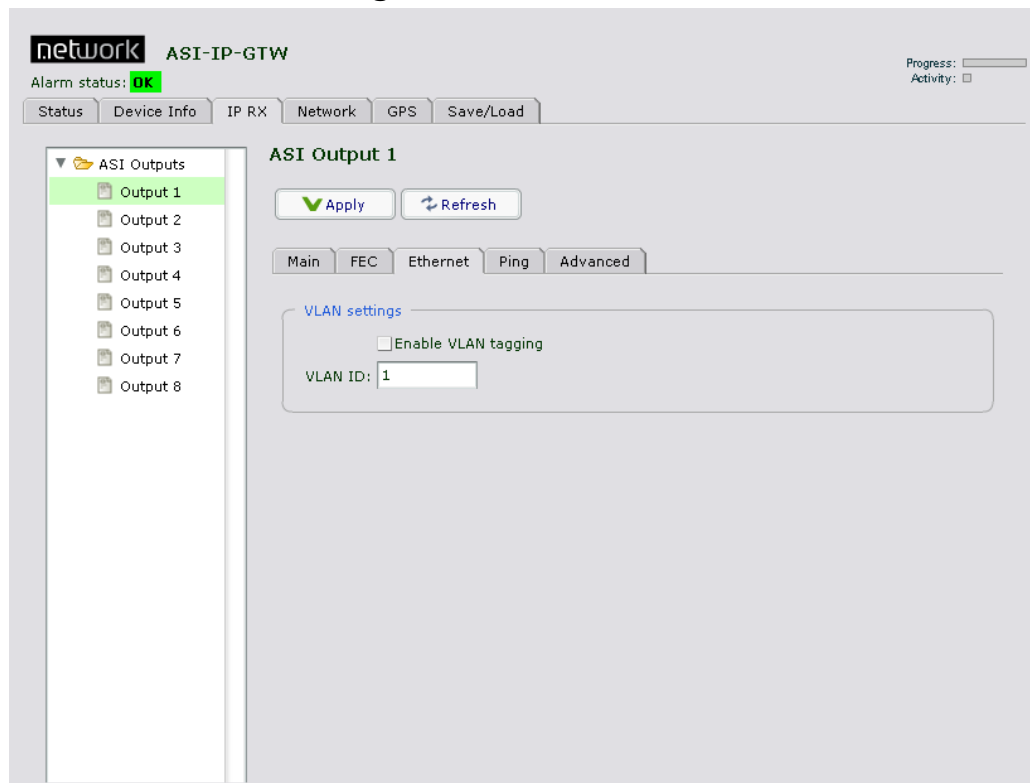

Figure 22. The Ethernet sub-page of an IP receiver

3.7.3.1 VLAN settings

Enable VLAN tagging: Check this box to enable VLAN tagging.

VLAN ID: Enter VLAN ID in this field. This value shall be between 1 and 4094.

3.7.4 Ping Settings

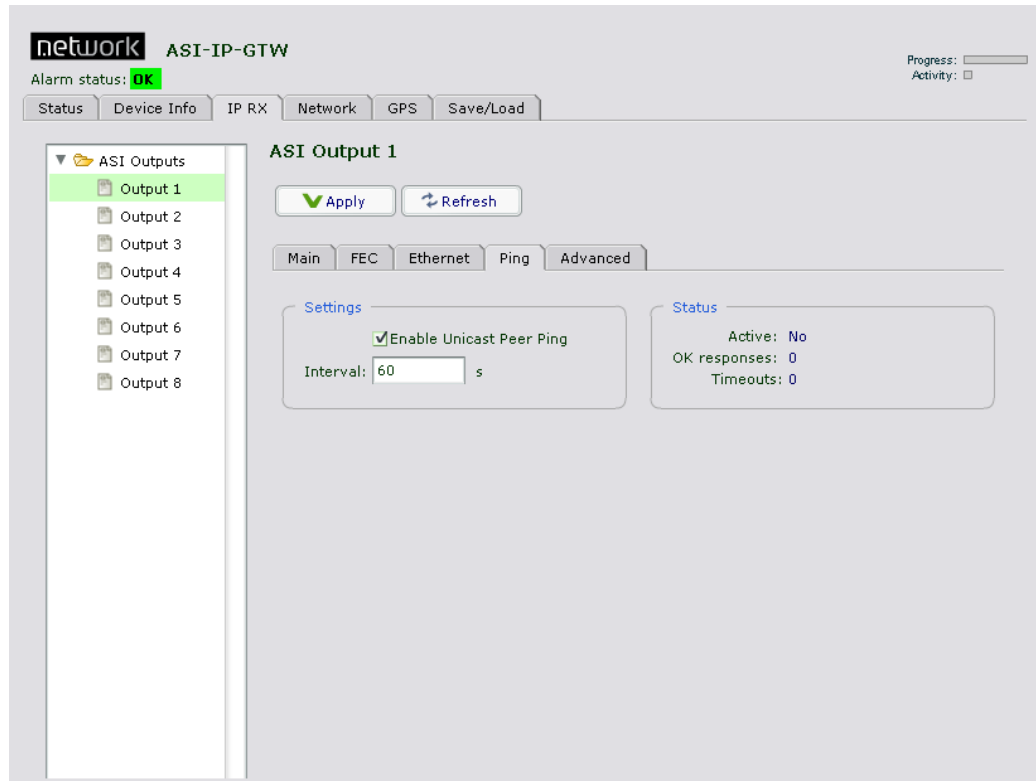

Figure 23. The Ping page of an IP receiver

To resolve network problems, avoiding flooding, were the transmitter or specific network components on the way to the receiver time out on there MAC address lookup. This feature solves this by pushing through a ping message regularly. This feature makes it also possible for the receiver to know if there is an active sender, or if it is down at the moment.

Enable Unicast Peer Ping: Check this box to enable Unicast Peer Ping. This enables regular pingging of the transmitting device.

Interval: Set the interval in seconds between each Ping.

Active: Indicates if the channel is actively sending Ping requests.

OK responses: Indicates how many valid Ping responses have been received.

Timeouts: Indicates how many of the sent Ping messages timed out, without receiving a valid response.

3.7.5 Advanced Tab

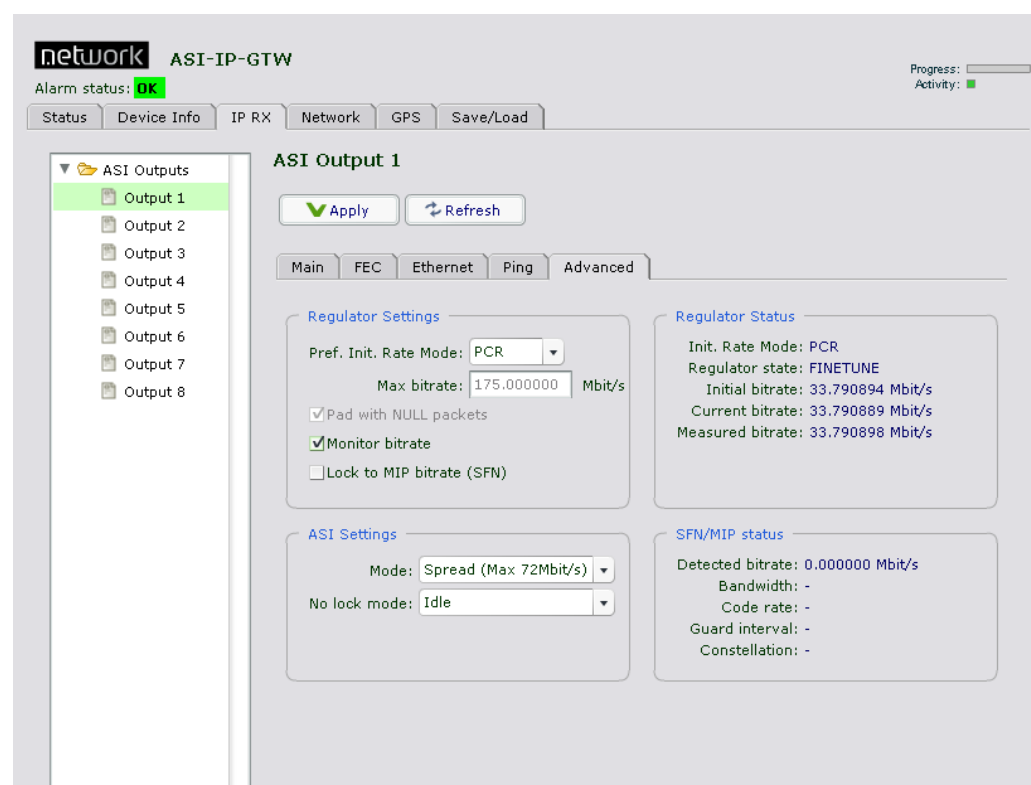

Figure 24 Advanced Tab

On the advanced tab it is possible to control and inspect the status of the buffer regulator for a port.

Pref. Init. Rate Mode: This parameter is used to select the preferred algorithm to use to find an initial bitrate for a received data stream.

- o **PCR:** The default mode is 'PCR', in which a number of consecutive TS packets on the first PCR PID encountered are used to calculate the bitrate. If no PCR PID is found, COARSE mode is automatically used.
- o **MIP:** This mode may be used for signals that do not contain any PCR PIDs, but do have a DVB MIP PID (PID 21) used in Single Frequency Networks. In MIP mode, two consecutive MIP packets are used to estimate the bitrate. If no MIP PID is found, COARSE mode is automatically used.
- o **COARSE:** In this mode, a simple 2 second measurement is used to estimate the bitrate. This method is sensitive to network jitter and does not give as good results as PCR and MIP mode.
- o **VBR:** In this mode, the unit attempts to transmit data at the rate entered in the Max bitrate input. If the incoming rate is lower than this, the unit will either pad with idle bytes (resulting in a VBR output stream) or with NULL packets, depending on whether the "Pad with NULL packets" checkbox is checked. In this mode, no PCR adjustment is performed.

Max bitrate: : If VBR rate mode is chosen, this tells the unit what bitrate it should attempt to transmit at.

Pad with NULL packets: Checking this means that the unit, when in VBR rate mode, will pad the output stream with NULL packets up to the entered max bitrate.

Monitor bitrate: Checking this box will make the unit resync faster in the case of small bitrate changes.

Init. Rate Mode: This parameter shows the initial bitrate mode that was used at last re-sync. If you have selected PCR mode, and this parameter shows COARSE mode, the device has not been able to find a valid PCR PID on the signal.

Regulator state: This parameter shows the current state of the buffer regulator.

The possible states are *Stopped*, *Rate Estimation*, *Coarse* and *Finetune*.

When data is received and an initial bitrate estimate is found, the regulator enters the "Rate Estimation" state, where the signal is analyzed to check if a better estimation of the bitrate can be found. When a better estimate is found, the regulator switches to *coarse* mode, where the output bitrate is coarsely moved closer to the new rate. From Coarse mode, the regulator enters Finetune mode.

Initial bitrate: Here the exact initial bitrate found is displayed.

Current bitrate: This parameter shows the exact bitrate played out on the ASI port at the moment.

Measured bitrate: This parameter is an input to the regulator in the *Rate Estimation* and *Coarse phase*, and shows the bitrate measured for the datastream since last re-synch. In the first minutes after a re-synch, this measurement is highly inaccurate and dependent on IP network jitter. After a few minutes of operation the value gets more and more accurate, and can be compared to the current bitrate to see how far off the bitrate target the regulator is operating.

Mode: Here you can configure the unit to transmit ASI data using burst or spread mode. Note that spread mode only works with bitrates up to 72Mbit/s. If you choose spread mode and a transmit a higher bitrate, the signal will become a burst/spread hybrid.

No lock mode: This parameter lets you choose what the unit should transmit on the ASI port when it has no lock. You can choose to send idle bytes or turn the port completely off.

3.8 Network

Figure 25 shows the Network page for a unit configured to bi-directional operation of the Ethernet interface. The purpose of this page is to provide network related information.

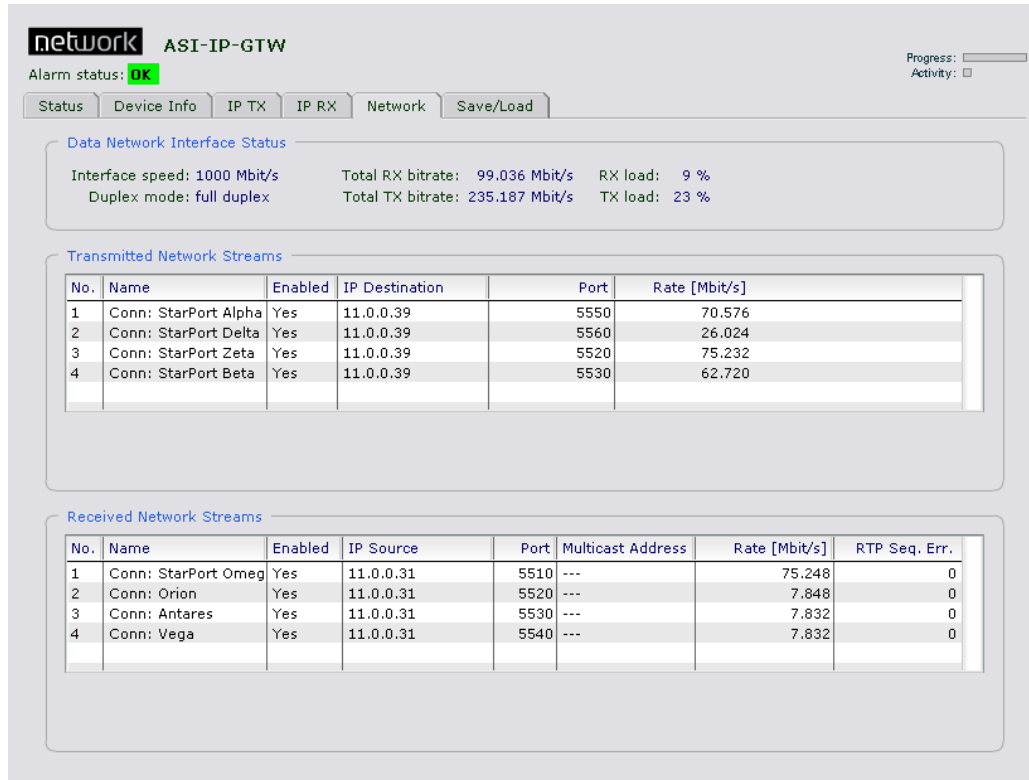

Figure 25. Network page for unit in IP TX mode

1.1.1.31 Data Network Interface Status

Interface speed: Shows the rate in Mbit/s of the data network interface.

Duplex mode: Full duplex or half duplex dependent of the configuration of the port.

Total RX bitrate: The total bitrate of IP frames received over the network data interface.

RX load: The percentage of the total interface speed used by the IP frames received over the network data interface.

Total TX bitrate: The total bitrate of IP frames sent over the network data interface.

TX load: The percentage of the total interface speed used by the IP frames sent over the network data interface.

1.1.1.32 Transmitted Network streams

The transmitted network streams table shows a list of all ASI inputs.

For each individual ASI input, the tables shows the name of the input, if input is enabled (Yes/No), the IP destination address of the stream, the UDP destination port, the total bitrate of the interface (in Mbit/s).

Figure 26 shows the Network page for a unit configured to IP-RX mode.

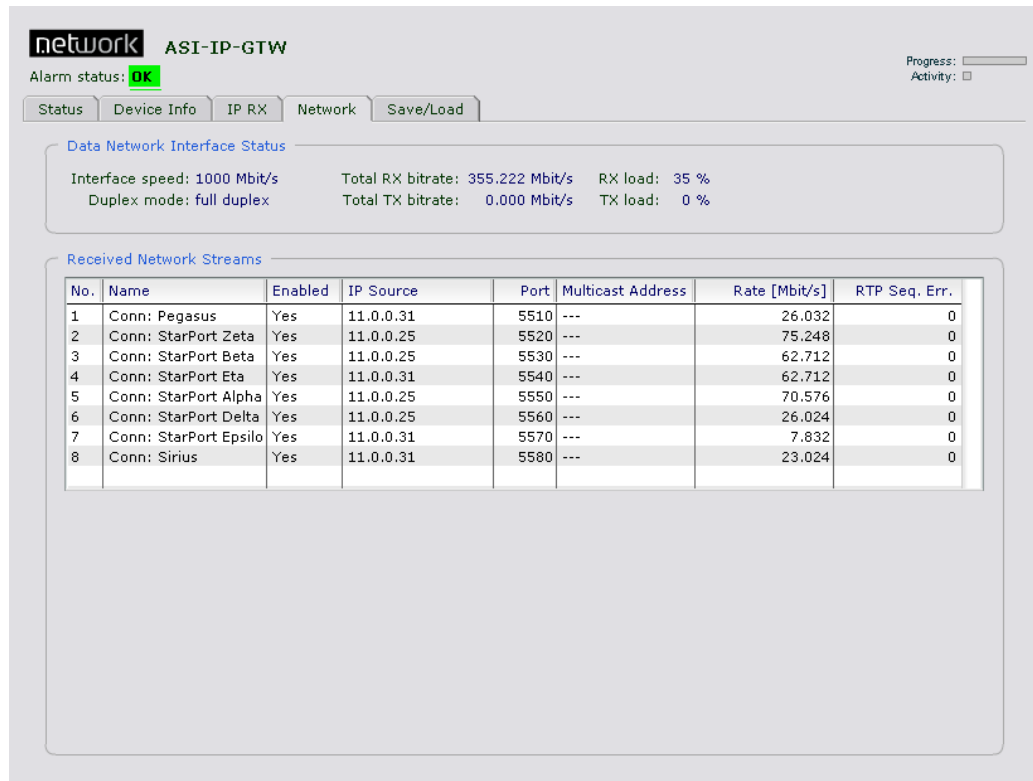

Figure 26. Network page for unit in IP RX mode

We see that only received network streams is visible. The Data Network Interface Status is the same for an IP transmitter and an IP receiver.

1.1.1.33 Received Network streams

The network streams table of a unit configured for IP reception shows a list of all ASI outputs.

For each individual ASI output, the table shows the name of the output, if the output is enabled (Yes/No), the IP source address, the UDP port, the total bitrate of the interface (in Mbit/s) and a counter showing RTP sequence errors.

3.9 Save/Load

Figure 27 shows the Save and Load configuration page. This is where you save the current configuration or restores a configuration from file.

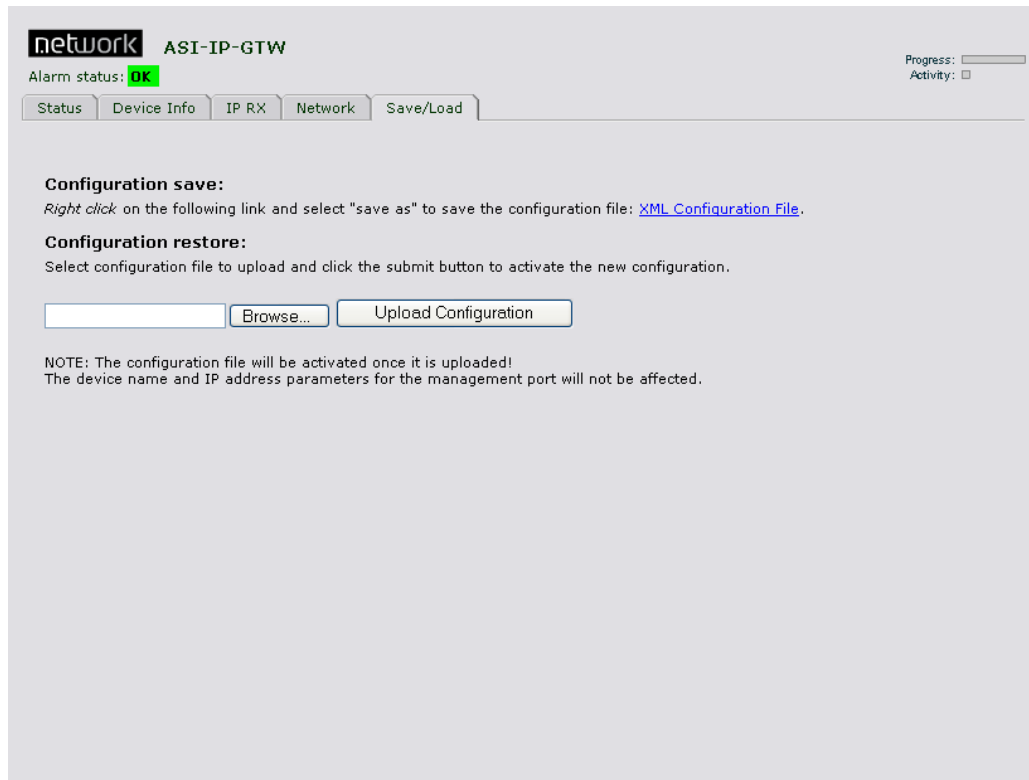

Figure 27. Save/load configuration page

The configuration in effect while the unit is operating is called the current configuration.

3.9.1 Saving a Configuration

In order to save the current configuration of the unit to a file, please right-click the link labelled "XML Configuration file" and select "Save target as". Enter the file name of the configuration file. Figure 28 shows the user interface.

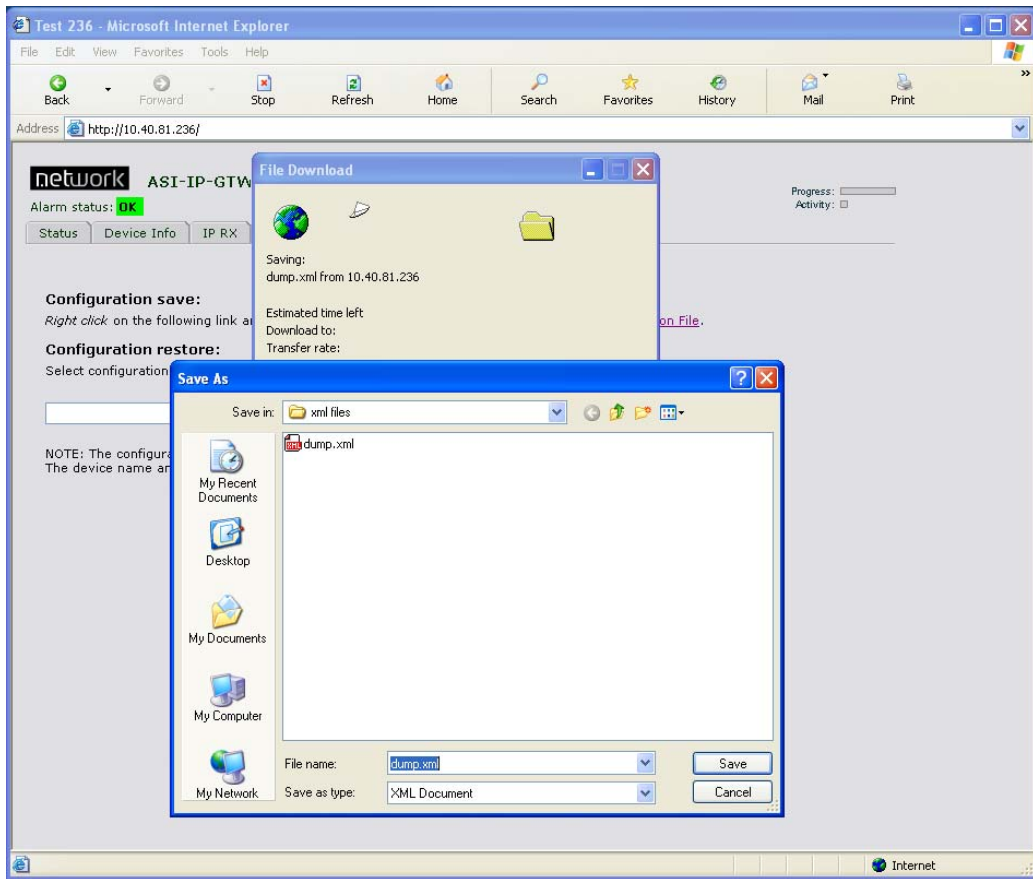

Figure 28. Save/Load page when saving configuration

3.9.2 Loading a Configuration

In order to upload a new configuration file to the unit, browse to find the file and select the file or enter the file including path directly. When the file name including path is entered, select "Upload configuration".

Note: The configuration file will be activated once it is uploaded!

4 Options

This chapter describes functionality and operating instructions for various additional product options.

4.1 1PPS/10MHz interface modules

In order to achieve exact bitrate control for use in SFN networks, the ASI-IP-GTW may be equipped with 1PPS/10MHz interface modules. The purpose is to lock the internal system clock of the ASI-IP-GTW to external 1PPS/10MHz signals to obtain exact bitrate control. The typical application is to receive a stream over IP network and send it out on ASI connectors at a fixed, accurate rate. The transmitter needs to transmit at the same rate.

Two options exist to lock the product to external time reference: A separate 10MHz/1PPS module which occupies an ASI slot, or a separate 1PPS input module that allows 8 ASI ports.

4.1.1 Separate 10MHz/1PPS module

Figure 29 shows a picture of the back panel when this module is mounted.

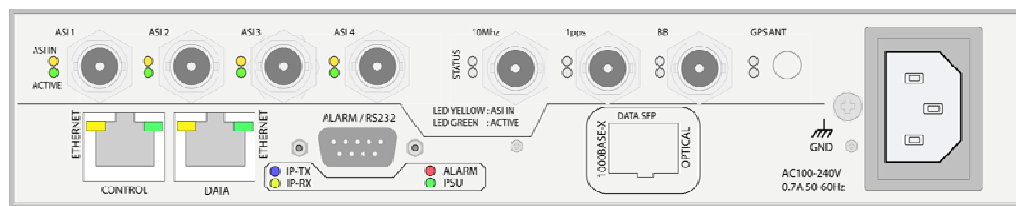

Figure 29. ASI-IP-GTW with 1PPS/10MHz interface module equipped

The signals are:

- o 10MHz. 50 ohm terminated input for a sinusoidal 10MHz signal.
- o 1PPS. 50 ohm TTL input for a 1 pulse-per-second signal.

For physical parameters of these ports, see appendix B.

Both signals may be connected. However, the ASI-IP-GTW only uses one of them at a time. The active input is selected from the “GPS” tab in the ASI-IP-GTW WEB user interface.

4.1.2 1PPS interface

When 8 ASI outputs are required together with SFN operation, an alternative to the 1PPS/10MHz module is to use a separate 1PPS interface as described in the following figure.

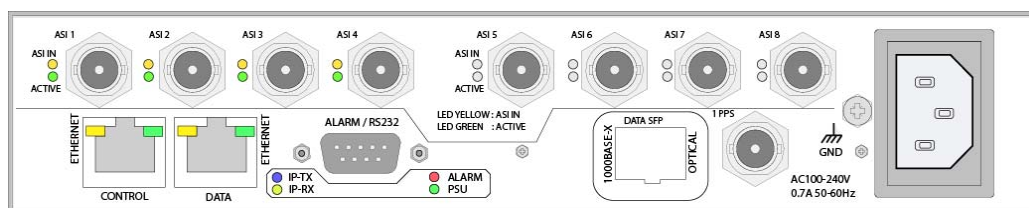

Figure 30. ASI-IP-GTW with separate 1PPS interface module

The signals are:

- o 1PPS. 50 ohm TTL input for a 1 pulse-per-second signal.

For physical parameters of the 1PPS port, see appendix B.

4.1.3 Operating the 1PPS/10MHz interface module

A new top-level tab named “GPS” appears in the user interface of the ASI-IP-GTW units with the interface mounted. The control part of this tab only consists of a ComboBox where the lock mode is selected.

Figure 31 shows the layout of the page.

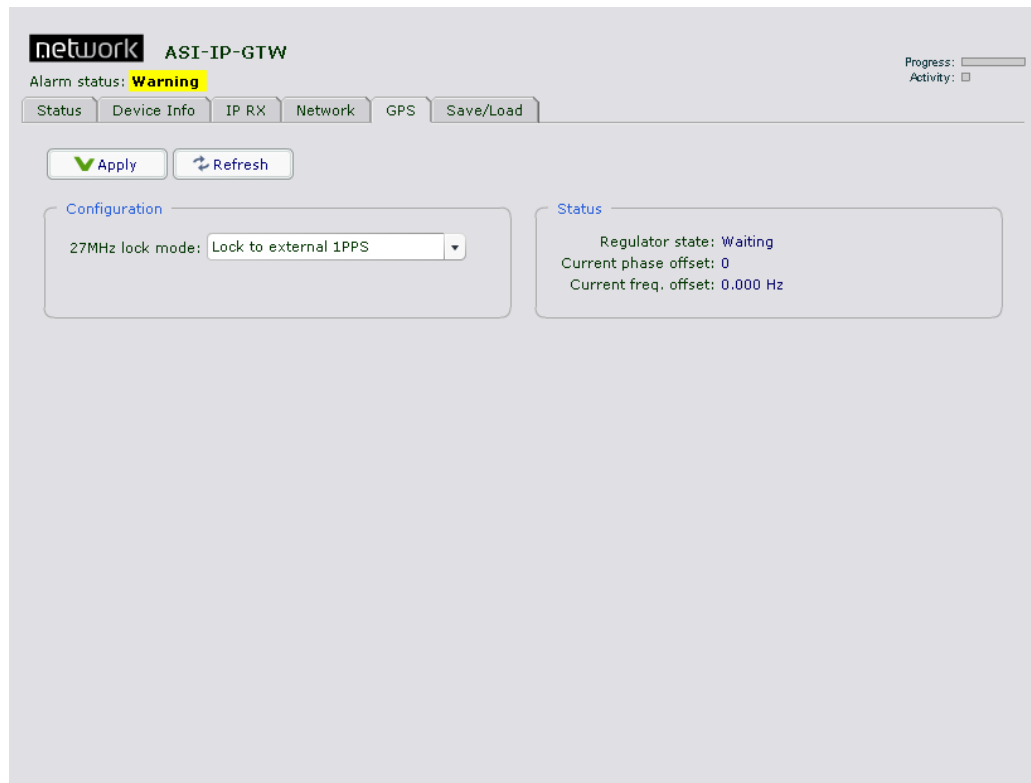

Figure 31. GPS tab

The control parameter simply consists of a combobox:

27MHz lock mode: Select the lock mode for the internal 27MHz. Set this parameter to “Disabled” if you don’t want to use the GPS board. Set to “Lock to external 1PPS” or “Lock to external 10MHz” if you want to lock the system clock to the reference signal.

The status parameters show the current state of the lock mechanism. The parameters are as follows:

Regulator state: Shows “Idle”, “Waiting” or “Fine tune” dependent on the selected mode. In the “Waiting” state, the ASI-IP-GTW waits for a valid input signal to lock to. After some seconds with valid input signal, the regulator enters the “Fine tune” state which indicates that the system clock is locked OK. The “Idle” state indicates that the regulator is disabled.

Current phase offset: This is an integer number that gives an indication of the current phase offset between the internal and external clock sources. It’s absolute value should be below 100 in the stable phase.

Current freq. offset: This shows the offset between the internal clock (in idle state) and the external clock reference.

4.1.4 LED descriptions

(Separate 1PPS/10MHz module only)

Each input connector has two LEDs associated with it; one yellow and one green LED. The yellow LED is lit when the input is enabled. The green LED is lit when the unit has locked correctly to the signal, as shown in the following figure.

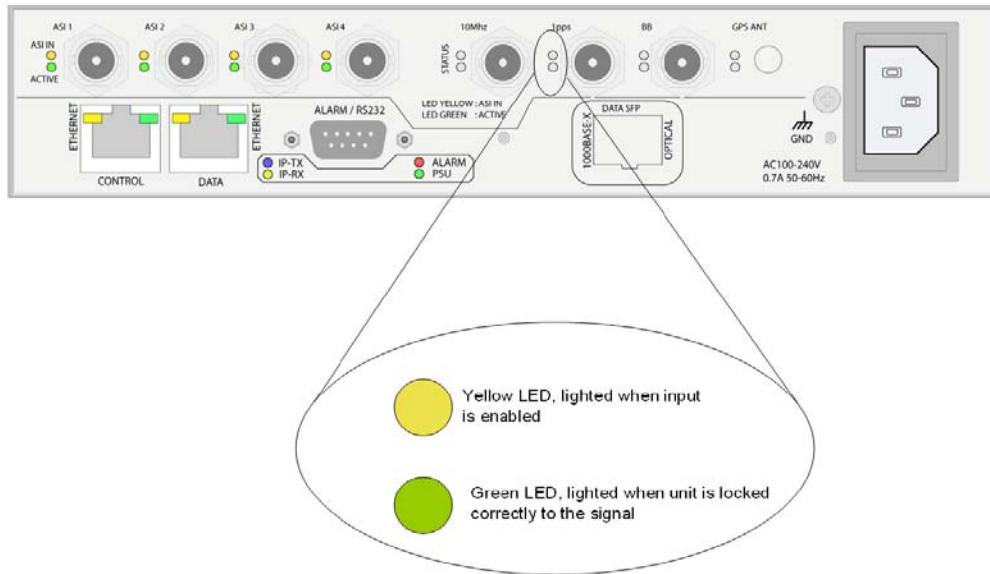

Figure 32. LED description for separate 1PPS/10MHz interface module

4.2 RIPv2 functionality

The ASI-IP-GTW is equipped with RIPv2 functionality. The ASI-IP-GTW will then transmit RIPv2 messages regularly. The content of the RIPv2 messages is set as specified in this chapter.

RIP2 messages are sent with one entry each. The metric of this entry can be set either manually or automatically based on the current alarm level of the unit. This information may be used by network routers to select the source with the lowest metric; i.e. in effect automatic redundancy switchover.

4.2.1 User interface

Figure 33 shows the layout of the RIP-2 screen.

The screenshot displays the web interface for the ASI-IP-GTW device, specifically the RIP-2 configuration page. At the top, the 'network' logo and 'ASI-IP-GTW' title are visible, along with an 'Alarm status: OK' indicator and a progress bar. A navigation bar includes tabs for 'Status', 'Device Info', 'IP TX', 'Network', 'GPS', and 'Save/Load', with 'RIP-2' currently selected. Below the navigation bar are 'Apply' and 'Refresh' buttons. The main content area is divided into three sections: 'Product Information', 'Settings', and 'Status'. The 'Product Information' section shows details like 'Name: IP TX Boks', 'Internal temp.: 59°C (138°F)', and 'Mode of operation: ASI --> IP'. The 'Settings' section contains various configuration parameters: 'Mode' is set to 'Alarm', 'Metric on clear' is 8, 'Metric on critical' is 16, 'Destination' is 'All Routers (224.0.0.2)', 'Manual next hop' is checked with IP '11.0.0.33', 'Route tag' is 0, 'Update interval' is 30 seconds, and 'Hold time' is 300 seconds. The 'Status' section provides real-time data: 'RIP-2 message count: 11', 'Current metric: 16', 'Next hop: 11.0.0.33', 'Update timeout: 15 seconds', and 'Hold timeout: - seconds'.

Figure 33. RIP-2 screen

The configuration parameters are as follows:

Mode: Controls the mode of the RIP-2 engine. The valid choices are:

- o Off: No RIP-2 messages are sent.
- o Auto: RIP-2 messages are sent. The metric in the RIP entry is set dependent on the current unit alarm state. If the alarm state is critical, the “Metric on critical” value is used. If the alarm state is “OK”, the “Metric on clear” value is used.
- o Alarm: RIP-2 messages are sent. The “Metric on critical” value is used, independently on the current alarm state.
- o Clear: RIP-2 messages are sent. The “Metric on clear” value is used, independently on the current alarm state.

Metric on clear: The metric number to be used in the RIP messages when there are no active alarms in the unit.

Metric on critical: The metric number to be used in the RIP messages when there are at least one critical alarm present.

Destination: The IP destination address to use for the RIP messages.

Enable manual next hop: If set, the RIPv2 messages will specify the next hop as defined in the "Next hop address" field.

Next hop address: The address to be used for the next hop.

Route tag: Corresponds to the route tag field in the outgoing RIP messages.

Update interval: Specifies the average update interval for the RIPv2 messages. Note that the ASI-IP-GTW adds some random delay to avoid sending messages too regularly.

The status parameters are:

RIP-2 message count: Shows the number of RIP-2 messages transmitted.

Current metric: Shows the current metric used in the outgoing RIP-2 messages. Will be either the "Metric on clear" or the "Metric on critical" value.

Next hop: Shows the next hop value.

5 Equipment Description

5.1 Introduction

This chapter provides an overview of transmission of MPEG-2 data over IP networks and a high-level functional description of the ASI-IP-GTW.

5.2 Functional Description

5.2.1 Introduction

The ASI-IP-GTW consists of a main module and 1 or 2 ASI boards each handling up to 4 ASI ports. Optical Gigabit is provided as a hardware option.

The ASI-IP-GTW can be configured by the operator to be IP transmitter or an IP receiver. A SW option is also available to enable bi-directional operation of the IP data interface. In the IP transmitter mode, the ASI-IP-GTW encapsulates MPEG-2 transport streams received on the ASI ports into IP streams. These streams are sent on an Ethernet interface onto the IP network.

In IP receive mode, the ASI-IP-GTW receives and de-capsulates up to 8 transport streams from the IP network and outputs the MPEG-2 transport streams on the DVB ASI ports.

In bi-directional mode, half the ports are used as ASI outputs, while the other half operate as ASI inputs.

5.2.2 IP Transmit Mode

In the IP transmit mode, the MPEG-2 transport streams are sourced from the ASI ports on the ASI boards.

The ASI-IP-GTW is able to handle source transport streams on ASI on the following formats:

- o Packet format of 188 bytes
- o Packet format of 204 bytes, including padding
- o Packet format of 204 bytes, including RS bytes (no RS checking performed)

The sourced transport stream is then processed by the Main board. The ASI-IP-GTW will always send 188 bytes packets over the IP network. The MPEG-2 transport stream packets are encapsulated as described in section 5.3.1. The user configures the IP address of the Ethernet data port. For each transport stream to be sent over the IP network, the IP destination address and UDP port are configured. The ASI-IP-GTW handles both unicast and multicast transmissions.

The IP packets from one ASI input port are then merged with the IP packets from the other ASI inputs. The combined IP stream is then passed onto the physical Ethernet connector.

5.2.3 IP Receive Mode

In IP receive mode, the ASI-IP-GTW receives IP packets from the data Ethernet interface. The ASI-IP-GTW will receive streams from different sources. In the case of unicast, the ASI-IP-GTW will parse the IP stream and send the transport stream to the ASI output which is configured with the matching UDP port. In case of multicast, the ASI-IP-GTW will send a join message to join the configured multicast. When reception is disabled, the ASI-IP-GTW will send a leave message to the network.

For each transport stream, the reassembled MPEG-2 transport packets are held in a buffer. The function of this buffer is to handle re-ordering of packets, eliminate network jitter and support the adaptive rate recovery.

After clock recovery, the MPEG-2 transport stream is passed to the DVB ASI output port.

In the current version of the product, the ASI output will always output 188 byte packets. If you require 204 byte packets, please contact Network support as this is likely to be available in a future software version.

5.2.4 IP Bi-directional Mode

In IP bi-directional mode, half the ASI ports are operate as described in IP transmit mode, while the other half are operated as described in IP receive mode.

5.2.5 Management

The ASI-IP-GTW provides an Ethernet management port for configuration and control of the unit. The management port has its own IP address. This interface provides the following features:

- o WEB interface for remote control
- o SNMP for alarm and status monitoring (optional).
- o FTP for software and firmware updates
- o Telnet for engineering and debug purposes

In addition, the IP address of the management port can be set though the RS232 connector.

The WEB interface is described in detail in Chapter 1. SNMP is an option to the product. The unit will send SNMP traps to report alarm conditions; in addition it is possible to read from the unit all active alarms and trap history. The MIB is available on request.

5.2.6 Alarms

The ASI-IP-GTW indicates alarm or fail status to the user in four ways:

- o WEB interface
- o Alarm LED on the front and on the rear
- o SNMP traps to Network Management System
- o Alarm relay

The user can define the severity level of the different alarm events. The three levels are No alarm, Warning and Critical.

The WEB interface gives the most detail alarm information as all active alarms and warning are listed with time when the alarm condition occurred.

The unit sends an SNMP trap message when an alarm condition rises. A critical alarm will have severity level 6 and a warning will have severity level 3. When the alarm is cleared, a new message is sent to indicate that the alarm condition is cleared.

Finally, the red alarm LED will illuminate when an unmasked alarm condition rises. At the same time the alarm relay will be in an alarm state.

Table 12. Alarms

Alarm id	Alarm	Severity level	Description
100	No sync	Critical	No valid ASI input stream detected.
101	ASI bitrate too high	Critical	The ASI input bitrate has exceeded the configured maximum value.
121	Bitrate regulation in progress	Filtered	The regulation algorithm is estimating the incoming bitrate to compensate for the difference in PCR clocks on the source encoder and the IP receiver. While this alarm is active, the output bitrate may be tuned beyond the limits of the ASI specifications.
130	Ethernet link down	Critical	No link on Ethernet layer
131	Output buffer overflow	Warning	The total bitrate of the ASI input streams is too high.
140	ARP unresolved	Warning	IP address is not resolved into physical MAC address.
150	Sequence error	Warning	Analysis of the sequence number of the RTP layer indicates that IP frames have been lost or that they have been received out of order.
151	No data received	Warning	No data received on Ethernet input for stream
152	FEC threshold exceeded	Warning	The frequency of lost frames is higher than the configured value. Threshold values are configured per stream.
153	Input buffer overflow	Warning	The total bitrate of the IP input streams is too high.
154	Data lost	Critical	The data stream received for a channel is incomplete, and if running FEC, the FEC engine is not able to recover all the lost frames.
155	No lock	Critical	The IP receive channel is not able to find an initial bitrate for the data received.
156	MIP not present	Warning	No MIP frames are received.
157	Too low latency for FEC	Warning	The preferred latency is set lower than the latency required by the incoming stream.
160	SNTP server unreachable	Warning	Unit is not receiving answers from the SNTP server.
161	Too high temperature	Warning	Internal temperature of unit is too high.
162	Defective fan	Warning	One or both of the fans are not spinning.
200	No GPS 1PPS reference signal	Warning	The 1PPS reference signal is lost. (The regulator has however not lost synchronization)
201	Lost GPS 1PPS synchronization	Critical	The clock synchronization mechanism has been resynchronized due to too large phase error.

5.3 Overview of Video over IP

5.3.1 Protocol mapping

One of the core functions in the ASI-IP-GTW is the IP encapsulation of the MPEG-2 transport streams. The task is basically to encapsulate video packets into IP frames, using the right headers.

Figure 34 shows how the transport can be separated into various layers.

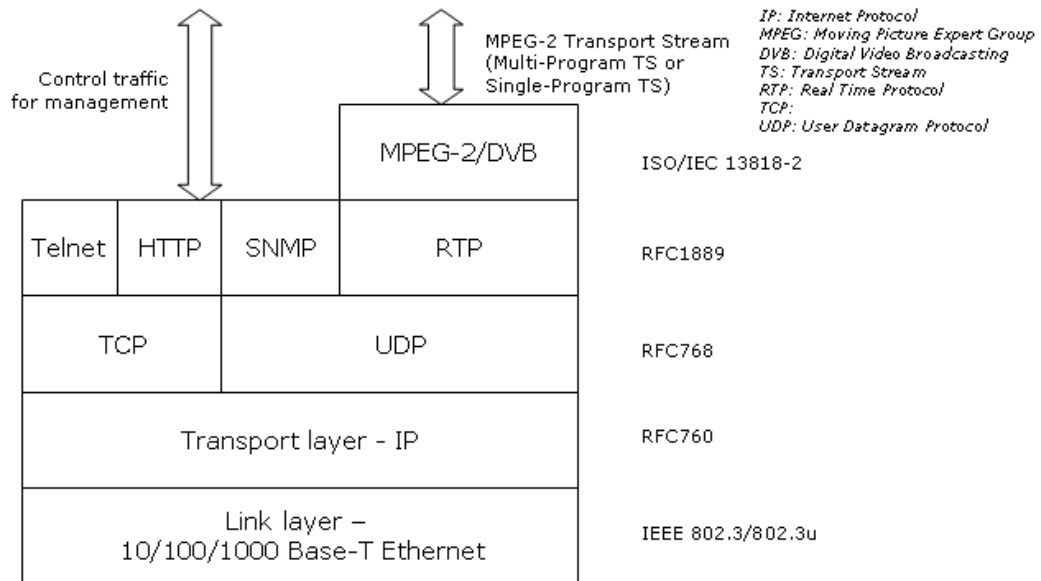

Figure 34. Protocol mapping

The MPEG-2/DVB layer is specified in ISO/IEC 13818-1.

The ASI-IP-GTW is able to handle both Multi-Program Transport Streams (MPTS) and Single-Program Transport Streams (SPTS). In the current version, the ASI-IP-GTW operates in a transparent mode. The unit will encapsulate and de-encapsulate complete transport streams without changing the streams. This means that no insertion or removal of NULL packets is performed and PCR is sent transparently through the unit.

Control data are handled differently from transport stream data on the next layer. RTP as defined in RFC1889 is applied for the MPEG-2 transport stream data. Three types of protocols are used for control data. HTTP is used when the unit is configured and monitored via the internal WEB server. SNMP is used for alarm traps and simple status polling. Telnet is used for development purposes.

The transport stream data are handled according to RFC768 on the UDP layer. The operator can configure destination port for the MPEG-2 transports stream. The MTU for Ethernet is usually 1500 bytes. This limits the number of transport stream packets to embed into the outgoing Ethernet/IP frames to be between 1 and 7.

TCP is used for control data.

1.1.1.34 UDP Mode

To allow interoperability with legacy equipment, the ASI-IP-GTW can stream video over IP without using the RTP protocol encapsulation. This is also called *UDP mode* or *UDP only*. UDP mode is manually configured on the transmitting ASI-IP-GTW unit, and automatically detected on the receiving ASI-IP-GTW.

Note: FEC relies on information in the RTP protocol, and will not be available in UDP mode. FEC is explained in 5.4.1.

5.4 Data Flow Block Diagrams

The following figure shows the data flow between two ASI-IP-GTW over an IP network.

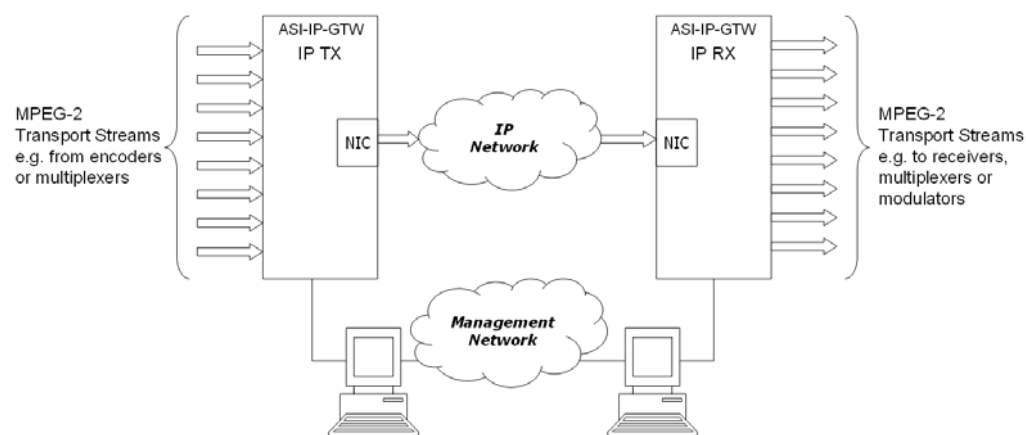

Figure 35. Data flow between two units

5.4.1 Forward Error Correction (FEC)

Unfortunately, real networks are not perfect and packet losses occur. In order to cope with packet losses, the ASI-IP-GTW has implemented Pro-MPEG FEC according to Pro-MPEG Code of Practice #3 rev. 2. Pro-MPEG FEC is carried out on RTP packets. The mechanism is based on the insertion of additional data containing the result of an XOR (exclusive OR)-operation of packets over a time window.

The generation of FEC packets is based on the use of a matrix. The matrix size is defined by the number of columns (L) and the number of rows (D). The FEC packets are calculated as an XOR operation over the packets in a column and the packets in a row. Figure 36 shows an example of the FEC scheme. Three packets are lost and corrected.

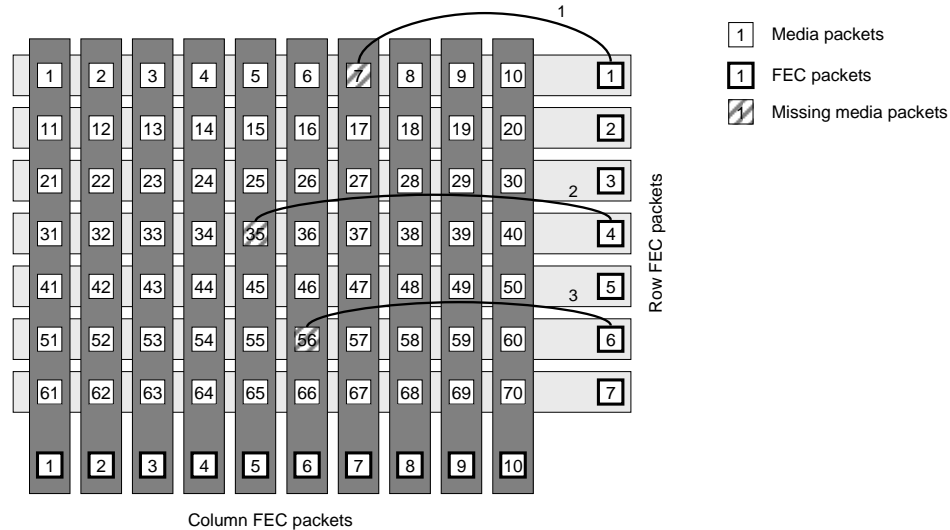

Figure 36. Illustration of two-dimensional FEC, where packet 7, 35 and 56 are lost and corrected.

One missing packet per row or column can be calculated by XOR'ing the FEC packet with the other packets in that row or column. By iterative operations it is possible to correct more than one missing packet per column or row. Please note that $4 \leq L \leq 32$, $4 \leq D \leq 32$ and $L+D \leq 32$ and that the maximum matrix size is $256(L \cdot D)$. When using column FEC only, L is allowed to be in the range $1 \leq L \leq 32$. The size of the matrix is a trade between latency, transmission overhead and error protection.

Column FEC provides correction for consecutive burst packets loss of up to L packets. The FEC packets are generated per a column within the matrix allowing loss of any single media packet within a column or a burst of packets of errors within a row to be corrected through the FEC packet. Column FEC is used to correct burst errors and random errors.

Row FEC provides correction of non-consecutive packet loss and can correct any single packet loss within a row of media packets. The FEC packets are generated per a row allowing loss of any single packet to be recovered. Row FEC is ideal for correcting random packet errors.

Once the FEC packets have been computed they are transmitted with the media packets to the receiver site. FEC column packets are transmitted on UDP port $n+2$ and FEC row packets are transmitted on UDP port $n+4$ where n is the UDP port of the media data. This is in accordance with Pro-MPEG CoP 3.

6 Preventive Maintenance and Fault-finding

6.1 Introduction

This chapter provides the schedules and instructions, where applicable, for routine inspection, cleaning and maintenance of the ASI-IP-GTW to be carried out by the operator of the unit.

6.2 Preventive Maintenance

6.2.1 Routine Inspection

1.1.1.35 Cooling fans

This equipment must never be used unless all the cooling fans are working. They should be checked when the unit is switched on and periodically thereafter.

6.2.2 Cleaning

- o Remove power from the unit.
- o Clean the external surfaces of the ASI-IP-GTW with a soft cloth dampened with a mixture of mild detergent and water.
- o Make sure that the unit is completely dry before reconnecting it to a power source.

6.2.3 Servicing

Warning: Do not attempt to service this product as opening or removing covers may expose dangerous voltages or other hazards. Refer all servicing to service personnel who have been authorised by Network.

1.1.1.36 Damage requiring service

Unplug the unit from the power and refer servicing to qualified personnel under the following conditions:

- o The power supply cord or plug is damaged
- o Liquid has been spilled or objects have fallen into the product
- o Product has been exposed to rain or water
- o Product does not operate normally by following the operating instructions
- o Product has been dropped or has been damaged
- o Product exhibits a distinct change in performance

6.3 Maintenance

6.3.1 Warranty

The ASI-IP-GTW is covered by standard Network warranty service for a period of 12 months from delivery.

The warranty covers the following:

- o All material defects in the equipment for a period of 12 months
- o All parts and labour charges
- o Return of the repaired item to the customer, postage paid.
- o Customer assistance through Network Customer Service Help Line

The warranty does not cover any engineering visit(s) to the customer premises.

6.4 Fault-finding

6.4.1 Fault finding Philosophy

The objective of this chapter is to provide sufficient information to enable the operator to rectify apparent faults or else to identify where the suspect fault might be. It is assumed that fault-finding has already been performed at a system level.

Warning: Do not remove the covers of this equipment. Hazardous voltages are present within this equipment and may be exposed if the covers are removed. Only Network trained and approved service engineers are permitted to service this equipment.

Caution: Unauthorised maintenance or the use of non-approved replacements may effect the equipment specification and invalidate any warranties.

This manual does not provide any maintenance information or procedures which would require to removal of covers.

If the following information fails to clear the abnormal condition, please contact your local reseller or Network customer care.

6.4.2 Preliminary Checks

Always investigate the failure symptoms fully, prior to taking remedial action. The operator should not remove the cover of the equipment to carry out the fault diagnosis. The following fault-finding tasks can be carried out:

- o Check that the PSU LED is lit. If this is not lit, replace external equipment, power source and cables by substitution to check that they are not defect.
- o Confirm that the equipment hardware configuration is suitable for the purpose and has been correctly connected.
- o Confirm that inappropriate operator action is not causing the problem, and that the equipment software set-up is capable of performing the required functionality.
- o Check that the fans are unobstructed and working correctly.

When the fault condition has been fully investigated, and the symptoms are identified, proceed to fault-finding according to the observed symptoms. If the fault persists, and can not be rectified using the instructions given in this manual, contact Network Customer Support. Switch off the equipment if it becomes unusable, or to protect it from further damage.

6.4.3 PSU LED Unlit / Power Supply Problem

If the ASI-IP-GTW PSU LED is unlit, fault-finding the problem is detailed in the following table.

Table 13. Power fault-finding

Step	Action	If the result of action is Yes...	If the result of action is No...
1	Check the Power LED. Is the LED unlit, but the Video Gateway still working properly?	If the Video Gateway is working normally then the Power LED itself is probably at fault - Call a Service Engineer.	Proceed to next step
2	Check the Power Source. Connect a known-working equipment to the power source outlet. Does it work?	The problem lies within the ASI-IP-GTW or the power cable. Proceed to next step.	The problem lies with the power source. Check building circuit breaks, fuse boxes source outlet. Does it work? If problem persists, contact the electricity supplier.
3	Check Power Cable. Unplug power connector and try it in another piece of equipment. Does it work?	The problem lies within the ASI-IP-GTW. Call a Service Engineer.	The problem lies with the cable. Replace the cable.

The PSU does not have any user changeable fuses.

6.4.4 Fan(s) Not Working / Overheating

This equipment has forced air cooling and must not be operated unless all cooling fans are working. In the event of overheating problems, refer to table.

Note: Failure to ensure a free air flow around the unit may cause overheating.

Step	Action	If the result of action is Yes...	If the result of action is No...
1	Check Fan Rotation. Inspect the fans located at the sides of the unit. Are the fans rotating?	Check that the Video Gateway has been installed with sufficient space allowed enclosure for air flow. If the air is too hot, additional cooling may be required.	Possible break in the dc supply from the PSU module to the suspect fan(s). Call a Service Engineer.

6.4.5 Alarm LED lit / Alarm condition

The alarm LED on front and rear will light when a critical alarm occurs.

The following table describes the different alarm conditions and what might be the cause of these alarms.

Table 14. Alarm condition description.

Alarm	Description	Error source
Bitrate regulation in progress	The regulation algorithm is working with bitrate estimation.	This alarm may stay on the first minutes after tuning to a new IP stream. If the alarm does not clear, the input stream may be a variable bitrate stream.
SNTP server unreachable	Unit is unable to connect to SNTP server.	There is no SNTP server on the configured IP address or there is no contact with the SNTP server due to network problems.
No sync	No valid ASI input stream detected.	The problem can be related to a problem with the sending device or the cable.
Too high temperature	Internal temperature of unit is too high.	The fans are not working or forced cooling is required.
Sequence error	Analysis of the sequence number of the RTP layer indicates that IP frames have been lost or that they have been received out of order	Typically this error is generated by packets being dropped by some equipment in the network, f.ex when a link is overloaded.
Defective fan	There is an error with fan of the unit	Hardware problem.
No data received	No data received on Ethernet input for stream	The most likely error is that there is a set-up problem where IP address and UDP port are not correctly configured. The error can result from an error with the transmitting unit or an error on the network.
No lock	The IP receive channel is not able to find an initial bitrate for the data received.	The stream contains a PCR PID with an invalid clock reference.
Data lost	Stream received is incomplete and a valid ASI output can not be expected	See 'Sequence errors'. If you have 'Sequence errors' but not 'Data lost', all frames are received but they are out of sequence, or enough data is received for the FEC engine to correct all lost frames.
ARP unresolved	IP address not resolved into physical MAC address.	This error may be caused by wrong default gateway configured, wrong unicast IP address on same subnet or unit on same subnet does not respond.
Ethernet link down	No link on Ethernet layer	No connection on physical layer.
Input buffer overflow	The total bitrate of the IP input streams is too high.	There is a configuration error or one of the sources is generating a too high bitrate.
Output buffer overflow	The total bitrate of the ASI input streams is too high.	There is a configuration error or one of the sources is generating a too high bitrate.

The description of the severity levels of the different alarms are given in Section 5.2.6.

6.5 Disposing of this Equipment

6.5.1 General

Dispose this equipment safely at the end of its life time, Local codes and/or environmental restrictions may affect its disposal. Regulations, policies and/or environmental restrictions differ throughout the world and they might have changed since you acquired this equipment. Please contact your local jurisdiction or local authority for specific advice on disposal.

6.6 To return the unit

Before shipping the ASI-IP-GTW to Network, contact your local Network reseller or Network directly for additional details.

- o Write the following information on a tag and attach it to the ASI-IP-GTW.
 - o Name and address of the owner
 - o Model number
 - o Serial number
 - o Description of service required or failure indication
- o Package the ASI-IP-GTW.
 - o You can use the original shipping containers or adequate other packing containers
- o Seal the shipping container securely, and mark it FRAGILE.

7 Appendix A: Glossary

1000Base-T: The term for the Electrical Gigabit Ethernet interface. This is the most common interface for Gigabit Ethernet. Most Gigabit-enabled PCs and equipment use this interface.

ARP: Address Resolution Protocol. A protocol used to "resolve" IP addresses into underlying Ethernet MAC addresses.

ATSC: Advanced Television Systems Committee. An American organisation working with standardisation of digital television broadcasts, primarily in the US but also in Asia and other parts of the world.

DiffServ: Differentiated Services. A mechanism used on layer 3 - e.g. the IP layer - to differentiate between traffic of various types. DiffServ is based on the ToS field and provides a mechanism for the network to give e.g. video traffic higher priority than other traffic (for example Internet traffic).

DVB: Digital Video Broadcasting. The European consortium defining standards for transmission of digital TV broadcasts, primarily in Europe.

DVB ASI: Digital Video Broadcasting Asynchronous Serial Interface. A common physical interface for transmission of MPEG2 Transport Streams (i.e. MPEG2-compressed video) over a serial interface, typically coaxial cables.

DWDM: Dense Wavelength Division Multiplexing. A mechanism to utilize existing fiber with even more bandwidth by adding extra signals using other wavelengths/colors.

Ethernet: Originally a 10Mbit/s shared medium network type developed by Xerox. Later transformed into an official standard. Nowadays, most Ethernet networks are based on full duplex connections over twisted pair cables. Ethernet switches in the network take care of routing Ethernet frames between nodes. The speeds now supported are 10Mbit/s, 100Mbit/s and 1000Mbit/s. 10Gigabit/s Ethernet networks are now emerging.

FEC: Forward Error Correction. A mechanism to add extra data to a transmission in order to protect it. Dependent on the amount of extra data added, the receiver will be able to correct errors (i.e. regenerate lost packets) in case of network packet loss.

HDTV: High Definition Television. The new, coming television standard(s) that gives clearer and more detailed TV pictures. Many TV sets sold today (especially flat-screen TVs) are prepared for high definition TV.

HTTP: HyperText Transfer Protocol. The fundamental protocol used on the Internet for transmission of WEB pages and other data between servers and PCs.

ICMP: Internet Control Message Protocol. ICMP messages, delivered in IP packets, are used for out-of-band messages related to network operation or mis-operation.

IGMP: Internet Group Management Protocol. IGMP is a protocol used to manage multicasts on the Internet. For a host (receiver unit) to receive a multicast, it needs to transmit IGMP "join" messages on the right

format. Three versions exist. IGMPv2 is common today but IGMPv3 is the next step.

Meta-data: Meta-data is descriptive data that is "tagged" to a movie or audio clip. Meta-data is essential for the broadcaster.

MPEG2: Moving Picture Experts Group 2. The compression standard used today on most satellite and cable TV digital broadcasts.

MPLS: Multi-protocol Label Switching. A Quality of Service mechanism for IP networks that allow IP packets to flow along a predefined path in a network, improving the reliability and robustness of the transmission.

MPTS: Multi Program Transport Streams. Transport Streams that carry multiple TV/Radio services.

Multicast: An IP mechanism that allows transmission of data to multiple receivers. A multicast can also have several transmit sources simultaneously. In video applications, multicast is typically used to distribute a video signal from a central source to multiple destinations.

NMS: Network Management System. A system used to supervise elements in an IP network. When a device reports an alarm, the alarm will be collected by the NMS and reported to the operator. NMS systems typically collect valuable statistics information about the network performance and can warn the operator early.

PCR: Program Clock Reference. A sampled 27MHz video clock used in MPEG2 Transport Streams. The primary purpose of the PCR is timing synchronization between transmitter and receiver.

PSI/SI: Program Specific Information / Service Information. This is information tables (meta-data) that is carried in MPEG2 transport streams in addition to video and audio. The information carried is typically service/program IDs, program names, conditional access information etc.

QAM: Quadrature Amplitude Modulation. A digital modulation type that is used for transmission of digital TV signals over cable TV networks. Often referred to as DVB-C.

QoS: Quality of Service. A common term for a set of parameters describing the quality you get from an IP network: Throughput, availability, delay, jitter and packet loss.

QPSK: Quadrature Phase-Shift Keying. The digital modulation type typically used for transmission of digital TV signals over satellite. Often referred to as DVB-S.

RIP2: Routing Information Protocol v2. A protocol used between network routers to exchange routing tables and information.

RSVP: ReSerVation Protocol. A Quality-of-service oriented protocol used by network elements to reserve capacity in an IP network before a transmission takes place.

RTP: Real-time Transfer Protocol. A protocol designed for transmission of real-time data like video and audio over IP networks. RTP is used for most video over IP transmissions.

SDI: Serial Digital Interface. Also known as ITU-R BT.656. A specification describing how to digitize and transmit uncompressed video signals. The typical bit rate of an SDI signal is 270Mbit/s.

SDP: Session Description Protocol. A protocol to signal multicasts in a network. SDP is used as a mechanism to describe an ongoing multicast; for example the type of compression used, IP addresses etc.

SDTI: Serial Data Transport Interface. A mechanism that allows transmission of various types of data over an SDI signal. This may be one or more compressed video signals or other proprietary data types. The advantage of SDTI is that existing SDI transmission infrastructure can be used to transport other types of data.

SDTV: Standard Definition Television. The normal television standard/resolution in use today.

SFP: Small Form-factor Pluggable module. A standardized mechanism to allow usage of various optical interfaces for Gigabit Ethernet. Several types of SFP modules exist: Single mode fiber modules for long-distance transmission and multi mode fiber modules for shorter distances. SFP is also known as "mini-GBIC".

SIP: Session Initiation Protocol. A common acronym for the ongoing effort to standardize *signalling* over IP networks, i.e. connection setup and tear-down. SIP makes it possible to "dial" a remote receiver of data and set up the connection in this way.

SNMP: Simple Network Management Protocol. A fundamental and simple protocol for management of network elements. Very common in use today by most Network Management Systems and other applications.

SNTP: Simple Network Time Protocol is an Internet protocol used to synchronize the clocks of computers to some time reference. It is a simplified version of the protocol NTP protocol which is too complicated for many systems.

SPTS: Single Program Transport Streams. A Transport Stream that contains a single program/ service.

TCP: Transmission Control Protocol. A protocol above the IP layer that provides automatic retransmission of datagrams in case of packet loss, making it very robust and tolerant against network errors. TCP is the fundamental protocol used in the Internet for WEB traffic (HTTP protocol). TCP is indented for point-to-point protocol; you cannot use TCP for communication from one node to many others.

TCP/IP: A common term used for the Internet protocol *suite*, i.e. the set of protocols needed to get fundamental IP network access: TCP, IP, UDP, ARP etc.

ToS: Type of Service. This is a field in the header of IP datagrams to provide various service types. It has now been "taken over" and reused by DiffServ.

Transport Streams: The common name for MPEG2 Transport Streams. A bit stream used to carry packets with MPEG-2 compressed video. A transport stream typically carries approximately 10 compressed TV channels, but can consist of an arbitrary number of TV and Radio services.

UDP: User Datagram Protocol. A protocol above the IP layer that provides *port multiplexing* in addition. In essence, you can transmit IP data packets to several receiving processes in the same unit/device.

Unicast: Point-to-point connection, i.e. the "opposite" of multicast which is one to many (or many to many). In this mode, a transmit unit sends video data direct to a unique destination address.

VLAN: Virtual LAN, a network of units that behave as if they are connected to the same wire even though they may actually be physically located on different segments of a LAN.

Watermarking: A mechanism to "stamp" video content with unique marks, making it possible to trace the origins of illegally distributed content. The marks are invisible for the viewer.

XML: eXtensible Markup Language. A very common self-describing text-based data format. Used for many purposes: Meta-data, configuration files, documents, etc. The readability of the format has made it very popular and is now the fundament for many types of WEB services.

8 Appendix B: Technical Specification

8.1 DVB ASI port

Table 15. DVB ASI Port Specification

Item	Specification
Type	ASI-C, Coaxial cable
Connector type	BNC 75 ohm socket
Signal	Compliant with ETSI TR 101891v 1.1.1 (DVB A010 rev.1)
Line rate	270Mbit/s \pm 100ppm
Data rate	0,1-213Mbit/s
Packet length	Input: 188 or 204 bytes Output: 188 bytes
Maximum cable length (Belden 8281 type)	300m typical
Safety status (UK)	SELV

8.2 Ethernet data port

Table 16. Ethernet Data Port Specification

Item	Specification
Maximum ASI data rate	680 Mbit/s
Maximum IP data rate	700 Mbit/s
Protocols :	
Link layer:	IEEE Std 802.3-2002
VLAN:	IEEE Std 802.1q
Transport layer:	RFC 760
UDP:	RFC 768
RTP:	RFC 1889, RFC 3550, RFC 2250, Pro-MPEG CoP3, rev.2
FEC:	RFC2733, Pro-MPEG CoP3, rev.2
DVB/MPEG-2:	ISO/IEC 13818-1:2000

Table 17. Electrical Ethernet Data Port Specification

Item	Specification
Type	IEEE Std 802.3-2002, 10/100/1000Base-T
Connector type	RJ45
Safety status (UK)	SELV

Table 18. Optional SFP Ethernet Data Port Specification

Item	Specification
Type	Gigabit Ethernet, Small Form-Factor Pluggable (SFP) slot to carry copper or optical SFP, compatible with approved modules conforming to the Small Form-factor Pluggable Transceiver MultiSource agreements (Sept.14, 2000).

8.3 Ethernet management port

Table 19. Ethernet Management Port Specification

Item	Specification
Type	10/100Base-T
Connector type	RJ45
Safety status (UK)	SELV

8.4 Alarm relay and maintenance port specification

Table 20. Alarm Relay and Maintenance Port Specification

Item	Specification
------	---------------

Item	Specification
Connector type	9-pin DSUB Male
RS232 baudrate	115,2 kbaud
RS232 framing	8 bit, no parity, 1 stop bit
RS232 handshake	None
Relay rating	0.1 A max, 50 Vdc max
Relay minimum load	10 μ A at 10 mVdc
Pins	<ol style="list-style-type: none"> 1. NC 2. RS232 Receive Data (input) 3. RS232 Transmit Data (output) 4. NC 5. Ground 6. Alarm on 7. Alarm relay common 8. Alarm off 9. NC
Safety status (UK)	SELV

8.5 AC Mains Input

Table 21. AC Power Supply Specification

Item	Specification
Rated voltage	100-240 VAC
Voltage tolerance limits	85-264 VAC
Rated frequency	50/60 Hz
Rated current	0.7 A
Power consumption	< 50 W

8.6 DC Mains input

Table 22. DC Power Supply Specification

Item	Specification
Rated voltage	48 VDC
Voltage tolerance limits	36-72 VDC
Power consumption	< 60 W

8.7 Physical Details

Table 23. Physical details

Item	Specification
Height	43 mm, 1U
Width	222 mm excluding fixing brackets
Overall width	485 mm including fixing brackets
Depth	320 mm excluding connectors
Overall depth	340 mm including connectors
Approximate weight	3 kg
Rack-mount case	19 inch width, 1 U height

8.8 Environmental Conditions

Table 24. Environmental specification

Item	Specification
Operational temperature	0°C to +50°C
Storage temperature	-20°C to +70°C
Relative humidity	5% to 95% (non-condensing)
Handling/movement	Designed for fixed use when in operation

8.9 Compliance¹

8.9.1 Safety

The equipment has been designed and tested to meet the requirements of the following:

EN60950	European	Safety of information technology equipment including business equipment.
IEC 60950	International	Safety of information technology equipment including business equipment.

In addition, the equipment is designed to meet the following:

UL 1950	USA	Safety of information technology equipment including business equipment.
---------	-----	--

8.9.2 Electromagnetic Compatibility - EMC

The equipment has been designed and tested to meet the requirements of the following:

EN 55022 and AS/NZS 3548	European Australian and New Zealand	Emission Standards Limits and methods of measurement of radio frequency interference characteristics of information technology equipment – Class A
EN 61000-3-2	European	Electronic Compatibility (EMC), Part 3 Limits, Section 2.

¹ The version of the standards shown is that available at the time of manufacture.

		Limits for the harmonic current emission.
EN 50082-1	European	Generic Immunity Standard Part 1: Domestic, commercial and light industry environment.
FCC	US	Conducted and radiated emission limits for a Class A digital device, pursuant to the Code of Federal Regulations (CFR) Title 47- Telecommunications, Part 15: radio frequency devices, subpart B – Unintentional Radiators.

8.9.3 CE Marking

The CE mark is affixed to indicate compliance with the following directives:

- o 89/336/EEC of 3 May 1989 on the approximation of the laws of the Member States relating to electromagnetic compatibility.
- o 73/23/EEC of 19 February 1973 on the harmonisation of the laws of the Member States relating to electrical equipment designed for the use within certain voltage limits.
- o 1999/5/EC of March 1999 on radio equipment and telecommunication terminal equipment and the mutual recognition of their conformity.

o

8.9.4 Interface to “public telecommunication system”

The equipment is not constructed for electrical connection directly to a "public telecommunication system". None of the signals shall be connected directly from the unit to a "public telecommunication system" leaving the building without using some kind of interface in between such as a telecom terminal, switch or similar unit. Such kind of buffer is required to achieve a protective electrical barrier between the "public telecommunication system" and the unit. This electrical barrier is required to achieve protection against lightening or faults in nearby electrical installations.

9 Appendix C: References

- o ISO13818-1,2 and 3: MPEG-2 Video and Audio and Systems
- o EN 300 468: Digital Video Broadcasting (DVB); Specification for Service Information (SI) in DVB systems
- o RFC 1889 - RTP: A Transport Protocol for Real-Time Applications.
- o RFC 3550 - RTP: A Transport Protocol for Real-Time Applications.
- o RFC 2733 - RTP: An RTP Payload Format for Generic Forward Error Correction.
- o RFC 2250 - RTP: RTP Payload Format for MPEG1/MPEG2 Video
- o RFC 3497 - RTP: Payload Format for Society of Motion Picture and Television Engineers (SMPTE) 292M Video
- o RFC 3376 - IGMP: Internet Group Management Protocol, Version 3
- o RFC 2236 - IGMP: Internet Group Management Protocol, Version 2
- o RFC 0791 - IPv4: Internet Protocol
- o RFC 3261 - SIP : Session Initiation Protocol
- o RFC 0793 - TCP : Transmission Control Protocol
- o RFC 0792 - ICMP: Internet Control Message Protocol
- o RFC 0768 - UDP : User Datagram Protocol
- o RFC 0959 - FTP: File Transfer Protocol
- o RFC 2068 - HTTP: Hypertext Transfer Protocol -- HTTP/1.1
- o RFC 0764 - Telnet: Telnet Protocol specification
- o RFC 1157 - SNMP: Simple Network Management Protocol (SNMP)
- o RFC 2030 - SNTP: Simple Network Time Protocol (SNTP) Version 4 for IPv4, IPv6 and OSI
- o RFC 3497 - RTP Payload Format for Society of Motion Picture and Television Engineers (SMPTE) 292M Video
- o RFC 3550 - RTP: A Transport Protocol for Real-Time Applications
- o Pro MPEG Forum Code of Practice 3 version 2: Transmission of Professional MPEG-2 Transport Streams over IP Networks
- o Pro-MPEG Code of Practice \#4 release 1 July 2004 Transmission of High Bit Rate Studio Streams over IP Networks

10 Appendix D: Upgrade of Features

The ASI-IP-GTW ASI to IP Video Gateway encompasses software licensing of functionality. This appendix describes how to upgrade the product features with the software feature system.

Customers who purchase "base" software licenses may wish to increase their software functionality or feature set at some point. A feature license conveys the right to use a feature, but cannot add a feature to a software release that does not support it.

The following table describes which functionality is currently available through software licenses:

Table 25. Functionality enabled through software licenses

Functionality	Max value	Description
Number of enabled ports	8	The number of ASI ports enabled. This can be different from the number of ports physically mounted.
Data port max. speed:	1000Mbit/s	The speed of the data port can be 100Mbit/s or 1000Mbit/s.
Connect Control	NA	Enabled control of the unit through the Connect software.
Forward Error Correction	NA	Pro-MPEG Forward Error Correction enabled for use on all streams.
Bi-directional operation	NA	Enables simultaneous transmission and reception of MPEG2 data on the Ethernet data interface.

When you order upgrade of functionality on your ASI-IP-GTW, you will receive a license key on email. Figure 37 shows the format of the license key. The license key is an encrypted code linked to the serial number of the unit to be upgraded.

```

-----
6ysyqeGI/3vcJVAWmxv6oJ9EJZQLEE0NzEBkjUzA
/rTozK6ZqTH0g70XBFow7pmDq0yVdtnwSleHrcGM
LgewY1PXwW0lwHc7flvDq6wsGnv6ZINHymeljiEP
0mk5K5D7IEKICxxsR9BP4ab90V08xBy8hk2OVSeq
DHx7iTLsnryP9IXydyM01J3I3yMGzoKSvkSd9ZyV
7w8xNF+q1KLjYMRKc1p5QE3TVUdjM+PjV3IPOkjl
36uWwIPKQjybdBD372DSyGXoudiwP+YZihuLNcmD
JmgOc12yctrfGwzXum72McNUM/oKtURptnupiuFX
kWHljxHKomJRkPv90IIMQLNIbE41Gp6YwC/cQYpD
vIvQJX5fmVvfwPNL6hIXuF9yORfZpN7PJ6883nye
IM2pdMgo3kLzMTwXTNTbdzK56Ngxfc5wKEL7HsDQ
7JN2BytuctrfGwzXum7dOaxAmr5IVERptnupiuFX
4en1cXPkGnRRkPv90IIMQHZHsI2bHY5DitH3nha8
Jd7QJX5fmVvfwPNL6hIXuF9y+8Qe8v1I2FYQ/pIC
2KRICsgo3kLzMTwXTNTbdzK56NjoFEBEDicW8DQ
7JN2BytuKelcSUunCXjKx401PRpXpw==
-----
    
```

Figure 37. Format of feature key

In order to upgrade the unit, open the web page "http://<ip_address_of_unit>/upgrade"

(ex. <http://192.168.0.100/upgrade>).

Figure 38 shows the feature upgrade page. Please paste in the license key in the "Activate feature key" field and press the button "Activate feature key" to load a new feature key for the unit.

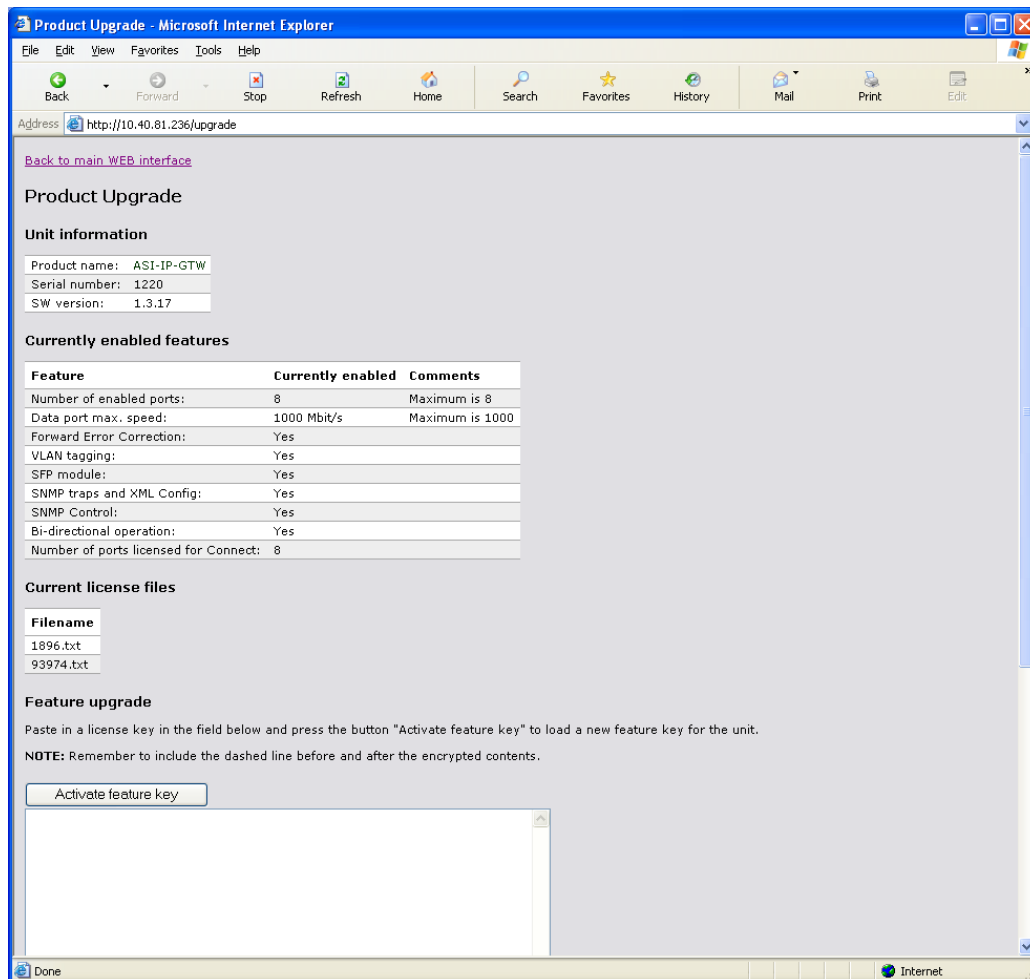

Figure 38. Feature upgrade page

Note: Remember to include the dashed line before and after the encrypted contents.

The dialogue shown in Figure 39 will appear when a valid license key is downloaded to the unit.

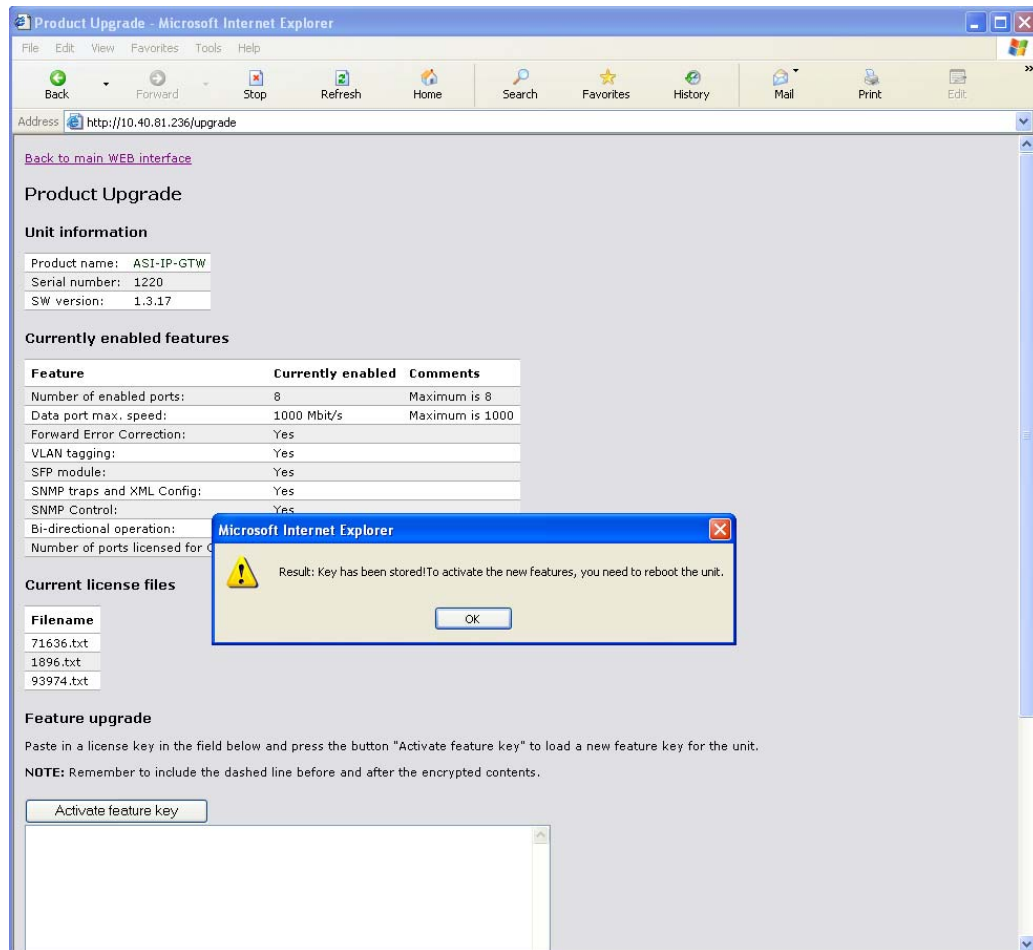

Figure 39. Feature upgrade dialogue

Note: Please observe that you have to switch off and on the unit to active the new keys.

In addition to the feature upgrade field, the Upgrade-page contains information about the unit and currently enabled features.

The license files already entered to the unit are listed under current license files. A license key can contain license to one or more features. The feature set of the unit is always the sum of the features from all the license keys entered.

11 Appendix E: Upgrading Software

SW loading can be performed from the bottom of the /upgrade page, as shown in Figure 40.

This option is available on SW versions 1.3.0 and above. To load SW on older SW versions, please refer to documentation on how to load SW by FTP.

Press the 'Browse' button and select the file to load to the device. The file must have the filename extension '.out'. Then press the 'Upload Software' button to start the SW loading.

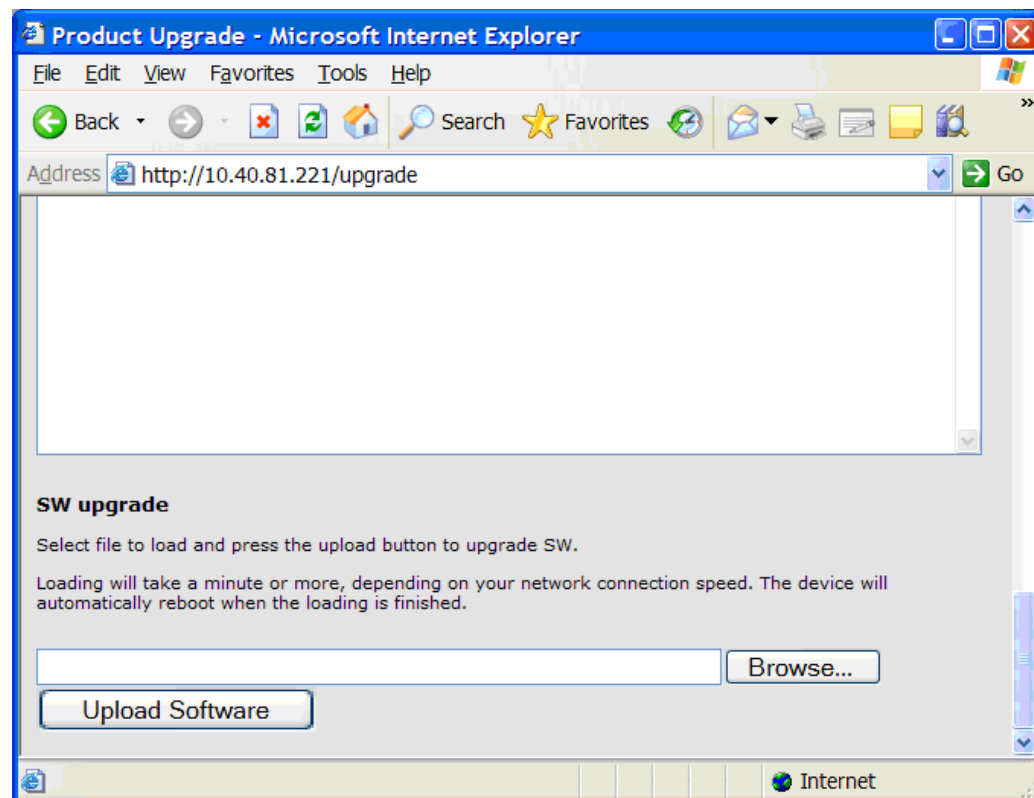

Figure 40 Upgrade SW

File loading from this page uses HTTP port 80, making it useful to pass through firewalls. If you have not blocked pop-ups in your browser, a progress meter (Figure 41) is displayed during file transfer. By pressing the 'cancel' button the transmission can be cancelled. If you do not see the progress meter, the SW loading can still be interrupted by pressing the stop button in your browser.

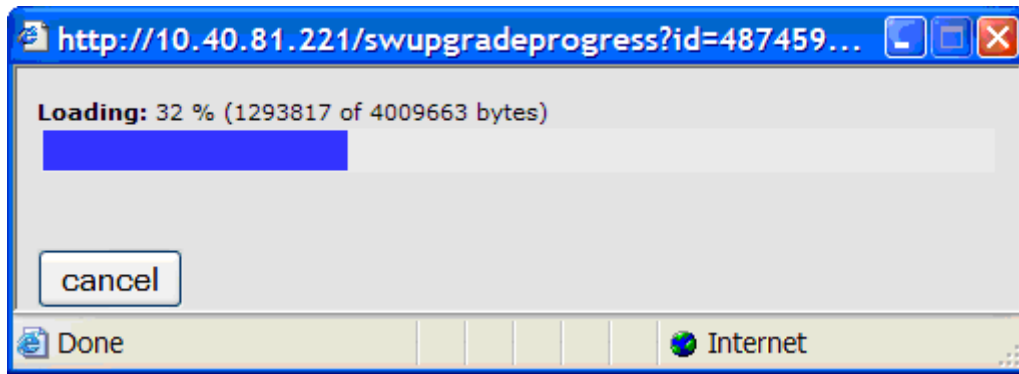

Figure 41 SW load progress

When the file is transferred, a status message is printed in the main browser window. If the loading was successful, the device is automatically rebooted to start the new SW.

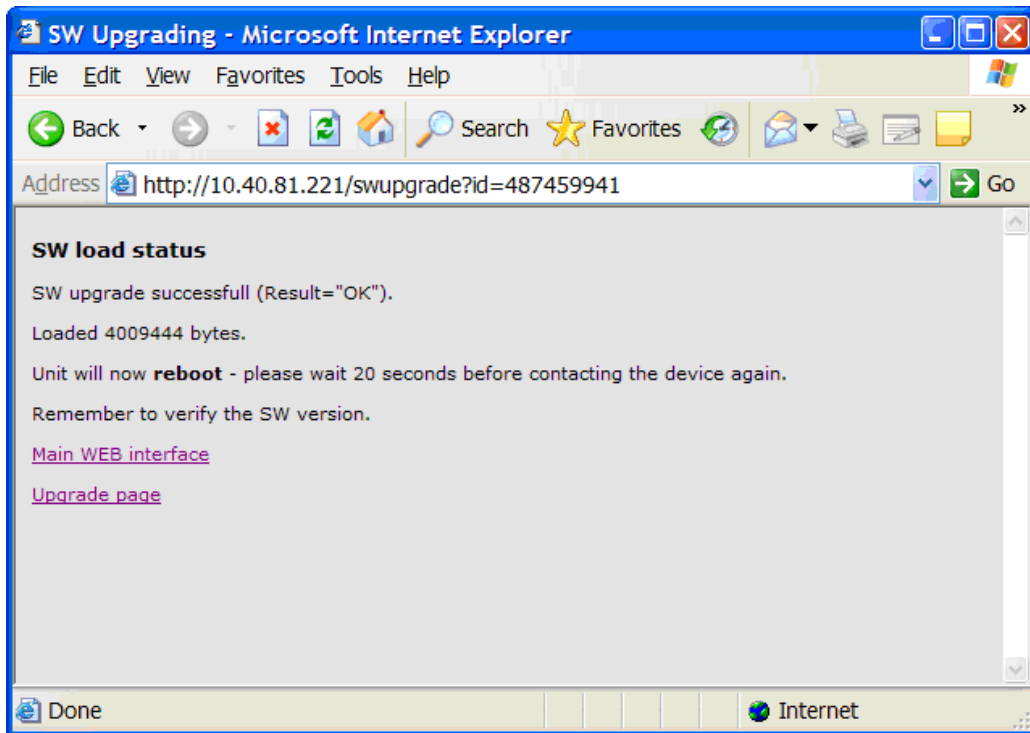

Figure 42 SW load status

Please remember to verify the new SW version on the 'Device Info' page after the device has re-booted.

12 Appendix F: Quality of service – Setting Packet priority

Normal IP routing is by best effort. This does not work well for broadcast television as the video and audio components needs to be transport as a continuous flow of packets without inference caused by other traffic over the internet. There are different techniques to secure a high quality of service. The main ones are:

- o MPLS (Multi Protocol Label Switching)
- o Layer 3 routing priority
- o Layer 2 routing priority

12.1 MPLS

In networks running MPLS, the packets are forwarded along a predefined path from an ingress router to an egress router. Packet switching is then done according to the label and packets will be switched expediently. The MPLS label is added to the IP packet by the ingress router and removed on the egress router. The labelling is done on the basis of packet classification.

12.2 Layer 3 Routing

An alternative technique to get QoS is to use layer 3 routing and give video content packets higher priority than other data. IP packets are put into queues according to their priority. Packets with high priority are forwarded expediently and have a lower probability to being discarded due to buffer overflow.

There are two ways prioritize IP packets called **Differentiated services (Diff-serve)** or by the **precedence bits (TOS)**. Both these method use the same bits in the IP header and both of them are in common use.

IP precedence values range from 0 to 7.

DSCP values range from 0 to 63.

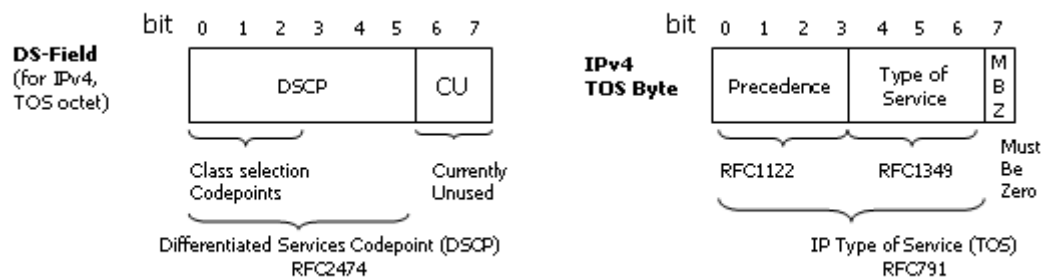

Figure 43 Differentiated services (Diff-serve) or by the precedence bits (TOS)

Layer 3 prioritisation may also be combined with MPLS where layer 3 routing is used in the aggregation network and MPLS in the core network. The DSCP priority setting may be used for MPLS tagging.

1.1.1.37 ASI-IP-GTW Configuration

The number entered into the **Type of service (TOS)** field on ASI-IP-GTW IP TX configuration menu defines all 8 bits. The value used should be in accordance with traffic engineering policy of network and should be in the range from 0 to 255.

12.3 Layer 2 priority

Prioritisation can also be supported at layer 2 for the case when VLAN tags. The 802.1q VLAN tag has 3 bits for setting the Class of Service (COS). The operation is further defined in 802.1p. The COS bits will be handled in the same ways as diff-serv or precedence bits with regard to packet classification in the network

1.1.1.38 ASI-IP-GTW Configuration

The COS priority is entered on the VLAN configuration tab on the ASI-IP-GTW IP TX configuration menu, in the field named **VLAN Priority**. A value in the range from 0 to 7 should be inserted. This value will be directly transferred to 3 user priority bits in the VLAN header.

More information on quality of service issues and configuration can be found in the literature e.g. router configuration guides.

Free Manuals Download Website

<http://myh66.com>

<http://usermanuals.us>

<http://www.somanuals.com>

<http://www.4manuals.cc>

<http://www.manual-lib.com>

<http://www.404manual.com>

<http://www.luxmanual.com>

<http://aubethermostatmanual.com>

Golf course search by state

<http://golfingnear.com>

Email search by domain

<http://emailbydomain.com>

Auto manuals search

<http://auto.somanuals.com>

TV manuals search

<http://tv.somanuals.com>