

NODEMUX™ HD Series

ST-nXm-U-HD (Multi-user / Universal KVM Switch)

INSTALLATION / USER GUIDE

MAN001 Rev Date 1/6/2003



WARRANTY INFORMATION

The warranty period on this product (parts and labor) is one (1) year from the date of purchase. Please contact Network Technologies Inc at **(800) 742-8324** (800-RGB-TECH) or **(330) 562-7070** or visit our website at <http://www.nti1.com> for information regarding repairs and/or returns. A return authorization number is required for all repairs/returns.

COPYRIGHT

Copyright © 2003 by Network Technologies Inc. All rights reserved. No part of this publication may be reproduced, stored in a retrieval system, or transmitted, in any form or by any means, electronic, mechanical, photocopying, recording, or otherwise, without the prior written consent of Network Technologies Inc, 1275 Danner Drive • Aurora, Ohio 44202

CHANGES

The material in this guide is for information only and is subject to change without notice. Network Technologies Inc reserves the right to make changes in the product design without reservation and without notification to its users.

Table of Contents

Introduction	1
Definitions.....	1
Limitations	1
Compatibility.....	1
Ordering Information	1
Features and Functions.....	2
Additional Features	3
Installation	4
Using the ST-nXm-U-HD Switch	6
Basic Operation	6
Keypad Control	6
OSD Control.....	7
Security Feature.....	7
Enabling The Security Feature.....	7
User Login Mode.....	8
Additional OSD Modes Available With Security	8
Administration Functions	8
Administration Options	8
Port Status Mode	9
Administrator Password	9
User Name List.....	10
System Access List	10
User Access Functions	11
Command Mode.....	11
Scan Mode	12
Edit Mode.....	13
Search Mode.....	13
Maintenance Mode.....	14
Help Mode.....	15
Keyboards	15
Key Equivalentents	15
SUN's Startup Keys	16
SUN's 14 Extra Keys.....	16
RS232 Control.....	17
Remote Connection	17
Baud Rate	17
Unit Address.....	17

Command Protocol.....	17
RS232 INTERFACE TEST PROGRAM DESCRIPTION	18
Matrix Switcher's Control Program For Windows 9X, NT, and 2000	20
Dual Redundant Power Supply	20
ST- MX Expansion Units	21
Safety and EMC Regulatory Statements	21

Table of Figures

Figure 1- Connect devices to switch using interface cables.....	4
Figure 2- Connect CPUs to switch using interface cables	5
Figure 3- User login screen	7
Figure 4- Administration Mode Menu.....	9
Figure 5- Administrator password menu	9
Figure 6- User Name List	10
Figure 7- Command Mode main menu	11
Figure 8- Maintenance Mode menu	14
Figure 9- Keyboard Layouts.....	16
Figure 10- RS232 Connections for Daisy-chain	17
Figure 11- Dual Redundant Power Supply Option	20

Appendices

Appendix A- Defaults	21
Appendix B- General Information.....	22
Appendix C- Cables	22
Appendix D- Rack mounting Instructions	22

Introduction

The NTI ST-nXm-U-HD (also known as NODEMUX-HD) is a multi-user / Universal Multi-Platform Matrix KVM switch, (n= number of users, m= number of CPUs) with high density construction to require less rack space. It allows multiple users, up to 4, each with a keyboard, monitor, and mouse, to communicate directly with any PS/2 or SUN workstation connected to the switch. A single switch can connect to 16 CPUs or up to 256 CPUs when switches are cascaded. These CPUs can be file servers, network managers, etc. The auto-boot circuitry in the NTI switch allows all CPUs to boot simultaneously without keyboard and/or mouse error.

Definitions

- CPU Enclosure that contains the operating system and processor
- User Device Keyboard or Mouse
- System One or more CPUs connected to one or more switches controlled by one or more user devices
- OSD On Screen Display

Limitations

- Only **VGA multi-scan Monitors** can be used with this product.

Compatibility

The ST-nXm-U-HD Universal Matrix KVM switch supports the following:

- Windows PS/2 CPUs
- SUN CPUs (including all SUN Ultras, SUN Blades and SUN Rays) (USB SUN CPU's need USB-SUN adapter)
- PS/2 laptops

Ordering Information

The ST-nXm-U-HD switch is built to a specific size ranging from 2 to 4 users and 8 to 16 CPUs. The switch is built at the factory based on the specified size ordered. The switch has high density connectors (similar to SCSI) for inputs and outputs that support PS/2 and SUN platforms and are configured with interface cables, see interface cable section. The "n" in the part number ST-nXm-U-HD represents the number of users. Select either 2 or 4 user switches. The "m" in the part number represents the number of CPUs. The switch is available with either 8 or 16 CPU ports. It is not necessary to connect a user or CPU to each port (ex. a ST-2x16 switch has the capability of supporting 16 CPUs, but can have only 10 CPUs connected and 6 empty ports.

ST-nXm-U-HD

Replace the "n" with either 2 or 4

Replace the "m" with either 8 or 16

The following list represents the available sizes that can be ordered:

ST-2x8-U-HD
ST-2x16-U-HD

ST-4X8-U-HD
ST-4X16-U-HD

Options

The following options are available for the ST-nXm-U-HD switch.

Dual Redundant Power supply

This feature ensures constant power to the unit.

Ordered by adding a -DRP suffix to the main part number.

Interface cables and adapters are not included and must be purchased separately.

A cable for each CPU being connected to the switch:

- PS/2 CPU to Switch
 - VMTINT-xx-MM for video, keyboard and mouse interface
- OR
- SUN CPU to Switch
 - SMTINT-xx-MM for video, keyboard and mouse interface
 - 13W3M-15HDF (adapter for 13W3 to 15HD)
 - USB-SUN Adapter (adapter for USB SUN CPU)

One of the following cables must be used to connect the keyboard/mouse and monitor:

- PS/2 keyboard/mouse VMTINT-xx
- OR
- SUN keyboard/mouse SMTINT-xx

where:

xx is the length of the cable in feet (3/6/10/15/25 foot cables available)
MM indicates male-to-male connector

Cables can be purchased from Network Technologies Inc by calling 800-RGB-TECH (800-742-8324) in the U.S. or (330) 562-7070 worldwide.

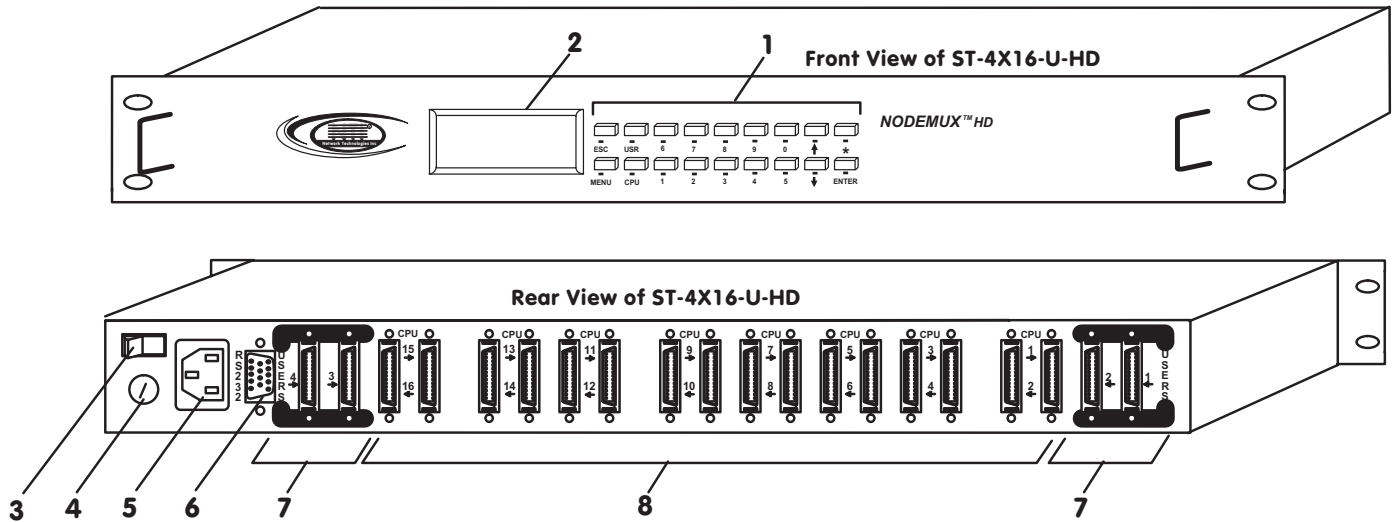

Features and Functions

1. Keypad buttons for user control over switch functions
2. LCD Display for visual indication of connection between the user and a specific CPU.
3. Power ON/OFF switch
4. Fuse Holder holder for replaceable overcurrent protection fuse
5. IEC Power Connector for attachment of power cord
6. RS232 for attaching RS232 interface cable from a CPU to control the functions of one or more switches
7. USER x high density female connectors for connection of user device interface cables
8. CPU x high density female connectors- for connection of CPU interface cables

Additional Features

- Users can work individually or share the same CPU.
- Up to n users can work with m CPUs where n and m are the switch size acquired.
- High density (similar to SCSI) input and output ports that interface cables plug into adapt to PS/2 and SUN platform devices.
- Power cycle circuit control allows the NTI switch to be powered OFF, then ON, at any time without affecting the attached CPUs.
- Power cycle circuit control allows the attached CPUs to be powered OFF, then ON, at any time without affecting the switch or other attached CPU.
- OSD enabled system with security features optionally enabled on a port by port basis.
- A microprocessor is dedicated to each CPU, preventing connected CPUs from locking up.
- Each connected CPU can boot without a keyboard or mouse.
- Keyboard and mouse interface cable can be hot-plugged during operation.
- LCD display on the front panel shows the CPU to which each user is connected.
- 10 connection setups can be saved in memory by the user for instant setup recall.
- No dip switches or jumpers necessary to configure.
- Video formats up to 1900X1200 can be displayed from all platforms. (A VGA multi-scan monitor must be used)
- User's keyboard and mouse can control the switch using the On Screen Display (OSD) of each user's connections :
 - Names can be assigned to the CPUs
 - Password security on a port-enabled basis.
- RS-232 control allows control of the switch with one CPU serial port.
- Power required is 110 or 220 VAC @ 50-60 Hz at less than 50 watts.
- ST-MX multi-console adapter is compatible for system expansion.

Installation

Turn **OFF** power to all CPUs that will be connected to the NTI ST-nXm-U-HD switch before connecting or disconnecting any cables.

1. If using RS-232 Control see RS-232 section for more information.
2. Connect the monitors to the 15HD female connector ends of the VMTINT-xx or SMTINT-xx cables, depending upon what type of devices will be connected (PS/2 or SUN). See Fig. 1.
3. Connect the keyboards to the purple 6 miniDIN female connector (PS/2) or orange 8 miniDIN female connector (SUN) of the VMTINT-xx or SMTINT-xx (respectively). If using a PS/2 mouse, connect it to the green 6 miniDIN female connector on the VMTINT-xx cable. See Fig. 1. Insure that the monitors and related keyboards are connected to the same interface cables.
4. Connect the high density male connector end of the cable to a USER x port on the ST-nXm-U-HD switch.

NOTE: If it is desired for only a monitor to be connected to a user port, the device cable end(s) of the VMTINT-xx / SMTINT-xx does not need to be connected to anything.

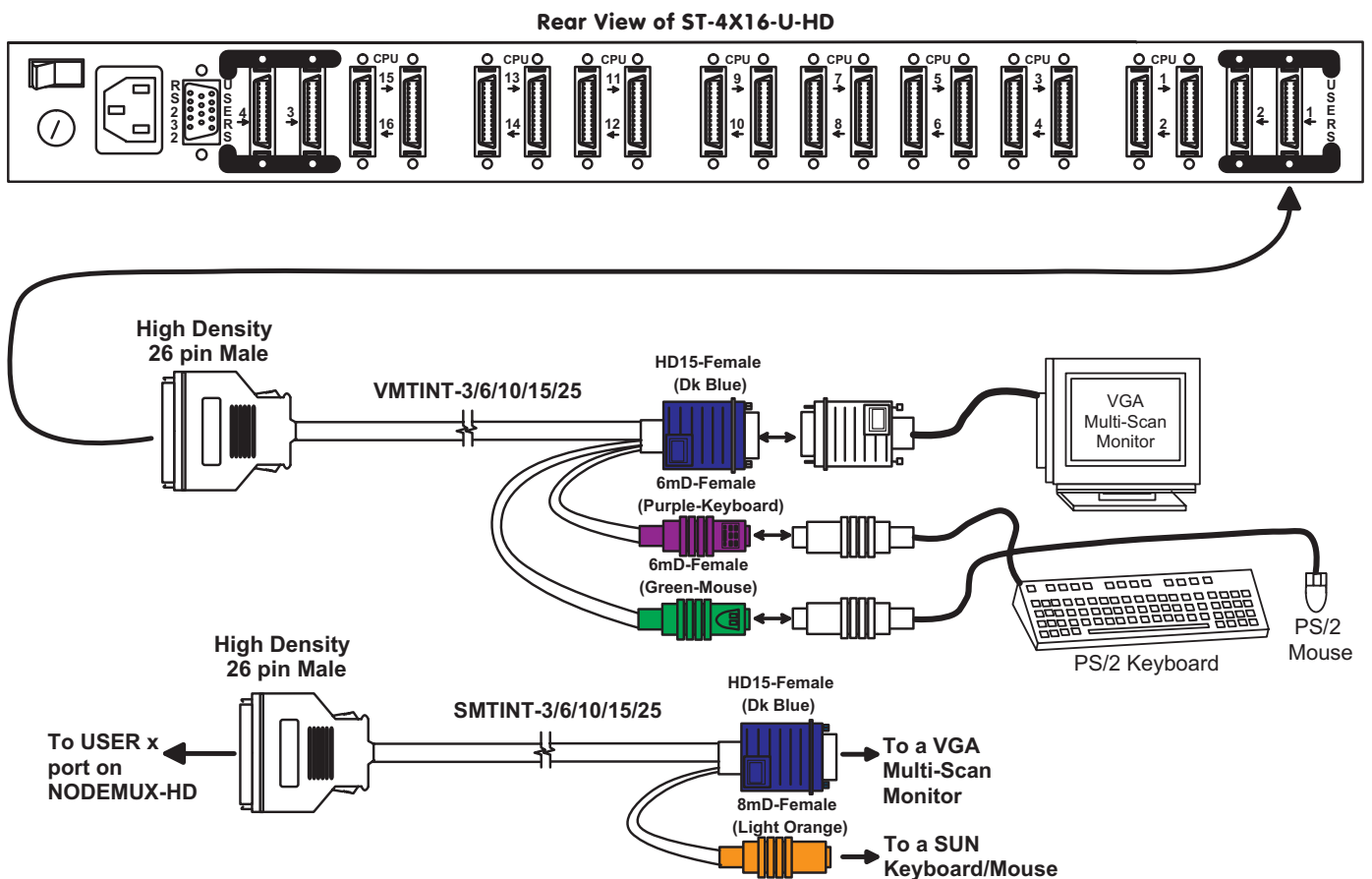

Figure 1- Connect devices to switch using interface cables

5. **For each CPU:** Connect a VMTINT-xx-MM (PS/2 CPU) or SMTINT-xx-MM (SUN CPU) or MMTINT-xx-MM (MAC CPU) cable to the devices port(s) and video port of the CPU as shown in Fig. 2.

NOTE: If the CPU is a SUN type with 13W3 video connector, use an NTI 13W3M-15HDF adapter to connect the SMTINT-xx-MM cable to the CPU.

NOTE: If the CPU only has a serial port for mouse connection (via a com port), a VOPEX-IM9D must be used to convert the signal from the serial port to PS/2 port. Do not use a 9D-to-6mD adapter, it will not work.

NOTE: For USB SUN CPUs, a USB-SUN adapter and a USB-AB-Xm cable must be used to connect the SMTINT-xx-MM cable to the CPU. See Fig. 2.

6. Connect the high density end of each cable to a CPU x port on the ST-nXm-U-HD switch. See Fig. 2.

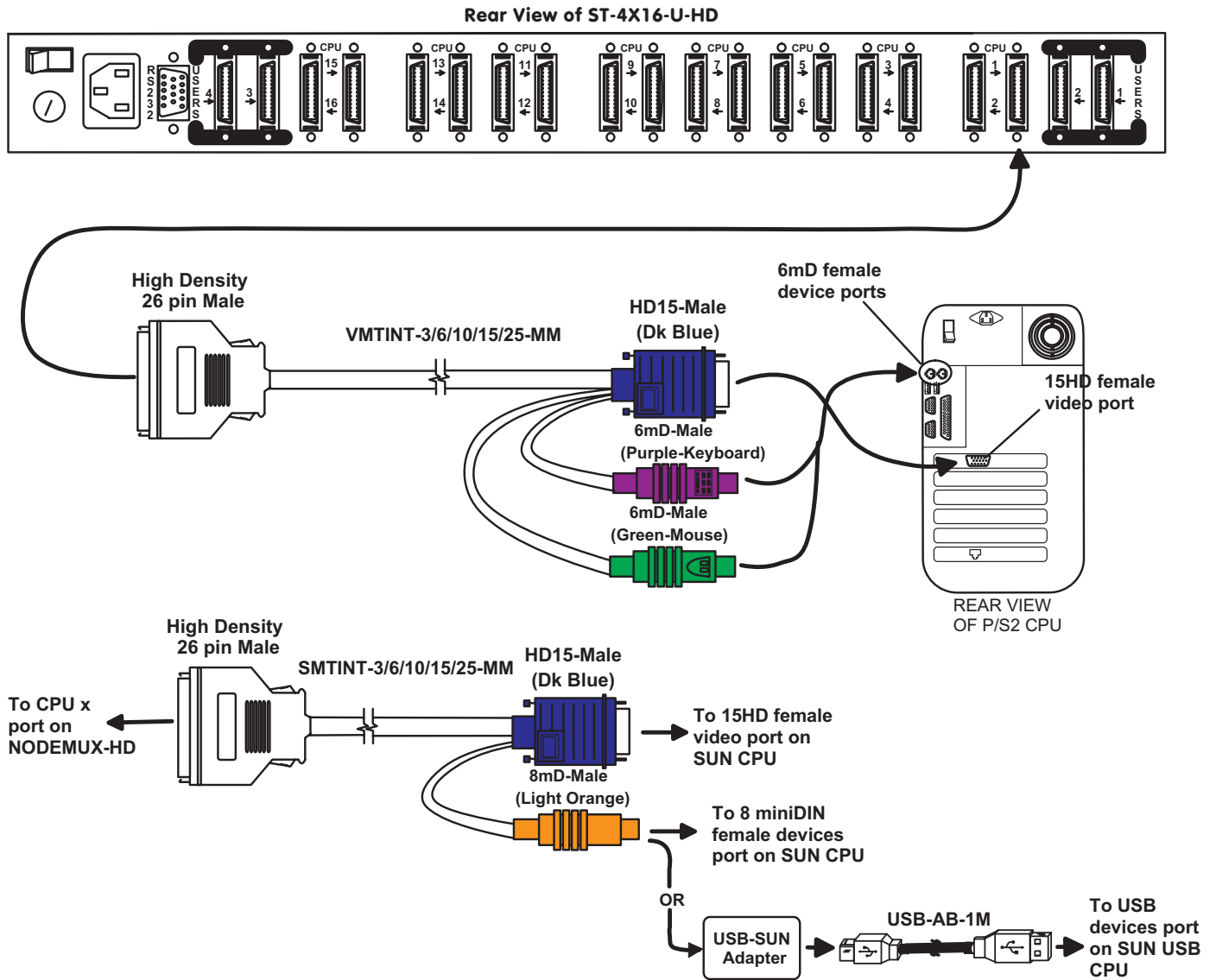

Figure 2- Connect CPUs to switch using interface cables

7. Plug the NTI Switch into an AC power outlet.
8. Turn ON power to the NTI Switch, the LCD should illuminate.
9. Turn ON power to any or all CPUs connected to the NTI Switch.

NOTE: The order in which the CPUs and switch are turned ON does not matter. A power strip can be used.

Using the ST-nXm-U-HD Switch

Basic Operation

This unit enables any user to access any CPU at any time with no restrictions or limitations. Users can even share a CPU and work on the same project – each from their own console. Resolution is supported through 1900x1200 with no degradation – guaranteed. A Liquid Crystal Display (LCD) on the front panel indicates the port to which the user is attached. The ST-nXm-U-HD can be controlled by three methods, front panel keypad control with LCD, keyboard control with on-screen display (OSD), and RS-232 interface.

Keypad Control

The front panel keypad and LCD display allow the user to monitor switch status and route any user to any CPU on the switch. Along with the routing of the inputs to the outputs the keypad and LCD allow the users to configure the RS-232 control interface. The keypad buttons perform the following functions:

<u>Key</u>	<u>Action</u>
ESC	Escape back to the main display.
0 – 9	Used to enter numbers. (<i>n</i>)
USR	The output user number can be entered (2 digits or 1 digit and ENTER) followed by the desired CPU to be connected to.
CPU	Used following single digit user entries.
ENTER	Used following single digit entries.
▲	Display next 4 users and the CPUs they are connected to. (See note below.)
▼	Display previous 4 users and the CPUs they are connected to. (See note below.)
MENU	The RS-232 menu is displayed. This allows the baud rate to be set at 9600, 2400, 1200 or 300 baud and the unit address to be set to 1 - 15. See RS-232 control on page 17.
*	Activate Memory Function- 10 memory locations (0 – 9), 0 is the power ON default. to Save current connections * - USR - <i>n</i> (0-9) - ENTER to Recall connections * - CPU - <i>n</i> (0-9) - ENTER

The following examples show various methods of routing user 3 to CPU 5. Users and CPUs can be entered as a two digit number or a one digit number followed by ENTER.

```
USR - 3 - CPU - 5 - ENTER
USR - 3 - ENTER - 5 - ENTER
USR - 0 - 3 - 0 - 5
0 - 3 - 0 - 5
```

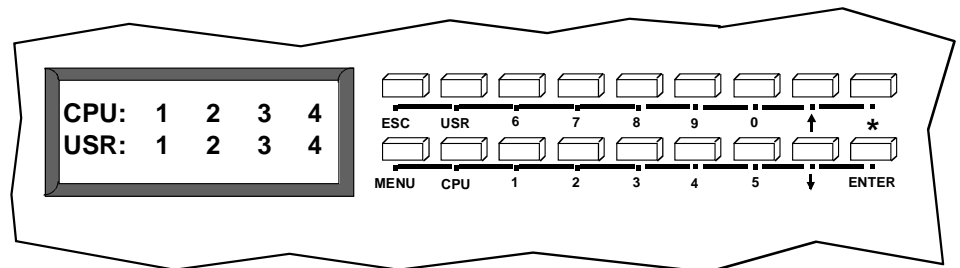

NOTE: By default, the display will show all connections between CPUs and users, displaying 4 at a time, from the first to the last, and repeating the cycle indefinitely. If the user presses either the up or down arrow to manually view connections, the display will freeze on the chosen view. To resume the default cycle of displaying all connections, the user must press and hold either the up or down arrow for 3 seconds, and then release it.

OSD Control

OSD superimposes a menu system on the user's video screen with a list of all connected CPUs. OSD allows CPUs to be named (with up to 12 character names). OSD then allows selection of CPUs by that name. Connected CPUs can be listed by name or by port number. OSD Search Mode enables the user to type in the first few characters of the CPU's name and the OSD will locate it. HELP screens assist with all OSD functions.

Security Feature

The security feature in the OSD control of the ST-nXm-U-HD switch enables an administrator to control access to CPU ports for each user. Up to 63 users can be created. These users have controlled access to any CPU. Only the administrator can activate or deactivate the security features on each user port. Finally, the administrator can set a maximum idle time value after which the current user will be logged out and the login screen displayed again. This time out does not function while the OSD is active. The current security status, idle time out, and scan dwell time are all saved and will be restored whenever power to the switch is cycled OFF, then ON. To reset the administrator's password call NTI and have the device serial number of the ST-nXm-U-HD switch available.

Enabling The Security Feature

To enable the security feature the administrator must first enter Command Mode from the keyboard using the <Ctrl> + <`> (accent key). The OSD menu will automatically appear on the monitor. This provides a visual way to control the ST-nXm-U-HD switch using the keyboard and mouse.

The administrator will activate security when logging in by typing <Ctrl> + <M> , then <A>, and then <Y>. The administrator will then be prompted for a valid administrator username and password (see Fig. 3).

The factory administrator login settings are:

- default user name = ADMINISTRATOR
- default password = ADMINISTRATOR

NOTE: *The username for the administrator cannot be changed from "ADMINISTRATOR".*

```
NETWORK TECHNOLOGIES INC
-----
USER LOGIN
USER NAME: [blacked out]
PASSWORD: [blacked out]
```

Figure 3- User login screen

Once logged-in, follow the instructions on pages 9 and 10 for setting up users and changing the password. Once the password is setup, if it is lost or forgotten the administrator will have to contact NTI for assistance on clearing the password and set it up again. The administrator can setup each of the users and the limitations of their use of the individual CPUs within the Administration Mode.

When a standard user powers up the system a security screen may appear as setup by the administrator. The user will need to login to the system by following the instructions on page 8 for the USER LOGIN. If the user does not know the appropriate user name and password (setup by the administrator), contact the system administrator for this information. Once logged-in a user can follow the Command Mode functions described on page 11 to control the system of CPUs within the limitations as determined by the administrator.

User Login Mode

User Login Mode requires a user to login with a user name and password from the list created by the administrator. With security enabled, the user will be locked to the current CPU and the login screen will remain on the monitor until the user logs in.

Function:

Add a character to the user name/password

Keystroke:



OR

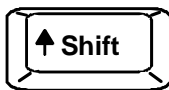

+



(Type any upper or lower case alphabetical or numeric character)

Remove previous character from the user name/password

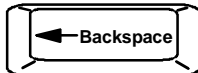

Submit user name/password



Exit USER LOGIN and return to previous mode. This function is only available if security is not currently enabled.



If the password submitted is incorrect, the user will not be able to proceed.

If the password submitted is correct, the user will proceed to Normal Mode.

Additional OSD Modes Available With Security

Administration Functions

Administration mode enables the administrator to select a port for extended status information or setup users and assign system access rights to those users.

Function:

Enter Administration Options mode

Keystroke:



Enter Port Status mode for selected port



Exit Administration and Return to previous mode



Administration Options

To enter the Administration Options mode: press <A> from the Maintenance Mode menu. (See page 14 for Maintenance menu.)

The Administration Mode (see Fig. 4) can be accessed only when security features are activated and the administrator is logged-in. Users other than the administrator are not allowed to enter the Administration Mode.

If a different user is logged-in, log-out by pressing <Q> from the Maintenance Mode menu, then log-in as Administrator. (See page 7, "Enabling The Security Feature".)

Administration Mode allows the administrator to use the following functions:

Function:

Change the administrator's password

Keystroke:



Disable security



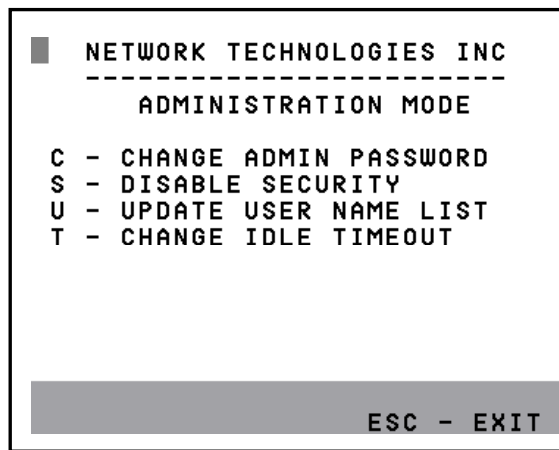

Figure 4- Administration Mode Menu

Function:

Keystroke:

Enter User Name List Mode



Selects the idle time in minutes

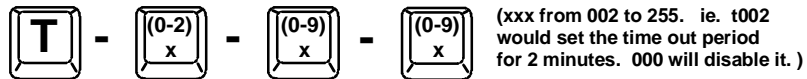

Exit Administration Mode and return to previous mode



Port Status Mode

Port Status mode enables the administrator to view extended status information about the port selected in Administration mode. The information available here can also be found on the Command mode main menu, except when multiple users are connected to a single CPU. In that event, while the Command mode main menu simply lists the number of users connected, the specific users connected can be seen here. To exit Port Status Mode, press <Esc>.

Administrator Password

To enter the Administrator Password menu press <C> from the Administration Mode menu.

The Administrator Password menu (see Fig. 5) enables the administrator to change his password. Two edit fields are available, one for password, the other for verify password. The password can be up to 13 characters in length.

NOTE: The default password for the administrator is ADMINISTRATOR.

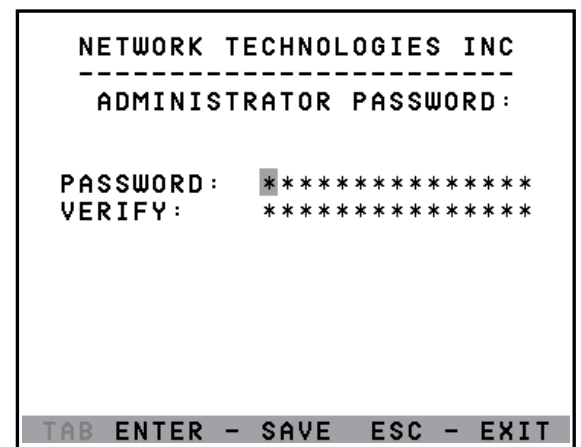
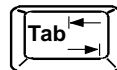

Figure 5- Administrator password menu

Function:

Keystroke:

Switch between Password and Verify Password fields



Add character to password string or verify password string



Delete previous character in edited string

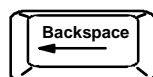

Administrator Password (cont'd)

Function:

Save new password. (The administrator will be prompted for a Yes or No confirmation)

Keystroke:

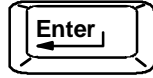

(If Password string and Verify Password string are different, this command will have no effect, enabling the administrator to correct the password)

Return to Administration Mode



User Name List

To enter the User Name List press <U> from the Administration Mode menu.

The User Name List (see Fig. 6) enables the administrator to see a list of users. The administrator can select either an existing user to modify user settings, or an empty record to add a new user.

Function:

Edit the highlighted user's access rights in System Access List

Keystroke:

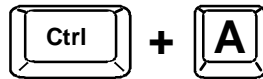

Enter Edit mode to add/change/remove users

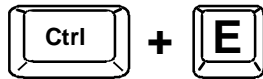

Change the highlighted user's password

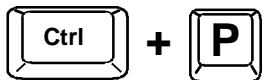

Return to Administration Mode

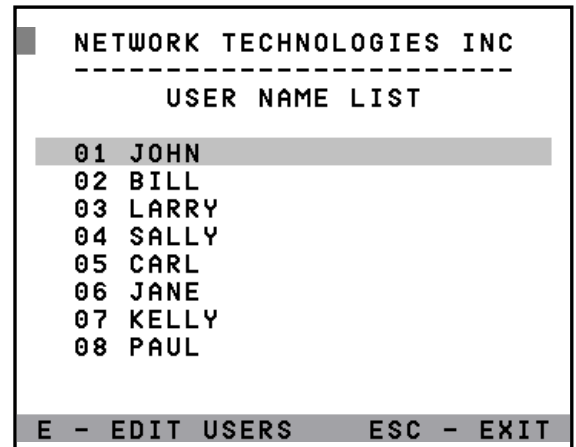

Figure 6- User Name List

System Access List

To enter the System Access List, press <Ctrl> + <A> from the User Name List. The System access list displays the ports so that the Administrator can change access rights for the selected user. That user's name is displayed at the top of the access list. Use the mouse to change access rights by clicking on a given number to toggle the port's status.

Function:

Save the changes to the access list and return to previous mode



Exit the System Access List without saving and return to previous mode



User Access Functions

Command Mode

In order to control the switch with the keyboard, Command Mode must be enabled. To enable Command Mode from the keyboard:

Press

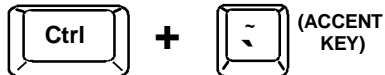

All the status lights on the keyboard will illuminate to indicate that Command Mode is enabled. At this point, the Command Mode menu will be displayed.

The Command Mode menu (see Fig. 7) lists all CPUs by name and port number. Only 8 ports are listed on the screen at a time. To view the other portions of the list, scroll using the arrow keys on the keyboard or use the mouse to click on the arrows on the scroll bar in the OSD menu. When the Command Mode main menu is displayed, the first displayed port in the list will be the port the current user is connected to, followed by the next seven consecutively numbered ports. (Alternatively the list may be alphabetically sequential- see Maintenance Mode on page 14 to toggle sort method.) The names of accessible ports are displayed with white characters. If Security is activated, the access rights for the user logged-in may not include all ports. Names of restricted access ports are displayed in blue.

An arrow to the left of a port number in the list indicates the port the user is currently connected to. From left to right, the columns display the following:

- Port Number
- Port Name
- Type of CPU connected
- Power Status of the CPU (ON/OFF)
- The actual user number (1-8) connected to the CPU.
- If no user is connected to a CPU, the user number is replaced by a "-" (dash).
- If more than one user is connected to the same port, this field will indicate the total number of users connected and the text color will be red.

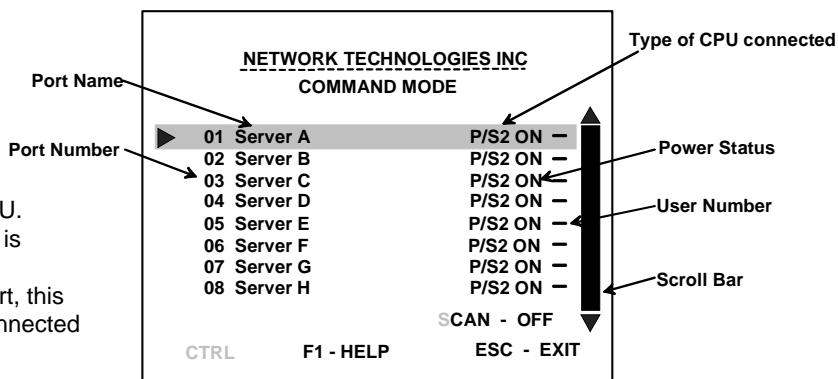

Figure 7- Command Mode main menu

NOTE: While in Command Mode, the numbers on the NUM PAD on the keyboard are not active. If numbers are required while in Command Mode, use the numbers on the main key bank.

The list below describes the command functions available from the keyboard within the OSD mode of control after entering into Command Mode:

Function:

Keystroke:

Select the previous port



Select the next port



Increments the menu by 1 page



Decrements the menu by 1 page



Enable/disable Scan Mode

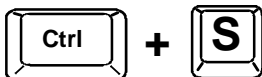

Command Mode (Cont'd)

Function:

Keystroke:

Enter Edit Mode
(Only available if administrator
is logged in)

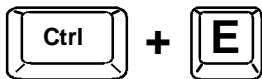

Selects scan time in seconds

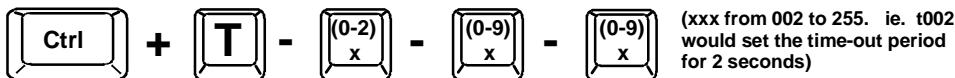

Enter Maintenance Mode

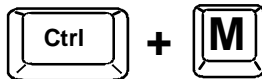

Display Help Menu



Select a specific port

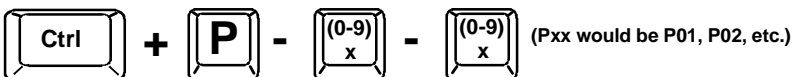

Select the first port on the switch



Select the last port on the switch



Enter Search Mode, add a character
to search string and select the CPU's
name that matches best.

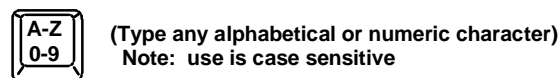

Switch to a selected port



Exit Command Mode



The mouse can also be used to control the ST-nXm-U-HD switch Command Mode within the menu.

- The scroll wheel can be used to scroll through the ports list.
- The mouse cursor can be moved to the Scan, Help, and Exit fields where the user can click on the left mouse button to perform that function or toggle that indicator.
- Ports listed on the screen can be selected by moving the cursor onto a port and clicking.
- To move through the port list, the scroll bar to the right of the list can be used by clicking the up and down arrows.

NOTE: Exit Command Mode to type to a CPU. To exit Command Mode, press <Esc> or <Ctrl> + <`> (accent) keys or by clicking the "ESC" command on the screen with the mouse.

Scan Mode

To activate Scan Mode press <Ctrl> + <S> from the Command Mode menu.

Scan Mode enables the user to scan through selected ports and to have full device control of the connected port. A port is skipped from the scan cycle if one of the following conditions is true:

- the port is used by another user
- security mode is enabled and the user does not have access rights to the port
- the CPU connected to the port is OFF

The scan dwell time is programmable from 2 to 255 seconds (default time-out period is 5 seconds). When the user uses the mouse or keyboard the scanned port becomes active and scanning is stopped. The switch will resume scanning after a period of user inactivity determined by the scan dwell time. See Command Mode above for configuring the scan dwell time.

NOTE: The scan dwell time set by the user only effects that user and has no effect on other switch users.

NOTE: The keyboard and mouse must remain idle for the full scan dwell time before the switch selects the next active port.

Edit Mode

To activate Edit Mode press <Ctrl> + <E> from the Command Mode menu.

Edit Mode allows only the administrator to modify the names of the CPUs connected to the switch. Names of CPUs can be up to 12 characters in length. Characters typed can be upper or lower case. After changes have been made the administrator will be prompted by the menu to save the changes. Answer "Y" to save changes and answer "N" to continue using previously entered port names.

Function:

Keystroke:

Move cursor one position to the right



Move cursor one position to the left



Move cursor to the previous port



Move cursor to the next port



Select the first port on the switch



Select the last port on the switch



Toggles between insert and overstrike



Character either gets inserted and the remaining characters shift to the right, or characters get overwritten.

Erase current character



Erase previous character



NOTE: If a change has been made, using the up or down arrow will also prompt the user to save any changes.

When finished making changes in Edit Mode, press <Esc> and a prompt will appear to press either <Y> to save the changes or <N> to continue making changes without saving the changes just made.

Search Mode

Search Mode is enabled by typing any alphabetical or numeric characters while in the Command Mode menu.

Search Mode allows the user to enter and maneuver through a list of CPU names. The CPU name best matching the characters typed is selected. The list of CPUs may also be searched for a specific (or similar) name. The following commands are valid when the search option has been invoked from Command Mode.

Function:

Keystroke:

Erase previous character in search name

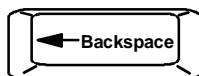

Select the previous port



Search Mode (cont'd)

Function:

Keystroke:

Select the next port



Add a character to the search string and select the best matching CPU name



(Type any alphabetical or numeric character)

Exit Search Mode, return to Command mode



or

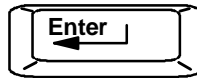

Maintenance Mode

To enter Maintenance Mode (see Fig. 8) press <Ctrl>+<M> from the Command Mode menu.

Maintenance Mode enables a user to customize the On Screen Display to their requirements. Also, the Security Mode can be activated/deactivated from this menu.

Function:

Keystroke:

Reset all of the port names



Toggle between numeric and alphabetic listing of ports



Move On Screen Display (OSD) menu up on monitor



Move OSD menu down on monitor



Move OSD menu to the right



Move OSD menu to the left



Make OSD menu taller



Make OSD menu shorter



Activate security features.

Present only when security is available but not active.



Enter Administration Mode.

Option present only when administrator is logged in.

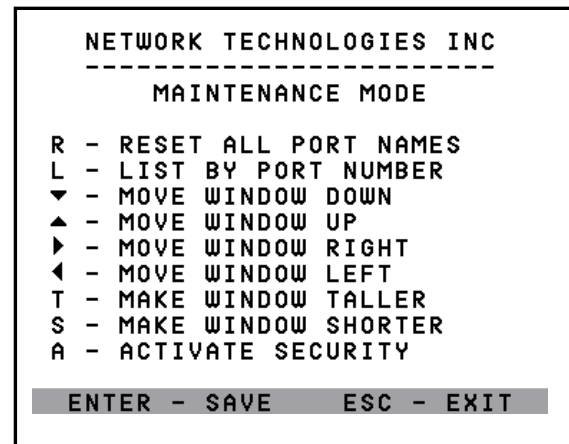

Figure 8- Maintenance Mode menu

NOTE: If activating security features, the user will be prompted for a "Y" (yes) or "N" (no) to confirm the menu choice, at which point the user will be asked for a username and password before continuing. Only the administrator can activate the security features.

Maintenance Mode (Cont'd)

Function:

Log current user out and return to User Login Mode.

Keystroke:



(Only displayed when security is active)

Save OSD window parameters for the port



Return to Command Mode



NOTE: Based on different scan rates, the OSD window may appear in different areas of the monitor as different CPU ports are selected. The Maintenance Mode functions allow placement of the window in a particular area of the monitor and the window will return there when the ST-nXm-U-HD switch is reconnected to that particular CPU (provided the parameters are saved before exiting Maintenance Mode).

Help Mode

To enter Help Mode press the <F1> key from the Command Mode menu (see page 12).

Help Mode displays a list of commands with a short explanation of their function. The following options allow the user to quickly obtain information on any command.

Function:

View the previous page of help if available

Keystroke:



View the next page of help if available



Exit HELP and return to previous mode



Keyboards

The keyboard configuration of each CPU is saved in the NTI Switch. For example, if the CPU attached to Port 4 had CAPS LOCK and NUM LOCK selected the last time that CPU was accessed, then they will automatically be set when that CPU is accessed again.

Key Equivalents

Using the chart below, find the character needed to be typed on the CPU being accessed, then follow the row across for the equivalent on the keyboard device being used.

PS/2 101	WINXX	SUN Keyboard
L-Ctrl	L-Ctrl	L-Ctrl
L-Alt	L-Alt	L-Alt
R-Ctrl	R-Ctrl	Compose
R-Alt	R-Alt/Aplcn	Alt-Graph
SB+Alt	Logo	Meta
SB+RT Arrow	SB+RT Arrow	Power

SB = Space Bar

L and R = Left and Right keys when two keys are marked the same on a keyboard.

+ (SB + Alt) = Press keys simultaneously

SUN's Startup Keys

With a Sun CPU attached to the switch, the following emergency startup keys are supported:

Stop	Bypass POST
Stop-A	Abort
Stop-D	Enter diagnostic mode
Stop-F	Enter Forth on TTYA instead of probing
Stop-N	Reset NVRAM contents to default values

This switch will also support other startup commands not listed above.

SUN's 14 Extra Keys

PS/2,Win Keyboards	Sun Extras
SB+F1	Stop (L1)
SB+F2	Again (L2)
SB+F3	Props (L3)
SB+F4	Undo (L4)
SB+F5	Front (L5)
SB+F6	Copy (L6)
SB+F7	Open (L7)
SB+F8	Paste (L8)
SB+F9	Find (L9)
SB+F10	Cut (L10)
SB+F11	Help
SB + UP Arrow	Vol +
SB + DOWN Arrow	Vol -
SB + LEFT Arrow	Mute

Use the chart to the left to type SUN's additional 14 keys using a PS/2 101 or a WIN95 keyboard

SB= Space Bar

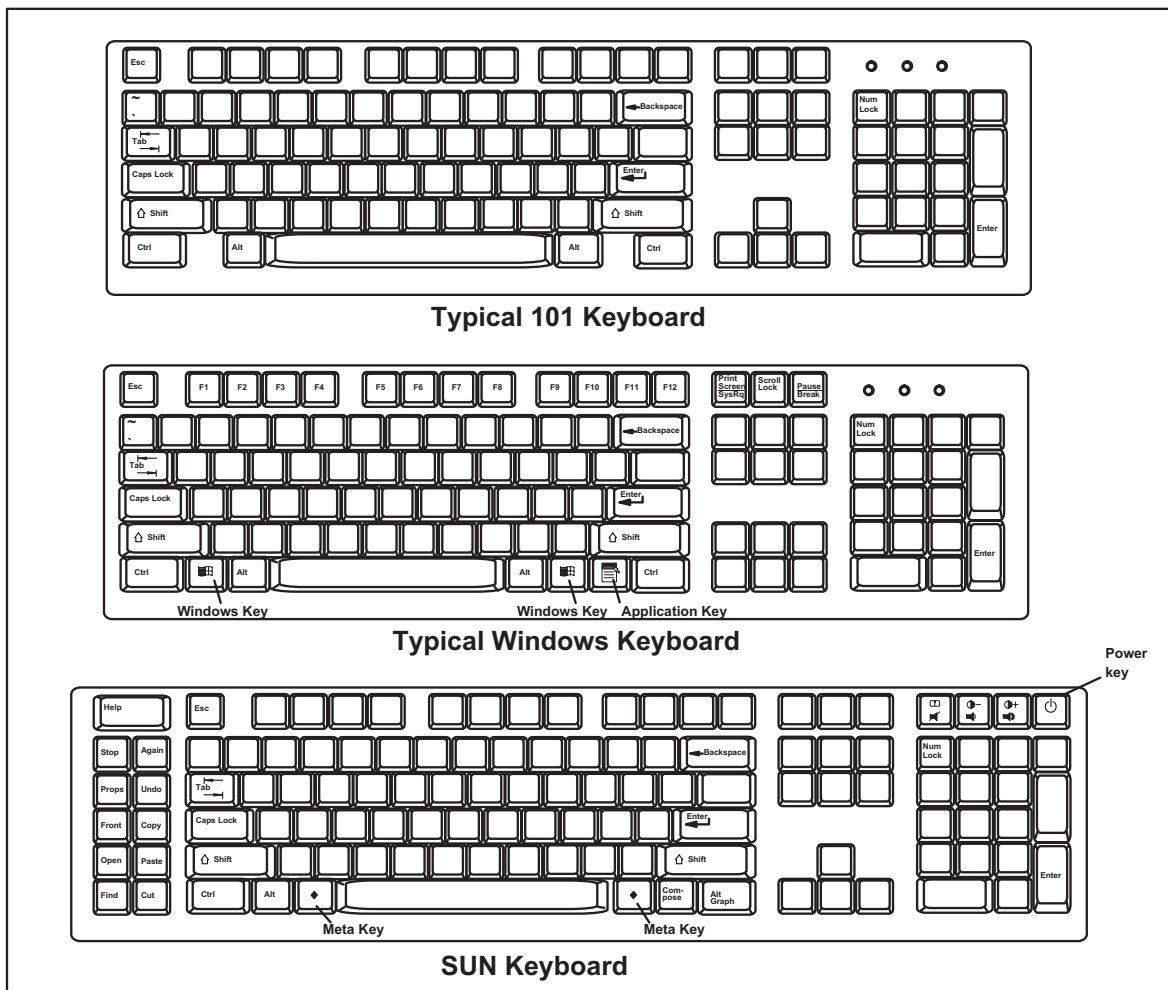

Figure 9- Keyboard Layouts

RS232 Control

Remote Connection

The RS232 Interface is designed to control the switch via serial (RS232) daisy chain connection from any CPU or other controller with an RS232 communications port. There is, however, a restriction that must be followed:

A program must be used that will send an entire command line all at once, not character by character. (The HyperTerminal program in WINDOWS cannot be used, as it sends each character one at a time.)

The pin outs for the DB-9 connector on the unit are as follows:

RS232 INPUT (DB-9 FEMALE)

PIN	SIGNAL	FUNCTION
1	none	no connection
2	TXD	Transmit Data (RXD at host)
3	RXD	Receive Data (TXD at host)
4	DTR	Data Terminal Ready
5	GND	Signal Ground
6	DSR	Data Set Ready
7	RTS	Request to Send
8	CTS	Clear to Send
9	none	no connection

On the DB-9 female connector, pins 4 (DTR) and 6 (DSR) are shorted and pins 7 (RTS) and 8 (CTS) are shorted. Therefore, host handshaking is bypassed and TXD and RXD are the only active signals. A straight through DB-9 cable (not null modem) will work for most CPUs. To daisy chain multiple units, use NTI Matrix-Y-1 "Y" cable (see Fig 10).

Baud Rate

The unit powers up with a default baud rate of 9600 and a fixed data protocol of 8 data bits, no parity and 1 stop bit. The baud rate is selectable through the "Baud Rate Menu". A data protocol of 8 data bits, no parity, and 1 stop bit is used in the daisy chain communication.

Unit Address

To allow multiple units to be controlled from a single host port, the RS232 control interface is designed to allow "daisy chaining" up to 15 units using the NTI Matrix-Y-1 "Y" cables. By setting the appropriate unit address with the keypad, each unit can be given a unique address (1-15). Then the unit will only respond to commands on the bus if its address is embedded in the command. (See Fig. 9.)

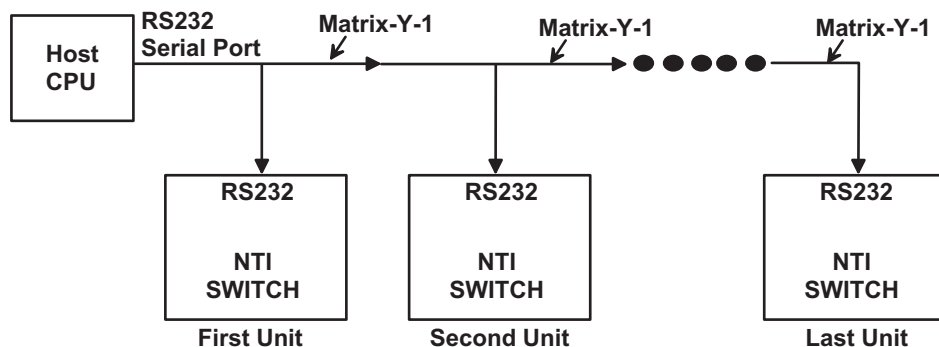

Figure 10- RS232 Connections for Daisy-chain

Command Protocol

Host controller commands supported by the unit are defined below. All commands should be terminated with a <CR> (carriage return). When a command is sent, the entire string is echoed back to the host along with a response from the addressed unit as shown in the command definitions. All characters should be upper case, and all numbers below 10 should have a leading 0 (ex: 1 = 01).

NOTE: For units with one output or user port, use 01 for the output select.

CS - change single USER channel

FORMAT: CS AA,XX,YY<CR>
CS = "change single USER" command followed by at least one space
AA = unit address
XX = CPU to connect
YY = USER to change

RESPONSE: *<CR> (command received and executed OK)
?<CR> (syntax or transmission error occurred)

RO - read single USER channel

FORMAT: RO AA,XX<CR>
RO = "read USER" command followed by at least one space
AA = unit address
XX = USER to read

RESPONSE: 1) *<CR> (command received and executed OK)
?<CR> (syntax or transmission error occurred)
2) XX<CR> (XX = CPU connected)

RU - read unit size

FORMAT: RU AA<CR>
RU = "read unit size" command followed by at least one space
AA = unit address

RESPONSE: 1) *<CR> (command received and executed OK)
?<CR> (syntax or transmission error occurred)

XX,YY<CR> (XX = # of CPU's, YY = # of USERS)

RS232 INTERFACE TEST PROGRAM DESCRIPTION

This software allows a user to test the functions of an NTI server switch, matrix switch or Multi-user/Multi-platform switch RS232 interface. The program SERTEST along with the Matrix Switcher's Control Program (see page 18) is installed from the 3-1/4" floppy disc packaged with this switch. SERTEST generates a main menu with the 3 selections described below:

Main Options

- Matrix Options - send commands to the matrix unit.
- Setup Options - set COM port, baud rate, and unit address
- About SERTEST - display the program version

If Matrix Options is selected, the following menu is displayed:

MATRIX OPERATIONS

- 1) Reset Unit (1)
 - send a reset command to the switch
 - the current unit address is displayed in parentheses
- 2) Reset All Units
 - send an internal reset command to all switches
- 3) Connect KVM Output/User to an Input/CPU
 - connect an output to an input (KVM ports only)
- 4) Connect All KVM Outputs/Users to an Input/CPU
 - connect all outputs to an input (KVM ports only)
- 5) Connect Audio Output/User to an Input/CPU
 - connect an output to an input (Audio ports only)
- 6) Connect All Audio Outputs/Users to an Input/CPU
 - connect all outputs to an input (Audio ports only)
- 7) Change Mute Status for Audio Output/User
 - mute or un-mute the Audio port output
- 8) Change Volume for Audio Output/User
 - change Audio port output volume

- 9) Read Connection for KVM Output/User
 - read what input is connected to the specified output (KVM ports only)
- a) Read Connection for Audio Output/User
 - read what input is connected to the specified output (Audio ports only)
- b) Read Mute Status and Volume for Audio Output/User
 - read the volume and the mute status of the specified output (Audio ports only)
- c) Read Unit Size
 - read the switch size (number of inputs and outputs)
- d) Read Unit Version/Revision String
 - read a string containing the switch version, type, and size
- e) Save I/O Connections into Unit Memory
 - save the connections into switch memory bank
- f) Restore I/O Connections from Unit Memory
 - restore the connections from switch memory bank
- g) Save All Units I/O Connections into Units Memory
 - save the connections into switch memory bank, command for all switches
- h) Restore All Units I/O Connections from Units Memory
 - restore the connections from switch memory bank, command for all switches
- i) Change All Units Baud Rate (9600/COM1:)
 - change RS-232 Baud rate of all switches
 - the current baud rate and serial port are displayed in parentheses

SET OPTIONS

- 1) select Com port current: (COM1:)
 - select PC serial port
 - the current PC serial port is displayed in parentheses
- 2) select Baud rate current: (9600)
 - select PC serial port baud rate
 - the current baud rate is displayed in parentheses
- 3) set unit Address current: (1)
 - select the unit address
 - the current address is displayed in parentheses

For any selection that requires user input, the user is prompted. When commands are sent to the matrix unit, the command string and matrix unit responses are echoed to the screen. All commands generated by the program are formatted according to the information provided in sections above. If any transmission problems are detected, an error message is displayed.

Matrix Switcher's Control Program For Windows 9X, NT, and 2000

The Matrix Switcher's Control Program is an easy and powerful graphical program that controls NTI matrix switches through an RS232 interface. The Matrix Switcher's Control Program is on a 3-1/4" floppy disc packaged with the ST-nXm-U-HD switch. The Matrix Switcher's Control Program is installed by typing SETUP.EXE at the A:\ prompt.

To install the Matrix Switcher's Control Program

1. At the DOS prompt, type **A: ** and press <Enter>
2. Type **SETUP** and press <Enter>
3. Follow the instructions on the screen

The Matrix Switcher's Control Program performs best on monitors set to a screen resolution of at least 800 X 600. Instruction for using the Matrix Switcher's Control Program is available by opening "MSCP Help" in the "NTI" program group once the program has been installed and is open on the screen.

To open "MSCP Help" from the Windows desktop

1. Click on **START**
2. Click on **PROGRAMS**
3. Click on **NTI**
4. Click on **MSCP Help**

Dual Redundant Power Supply

The ST-nXm-U-HD switch may be purchased with an optional Dual Redundant Power supply. This feature allows an external power supply to be connected to the unit with two supplies for +5V and -5V. This feature ensures constant power to the unit since there is a MASTER supply and a SLAVE supply ready to take over should the MASTER fail. LEDs on each portion of the supply indicate the status at all times. Should a portion of this supply fail (+5V for example), the +5V SLAVE would take over immediately and become the new MASTER. Any failed portion can be hot swapped, becoming the new SLAVE.

Male Connector
(replaces line cord and fuse)

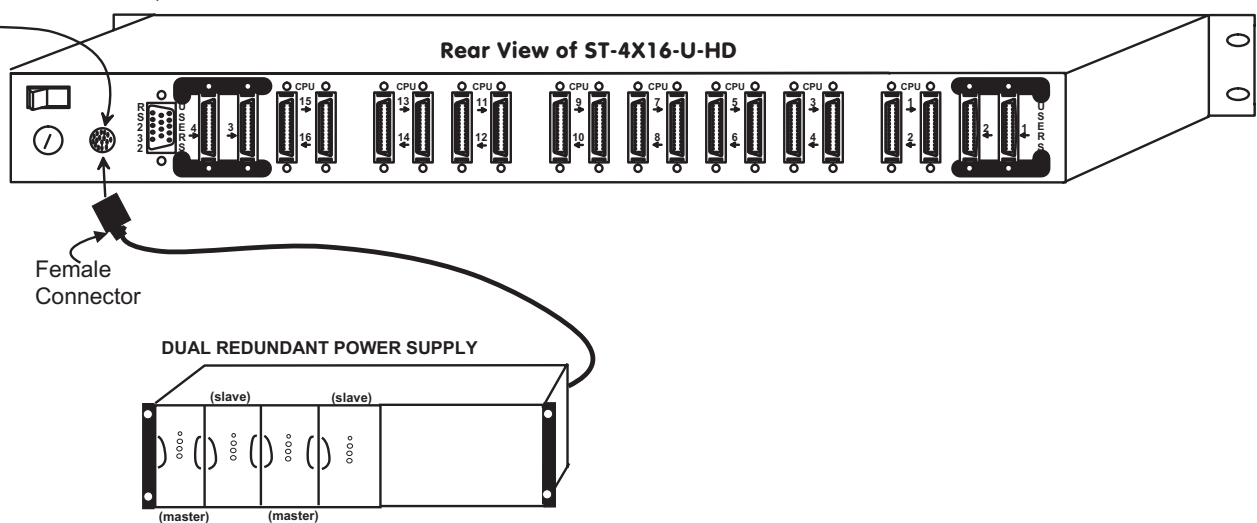

Figure 11- Dual Redundant Power Supply Option

ST-MX Expansion Units

In order to be able to expand the current ST-nXm-U-HD product or go beyond the 8/16 CPU limit on the ST-nXm-U-HD, the ST-MX expansion unit can be used to combine, or bank, multiple switches together to be controlled from one central workstation.

Each user that desires to use the switch in this fashion will require a ST-MX-xx unit. The largest ST-MX is the ST-MX-16; which allows the connection of up to 16 ST nXm-U-HD switches to be controlled by one set of keyboard/monitor/ and mouse peripherals.

Connections are made from the STMX to the ST-nXm-U-HD using a VKTINT-1 cable for the mouse and keyboard connections and a VEXT-xx-MM cable for the video connection. It is important to setup the ST-MX to be on the same user port on all ST-nXm-U-HD switches. For example, ST-MX unit one will plug into all user one ports on all of the ST-nXm-U-HD switches to be banked and ST-MX unit two will plug into all user two ports on all of the ST-nXm-U-HD switches to be banked together.

Even though connections must be made to a ST-nXm-U-HD, this does not mean the user is limited to using just P/S2 or SUN peripherals. Either SUN, MAC, or P/S2 peripherals may be connected to the ST-MX units as long as the DIP switch is set properly. See the manual that comes with the NTI ST-MX Expansion unit for more information on setup and operation.

SAFETY and EMC Regulatory Statements

WARNING A WARNING in this manual indicates the potential for serious injury or death.

CAUTION A CAUTION in this manual indicates the potential for damage to the equipment

Do not continue past a WARNING or CAUTION statement until you have read and clearly understand the reason for the potential injury, death, or damage to the equipment and have taken the appropriate action(s).

Grounding

These products have protective earth ground terminals and are built with full attention to consumer safety. There must be an uninterrupted safety earth ground between the main power source and the product's power cord or supplied power cord set. If ever the possibility exists for the grounding protection to have been reduced in any way, disconnect the power supply until the grounding connection has been fully restored.

Servicing

NTI products are not intended to be serviced in the field and contain no user-serviceable parts. In the event repair is needed, all servicing must be performed by factory trained and authorized service personnel. Only those items specifically identified in this manual (if any) may be adjusted by the user of this product and adjusted only as instructed in this manual.

APPENDIX

Appendix A- Defaults

SETTING	DEFAULT VALUE
KVM keyboard/mouse type	PS/2 or SUN
CPU keyboard/mouse type	PS/2, SUN
Computer Names	SERVERxx
Scan time interval	5 SECONDS
Scan setting	OFF
Security	OFF
Administrator password	ADMINISTRATOR
Maximum ports	16 CPU, 4 User

Appendix B- General Information

DESCRIPTION	SPECIFICATION
Dimensions	19"W x 10" D x 1.75" H
Operating temperature	0°C - 55°C (32°F - 131°F)
Power requirements	120 or 240VAC @ 50 or 60Hz
Video bandwidth	200 MHz (without cables)
Video sync	TTL
Chassis material	Aluminum

Appendix C- Cables

NTI #	DESCRIPTION
VMTINT-3/6/10/15/25	Interface PS/2 Keyboard and Mouse and VGA video to Nodemux-HD switch
SMTINT-3/6/10/15/25	Interface SUN Keyboard and Mouse and VGA video to Nodemux-HD switch
VMTINT-3/6/10/15/25-MM	Interface PS/2 CPU to Nodemux-HD switch
SMTINT-3/6/10/15/25-MM	Interface SUN CPU to Nodemux-HD switch

Legend:

MM- male connectors on both ends

If the cable desired is not listed above, please visit our website at <http://www.nti1.com> for a complete listing of the cables and adapters we offer, or call us at (800) 742-8324 (800-RGB-TECH) or (330) 562-7070.

Appendix D- Rack mounting Instructions

If this NTI switch was designed to be directly mounted to a rack, it includes a mounting flange to make attachment easy. Install 4 captive nuts to the rack in locations that line up with the holes (or slots) in the mounting flange on the NTI switch. Then secure the NTI switch to the rack using four 3/16" diameter screws (not provided). Each screw should be of sufficient length to go completely through the NTI mounting flange, rack frame and fully engage all threads in the captive nut. We suggest installing additional rails to the rack frame to support the weight of the switch. Be sure to tighten all mounting screws securely.

Do not block power supply vents in the NTI switch chassis (if provided) .

Attach all cables securely to the switch and where necessary supply adequate means of strain relief for cables.

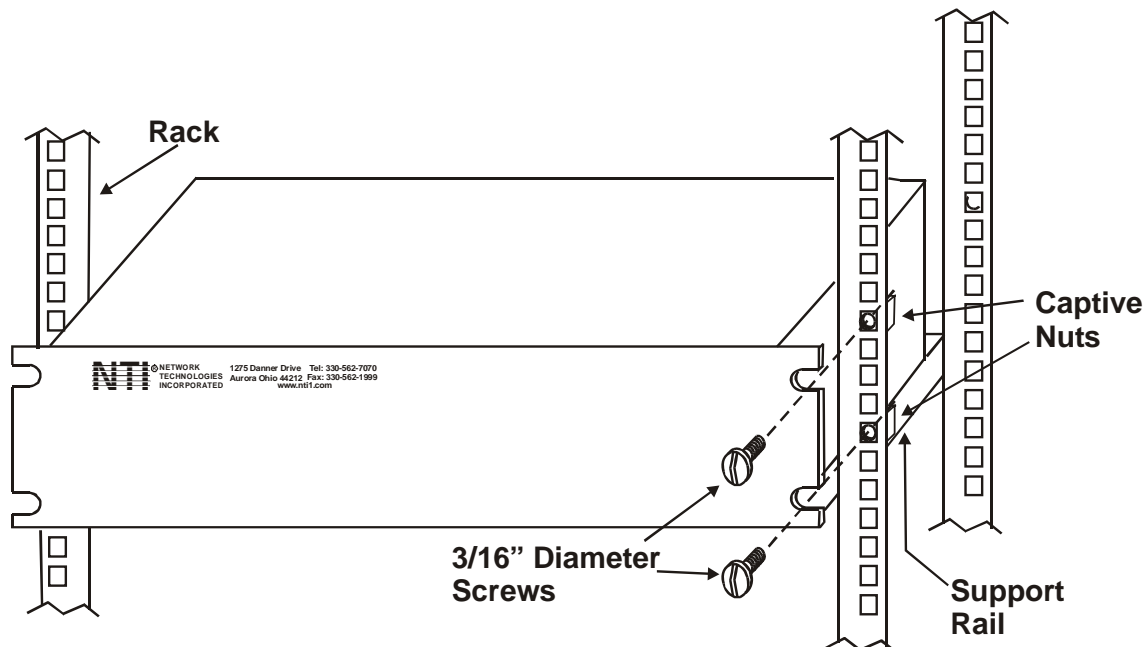

SERIAL NO: _____

DATE: _____

INSPECTED BY: _____

ST-2x8-U-HD

ST-4x8-U-HD

ST-4x8-U-HD

ST-4x16-U-HD

OPTION:

Dual Redundant Power Supply

Free Manuals Download Website

<http://myh66.com>

<http://usermanuals.us>

<http://www.somanuals.com>

<http://www.4manuals.cc>

<http://www.manual-lib.com>

<http://www.404manual.com>

<http://www.luxmanual.com>

<http://aubethermostatmanual.com>

Golf course search by state

<http://golfingnear.com>

Email search by domain

<http://emailbydomain.com>

Auto manuals search

<http://auto.somanuals.com>

TV manuals search

<http://tv.somanuals.com>