

UNIMUX™ Series

UNIMUX-DVI-x USB DVI KVM Switch Installation and Operation Manual



TRADEMARK

UNIMUX is a trademark of Network Technologies Inc in the U.S. and other countries

COPYRIGHT

Copyright © 2000,2007 by Network Technologies Inc. All rights reserved. No part of this publication may be reproduced, stored in a retrieval system, or transmitted, in any form or by any means, electronic, mechanical, photocopying, recording, or otherwise, without the prior written consent of Network Technologies Inc, 1275 Danner Drive, Aurora, Ohio 44202.

CHANGES

The material in this guide is for information only and is subject to change without notice. Network Technologies Inc reserves the right to make changes in the product design without reservation and without notification to its users.

CE Statement

We, Network Technologies Inc, declare under our sole responsibility that the UNIMUX-DVI-4/8 is in conformity with European Standard EN55022.

TABLE OF CONTENTS

INTRODUCTION	1
MATERIALS	2
DEFINITIONS.....	2
FEATURES AND FUNCTIONS.....	3
RACKMOUNTING INSTRUCTIONS.....	4
To Mount to a Rack	4
INSTALLATION.....	5
RS232 Connection.....	7
Power-Up Sequence.....	8
Limitations.....	8
USING THE UNIMUX DVI KVM SWITCH	9
Front Panel Control.....	9
Keyboard Control.....	9
Command Mode	9
Scan Mode.....	10
Broadcast Mode.....	10
Normal Mode	10
No Sun Sleep Mode.....	10
Select Country Code.....	11
Mice and Trackballs with MACs.....	11
RS232 CONTROL.....	12
RS232 Connections and Configuration	12
Remote Connection	12
Baud Rate	12
Unit Address and Loop Back	12
Command Protocol.....	14
NTI Switch Control Program For Windows 9X, NT, 2000, XP, And Vista	15
SerTest- RS232 Interface Test Program	15
Main Options.....	15
KEYBOARD FEATURES	17
Keyboard-To-Computer Translation.....	17
Translation Capabilities	17
Translation Tables	17
International Sun Keyboards	18
TROUBLESHOOTING	19
INDEX.....	19
WARRANTY INFORMATION.....	19

TABLE OF FIGURES

Figure 1- Secure rackmount ears to switch.....	4
Figure 2- Secure switch to a rack.....	4
Figure 3- Connect a DVI monitor	5
Figure 4- Connect the device(s).....	5
Figure 5- Connect each CPU	6
Figure 6- Connect the AC adapter	6
Figure 7- Connect RS232 control terminal.....	7
Figure 8- Compatible device combinations	8
Figure 9- Country Codes for international SUN keyboards.....	11
Figure 10- RS232 dip-switches	12
Figure 11- RS232 connection with Matrix-Y-1 cable.....	13
Figure 12- Pinout of Matrix-Y-1 cable	13
Figure 13- RS232 Communication Illustrated	14
Figure 14- Keyboard Layouts	18

INTRODUCTION

The UNIMUX-DVI-x 4 or 8-Port USB DVI KVM switch (UNIMUX) allows access to up to eight Windows, MAC, or SUN USB CPUs from one USB keyboard and mouse and a DVI video-enabled monitor. Internal microprocessor circuitry allows all USB CPUs to be booted simultaneously without keyboard error. Port selection is accomplished by front panel push buttons or commands typed on the keyboard. Port lights and status LEDs continuously update on the front panel.

Available Options

- RS232- Control the switch(s) from the serial port of any CPU with an RS232 port. (Model UNIMUX-USBV-xRS)

Types of User Input Devices Supported:

- USB keyboard with Windows layout
- USB keyboard with SUN layout
- USB keyboard with MAC layout
- USB Mouse - (up to 3 buttons)
- USB IntelliMouse (scrollwheel)
- USB Hub
- Mouse-Trak trackball
- Logitech, Kensington and Microsoft Wheelmouse or Trackball on Mac CPUs with special drivers
- Logitech Cordless Elite Duo keyboard and mouse
- Logitech wireless (S510, EX110, diNovo, LX710, MX5000)
- Crystal Vision keyboard with touchpad
- Gyration keyboard/mouse (Go 2.4)
- NTI USB-PS/2-R Adapter
- NTI USB-SUN-R Adapter
- Kensington wireless (64379)
- MS Wireless Optical Desktop (3000 and 4000)
- HP P2360AA
- Fellowes wireless keyboard (KBR0108) with mouse (MSR0238T)
- Creative Desktop Wireless 8000
- DVI monitors

Types of CPUs Supported:

Any USB CPU supporting USB version 1.0 or above including:

- USB WINxx
- USB MAC
- USB SUN
- USB Linux
- USB Unix
- USB Free BSD

MATERIALS

Materials supplied with this kit:

- NTI UNIMUX-DVI-x (4 or 8 ports) USB DVI Video KVM Switch
- 120VAC or 240VAC at 50 or 60Hz-5VDC/2.0A AC Adapter
- 1- 3 foot HDMI male -to-DVI-D male cable (DVI-HDMI-MM-3)
- Line cord, country specific
- Rack mount kit
- CD with pdf file of this manual
- 1- DB9 Female-to-RJ45 Female adapter (models with RS232 option only)
- 1- DB25 Female-to-RJ45 Female adapter (models with RS232 option only)
- 1- 5 foot RJ45-to-RJ45 CAT5 patch cable (models with RS232 option only)

Materials Not supplied but REQUIRED:

- USB-AB-xxM cable for each USB CPU being connected to the switch for keyboard and mouse interface.
- DVI-HDMI-MM-xx cable for each CPU being connected to the switch- for DVI monitor support

where:

xx is the length of the cable in feet

MM indicates male-to-male connector

Cables can be purchased from Network Technologies Inc by calling (800) 742-8324 (800-RGB-TECH) in the US and Canada or (330) 562-7070 (worldwide).

DEFINITIONS

- USB Composite Device A USB device that contains multiple endpoints each representing input devices that cannot be separated (i.e. a keyboard with a built-in mouse)
- USB Hub A USB device that allows one or more USB input devices to plug in to the USB. The hub has exactly one upstream port with one or more downstream ports which input devices connect to
- CPU Enclosure that contains the operating system and processor (i.e. Sun with SPARCstation5, Windows 95 with Pentium II)
- Input Device Keyboard or Mouse
- System One or more CPUs connected to one or more switches controlled by one or more input devices

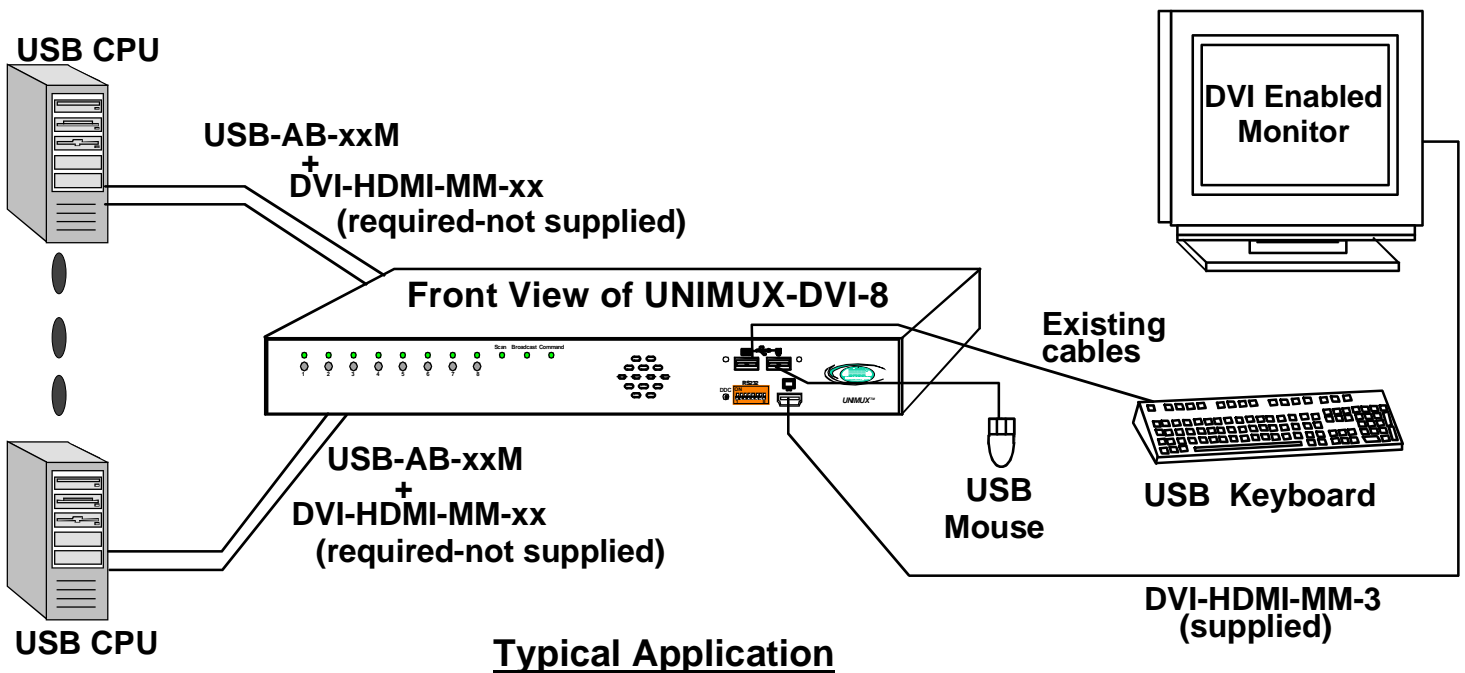

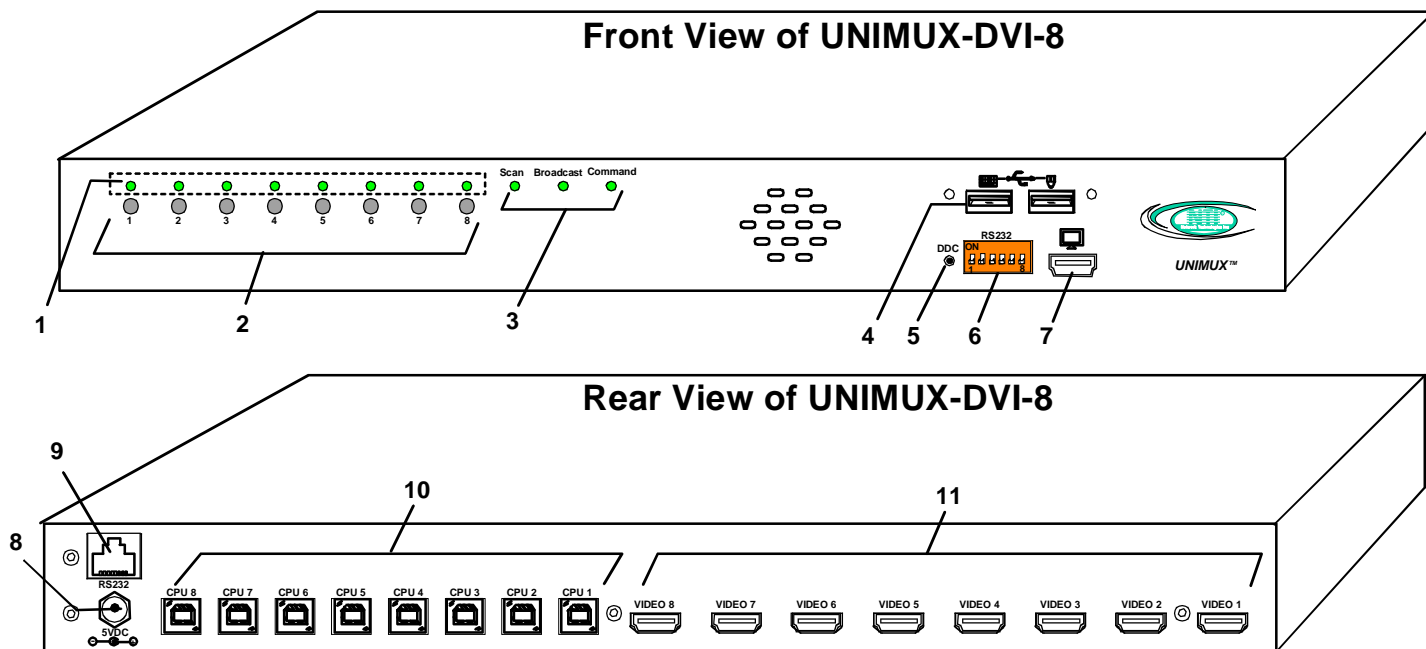

FEATURES AND FUNCTIONS

1. **CPU Status LEDs**- for visual indication of connection between the user and a specific CPU.
2. **CPU Select Switches**- push to manually switch to a specific CPU or change the switch operating mode
3. **Mode Status LEDs**- for visual indication of switch operating mode
4. **USB DEVICES**- USB type A female connector- for connection of user USB keyboard and mouse
5. **DDC**- for refreshing the DDC information between the monitor and CPU
6. **RS232**- (optional) Dip switches for configuring switch address when RS232 is used
7. **MONITOR**- HDMI Type A female connector- for connection of the user DVI video monitor
8. **5VDC**- power input connector for attachment of the AC adapter
9. **RS232**-(optional) RJ45 serial connector- for attachment of RS232 control cable
10. **CPU x**- USB type B female connector-for connection of USB device cable from CPU(s)
11. **VIDEO-x**- HDMI Type A female connectors- for connecting video cables from CPUs

RACKMOUNTING INSTRUCTIONS

This NTI switch was designed to be mounted to a rack or to set on a desktop. It includes rackmount ears to make attachment to a rack easy, and rubber feet to be applied to the bottom of the case if it will instead sit on a flat surface. If this will sit on a flat surface, simply apply the rubber feet to the bottom of the case in each of the 4 corners.

To Mount to a Rack

1. Attach the ears to the switch using the 6-32x3/16" flat Phillips-head screws (6) provided as shown in the illustration below. The holes in the ears should line up with pre-threaded holes in the sides of the NTI switch. Tighten the screws securely.

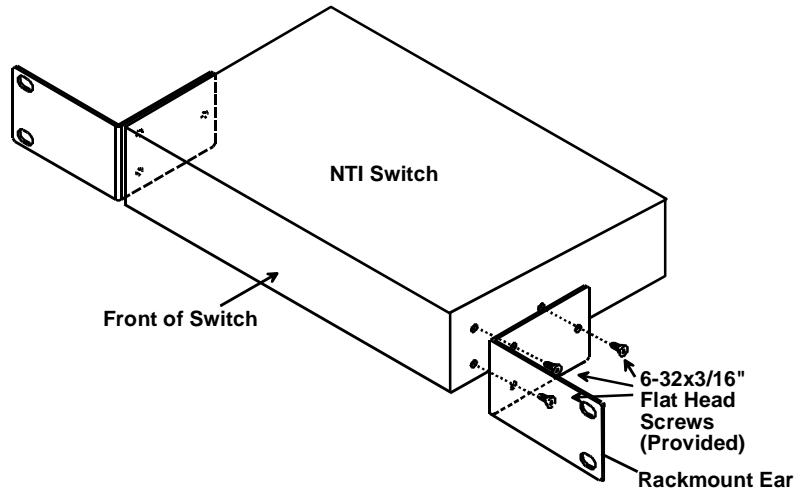

Figure 1- Secure rackmount ears to switch

2. Install 4 captive nuts (not supplied) to the rack in locations that line up with the holes in the mounting ear on the NTI switch.
3. Secure the NTI switch to the rack using four rack screws (10-32, 12-24, M6, etc.- not supplied). Each screw should be of sufficient length to go completely through the NTI mounting ear, rack frame and fully engage all threads in the captive nut. Be sure to tighten all mounting screws securely.
4. Attach all cables securely to the switch and where necessary supply adequate means of strain relief for cables.

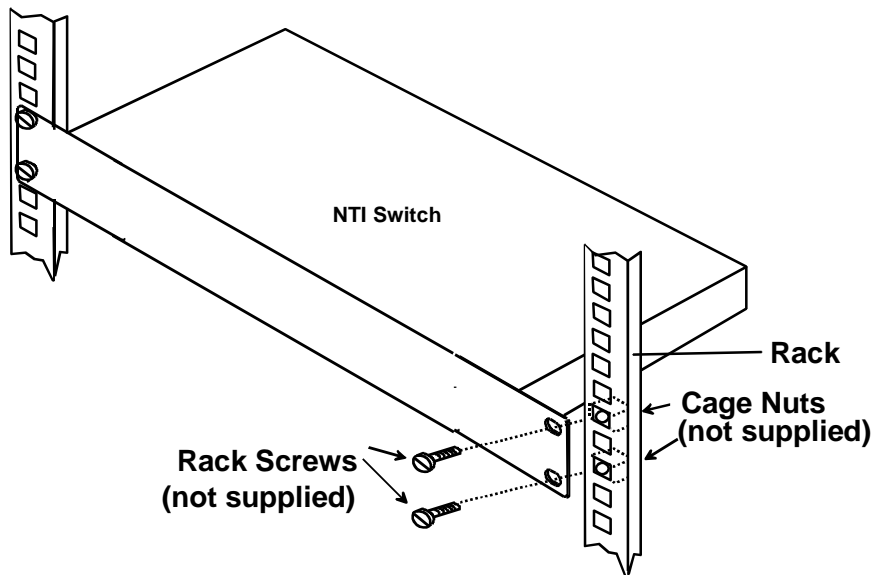



Figure 2- Secure switch to a rack

INSTALLATION

1. It is not necessary to turn the CPUs or monitors OFF during this installation.
2. Connect a HDMI-to-DVI cable (supplied) from a DVI monitor to the HDMI connector labeled with a monitor symbol () on the front of the UNIMUX (See Fig. 3 below.)

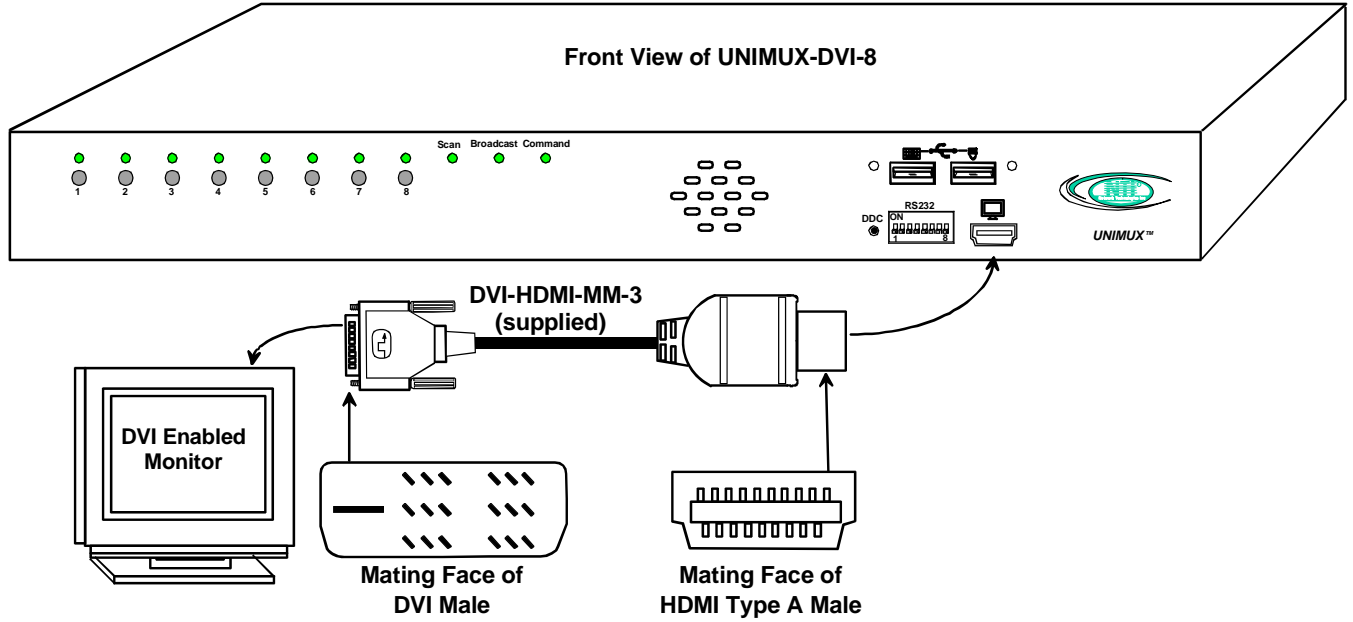



Figure 3- Connect a DVI monitor

3. Connect the male USB type A connector on the keyboard cable to either one of the two USB type A female connectors labeled with the USB symbol () on the front of the UNIMUX.
4. Connect the male USB type A connector on the mouse cable to the remaining USB type A female connector labeled with the USB symbol on the front of the UNIMUX.

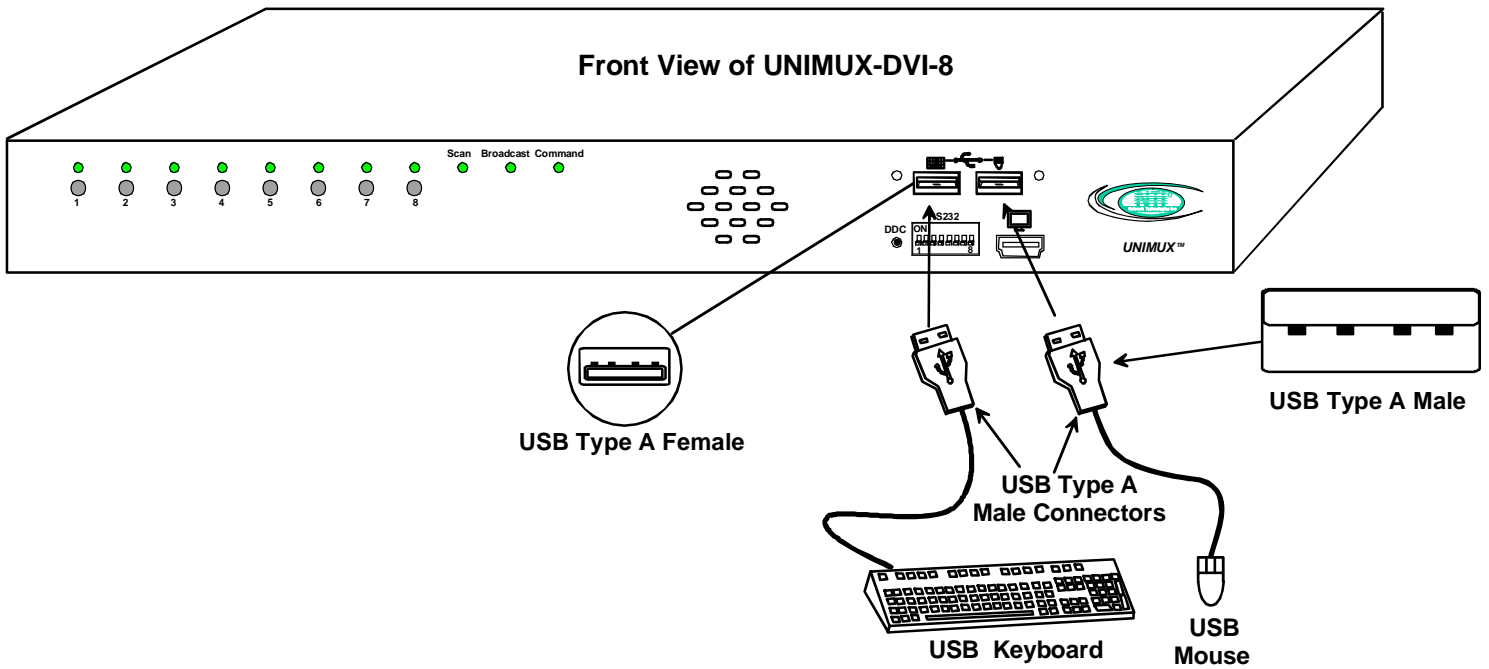

Figure 4- Connect the device(s)

- Connect each CPU to the USB switch using a DVI-HDMI-MM-x (x=3, 6, 10, or 15 foot) cable for each video connection and a USB-AB-yM (y= .5, 1, 2, 3, or 5 meters) for each input device connection – REQUIRED (not supplied). (See Fig. 5 below.) Cables are available from NTI.
- Group the input device and monitor interface cables from each CPU, making sure that cables from the first CPU are connected to the UNIMUX at connectors CPU 1 and VIDEO 1. Cables from the second CPU should connect to CPU 2 and VIDEO 2 connectors...etc.

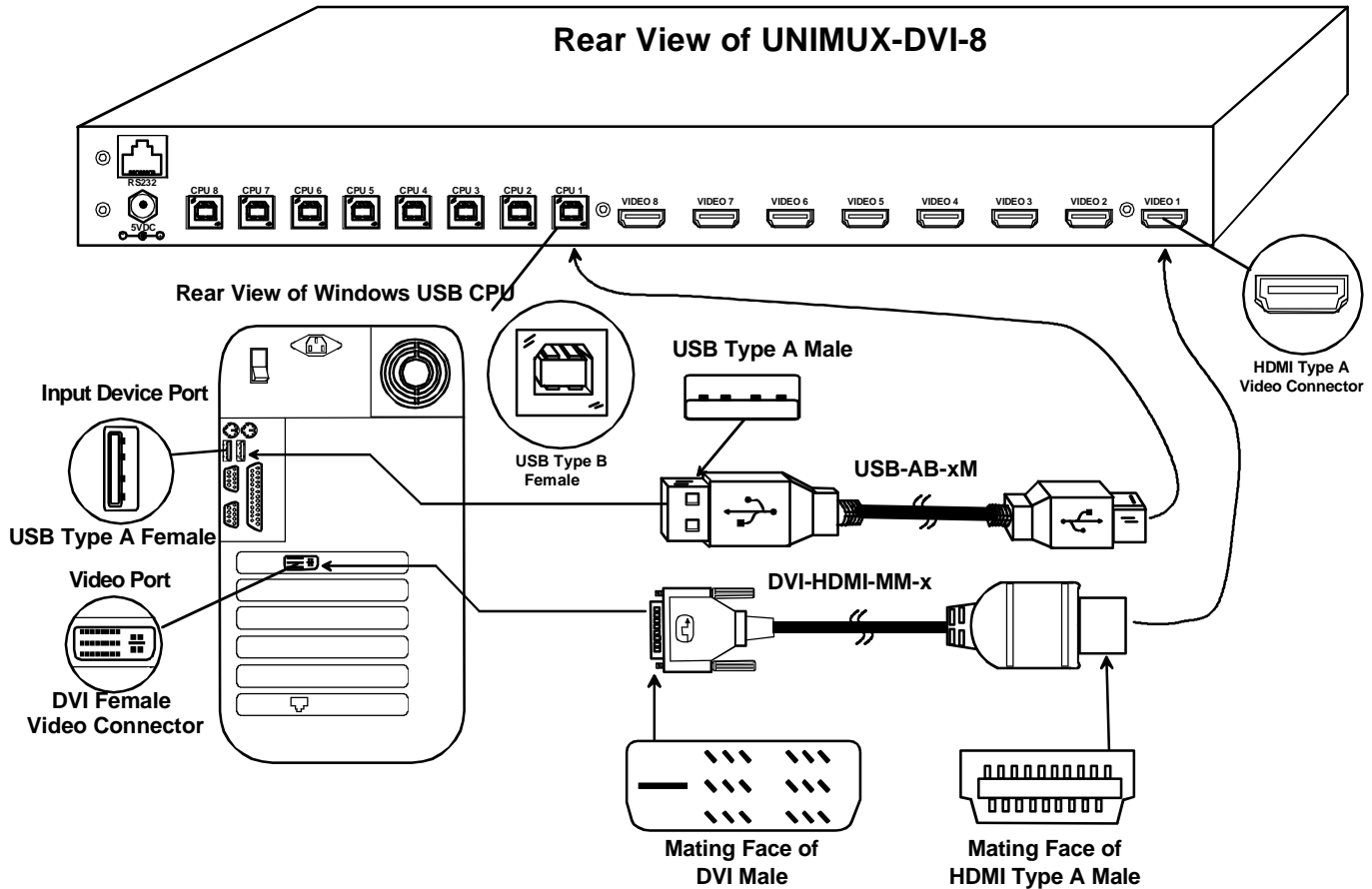

Figure 5- Connect each CPU

- Connect the AC adapter to the UNIMUX. (See Fig. 6 below.)

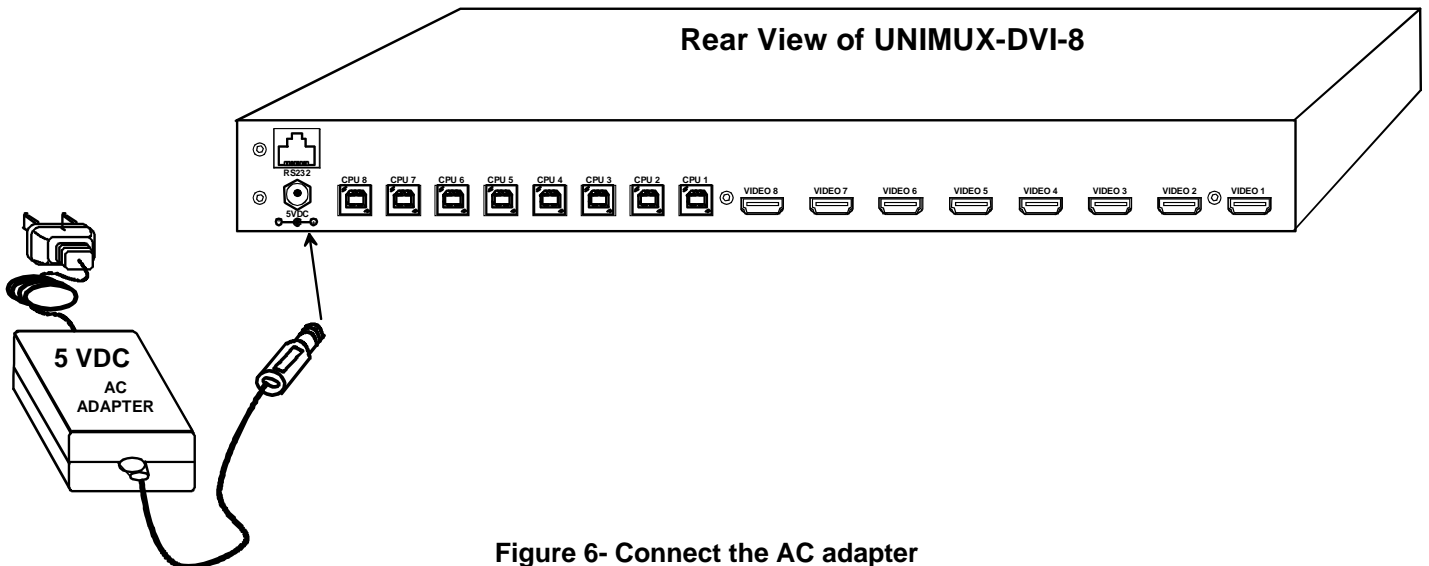

Figure 6- Connect the AC adapter

RS232 Connection

If the RS232 option is installed, connect one end of the CAT5 patch cable (supplied) to the port labeled “RS232” on the rear of the UNIMUX. Plug the other end of the CAT5 cable into either the RJ45-to-DB9 or RJ45-to-DB25 adapter supplied, and connect the adapter to the RS232 port on the control terminal. Follow the instruction under “RS232 Control” on page 12 for configuration and use of the RS232 control feature.

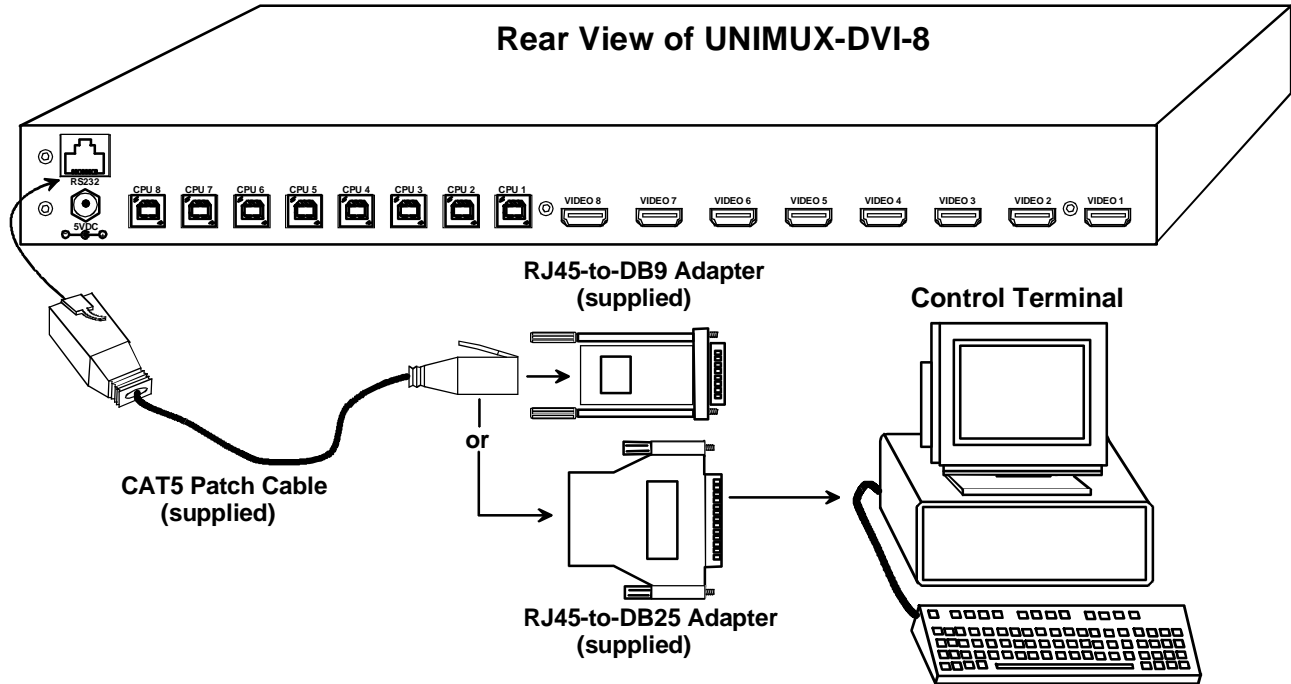

Figure 7- Connect RS232 control terminal

Power-Up Sequence

- Power-up the monitor(s).
- The UNIMUX can be powered at any time.

Note: It is recommended that the monitor be powered-ON before powering on the UNIMUX in order for DDC information to be properly communicated.

- The CPUs can be powered at any time although if a CPU needs a keyboard and/or mouse at power-ON it should be powered after connecting to and powering-ON the UNIMUX.
- USB input devices (keyboard and mouse) can be hot plugged to and from the UNIMUX at any time.

Limitations

- Only USB input device or hub cables can be connected to the UNIMUX at the USB Type A female ports. (See Features and Functions on page 3, item 4.)
- A USB hub (single or multi-port) can be used provided only USB input devices are plugged into it.
- Only a USB Windows or SUN keyboard or USB mouse may be connected to the USB port on a USB MAC keyboard
- A maximum of 8 input devices may be connected to the UNIMUX either directly or through hubs.

See Fig. 8 for some examples of input device combinations that can be used with the UNIMUX.

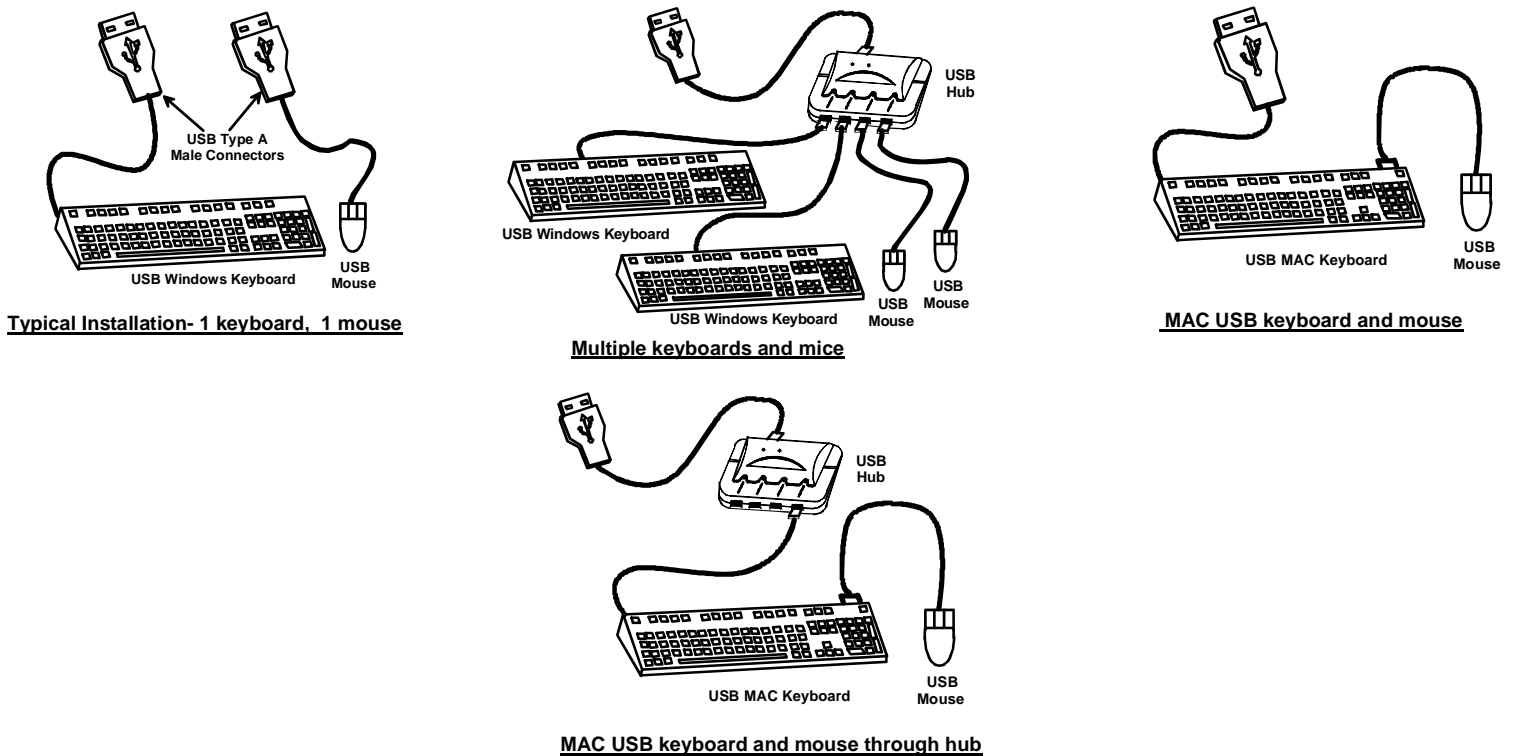

Figure 8- Compatible device combinations

USING THE UNIMUX DVI KVM SWITCH

Once the UNIMUX is properly connected, the UNIMUX will enable a connection to be made between the CPUs attached to its VIDEO and CPU ports and the monitor and input devices attached to the MONITOR and USB Device ports. The LEDs on the control panel of the UNIMUX will illuminate depending on which port (and corresponding CPU) is being connected to the monitor and input devices.

The UNIMUX can be controlled by three methods:

- front control panel using touch-switches and LEDs
- keyboard control through Command Mode
- RS232 control (page 12-optional)

Front Panel Control

There is a touch-switch and LED on the front panel of the UNIMUX for each CPU the switch will connect the monitor and input devices to. Pressing any touch-switch on the front panel of the UNIMUX will connect the corresponding CPU to the monitor and input devices.

Holding down any front panel touch-switch for more than 2 seconds will cause the UNIMUX to cycle through all modes of operation including COMMAND, BROADCAST, SCAN, and NORMAL (described in "Command Mode" below). The three MODE LEDs on the front panel indicate which mode is selected. Release the touch-switch when the LEDs indicate the desired mode. When no mode LEDs are illuminated the user is in Normal Mode controlling directly the CPU to which the user is connected through the UNIMUX.

Keyboard Control

Keyboard control of the UNIMUX can be achieved using Command Mode (below). The keyboard can be used to control all functions of the UNIMUX as an alternative to using the front panel on the UNIMUX.

By pressing <Ctrl> + <`> (accent key), the user can enter Command Mode. Once in Command Mode, typing a series of commands will cause the UNIMUX to connect the user to any one CPU connected to the switch. Pressing the <Esc> key will exit Command Mode.











Command Mode

In order to control the UNIMUX with the keyboard connected, Command Mode must be enabled. To enter Command Mode from the keyboard:











When the COMMAND LED is illuminated, all 3 status lights on the keyboard will illuminate (if they aren't already due to caps lock, scroll lock, and/or num lock) to indicate that Command Mode is enabled and the following functions are available:

Basic Command Functions

Function:	Keystroke:
Increment Port	 or  (select the next higher port ex. 03 → 04)
Decrement Port	 or  (select the next lower port ex. 02 → 01)
Toggle Scan Mode ON and OFF	 (The SCAN Mode LED will also toggle ON and OFF)
Toggle Broadcast Mode ON and OFF	 (The Broadcast Mode LED will toggle ON and OFF.)
Sets scan time-out period for each port.	 -  -  -  (xxx from 002 to 255. ie. T002 would set the time-out period for 2 seconds)

KEY SYMBOLS LEGEND:	
or	PRESS EITHER KEY
+	CHORDED SEQUENCE- PRESS CONSECUTIVELY AND KEEP KEYS PRESSED UNTIL ALL ARE PRESSED.
-	PRESS CONSECUTIVELY

- Selects a specific port  -  -  (Pxx would be P01, P02, etc.)
- Configure port to connect To a MAC CPU  +  +  (xx= 01-8 <M> + <0> + <1> will enable function on Port 1 <M> + <0> + <4> will enable function on Port 4. Keyboard LED's will flash once to confirm command.)
- Configure port to connect To a WINDOWS or SUN CPU  +  +  (xx= 01-8 <W> + <0> + <1> will disable function on Port 1 <W> + <0> + <4> will disable function on Port 4. Keyboard LED's will flash once to confirm command.)

Exit Command Mode



FYI: The user must exit Command Mode to type to a CPU.

To exit Command Mode, either hold down any touch-switch on the front panel for more than 2 seconds, OR press <ESC> on the keyboard.

Scan Mode

When in Scan Mode the switch scans to each port with a CPU powered-ON. (The SCAN LED on the front panel will illuminate and remain ON while in Scan Mode.) The port with the CPU powered-ON remains active while in use until it becomes idle for the configured dwell time (default time-out period is 5 seconds) before switching to the next powered-ON CPU port. See Command Mode section above for configuring the scan dwell time.

Note: The keyboard and mouse must remain idle for the full scan dwell time before the switch selects the next active port.

Broadcast Mode

To activate Broadcast Mode press <Ctrl> + from the Command Mode menu. Broadcast Mode enables the user to type characters to all powered-ON CPUs simultaneously.

Note: The user must type somewhat slowly when in Broadcast Mode (less than 20 wpm) and cannot use the <Backspace> key.

Normal Mode

When all of the UNIMUX mode LEDs are OFF the user is in Normal Mode, controlling the CPU to which the user is connected through the UNIMUX.

No Sun Sleep Mode

Note: It is necessary to configure a Sun CPU (most versions) such that the Sleep Mode is not enabled. If the Sun CPU goes into Sleep Mode either automatically or manually, the user must reboot the Sun CPU in order to resume use of the Sun CPU.

To disable the Sleep Mode, perform the following steps:

1. Select "Power Manager"
2. Look for "Device Idle Time Before Power Saving Starts"
3. Select "Always ON"
4. Look for "Override Device Idle Time For:"
5. Make sure neither "Monitors" nor "Disks" are selected.

Select Country Code

It is possible to configure the UNIMUX to emulate a specific international Sun keyboard regardless of what actual keyboard is connected. This is recommended when the CPU needs the layout code (i.e. a SUN CPU) and the keyboard doesn't have an explicit layout code (i.e. some Windows keyboards). To do this, manually set the UNIMUX to indicate the international keyboard identification number to the CPU using the following procedure;

1. Connect the keyboard to be used to the UNIMUX
2. Enter Command Mode
3. Type Lxx, where xx is the number from the list below that corresponds to the desired country code
4. Exit Command Mode

Note: *If any SUN CPUs are connected to the UNIMUX, they must be rebooted. Keyboard configuration is only read by SUN CPUs on startup.*

Country Codes

00	Auto Detect	13	International (ISO)	26	Swedish
01	Arabic	14	Italian	27	Swiss/French
02	Belgian	15	Japan (Katakana)	28	Swiss/German
03	Canadian-Bilingual	16	Korean	29	Switzerland
04	Canadian-French	17	Latin American	30	Taiwan
05	Czech Republic	18	Netherlands/Dutch	31	Turkish
06	Danish	19	Norwegian	32	UK
07	Finnish	20	Persian (Farsi)	33	US
08	French	21	Poland	34	Yugoslavia
09	German	22	Portuguese		
10	Greek	23	Russia		
11	Hebrew	24	Slovakia		
12	Hungary	25	Spanish		

Figure 9- Country Codes for international SUN keyboards

For more on international SUN keyboards, see page 18.

Mice and Trackballs with MACs

The UNIMUX can be configured to enable full functionality between mice and trackballs having two or more buttons and USB MAC CPUs. By default, the ports on the UNIMUX are configured for use with WINDOWS and SUN CPUs and have no special translation for using multi-function mice and trackballs when a MAC CPU is connected. Using the commands <M> + <x> + <x> (xx = port number), or <W> + <x> + <x> in Command Mode (page 9), either enable or disable this feature as needed for each port.

NOTE: *Be sure to re-configure port for connection to a WINDOWS or SUN CPU if a MAC CPU is removed and a WINDOWS or SUN CPU is then connected.*

RS232 CONTROL

(Optional)

RS232 enables the UNIMUX to be remotely controlled via RS232. To control the UNIMUX via RS232 the user has three options:

- write a program that runs on a PC using the Command Protocol (page 14)
- use the NTI Switch Control Program (page 15) provided on the CD
- use the SerTest program (page 15) provided on the CD

RS232 Connections and Configuration

Remote Connection

The RS232 Interface (optional) is designed to meet the RS232C standard and can be controlled from any CPU or other controller with an RS232 communications port. The pin-out for the RJ45 connector on the unit is as follows:

RS232 (RJ45) CONNECTOR

PIN	SIGNAL	FUNCTION
1	-	No connection
2	-	No connection
3	RX+	Receive data (TXD at host)
4	GND	Ground
5	-	No connection
6	TX+	Transmit data (RXD at host)
7	-	No connection
8	-	No connection

A 5 foot patch cable and two adapters, RJ45-to-DB9 and RJ45-to-DB25, have been provided for connection to most CPUs (see page 7).

Baud Rate

The baud rate can be changed by powering down the unit, changing the 8 position RS232 dip switch on the front of the UNIMUX, and then powering back up. This table shows how to set the baud rate. (Fig. 10 shows switches in their factory default position.)

DIP SWITCH		BAUD RATE
3	2	
OFF	OFF	2400
OFF	ON	9600 (default)
ON	OFF	19200
ON	ON	38400

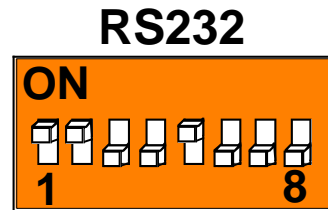

Figure 10- RS232 dip-switches

Unit Address and Loop Back

To allow multiple units to be controlled from a single CPU serial port, the RS232 control interface is designed to allow "daisy chaining" up to 15 units. By setting the appropriate RS232 dip switches, each unit can be given a unique address (1-15). Then the unit will only respond to commands on the bus if its address is embedded in the command. Use the following table to set the unit address.

DIP SWITCH				UNIT ADDRESS
8	7	6	5	
OFF	OFF	OFF	OFF	0 (not valid)
OFF	OFF	OFF	ON	1 (default)
OFF	OFF	ON	OFF	2
OFF	OFF	ON	ON	3
OFF	ON	OFF	OFF	4
OFF	ON	OFF	ON	5
OFF	ON	ON	OFF	6
OFF	ON	ON	ON	7
ON	OFF	OFF	OFF	8
ON	OFF	OFF	ON	9
ON	OFF	ON	OFF	10
ON	OFF	ON	ON	11
ON	ON	OFF	OFF	12
ON	ON	OFF	ON	13
ON	ON	ON	OFF	14
ON	ON	ON	ON	15

Note: The "loop back" RS232 dip switch (RS232 dip switch 1) should be ON for each unit in the chain.

Note: Pin 4 on the RS232 dip switch is not used.

In order to connect multiple switches (up to 15) with RS232 connections to the same CPU, an NTI Matrix-Y-1 cable must be used. Connect the Matrix-Y-1 cable between the RJ45-to-DB9 serial adapter (provided with the RS232 option) and the CPU as shown in Fig. 11.

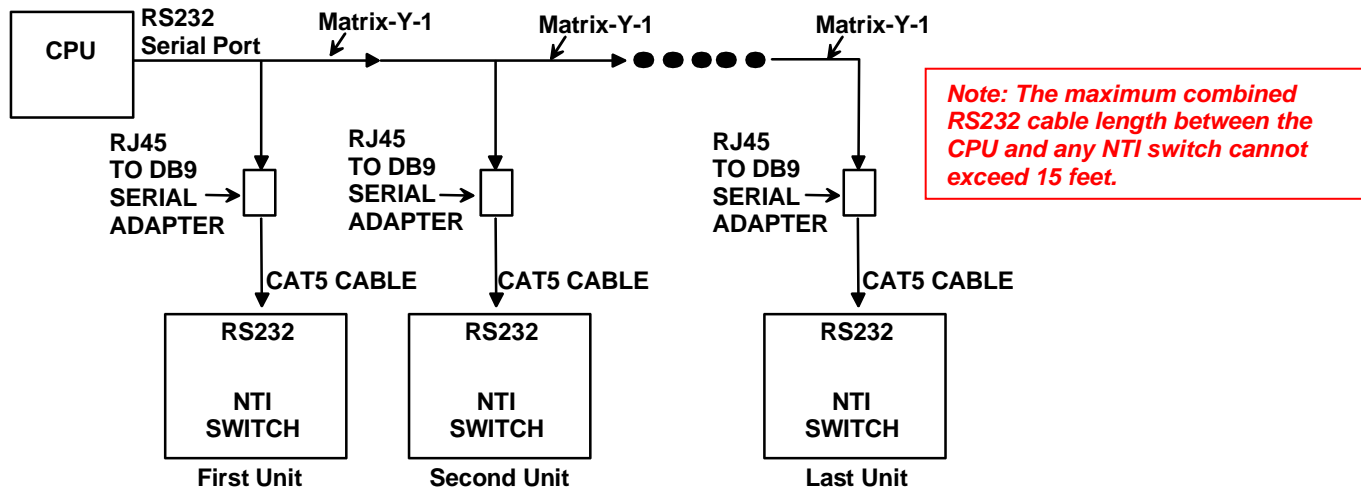

Figure 11- RS232 connection with Matrix-Y-1 cable

Wiring Schematic of Matrix-Y-1 cable

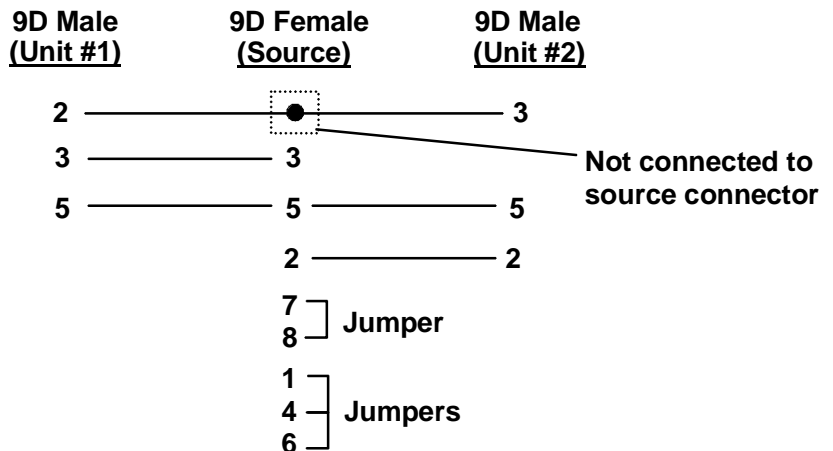

Figure 12- Pinout of Matrix-Y-1 cable

Command Protocol

RS232 commands supported by the unit are defined below. All command strings should be terminated with a <CR> (carriage return). When a command is sent, the entire string is echoed back along with a response from the addressed unit as shown in the command definitions. All characters in the command string should be upper case, and all numbers below 10 should have a leading 0 (ex: 1 = 01). As command strings are sent, the inner character delay cannot exceed 500 milliseconds.

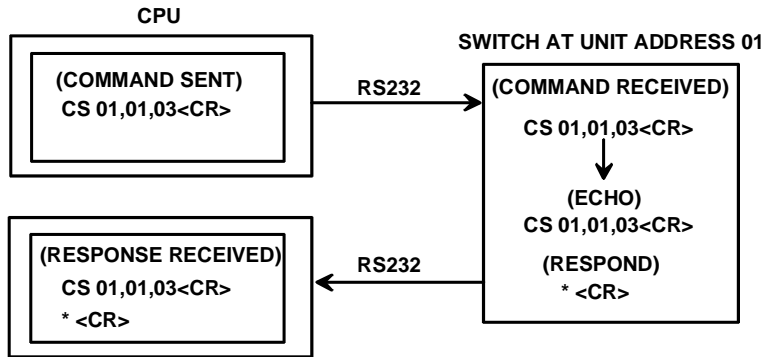

Figure 13- RS232 Communication Illustrated

Note: To use this command protocol, the user is required to write a program that will send an entire command string all at once, not character by character. Programs that send one character at a time (such as HyperTerminal) cannot be used to control the UNIMUX. Alternatively, the user may use the NTI Switch Control Program or SerTest to control the UNIMUX via RS232 (see page 15).

Legend: (All numbers must be two digits)

SW : Switch (01-15) (Unit Address)
 OP : Output (User) Port (01)
 IP : Input (CPU) Port (01-MAXINPUTS)
 <CR> : Carriage Return (Hex 0xD)

Note: For units with one output (user) port, use 01 for the output selection.

Command Definitions

Command String	Good Response	Description
CS SW,IP,OP	*<CR>	Connect Output (User) Port To specific Input (CPU) Port
RO SW,OP	*<CR>IP<CR>	Read Connection For Output (User) Port to Input (CPU) Port
RS SW	*<CR>	Internal Reset
RU SW	*<CR>IP,OP<CR>	Read Unit Size
SS SW,00	*<CR>	Disable Autostatus feature (see below)
SS SW,01	*<CR>	Enable Autostatus feature (see below)
GO SW,OP	*<CR>go SW,OP:IP<CR>	Read connection of a Output (User) Port to Input (CPU) Port (different response format than RO command)
GM SW,00	*<CR>go OP,IP (all ports)<CR>	Read connection matrix of all Output (User) ports

If the first field is not a known command (as listed above) or SW field is different from the unit address programmed at the dip switch (page 12), the command will be ignored. If the SW field corresponds to the unit address, but if the syntax is wrong after this field, the switch will answer with a bad response ?<CR>.

Autostatus

When Autostatus is enabled, any output (user) -to-input (CPU) connection change in the UNIMUX will cause an Autostatus message to be sent via RS232 to the administrator. The format of the message would be "pc SW,OP:IP<CR>"

Example of an Autostatus message:

pc 01,01:04<CR>

which means "At the switch with unit address 01, the output (User) (01) has changed connection to input (CPU) port 04."

Note: An Autostatus message to the administrator will be delayed by any RS232 traffic being received by the switch from the administrator.

By default, Autostatus is disabled and must be manually enabled.

NTI Switch Control Program For Windows 9X, NT, 2000, XP, And Vista

The NTI Switch Control Program is an easy and powerful graphical program that controls NTI switches through an RS232 interface. The NTI Switch Control Program is included on the CD packaged with the UNIMUX. The NTI Switch Control Program is downloaded by clicking on the link "Download NTI Switch Control Program".

To install the NTI Switch Control Program after downloading

1. Locate the **Setup.exe** in the directory the program was downloaded to and double-click on it
2. Follow the instructions on the screen

Note: In order to use the NTI Switch Control Program to control the UNIMUX, the UNIMUX RS232 port must be set at a baud rate of 9600 bps (see page 12).

The NTI Switch Control Program performs best on monitors set to a screen resolution of at least 800 X 600. Instruction for using the NTI Switch Control Program is available by opening "MSCP Help" in the "NTI" program group once the program has been installed and is open on the screen.

To open "MSCP Help" from the Windows desktop

1. Click on **START**
2. Click on **PROGRAMS**
3. Click on **NTI**
4. Click on **MSCP Help**

SerTest- RS232 Interface Test Program

This software allows a user to test the functions of an NTI server switch, matrix switch or Multi-user/Multi-platform/Single-user switch RS232 interface. The SerTest program is automatically loaded when installing the NTI Switch Control Program as described above. The SerTest program, located in the NTI program group, generates a main menu with the 4 selections described below:

Main Options

- Switch Operations - send commands to the unit.
- Ethernet Operations - set ethernet connection variables (not applicable to this model)
- Setup Options - set COM port, baud rate, and unit address
- About SerTest - display the program version

If Matrix Operations is selected, the following menu is displayed:

SWITCH OPERATIONS

- 1) Reset Unit
 - send a reset command to the switch
 - the current unit address is displayed in parentheses
- 2) Reset All Units
 - send an internal reset command to all switches
- 3) Connect Output/User to an Input/CPU
 - connect an output to an input
- 4) Connect All Outputs/Users to an Input/CPU (not applicable to this model)
 - connect all outputs to an input
- 5) Connect Audio Output/User to an Input/CPU (not applicable to this model)
 - connect an output to an input
- 6) Connect All Audio Outputs/Users to an Input/CPU (not applicable to this model)
 - connect all outputs to an input
- 7) Change Mute Status for Audio Output/User (not applicable to this model)
 - mute or un-mute the Audio port output

- 8) Change Volume for Audio Output/User (not applicable to this model)
 - change Audio port output volume
- 9) Read Connection for Output/User
 - read what input is connected to the specified output
- a) Read Connection for Audio Output/User (not applicable to this model)
 - read what input is connected to the specified output
- b) Read Mute Status and Volume for Audio Output/User (not applicable to this model)
 - read the volume and the mute status of the specified output
- c) Read Unit Size
 - read the switch size (number of inputs and outputs)
- d) Read Unit Version/Revision String (not supported by this model)
 - read a string containing the switch version, type, and size
- e) Save I/O Connections into Unit Memory (not applicable to this model)
 - save the connections into switch memory bank
- f) Restore I/O Connections from Unit Memory (not applicable to this model)
 - restore the connections from switch memory bank
- g) Save All Units I/O Connections into Units Memory (not applicable to this model)
 - save the connections into switch memory bank, command for all switches
- h) Restore All Units I/O Connections from Units Memory (not applicable to this model)
 - restore the connections from switch memory bank, command for all switches
- i) Change All Units Baud Rate (9600/COM1)
 - change RS-232 Baud rate of all switches
 - the current baud rate and serial port are displayed in parentheses

ETHERNET OPERATIONS (not applicable to this model)

SETUP OPTIONS

- 1) select Com port current: (COM1:)
 - select PC serial port
 - the current PC serial port is displayed in parentheses
- 2) select Baud rate current: (9600)
 - select PC serial port baud rate
 - the current baud rate is displayed in parentheses
- 3) set unit Address current: (1)
 - select the unit address of the switch to be connected to by this program
 - the current address is displayed in parentheses

For any selection that requires user input, the user is prompted. When commands are sent to the UNIMUX, the command string and UNIMUX responses are echoed to the screen. All commands generated by the program are formatted according to the information provided in sections above. If any transmission problems are detected, an error message is displayed.

Press <Esc> or <Enter> to back out to the main menu and press again to exit.

KEYBOARD FEATURES

The keyboard configuration of each CPU is saved in the UNIMUX. For example, if the CPU attached to Port 2 had CAPS LOCK and NUM LOCK selected the last time that CPU was accessed, then they will automatically be set when that CPU is accessed again.

Keyboard-To-Computer Translation (See Fig. 14 on page 18 for reference.)

The UNIMUX enables a mixture of otherwise incompatible peripheral computer components to be connected together. This is accomplished by performing keyboard-to-computer translations automatically (i.e. translate a MAC keyboard and mouse to a Windows type CPU). The chart below shows the capabilities of devices controlling certain CPU types.

Translation Capabilities

<i>Device</i>	CPU		
	<i>Sun</i>	<i>Mac</i>	<i>Windows</i>
Sun Keyboard	Full functionality	Full functionality	Full functionality
AT101 Keyboard	Extra keys emulation	Power key emulation	Full functionality
Mac keyboard	Extra keys emulation	Full functionality	Full functionality-except Application Key
Apple Pro Keyboard	Extra keys emulation	Extra Keys not supported (Eject, Mute, Volume+, Volume-)	Full functionality
Sun Mouse	Full functionality	Full functionality	Full functionality
Wheel Mouse	Full functionality	Full functionality	Full functionality
Apple Mouse	Right button emulation	Full functionality	Right button emulation

Translation Tables

Use the charts below to type SUN's additional keys with Win95 and Apple keyboards:

SUN Extra Keys

WINxx or Mac Keyboards	Sun Extra Keys
Space Bar + F1	Stop
Space Bar + F2	Again
Space Bar + F3	Props
Space Bar + F4	Undo
Space Bar + F5	Front
Space Bar + F6	Copy
Space Bar + F7	Open
Space Bar + F8	Paste
Space Bar + F9	Find
Space Bar + F10	Cut
Space Bar + F11	Help
Space Bar + F12	Compose
Space Bar + Up Arrow	Volume +
Space Bar + Down Arrow	Volume -
Space Bar + Left Arrow	Mute

Power Key Emulation

Win95 Keyboards	Mac CPU	Sun CPU
SB+RT Arrow	Power	Power

Mouse Click Equivalents

To emulate right-button click using an Apple 1-button mouse, hold down the CMND key (key with open apple insignia) while pressing the mouse button.

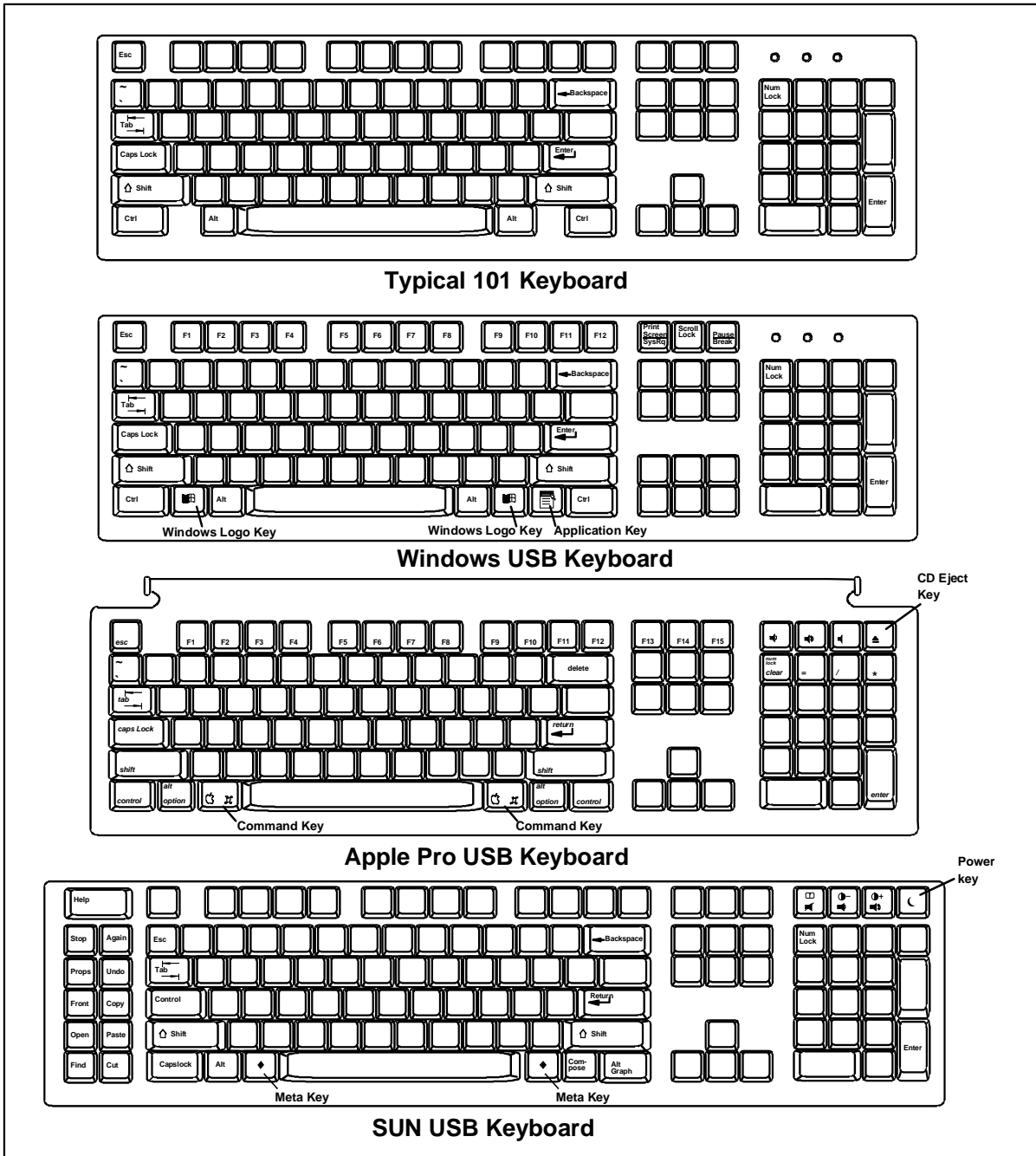

Figure 14- Keyboard Layouts

International Sun Keyboards

The UNIMUX can recognize international layouts for Sun keyboards. In order to use an international Sun keyboard, follow this procedure:

1. Power-OFF the CPU from the UNIMUX
2. Connect the international keyboard to be used to the UNIMUX
3. Power-ON the CPU to the UNIMUX

It is also possible to configure the UNIMUX to emulate a specific international Sun keyboard regardless of what actual keyboard is connected. This is recommended when the CPU needs the layout code (i.e. a SUN CPU) and the keyboard doesn't have an explicit layout code (i.e. some Windows keyboards). To do this, manually set the UNIMUX to indicate the international keyboard identification number to the CPU by following the instruction on page 11.

TROUBLESHOOTING

PROBLEM: Keyboard Errors

SOLUTION: Check cable connections on each CPU and the switch.

PROBLEM: No Video

SOLUTION: Check cable connections on each CPU and the switch. Verify that keyboard and video connect from each CPU to matching ports. After reconnecting, CPU may need to be re-booted in order to sense the monitor connection.

PROBLEM: No Mouse Movement

SOLUTION: Check cable connections of mouse. Verify that mouse driver was loaded.

INDEX

addressing, 12
 Autostatus, 14
 baud rate, 12
 Broadcast mode, 10
 Command mode, 9
 control methods, 9
 country codes, 11
 CPUs supported, 1
 daisy-chaining, 12
 definitions, 2
 devices supported, 1
 features, 3
 front panel control, 9
 Installation, 5
 international keyboard layouts, 18
 Keyboard control, 9
 keyboard features, 17
 keyboard translation, 17
 limitations, 8
 MAC mice and trackballs, 11
 materials supplied, 2
 Matrix-Y-1 cable, 13
 power-up sequence, 8
 Rackmounting, 4
 RS232 commands, 14
 RS232 Control, 12
 RS232 pinout, 12
 Scan mode, 10
 SerTest, 15
 Sun sleep mode, 10
 Switch Control Program, 15

WARRANTY INFORMATION

The warranty period on this product (parts and labor) is two (2) years from the date of purchase. Please contact Network Technologies Inc at **(800) 742-8324** (800-RGB-TECH) or **(330) 562-7070** or visit our website at <http://www.networktechinc.com> for information regarding repairs and/or returns. A return authorization number is required for all repairs/returns.

Free Manuals Download Website

<http://myh66.com>

<http://usermanuals.us>

<http://www.somanuals.com>

<http://www.4manuals.cc>

<http://www.manual-lib.com>

<http://www.404manual.com>

<http://www.luxmanual.com>

<http://aubethermostatmanual.com>

Golf course search by state

<http://golfingnear.com>

Email search by domain

<http://emailbydomain.com>

Auto manuals search

<http://auto.somanuals.com>

TV manuals search

<http://tv.somanuals.com>