



NTI NETWORK
TECHNOLOGIES
INCORPORATED

1275 Danner Dr Tel:330-562-7070
Aurora, OH 44202 Fax:330-562-1999
www.nti1.com

VEEMUX[®] Series

SM-8X4-HDA

Audio/HD Video Matrix Switch Installation and Operation Manual



TRADEMARK

VEEMUX is a registered trademark of Network Technologies Inc in the U.S. and other countries.

COPYRIGHT

Copyright © 2006 by Network Technologies Inc. All rights reserved. No part of this publication may be reproduced, stored in a retrieval system, or transmitted, in any form or by any means, electronic, mechanical, photocopying, recording, or otherwise, without the prior written consent of Network Technologies Inc, 1275 Danner Drive, Aurora, Ohio 44202.

CHANGES

The material in this guide is for information only and is subject to change without notice. Network Technologies Inc reserves the right to make changes in the product design without reservation and without notification to its users.

TABLE OF CONTENTS

Introduction.....	1
Materials	1
Cables.....	1
Default User Name and Passwords	1
Features and Functions.....	2
Installation	3
Connect the Sources	3
Connect the Devices.....	4
Connect RS232	5
Connect to the Ethernet.....	5
Power Up	6
Control Options	7
Front Panel LCD with Keypad Control.....	7
Volume Control	8
Memory Functions	8
Menu Button.....	8
Scan Mode.....	9
RS232 Control	10
Remote Connection	10
Baud Rate.....	10
Unit Address	10
Command Protocol.....	11
Matrix Switcher's Control Program For Windows 9X, NT, 2000 AND XP	12
SerTest- RS232 Interface Test Program	12
Main Options.....	12
Matrix Operations.....	13
Ethernet Operations.....	13
Setup Options	13
Telnet Interface.....	14
Web Interface	16
Enter the Password	16
Video Switch Page	17
Audio Switch Page	18
Setup Pages	19
Input Names	20
Output Names	21
Scan Mode.....	21
Update Firmware	22
Change Password Page.....	23
Help Page.....	23
Update Web Server	23
Logout Page	23
Device Discovery Tool.....	24
Infrared Control	25
Features And Functions.....	25
Keypad.....	25
LCD Display.....	25
How To Use The IRT	26
Change the Switch.....	26
Change Output Port.....	27
Change Input Port.....	27
Set Configuration	28
Battery Replacement	29
Specifications.....	29
Troubleshooting the IRT	29
RS232 Connection Cables.....	30

Pinout of RS232 port on VEEMUX-A	30
Pinouts for typical DCE to DTE cable for CPU connection	30
Pinout for Matrix Y-1 Cable	31
Safety Statements	31
Rack Mounting Instructions	32
Specifications	33
Troubleshooting	34
Warranty Information	34

TABLE OF FIGURES

Figure 1- Connect sources to the VEEMUX-A	3
Figure 2- Stereo audio connection block	4
Figure 3- Connect devices, audio and video	4
Figure 4- Connect cable for RS232 control	5
Figure 5- Connect the VEEMUX-A to the Ethernet	5
Figure 6- Plug in and power up	6
Figure 7- RS232 connection with Matrix-Y-1 cable	10
Figure 8- Web interface Welcome page	16
Figure 9- Web interface Login Prompt	16
Figure 10- Web interface Video Switch page	17
Figure 11- Web interface Audio Switch page	18
Figure 12- Web interface Setup page	19
Figure 13- Web interface Serial Setup page	20
Figure 14- Web interface Input Names page	20
Figure 15- Web interface Output Names page	21
Figure 16- Web interface Scan Mode page	21
Figure 17- Web interface Update Firmware page	22
Figure 18- Web interface Password page	23
Figure 19- Updating the Web Server	23
Figure 20- Web interface Logout page	23
Figure 21- Device Discovery Tool page	24
Figure 23- Pinout for Matrix Y-1 Cable	31
Figure 24- Mount the VEEMUX-A to a rack	32

INTRODUCTION

The VEEMUX SM-8X4-HDA (VEEMUX-A) is a versatile multi-input audio/video matrix switch that independently switches eight sets of incoming YPbPr component video and analog/digital audio signals to any or all of the four outputs. Each input and output has YPbPr component video, L/R analog audio (balanced/unbalanced), and digital audio on coax (S/PDIF).

Video resolution up to 1920x1080@60Hz is supported with no degradation – guaranteed. An LCD on the front panel indicates the current connections. The VEEMUX-A can be controlled by four methods: Front Panel LCD with Keypad, RS232 interface, Ethernet, or optional Infrared Remote. The SM-8X4-HDA is the ideal solution for many applications, such as mission critical command centers, sports facilities and entertainment venues.

Features

- Supports High Definition and Standard Definition YPbPr component video, S-Video or composite video.
- Audio can be unbalanced analog stereo, balanced analog stereo or digital S/PDIF.
- Supports S/PDIF, DTS Digital Surround™, and Dolby Digital™ 5.1 digital signals.
- Supports 480i (interlaced), 480p (progressive), 720i, 720p, 1080i, and 1080p formats.
- Features break-away audio- allowing audio to be switched independent of video.
- Equipped with volume control: -80dB to 10dB, in 1dB steps.
- Control the switch through Ethernet, RS232, front panel buttons or optional IR remote.

Optional Feature

- Infrared Control (see page 25)- to order, add "IR" to the part number (i.e. SM-8X4-HDA-IR)

Materials

Materials Supplied with this kit:

- NTI SM-8X4-HDA Audio/HD Video Matrix switch
- IEC Line cord, country specific
- CD with a pdf file of this owners manual
 - the NTI Discovery Tool
 - the Matrix Switcher's Control Program

Cables

All cables are sold separately. The following table lists the available stocked cables with their length in feet. Custom cables are available – contact NTI for pricing and distance / resolution limitations.

NTI NAME	DESCRIPTION
VGA and AUDIO	
4CINT-6	RGBS Video 4 mini coaxes in one jacket- 6 feet long
3CINT-6	RGBS Video 3 mini coaxes in one jacket- 6 feet long
4CEXT-xx	RGBS Video 4 mini coaxes in one jacket- up to 250 feet long
3CEXT-xx	RGBS Video 3 mini coaxes in one jacket- up to 250 feet long
RS232	
Matrix-Y-1 or see page 31 for alternative cables	RS232 Interface Cable- Connectors are 9D male- female-female 12" long (also see alternative cable specifications on page 31)

Default User Name and Passwords

The default Telnet password is **admin** (lower case letters only) . For instruction on using Telnet, see page 15.

The default Web Interface user name is **Administrator** (upper case letter for "A" only).

The default Web Interface password is **admin** (lower case letters only). For instruction on using the Web Interface, see page 17.

FEATURES AND FUNCTIONS

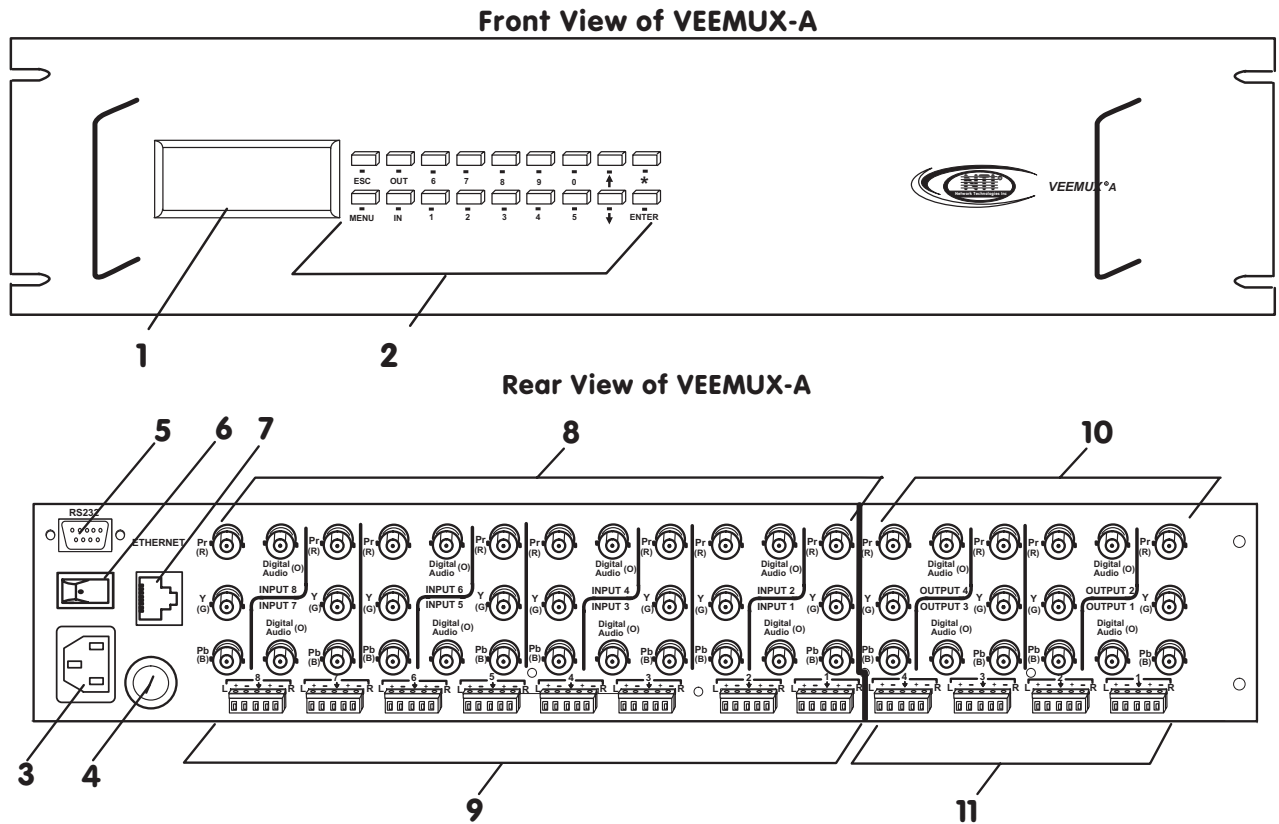

1. LCD Display- for visual indication of input-to-output connections and for configuration of the VEEMUX-A.
2. Keypad- buttons for user control over switch functions
3. IEC Power Connector- for attachment of power cord
4. Fuse Holder- holder for replaceable overcurrent protection fuse
5. RS232 In/Out - 9D female connector- for attaching RS232 interface cable from a user terminal
6. Power ON/OFF switch
7. Ethernet- RJ45 female connector- for connection of CAT5 cable to LAN for WEB interface
8. INPUT- BNC connectors- for video and digital audio input from audio/video sources
9. INPUT- terminals- for connection of analog (balanced or unbalanced) stereo audio signals from analog audio sources
10. OUTPUT-BNC connectors- for video and digital audio output to audio/video devices
11. OUTPUT- terminals- for analog (balanced or unbalanced) stereo audio signal output to analog audio devices

INSTALLATION

Connect the Sources

1. Turn OFF power to all video sources (inputs) that will be connected to the VEEMUX-A before connecting or disconnecting any cables.
2. Connect each video source to the VEEMUX-A using 4CEXT-xx BNC cables. The groups of terminals are labeled INPUT1-8. and colored cables attach to terminals as follows: green (Y), blue (Pb) and red (Pr). If necessary, use BNC to RCA adapters to connect the cables to the video sources (see Fig. 1). If the cables used do not have BNC connectors on them but have RCA connectors instead, use an RCA-to-BNC adapter on each to connect to the VEEMUX-A.

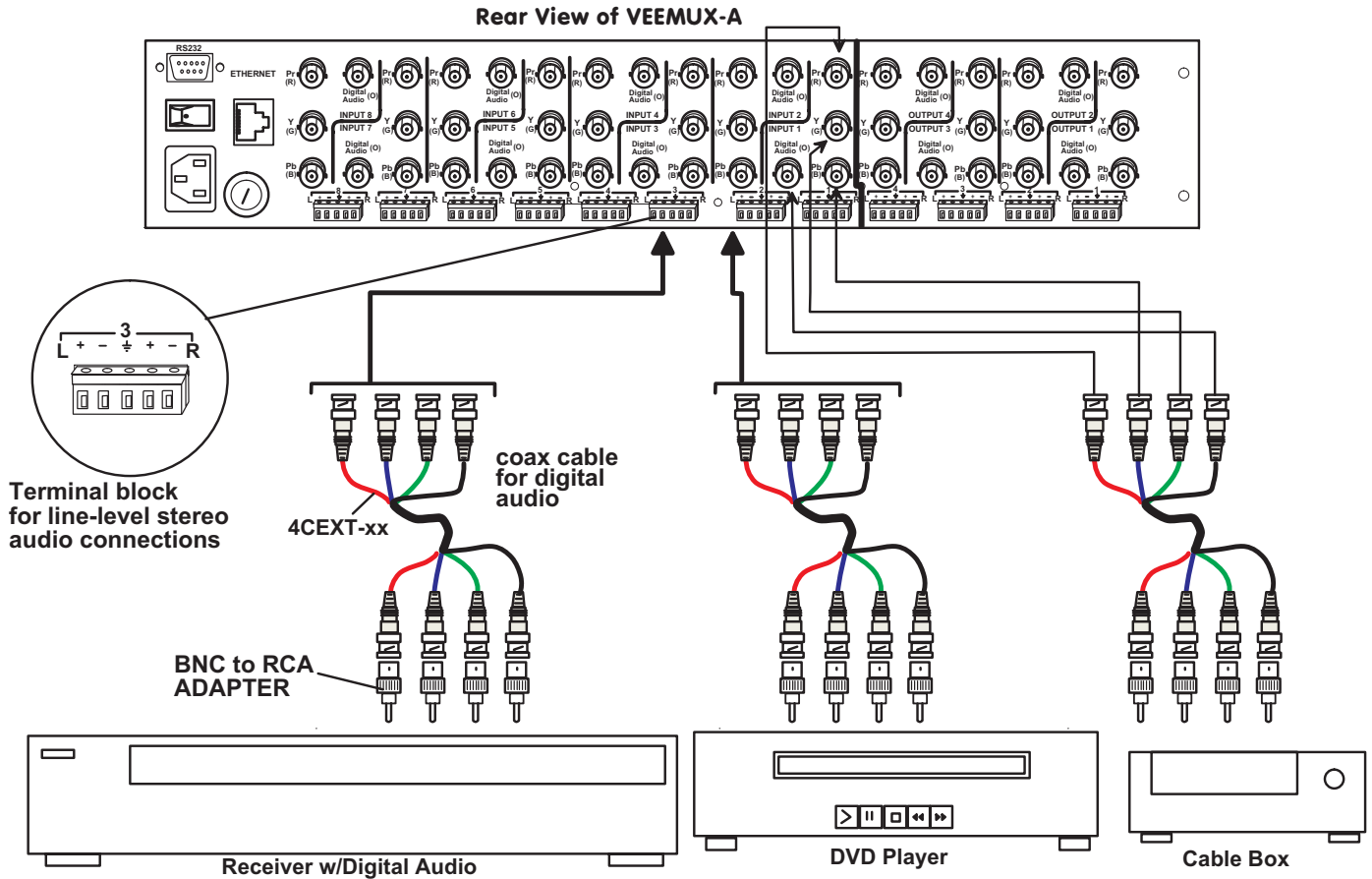

3. Audio connections can either be digital or analog (stereo). A connector marked "DIGITAL" is provided in each INPUT group for digital audio cable connection. A terminal block for the connection of a line-level stereo audio cable is located below each connector group. (See Fig. 1) The VEEMUX-A supports balanced line-level audio signals, as well as unbalanced. Fig. 2 shows the proper cable connection method for each.

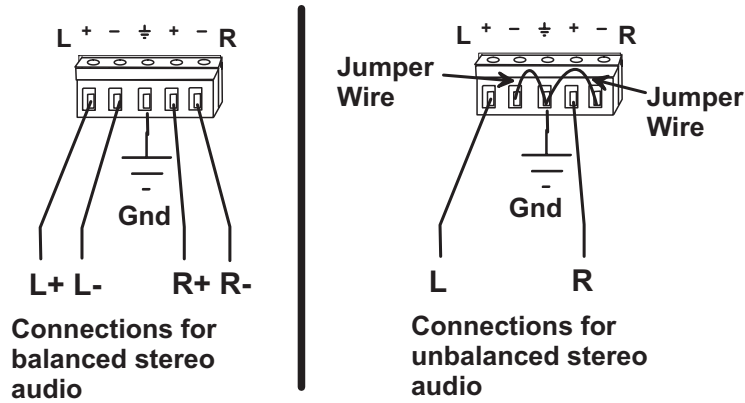

Figure 2- Stereo audio connection block

Connect the Devices

1. Connect each of the video display devices to the VEEMUX-A using 3CEXT-xx or 4CEXT-xx cables. The groups of terminals are labeled OUTPUT1-4. Use BNC to RCA adapters (as shown in figure 3) to connect the BNC cables to the devices. Connectors on the VEEMUX-A are labeled green (Y), blue (Pb) and red (Pr) to correspond with the colors on the BNC cables.
2. Connect each digital audio device to a OUTPUT connector labeled "DIGITAL". If the audio device is a stereo type device, connect it an OUTPUT terminal block. Connections to the terminal block should be made as shown in Fig. 2 for devices that are compatible with balanced or unbalanced stereo audio.

Note: Stereo audio devices can not be used to listen to digital audio sources, and digital audio devices can not be used to listen to stereo audio sources.

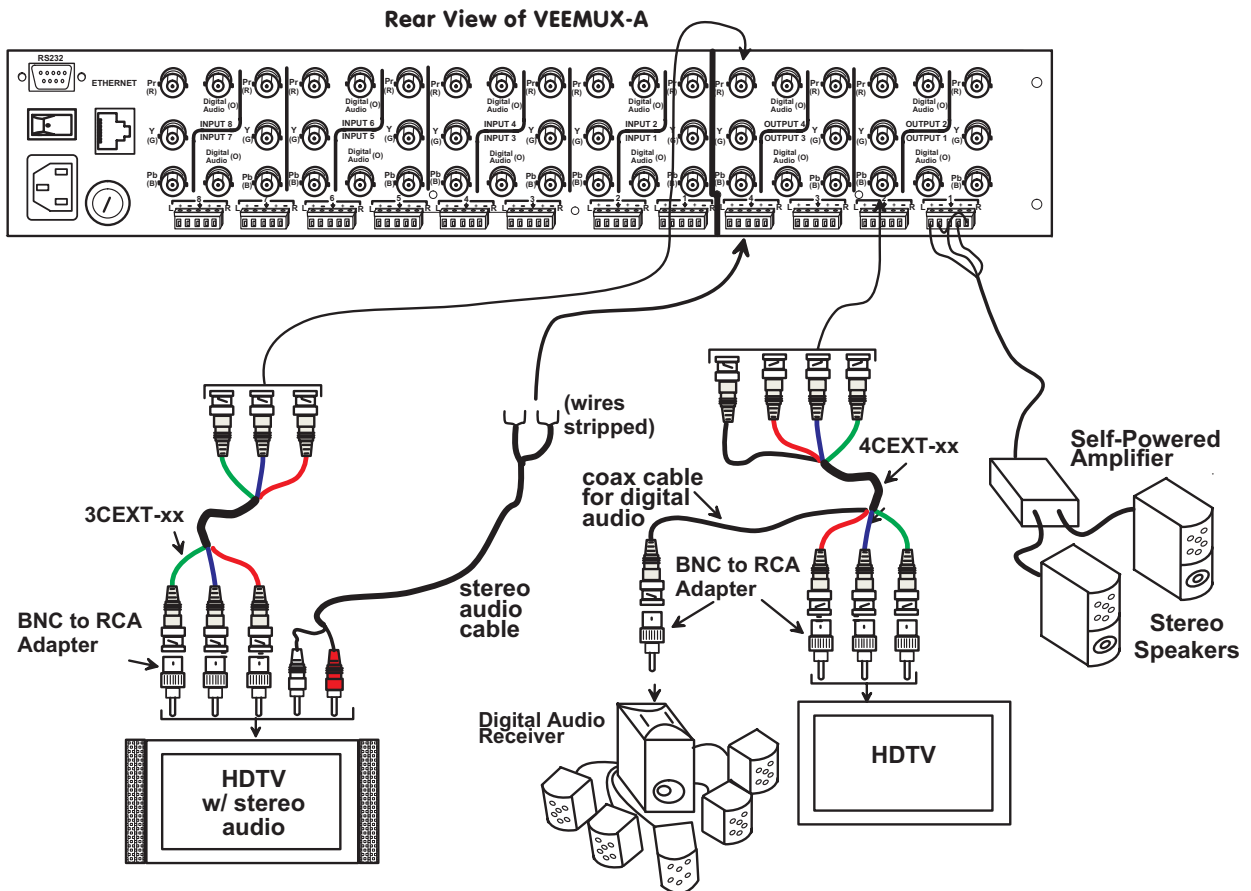

Figure 3- Connect devices, audio and video

Connect RS232

RS232 control can be achieved using a separate user terminal or CPU with a terminal program. To make a terminal connection, connect a serial cable (specifications on page 30) between the user terminal and the 9 pin DIN female connector on the VEEMUX-A labeled "RS232". (See Fig. 3)

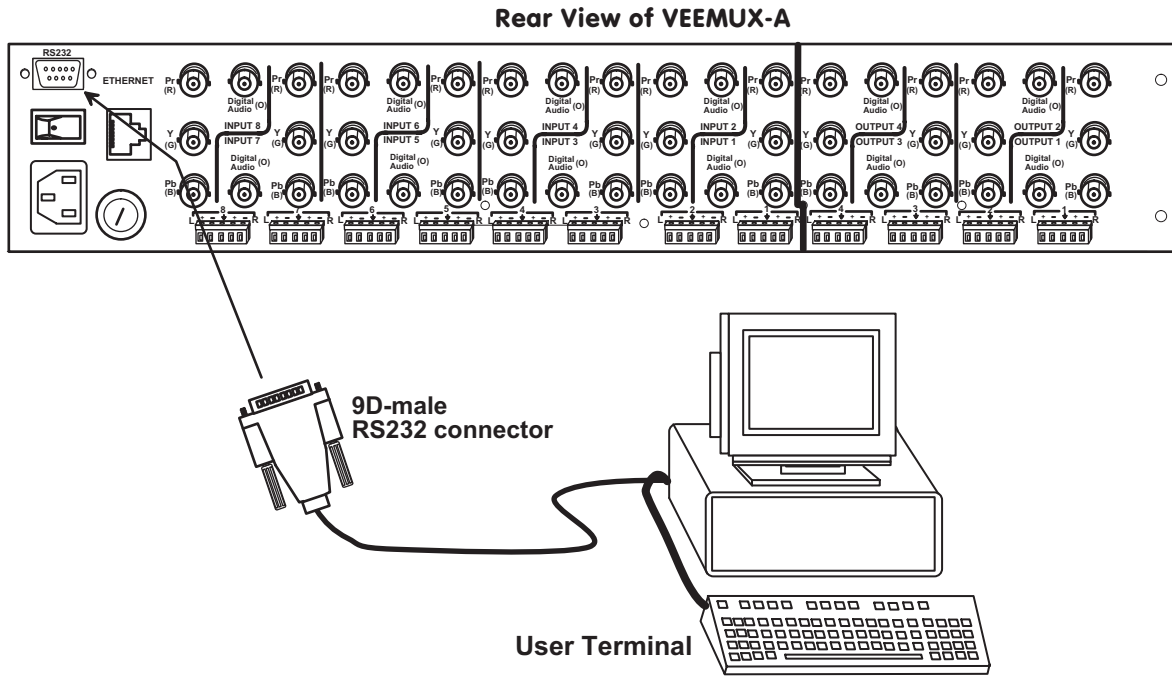

Figure 4- Connect cable for RS232 control

Connect to the Ethernet

If the Telnet Interface (page 14) or Web Interface (page 16) will be used, an Ethernet connection to the Local Area Network (LAN) must be made using CAT 5 cable with RJ45 connectors wired straight through (pin 1 to pin 1, pin 2 to pin 2, etc). Connect a CAT 5 cable between the connector label "ETHERNET" and the LAN (see Fig. 4).

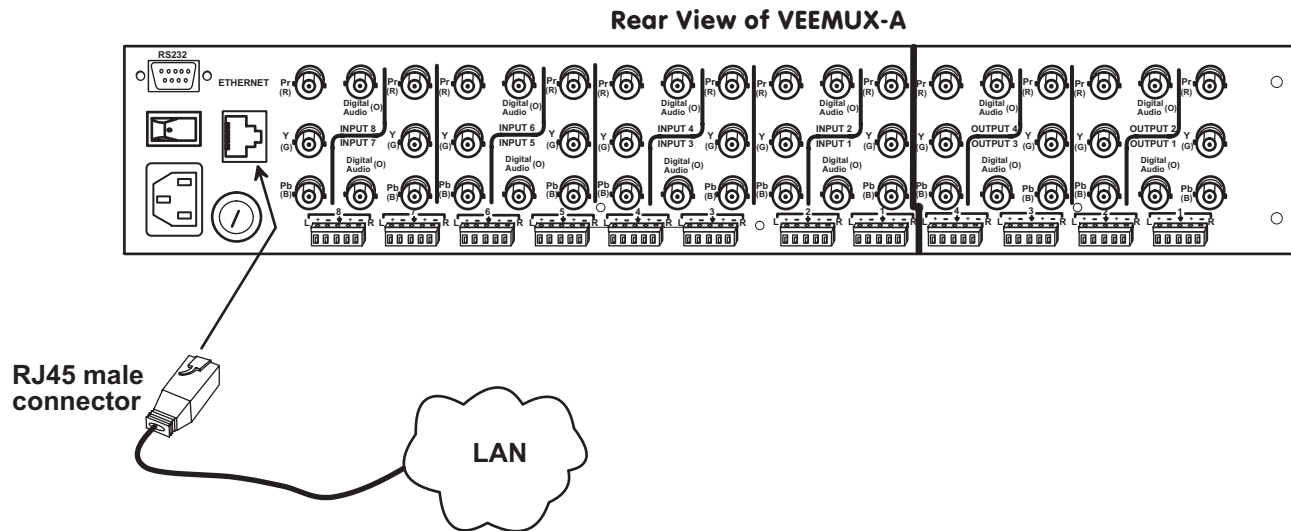

Figure 5- Connect the VEEMUX-A to the Ethernet

Power Up

1. Connect the IEC power cord to the VEEMUX-A and plug the cord into an AC power outlet.
2. Turn ON power to the VEEMUX-A using the switch above the IEC socket.
3. Turn ON power to the video and audio sources, and the video and audio devices connected to the VEEMUX-A, if they are not already ON.

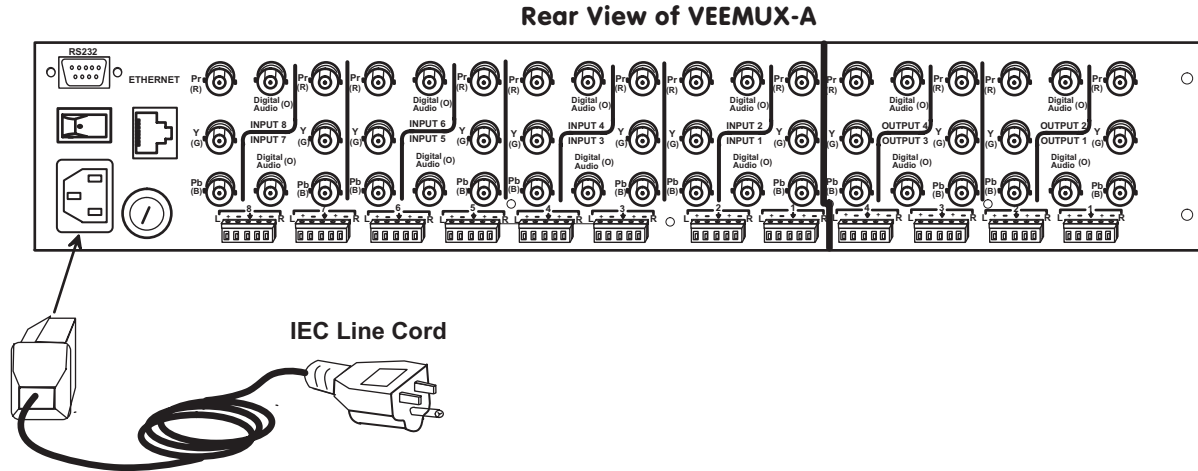

Figure 6- Plug in and power up

CONTROL OPTIONS

The VEEMUX-A video matrix switch has four methods of control:

- Front Panel LCD with Keypad
- Directly via an RS232 Interface
- Remotely via Ethernet (web interface)
- Infrared Remote (optional).

Every unit comes standard with the Front Panel LCD with Keypad, RS232, and Ethernet connection built-in. If desired, the Infrared option must be requested at the time of the order. The Infrared option requires the purchase of a separate remote control device (Infrared transmitter) as well as an Infrared receiver to be installed in the VEEMUX-A. No software is involved (see Infrared Control on page 25). With the RS232 option, there are no external devices to be purchased. NTI provides software commands as well as a test program to ensure the RS232 functions properly (see page 10 – RS232 Control).

Front Panel LCD with Keypad Control

The front panel LCD and keypad allow the user to monitor switch status and route any display to any video source on the switch. When the unit is powered up, each monitor is automatically connected to the video source of its equal number (i.e. monitor 1 to source 1, monitor 2 to source 2, monitor 3 to source 3, etc.). Along with the routing of the inputs (video sources) to the outputs (monitors) the keypad and LCD allow the users to configure the RS-232 control interface. The keypad buttons perform the following functions.

- ESC Escape back to the main display.
- 0 – 9 Used to enter numbers. (#)
- OUT The output user number can be entered
(2 digits or 1 digit and ENTER or IN)
 followed by the input
- IN Used following single digit output entries
- ENTER Used following single digit entries
- ▲ Display next 4 outputs and their inputs
- ▼ Display previous 4 outputs and their inputs
- MENU The RS-232 menu is displayed. This allows the baud rate to be set at 9600, 2400, 1200 or 300 baud and the unit address to be set to 1 - 15. See RS-232 control later in this chapter.
- * Activate Memory Function - 10 memory locations 0 – 9, 0 is the power on default.
 - to Save current connections (*) (OUT) (#) (ENTER)
 - to Recall connections from (*) (IN) (#) (ENTER)
 - To set all outputs to one input (*) + (#) + (ENTER)

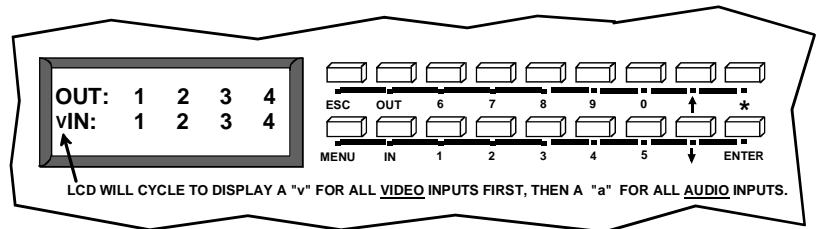

The following examples show various method of routing output 3 to input 5. Inputs and Outputs can be entered as a two digit number or a one digit number followed by IN or ENTER.

```
(OUT) 3 (IN) 5 (ENTER)
(OUT) 3 (ENTER) 5 (ENTER)
(OUT) 03 05
03 05
```

Volume Control

The volume level can be adjusted on each output port.

- To increment <▲> or decrement <▼> the volume, use the following command:
<OUT>, <▼>, Double digit output port number, <▲> increment or <▼> decrement, <ENTER>
Ex 1: <OUT> <▼> 03 <▲> <▲> <▲> <ENTER>
This will increment the volume by +3dB (1dB/ step).
Ex 2: <OUT> <▼> 14 <▼> <▼> <ENTER>
This will decrement the volume by -2dB.
- To Mute, use the command:
<OUT>, <▼>, Double digit output port number, the <0> key, <ENTER>
Ex: <OUT> <▼> 03 0 <ENTER>
This will mute output 3
- To Un-mute, use the instruction:
<OUT>, <▼>, Double digit output port number, the <1> key, <ENTER>
Ex: <OUT> <▼> 03 1 <ENTER>
This will un-mute output 3

Memory Functions

There are 100 memory locations(0-99) available to save connection configurations. Location 0 is the power-ON default).

- Saving Connections**
To save all current connections, use the following command:
<*>, <OUT>, Memory location, <ENTER>
Ex: <*> <OUT> 5 <ENTER>
- Restoring Connections**
To restore connections from memory, use the following command:
<*>, <IN>, Memory location, <ENTER>
Ex: <*> <IN> 5 <ENTER>

Note: *If the current switch configuration includes assigned Scan Mode dwell time values (pg. 9), to save the current configuration be sure to assign a memory location to it. Otherwise, when the VEEMUX-A is powered OFF, all dwell time values will be erased. Also, saving the configuration as memory location 0 will cause it to be the power-ON default configuration.*

Menu Button

The Menu button is used to configure the RS-232 port.

- The baud rate is selected from the "Baud Rate Menu" . To access this menu, use the command:
<MENU>, the <1> key

Next, press the keypad number corresponding with the desired baud rate:

<1> – 9600
<2> – 4800
<3> – 2400
<4> – 1200

Ex: <MENU> 1 1
This will select 9600 baud

- To set the switch address, use the following instruction:
<MENU>, the <2> key, Double digit address (from 01 to 15- the default address is 01)
Ex: <MENU> 2 03
This will set the address at 03

Scan Mode

Scan Mode causes output ports (audio and video) to automatically switch from one audio and video input port to the next consecutive audio and video input port after a specified period of time (referred to as the dwell time). Audio and video port switching will continue indefinitely and no ports will be skipped, whether there are audio or video sources connected to them or not. If desired, the VEEMUX-A can be configured to skip the scanning of specific ports using the RS232 Command Protocol (page 10) or Telnet (page 14).

Dwell time settings can be any value from 0 seconds (000) to 255 seconds. A setting of 000 seconds (the default setting) disables Scan Mode for that output port. If Scan Mode is disabled for a specific port number, then the video or audio to that output port number will only change as decided by the administrator.

Note: While Scan Mode is enabled, audio and video ports of the same number will switch together. Independent control of video and audio ports will be disabled. I.e., when video output 1 switches from input 1 to input 2, audio output 1 will also switch from input 1 to input 2.

To configure Scan Mode from the front panel LCD:

Press MENU, the following lines will be displayed:

- 1) Set Baud Rate
- 2) Set Unit Addr

Press MENU again, the following line will be displayed:

- 3) Set Scan Mode

Press 3 to select that menu item. The following request will be displayed:

Select Port

Select the output to be programmed using the numeric keys, then press ENTER. The display will show the current Dwell Time value for that output and ask for a new value.

Current Time: 16
New Time:

Using the numeric keys, enter a value between 0 and 255 and press ENTER. Leading zeros are allowed (000) but the number should not exceed 3 digits. The Scan Mode dwell setting value 0 will disable Scan Mode for that output port.

Scan Mode dwell time settings can also be configured through the RS232 Command Protocol (page 10), Telnet commands (page 14), or through the Web Interface (page 21).

NOTE: Scan Mode configuration settings can only be saved if they are assigned a memory location via the Keypad Control (page 8). Otherwise when the power is cycled to the VEEMUX-A, all Scan Mode settings will be erased.

TIP: If the Scan mode settings are stored as memory location 0, they will be loaded each time the VEEMUX-A is powered ON.

RS232 Control

Remote Connection

The RS232 Interface is designed to control the switch via serial (RS232) daisy chain connection from any host computer or other controller with an RS232 communications port. There is, however, a restriction that must be followed:

A program must be used that will send an entire command line all at once, not character by character. (The HyperTerminal program in WINDOWS cannot be used, as it sends each character one at a time.)

The pin outs for the DB-9 connector on the unit are as follows:

RS232 Connector (DB-9 FEMALE)

PIN	SIGNAL	FUNCTION
1	None	no connection
2	TXD	Transmit Data (RXD at host)
3	RXD	Receive Data (TXD at host)
4	DSR	Data Set Ready
5	GND	Signal Ground
6	DTR	Data Terminal Ready
7	CTS	Clear to Send
8	RTS	Request to Send
9	none	no connection

On the DB-9 female connector, pins 4 (DSR) and 6 (DTR) are shorted and pins 7 (CTS) and 8 (RTS) are shorted. Therefore, host handshaking is bypassed and TXD and RXD are the only active signals. A straight through DB-9 cable (not null modem) will work for most CPUs. To daisy chain multiple units, use NTI Matrix-Y-1 "Y" cables, except for the last unit connected. (see Fig 6). For a pinout of the Matrix-Y-1 cable, see page 31. For straight through cable pinouts applicable to various terminal types, see page 30.

Baud Rate

The unit powers up with a default baud rate of 9600 and a fixed data protocol of 8 data bits, no parity and 1 stop bit. The baud rate can be changed by pressing the MENU button on the front panel keypad. Then select 1 for SET BAUD RATE and select the desired baud rate of 9600, 2400, 1200 or 300. A data protocol of 8 data bits, no parity, and 1 stop bit is used for communications.

Unit Address

To allow multiple units to be controlled from a single CPU port, the RS232 control interface is designed to allow "daisy chaining" up to 15 units using the NTI Matrix-Y-1 "Y" cables (sold separately- pin out is on page 28). By setting the appropriate unit address with the keypad, each unit can be given a unique address (1-15). Then the unit will only respond to commands on the bus if its address is embedded in the command. To set the unit address select MENU on the front panel keypad. Then select 2 for SET UNIT ADDRESS and then type the address number (1-15) and (ENTER).

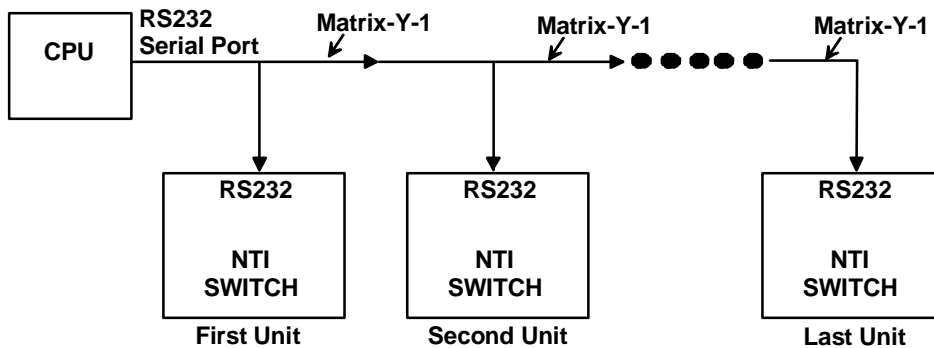

Figure 7- RS232 connection with Matrix-Y-1 cable

Command Protocol

CPU controller commands supported by the unit are defined below. All commands should be terminated with a <CR> (carriage return). When a command is sent, the entire string is echoed back to the CPU along with a response from the addressed unit as shown in the command definitions. All characters should be upper case, and all numbers below 10 should have a leading 0 (ex: 1 = 01).

NOTE: For units with one output or user port, use 01 for the output select.

Legend:

(All numbers must be two digits)

SW	:	Switch (01-15)	MM	:	Save Into Memory Bank (00-09)
BR	:	Baud Rate Code (12,24,48,96)	LL	:	Load From Memory Bank (00-09)
OP	:	Output Port (01-MAXOUTPUTS)	<CR>	:	Carriage Return (Hex 0xD)
IP	:	Input Port (01-MAXINPUTS)	ip	:	IP address

Command String	Good Response	Description
CS SW,IP,OP	*<CR>	VIDEO Connect One Output/User Port To Input/CPU Port
CA SW,IP	*<CR>	VIDEO Connect All Output/User Ports To Input/CPU Port
RO SW,OP	*<CR>IP<CR>	VIDEO Read Connection For Output/User Port
AS SW,IP,OP	*<CR>	AUDIO Connect One Output/User Port To Input/CPU Port
AA SW,IP	*<CR>	AUDIO Connect All Output/User Ports To Input/CPU Port
AO SW,OP	*<CR>IP<CR>	AUDIO Read Connection For Output/User Port
AM SW,OP,MU	*<CR>	Set Mute State For Output/User Port
AV SW,OP,VV	*<CR>	Set Volume Level For Output/User Port See chart on page 10 for values
AR SW,OP	*<CR>MU,VV<CR>	Read Mute, Volume For Output/User Port MU is 00 if the port is UNMUTED, MU is 01 if the port is MUTED. VV is a value between 00 to 99 (see chart page 12)
CC SW,MM	*<CR>MM<CR>	Save Matrix Connections Into Memory Bank xx Xx=00-09
RC SW,LL	*<CR>LL<CR>	Restore Matrix Connections From Memory Bank
CB 00,BR	None	Change baud rate of serial line, BR=12(00),24(00),48(00),96(00) Factory default is 9,600
RS SW	*<CR>	Internal Reset
RV SW,00	*<CR>string\0<CR>	Read NTI Version String
RU SW	*<CR>IP,OP<CR>	Read Unit Size
EA SW,ip	*<CR>	Set the IP address, ip is in xxx.xxx.xxx.xxx format, number of digits is minimum 1 and maximum 3 for each field Leading zeroes are accepted
EM SW,ip	*<CR>	Set the Subnet mask, ip is in xxx.xxx.xxx.xxx format, number of digits is minimum 1 and maximum 3 for each field. Leading zeroes are accepted
EG SW,ip	*<CR>	Set the default gateway, ip is in xxx.xxx.xxx.xxx format, number of digits is minimum 1 and maximum 3 for each field Leading zeroes are accepted
ET SW,timeout	*<CR>	Set the website timeout; timeout = numeric string of timeout in seconds. Values: 60, 300, 600, 900, 1800, 3600, 7200, 18000, 28800
RA SW *	<CR>ip<CR>	Read the IP address, ip is in xxx.xxx.xxx.xxx format, number of digits is minimum 1 and maximum 3 for each field Leading zeroes are accepted
RM SW *	<CR>ip<CR>	Read the Subnet mask, ip is in xxx.xxx.xxx.xxx format, number of digits is minimum 1 and maximum 3 for each field Leading zeroes are accepted
RG SW *	<CR>ip<CR>	Read the default gateway, ip is in xxx.xxx.xxx.xxx format, number of digits is minimum 1 and maximum 3 for each field Leading zeroes are accepted
RT SW *	<CR>timeout<CR>	Read the website timeout; timeout = numeric string of timeout in seconds. Values: 60, 300, 600, 900, 1800, 3600, 7200, 18000, 28800

If the first field is not a known command (as listed above) or SW field is different from the serial address programmed in the switch memory, the command will be ignored. If the SW field corresponds to the serial address, but the syntax is wrong after this field, the switch will answer with ?<CR>.

Set Volume Level For Output/User Port (for command string AV SW,OP,VV in chart on page 11)

This command will set the volume of the specified AUDIO output/user port from a scale of 00 to 99, which represents a logarithmic volume.

Serial Data (VV)	Audio Volume	Serial Data (VV)	Audio Volume
90-99	+10dB	40	-40dB
80	0dB	30	-50dB
70	-10dB	20	-60dB
60	-20dB	10	-70dB
50	-30dB	0	-80dB

Matrix Switcher's Control Program For Windows 9X, NT, 2000 AND XP

The Matrix Switcher's Control Program is an easy and powerful graphical program that controls NTI matrix switches through an RS232 interface. The Matrix Switcher's Control Program is included on the CD packaged with the VEEMUX-A. The Matrix Switcher's Control Program is downloaded by clicking on the link "Download Matrix Switcher's Control Program" found on the web page that appears when you insert the instruction manual CD into your CD ROM drive.

To install the Matrix Switcher's Control Program after downloading

1. Locate the **Setup.exe** in the directory the program was downloaded to and double-click on it
2. Follow the instructions on the screen

The Matrix Switcher's Control Program performs best on monitors set to a screen resolution of at least 800 X 600. Instruction for using the Matrix Switcher's Control Program is available by opening "MSCP Help" in the "NTI" program group once the program has been installed and is open on the screen.

To open "MSCP Help" from the Windows desktop

1. Click on **START**
2. Click on **PROGRAMS**
3. Click on **NTI**
4. Click on **MSCP Help**

SerTest- RS232 Interface Test Program

This software allows a user to test the functions of an NTI server switch, matrix switch or Multi-user/Multi-platform switch RS232 interface. The program SERTEST along with the Matrix Switcher's Control Program (above) is installed from the CD packaged with this switch. SERTEST generates a main menu with the 3 selections described below:

Main Options

- Matrix Operations - send commands to the matrix unit.
- Ethernet Operations - set Ethernet connection variables
- Setup Options - set COM port, baud rate, and unit address
- About SerTest - display the program version

Matrix Operations

Key	Selection	Description
1)	Connect Video Output/User to an Input/CPU	- connect an output to an input
2)	Connect All Video Outputs/Users to an Input/CPU	- connect all outputs to an input
3)	Connect Audio Output/User to an Input/CPU	- connect an output to an input (audio ports only)
4)	Connect All Audio Outputs/Users to an Input	- connect all outputs to an input (audio ports only)
5)	Change Mute Status for Audio Output/User	- mute or un-mute the Audio port output
6)	Change Volume for Audio Output/User	- change Audio port output volume
7)	Read Connection for Video Output/User	-read the connection of a specific video output
8)	Read Connection for Audio Output/User	-read the connection of a specific audio output
9)	Read Mute and Volume for Audio Output/User	- read the volume and the mute status of the specified output (audio ports only)
a)	Save I/O Connections into Unit Memory	-save the connections into switch memory bank
b)	Restore I/O Connections from Unit Memory	-restore the connections from switch memory bank
c)	Change All Units Baud Rate (9600/COM1:)	-change RS-232 Baud rate of all switches -the current baud rate and serial port are displayed in parentheses
d)	Reset Unit	- send a reset command to the switch - the current unit address is displayed in parentheses
e)	Reset All Units	- send an internal reset command to all switches
f)	Read Unit Size	- read the switch size (number of inputs and outputs)
g)	Read Unit Version/Revision String	-read a string containing the switch version, type, and size
h)	Save All Units I/O Connections into Units Memory	-save the connections into switch memory bank, command for all switches
i)	Restore All Units I/O Connections from Units Memory	-restore the connections from switch memory bank, command for all switches

Ethernet Operations

Key	Selection	Description
1)	Set Unit IP Address	- enter the desired IP address in xxx.xxx.xxx.xxx format - number of digits is minimum 1 and maximum 3 for each field. Leading zeroes are accepted
2)	Set Unit Subnet Mask	- enter the desired IP address in xxx.xxx.xxx.xxx format - number of digits is minimum 1 and maximum 3 for each field. Leading zeroes are accepted
3)	Set Unit Default Gateway	- enter the desired default gateway - number of digits is minimum 1 and maximum 3 for each field. Leading zeroes are accepted
4)	Set Unit Website Timeout	- set the website timeout; timeout = numeric string of timeout in seconds - Values: 60, 300, 600, 900, 1800, 3600, 7200, 18000, 28800 0 = no timeout
5)	Read Unit IP Address	- read the unit IP address in xxx.xxx.xxx.xxx format
6)	Read Unit Subnet Mask	- read the unit subnet mask in xxx.xxx.xxx.xxx format
7)	Read Unit Default Gateway	- read the unit default gateway in xxx.xxx.xxx.xxx format
8)	Read Unit Website Timeout	- read the current website timeout period in seconds - Values: 60, 300, 600, 900, 1800, 3600, 7200, 18000, 28800 0 = no timeout

Setup Options

Key	Selection	Description
1)	select Com port current: (COM1:)	- select PC serial port - the current PC serial port is displayed in parentheses
2)	select Baud rate current: (9600)	- select PC serial port baud rate - the current baud rate is displayed in parentheses
3)	set unit Address current: (1)	- select the unit address - the current address is displayed in parentheses

For any selection that requires user input, the user is prompted. When commands are sent to the matrix unit, the command string and matrix unit responses are echoed to the screen. All commands generated by the program are formatted according to the information provided in sections above. If any transmission problems are detected, an error message is displayed.

Press <Esc> or <Enter> to back out to the main menu and press again to exit.

Telnet Interface

The Telnet Interface enables the user to control the switch using telnet client through an Ethernet connection. The telnet server listens on **port 2000**. To access the telnet interface, using the current IP address type the following in a command shell:

telnet 192.168.1.1 2000

The VEEMUX-A will prompt the user for a password. The user must enter the password followed by <Enter>.

The factory default password is "admin".

With a proper password sent the VEEMUX-A will respond with:

***Password Successful
Connection Established***

The following commands are now available:

Command	Reply	Description
H(elp) or h(elp)	Displays the list of commands	Help
CS nn,mm	*<CR>	Connect One Output nn To Input mm
CA nn	*<CR>	Connect All Outputs To Input nn
RO nn	*<CR>mm<CR>	Read Connection For Output. Returns the number of the input mm connected to output nn
CC nn	*<CR>nn<CR>	Save Matrix Connections Into Memory Bank nn nn should be between 00 and 99
RC nn	*<CR>nn<CR>	Restore Matrix Connections From Memory Bank nn nn should be between 00 and 99
CB nn	*<CR>	Change baud rate of serial line, nn=12(00),24(00),48(00),96(00) Factory default is 9600.
RV 00	*<CR>string<CR>	Read NTI Version String
RU	*<CR>nn,mm<CR>	Read Unit Size Returns the number of inputs mm and the number of outputs mm
RS	*<CR>	Reset Unit
AS nn,mm	*<CR>	Connect audio input mm to output mm
AA nn	*<CR>	Connect audio input nn to all outputs
AO nn	*<CR>nn<CR>	Read audio connection for output nn
AM nn,mu	*<CR>	Set mute state for output nn mu(ute State) = (00=UNMUTE, 01=MUTE)
AV nn,vv	*<CR>	Set volume level for output nn vv is a value between 00 to 99 (see chart page 12)
AR nn	*<CR>MU,VV<CR>	Read mute, volume for output nn MU is 00 if the port is UNMUTED, MU is 01 if the port is MUTED. VV is a value between 00 to 99 (see chart page 12)
Ss nn,dwt	*<CR>	Set value of Scan Mode dwell time (see page 9) for specific Output (nn) dwt = 000-255 (seconds) 000= disable Scan Mode
Gs nn	*<CR> dwt<CR>	Read set Scan Mode dwell time value (dwt) for specific Output (nn) in seconds (see also "Scan Mode" on page 9)
Sa nn,mm	*<CR>	Set scan list of individual output nn to all inputs mm

Sc nn	*<CR>	Clear scan list of individual output nn
S+ nn,mm	*<CR>	Add input mm to Scan List of output nn
S- nn,mm	*<CR>	Remove input mm from Scan List of output nn
Sx nn	*<CR>oooxoxxxooooxxx<CR>	Display the Scan List of output nn (o=skip x=don't skip)
CP	User is prompted to introduce the password twice	Change password- five (5) characters minimum
<Ctrl>-<X> (see note 4 below)	Good Bye. Connection to host lost.	Quit telnet session

Notes:

1. The commands must be typed exactly as shown in the chart. The commands are case sensitive.
2. If a mistake is made, the user must backspace to the beginning and completely retype the command.
3. If a command is sent that the VEEMUX-A does not recognize or exceeds the configuration of the switch, the reply "?" may be received. Check the command syntax and try again.
4. To quit the telnet session, press the keyboard keys <Ctrl><X>.

Web Interface

A user may control the connections of the VEEMUX-A using a Web Interface via any web browser (see page 1 for web supported browsers). With the VEEMUX-A connected to a LAN through an Ethernet cable, a user can access the web interface controls inside the VEEMUX-A.

FYI: To quickly locate a VEEMUX-A on the LAN and edit the IP address settings, use the Device Discovery Tool (page 24).

To access the web interface, type the current IP address into the address bar of the web browser.

Address

To open a SSL-encrypted connection, type:

Address

You will be prompted to accept a certificate. Accept the NTI certificate.

A "Welcome Page" will appear.

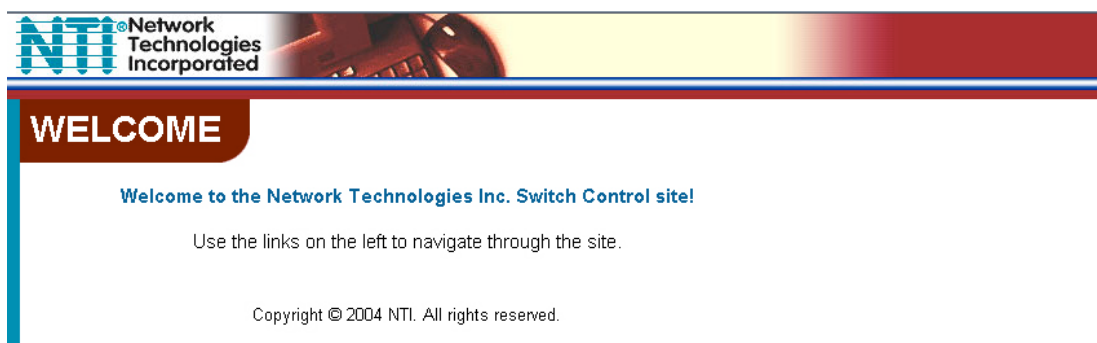

Figure 8- Web interface Welcome page

Enter the Password

Click on a link to the left to be prompted for a username and password. To change the password, see page 23.

User Name = Administrator (upper case letter for "A" only)

Password = admin (lower case letters only)

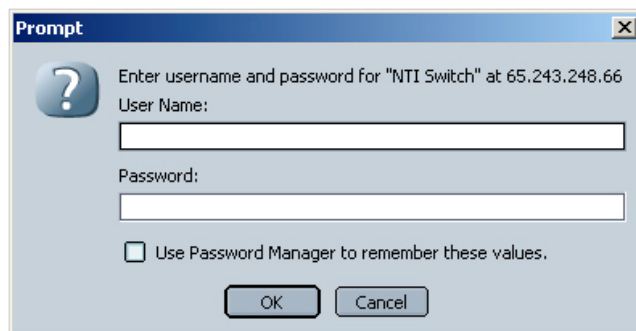

Note: The browser must be configured to accept cookies in order for the user to successfully make use of the web interface.

Figure 9- Web interface Login Prompt

As described on the following pages, each link will enable different areas of control for the VEEMUX-A.

Video Switch Page

The Video Switch page (right) displays the active connections (shown in orange) and enables the user to control the audio and video connections of the VEEMUX-A, or just the video. (To change audio connections separately, see page 18.) Up to 100 different connection configurations can be saved and later recalled by any connection method.

Note: Configuration 0 will be automatically loaded when the VEEMUX-A is powered up.

To change a connection, click on the radio button (square image with circle in the center) that intersects the input and output columns. A black dot will be placed in the circle to indicate the selection. Then press the **Submit** button. The display will be reloaded with the selections changed to orange to indicate they are now active. Multiple connections can be changed simultaneously.

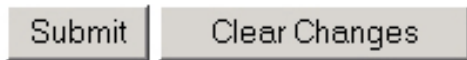

To quickly clear the selected radio buttons press the **Clear Changes** button. This will only work if the **Submit** button has not already been pressed with the selections made.

To quickly connect all outputs to a single input, choose the desired input from the "Set all Outputs to Input" drop-down list and press the **Submit** button.

Note: Click an Input to Set All Outputs to that Input.

Copyright © 2004 NTI. All rights reserved.

Figure 10- Web interface Video Switch page

Note: If radio buttons are selected in addition to using the "Set all Outputs to Input" option, the selections made by the "Set all Outputs to Input" will take precedence when the Submit button is pressed. Selections that conflict with it will be ignored.

To save a configuraton, from the **Stored Configurations** user interface, use the drop-down list to select the desired slot (numbers 0-99) to save the active configuration into and press the **Save** button.

Note: This will save the currently active configuration on the VEEMUX-A. If changes have been made in the web interface without first pressing the Submit button, those changes will not yet be part of the active configuration.

Note: If changes to the active configuration have been made by another user prior to saving the current connection selections, the changes made by the other user will be saved as the configuration.

The webpage configuration that loads after a **Save** is the configuration that was actually saved.

To load a saved configuration, from the **Stored Configurations** user interface, use the drop-down list to select the desired configuration. Then press the **Load** button. The VEEMUX-A will make the connections and the screen will refresh to show the connections associated with that configuration selection.

To change video only, or audio and video, either leave the "Video + Audio" block empty (to effect only video) or use the mouse to place a check in the box shown to the right (to effect audio and video connections). With a change of status, press **Save** to have it take effect.



To change audio connections only, the Audio Switch page (below) enables the user to control the audio connections independently of the video connections.

Audio Switch Page

Using the same methods of control described for the Video Switch page (page 17) the user can separately control the audio connections made between ports on the VEEMUX-A. Additionally, the user can mute any output port or raise and lower the volume at each output port.

AUDIO SWITCH

CHANGE AUDIO CONNECTIONS

Stored Configurations	Sort Ports by:	Legend
Load/Save Video and Audio Connections: <input type="button" value="Load"/> <input type="button" value="Save"/> <input type="button" value="0"/>	<input type="button" value="Port Number"/> <input type="button" value="Port Name"/>	<input checked="" type="checkbox"/> Active Connection <input type="checkbox"/> Connection to be applied

Inputs	Outputs			
	1	2	Output01	Output02
(1)	<input type="checkbox"/>	<input type="checkbox"/>	<input type="checkbox"/>	<input type="checkbox"/>
(2)	<input type="checkbox"/>	<input type="checkbox"/>	<input type="checkbox"/>	<input type="checkbox"/>
(3)	<input type="checkbox"/>	<input type="checkbox"/>	<input type="checkbox"/>	<input type="checkbox"/>
(4)	<input type="checkbox"/>	<input type="checkbox"/>	<input type="checkbox"/>	<input type="checkbox"/>
(5)	<input type="checkbox"/>	<input type="checkbox"/>	<input type="checkbox"/>	<input type="checkbox"/>
(6)	<input type="checkbox"/>	<input type="checkbox"/>	<input type="checkbox"/>	<input type="checkbox"/>
(7)	<input type="checkbox"/>	<input type="checkbox"/>	<input type="checkbox"/>	<input type="checkbox"/>
(8)	<input type="checkbox"/>	<input type="checkbox"/>	<input type="checkbox"/>	<input type="checkbox"/>

Settings	Volume	Mute	Output03	Output04
Volume	<input type="text" value="11"/>	<input type="checkbox"/>	<input type="text" value="22"/>	<input type="text" value="33"/>
Mute	<input checked="" type="checkbox"/>	<input type="checkbox"/>	<input checked="" type="checkbox"/>	<input type="checkbox"/>

Note: Click an Input to Set All Outputs to that Input.

Copyright © 2004 NTI. All rights reserved.

Figure 11- Web interface Audio Switch page

Settings				
Volume	<input type="text" value="80"/>	<input type="text" value="80"/>	<input type="text" value="80"/>	<input type="text" value="80"/>
Mute	<input type="checkbox"/>	<input type="checkbox"/>	<input type="checkbox"/>	<input type="checkbox"/>

Using the chart on page 19, apply the value for the desired level of volume for each output port.

Serial Data (VV)	Audio Volume	Serial Data (VV)	Audio Volume
90-99	+10dB	40	-40dB
80	0dB	30	-50dB
70	-10dB	20	-60dB
60	-20dB	10	-70dB
50	-30dB	0	-80dB

Place a checkmark in the **Mute** box for any output port where no volume is desired.

Setup Pages

These settings enable the user to configure the VEEMUX-A web interface connection. This change will take a few seconds and automatically redirect the user to the IP address specified.

Note: Since the webserver will be restarting all active connections will be logged out.

The Website Timeout option controls how long an inactive web connection will stay logged in. Any change to the Website Timeout configuration takes effect immediately.

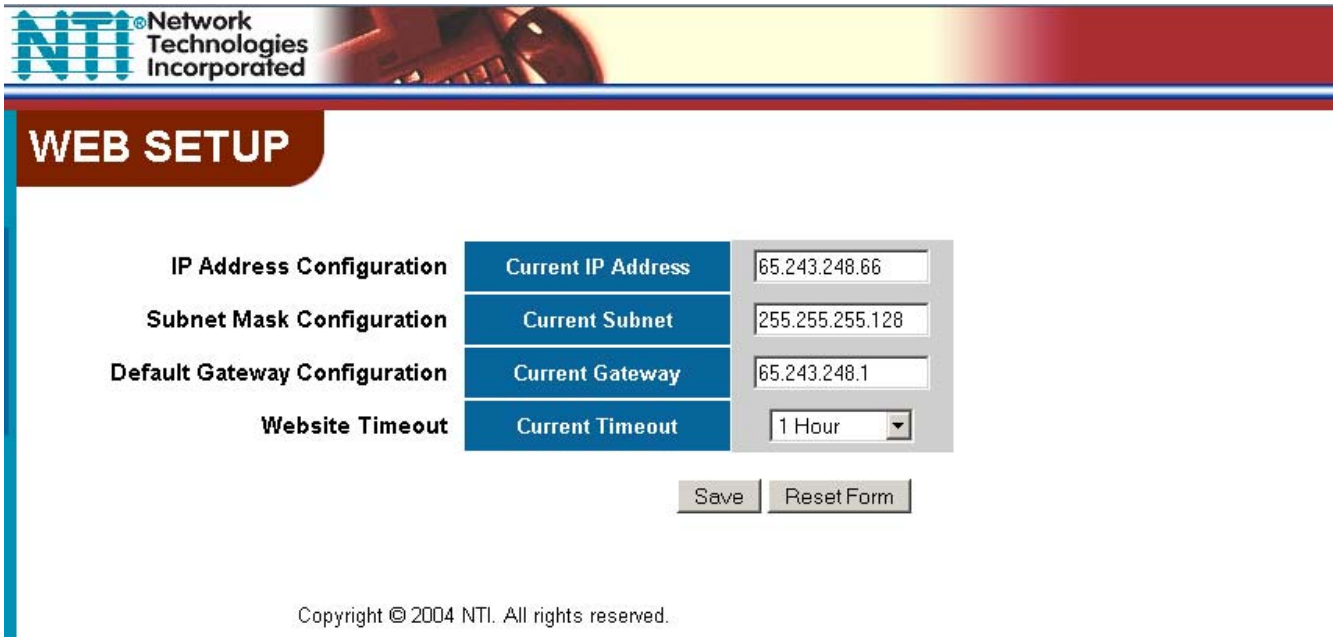

NTI Network Technologies Incorporated

WEB SETUP

IP Address Configuration	Current IP Address	65.243.248.66
Subnet Mask Configuration	Current Subnet	255.255.255.128
Default Gateway Configuration	Current Gateway	65.243.248.1
Website Timeout	Current Timeout	1 Hour

Save Reset Form

Copyright © 2004 NTI. All rights reserved.

Figure 12- Web interface Setup page



Figure 13- Web interface Serial Setup page

Changes to the Serial Address and Serial Speed (Fig. 13) do not require a reset and will take effect immediately.

Input Names



Figure 14- Web interface Input Names page

The Input Names pages (Video and Audio) enable the Administrator to change the names of the video and audio input ports displayed on the Switch page. To change an input port name, enter the name of the port for the desired input port number, and press "Save".

Output Names

From the Administration menu, the Video or Audio Output Names page can be displayed. (Selected separately from the menu.) These pages enable the Administrator to change the names of the output ports displayed on the Switch page. To change an Output Name, enter the name of the port for the desired output port number, and press "Save".

Note: Only the changes to the port directly to the left of the Save button will be saved. All other changes to ports without pressing the port's respective Save button will be discarded. All port names must be no more than 16 characters in length and only alphanumeric characters may be used.

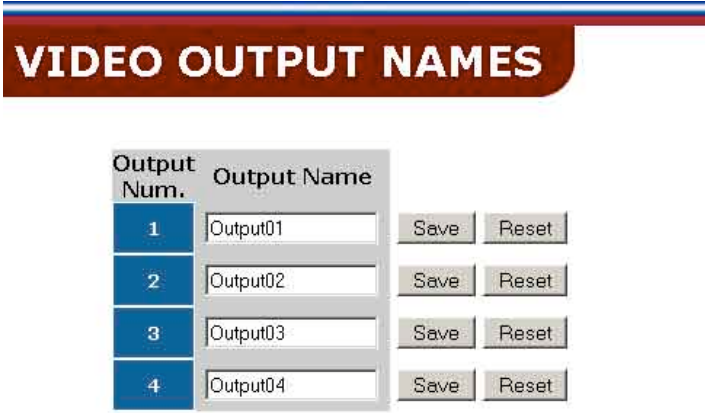

Copyright © 2004 NTI. All rights reserved.

Figure 15- Web interface Output Names page

Scan Mode

From the Administration menu the "Outputs Scan Mode Settings" page can be displayed. This page shows a table with all outputs, the status of Scan Mode for each, and edit boxes for dwell time settings (in seconds) for each output. Each setting can be edited with a value from 0-255. A setting of 0 seconds will disable Scan Mode for that output.

If Scan Mode is disabled for a specific output, then the video to that output will only change as decided by the administrator.

To change Scan Mode from "Off" to "On", simply enter a dwell time value in a box under "Dwell Time" for any Output and press "Apply". Only those boxes with a value of 0 will indicate Scan Mode is "Off" for the respective output.

Scan Mode dwell time settings can also be configured through the LCD menu (page 7), Telnet commands (page 14), or through the RS232 Command Protocol (page 10).

Press "Clear All" to set all output scan mode settings to "Off".

For more on Scan Mode, see page 9.

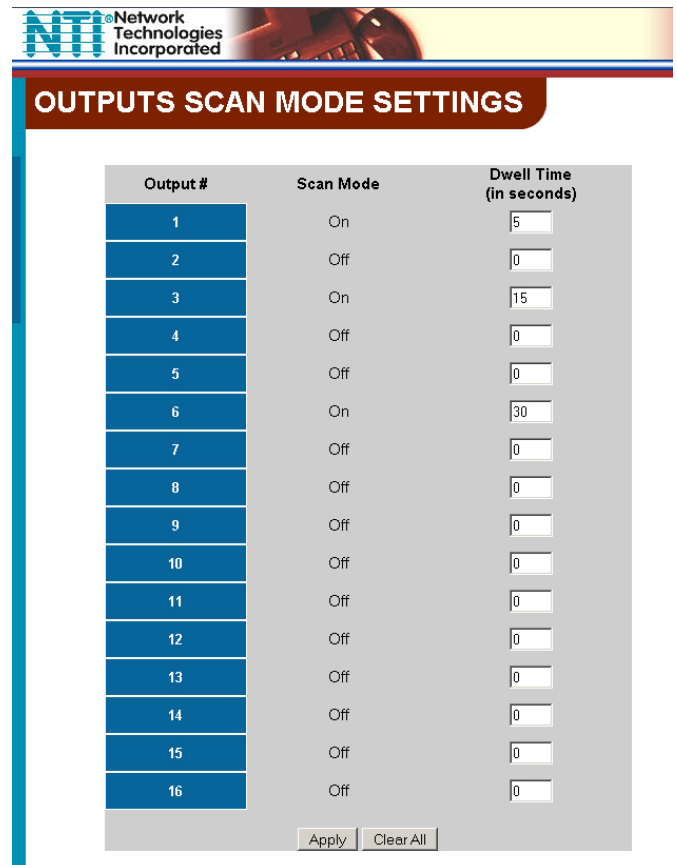

Figure 16- Web interface Scan Mode page

Update Firmware

UPDATE FIRMWARE

Caution! You have asked to update the firmware.
Failure to update firmware properly can permanently damage the product.

[Please read these instructions](#) before proceeding.

Select the firmware update file

Firmware Revision: 1.6
Revision Date: 2006/03/13 18:02:51

Figure 17- Web interface Update Firmware page

The Update Firmware page (found in the main menu under "ADMINISTRATION") shows the current version of the firmware and enables the Administrator to update the firmware of the VEEMUX-A.

WARNING: Failure to carefully follow these directions can permanently damage the VEEMUX-A. Please read these directions in full before continuing. Do not, under any circumstances, reset or power-down the VEEMUX-A while the firmware is being updated. Do not attempt to update the firmware if a power-failure is likely.

Note: The Firmware can only be updated from the non-secure (http) website. If you attempt to access this page from the secure (https) website, you will be automatically redirected to the non-secure site.

To update the firmware:

1. Contact NTI for the latest firmware file and copy it to your computer.
2. On the Update Firmware page, browse to the firmware file.
3. Press *Update Firmware*.
4. Wait for the following message to appear (may take several minutes):

*Upload Succeeded
Flash of new image completed.
The system will automatically restart.*

5. The VEEMUX-A will restart itself in 10 seconds, logging out all connections. After approximately 40 seconds, the VEEMUX-A will be ready to resume operation.

If a message appears stating that the Upload has failed, or that a non-fatal error has occurred:

1. Ensure that the file being uploaded is the NTI firmware file.
2. Repeat the process from step 2 above.

Note: The following message does not indicate that damage to the product has occurred.

If a message appears stating that there has been a fatal error:

1. **DO NOT RESET OR POWER-DOWN THE VEEMUX-A.**
2. Repeat the update process from the first step 2 above.
3. If you get another Fatal Error message, call NTI tech-support at 1-800-742-8324 or 330-562-7070.

FYI: The VEEMUX-A should continue to run normally unless it is reset. However, damage may have occurred to the web server firmware that will prevent the product from starting up correctly.

Change Password Page

Use this page to change the password for accessing the web interface. (This password is also used for the telnet interface.) Be sure to make note of the new password exactly as it is case sensitive. The password must be between 5 and 16 characters in length and can be alphabetical or numeric.

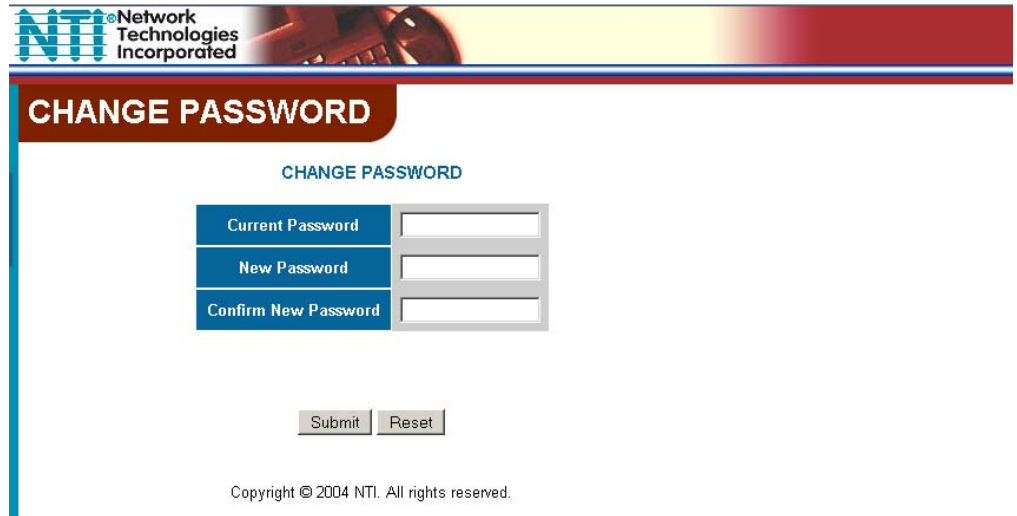

Figure 18- Web interface Password page

Help Page

This page explains the purpose of each of the other pages in the VEEMUX-A web interface.

Update Web Server

Click on this selection to globally update the Web Server to any settings that have been changed though Telnet, the RS232 interface, or via the front panel of the VEEMUX-A. All users presently connected will be disconnected and must log back in after using this command.



Figure 19- Updating the Web Server

Logout Page

This page will enable the user to end the session and close the web interface connection. Click on the "Press Here to Continue Logout" button to exit the VEEMUX-A web interface.

Note: The connection will timeout automatically after a preset period of inactivity, configurable on the Web Setup page.

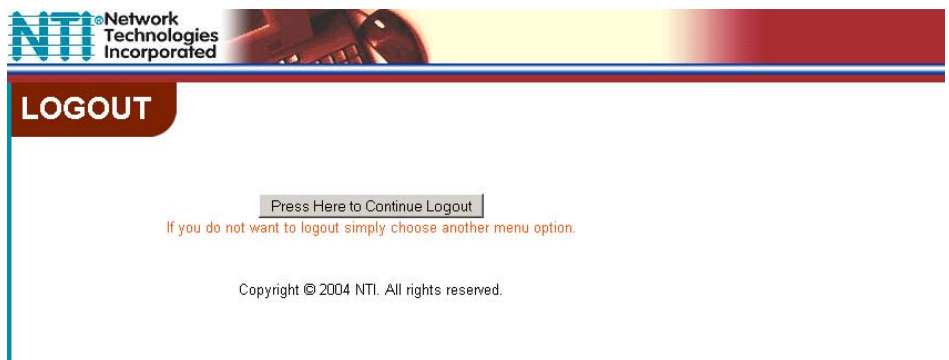

Figure 20- Web interface Logout page

DEVICE DISCOVERY TOOL

In order to easily locate the VEEMUX-A on a network, and change the IP settings, the NTI Device Discovery Tool may be used. A link to the Discovery Tool is provided on the web page that appears when you insert the instruction manual CD provided into your CD ROM drive. Click on the link or browse the CD and click on the file *discover.html*. This will open your browser and display the Device Discovery Tool page.

Note: The Discovery Tool requires the Java Runtime Environment to operate. A link to the web page from which it can be downloaded and installed is provided on the CD.

Note: The computer using the Discovery Tool and the VEEMUX-A must be connected to the same physical network in order for the Device Discovery Tool to work.

Network Technologies Inc Device Discovery Tool

- **START**
 - When you load this page, the NTI Device Discovery Applet should load. Accept the Certificate to allow this applet access to your network. Press the button entitled **Detect NTI Devices** to start the discovery process. After a short time, the tool will display all NTI devices on your network, along with their network settings.

Note: Do not close this page while the NTI Discovery Tool is running. Close the NTI Device Discovery Application first, **then** this webpage.
- **How To Use the Discovery Tool**
 - **To Change A Device's Settings**, within the row of the device whose setting you wish to change, type in a new setting and press the **Enter** key or the **Submit** button on that row. You can also press the **Submit All** button to submit all changes at once.
 - **To Refresh the list of devices**, press the **Refresh** button.
 - **To Blink the LEDs of the unit**, press the **Blink LED** button (This feature not supported on all products). The **Blink LED** button will change to a **Blinking...** button. The LEDs of the unit will blink until the **Blinking...** button is pressed, or the NTI Device Discovery Application is closed. The LEDs will automatically cease blinking after 2 hours.
 - **To Stop the LEDs of the unit blinking**, press the **Blinking...** button. The **Blinking...** button will change to a **Blink LED** button.

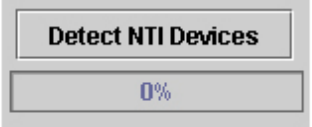

Figure 21- Device Discovery Tool page

Use the Device Discovery Tool to display all NTI VEEMUXs on your network, along with their network settings. Follow the instructions on the Device Discovery Tool page to use the tool and to change the device settings if so desired.

Device	MAC Address	IP Address	Mask	Gateway		
VEEMUX	00:40:9D:24:07:70	65.243.248.18	255.255.255.128	65.243.248.1	Submit	Blink LED
		Submit All	Refresh	Close		

INFRARED CONTROL

(Optional)

The IRT-64X32 (or IRT) is an infrared remote transmitter that enables the user to control up to four (4) NTI VEEMUX-A Video Matrix switches via an infrared receiver from up to 50 feet away (with an unobstructed view). The IRT is battery-powered and always ready to use. The IRT will have a blank display unless an action is being selected by the user. The IRT enables the user to make connections between any input (video source) and any output (display device) on up to four (4) separate switches.

Note: Multiple switches that are located close to each other and are to be individually controlled must be pre-configured (by NTI) to be identified by the IRT as switches #1, #2, #3, or #4. Please ask your salesperson to have switches configured accordingly at time of order. Unless otherwise specified, by default, all IRT-enabled switches will be configured as switch #1.

Materials included:

- IRT-64X32 Infrared Remote Transmitter for video matrix switches
- (2) AA Cell Batteries- installed

Features And Functions

Keypad

- Buttons Numbered 0-9 – Used for port selection
- OUT – Pressed to validate and transmit the Output selection
- IN – Pressed to validate and transmit the Input selection
- SYS – Pressed to choose the switch to be controlled or to configure the maximum number of inputs/outputs

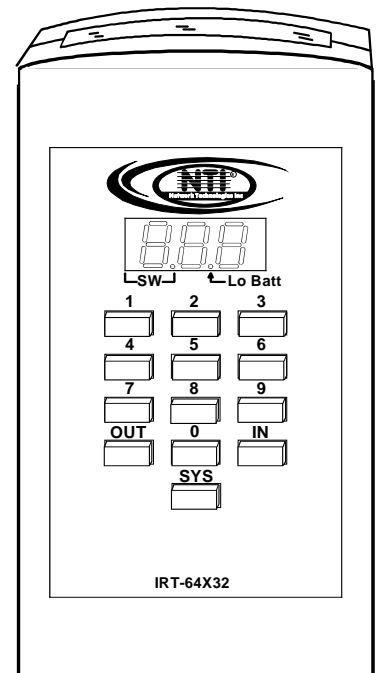

LCD Display

- The first digit of the LCD will display the number of the switch to be controlled followed by the decimal point. This way the user will always know which switch will be effected by the IRT.
- The last two digits in the LCD represent 1) the desired input or output port to be connected or 2) the desired switch to be controlled when changing switches.
- The "Lo Batt" decimal point will illuminate when the user should change the batteries.
- The LCD will automatically power-down after 30 seconds of non-use and power-up with the press of any button.

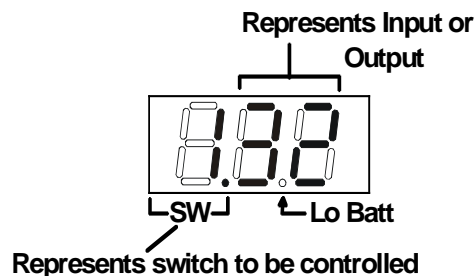

How To Use The IRT

The IRT-64X32 enables the user to control the connections of up to 32 input ports and 16 output ports on up to four (4) separate NTI video matrix switches. When any key is pressed, the IRT will power ON. A number key should always be pressed first unless a change to the configuration is desired (see "Set Configuration" on page 28). When a number key is pressed the LCD will display that number blinking. What to press next depends on what action is desired;

- change the switch to be controlled
- change the output port
- change the input port

Note: The user must always change or confirm the output port first and the input port second

If the "SYS", "IN" or "OUT" key is pressed first, the LCD will display the current switch followed by the decimal point and an error signal "EE". The error signal will display because there is no number to be displayed. A number key must always be pressed before a "SYS", "IN" or "OUT" key is pressed.

Exception: The "SYS" key is pressed first when setting the configuration. (See page 28)



Power ON with SYS, IN or OUT keys

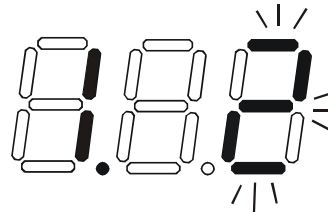

Power ON with "2" key

Change the Switch

Press the number of the switch to be controlled. The number selected will be blinking in the last digit.

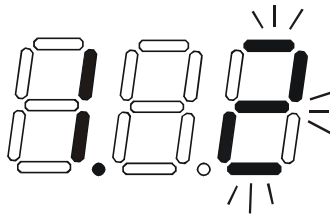

FYI: If the user realizes that an invalid number has been introduced before pressing either the "SYS", "IN", or "OUT" buttons, a correction can be made by pressing the correct number. If the correct number is a single digit, it must be preceded by a "0" to make the correction.

Press the "SYS" key. The blinking number will become blank and the switch number will update.



Note: If the number entered is larger than 4, when the "SYS" key is pressed the LCD will display the current switch and the error signal "EE".

Change Output Port

Press the desired port number. If there is no change in the desired output port, the output port must still be selected. As the digits are selected, the last number entered will blink. The LCD will also display the current switch number followed by the decimal point.

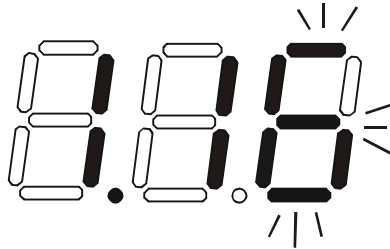

With the desired port number selected, point the IRT at the switch/receiver and press the "OUT" button to transmit the selection and make the change. The blinking number in the LCD will stop blinking. An LED on the receiver will illuminate.

FYI: If the switch did not receive the data the LED will not illuminate. The user can re-send the same data by pressing the "OUT" button again. The LED at the receiver will illuminate to indicate a completed transmission from the IRT..

Note: If the number introduced is larger than the maximum number of outputs the IRT is configured for, then once the "OUT" key is pressed the LCD will display the current switch and the error signal "EE".



Change Input Port

Press the desired port number. As the digits are selected, the last number entered will blink. The LCD will also display the current switch number followed by the decimal point.



With the desired port number selected, point the IRT at the switch/receiver and press the "IN" button to transmit the selection and make the change. The blinking number in the LCD will stop blinking. The LED at the receiver will go OFF.

FYI: If the switch did not receive the data the LED will not go OFF. The user can re-send the same data by pressing the "IN" button again. The illuminated LED on the receiver will go OFF when the received data is complete.

Note: If the number introduced is larger than the maximum number of inputs that the IRT is configured to control, then once the "IN" key is pressed the LCD will display the current switch and the error signal "EE".



Set Configuration

The IRT-64x32 factory default setting is 32 inputs and 16 outputs. When the batteries are changed the setting will return to the default value. At the default setting the IRT has the ability control any matrix switch with up to 32 inputs and 16 outputs without changing the configuration. However, when controlling smaller switches without changing the configuration it is up to the user to press valid number(s). To avoid confusion, it is recommended to configure the IRT to communicate with the largest switch to be controlled.

To change the maximum number of inputs or outputs:

1. From power-down state (blank LCD) press and hold the "SYS" button for at least 3 seconds. The LCD will first display an error message but after 3 seconds the letter "c" will display:

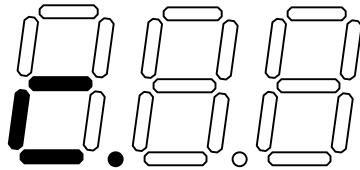

2. Enter the number of inputs or outputs. As the digits are entered, they will be displayed and the last one entered will blink.

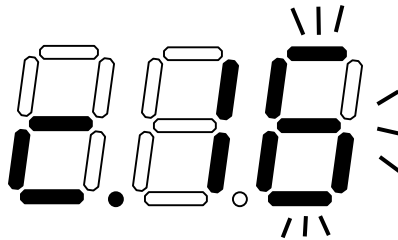

Note: Only the inputs OR the outputs may be configured each time the configuration function is used. To perform another configuration operation the user must start again at "Set Configuration" step 1.

3. Accept the choice by pressing the "IN" button for setting inputs, or the "OUT" button for setting the outputs. The LCD will not blink anymore and will display "i" (for inputs) or "o" (for outputs) and the number.



Notes:

- The maximum number of inputs and outputs that can be entered is 32 and 16 respectively. If the user introduces a number larger, the display will show an error signal ("c.EE") and the maximum number will remain at the last valid value configured.
- If more than one switch is being controlled, the IRT should be configured for the largest switch. It is up to the user to introduce valid numbers to the smaller switches when making selections.

Battery Replacement

The IRT has a low-battery indicator to let the user know when it is time to change the batteries. The right-hand decimal point in the LCD display will illuminate (see illustration below). This will stay illuminated while the IRT is in use until the batteries are changed or the battery charge is too low for the IRT to operate.

To Change The Batteries:

1. Remove slide cover on rear of unit.
2. Remove old batteries carefully.
3. Insert (2) new "AA" cell batteries.
4. Replace slide cover on unit.
5. Reset the configuration if a range other than the default setting is desired.

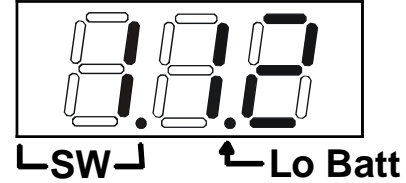

Specifications

- 50 feet maximum operating range between the transmitter and the front of the NTI switch / infrared receiver.

Note: Line of sight between IRT and receiver must be unobstructed.

- Select up to 16 outputs
- Select up to 32 inputs
- Operates with (2) "AA" batteries.
- "Lo Batt" decimal point in LCD will illuminate to indicate a low battery when the battery voltage drops to approximately 2.25 volts.

Troubleshooting the IRT

PROBLEM	SOLUTION
IRT is not selecting output	<ul style="list-style-type: none"> • Check battery • Make sure you are using the correct IRT for the switch. (Check model number on the front of the IRT.) • The IRT may be configured to control the wrong switch or the wrong size of switch (see "Set Configuration" on page 28)
IRT is not selecting input	<ul style="list-style-type: none"> • Check battery • The IRT may be configured to control the wrong switch or the wrong size of switch (see "Set Configuration" on page 28)

RS232 CONNECTION CABLES

Pinout of RS232 port on VEEMUX-A

The VEEMUX-A RS232 serial port is a DB-9F (female) connector configured as a DCE (data communication equipment) port. The RS232 port interface signals are listed below, including equivalent CCITT V.24 identification, and signal direction:

DB-9F pin #	Common name	EIA name	CCITT name	Function	Direction
1	N/a	N/a	N/a	No connection	--
2	TxD	BA	103	Transmit Data	Output
3	RxD	BB	104	Receive Data	Input
4	DSR	CC	107	Data Set Ready	Input
5	SG	AB	102	Signal Ground	-
6	DTR	CD	108.2	Data Terminal Ready	Output
7	CTS	CB	106	Clear To Send	Input
8	RTS	CA	105	Request To Send	Output
9	N/a	N/a	N/a	No connection	--

Pinouts for typical DCE to DTE cable for CPU connection

VEEMUX (DCE) to 9 PIN DTE (PS2 or SUN)

VEEMUX 9 pin		Signal Direction	PS/2 or SUN CPU 9 pin	
Function	Pin #		Pin #	Function
RxD	3	←	3	TxD
TxD	2	→	2	RxD
CTS	7	←	7	RTS
RTS	8	→	8	CTS
DSR	4	←	4	DTR
DTR	6	→	6	DSR
SG	5	—	5	SG

VEEMUX (DCE) to 25 PIN DTE (MAC)

VEEMUX 9 pin		Signal Direction	MAC CPU 25 pin	
Function	Pin #		Pin #	Function
RxD	3	←	2	TxD
TxD	2	→	3	RxD
CTS	7	←	4	RTS
RTS	8	→	5	CTS
DSR	4	←	20	DTR
DTR	6	→	6	DSR
SG	5	—	7	SG

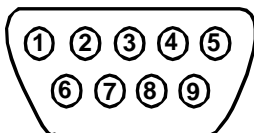
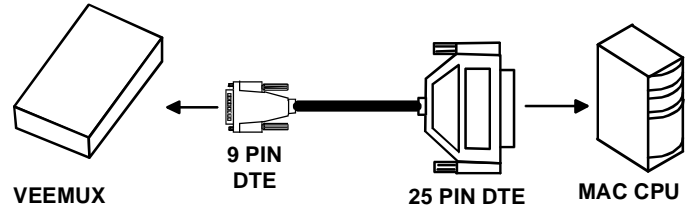
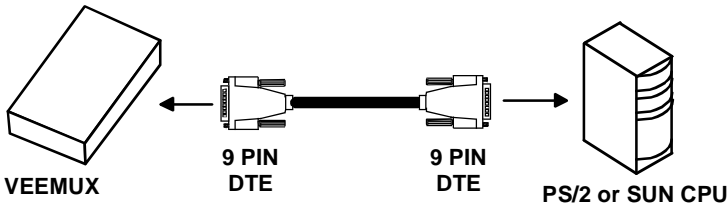

Mating Face of a 9D Male

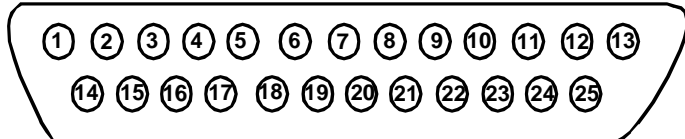

Mating Face of DB25 Male

Pinout for Matrix Y-1 Cable

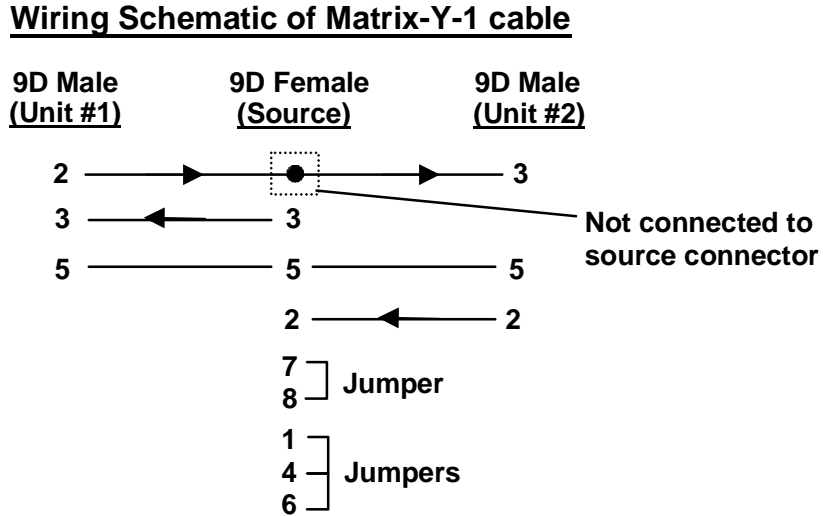

Arrows indicate signal direction.

Figure 22- Pinout for Matrix Y-1 Cable

SAFETY STATEMENTS

Grounding

These products have protective earth ground terminals and are built with full attention to consumer safety. There must be an un-interruptible safety earth ground between the main power source and the product's power cord or supplied power cord set. If ever the possibility exists for the grounding protection to have been reduced in any way, disconnect the power supply until the grounding connection has been fully restored.

Servicing

NTI products are not intended to be serviced in the field and contain no user-serviceable parts. In the event repair is needed, all servicing must be performed by factory trained and authorized service personnel. Only those items specifically identified in this manual (if any) may be adjusted by the user of this product and adjusted only as instructed in this manual.

RACK MOUNTING INSTRUCTIONS

This NTI switch was designed to be directly mounted to a rack. It includes a mounting flange to make attachment easy. Install 4 captive nuts to the rack in locations that line up with the holes (or slots) in the mounting flange on the NTI switch. Then secure the NTI switch to the rack using four 3/16" diameter screws (not provided). Each screw should be of sufficient length to go completely through the NTI mounting flange, rack frame and fully engage all threads in the captive nut. Be sure to tighten all mounting screws securely.

Do not block power supply vents in the NTI switch chassis (if provided) . Be sure to enable adequate airflow in front of and behind the NTI switch.

Attach all cables securely to the switch and where necessary supply adequate means of strain relief for cables.

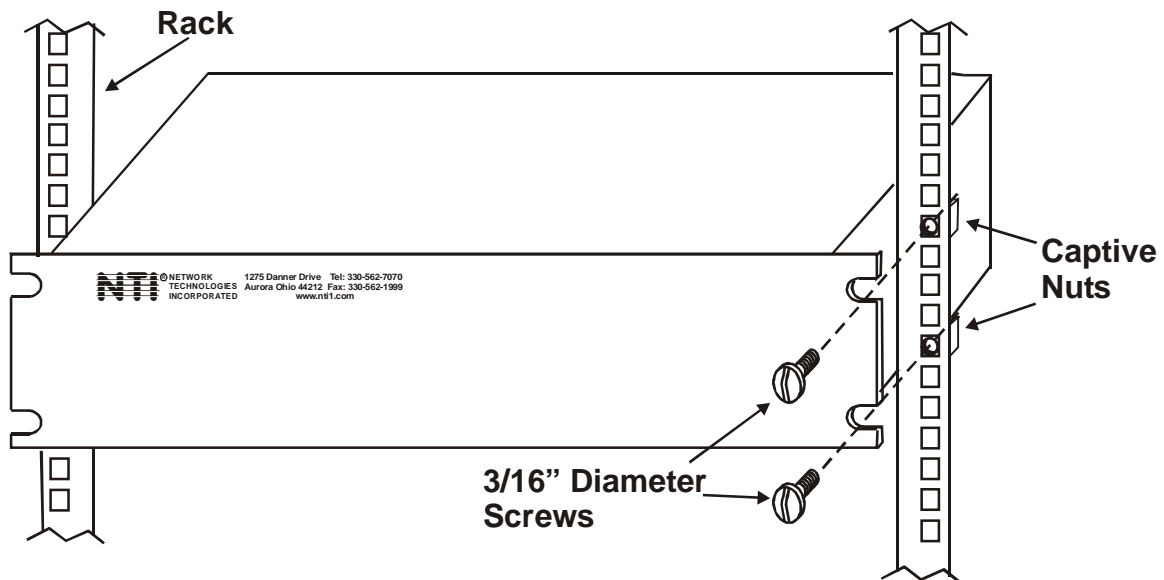

Figure 23- Mount the VEEMUX-A to a rack

SPECIFICATIONS

DESCRIPTION	SPECIFICATION
Video	
Video Connectors	BNC
Maximum Resolution	1920X1080@ 60Hz
Supported Signals	Component video, S-video, Composite video
Input/Output Impedance	75 ohm
Maximum Input / Output Levels	1.7Vp-p, no DC offset
Gain	Unity
DC offset (output)	+/- 15mV; no input offset
Bandwidth	160MHz)
Stereo Audio	
Signal Type	Stereo Audio, analog, left / right
Connectors (Unbalanced)	RCA: Red = Right; White = Left; or BNC (customer defined)
Connectors (Balanced)	Detachable Screw Terminals
Maximum Input Level	2.5Vp-p
Input Impedance	10K ohms
Output Impedance	50 ohms
Frequency Response	+0.15/-1.65dB; 20Hz – 20kHz
THD +N	0.15% @ 1kHz
S/N	90dB
Stereo Channel Separation	-80dB
Output Gain	-80dB to 10dB
Digital Audio	
Signal Type	S/PDIF
Connectors	RCA (Orange); or BNC (customer defined)
Input Impedance	75 ohms
Output Impedance	75 ohms
Resolution	16 to 24 bit
Sampling Rate	32 to 96 kHz
RS232 Control	
RS232 Connector	DB9 female, 1200-9600 bps
Supported Signals	Tx, Rx; RTS wired to CTS; DTR wired to DSR and CD
Flow Control	None
Parity	None
Handshaking	None
Ethernet Control	
Ethernet Connector	RJ45 female
Connection Speed	10 / 100 Mbps; half-duplex and full-duplex support
Security	SSL
Supported Protocols	Http, https, telnet
General Specifications	
Available Sizes	8x4, 8x2, 4x4, 4x2
Power	110~240VAC; 50 or 60Hz
Power Connector	IEC Female
Operating Temperature	10° - 40° C
Enclosure Type	Metal, Rack, 2RU
Enclosure Dimensions	19"x10"x3.5"
Standard Case	2RU Rack Mount
Compliance Certifications	
CE Mark	Complies with EN55022
ESD Protection	Complies with EN61000-4-2 Specification
UL	UL Listed E238791
FCC	Part 15

TROUBLESHOOTING

Problem	Solution
No Video	<ul style="list-style-type: none"> - Check power – power ON, power cable connected - Check video cabling – make sure cables are secured - Check connections – make sure you're connected to an active input
No Audio	<ul style="list-style-type: none"> - Check power – power ON, power cable connected - Check audio cabling – make sure BNC cables are secured (for digital audio), <ul style="list-style-type: none"> - make sure screw terminals are secure (for analog audio). - Check connections – make sure you're connected to an active input - Check volume – make sure the output you are checking is un-muted and turned up to an audible level.

WARRANTY INFORMATION

The warranty period on this product (parts and labor) is one (1) year from the date of purchase. Please contact Network Technologies Inc at **(800) 742-8324** (800-RGB-TECH) or **(330) 562-7070** or visit our website at <http://www.nti1.com> for information regarding repairs and/or returns. A return authorization number is required for all repairs/returns.

Free Manuals Download Website

<http://myh66.com>

<http://usermanuals.us>

<http://www.somanuals.com>

<http://www.4manuals.cc>

<http://www.manual-lib.com>

<http://www.404manual.com>

<http://www.luxmanual.com>

<http://aubethermostatmanual.com>

Golf course search by state

<http://golfingnear.com>

Email search by domain

<http://emailbydomain.com>

Auto manuals search

<http://auto.somanuals.com>

TV manuals search

<http://tv.somanuals.com>