

## VOPEX™ Series

# VOPEX-USBV-2

## USB Keyboard, Video, and Mouse Splitter/Hub

### Installation and Operation Manual



## Warranty Information

The warranty period on this product (parts and labor) is one (1) year from the date of purchase. Please contact Network Technologies Inc at **(800) 742-8324** (800-RGB-TECH) or **(330) 562-7070** or visit our website at <http://www.nti1.com> for information regarding repairs and/or returns. A return authorization number is required for all repairs/returns.

### **COPYRIGHT**

Copyright © 2004 by Network Technologies Inc. All rights reserved. No part of this publication may be reproduced, stored in a retrieval system, or transmitted, in any form or by any means, electronic, mechanical, photocopying, recording, or otherwise, without the prior written consent of Network Technologies Inc, 1275 Danner Drive, Aurora, Ohio 44202.

### **CHANGES**

The material in this guide is for information only and is subject to change without notice. Network Technologies Inc reserves the right to make changes in the product design without reservation and without notification to its users.

**Trademark**---- VOPEX is a trademark of Network Technologies Inc in the U.S. and other countries.

## TABLE OF CONTENTS

INTRODUCTION .....	1
LIMITATIONS .....	1
MATERIALS .....	1
FEATURES AND FUNCTIONS.....	2
INSTALLATION .....	3
Monitor Connection.....	3
Mouse Connection .....	3
Keyboard Connection .....	3
CPU Connection .....	4
Hub Ports .....	4
Power-Up .....	4
OPERATION .....	5
Keyboard Command Mode.....	5
Mice and Trackballs with MACs .....	6
International SUN Keyboards .....	6
Hub Ports .....	6
SPECIFICATIONS .....	7
TROUBLESHOOTING .....	7

## TABLE OF FIGURES

Figure 1- Connect User 1 Keyboard, Mouse, and Monitor.....	3
Figure 2- Connect the VOPEX to the CPU .....	4
Figure 3- Connect other devices to Ports 2-4 .....	4

## INTRODUCTION

The VOPEX-USBV-2-HUB (VOPEX) is a USB KVM Splitter and 3-Port Hub. It enables the control of one USB enabled CPU through two separate USB keyboards, USB mice, and VGA monitors and it enables the connection of 3 additional USB devices (other than keyboards or mice). Each user is able to have complete control of a CPU, provided they don't try to access it at the same time. While the user access is controlled by four (4) separate modes of operation, both user monitors will show the same image at all times. The 3 hub ports (for printer, scanner, camera, etc.) will be connected to the CPU at all times.

### Types of User Input Devices Supported:

- USB keyboard with Windows layout
- USB keyboard with SUN layout
- USB keyboard with MAC layout
- USB Mouse - (up to 3 buttons)
- USB IntelliMouse (scrollwheel)
- Mouse-Trak trackball
- Logitech, Kensington and Microsoft Wheelmouse or Trackball on Mac CPUs with special drivers
- Logitech Cordless Elite Duo keyboard and mouse
- Crystal Vision keyboard with touchpad
- Gyration keyboard/mouse
- NTI USB-PS/2 Adapter
- NTI USB-SUN Adapter

### Types of Shared Devices Supported:

- Both low-speed and full speed USB devices are supported.
- USB 1.1 compliant.
- Plug-n-Play specification supported

### Types of CPUs Supported:

Any USB CPU supporting USB version 1.0 or above including:

- USB WINxx
- USB MAC
- USB SUN

## LIMITATIONS

- The USB ports on the VOPEX are USB 1.1 compatible. Any USB 2.0 device connected to the VOPEX will be regulated to USB 1.1 speeds.

## MATERIALS

### Materials included with this kit:

- VOPEX-USBV-2 2-Port USB KVM Splitter
- USB-AB-1M-ST 1 Meter Transparent USB A-B Device Cable
- VEXT-3 3' M-F VGA Video Cable
- 120 or 240VAC @ 50 or 60Hz-5VDC/2.0A AC Adapter

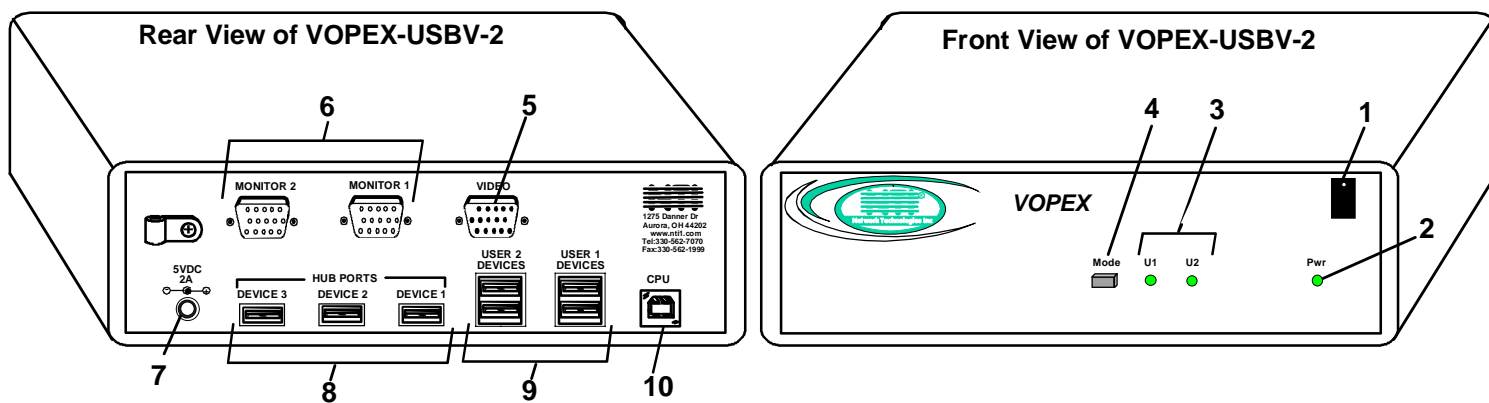

## FEATURES AND FUNCTIONS

1. Power Switch- to power up or power down the VOPEX-USBV-2.
2. Power LED- for visual indication of splitter's power status
3. Mode Status LEDs- for visual indication of splitter's operating mode
4. Mode Switch- press to manually switch between operating modes
5. VIDEO- 15HD male connector- for connecting the video cable from the CPU
6. MONITOR x- 15HD female connectors- for connection of the user video monitors
7. 5VDC- connection jack for the AC adapter
8. DEVICES x- USB type A female connectors- for connection of the cables from USB devices
9. USER x DEVICES- USB type A female connectors- for connection of user USB device(s)
10. CPU- USB type B female connector- for connection of the devices cable from the CPU

## INSTALLATION

*FYI: It is not necessary to disconnect power to the CPU and monitor(s) before installation.*

### Monitor Connection

1. Disconnect the monitor cable at the CPU and reconnect it to the "MONITOR 1" port on the VOPEX. (See Fig. 1)
2. Plug a second monitor (or optional VEXT-xx extension cable) into the "MONITOR 2" port on the VOPEX.

**Note: "xx" in VEXT-xx indicates the length of the cable in feet. Many lengths are available. Contact your VPI salesperson or visit us at our website at <http://www.vpi.us> for details.**

### Mouse Connection

1. Disconnect the mouse at the CPU and reconnect it to one of the female USB type A "USER 1 DEVICES" ports on the VOPEX.
2. Connect a second mouse (or optional USB extension cable NTI USB-A+A-5M) to the female USB type A "USER 2 DEVICES" ports on the VOPEX.

### Keyboard Connection

1. Disconnect the keyboard at the CPU and reconnect the keyboard to the remaining female USB type A "USER 1 DEVICES" port on the VOPEX.
2. Connect a second keyboard (or optional USB extension cable NTI USB-A+A-5M) to the remaining female USB type A "USER 2 DEVICES" ports on the VOPEX.

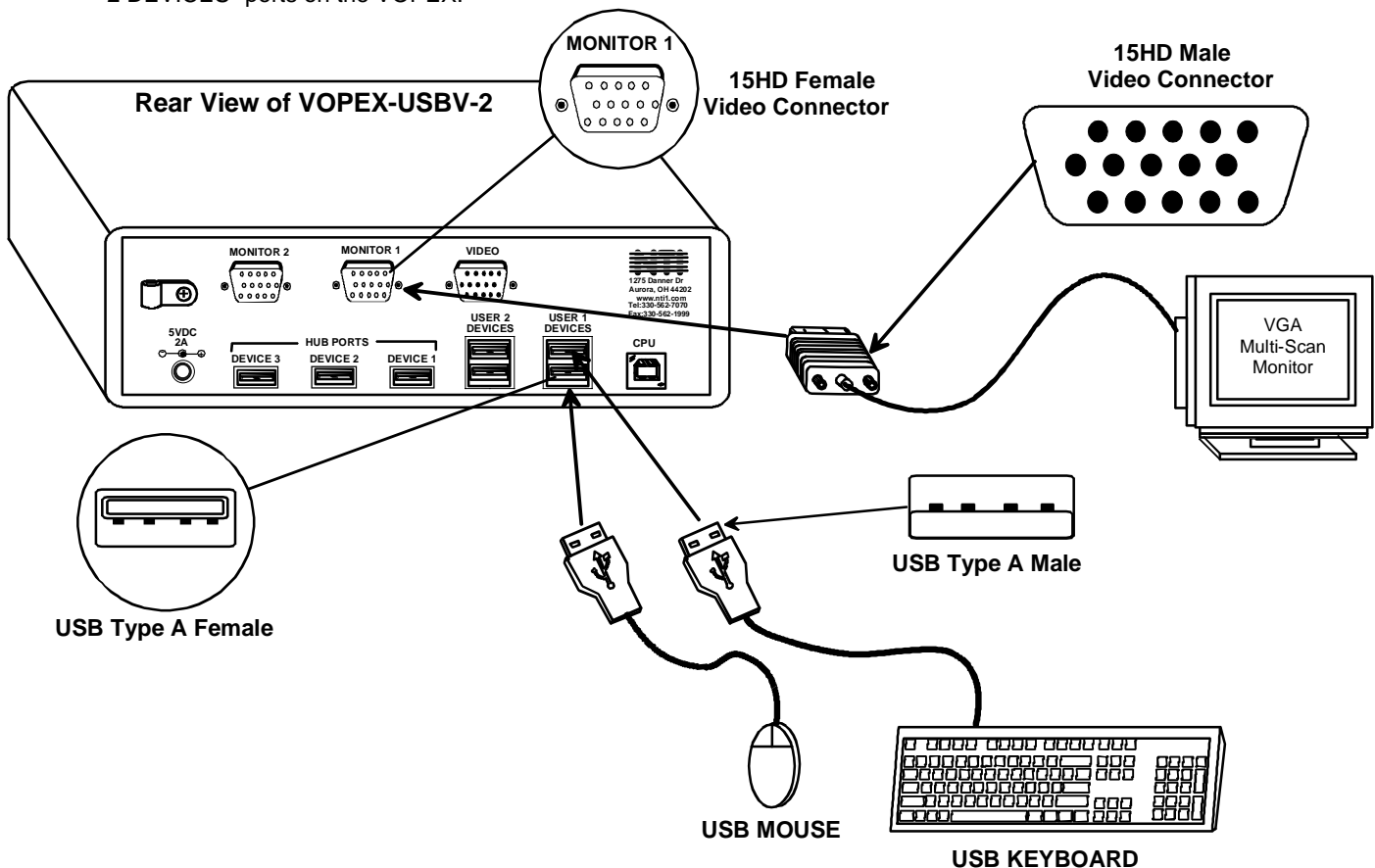

Figure 1- Connect User 1 Keyboard, Mouse, and Monitor

## CPU Connection

1. Connect the male USB type A connector end of the USB-AB-1M-ST cable into the device port on the CPU.
2. Connect the male USB type B connector of the same cable to the "CPU" port on the VOPEX.
3. Connect the male 15HD connector end of the VEXT-3 into the CPU's video port. (See Fig. 2)
4. Connect the female 15HD connector end of the VEXT-3 into the "VIDEO" port on the VOPEX.

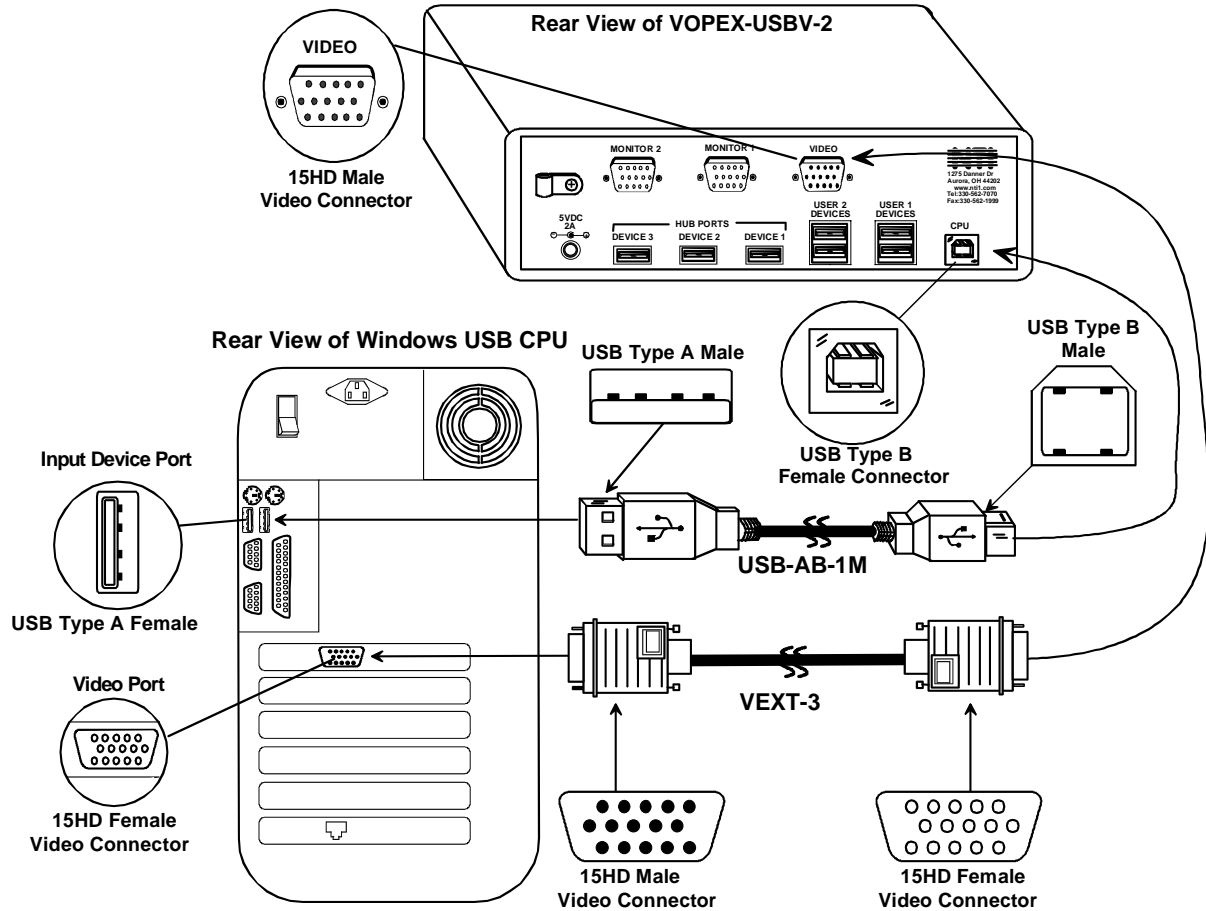

Figure 2- Connect the VOPEX to the CPU

## Hub Ports

If desired, connect additional USB devices to the each of the three "Hub Ports". These ports will be powered and operate anytime the VOPEX and CPU are powered ON. See Fig. 3.

## Power-Up

If not already ON, turn ON power to the CPU monitors, and VOPEX.

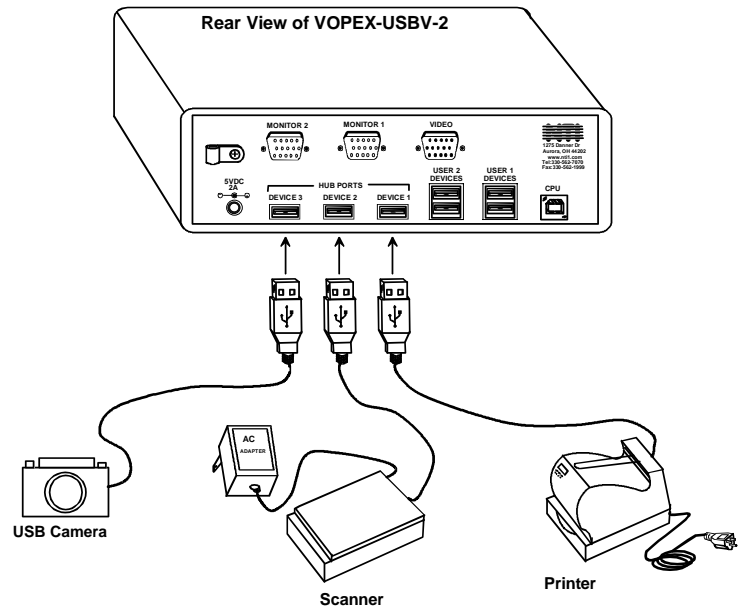









Figure 3- Connect other devices to Ports 2-4

# OPERATION

## Mode Selection

The VOPEX comes equipped with four (4) modes of operation. To manually toggle between modes, depress the MODE button once each time a mode change is desired. The VOPEX will cycle through the 4 modes of operation, then return to the first mode (1 to 2, 2 to 3, 3 to 4, 4 to 1). The following table depicts the 4 operations available for operation.

MODE	DESCRIPTION	INDICATOR LEDS
1- INSTANTANEOUS	Same as "DELAY" mode except that the delay is only 2 seconds rather than 5.	<div style="display: flex; justify-content: space-around;"> <div style="text-align: center;">U1 </div> <div style="text-align: center;">U2 </div> </div>
2- DELAY	First user with active device gets control of CPU. Second user is "Locked out" until after 5 seconds of no activity from first user.	<div style="display: flex; justify-content: space-around;"> <div style="text-align: center;">U1 </div> <div style="text-align: center;">U2 </div> </div>
3- USER 1	"USER 1" has sole access. "USER 2" is locked out.	<div style="display: flex; justify-content: space-around;"> <div style="text-align: center;">U1 </div> <div style="text-align: center;">U2 </div> </div>
4- USER 2	"USER 2" has sole access. "USER 1" is locked out.	<div style="display: flex; justify-content: space-around;"> <div style="text-align: center;">U1 </div> <div style="text-align: center;">U2 </div> </div>

## Keyboard Command Mode

In order to control the other features of the VOPEX with the keyboard, Command Mode must be enabled. To enter Command Mode from the keyboard:

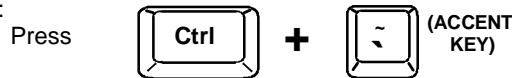

When the Command Mode is enabled, all 3 status lights on the keyboard will illuminate and both LEDs on the VOPEX will illuminate solid to indicate Command Mode is enabled. See the table below for available functions while in Command Mode.

**NOTE: The user must exit Command Mode in order to use the CPU in the selected mode. To exit Command Mode, press ESC on the keyboard. ) The mouse will not operate while in Command Mode.**

**NOTE: While in Command Mode, when a proper programming key is pressed and recognized by the switch, the LEDs on the keyboard will flash once to indicate acceptance. The user must exit Command Mode (by pressing ESC) to see a change take effect in the switch operation.**

**NOTE: The VOPEX will automatically exit Command Mode after 10 seconds of inactivity by the user if the user does not manually exit Command Mode.**

The following functions exist while in Command Mode:

Key Combination	Description of Function
<X>-<key>-<Y>	Select a new key sequence to use to enter Command Mode- Replace <key> with the desired key to follow <Ctrl> with.
<L> - <x> - <x>	Select the country code of the keyboard being used with a USB SUN CPU (see <b>Country Codes</b> chart on page 6)
<V> - <Enter>	This will print the version of the code in the VOPEX to a text editor window (i.e. Windows Notepad) for use when troubleshooting the VOPEX. <b>Note:</b> The text editor should be open prior to entering Command Mode.
<M>	Configure the CPU port to connect to a MAC CPU (see "Mice and Trackballs with MACs" on pg. 6.
<W>	Configure the CPU port to connect to a Windows or SUN CPU
<D> - <x>	Select the operating mode, x=1 for Instantaneous Mode, x=2 for Delay Mode, x=3 User 1Mode, x=4 for User 2 mode. (Modes are described in the table above.)
<P> - <x>	Select the default mode to have the VOPEX enter upon power-up.
<Esc>	Exit Command Mode



## Mice and Trackballs with MACs

The VOPEX can be configured to enable full functionality between mice and trackballs having two or more buttons and a USB MAC CPU. By default, the CPU port on the VOPEX is configured for use a WINDOWS or SUN CPU and has no special translation for using multi-function mice and trackballs when a MAC CPU is connected. Using the commands in Command Mode above, either enable or disable this feature as needed.

**NOTE: Be sure to re-configure port for connection to a WINDOWS or SUN CPU if a MAC CPU is removed and a WINDOWS or SUN CPU is then connected.**

## International SUN Keyboards

The VOPEX can recognize international layouts for Sun keyboards. In order to use an international Sun keyboard, follow this procedure:

1. Disconnect the CPU from the VOPEX
2. Connect the international keyboard to be used to the VOPEX
3. Power down the VOPEX for at least 3 seconds
4. Power up the VOPEX
5. Reconnect the CPU to the VOPEX

It is also possible to configure the VOPEX to emulate a specific international Sun keyboard regardless of what actual keyboard is connected. This is recommended when the CPU needs the layout code (i.e. a SUN CPU) and the keyboard doesn't have an explicit layout code (i.e. some Windows keyboards). To do this, manually set the VOPEX to indicate the international keyboard identification number to the CPU using the following procedure;

1. Connect the keyboard to be used to the VOPEX
2. Power down the VOPEX for at least 3 seconds
3. Power up the VOPEX
4. Enter Command Mode (<Ctrl> - <`>)
5. Type Lxx, where xx is the number from the list below that corresponds to the desired country code
6. Exit Command Mode
7. Power down the VOPEX for at least 3 seconds
8. Power up the VOPEX
9. Reboot the CPU connected to the VOPEX

### Country Codes

00	Not Supported	18	Netherlands/Dutch
01	Arabic	19	Norwegian
02	Belgian	20	Persian (Farsi)
03	Canadian-Bilingual	21	Poland
04	Canadian-French	22	Portuguese
05	Czech Republic	23	Russia
06	Danish	24	Slovakia
07	Finnish	25	Spanish
08	French	26	Swedish
09	German	27	Swiss/French
10	Greek	28	Swiss/German
11	Hebrew	29	Switzerland
12	Hungary	30	Taiwan
13	International (ISO)	31	Turkish
14	Italian	32	UK
15	Japan (Katakana)	33	US
16	Korean	34	Yugoslavia
17	Latin American	35-99	Reserved

## Hub Ports

The three connections labeled "Hub Ports" can be used to connect any USB device, such as a printer, scanner, camera, etc. for continuous operation at USB 1.1 compliant speeds. These ports are not controlled by the VOPEX.

## SPECIFICATIONS

**Size:** Each unit is 8.5"W x 6"D x 2.6"H

**Power:** Powered by 120 or 240VAC @ 50 or 60Hz-5VDC/2.0A AC Adapter

**Connections:** 15HD VGA & SGA compatible  
USB Type A female device connectors  
USB Type B female CPU connector

## TROUBLESHOOTING

### PROBLEM

- Keyboard error
- Mouse not working
- Monochrome on VIDEO OUT 1 port

### SOLUTION

- Check cable connections on CPU and VOPEX
- Check cable connections on CPU and VOPEX
- No ID bits – call VPI immediately

**MODEL NO:** VOPEX-USBV-2

**SERIAL NO:** \_\_\_\_\_

**DATE:** \_\_\_\_\_

**INSPECTED BY:** \_\_\_\_\_

## Free Manuals Download Website

<http://myh66.com>

<http://usermanuals.us>

<http://www.somanuals.com>

<http://www.4manuals.cc>

<http://www.manual-lib.com>

<http://www.404manual.com>

<http://www.luxmanual.com>

<http://aubethermostatmanual.com>

Golf course search by state

<http://golfingnear.com>

Email search by domain

<http://emailbydomain.com>

Auto manuals search

<http://auto.somanuals.com>

TV manuals search

<http://tv.somanuals.com>