

Nikon

DIGITAL CAMERA

COOLPIX S33



Reference Manual

En

Introduction	⇒ i
Table of Contents	⇒ xvi
Parts of the Camera	⇒ 1
Preparing for Shooting	⇒ 7
Basic Shooting and Playback Operations	⇒ 14
Shooting Features	⇒ 21
Playback Features	⇒ 43
Recording and Playing Back Movies	⇒ 75
General Camera Setup	⇒ 79
Connecting the Camera to a TV, Printer, or Computer	⇒ 89
Technical Notes	⇒ 98

Introduction

Read This First

To get the most from this Nikon product, be sure to read “For Your Safety” (📖v-vii) and “<Important> Shockproof, Waterproof, Dustproof, Condensation” (📖x-xv), and all other instructions thoroughly and keep them where they will be read by all who use the camera.

- If you want to start using the camera right away, see “Preparing for Shooting” (📖7) and “Basic Shooting and Playback Operations” (📖14).

Other Information

- Symbols and Conventions

Symbol	Description
☑	This icon marks cautions and information that should be read before using the camera.
📝	This icon marks notes and information that should be read before using the camera.
📖	This icon marks other pages containing relevant information.

- SD, SDHC, and SDXC memory cards are referred to as “memory cards” in this manual.
- The setting at the time of purchase is referred to as the “default setting.”
- The names of menu items displayed in the camera monitor, and the names of buttons or messages displayed on a computer monitor appear in bold.
- In this manual, images are sometimes omitted from monitor display samples so that monitor indicators can be more clearly shown.

How to Attach the Camera Strap

Pass the strap through either the left or right strap eyelet and attach the strap.

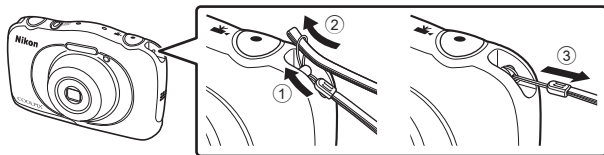

Information and Precautions

Life-Long Learning

As part of Nikon's "Life-Long Learning" commitment to ongoing product support and education, continually updated information is available online at the following websites:

- For users in the U.S.A.: <http://www.nikonusa.com/>
- For users in Europe and Africa: <http://www.europe-nikon.com/support/>
- For users in Asia, Oceania, and the Middle East: <http://www.nikon-asia.com/>

Visit these websites to keep up-to-date with the latest product information, tips, answers to frequently asked questions (FAQs), and general advice on digital imaging and photography. Additional information may be available from the Nikon representative in your area. Visit the website below for contact information.

<http://imaging.nikon.com/>

Use Only Nikon Brand Electronic Accessories

Nikon COOLPIX cameras are designed to the highest standards and include complex electronic circuitry. Only Nikon brand electronic accessories (including battery chargers, batteries, Charging AC Adapters, AC adapters, and USB cables) certified by Nikon specifically for use with this Nikon digital camera are engineered and proven to operate within the operational and safety requirements of this electronic circuitry. THE USE OF NON-NIKON ELECTRONIC ACCESSORIES COULD DAMAGE THE CAMERA AND MAY VOID YOUR NIKON WARRANTY.

The use of third-party rechargeable Li-ion batteries not bearing the Nikon holographic seal could interfere with normal operation of the camera or result in the batteries overheating, igniting, rupturing, or leaking.

For more information about Nikon brand accessories, contact a local authorized Nikon dealer.

Holographic seal: Identifies this device as an authentic Nikon product.



Before Taking Important Pictures

Before taking pictures on important occasions (such as at weddings or before taking the camera on a trip), take a test shot to ensure that the camera is functioning normally. Nikon will not be held liable for damages or lost profits that may result from product malfunction.

About the Manuals

- No part of the manuals included with this product may be reproduced, transmitted, transcribed, stored in a retrieval system, or translated into any language in any form, by any means, without Nikon's prior written permission.
- Illustrations and monitor content shown in this manual may differ from the actual product.
- Nikon reserves the right to change the specifications of the hardware and software described in these manuals at any time and without prior notice.
- Nikon will not be held liable for any damages resulting from the use of this product.
- While every effort was made to ensure that the information in these manuals is accurate and complete, we would appreciate it were you to bring any errors or omissions to the attention of the Nikon representative in your area (address provided separately).

Notice Concerning Prohibition of Copying or Reproduction

Note that simply being in possession of material that was digitally copied or reproduced by means of a scanner, digital camera or other device may be punishable by law.

• Items prohibited by law from being copied or reproduced

Do not copy or reproduce paper money, coins, securities, government bonds or local government bonds, even if such copies or reproductions are stamped "Sample." The copying or reproduction of paper money, coins, or securities which are circulated in a foreign country is prohibited. Unless the prior permission of the government was obtained, the copying or reproduction of unused postage stamps or post cards issued by the government is prohibited.

The copying or reproduction of stamps issued by the government and of certified documents stipulated by law is prohibited.

• Cautions on certain copies and reproductions

The government has issued cautions on copies or reproductions of securities issued by private companies (shares, bills, checks, gift certificates, etc.), commuter passes, or coupon tickets, except when a minimum of necessary copies are to be provided for business use by a company. Also, do not copy or reproduce passports issued by the government, licenses issued by public agencies and private groups, ID cards and tickets, such as passes and meal coupons.

• Comply with copyright notices

The copying or reproduction of copyrighted creative works such as books, music, paintings, woodcut prints, maps, drawings, movies, and photographs is governed by national and international copyright laws. Do not use this product for the purpose of making illegal copies or to infringe copyright laws.

Disposing of Data Storage Devices

Please note that deleting images or formatting data storage devices such as memory cards or built-in camera memory does not completely erase the original image data. Deleted files can sometimes be recovered from discarded storage devices using commercially available software, potentially resulting in the malicious use of personal image data. Ensuring the privacy of such data is the user's responsibility.

Before discarding a data storage device or transferring ownership to another person, erase all data using commercial deletion software, or format the device and then completely refill it with images containing no private information (for example, images of empty sky). Care should be taken to avoid injury or damage to property when physically destroying data storage devices.

Conformity Marking

Follow the procedure below to display some of the conformity markings that the camera complies with.

Enter shooting mode or playback mode → flexible button 4 (Y) → flexible button 4 (Y) Camera settings → press ▲▼ → □ Conformity marking

For Your Safety

To prevent damage to your Nikon product or injury to yourself or to others, read the following safety precautions in their entirety before using this equipment. Keep these safety instructions where all those who use the product will read them.



This icon marks warnings, information that should be read before using this Nikon product, to prevent possible injury.

WARNINGS

Turn off in the event of malfunction

Should you notice smoke or an unusual smell coming from the camera or Charging AC Adapter, unplug the Charging AC Adapter and remove the battery immediately, taking care to avoid burns. Continued operation could result in injury. After removing or disconnecting the power source, take the equipment to a Nikon-authorized service representative for inspection.

Do not disassemble

Touching the internal parts of the camera or Charging AC Adapter could result in injury. Repairs should be performed only by qualified technicians. Should the camera or Charging AC Adapter break open as the result of a fall or other accident, take the product to a Nikon-authorized service representative for inspection, after unplugging the product and/or removing the battery.

Do not use the camera or Charging AC Adapter in the presence of flammable gas

Do not use electronic equipment in the presence of flammable gas, as this could result in explosion or fire.

Handle the camera strap with care

Never place the strap around the neck of an infant or child.

Keep out of reach of children

Particular care should be taken to prevent infants from putting the battery, brush, or other small parts into their mouths.

Do not remain in contact with the camera, Charging AC Adapter, or AC adapter for extended periods while the devices are on or in use

Parts of the devices become hot. Leaving the devices in direct contact with the skin for extended periods may result in low-temperature burns.

 **Do not leave the product where it will be exposed to extremely high temperatures, such as in an enclosed automobile or in direct sunlight**

Failure to observe this precaution could cause damage or fire.

 **Observe caution when handling the battery**

The battery may leak, overheat, or explode if improperly handled. Observe the following precautions when handling the battery for use in this product:

- Before replacing the battery, turn the product off. If you are using the Charging AC Adapter/AC adapter, be sure it is unplugged.
- Use only a Rechargeable Li-ion Battery EN-EL19 (included). Charge the battery by using a camera that supports battery charging or by using a Battery Charger MH-66 (available separately). To charge the battery with the camera, use either Charging AC Adapter EH-71P (included) or the **Charge by computer** function.
- When inserting the battery, do not attempt to insert it upside down or backwards.
- Do not short or disassemble the battery or attempt to remove or break the battery insulation or casing.
- Do not expose the battery to flame or to excessive heat.
- Do not immerse in or expose to water.
- Put the battery in a plastic bag, etc. in order to insulate it before transporting. Do not transport or store with metal objects such as necklaces or hairpins.
- The battery is prone to leakage when fully discharged. To avoid damage to the product, be sure to remove the battery when no charge remains.
- Discontinue use immediately should you notice any change in the battery, such as discoloration or deformation.
- If liquid from the damaged battery comes in contact with clothing or skin, rinse immediately with plenty of water.

 **Observe the following precautions when handling the Charging AC Adapter**

- Keep dry. Failure to observe this precaution could result in fire or electric shock.
- Dust on or near the metal parts of the plug should be removed with a dry cloth. Continued use could result in fire.
- Do not handle the plug or go near the Charging AC Adapter during lightning storms. Failure to observe this precaution could result in electric shock.
- Do not damage, modify, forcibly tug or bend the USB cable, place it under heavy objects, or expose it to heat or flames. Should the insulation be damaged and the wires become exposed, take it to a Nikon-authorized service representative for inspection. Failure to observe these precautions could result in fire or electric shock.

- Do not handle the plug or Charging AC Adapter with wet hands. Failure to observe this precaution could result in electric shock.
- Do not use with travel converters or adapters designed to convert from one voltage to another or with DC-to-AC inverters. Failure to observe this precaution could damage the product or cause overheating or fire.

 **Use the appropriate power supply (battery, Charging AC adapter, AC adapter, USB cable)**

Using a power supply other than those provided or sold by Nikon could result in damage or malfunction.

 **Use appropriate cables**

When connecting cables to the input and output jacks, use only the cables provided or sold by Nikon for the purpose, to maintain compliance with product regulations.

 **Handle moving parts with care**

Be careful that your fingers or other objects are not pinched by the lens cover or other moving parts.

 **Using the flash close to your subject's eyes could cause temporary visual impairment**

The flash should be no less than 1 meter (3 ft 4 in.) from the subject. Particular care should be observed when photographing infants.

 **Do not operate the flash with the flash window touching a person or object**

Failure to observe this precaution could result in burns or fire.

 **Avoid contact with liquid crystal**

Should the monitor break, care should be taken to avoid injury caused by broken glass and to prevent liquid crystal from the monitor touching the skin or entering the eyes or mouth.

 **Follow the instructions of airline and hospital personnel**

Notices

Notices for Customers in the U.S.A.

IMPORTANT SAFETY INSTRUCTIONS - SAVE THESE INSTRUCTIONS.

DANGER - TO REDUCE THE RISK OF FIRE OR ELECTRIC SHOCK, CAREFULLY FOLLOW THESE INSTRUCTIONS

For connection to a supply not in the U.S.A., use an attachment plug adapter of the proper configuration for the power outlet if needed.

The power supply unit is intended to be correctly orientated in a vertical or floor mount position.

Federal Communications Commission (FCC) Radio Frequency Interference Statement

This equipment has been tested and found to comply with the limits for a Class B digital device, pursuant to Part 15 of the FCC rules. These limits are designed to provide reasonable

protection against harmful interference in a residential installation. This equipment generates, uses, and can radiate radio frequency energy and, if not installed and used in accordance with the instructions, may cause harmful interference to radio communications. However, there is no guarantee that interference will not occur in a particular installation. If this equipment does cause harmful interference to radio or television reception, which can be determined by turning the equipment off and on, the user is encouraged to try to correct the interference by one or more of the following measures:

- Reorient or relocate the receiving antenna.
- Increase the separation between the equipment and receiver.
- Connect the equipment into an outlet on a circuit different from that to which the receiver is connected.
- Consult the dealer or an experienced radio/television technician for help.

CAUTIONS

Modifications

The FCC requires the user to be notified that any changes or modifications made to this device that are not expressly approved by Nikon Corporation may void the user's authority to operate the equipment.

Interface Cables

Use the interface cables sold or provided by Nikon for your equipment. Using other interface cables may exceed the limits of Class B Part 15 of the FCC rules.



Nikon

COOLPIX S33

Notice for Customers in the State of California

WARNING

Handling the cord on this product will expose you to lead, a chemical known to the State of California to cause birth defects or other reproductive harm.

Wash hands after handling.

Nikon Inc.,

1300 Walt Whitman Road, Melville, New York 11747-3064, U.S.A.

Tel: 631-547-4200

Notice for Customers in Canada

CAN ICES-3 B / NMB-3 B

Notices for Customers in Europe

CAUTIONS

RISK OF EXPLOSION IF BATTERY IS REPLACED BY AN INCORRECT TYPE.

DISPOSE OF USED BATTERIES ACCORDING TO THE INSTRUCTIONS.

This symbol indicates that electrical and electronic equipment is to be collected separately.

The following apply only to users in European countries:

- This product is designated for separate collection at an appropriate collection point. Do not dispose of as household waste.
- Separate collection and recycling helps conserve natural resources and prevent negative consequences for human health and the environment that might result from incorrect disposal.
- For more information, contact the retailer or the local authorities in charge of waste management.



This symbol on the battery indicates that the battery is to be collected separately.

The following apply only to users in European countries:

- All batteries, whether marked with this symbol or not, are designated for separate collection at an appropriate collection point. Do not dispose of as household waste.
- For more information, contact the retailer or the local authorities in charge of waste management.



<Important> Shockproof, Waterproof, Dustproof, Condensation

- Make sure to read the following instructions as well as the instructions provided in “Caring for the Product” (📖99).

Notes About Shockproof Performance

This camera has passed Nikon’s in-house test (drop test from a height of 1.5 m (5 ft) on a 5 cm (2 in.) thick plywood panel) compliant with MIL-STD 810F Method 516.5-Shock*.

This test does not guarantee the waterproof performance of the camera or that the camera will be free from damage or trouble under all conditions.

Changes in appearance, such as paint peeling off and deformation of the drop shock portion are not subject to the Nikon’s in-house test.

* U.S. Department of Defense test method standard.

This drop test drops 5 cameras in 26 directions (8 edges, 12 corners, and 6 faces) from a height of 122 cm (48 in.) to make sure that one to five cameras pass the test (if any defect is detected during the test, another five cameras are tested to make sure that the test criteria are satisfied for one to five cameras).

● Do not subject the camera to excessive shock, vibration or pressure by dropping or hitting it, or by placing heavy objects on it.

Deformation may damage the airtight seals and water may seep inside the camera, resulting in camera malfunction.

- Do not use the camera deeper than 10 m (33 ft) underwater.
- Do not subject the camera to water pressure by exposing it to high-pressure running water.
- Do not sit down with the camera in the pocket of your trousers.
Do not forcibly stuff the camera into a bag.

Notes About Waterproof and Dustproof Performances

The camera is equivalent to IEC/JIS waterproof grade 8 (IPX8) and IEC/JIS dustproof grade 6 (IP6X) and enables shooting pictures underwater at a depth of 10 m (33 ft) for up to 60 minutes.*

This rating does not guarantee the waterproof performance of the camera or that the camera will be free from damage or trouble under all conditions.

* This rating indicates that the camera has been designed to withstand the specified water pressure for the specified period of time when the camera is used according to the methods defined by Nikon.

● **If the camera is subjected to excessive shock, vibration or pressure by dropping or hitting it, or by placing heavy objects on it, the waterproof performance is not guaranteed.**

- If the camera is exposed to shocks, it is recommended to consult your retailer or Nikon-authorized service representative to confirm the waterproof performance (charged service).
 - Do not drop the camera, strike it against a hard object such as a rock, or throw it at a water surface.
 - Do not use the camera deeper than 10 m (33 ft) underwater.
 - Do not subject the camera to water pressure by exposing it to rapid flowing water or waterfalls.
 - Your Nikon warranty may not cover troubles caused by water seeping inside the camera due to improper handling of the camera.
- If water seeps inside the camera, immediately stop using the camera. Wipe off moisture from the camera, and at once take the camera to your Nikon-authorized service representative.
- The waterproof performance of this camera is designed to work for fresh water and seawater only.
- The inner portion of this camera is not waterproof. If water seeps inside the camera, this could cause the components to rust and result in a high repair charge or the camera may not be repairable.
- Accessories are not waterproof.
- If liquids or water droplets come into contact with the outside of the camera or the inside of the battery-chamber/memory card slot cover, immediately wipe the liquids off with a soft dry cloth. Do not insert wet memory cards or the battery.

If the battery-chamber/memory card slot cover is opened or closed under wet conditions near a waterfront or underwater, this could cause water to seep inside the camera or result in camera malfunction.

Do not open or close the cover with wet hands. This could cause water to seep inside the camera or result in camera malfunction.

- If a foreign substance adheres to the outside of the camera or the inside of the battery-chamber/memory card slot cover (such as the hinge, memory card slot, and connectors), remove it immediately with a blower. If a foreign substance adheres to the waterproof packing inside the battery-chamber/memory card slot cover, remove it with the included brush. Do not use the included brush for anything other than cleaning the waterproof packing.

Waterproof packing

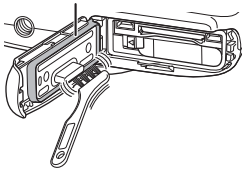

- If a foreign substance such as suntan oil, sunscreen lotion, hot spring water, bath mix powder, detergent, soap, organic solvent, oil, or alcohol adheres to the camera, immediately wipe it off. Failure to do so may cause the camera exterior to deteriorate.
- Do not leave the camera in high-temperature conditions of 40°C (104°F) or more (in particular, a place exposed to direct sunlight, inside the cabin of a car, on a boat, on the beach, or near a heating device) for a long period of time. This could cause deterioration of the waterproof performance.

Before Using the Camera Underwater

- 1. Make sure that there are no foreign substances inside the battery-chamber/memory card slot cover.**
 - Any foreign substances such as sand, dust or hair inside the battery-chamber/memory card slot cover should be removed with a blower.
 - Any liquid such as water droplets inside the battery-chamber/memory card slot cover should be wiped off with a soft dry cloth.
- 2. Make sure that the waterproof packing (📖2) of the battery-chamber/memory card slot cover is not cracked or deformed.**
 - The waterproof performance of waterproof packing may start to deteriorate after one year. If the waterproof packing begins to deteriorate, consult your retailer or Nikon-authorized service representative.
 - Also make sure that the waterproof packing does not come off.
- 3. Make sure that the battery-chamber/memory card slot cover is firmly closed.**
 - Slide the cover until it clicks into place.

Notes About Using the Camera Underwater

Observe the following precautions to prevent water from seeping inside the camera.

- Do not dive into water deeper than 10 m (33 ft) with the camera.
- Do not continuously use the camera underwater for 60 minutes or more.
- Use the camera in the water temperature range 0°C–40°C (32°F–104°F) when using it underwater.
Do not use the camera at hot springs.
- Do not open or close the battery-chamber/memory card slot cover underwater.
- Do not subject the camera to shock when using it underwater.
Do not jump into water with the camera or subject it to high water pressure conditions such as rapids or waterfalls.
- This camera does not float in water. Make sure not to drop the camera underwater.

Cleaning After Using the Camera Underwater

After using the camera underwater or at the beach or other sandy or dusty environment, wipe off any sand, dust, or salt with a dry cloth lightly dampened with fresh water and dry thoroughly within 60 minutes.

If you leave the camera in wet conditions where salt particles or other foreign substances adhere to it, this could cause damage, discoloration, corrosion, a bad smell or deterioration of waterproof performance.

To ensure long operational use, washing the camera by using the following procedure is recommended.

- Before cleaning the camera, thoroughly remove water droplets, sand, salt particles, or other foreign substances from your hands, body, and hair.
- It is recommended to clean the camera indoors to avoid a place where it could be exposed to water spray or sand.
- Do not open the battery-chamber/memory card slot cover until all foreign substances are washed off with water and all moisture is wiped off.

1. Keep the battery-chamber/memory card slot cover closed and wash off the camera with fresh water.

Lightly rinse the camera with tap water, or immerse the camera in a shallow basin filled with freshwater for about 10 minutes.

- If the buttons or switches do not operate properly, foreign substances may have adhered to the camera.
Foreign substances can cause the camera to malfunction; wash the camera thoroughly.

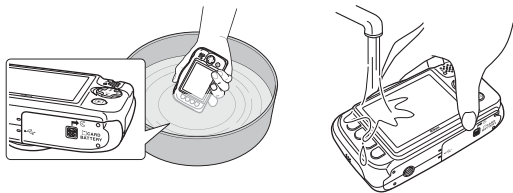

2. Wipe off water droplets with a soft cloth and dry the camera in the well-ventilated and shady place.

- Place the camera on a dry cloth to dry it.
Water will flow out from openings in the microphone or speakers.
- Do not dry the camera with hot air from a hair dryer or clothes dryer.
- Do not use chemicals (such as benzine, thinner, alcohol, or cleanser), soap, or neutral detergents.
If the waterproof packing or body of the camera becomes deformed, the waterproof performance will deteriorate.

3. After making sure that there are no water droplets on the camera, open the battery-chamber/memory card slot cover, gently wipe off any water remaining inside the camera with a dry soft cloth, and use the blower to remove any foreign substances.

- If you open the cover before the camera is thoroughly dried, water droplets may fall on the memory card or battery.
The water droplets may also seep inside the battery-chamber/memory card slot cover (in locations such as waterproof packing, hinges, memory card slot, or terminals).
If that happens, wipe the water off with a dry soft cloth.
- If the cover is closed when the inside is wet, this could cause condensation or malfunction.
- If the microphone or speaker openings are clogged with water droplets, the sound may deteriorate or become distorted.
 - Wipe the water off with a dry soft cloth.
 - Do not puncture the microphone or speaker openings with a sharp implement. If the inside of the camera is damaged, the waterproof performance will deteriorate.

Notes About Operating Temperature and Humidity and Condensation

The operation of this camera has been tested at temperatures -10°C – $+40^{\circ}\text{C}$ (14°F – 104°F).

When you use the camera in cold climate regions, observe the following precautions. Keep the camera and spare batteries in a warm place before use.

- The performance of the batteries (number of pictures shot and shooting time) will drop temporarily.
- If the camera is in a very cold state, the performance may drop temporarily, for example, the monitor may be darker than normal immediately after the camera is turned on or residual images may be produced.
- When snow or water droplets adhere to the exterior of the camera, immediately wipe them off.
 - If the buttons or switches are frozen, they may not operate smoothly.
 - If the microphone or speaker openings are clogged with water droplets, the sound may deteriorate or become distorted.

● **Operating environmental conditions such as temperature and humidity may cause fogging (condensation) on the inside of the monitor, lens, or flash window.**

This is not a camera malfunction or defect.

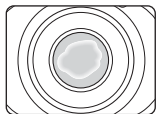

● **Environmental conditions that are likely to cause condensation inside of the camera**

Fogging (condensation) may occur on the inside of the monitor, lens, or flash window in the following environmental conditions where there are sharp temperature changes or high humidity.

- The camera is suddenly immersed in low temperature underwater from high temperature on land such as the beach or places under direct sunlight.
- The camera is moved from a cold place to a warm place, such as inside a building.
- The battery-chamber/memory card slot cover is open or closed in a high-humidity environment.

● **Clearing the fogging**

- Open the battery-chamber/memory card slot cover after turning off the camera in a place where the ambient temperature is stable (avoid any place that has high temperature/high humidity, sand or dust).
- To clear the fogging, remove the battery and memory card, and leave the camera with the battery-chamber/memory card slot cover open to allow the camera to adjust to the ambient temperature.
- If the fogging does not clear, consult your retailer or Nikon-authorized service representative.

Table of Contents

Introduction	i
Read This First	i
Other Information.....	i
How to Attach the Camera Strap.....	i
Information and Precautions.....	ii
For Your Safety	v
WARNINGS	v
Notices	viii
<Important> Shockproof, Waterproof, Dustproof, Condensation.....	x
Notes About Shockproof Performance.....	x
Notes About Waterproof and Dustproof Performances	x
Before Using the Camera Underwater.....	xii
Notes About Using the Camera Underwater	xii
Cleaning After Using the Camera Underwater.....	xiii
Notes About Operating Temperature and Humidity and Condensation	xv
<hr/>	
Parts of the Camera	1
The Camera Body.....	1
The Monitor	3
Shooting Mode	3
Playback Mode	4
Using the Flexible Buttons	5
<hr/>	
Preparing for Shooting.....	7
Insert the Battery and Memory Card	7
Removing the Battery or Memory Card.....	8
Memory Cards and Internal Memory.....	8
Charge the Battery	9
Turn the Camera On and Set the Display Language, Date, and Time	11

Basic Shooting and Playback Operations	14
Point and Shoot	14
The Shutter-release Button.....	15
Using the Zoom.....	16
Play Back Images	17
Delete Images	18
Restrict Image Deletion (Image Lock).....	20
Shooting Features	21
Functions Available in Shooting Mode (Shooting Menu)	21
 Point and Shoot	22
Using Target Finding AF.....	22
Flash Mode	23
Self-timer	24
Smile Timer	25
Choose a Style (Shooting Suited to Scenes and Effects)	26
Tips and Notes.....	27
Decorate	32
Change Colors	33
Change Sounds	34
Choose a Size	36
Choose a Photo Size.....	36
Choose a Movie Frame Size.....	37
Focusing	38
Using Face Detection.....	38
Using Skin Softening.....	39
Subjects Not Suitable for Autofocus.....	39
Focus Lock.....	40
Functions That Cannot Be Used Simultaneously When Shooting	41

Playback Features.....	43
Playback Zoom	43
Thumbnail Playback	44
Functions Available in Playback Mode (Playback Menu)	45
🔗 Exchange Messages.....	46
Leave a Message.....	46
Leave a Reply.....	47
Play Recordings.....	48
Erase Recordings.....	48
🖼️ Picture Play	49
Before Editing Images.....	49
👤 Add Makeup.....	50
📁 Make Photo Albums	51
👁️ Add a Fisheye Effect.....	53
📷 Toy Camera	53
🌀 Soften Pictures	54
✨ Add Starbursts	54
🏡 Add a Diorama Effect.....	55
🎨 Change Colors	55
🖌️ Highlight Colors.....	56
🖼️ Decorate.....	57
👑 Grading	58
Grade Pictures.....	58
View Graded Pictures.....	60
Remove All Grades	61
📌 Favorites	62
Add to Favorites.....	62
View Favorites	64
Remove From Favorites.....	65
📅 View by Date.....	66
📺 Slide Show	67
Choose Pictures	67
Choose a Theme.....	70
🔧 Retouch	71
📄 Copy.....	71
🔄 Rotate Pictures.....	73
🖼️ Small Picture	74
Recording and Playing Back Movies.....	75
Operations During Movie Playback	78

General Camera Setup	79
Camera Settings Menu	79
Y Camera Settings	80
Welcome Screen.....	80
Date and Time	80
Variety Menu.....	81
Brightness.....	82
Date Stamp	82
Electronic VR.....	83
AF Assist.....	84
Format Card/Format Memory.....	85
Language	86
Menu Background	86
Charge by Computer.....	87
Reset All.....	88
Conformity Marking	88
Firmware Version	88
Connecting the Camera to a TV, Printer, or Computer	89
Connecting the Camera to a TV	91
Connecting the Camera to a Printer	92
Connecting the Camera to a Printer	92
Printing Images One at a Time	93
Printing Multiple Images.....	94
Using ViewNX 2 (Transferring Images to a Computer)	96
Installing ViewNX 2	96
Transferring Images to a Computer.....	96

Technical Notes	98
Caring for the Product	99
The Camera.....	99
The Battery	100
The Charging AC Adapter.....	101
Memory Cards.....	102
Cleaning and Storage	103
Cleaning.....	103
Storage	103
Error Messages	104
Troubleshooting	107
File Names	114
Optional Accessories	115
Specifications	116
Approved Memory Cards.....	120
Index	122

Parts of the Camera

The Camera Body

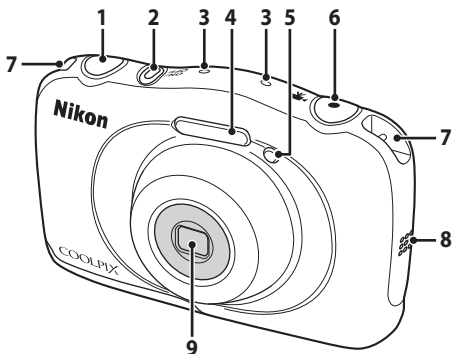

- | | | | | | |
|----------|---------------------------------|----|----------|--------------------------------|----|
| 1 | Shutter-release button..... | 14 | 6 | ● (▶ movie-record) button..... | 75 |
| 2 | Power switch/power-on lamp...11 | | 7 | Eyelet for camera strap..... | i |
| 3 | Microphone (stereo) | | 8 | Speaker | |
| 4 | Flash..... | 23 | 9 | Lens (with protective glass) | |
| 5 | Self-timer lamp..... | 24 | | | |
| | AF-assist illuminator | | | | |

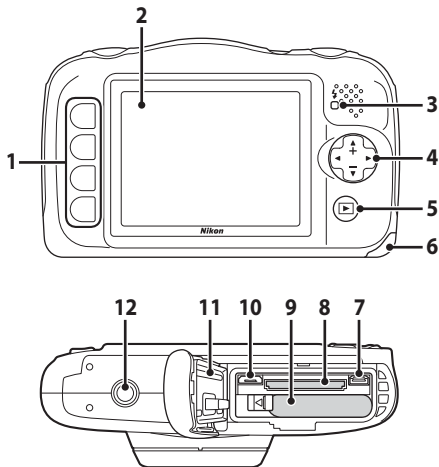

- | | | | |
|----------|--|-----------|---|
| 1 | Flexible buttons..... 5, 21, 45 | 7 | HDMI micro connector (Type D)
..... 89 |
| 2 | Monitor 3 | 8 | Memory card slot 7 |
| 3 | Charge lamp..... 9
Flash lamp..... 23 | 9 | Battery chamber 7 |
| 4 | Multi selector
▲: Telephoto 16
▼: Wide-angle..... 16 | 10 | Micro-USB connector..... 89 |
| 5 | ▶ (shooting/playback mode)
button..... 17 | 11 | Waterproof packing..... x, xii |
| 6 | Battery-chamber/
memory card slot cover 7 | 12 | Tripod socket 118 |

The Monitor

The information that is displayed in the monitor during shooting and playback changes depending on the camera's settings and state of use.

Shooting Mode

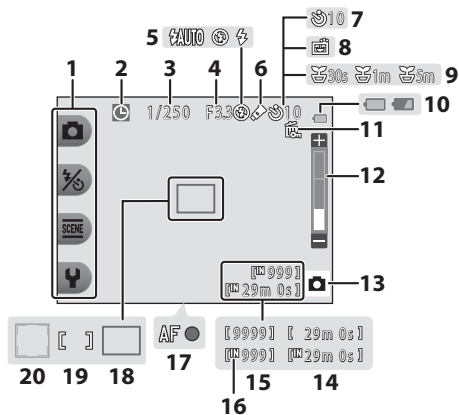

1	Flexible icons.....	5	11	Image lock icon.....	20
2	"Date not set" indicator.....	108	12	Zoom indicator.....	16
3	Shutter speed.....	15	13	Shooting mode.....	22, 26
4	Aperture value.....	15	14	Remaining movie recording time.....	75
5	Flash mode.....	23	15	Number of exposures remaining (still images).....	13, 36
6	Change colors icon.....	33	16	Internal memory indicator.....	13
7	Self-timer indicator.....	24	17	Focus indicator.....	14
8	Smile timer.....	25	18	Focus area (target finding AF).....	22
9	Shoot at intervals icon.....	28	19	Focus area (center).....	14
10	Battery level indicator.....	13	20	Focus area (face detection).....	38

Playback Mode

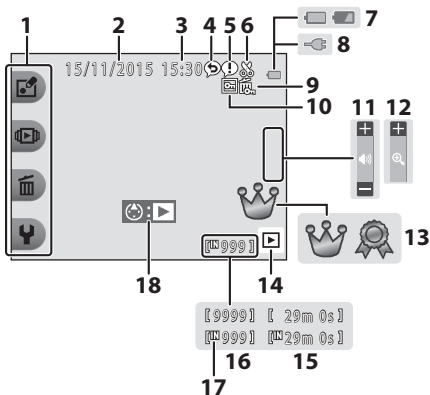

1	Flexible icons.....	5	11	Volume indicator	78
2	Date of recording		12	Switch to full-frame.....	44
3	Time of recording		13	Grade mark (when Variety menu is set to On).....	58
4	Message (reply).....	47	14	Playback mode	17
5	Message	46	15	Movie/message recording time	
6	Crop indicator.....	43	16	Current image number	
7	Battery level indicator.....	13	17	Internal memory indicator	
8	Charging AC Adapter connection indicator		18	Movie playback indicator	75
9	Image lock icon	20			
10	Favorites (when Variety menu is set to Off).....	62			

If Information Is Not Displayed During Shooting Mode and Playback Mode

Apart from certain information, information is not displayed if no operations are performed for several seconds. Information is displayed again when either a flexible button or the multi selector is pressed.

Using the Flexible Buttons

If you press a flexible button while the shooting screen or playback screen is displayed, the menu for the current mode is displayed. Once the menu is displayed, you can change various settings.

In this document, the flexible buttons are referred to as “flexible button 1” through “flexible button 4”, in order from top to bottom.

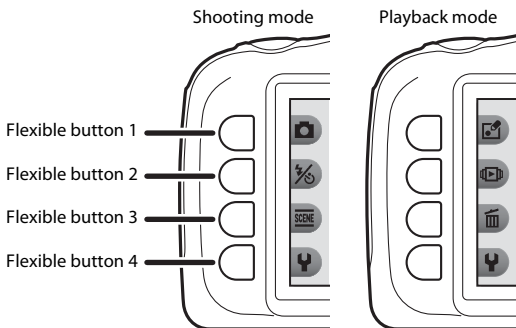

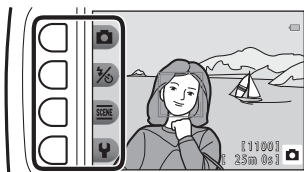

1 Press a flexible button.

- The menu is displayed.



2 Press a flexible button to select an item.

- When  is displayed, press flexible button 1 () to return to the previous screen.
- Certain menu options cannot be selected or displayed depending on the camera's settings.

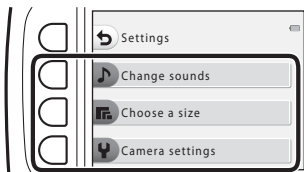

3 Press a flexible button to select an item.

- When the menu content continues on another page, a guide indicating the page position is displayed.

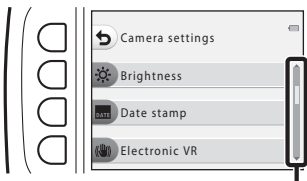

Use the multi selector ▲▼ to display other pages.

4 Press a flexible button to select a setting.

- Press the flexible button to confirm the selected setting.
- When a menu is displayed, you can switch to shooting mode by pressing the ▶ button, shutter-release button, or ● (P/A) button.

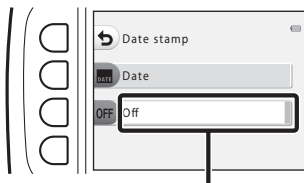

The current setting is displayed in white.

Preparing for Shooting

Insert the Battery and Memory Card

- 1 Open the battery-chamber/memory card slot cover, and then insert the battery and memory card.

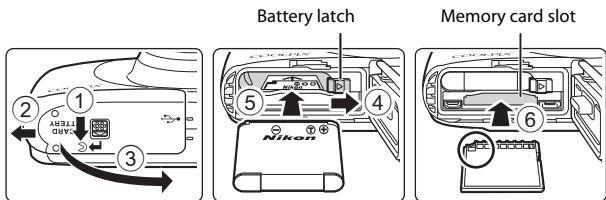

- With the battery's positive and negative terminals oriented correctly, move the orange battery latch (4), and fully insert the battery (5).
- Slide the memory card in until it clicks into place (6).
- Be careful not to insert the battery or memory card upside-down or backward, as this could cause a malfunction.

- 2 Close the battery-chamber/memory card slot cover.

- Lay the cover completely flat in the direction indicated by the arrow (1), and fully slide it in (2).

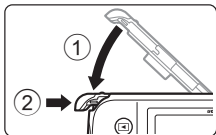

Damage Caution

Sliding the cover while it is open may damage the camera.



-  **Opening and Closing the Battery-chamber/Memory Card Slot Cover**

Do not open and close the battery chamber/memory card slot cover in a sandy or dusty environment or with wet hands. If the cover is closed without removing foreign particles, water may seep inside the camera or the camera may become damaged.

- If foreign particles get inside the cover or camera, immediately remove them with a blower or brush.
- If liquid such as water gets inside the cover or camera, immediately wipe it off with a soft and dry cloth.

Formatting a Memory Card

The first time you insert a memory card that has been used in another device into this camera, make sure to format it with this camera. Insert the memory card into the camera and select **Format card** in the camera settings menu (📖85).

Removing the Battery or Memory Card

Turn the camera off and make sure that the power-on lamp and monitor have turned off, and then open the battery-chamber/memory card slot cover.

- Move the battery latch to eject the battery.
- Gently push the memory card into the camera to partially eject the memory card.
- Be careful when handling the camera, battery, and memory card immediately after using the camera, as they may become hot.

Memory Cards and Internal Memory

Camera data, including images and movies, can be saved either on a memory card or in the camera's internal memory. To use the camera's internal memory, remove the memory card.

Charge the Battery

- 1 With the battery installed, connect the camera to an electrical outlet.

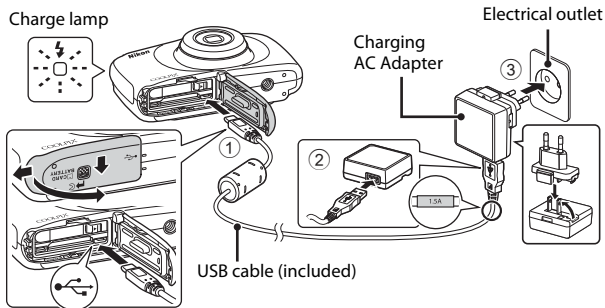

If a plug adapter* is included with your camera, securely connect it to the Charging AC Adapter. Once the two are connected, attempting to forcibly remove the plug adapter could damage the product.

- * The shape of the plug adapter varies according to the country or region in which the camera was purchased. This step can be omitted if the plug adapter comes permanently bonded to the Charging AC Adapter.
- The charge lamp slowly flashes green to indicate that the battery is charging.
- When charging is complete, the charge lamp turns off. It takes about 1 hour and 40 minutes to charge a fully exhausted battery.
- The battery cannot be charged when the charge lamp quickly flashes green, possibly due to one of the reasons described below.
 - The ambient temperature is not suited to charging.
 - The USB cable or Charging AC Adapter is not properly connected.
 - The battery is damaged.

- 2 Disconnect the Charging AC Adapter from the electrical outlet and then disconnect the USB cable.

Notes About the USB Cable

- Do not use a USB cable other than the UC-E21. Using a USB cable other than the UC-E21 could result in overheating, fire or electric shock.
- Make sure that the plugs are properly oriented. Do not insert or remove the plugs at an angle when connecting or disconnecting them.

Notes About Charging the Battery

- The camera can be operated while the battery is charging, but the charging time increases.
- If the battery level is extremely low, you may not be able to operate the camera while the battery is charging.
- Do not, under any circumstances, use another make or model of AC adapter other than Charging AC Adapter EH-71P, and do not use a commercially available USB-AC adapter or a battery charger for a mobile phone. Failure to observe this precaution could result in overheating or in damage to the camera.

Charging Using a Computer or Battery Charger

- You can also charge the battery by connecting the camera to a computer.
- You can use the Battery Charger MH-66 (available separately) to charge the battery without using the camera.

Turn the Camera On and Set the Display Language, Date, and Time

When the camera is turned on for the first time, the language-selection screen, and the date and time setting screen for the camera clock are displayed.

1 Press the power switch to turn on the camera.

- The monitor turns on.
- To turn the camera off, press the power switch again.

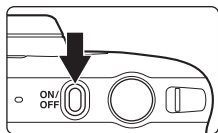

2 Use the multi selector ◀▶ to select the desired language and press flexible button 4 (OK).

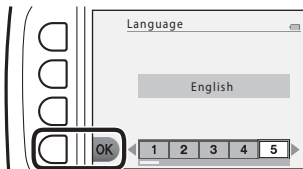

3 Press flexible button 3 (O Yes).

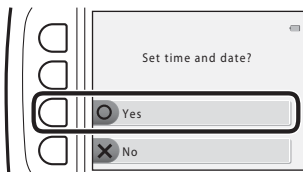

4 Use flexible button 2, 3, or 4 to select the date format.

5 Set the date and time, and press flexible button 4 (OK).

- Use ◀▶ to select a field and then use ▲▼ to set the date and time.
- Select the minute field and press the flexible button 4 (OK) to confirm the setting.
- Press flexible button 3 (☀) to display ☀ in the monitor and enable daylight saving time. To disable daylight saving time, press flexible button 3 (☀) again.

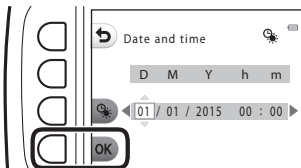

6 When the confirmation dialog is displayed, press flexible button 3 (O Yes).

7 Use ◀▶ to select the background image to be displayed when a menu or setting screen is displayed, and press flexible button 4 (OK).

- The background selection screen may not be displayed depending on your country or region. In this case, proceed to step 8.
- To restore the default background image, press flexible button 3 (RESET).

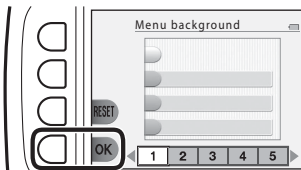

8 Confirm the waterproofing-related message and press ▶.

- There are seven message screens.
- Waterproofing-related messages are displayed in the following situations.
 - When turning on and setting the camera for the first time
 - When setting the camera to **Shoot under water** (📖27) or **Underwater face framing** (📖28)
 - When turning the camera on after charging

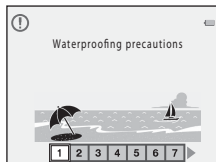

- 9 Confirm the message on the screen shown at right and press flexible button 4 (OK).

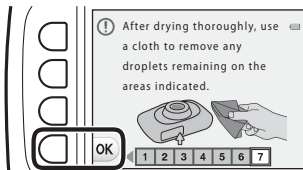

- The shooting screen is displayed, and you can take pictures in Point and shoot.
- Battery level indicator
: The battery level is high.
: The battery level is low.
- Number of exposures remaining is displayed when no memory card is inserted in the camera, and images are saved in the internal memory.

Battery level indicator

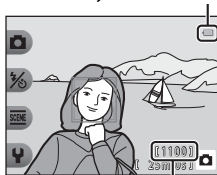

Number of exposures remaining

Changing the Language, the Date and Time, or the Menu Background Setting

- You can change the **Language**, **Date and time**, and **Menu background** settings in the camera settings menu (179).
- You can enable or disable daylight saving time in the camera settings menu by selecting **Date and time**. When enabled, the clock moves forward one hour; when disabled, the clock moves back one hour.

The Clock Battery

- The camera's clock is powered by a built-in backup battery. The backup battery charges when the main battery is inserted into the camera or when the camera is connected to an optional AC adapter, and it can run the clock for several days after about 10 hours of charging.
- If the camera's backup battery becomes exhausted, the date and time setting screen is displayed when the camera is turned on. Set the date and time again (111).

Basic Shooting and Playback Operations

Point and Shoot

1 Hold the camera steady.

- Keep fingers and other objects away from the lens, flash, AF-assist illuminator, microphone, and speaker.

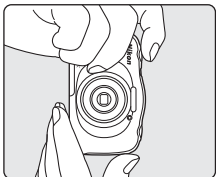
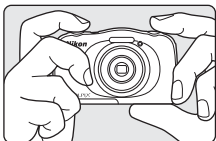

2 Frame the picture.

- Press the multi selector ▲▼ to change the zoom lens position.

Zoom in



Zoom out

3 Press the shutter-release button halfway.

- When the subject is in focus, the focus area or focus indicator is displayed in green.
- When you are using digital zoom, the camera focuses in the center of the frame and the focus area is not displayed.
- If the focus area or focus indicator flashes, the camera is unable to focus. Modify the composition and try pressing the shutter-release button halfway again.

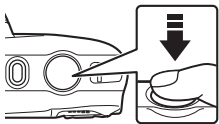

- 4** Without lifting your finger, press the shutter-release button the rest of the way down.



✓ Notes About Saving Images or Movies

The indicator showing the number of exposures remaining or the indicator showing the remaining recording time flashes while images or movies are being saved. **Do not open the battery-chamber/memory card slot cover or remove the battery or memory card** while an indicator is flashing. Doing this could result in loss of data, or in damage to the camera or the memory card.

📎 The Auto Off Function



- When no operations are performed for about three minutes, the monitor turns off, the camera enters standby mode, and then the power-on lamp flashes. The camera turns off after remaining in standby mode for about three minutes.
- To turn the monitor back on while the camera is in standby mode, perform an operation such as pressing the power switch or shutter-release button.

📎 When Using a Tripod

We recommend using a tripod to stabilize the camera in the following situations:

- When shooting in dim lighting with the flash mode (📖23) set to **🔊 Flash off**
- When the zoom is at a telephoto position

The Shutter-release Button

<p>Press halfway</p> 	<p>To set focus and exposure (shutter speed and aperture value), press the shutter-release button lightly until you feel a slight resistance. Focus and exposure remain locked while the shutter-release button is pressed halfway.</p>
<p>Press all the way</p> 	<p>Press the shutter-release button all the way to release the shutter and take a picture. Do not use force when pressing the shutter-release button, as this may result in camera shake and blurred images. Press the button gently.</p>

Using the Zoom

When you press the multi selector ▲▼, the zoom lens position changes.

- To zoom in: Press ▲.
- To zoom out: Press ▼.

When you turn the camera on, the zoom moves to the maximum wide-angle position.

- A zoom indicator is displayed on the shooting screen when the multi selector ▲▼ is pressed.

Telephoto



Wide-angle

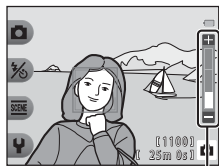

Zoom indicator

- Digital zoom, which allows you to further magnify the subject up to approximately 4x the maximum optical zoom ratio, can be activated by pressing ▲ when the camera is zoomed in to the maximum optical zoom position.

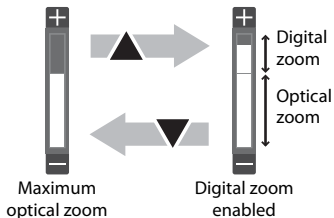



Digital Zoom

The zoom indicator changes to blue when the digital zoom is activated, and it changes to yellow when the zoom magnification is increased further.

- Zoom indicator is blue: Image quality is not noticeably reduced by using the Dynamic Fine Zoom.
- Zoom indicator is yellow: There may be cases in which image quality is noticeably reduced.
- The indicator remains blue across a wider area when the image size is smaller.



Play Back Images

- 1** Press the  (shooting/playback mode) button to enter playback mode.

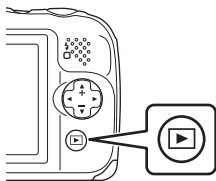
- If you press and hold down the  button while the camera is turned off, the camera turns on in playback mode.



- 2** Use the multi selector to select an image to display.

- Press and hold down  to scroll through the images quickly.
- To return to shooting mode, press the  button or shutter-release button.

Display the previous image



Display the next image

- Press  in full-frame playback mode to zoom in on an image.

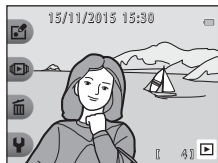

- Press  to zoom in on an image.



- In full-frame playback mode, press  to switch to thumbnail playback mode and display multiple images on the screen.



Delete Images

- 1 Press flexible button 3 (🗑️) to delete the image currently displayed in the monitor.

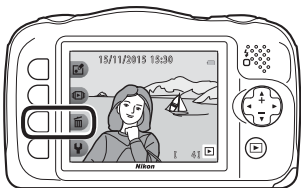

- 2 Use flexible button 2, 3, or 4 to select the desired deletion method.

- To exit without deleting, press flexible button 1 (↩).

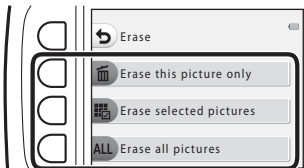

- 3 Press flexible button 3 (○ Yes).

- Deleted images cannot be recovered.

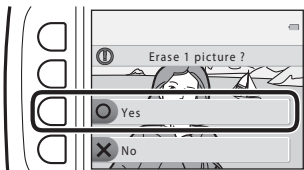

Selecting Which Images You Want to Delete

- 1** Use the multi selector ◀▶ to select an image to be deleted, and then press flexible button 2 (✔).

- The selected image is indicated by a check mark.
- A check mark is displayed or removed every time you press flexible button 2 (✔).
- Press flexible button 3 (**RESET**) to remove all check marks.

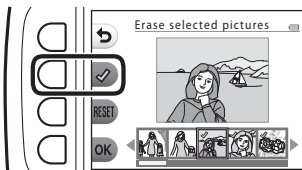

- 2** Add check marks to all images that you want to delete and then press flexible button 4 (**OK**) to confirm the selection.

- A confirmation dialog is displayed. Follow the on-screen instructions to complete operations.

Restrict Image Deletion (Image Lock)

To prevent accidental deletion of images, you can lock image deletion (📖18) and formatting (📖85).

- 1 Press and hold down flexible buttons 1 and 4 at the same time while in shooting mode or playback mode.

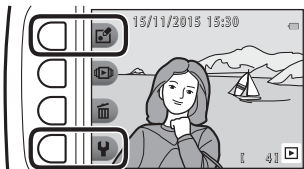

- 2 Press flexible button 3 (O Yes).

- Image lock is set.

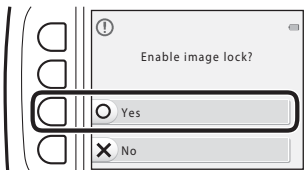

- When image lock is set, 📖 is displayed in the monitor.

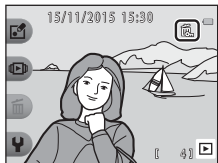









Removing Image Lock

The procedure for removing image lock is the same as for setting image lock.

Shooting Features

Functions Available in Shooting Mode (Shooting Menu)

Press a flexible button to display a menu. You can change the following settings.

Flexible button	Option	Description	
 Point and shoot	–	Sets the shooting mode to  Point and shoot.	22
 Flash mode/ self-timer	Flash	You can select a flash mode to match the shooting conditions.	23
	Self-timer	The camera is equipped with a self-timer that releases the shutter 10 seconds after you press the shutter-release button. You can also set the smile timer.	24, 25
 More picture options	Choose a style	When a style (shooting scenes and effects) is selected, camera settings are automatically optimized for the selected scene.	26
	Decorate	Allows you to add a frame around your images when taking pictures.	32
	Change colors	Allows you to select  Brighter/darker or  More vivid/less vivid from the menu, or use  Highlight colors to keep one specified color in the image, and change the other colors to black and white.	33
 Settings	Change sounds	Allows you to configure the shutter and button sounds.	34
	Choose a size	Allows you to set the size of still images and movies.	36
	Camera settings	Allows you to change a number of general settings.	79

Point and Shoot

When this camera is used for the first time, the shooting mode is set to  Point and shoot. The camera automatically selects the optimum scene when you frame a picture, making it even easier to take pictures using settings that suit the scene.

 Point and shoot is the default shooting mode for this camera.

- When the camera detects the main subject, it focuses on that subject (target finding AF).
- The flash may fire when shooting in low light.
- When shooting in low light, the use of a tripod is recommended.
- The camera does not detect the scene when the digital zoom is being used.

Using Target Finding AF

The camera focuses in the manner described below when you press the shutter-release button halfway.

- The camera detects the main subject and focuses on it. When the subject is in focus, the focus area is displayed in green. If a human face is detected, the camera automatically sets focus priority on it.

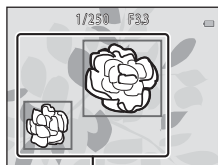

Focus areas

- If no main subject is detected, the camera focuses on the area in the center of the frame.

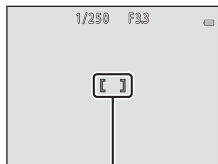

Focus area

Notes About Target Finding AF

- Depending on shooting conditions, the subject that the camera determines to be the main subject may vary.
- The camera may not detect the main subject appropriately in the following situations:
 - When the subject is very dark or bright
 - When the main subject lacks clearly defined colors
 - When the shot is framed so that the main subject is at the edge of the monitor
 - When the main subject is composed of a repeating pattern

Flash Mode

You can select a flash mode to match the shooting conditions.

Enter shooting mode → flexible button 2 (📷) → flexible button 2 (⚡ Flash)

Available Flash Modes

⚡AUTO Auto flash

The flash fires when necessary, such as in dim lighting.

📷 Flash off

The flash does not fire.

- We recommend using a tripod to stabilize the camera when shooting in dark surroundings.

⚡ Always fire flash

The flash fires whenever a picture is taken. Use to “fill-in” (illuminate) shadows and backlit subjects.

Use flexible button 2, 3, or 4 to select the flash mode.

- To cancel, press flexible button 1 (🏠).

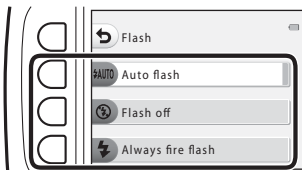

The Flash Lamp

- The status of the flash can be confirmed by pressing the shutter-release button halfway.
 - On: The flash fires when you press the shutter-release button all the way down.
 - Flashing: The flash is charging. The camera cannot shoot images.
 - Off: The flash does not fire when a picture is taken.
- If the battery level is low, the monitor turns off while the flash is charging.

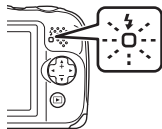

The Flash Mode Setting

- The setting may not be changed when using some shooting modes or settings.
- The setting applied in 📷 Point and shoot is saved in the camera's memory even after the camera is turned off.

Self-timer

The camera is equipped with a self-timer that releases the shutter 10 seconds after you press the shutter-release button.

Enter shooting mode → flexible button 2 (1/2) → flexible button 3 (Self-timer)

1 Press flexible button 2 (10s 10 s).

- When  **Smile timer** is selected, the camera uses face detection to detect a human face, and then automatically releases the shutter when a smile is detected (125).

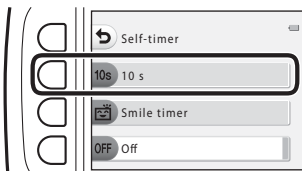

2 Frame the picture and press the shutter-release button halfway.

- Focus and exposure are set.

3 Press the shutter-release button the rest of the way down.

- Countdown starts. The self-timer lamp flashes and then glows steadily about one second before the shutter is released.
- When the shutter is released, the self-timer is set to **OFF off**.
- To stop the countdown, press the shutter-release button again.



Smile Timer

When the camera detects a smiling face, you can take a picture automatically without pressing the shutter-release button. The skin softening function makes the skin tones of human faces smoother.

Enter shooting mode → flexible button 2 (⌘) → flexible button 3 (⌘ Self-timer)

- 1 Press flexible button 3 (⌘ Smile timer).



- 2 Frame the picture.
 - Point the camera at a human face.
- 3 Without pressing the shutter-release button, wait for the subject to smile.
 - If the camera detects that the face framed by the double border is smiling, the shutter is automatically released.
 - Whenever the camera detects a smiling face, it automatically releases the shutter.
- 4 End automatic shooting.
 - To end automatic shooting, set the self-timer to **OFF off**.

✓ Notes About Smile Timer

Under some shooting conditions, the camera may be unable to detect faces or smiles (ⓘ38). The shutter-release button can also be used for shooting.

📎 When the Self-timer Lamp Flashes

When using **Smile timer**, the self-timer lamp flashes when the camera detects a face and flashes quickly immediately after the shutter is released.

Choose a Style (Shooting Suited to Scenes and Effects)

When a style (shooting scene and effect) is selected, camera settings are automatically optimized for the selected scene. The expected effect may not be achieved depending on the subject.

Enter shooting mode → flexible button 3 (SCENE) → flexible button 2 (SCENE Choose a style)

Use the multi selector ◀▶ to select the desired style (shooting scene and effect) and press flexible button 4 (OK).

- To cancel, press flexible button 1 (↶).

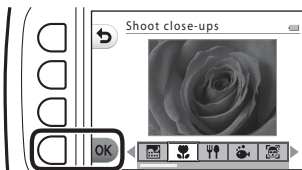

Shoot night scenes¹ (📖27)
(default setting)

Shoot close-ups^{2,3} (📖27)

Photograph food² (📖27)

Shoot under water^{2,3} (📖27)

Underwater face framing³ (📖28)

Shoot at intervals⁴ (📖28)

Take a series of pictures (📖29)

Photograph fireworks^{1,5} (📖29)

Shoot backlit scenes⁶ (📖29)

Mirror^{2,3} (📖30)

Add a bubble effect^{2,3} (📖30)

Add a neon effect^{2,3} (📖30)

Add a cartoon effect^{2,3} (📖30)

Take soft pictures^{2,3} (📖31)

Create a diorama effect^{2,3} (📖31)

Shoot a movie miniature^{2,4} (📖31)

¹ The camera focuses at infinity.

² The camera focuses on the area in the center of the frame. When the zoom is set to a position where the zoom indicator turns green, the camera can focus on subjects as close as about 20 cm (8 in.) from the front of the protective glass, or about 5 cm (2 in.) at the maximum wide-angle position.

³ The flash may be unable to light the entire subject at distances of less than 30 cm (1 ft).



⁴ Use of a tripod is recommended.

⁵ Use of a tripod is recommended, because the shutter speed is slow.



⁶ The camera focuses on the area in the center of the frame.

Tips and Notes



Shoot night scenes

- When the shutter-release button is pressed all the way, the camera captures a series of images which are combined into a single image and saved.
- Once the shutter-release button is pressed all the way, hold the camera still until a still image is displayed. After taking a picture, do not turn the camera off before the monitor switches to the shooting screen.
- The angle of view (i.e., the area visible in the frame) seen in the saved image is narrower than that seen in the monitor at the time of shooting.
- The flash setting is fixed at  **Flash off** (📖23).
-  **Smile timer** is not available (📖25).



Shoot close-ups

- The camera automatically zooms to the closest position at which it can focus.
- The flash is set to  **Flash off**, but the setting can be changed (📖23).
-  **Smile timer** is not available (📖25).





Photograph food

- The camera automatically zooms to the closest position at which it can focus.
- Use the multi selector  to adjust the hue setting and press flexible button 4 (**OK**). The hue setting is saved in the camera's memory even after the camera is turned off.
- The flash setting is fixed at  **Flash off** (📖23).
-  **Smile timer** is not available (📖25).





Shoot under water

- When **Shoot under water** is set, the waterproofing-related messages are displayed. Confirm each message and press the multi selector  to display the next message. Press flexible button 4 (**OK**) to skip the messages and change to the shooting screen.
- See "<Important> Shockproof, Waterproof, Dustproof, Condensation" (📖x-xv) for more information about using the camera underwater.
- The flash is set to  **Flash off**, but the setting can be changed (📖23).
-  **Smile timer** is not available (📖25).

Underwater face framing

- You can take pictures of human faces underwater automatically without submerging your face.
- When **Underwater face framing** is set, the waterproofing-related messages are displayed.
Confirm each message and press the multi selector  to display the next message. Press flexible button 4 (**OK**) to skip the messages and change to the shooting screen.
- See “<Important> Shockproof, Waterproof, Dustproof, Condensation” (x-xv) for more information about using the camera underwater.
- When the shutter-release button is pressed all the way while the shooting screen is displayed, automatic shooting begins. Submerge the camera into the water, and point it at a human face underwater. When the camera detects a human face, the power-on lamp and self-timer lamp flash, and the shutter is automatically released. When the shutter is released, the lamps flash quickly.
- Press the shutter-release button all the way again to stop shooting. When four images are captured or the camera remains in automatic shooting mode for about 30 seconds, shooting ends automatically.
- When shooting ends, the captured images are displayed in the monitor. Press flexible button 4 (**OK**) to return to the shooting screen.
- The zoom position is fixed at wide-angle position.
- The flash is set to  **Flash off**, but the setting can be changed (23).
- The self-timer is not available (24).
- The camera may not be able to detect faces depending on the clarity of the water or the shape of the goggles used.

Shoot at intervals

- The camera can automatically capture still images at pre-determined intervals. Images captured in one shooting are saved in one folder and can be viewed in a slide show (67).
- Press flexible button 2 (**30s Shoot every 30 seconds**), flexible button 3 (**1m Shoot once a minute**), or flexible button 4 (**5m Shoot every 5 minutes**) to set the shooting interval.
- The maximum number of images that can be captured depends on the selected interval.
 - **Shoot every 30 seconds**: Approx. 280 images
 - **Shoot once a minute**: Approx. 140 images
 - **Shoot every 5 minutes**: Approx. 30 images
- Use a sufficiently charged battery to prevent the camera from turning off during shooting.
- Press the shutter-release button all the way down to capture the first image. In between each shot, the monitor turns off and the power-on lamp flashes. The monitor automatically turns on again just before the next image is captured.
- Press the shutter-release button halfway to stop shooting.
- The flash is set to  **AUTO Auto flash**, but the setting can be changed (23).
- The self-timer is not available (24).



Take a series of pictures

- While the shutter-release button is held all the way down, the camera shoots up to 11 images continuously at a rate of about 4.7 frames per second (fps) (when **Choose a size > Photo size** is set to **Large (13 megapixels)**).
- The frame rate for continuous shooting may vary depending on the current photo size setting, the memory card used, or shooting condition.
- Focus, exposure, and hue are fixed at the values determined with the first image in each series.
- The flash setting is fixed at  **Flash off** (📖23).
- The self-timer is not available (📖24).



Photograph fireworks



- The shutter speed is fixed at four seconds.
- The flash setting is fixed at  **Flash off** (📖23).
- The self-timer is not available (📖24).





Shoot backlit scenes

- When taking pictures with very bright and dark areas in the same frame, such as backlit scenes, the high dynamic range (HDR) compositing is applied and loss of details in highlights or shadows is minimized.
- When the shutter-release button is pressed all the way, the camera shoots images continuously at high speed, and saves the following two images.
 - A non-HDR composite image
 - An HDR composite image in which the loss of details in highlights or shadows is minimized
- If there is only enough memory to save one image, an image processed at the time of shooting, in which dark areas of the image are corrected, is the only image saved.
- Once the shutter-release button is pressed all the way, hold the camera still until a still image is displayed. After taking a picture, do not turn the camera off before the monitor switches to the shooting screen.
- The angle of view (i.e., the area visible in the frame) seen in the saved image is narrower than that seen in the monitor at the time of shooting.
- The flash setting is fixed at  **Flash off** (📖23).
-  **Smile timer** is not available (📖25).





Mirror

- You can take pictures that are vertically or horizontally symmetrical over the center of the frame.
- Press flexible button 2 ( **Top → bottom**) or flexible button 3 ( **Left → right**) to set the flip direction.





When  **Top → bottom** is selected, the top half of the screen is flipped over the bottom half, and the image is composited and displayed. When  **Left → right** is selected, the left half of the screen is flipped over the right half.

- The flash is set to  **AUTO Auto flash**, but the setting can be changed (23).
-  **Smile timer** is not available (25).





Add a bubble effect

- This effect makes the image appear to be projected on a bubble.
- A guide is displayed in the monitor. Compose the shot so that the main subject is contained within the guide.
- The flash is set to  **AUTO Auto flash**, but the setting can be changed (23).
-  **Smile timer** is not available (25).



Add a neon effect

- This effect makes the outlines of the image appear to glow with neon tubing.
- Use the multi selector  to select the outline color and press flexible button 4 (**OK**). The color setting is saved in the camera's memory even after the camera is turned off.
- After taking a picture, do not turn the camera off before the monitor switches to the shooting screen.
- The flash is set to  **AUTO Auto flash**, but the setting can be changed (23).
-  **Smile timer** is not available (25).



Add a cartoon effect

- Performs tone compensation and makes the image appear like a cartoon.
- After taking a picture, do not turn the camera off before the monitor switches to the shooting screen.
- The flash is set to  **AUTO Auto flash**, but the setting can be changed (23).
-  **Smile timer** is not available (25).

Take soft pictures

- Softens the image by adding a slight blur to areas outside of the guide displayed in the monitor.
- A guide is displayed in the monitor. Compose the shot so that the main subject is contained within the guide.
- The flash is set to  **AUTO Auto flash**, but the setting can be changed (📖23).
-  **Smile timer** is not available (📖25).

Create a diorama effect

- This effect is well-suited for images captured from a high vantage point with the main subject in the center of the image.
- A guide is displayed in the monitor. Compose the shot so that the main subject is contained within the guide.
- The flash is set to  **Flash off**, but the setting can be changed (📖23).
-  **Smile timer** is not available (📖25).

Shoot a movie miniature

- Captures miniature-like still images every two seconds and joins the still images to create a movie with a maximum length of 10 seconds.
- This effect is well-suited for images captured from a high vantage point with the main subject in the center of the image.
- You cannot shoot when a memory card is not inserted. Do not replace the memory card until shooting ends.
- Use a sufficiently charged battery to prevent the camera from turning off during shooting.
- Compose the shot so that the main subject is contained in the guide displayed in the monitor.
- Press the shutter-release button to capture the first image. Focus, exposure, and hue are fixed at the values determined with the first image.
- The camera releases the shutter automatically after the first image.
- The monitor may turn off in between each shot.
- To end shooting, press flexible button 1 (). When 300 images are captured, shooting ends automatically.
- Sound and still images are not recorded.
- The movie frame size is fixed at  **Large (1080p)**.
- The flash setting is fixed at  **Flash off** (📖23).
-  **Smile timer** is not available (📖25).

Decorate

You can add a frame around your images when taking pictures. Nine different frames are available.

Enter shooting mode → flexible button 3 (SCENE) → flexible button 3 (Decorate)

- The **FR** Choose a size > **Photo size** setting is fixed at **Small (2 megapixels)** (36).

1 Use the multi selector **◀▶** to select the desired frame and press flexible button 4 (**OK**).

- To cancel, press flexible button 1 (↶).
- You can press flexible button 3 (✖) to remove the frame.

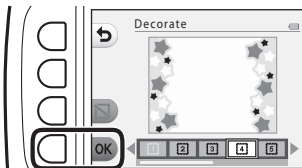

2 Frame the subject and take a picture.

✓ Notes About Decorate

- The area that is captured becomes smaller when a thicker frame is selected.
- When using borderless printing to print images that you have added frames to, the frames may not be printed.

Change Colors

You can adjust brightness (exposure compensation) and vividness when taking pictures. You can also select one color to keep in your images and turn the rest of the colors to shades of black and white.

Enter shooting mode → flexible button 3 (SCENE) → flexible button 4 (Change colors)

1 Use flexible button 2, 3, or 4 to select the setting.

- Select **Brighter/darker**, **More vivid/less vivid**, or **Highlight colors**.

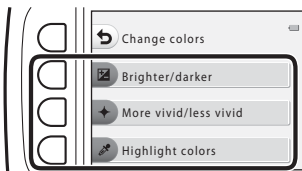

2 Use the multi selector to change colors and press flexible button 4 (OK).

- **Brighter/darker** (exposure compensation):
Adjust the overall image brightness.
- **More vivid/less vivid** (saturation):
Adjust the overall image vividness.
- **Highlight colors**:
Select the color you want to highlight. Colors not selected are changed to black and white.
- Press flexible button 3 (RESET) to turn the effect off.
- To cancel, press flexible button 1 (Back).

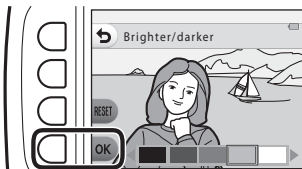

3 Frame the subject and take a picture.

Change Colors

- The setting is saved in the camera's memory even after the camera is turned off.
- Images adjusted with **Change colors** are indicated by .



Change Sounds

Allows you to configure the shutter and button sounds. You can select one of eight different sounds, or turn sounds off.

Enter shooting mode → flexible button 4 (F) → flexible button 2 (M Change sounds)

Pick a shutter sound

Allows you to select the sound heard when the shutter is released and when the focus has been locked.

When using **Take a series of pictures** (📖29) or when recording movies, the shutter sound is not heard.

Pick a button sound



Allows you to select the beep heard when the camera switches between shooting and playback modes, when using the menus, etc.

- Regardless of this setting, sounds that are heard when an error occurs and when the camera is turned on do not change.

Turn sounds on or off



Turn all sounds on or off.

1 Press flexible button 2 or flexible button 3.

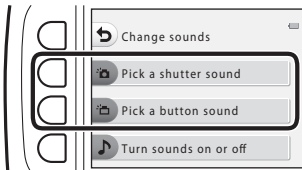
-  **Pick a shutter sound:** Set the shutter sound.
-  **Pick a button sound:** Set the button sound.



2 Use the multi selector ◀▶ to select the type of sound.

- : Set the standard sounds.
- : Sounds are not heard.
- Press flexible button 3 (▶) to play the selected sound.
- To cancel, press flexible button 1 (◀).

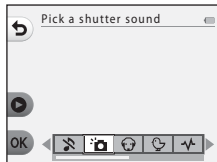

3 Press flexible button 4 (OK).

- The sound is set.

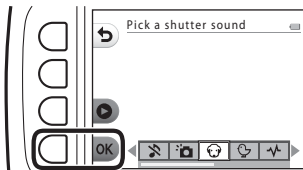

Muting All Sounds

On the screen displayed in step 1, press flexible button 4 (**Turn sounds on or off**) → flexible button 3 (**Turn sounds off**), in that order, to mute all sounds.

To cancel the mute, press flexible button 4 (**Turn sounds on or off**) → flexible button 2 (**Turn sounds on**), in that order.

Choose a Size

Set the size of still images and movies.

Choose a Photo Size

Select the combination of image size and compression ratio to be used when saving images. The higher the image mode setting, the larger the size at which it can be printed, and the lower the compression ratio, the higher the quality of the images, but the number of images that can be saved is reduced.

Enter shooting mode* → flexible button 4 (⏏) → flexible button 3 (📷 Choose a size) → flexible button 2 (📷 Photo size)

* The changed setting is also applied to **Choose a style** and **Change colors**.

Option*	Size* (pixels)	Compression ratio	Aspect ratio (horizontal to vertical)
■ Large (13 megapixels) (default setting)	4160 × 3120	Approx. 1:4	4:3
■ Medium (4 megapixels)	2272 × 1704	Approx. 1:8	4:3
■ Small (2 megapixels)	1600 × 1200	Approx. 1:8	4:3

* The numerical values indicate the number of pixels that are captured.
Example: ■ **Large (13 megapixels)** = approx. 13 megapixels, 4160 × 3120 pixels



Notes About Photo Size

This function may not be available to use in combination with other functions (📖41).





Number of Images That Can Be Saved



- The approximate number of images that can be saved can be checked in the monitor when shooting (📖13).
- Note that due to JPEG compression, the number of images that can be saved may vary greatly depending on the image content, even when using memory cards with the same capacity and the same photo size setting. In addition, the number of images that can be saved may vary depending on the make of the memory card.
- If the number of exposures remaining is 10,000 or more, the number of exposures remaining display shows "9999".

Choose a Movie Frame Size

Select the desired movie option to record.

Enter shooting mode → flexible button 4 (👤) → flexible button 3 (📷 Choose a size) → flexible button 3 (🎬 Movie frame size)

Option	Image size	Aspect ratio (horizontal to vertical)	Frame rate
 Large (1080p) (default setting ¹)	1920 × 1080	16:9	Approx. 30 fps
 Small (640)	640 × 480	4:3	Approx. 30 fps
 Small (old-fashioned) ²	640 × 480	4:3	Approx. 15 fps

¹ When using the camera's internal memory, you can select  **Small (640)** or  **Small (old-fashioned)**.

² Allows you to record movies with an atmosphere and hue similar to movies shot on old 8mm film.

Focusing

The focus area varies depending on the shooting mode and settings.

Using Face Detection

In the following shooting modes and settings, the camera uses face detection to automatically focus on human faces.

-  Point and shoot (📖22)
- **Underwater face framing** (📖28), **Shoot at intervals** (📖28), and **Take a series of pictures** (📖29) when using **Choose a style**
- **Smile timer** (📖25)



If the camera detects more than one face, a double border is displayed around the face that the camera focuses on, and single borders are displayed around the other faces.

If no faces are detected when the shutter-release button is pressed halfway:

- In  Point and shoot, the focus area changes depending on the composition and subject.
- In **Shoot at intervals**, **Take a series of pictures**, or **Smile timer**, the camera focuses in the center of the frame.

Notes About Face Detection

- The camera's ability to detect faces depends on a variety of factors, including the direction in which the faces are looking.
- The camera cannot detect faces in the following situations:
 - When faces are partially hidden by sunglasses or otherwise obstructed
 - When faces take up too much or too little of the frame

Using Skin Softening

When the shutter is released while using the settings listed below, the camera detects human faces and processes the image to soften facial skin tones (up to three faces).

- **Smile timer** (📖25)

Editing functions such as **Make skin prettier** in **Add makeup** can be applied to saved images (📖50) even after shooting.

Notes About Skin Softening

- It may take more time than usual to save images after shooting.
- Under some shooting conditions, the desired skin softening results may not be achieved, and skin softening may be applied to areas of the image where there are no faces.

Subjects Not Suitable for Autofocus

The camera may not focus as expected in the following situations. In rare cases, the subject may not be in focus despite the fact that the focus area or the focus indicator is displayed in green:

- Subject is very dark
- Objects of sharply differing brightness are included in the scene (e.g. the sun behind the subject makes that subject appear very dark)
- No contrast between the subject and surroundings (e.g. a portrait subject wearing a white shirt is standing in front of a white wall)
- Several objects are at different distances from the camera (e.g. the subject is inside a cage)
- Subjects with repeating patterns (window blinds, buildings with multiple rows of similarly shaped windows, etc.)
- Subject is moving rapidly

In the situations noted above, try pressing the shutter-release button halfway to refocus several times, or focus on another subject positioned at the same distance from the camera as the actual desired subject, and use focus lock (📖40).

Focus Lock

Focus lock shooting is recommended when the camera does not activate the focus area that contains the desired subject. The following explains how to use focus lock when the focus area is displayed in the center of the frame.

1 Position the subject in the center of the frame and press the shutter-release button halfway.

- The camera focuses on the subject and the focus area is displayed in green.
- Exposure is also locked.

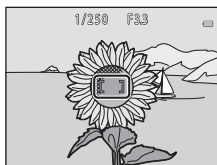

2 Without lifting your finger, recompose the picture.

- Make sure to maintain the same distance between the camera and the subject.

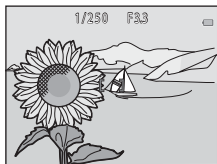

3 Press the shutter-release button the rest of the way down to take the picture.



Functions That Cannot Be Used Simultaneously When Shooting

Some functions cannot be used with other menu options.

Restricted function	Option	Description
Flash	Choose a style (📖26)	When Shoot night scenes , Photograph food , Take a series of pictures , Photograph fireworks , Shoot backlit scenes , or Shoot a movie miniature is selected, the flash cannot be used.
Self-timer	Choose a style (📖26)	When Underwater face framing , Shoot at intervals , Take a series of pictures , or Photograph fireworks is selected, the self-timer cannot be used.
Smile timer	Choose a style (📖26)	When any option in Choose a style is enabled, Smile timer cannot be used.
	Highlight colors (📖33)	When Highlight colors is enabled, Smile timer cannot be used.
Decorate	Smile timer (📖25)	When Smile timer is selected, Decorate cannot be used.
	Choose a style (📖26)	When any option in Choose a style is enabled, Decorate cannot be used.
Change colors	Smile timer (📖25)	When Smile timer is selected, Change colors cannot be used.
	Choose a style (📖26)	When any option in Choose a style is enabled, Change colors cannot be used.
Pick a shutter sound	Take a series of pictures (📖29)	When Take a series of pictures is selected, the shutter sound is disabled.
Choose a size	Choose a style (📖26)	When Shoot a movie miniature is selected, Choose a size cannot be used.
Photo size	Decorate (📖32)	When Decorate is selected, the Photo size setting is fixed at ■ Small (2 megapixels) .
Date stamp	Take a series of pictures (📖29)	When Take a series of pictures or Shoot a movie miniature is selected, the date cannot be stamped on images.

Restricted function	Option	Description
Electronic VR	Choose a style (📖26)	When Shoot night scenes, Shoot at intervals, Take a series of pictures, Photograph fireworks, or Shoot backlit scenes is selected, electronic VR is disabled.
Digital zoom	Smile timer (📖25)	When Smile timer is selected, digital zoom cannot be used.
	Choose a style (📖26)	When Shoot night scenes, Shoot under water, Underwater face framing, Shoot backlit scenes, Take soft pictures, Create a diorama effect, or Shoot a movie miniature is selected, digital zoom cannot be used.

Playback Features

Playback Zoom

Pressing the multi selector ▲ in full-frame playback mode (📖17) zooms in on the image.

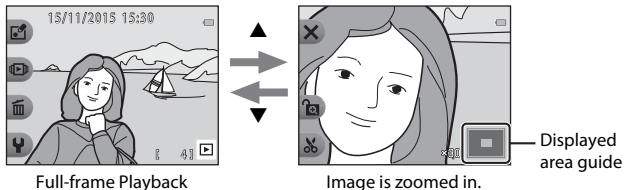

- You can change the magnification rate by pressing ▲▼.
- To view a different area of the image, press flexible button 3 (🔒) to lock the magnification rate and press ▲▼◀▶.
If you want to change the magnification rate, press flexible button 3 (🔒) and then change the magnification rate as desired.
- When a zoomed image is displayed, press flexible button 1 (✕) to return to full-frame playback mode.

✂ Crop: Creating a Cropped Copy

When using playback zoom, you can crop the image and save the displayed area of the image as a separate file by pressing flexible button 4 (✂).

Thumbnail Playback

Press the multi selector ▼ in full-frame playback mode (📖17) to display images in contact sheets of thumbnail images.

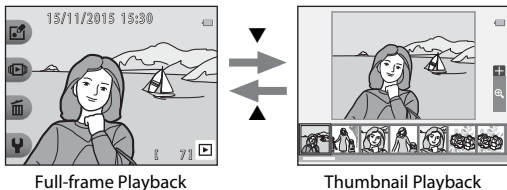

- While using thumbnail playback mode, press ◀▶ to select an image, and the selected image is magnified and displayed at the center of the screen. Select an image and press ▲, and the selected image is displayed in the full-frame playback mode.

Functions Available in Playback Mode (Playback Menu)

When viewing images in full-frame playback mode, you can select one of the flexible buttons (📖5) and display the corresponding menu.

Flexible button	Option	Description	📖
📖 Have fun with pictures	Exchange messages ¹	Allows you to add voice messages to your images.	46
	Picture play ¹	Allows you to edit your images using a variety of functions.	49
	Grading ²	Allows you to add grade marks to your images. You can play back only the images that have grade marks. Protects selected images from accidental deletion.	58
	Favorites ³	Allows you to play back only the images added to favorites. Protects selected images from accidental deletion.	62
📺 View	View by date	Allows you to play back images by selecting the shooting date from the calendar.	66
	Slide show	Allows you to view images in an automated slide show.	67
🗑️ Erase	Erase this picture only	Allows you to delete only the image currently displayed.	18
	Erase selected pictures	Allows you to select multiple images and delete them.	19
	Erase all pictures	Allows you to delete all images.	18
⚙️ Settings	Retouch	Allows you to copy or rotate images or create a small copy of the current image.	71
	Camera settings	Allows you to change a number of general settings.	79

¹ Available when a still image is displayed.



² This function is displayed when **Variety menu** (📖81) is set to **On**.

³ This function is displayed when **Variety menu** (📖81) is set to **Off**.

Exchange Messages

Voice messages can be recorded and attached to images.

- You can attach up to two messages to each image.

Enter playback mode → select an image → flexible button 1 () → flexible button 2 () Exchange messages)

Leave a Message

- 1** Press flexible button 2 ( **Record**).





- 2** Press flexible button 2 ( **Leave a message**).

- You cannot select this option if the image already has a message attached to it. → "Leave a Reply" () 47)



- 3** Press flexible button 2 ().

- Recording starts. You can record for up to about 20 seconds.
- Do not touch the microphone.
- Press flexible button 2 () again to stop recording.
- If battery power runs out, recording stops automatically.
- The message is saved when you press flexible button 4 (**OK**) in step 4. You can re-record the message as long as you do not press flexible button 4.
- Press flexible button 3 () to play back the message.
- Press flexible button 1 () before or after recording a message to return to step 2.

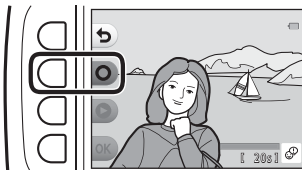

4 Press flexible button 4 (OK).

- **Message recorded.** is displayed and the message is attached to the image.
- Delete the current message before recording a new message (448).

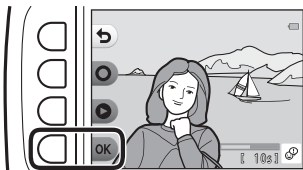

Leave a Reply

1 Press flexible button 2 (Record).



2 Press flexible button 3 (Leave a reply).

- You cannot select this option if the image does not have a message attached to it. → "Leave a Message" (446)

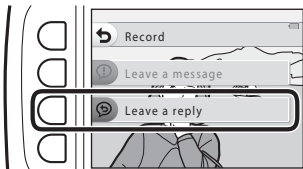

3 Press flexible button 2 (Record).

- Once recording starts, the operations are the same as explained in "Leave a Message" (446).

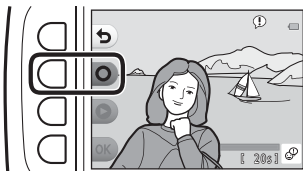

Play Recordings

Press flexible button 3 (▶ **Play recordings**).

- The camera plays the message. If two messages have been recorded, they are played back to back.
- Press flexible button 1 (⏮) to stop playback.
- Use the multi selector ▲▼ during playback to adjust playback volume.
- If battery power runs out, playback stops automatically.

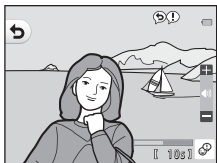

Erase Recordings

1 Press flexible button 4 (🗑️ **Erase recordings**).

- If you select an image that has a grade mark (📖58) or an image that is added to favorites (📖62), a confirmation message is displayed.
 - **○ Yes:** Removes the grade or removes the image from favorites and displays the screen displayed in step 2.
 - **✕ No:** Returns to step 1.

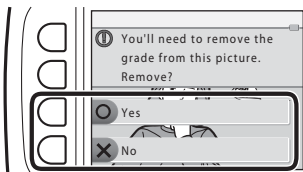

2 When the confirmation message is displayed, press flexible button 3 (○ **Yes**).

- Only the recording is deleted. If both a message and a reply have been recorded, they are both deleted.

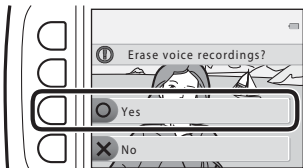

Picture Play

Before Editing Images

You can easily edit images on this camera. Edited copies are saved as separate files (except for **Rotate pictures**).



Edited copies are saved with the same shooting date and time as the original.

Restrictions on Image Editing

- An image can be edited up to 10 times (there is no restriction on the number of times **Rotate pictures** can be applied).
- You may not be able to edit images of a certain size or with certain editing functions.





Add Makeup

Enter playback mode → select an image → flexible button 1 () → flexible button 3 ( Picture play) → use   to select  → flexible button 4 (OK)

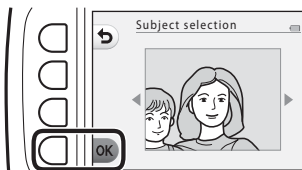







- 1 Use the multi selector    to select the face that you want to retouch and press flexible button 4 (OK).

- When only one face is detected, proceed to step 2.



- 2 Use   to select the effect, use   to select the effect level, and press flexible button 4 (OK).

- You can simultaneously apply multiple effects. Adjust or check the settings for all effects before pressing flexible button 4 (OK).

 **Make faces smaller**,  **Make skin prettier**,  **Color faces**,  **Make skin less shiny**,  **Hide eye bags**,  **Make eyes bigger**,  **Whiten eyes**,  **Add eye shadow**,  **Add mascara**,  **Whiten teeth**,  **Color lips**,  **Redden cheeks**

- Press flexible button 1 () to return to the screen for selecting a person.

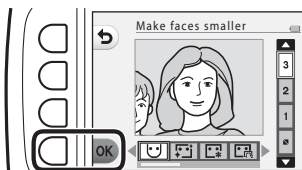

- 3 Preview the result and press flexible button 4 (OK).

- To change the settings, press flexible button 1 () to return to step 2.

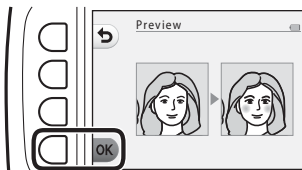

✓ Notes About Add Makeup

- One face can be edited at a time. To add makeup to another face, edit the edited image again.
- Depending on the direction in which faces are looking, or the brightness of faces, the camera may be unable to accurately detect faces, or the function may not perform as expected.
- If no faces are detected, a warning is displayed and the screen returns to the playback menu.
- Only images captured at an image size of 640 × 480 or larger can be edited.

🖼️ Make Photo Albums

Enter playback mode → flexible button 1 (🖼️) → flexible button 3 (🖼️ Picture play) → use ◀▶ to select 🖼️ → flexible button 4 (OK)

Display images similarly to a photo album. Five different photo album designs are available. The created album is saved as a separate image of 2 megapixels (1600 × 1200) in size.

1 Use the multi selector ◀▶ to select an image.



2 Press flexible button 2 (✓).

- A check mark is displayed.
- A check mark is displayed or removed every time you press flexible button 2 (✓).
- Press flexible button 3 (RESET) to remove all check marks.
- Images are arranged in an album in the order the check marks were added.
- Up to 20 images can be selected.

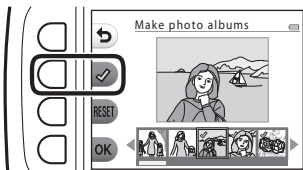

- 3** Press flexible button 4 (OK).

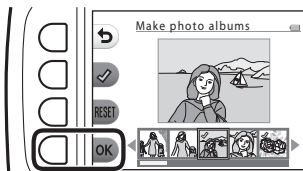

- 4** Use ◀▶ to select the desired photo album design and press flexible button 4 (OK).

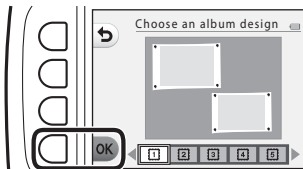

- Photo albums are displayed one page at a time. After all pages have been displayed, the camera returns to **Have fun with pictures** menu.
- To cancel before the photo album has been created, press flexible button 1 (X).

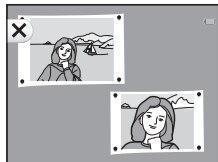

✔ **Notes About Make Photo Albums**

- Movies cannot be selected.
- This camera is unable to select images captured with other cameras.

Add a Fisheye Effect

Enter playback mode → select an image → flexible button 1 (📷) → flexible button 3 (🖼️ Picture play) → use ◀▶ to select  → flexible button 4 (OK)

Make an image look as if it were captured with a fisheye lens. This effect is well-suited for images captured using **Shoot close-ups** in the shooting menu.

Confirm the effect and press flexible button 4 (OK).

- To cancel, press flexible button 1 (📷).

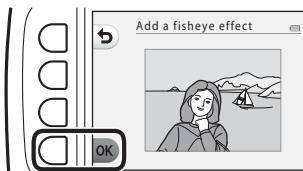

Toy Camera

Enter playback mode → select an image → flexible button 1 (📷) → flexible button 3 (🖼️ Picture play) → use ◀▶ to select  → flexible button 4 (OK)



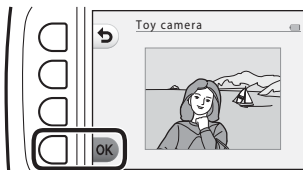

Make an image look as if it were shot with a toy camera. This effect is well-suited for landscapes.

Confirm the effect and press flexible button 4 (OK).

- To cancel, press flexible button 1 (📷).



Soften Pictures

Enter playback mode → select an image → flexible button 1 () → flexible button 3 () → use  to select  → flexible button 4 (**OK**)



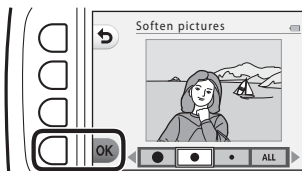

Soften the image by adding a slight blur around the center of the image. Four blur regions are available.

Use the multi selector  to select the area to be blurred and press flexible button 4 (**OK**).

- To add a slight blur to the entire image, press **ALL**.
- To cancel, press flexible button 1 ()



Add Starbursts

Enter playback mode → select an image → flexible button 1 () → flexible button 3 () → use  to select  → flexible button 4 (**OK**)

Produce star-like rays of light that radiate outward from bright objects such as sunlight reflections or street lights. This effect is suitable for night scenes.

Confirm the effect and press flexible button 4 (**OK**).

- To cancel, press flexible button 1 ()

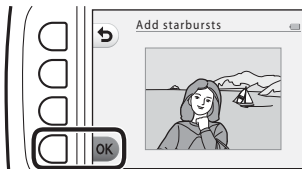

Add a Diorama Effect

Enter playback mode → select an image → flexible button 1 (🖼️) → flexible button 3 (🖼️ Picture play) → use ◀▶ to select  → flexible button 4 (OK)

Make an image look like a miniature scene captured in macro mode. This effect is well-suited for images captured from a high vantage point with the main subject at the center of the image.

Confirm the effect and press flexible button 4 (OK).

- To cancel, press flexible button 1 (🖼️).

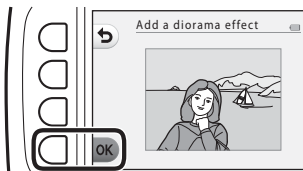

Change Colors

Enter playback mode → select an image → flexible button 1 (🖼️) → flexible button 3 (🖼️ Picture play) → use ◀▶ to select  → flexible button 4 (OK)

Adjust image colors.

Use the multi selector ◀▶ to select the desired setting and press flexible button 4 (OK).

- The following image color settings are available.
 - ① Vivid color (default setting): Use to achieve a vivid, photoprint effect.
 - ② Black-and-white: Save images in black-and-white.
 - ③ Sepia: Save images in sepia tones.
 - ④ Cyanotype: Save images in cyan-blue monochrome.
- To cancel, press flexible button 1 (🖼️).

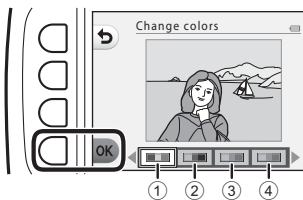

Highlight Colors

Enter playback mode → select an image → flexible button 1 (🖼️) → flexible button 3 (🖼️ Picture play) → use ◀▶ to select 🖋️ → flexible button 4 (OK)

Creates a black and white image in which only the specified color remains.

Use the multi selector ◀▶ to select a color and press flexible button 4 (OK).

- To cancel, press flexible button 1 (🖼️).

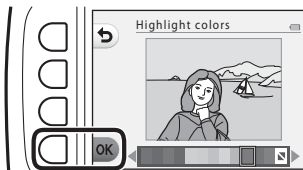

Decorate

Enter playback mode → select an image → flexible button 1 (📄) → flexible button 3 (🖼️ Picture play) → use ◀▶ to select  → flexible button 4 (OK)

Add a frame around your images. Nine different frames are available. The image size of the edited copy varies depending on the size of the original image, as described below.

- When the original image is 2 megapixels (1600 × 1200) or larger, the copy is saved at 2 megapixels (1600 × 1200).
- When the original image is smaller than 2 megapixels (1600 × 1200), the copy is saved at the same size as the original.

Use the multi selector ◀▶ to select the desired frame and press flexible button 4 (OK).

- The frame is added to the image and saved as a new copy.
- To cancel, press flexible button 1 (📄).
- Press flexible button 3 (🖼️) to remove the frame.

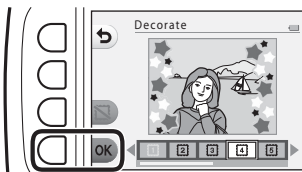





Notes About Decorate

- The frame is placed on top of the image and therefore replaces the area of the image underneath it. Thicker frames cover up a larger area of the image.
- When using borderless printing to print images that you have added frames to, the frames may not be printed.

Grading

This function is displayed when **Variety menu** (81) is set to **On**.



Grade images by using  **Excellent** or  **Good**. You can use **View graded pictures** to play back only the images that have grade marks.

Enter playback mode → flexible button 1 () → flexible button 4 ( Grading)

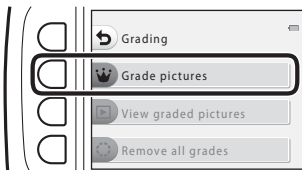

Grade Pictures

- 1 Press flexible button 2 () **Grade pictures**).

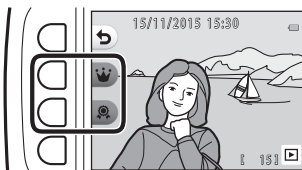

- 2 Use the multi selector  to select an image and press flexible button 2 () or flexible button 3 ()





- Graded images are indicated with grade marks ( or ) on the playback screen, and are protected.
- You cannot add two grade marks to a single image.



Notes About Graded Images

Formatting the memory card or the camera's internal memory (85) permanently deletes all data, including graded images.

Grading

- Graded images are also added to **Favorites** (62). Removing the grade also removes the image from favorites.
- Grade mark  can be added to up to a total of 200 images that includes the images added to favorites. Grade mark  can be added to up to a total of 200 images.

Changing or Removing Grades from Individual Images

- 1** In step 2 (📖58) of “Grade Pictures”, select the image with the grade you want to change or remove.

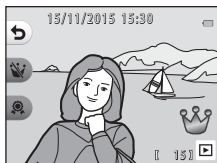

- 2** Change or remove the grade.

- Press flexible button 2 (👑) or flexible button 3 (👑) to change the current grade to the selected grade.
- Press flexible button 2 (👑) or flexible button 3 (🗑️) to remove the grade of the selected image.

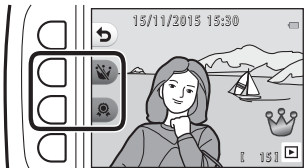

View Graded Pictures

- 1** Press flexible button 3 (▶) **View graded pictures**.

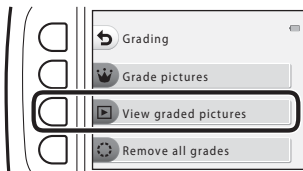

- 2** Press flexible button 2 (👑 **Excellent**) or flexible button 3 (👍 **Good**).

- Only images with the grade mark you selected are displayed.

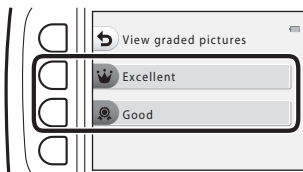

- 3** Use the multi selector ◀▶ to view images.

- Press ▲ to magnify the image.
- Press ▼ to switch to thumbnail playback mode.
- Press flexible button 1 (↶) to return to the screen displayed in step 2.
- Press flexible button 4 (✕) to return to full-frame playback mode (📖17).

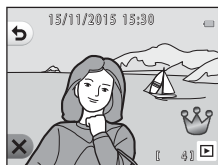

✓ **Notes About View Graded Pictures**

Images cannot be edited, including changing or removing grades, when they are played back using **View graded pictures**.

Remove All Grades

- 1** Press flexible button 4 (🔄 **Remove all grades**).

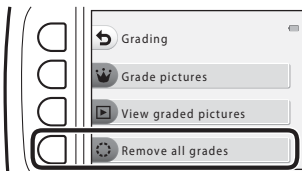

- 2** Press flexible button 2 (👑 **Excellent**) or flexible button 3 (👍 **Good**).

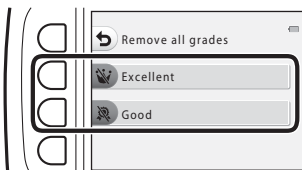

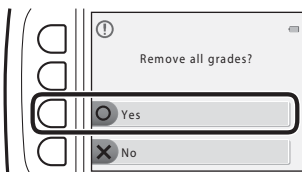

- 3** Press flexible button 3 (○ **Yes**).

- The selected grade mark is removed from all images.



Favorites



This function is displayed when **Variety menu** (81) is set to **Off**. You can use **View favorites** to play back only the images added to favorites.

Enter playback mode → flexible button 1 () → flexible button 4 ( Favorites)

Add to Favorites

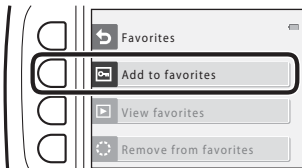
- 1 Press flexible button 2 ( **Add to favorites**).



- 2 Use the multi selector  to select a favorite image and press flexible button 2 ()

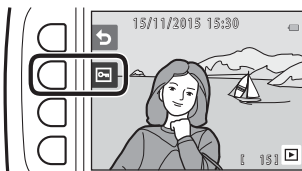



- Images added to favorites are displayed with  on the playback screen, and are protected.



Notes About Images Added to Favorites

Formatting the memory card or the camera's internal memory (85) permanently deletes all data, including graded images.

Favorites

- Grade mark  (58) is added to images that are added to favorites. Removing the image from favorites also removes the grade.
- Up to a total of 200 images can be added to favorites, which includes graded images.

Removing Favorites from Individual Images

- 1** In step 2 (📖62) of “Add to Favorites”, select the image that you want to remove from favorites.

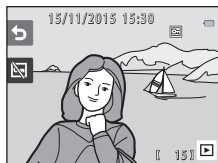

- 2** Press flexible button 2 (📄).

- The selected image is removed from favorites.

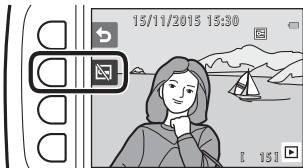

View Favorites

- 1 Press flexible button 3 (▶) **View favorites**).



- 2 Use the multi selector ◀▶ to view images.

- Press ▲ to magnify the image.
- Press ▼ to switch to thumbnail playback mode.
- Press flexible button 1 (↶) to return to the screen displayed in step 1.
- Press flexible button 4 (✕) to return to full-frame playback mode (📖17).

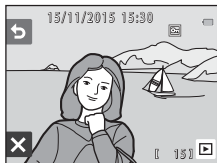

✓ Notes About View Favorites

Images cannot be edited, including removing from favorites, when they are played back using **View favorites**.

Remove From Favorites

- 1 Press flexible button 4 (⊖ Remove from favorites).



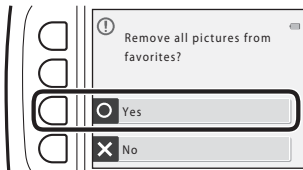

- 2 Press flexible button 3 (○ Yes).
 - All images added to favorites are removed.





View by Date

Play back images by selecting the shooting date from the calendar.



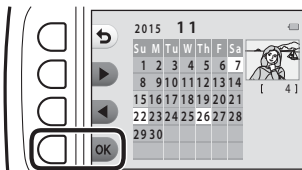

Enter playback mode → flexible button 2 () → flexible button 2 ( View by date)

1 Use the multi selector to select the desired date and press flexible button 4 (OK).

- Images are selected based on the selected date. The first image captured on that date is displayed.
- A white background of a date indicates that images were recorded on that date.
- Press flexible button 2 () to display the next month. Press flexible button 3 () to display the previous month.



2 Use to view images.

- Press  to magnify the image.
- Press  to switch to thumbnail playback mode.
- Press flexible button 1 () to return to the screen displayed in step 1.
- Press flexible button 4 () to return to full-frame playback mode (17).

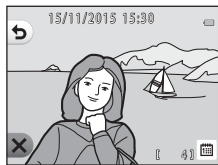



Notes About View by Date

- The 9000 most recent images can be displayed.
- Images captured when the camera's date is not set are treated as images captured on January 1, 2015.
- When movie files are played back, only the first frame of each movie is displayed.
- Images cannot be edited when they are played back using **View by date**.

Slide Show

Play back images one by one in an automated "slide show." When movie files are played back in the slide show, only the first frame of each movie is displayed.

Background music is played during playback. Background music varies depending on the theme selected under  **Choose a theme** (📖70).

Enter playback mode → flexible button 2 () → flexible button 3 ( Slide show)



Choose Pictures

1 Press flexible button 3 () **Choose pictures**).

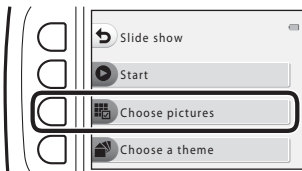
- To play back all images → step 3.



2 Use flexible button 2, 3, or 4 to select the images you want to play back.

-  **View graded pictures/ View favorites:** Only graded images or images added to favorites are played back. Proceed to step 3.
-  **Choose by date:** Only images captured on the same day are played back. Select a date from the calendar, press flexible button 4 (**OK**), and continue from step 3.
-  **Pick a series:** Images captured using **Shoot at intervals** (📖28) are played back consecutively. This option can be selected only when images have been captured using **Shoot at intervals** (📖69).

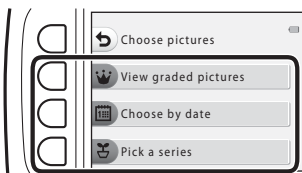

3 Press flexible button 2 (▶) (Start).

- The slide show begins.

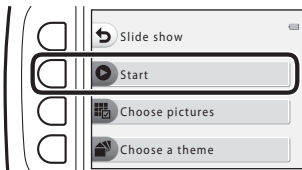

- To pause playback, press flexible button 4 (⏸). To exit, press flexible button 1 (↶).
- While the slide show is in progress, press the multi selector ▶ to display the next image or ◀ to display the previous image. Press and hold ▶ or ◀ to fast forward or rewind.
- Press ▲▼ during playback to adjust the volume of the background music.



4 End or restart the slide show.

- The screen shown on the right is displayed when the slide show is paused.
- ✕: Returns to the screen displayed in step 1.
- ⏸: Displays the next image.
- ⏮: Displays the previous image.
- ▶: Resumes playback.



Pick a Series

1 Press flexible button 2 (**Choose pictures**).

- The first image in the folder where images captured using **Shoot at intervals** are saved is displayed.

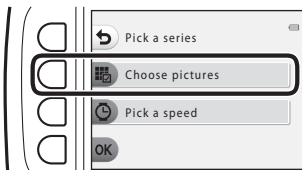

2 Use flexible button 2 (**Next series**) or flexible button 3 (**Previous series**) to select the folder and press flexible button 4 (**OK**).

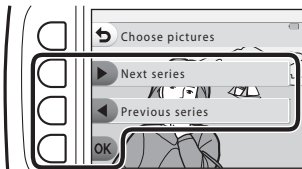

3 Press flexible button 3 (**Pick a speed**).

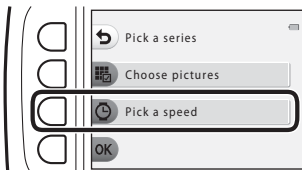

4 Use flexible button 2, 3, or 4 to select a desired speed.

- Select **Fast**, **Normal** (default setting), or **Slow**.

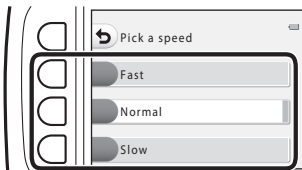

5 Press flexible button 4 (**OK**).

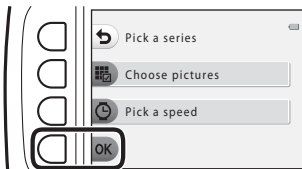

6 Press flexible button 2 (▶ **Start**).

- The slide show begins.

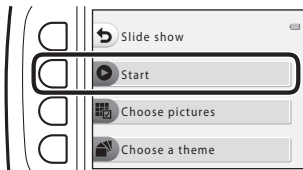

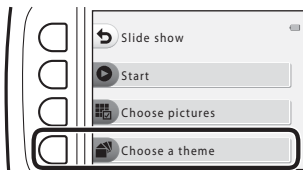

Choose a Theme

1 Press flexible button 4 (🏠 **Choose a theme**).



2 Use flexible button 2, 3, or 4 to select a playback theme.

- You can select  **Animated** (default setting),  **Pop art**, or  **Classic**.

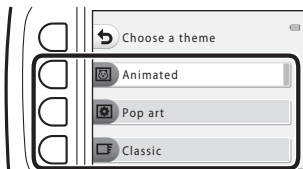

3 Press flexible button 2 (▶ **Start**).

- The slide show begins.

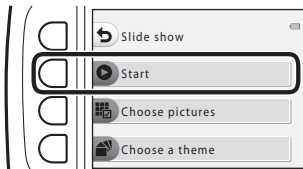

✓ **Notes About Slide Show**

The maximum playback time is up to about 30 minutes.

Retouch

Copy or rotate images or create a small copy of the current image.

Enter playback mode → flexible button 4 (⏪) → flexible button 2 (🔍 Retouch)

Copy

Images can be copied between a memory card and the internal memory.

- When a memory card that contains no images is inserted and the camera is switched to playback mode, **Memory contains no images.** is displayed. In that case, press a flexible button and select flexible button 2 (🔍 **Retouch**) to select **Copy**.

- 1 Press flexible button 2 (🔍 **Copy**).

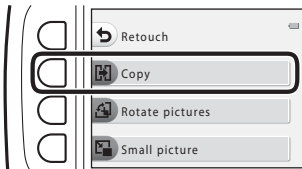

- 2 Use flexible button 2 (📷 **Camera to card**) or flexible button 3 (📷 **Card to camera**) to select the copy source and destination.

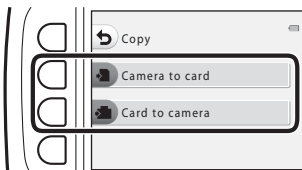

- 3 Use flexible button 2 (🔍 **Selected images**) or flexible button 3 (🔍 **All images**) to select the copy method.
 - When **All images** is selected, proceed to step 6.

4 Use the multi selector ◀▶ to select an image and press flexible button 2 (✔).

- The selected image is indicated by a check mark.
- A check mark is displayed or removed each time you press flexible button 2 (✔).
- Press flexible button 3 (RESET) to remove all check marks.
- Repeat step 4 to select additional images.

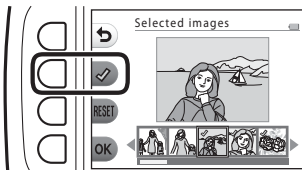

5 Press flexible button 4 (OK) to apply image selection.

- A confirmation dialog is displayed.

6 Press flexible button 3 (O Yes).

- Images are copied.

✔ Notes About Copy

- Only files in formats that this camera can record can be copied.
- Operation is not guaranteed with images captured with another make of camera or that have been modified on a computer.
- The **Grade pictures** (📖58) and **Add to favorites** (📖62) settings configured for images are not copied.

Rotate Pictures

Specify the orientation in which saved images are displayed during playback. Still images can be rotated 90 degrees clockwise or 90 degrees counterclockwise.

- 1** Press flexible button 3 () **Rotate pictures**).

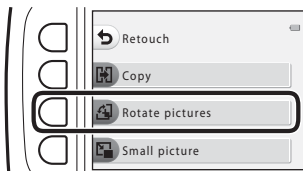

- 2** Press flexible button 2 () or flexible button 3 ()
 - The image is rotated 90 degrees.

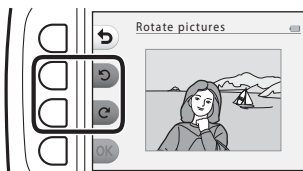

- 3** Press flexible button 4 (**OK**).
 - The displayed orientation is applied, and the orientation information is saved with the image.

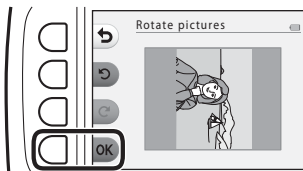



Small Picture

Create a small copy of images.

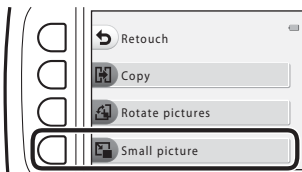
- 1 Press flexible button 4 () **Small picture**).



- 2 Use flexible button 2 () or flexible button 3 () to select the desired copy size and press flexible button 4 (**OK**).

- A new, edited copy is saved as a separate image with a compression ratio of about 1:16.
- To cancel, press flexible button 1 ()

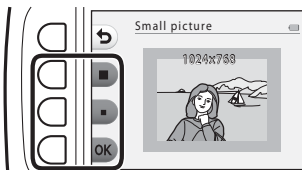

Notes About Small Picture

Images with an image size of 640 × 480 or smaller cannot be edited using **Small picture**.

Recording and Playing Back Movies

- When using the camera's internal memory, the movie frame size (📖37) can be set to 📷 **Small (640)** or 📷 **Small (old-fashioned)**.

1 Display the shooting screen.

- Check the remaining amount of movie recording time.

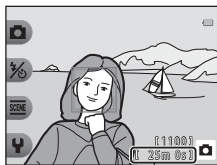

Remaining movie recording time

2 Press the ● (📷 movie-record) button to start movie recording.

- The camera focuses in the center of the frame.

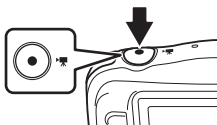

3 Press the ● (📷 movie-record) button again to end recording.

4 Select a movie in full-frame playback mode and press the multi selector ▲.

- An image with a playback time displayed is a movie.

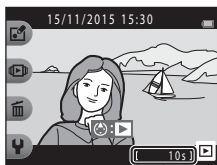

Playback time

Area Captured in Movies

- The area that is captured in a movie varies depending on **Movie frame size** (📖37).
- When recording movies while **Electronic VR** (📖83) in the camera settings is set to **Auto**, the angle of view (i.e., the area visible in the frame) is narrow compared to that of still images.

Maximum Movie Recording Time

Individual movie files cannot exceed 4 GB in size or 29 minutes in length, even when there is sufficient free space on the memory card for longer recording.

- The remaining recording time for a single movie is displayed on the shooting screen.
- The actual remaining recording time may vary depending on the movie content, subject movement, or type of memory card.
- Memory cards with an SD Speed Class rating of 6 or faster are recommended when recording movies (📖120). Movie recording may stop unexpectedly when memory cards with a lower Speed Class rating are used.

✓ **Notes About Camera Temperature**

- The camera may become hot when shooting movies for an extended period of time or when the camera is used in a hot area.
- If the inside of the camera becomes extremely hot when recording movies, the camera will automatically stop recording.
The amount of time remaining until the camera stops recording (🕒10s) is displayed.
After the camera stops recording, it turns itself off.
Leave the camera off until the inside of the camera has cooled.

Notes About Movie Recording

✓ Notes About Saving Images or Movies

The indicator showing the number of exposures remaining or the indicator showing the remaining recording time flashes while images or movies are being saved. **Do not open the battery-chamber/memory card slot cover or remove the battery or memory card** while an indicator is flashing. Doing this could result in loss of data, or in damage to the camera or the memory card.

✓ Notes About Recorded Movies

- The optical zoom ratio cannot be changed once recording starts.
- There may be some degradation in image quality when digital zoom is used.
- The sounds of multi selector operation, autofocus lens drive movement, and aperture operation when brightness changes may be recorded.
- The following phenomena may be seen in the monitor while recording movies. These phenomena are saved in the recorded movies.
 - Banding may occur in images under fluorescent, mercury-vapor, or sodium-vapor lighting.
 - Subjects that move quickly from one side of the frame to the other, such as a moving train or car, may appear skewed.
 - The entire movie image may be skewed when the camera is panned.
 - Lighting or other bright areas may leave residual images when the camera is moved.
- Depending on the distance to the subject or the amount of zoom applied, colored stripes may appear on subjects with repeating patterns (fabrics, lattice windows, etc.) during movie recording and playback. This occurs when the pattern in the subject and the layout of the image sensor interfere with each other; it is not a malfunction.

✓ Notes About Autofocus for Movie Recording

Autofocus may not perform as expected (📖39). Should this occur, try the following: Frame another subject (positioned at the same distance from the camera as the intended subject) in the center of the frame, press the ● (📽 movie-record) button to start recording, and then modify the composition.

Operations During Movie Playback

To adjust the volume, press the multi selector ▲▼ while a movie is playing. You can use the flexible buttons to perform the following operations.

When paused

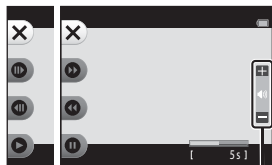

During playback

Volume indicator

Function	Icon	Description
Advance	▶▶	Hold down the button to advance the movie.
Rewind	◀◀	Hold down the button to rewind the movie.
Pause	⏸	Pause playback. The operations listed below can be performed while paused.
		▶▶ Advance the movie one frame. Hold down the button for continuous advancing.
		◀◀ Rewind the movie one frame. Hold down the button for continuous rewinding.
		▶▶ Resume playback.
End	✕	Return to full-frame playback mode.

General Camera Setup

Camera Settings Menu

Enter shooting mode or playback mode → flexible button 4 (Y) → flexible button 4 (Y Camera settings)

The settings of the menu options listed below can be configured.



Option	Description	
Welcome screen	Allows you to select whether or not the welcome screen is displayed when the camera is turned on.	80
Date and time	Allows you to set the camera clock.	80
Variety menu	Allows you to set whether to use all of the camera's functions.	81
Brightness	Allows you to adjust the brightness of the monitor.	82
Date stamp	Allows you to imprint the shooting date on images.	82
Electronic VR	Allows you to choose whether to use electronic VR (vibration reduction) when shooting.	83
AF assist	Allows you to enable or disable the AF-assist illuminator.	84
Format card/ Format memory	Allows you to format the memory card or the internal memory.	85
Language	Allows you to change the camera's display language.	86
Menu background	Allows you to change the background used on the menu screen.	86
Charge by computer	Allows you to set whether or not the battery in the camera is charged when the camera is connected to a computer.	87
Reset all	Allows you to reset the camera's settings to their default values.	88
Conformity marking	View some of the conformity markings that this camera has obtained.	88
Firmware version	View the current camera firmware version.	88

📷 Camera Settings

Welcome Screen

Enter shooting mode or playback mode → flexible button 4 (📷) → flexible button 4 (📷 Camera settings) → press ▲▼ →  Welcome screen







Select whether or not the welcome screen is displayed when you turn on the camera.

Option	Description
 Off	Does not display the welcome screen.
 On (default setting)	Displays an animated welcome screen. How often you use the camera and how many images you have taken with the camera affect the displayed characters.

Date and Time

Enter shooting mode or playback mode → flexible button 4 (📷) → flexible button 4 (📷 Camera settings) → press ▲▼ →  Date and time

Set the camera clock.

Option	Description
 Date format	Select Year/Month/Day , Month/Day/Year , or Day/Month/Year .
 Date and time	<ul style="list-style-type: none">Select a field: Press the multi selector .Edit the date and time: Press ▲▼.Apply the setting: Select the minute setting and press flexible button 4 (OK).Set daylight saving time: Press flexible button 3 () to display  in the monitor and enable daylight saving time. To disable daylight saving time, press flexible button 3 () again.

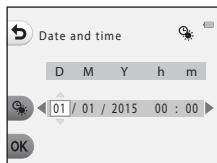

Variety Menu

Enter shooting mode or playback mode → flexible button 4 (👉) → flexible button 4 (👉 Camera settings) → press ▲▼ → 🤖 Variety menu

Allows you to set whether to use all of the camera's functions.

Option	Description
🤖 On	Enables use of all functions.
OFF Off	Some functions are restricted as follows.

The following functions are disabled.

- Shooting functions
 - **SCENE** → **Choose a style** → **Add a bubble effect** (📖30), **Add a neon effect** (📖30), **Add a cartoon effect** (📖30)
 - 👉 → **Change sounds** → **Turn sounds on or off** (📖34)
 - 👉 → **Choose a size** → **Movie frame size** → **Small (old-fashioned)** (📖37)
- Playback functions
 - 📷 → **Picture play** → **Make photo albums** (📖51)
 - 📺 → **Slide show** → **Choose a theme** (📖70)
- Camera settings
 - 👉 → **Camera settings** → **Welcome screen** (📖80)
 - 👉 → **Camera settings** → **Menu background** (📖86)

The following functions change.

- Three different frames are available in **SCENE** → **Decorate** (📖32)
- You will not be able to select sounds by using 👉 → **Change sounds** (📖34) → **Pick a shutter sound** and **Pick a button sound**
- Three different frames are available in 📷 → **Picture play** → **Decorate** (📖57)
- 📷 → **Grading** (📖58) changes to **Favorites** (📖62)
- 👉 → **Camera settings** → **Menu background** (📖86) design is fixed at 5.

Brightness

Enter shooting mode or playback mode → flexible button 4 (P) → flexible button 4 (P Camera settings) → press ▲▼ → ☼ Brightness

Adjust the brightness. The default setting is **3**.

- Use the multi selector ◀▶ to select the desired brightness and press flexible button 4 (OK).

Date Stamp

Enter shooting mode or playback mode → flexible button 4 (P) → flexible button 4 (P Camera settings) → press ▲▼ → DATE Date stamp

The shooting date and time can be stamped on images when shooting. The information can be printed even when using a printer that does not support the date imprinting function.



Option	Description
 Date	Date is stamped on images.
OFF Off (default setting)	Date is not stamped on images.

Notes About Date Stamp

- Stamped dates form a permanent part of image data and cannot be deleted. The date cannot be stamped on images after they have been captured.
- The date cannot be stamped in the following situations:
 - When using **Take a series of pictures**
 - Shoot a movie miniature**
 - When shooting movies



Printing a Shooting Date on Images Without a Date Stamp

You can transfer images to a computer and use the ViewNX 2 software (📖96) to imprint the shooting date on the images when they are printed.

Electronic VR

Enter shooting mode or playback mode → flexible button 4 (P) → flexible button 4 (P Camera settings) → press ▲▼ → (Hand) Electronic VR

Select the electronic VR (vibration reduction) setting used when shooting.

Option	Description
 Auto	<p>In the following conditions, the effects of camera shake are reduced when shooting.</p> <ul style="list-style-type: none">• When the flash mode is set to  Flash off• When the shutter speed is slow• When the subject is dark <p>Vibration reduction is always applied during movie recording.</p>
OFF Off (default setting)	Electronic VR is disabled.

Notes About Electronic VR

- Electronic VR is disabled while the flash is used.
- If the exposure period exceeds a certain period of time, electronic VR will not function.
- Electronic VR cannot be used when using the following styles.
 - **Shoot night scenes** (📖27)
 - **Shoot at intervals** (📖28)
 - **Take a series of pictures** (📖29)
 - **Photograph fireworks** (📖29)
 - **Shoot backlit scenes** (📖29)
- Even when electronic VR is set to **Auto**, depending on the scene (📖22) automatically selected by the camera when using  Point and shoot mode, the electronic VR may not function.
- The effectiveness of electronic VR decreases as camera shake increases.
- Images may contain noise.

AF Assist

Enter shooting mode or playback mode → flexible button 4 (P) → flexible button 4 (P Camera settings) → press ▲▼ → AF assist

Option	Description
AUTO Auto (default setting)	The AF-assist illuminator automatically lights up when you press the shutter-release button under dim lighting. The illuminator has a range of about 1.9 m (6 ft 3 in.) at the maximum wide-angle position and about 1.7 m (5 ft 7 in.) at the maximum telephoto position. <ul style="list-style-type: none">• Note that for some settings, the AF-assist illuminator may not light.
OFF Off	The AF-assist illuminator does not light.

Format Card/Format Memory

Enter shooting mode or playback mode → flexible button 4 (👉) → flexible button 4 (👉 Camera settings) → press ▲▼ → 📷 Format memory/📷 Format card

Use this option to format a memory card or the internal memory.

Formatting the memory cards or internal memory permanently deletes all data. Data that has been deleted cannot be recovered. Make sure to save important images to a computer before formatting.

Formatting a Memory Card

- Insert a memory card into the camera.
- Select **Format card** in the camera settings menu.

Formatting the Internal Memory

- Remove the memory card from the camera.
- Select **Format memory** in the camera settings menu.

To start formatting, press flexible button 3 (⊙ **Format**) on the screen that is displayed.

- Do not turn the camera off or open the battery-chamber/memory card slot cover during formatting.

📌 Notes About Format card/Format memory

You cannot format while image lock (🔒20) is set. Remove image lock.

Language

Enter shooting mode or playback mode → flexible button 4 (P) → flexible button 4 (P Camera settings) → press ▲▼ →  Language

Select a language for display of camera menus and messages.

Menu Background

Enter shooting mode or playback mode → flexible button 4 (P) → flexible button 4 (P Camera settings) → press ▲▼ →  Menu background

Select one of five background designs to be used for a menu screen or thumbnail playback mode.

- Use the multi selector ◀▶ to select the desired design and press flexible button 4 (OK).
- To restore the default background image, press flexible button 3 (RESET).

Charge by Computer

Enter shooting mode or playback mode → flexible button 4 (P) → flexible button 4 (P Camera settings) → press ▲▼ → Charge by computer

Option	Description
AUTO Auto (default setting)	When the camera is connected to a computer that is running (89), the battery inserted into the camera is automatically charged using power supplied by the computer.
OFF Off	The battery inserted into the camera is not charged when the camera is connected to a computer.

✓ Notes About Charging with a Computer

- When connected to a computer, the camera turns on and starts charging. If the camera is turned off, charging stops.
- About 2 hours and 30 minutes are required to charge a fully exhausted battery. Charging time increases when images are transferred while the battery is charging.
- The camera turns off automatically if there is no communication with the computer for 30 minutes after the battery has finished charging.

✓ When the Charge Lamp Quickly Flashes Green

Charging cannot be performed, possibly due to one of the reasons described below.

- The ambient temperature is not suited to charging. Charge the battery indoors with an ambient temperature of 5°C to 35°C (41°F to 95°F).
- The USB cable is not connected correctly, or the battery is faulty. Make sure the USB cable is connected correctly or replace the battery if necessary.
- The computer is in sleep mode and is not supplying power. Wake up the computer.
- The battery cannot be charged because the computer cannot supply power to the camera due to the computer's settings or its specifications.

Reset All

Enter shooting mode or playback mode → flexible button 4 (P) → flexible button 4 (P Camera settings) → press ▲▼ → ⌂ Reset all

When flexible button 3 (O **Reset**) is selected, the camera's settings are restored to their default values.

- Some settings, such as **Date and time** or **Language**, are not reset.

Resetting File Numbering

To reset file numbering to "0001", delete all images saved on the memory card or in the internal memory (📖18) before selecting **Reset all**.

Conformity Marking

Enter shooting mode or playback mode → flexible button 4 (P) → flexible button 4 (P Camera settings) → press ▲▼ → □ Conformity marking

View some of the conformity markings that the camera complies with.

Firmware Version

Enter shooting mode or playback mode → flexible button 4 (P) → flexible button 4 (P Camera settings) → press ▲▼ → Ver. Firmware version

View the current camera firmware version.

Connecting the Camera to a TV, Printer, or Computer

You can enhance your enjoyment of images and movies by connecting the camera to a TV, printer, or computer.

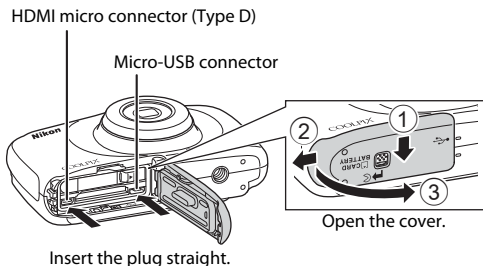

- Before connecting the camera to an external device, make sure the remaining battery level is sufficient and turn the camera off. Open the cover and make sure there are no water droplets. If there are water droplets, wipe the camera with a soft dry cloth before connecting. Before disconnecting, make sure to turn the camera off.
- If the AC Adapter EH-62G (available separately) is used, this camera can be powered from an electrical outlet. Do not use any other make or model of AC adapter as it may cause the camera to heat up or malfunction.
- For information about the connection methods and subsequent operations, refer to the documentation included with the device in addition to this document.

Viewing images on a TV

📖91



Images and movies captured with the camera can be viewed on a TV.

Connection method: Connect a commercially available HDMI cable to the TV's HDMI input jack.

Printing images without using a computer

📖92



If you connect the camera to a PictBridge-compatible printer, you can print images without using a computer.

Connection method: Connect the camera directly to the printer's USB port with the USB cable.

Viewing and organizing images on a computer

📖96



You can transfer images to a computer to perform simple retouching and manage image data.

Connection method: Connect the camera to the computer's USB port with the USB cable.

- Before connecting to a computer, install ViewNX 2 on the computer (📖96).
- If any USB devices that draw the power from the computer are connected, disconnect them from the computer before you connect the camera to it. Connecting the camera and other USB-powered devices to the same computer simultaneously may cause a camera malfunction or excessive power supply from the computer, which could damage the camera or memory card.

Connecting the Camera to a TV

1 Turn off the camera and connect it to the TV.

- Make sure that the plugs are properly oriented. Do not insert or remove the plugs at an angle when connecting or disconnecting them.

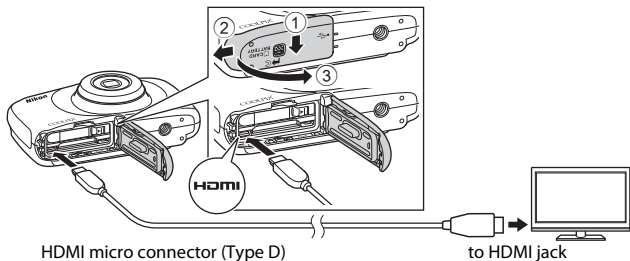

2 Set the TV's input to external input.

- See the documentation provided with your TV for details.

3 Hold down the (shooting/playback mode) button to turn on the camera.

- Images are displayed on the TV.
- The camera monitor does not turn on.

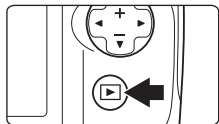

Image Resolution During TV Output

The option best suited to the TV to which the camera is connected is automatically selected from 1080i, 720p, or 480p.

HDMI

HDMI (High-Definition Multimedia Interface) is a multimedia interface.

Connecting the Camera to a Printer

Users of PictBridge-compatible printers can connect the camera directly to the printer and print images without using a computer.

Connecting the Camera to a Printer

- 1 Turn on the printer.
- 2 Turn off the camera and connect it to the printer using the USB cable.
 - Make sure that the plugs are properly oriented. Do not insert or remove the plugs at an angle when connecting or disconnecting them.

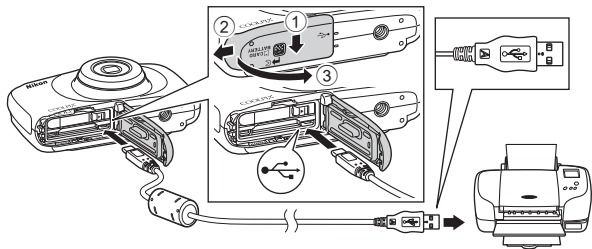

- 3 The camera is automatically turned on.

- The **PictBridge** startup screen (1) is displayed in the camera monitor, followed by the **Print selection** screen (2).

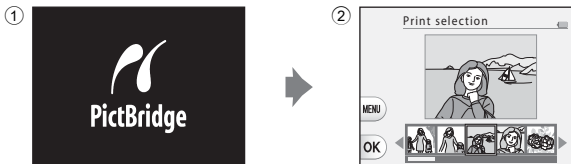

✓ If the PictBridge Startup Screen Is Not Displayed

When **Auto** is selected for **Charge by computer** (87), it may be impossible to print images with direct connection of the camera to some printers. If the PictBridge startup screen is not displayed after the camera is turned on, turn the camera off and disconnect the USB cable. Set **Charge by computer** to **Off** and reconnect the camera to the printer.

Printing Images One at a Time

- 1 Use the multi selector ◀▶ to select the desired image and press flexible button 4 (OK).



- 2 Press flexible button 3 (Copies).

- Use ▲▼ to set the desired number of copies (up to 9) and press flexible button 4 (OK).

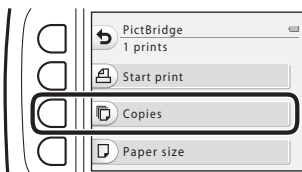

- 3 Press flexible button 4 (Paper size).

- Use ▲▼ to select the paper size and press flexible button 4 (OK).
- To print with the paper size setting configured on the printer, select **Default**.
- The paper size options available on the camera vary depending on the printer that you use.

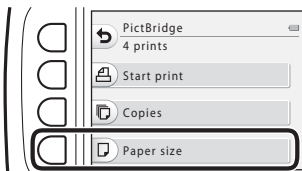

- 4 Press flexible button 2 (Start print).

- Printing starts.

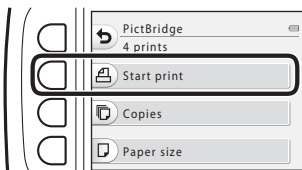

Printing Multiple Images

- 1** When the **Print selection** screen is displayed, press flexible button 3 (**MENU**).

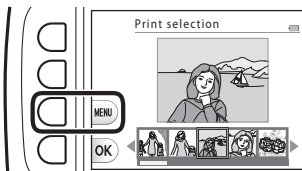

- 2** Press flexible button 4 (**□ Paper size**).

- Use ▲▼ to select the paper size and press flexible button 4 (**OK**).
- To print with the paper size setting configured on the printer, select **Default**.
- The paper size options available on the camera vary depending on the printer that you use.
- To exit the print menu, press flexible button 1 (↶).

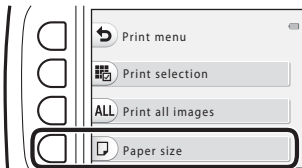

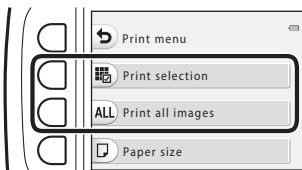

- 3** Press flexible button 2 or 3 to select the print method.

- Select **Print selection** or **ALL Print all images**.



Print selection

Select images (up to 99) and the number of copies (up to 9) of each.

- Use the multi selector  to select images, and use flexible button 2 (+) or flexible button 3 (-) to specify the number of copies to be printed.
- Images selected for printing are indicated by a check mark and the number of copies to be printed. To cancel the print selection, set the number of copies to 0.
- Press flexible button 4 (OK) when setting is complete. When the screen for confirming the number of print copies is displayed, press flexible button 2 ( **Start print**) to start printing.

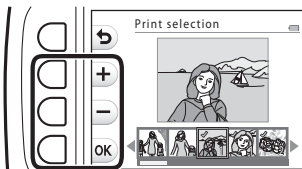

Print all images

One copy each of all images saved in the internal memory, or on the memory card, is printed.

- When the screen for confirming the number of print copies is displayed, press flexible button 2 ( **Start print**) to start printing.

Using ViewNX 2 (Transferring Images to a Computer)

Installing ViewNX 2

ViewNX 2 is free software that enables you to transfer images and movies to your computer so that you can view, edit, or share them. To install ViewNX 2, download the ViewNX 2 installer from the website below and follow the on-screen installation instructions.

<http://nikonimglib.com/nvnx/>

For system requirements and other information, see the Nikon website for your region.

Transferring Images to a Computer

1 Prepare a memory card that contains images.

You can use any of the methods below to transfer images from the memory card to a computer.

- **SD memory card slot/card reader:** Insert the memory card into the card slot of your computer or the card reader (commercially available) that is connected to the computer.
- **Direct USB connection:** Turn the camera off and ensure that the memory card is inserted in the camera. Connect the camera to the computer using the USB cable.

The camera automatically turns on.

To transfer images that are saved in the camera's internal memory, remove the memory card from the camera before connecting it to the computer.

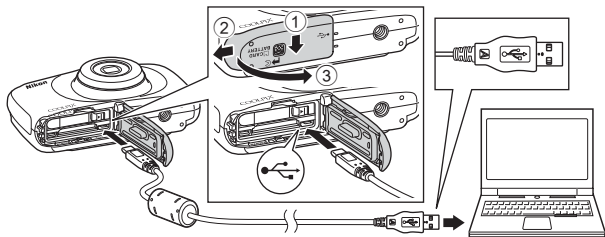

If a message is displayed prompting you to choose a program, select Nikon Transfer 2.

- **When using Windows 7**

If the dialog shown at right is displayed, follow the steps below to select Nikon Transfer 2.

- 1 Under **Import pictures and videos**, click **Change program**. A program selection dialog will be displayed; select **Import File using Nikon Transfer 2** and click **OK**.
- 2 Double-click **Import File**.



If the memory card contains a large number of images, it may take a while for Nikon Transfer 2 to start. Wait until Nikon Transfer 2 starts.

Notes About Connecting the USB Cable

Operation is not guaranteed if the camera is connected to the computer via a USB hub.

2 After Nikon Transfer 2 starts, click **Start Transfer**.

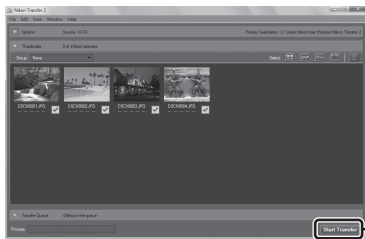

- Image transfer begins. When image transfer is complete, ViewNX 2 starts and the transferred images are displayed.
- Consult online help for more information on using ViewNX 2.

3 Terminate the connection.

- If you are using a card reader or card slot, choose the appropriate option in the computer operating system to eject the removable disk corresponding to the memory card and then remove the memory card from the card reader or card slot.
- If the camera is connected to the computer, turn the camera off and disconnect the USB cable.

Technical Notes

Caring for the Product	99
The Camera.....	99
The Battery.....	100
The Charging AC Adapter	101
Memory Cards.....	102
Cleaning and Storage	103
Cleaning.....	103
Storage	103
Error Messages	104
Troubleshooting	107
File Names.....	114
Optional Accessories.....	115
Specifications.....	116
Approved Memory Cards	120
Index.....	122

Caring for the Product

Observe the precautions described below in addition to the warnings in "For Your Safety" (📖v-vii) and "<Important> Shockproof, Waterproof, Dustproof, Condensation" (📖x-xv) when using or storing the device.

The Camera

Do Not Apply Strong Impact to the Camera

The product may malfunction if subjected to strong shock or vibration. In addition, do not touch or apply force to the lens.

Avoid Sudden Changes in Temperature

Sudden changes in temperature, such as when entering or leaving a heated building on a cold day, can cause condensation to form inside the device. To prevent condensation, place the device in a carrying case or a plastic bag before exposing it to sudden changes in temperature.

Keep Away from Strong Magnetic Fields

Do not use or store this device in the vicinity of equipment that generates strong electromagnetic radiation or magnetic fields. Doing so could result in loss of data or camera malfunction.

Do Not Point the Lens at Strong Light Sources for Extended Periods

Avoid pointing the lens at the sun or other strong light sources for extended periods when using or storing the camera. Intense light may cause the image sensor to deteriorate or produce a white blur effect in photographs.

Turn the Product Off Before Removing or Disconnecting the Power Source or Memory Card

Do not remove the battery while the product is on, or while images are being saved or deleted. Forcibly cutting power in these circumstances could result in loss of data or in damage to product memory or internal circuitry.

Notes About the Monitor

- Monitors and electronic viewfinders are constructed with extremely high precision; at least 99.99% of pixels are effective, with no more than 0.01% being missing or defective. Hence while these displays may contain pixels that are always lit (white, red, blue, or green) or always off (black), this is not a malfunction and has no effect on images recorded with the device.
- Images in the monitor may be difficult to see under bright lighting.
- Do not apply pressure to the monitor, as this could cause damage or malfunction. Should the monitor break, care should be taken to avoid injury caused by broken glass and to prevent the liquid crystal from the display touching the skin or entering the eyes or mouth.

The Battery

Precautions for Use

- Note that the battery may become hot after use.
- Do not use the battery at ambient temperatures below 0°C (32°F) or above 40°C (104°F) as this could cause damage or malfunction.
- If you notice any abnormalities such as excessive heat, smoke, or an unusual smell coming from the battery, immediately discontinue use and consult your retailer or Nikon-authorized service representative.
- After removing the battery from the camera or optional battery charger, put the battery in a plastic bag, etc. in order to insulate it.

Charging the Battery

Check the battery level before using the camera and replace or charge the battery if necessary.

- Charge the battery indoors with an ambient temperature of 5°C to 35°C (41°F to 95°F) before use.
- A high battery temperature may prevent the battery from charging properly or completely, and may reduce battery performance. Note that the battery may become hot after use; wait for the battery to cool before charging. When charging the battery inserted into this camera using the Charging AC Adapter or a computer, the battery is not charged at battery temperatures below 5°C (41°F) or above 55°C (131°F).
- When the battery temperature is between 45°C–55°C (113°F–131°F), the chargeable capacity may decrease.
- Do not continue charging once the battery is fully charged as this will result in reduced battery performance.
- The battery temperature may increase during charging. However, this is not a malfunction.

Carrying Spare Batteries

Whenever possible, carry fully charged spare batteries when taking pictures on important occasions.

Using the Battery When Cold

On cold days, the capacity of batteries tends to decrease. If an exhausted battery is used at a low temperature, the camera may not turn on. Keep spare batteries in a warm place and exchange as necessary. Once warmed, a cold battery may recover some of its charge.

Battery Terminals

Dirt on the battery terminals may prevent the camera from functioning. Should the battery terminals become dirty, wipe them off with a clean, dry cloth before use.

Charging an Exhausted Battery

Turning the camera on or off while an exhausted battery is inserted in the camera may result in reduced battery life. Charge the exhausted battery before use.

Storing the Battery

- Always remove the battery from the camera or optional battery charger when it is not being used. Minute amounts of current are drawn from the battery while it is in the camera, even when not in use. This may result in excessive battery drain and complete loss of function.
- Recharge the battery at least once every six months and completely exhaust it before returning it to storage.
- Put the battery in a plastic bag, etc. in order to insulate it and store it in a cool place. The battery should be stored in a dry location with an ambient temperature of 15°C to 25°C (59°F to 77°F). Do not store the battery in hot or extremely cold locations.

Battery Life

A marked drop in the time a fully charged battery retains its charge, when used at room temperature, indicates that the battery needs to be replaced. Purchase a new battery.

Recycling Used Batteries

Replace the battery when it no longer holds a charge. Used batteries are a valuable resource. Please recycle used batteries in accordance with local regulations.

The Charging AC Adapter

- The Charging AC Adapter EH-71P is for use only with compatible devices. Do not use with another make or model of device.
- Do not use any USB cable other than the UC-E21. Using a USB cable other than the UC-E21 could result in overheating, fire or electric shock.
- Do not, under any circumstances, use another make or model of AC adapter other than Charging AC Adapter EH-71P, and do not use a commercially available USB-AC adapter or a battery charger for a mobile phone. Failure to observe this precaution could result in overheating or in damage to the camera.
- The EH-71P is compatible with AC 100–240 V, 50/60 Hz electrical outlets. When using in other countries, use a plug adapter (commercially available) as necessary. For more information about plug adapters, consult your travel agency.

Memory Cards

Precautions for Use

- Use only Secure Digital memory cards. See "Approved Memory Cards" (📖120) for recommended memory cards.
- Be sure to follow the precautions described in the documentation included with the memory card.
- Do not put labels or stickers on memory cards.

Formatting

- Do not format the memory card using a computer.
- The first time you insert a memory card that has been used in another device into this camera, be sure to format it with this camera. We recommend formatting new memory cards with this camera before using them with this camera.
- **Note that formatting a memory card permanently deletes all images and other data on the memory card.** Be sure to make copies of any images you wish to keep before formatting the memory card.
- If the message **Card is not formatted. Format card?** is displayed when the camera is turned on, the memory card must be formatted. If there is data that you do not want to delete, press flexible button 4 (**X No**). Copy the necessary data to a computer, etc. To start formatting, press flexible button 3 (**O Yes**).
- Do not perform the following during formatting, while data is being written to or deleted from the memory card, or during data transfer to a computer. Failure to observe this precaution could result in the loss of data or in damage to the camera or memory card:
 - Open the battery-chamber/memory card slot cover to remove/insert the battery or memory card.
 - Turn off the camera.
 - Disconnect the AC adapter.

Cleaning and Storage

Cleaning

Do not use alcohol, thinner, or other volatile chemicals.

Lens	Avoid touching glass parts with your fingers. Remove dust or lint with a blower (typically a small device with a rubber bulb attached to one end that is pumped to produce a stream of air out the other end). To remove fingerprints or other stains that cannot be removed with a blower, wipe the lens with a soft cloth, using a spiral motion that starts at the center of the lens and working toward the edges. If this fails, clean the lens using a cloth lightly dampened with commercial lens cleaner.
Monitor	Remove dust or lint with a blower. To remove fingerprints and other stains, clean the monitor with a soft, dry cloth, being careful not to apply pressure.
Body	Use a blower to remove dust, dirt, or sand, then wipe gently with a soft, dry cloth. Do not stick sharp objects into the microphone or speaker holes. When the inside of the camera is damaged, waterproof performance will be lost. See "Notes About Waterproof and Dustproof Performances" (📖x) and "Cleaning After Using the Camera Underwater" (📖xiii) for more information. Note that foreign matter inside the camera could cause damage not covered by the warranty.

Storage

Remove the battery if the camera will not be used for an extended period. To prevent mold or mildew, take the camera out of storage at least once a month. Turn the camera on and release the shutter a few times before putting the camera away again. Do not store the camera in any of the following locations:

- Places that are poorly ventilated or subject to humidity of over 60%
- Exposed to temperatures above 50°C (122°F) or below -10°C (14°F)
- Next to equipment that produces strong electromagnetic fields, such as televisions or radios

For storing the battery, follow the precautions in "The Battery" (📖100) in "Caring for the Product" (📖99).

Error Messages

Refer to the table below if an error message is displayed.

Display	Cause/Solution	
Battery temperature is elevated. The camera will turn off.	The camera turns off automatically. Wait until the camera or battery temperature has cooled before resuming use.	–
The camera will turn off to prevent overheating.		
Memory card is write protected.	The write-protect switch is in the “lock” position. Slide the write-protect switch to the “write” position.	–
This card cannot be used.	An error occurred while accessing the memory card. <ul style="list-style-type: none"> • Use an approved memory card. • Check that the terminals are clean. • Confirm that the memory card is correctly inserted. 	7, 120
This card cannot be read.		
Card is not formatted. Format card?	The memory card has not been formatted for use in the camera. Formatting deletes all data saved on the memory card. If you need to keep copies of any images, make sure to press flexible button 4 (X No) and save the copies to a computer or other medium before formatting the memory card. Press flexible button 3 (O Yes) to format the memory card.	102
Out of memory.	Delete images or insert a new memory card.	7, 18
Image cannot be saved.	An error occurred while saving the image. Insert a new memory card or format the memory card or internal memory.	85
	The camera has run out of file numbers. Insert a new memory card or format the memory card or internal memory.	85
	There is insufficient space to save the copy. Delete images from the destination.	18
No further pictures can be graded.	200 images have already been graded or added to favorites.	59, 61, 63, 65
Album is full. No further pictures can be added.	Remove some grades or remove some images from favorites.	

Display	Cause/Solution	
Image cannot be modified.	Check that the images can be edited.	49, 112
Cannot record movie.	A time-out error occurred while saving the movie on the memory card. Select a memory card with a faster write speed.	76, 120
Memory contains no images.	There are no images in the internal memory or on the memory card. <ul style="list-style-type: none"> Remove the memory card to play back images in the internal memory. To copy the images saved in the camera's internal memory to the memory card, select Copy in the retouch menu. 	8 71
File contains no image data.	The file was not created or edited with this camera. The file cannot be viewed on this camera. View the file using a computer or the device used to create or edit this file.	–
All images are hidden.	There are no images available for a slide show, etc.	67
Lens error. Try again after turning the camera off and on.	If the error persists, contact your retailer or Nikon-authorized service representative.	107
Communications error	An error occurred while communicating with the printer. Turn the camera off and reconnect the USB cable.	92
System error	An error occurred in the camera's internal circuitry. Turn the camera off, remove and reinsert the battery, and turn the camera on. If the error persists, contact your retailer or Nikon-authorized service representative.	107
Printer error: check printer status.	After solving the problem, press flexible button 3 (Resume) to resume printing.*	–
Printer error: check paper.	Load the specified size of paper and press flexible button 3 (Resume) to resume printing.*	–
Printer error: paper jam.	Remove the jammed paper and press flexible button 3 (Resume) to resume printing.*	–
Printer error: out of paper.	Load the specified size of paper and press flexible button 3 (Resume) to resume printing.*	–

Display	Cause/Solution	
Printer error: check ink.	There is a problem with the printer's ink. Check the ink and press flexible button 3 (○ Resume) to resume printing.*	–
Printer error: out of ink.	Replace the ink cartridge and press flexible button 3 (○ Resume) to resume printing.*	–
Printer error: file corrupt.	There is a problem with the image file to be printed. Press flexible button 4 (✕ Cancel) to cancel printing.	–



* See the documentation provided with your printer for further guidance and information.

Troubleshooting

If the camera fails to function as expected, check the list of common problems below before consulting your retailer or Nikon-authorized service representative.





Power, Display, Settings Issues





Problem	Cause/Solution	
The camera is on but does not respond.	Wait for recording to end. If the problem persists, turn the camera off. If the camera does not turn off, remove and reinsert the battery or batteries or, if you are using an AC adapter, disconnect and reconnect the AC adapter. Note that although any data currently being recorded will be lost, data that have already been recorded will not be affected by removing or disconnecting the power source.	–
The camera cannot be turned on.	The battery is exhausted.	7, 9, 100
The camera turns off without warning.	<ul style="list-style-type: none">• The camera automatically turns off to save power (auto off function).• The camera and battery may not work properly at low temperatures.• The inside of the camera has become hot. Leave the camera off until the inside of the camera has cooled, and then try turning it on again.	15 100 –
The monitor is blank.	<ul style="list-style-type: none">• The camera is off.• The camera automatically turns off to save power (auto off function).• The flash lamp flashes while the flash is charging. Wait until charging is complete.• The camera is connected to a TV or computer.	11 15 – –
The camera becomes hot.	The camera may become hot when used for an extended period of time to shoot movies or when used in a hot environment; this is not a malfunction.	–

Problem	Cause/Solution	
The battery inserted in the camera cannot be charged.	<ul style="list-style-type: none"> • Confirm all connections. • When connected to a computer, the camera may not charge for any of the reasons described below. <ul style="list-style-type: none"> - Off is selected for Charge by computer in the camera settings menu. - Battery charging stops if the camera is turned off. - Battery charging is not possible if the camera's display language and date and time have not been set, or the date and time were reset after the camera's clock battery was exhausted. Use the Charging AC Adapter to charge the battery. - Battery charging may stop when the computer enters sleep mode. - Depending on the computer specifications, settings, and status, battery charging may not be possible. 	9 87 – 11, 13 – –
The monitor is hard to read.	<ul style="list-style-type: none"> • Adjust the monitor brightness. • The monitor is dirty. Clean the monitor. 	82 103
<p> flashes on the screen.</p> <p>Date and time of recording are not correct.</p>	<ul style="list-style-type: none"> • If the camera clock has not been set,  flashes on the shooting screen, and images and movies saved before the clock is set are dated "00/00/0000 00:00" and "01/01/2015 00:00" respectively. The shooting date and time of still images is not displayed during playback. Set the correct time and date for Date and time in the camera settings menu. • The camera clock is not as accurate as ordinary watches or clocks. Periodically compare the time of the camera clock with that of a more accurate timepiece and reset as required. 	3, 80
<p>Date stamp not available.</p>	<p>Date and time has not been set in the camera settings menu.</p>	80
<p>Date not stamped on images even when Date stamp is enabled.</p>	<ul style="list-style-type: none"> • The current shooting mode does not support Date stamp. • The date cannot be stamped on movies. 	82

Problem	Cause/Solution	
Screen for setting time and date is displayed when the camera is turned on.	The clock battery is exhausted; all settings were restored to their default values.	11, 13
The camera settings reset.		
Cannot select Format card or Format memory .	You cannot format while image lock is set. Remove image lock.	20
Some menu options are not displayed.	Some options are not displayed depending on the Variety menu settings. Change the settings.	81
The camera makes sound.	Depending on the settings, the camera may produce an audible focusing sound.	–

Shooting Issues

Problem	Cause/Solution	
Cannot switch to shooting mode.	Disconnect the HDMI cable or USB cable.	89
Cannot take pictures or record movies.	<ul style="list-style-type: none"> When the camera is in playback mode, press the  (shooting/playback mode) button, shutter-release button, or  button. 	1, 17
	<ul style="list-style-type: none"> When menus are displayed, press the  (shooting/playback mode) button, Shutter-release button, or  button. 	1
	<ul style="list-style-type: none"> The flash is charging while the flash lamp is flashing. 	23
	<ul style="list-style-type: none"> The battery is exhausted. 	7, 9, 100
The camera cannot focus.	<ul style="list-style-type: none"> The subject is too close. Try moving away from the subject or setting Choose a style to Shoot close-ups. 	27
	<ul style="list-style-type: none"> The subject is hard to focus on. 	39
	<ul style="list-style-type: none"> Set AF assist in the camera settings menu to Auto. 	84
	<ul style="list-style-type: none"> Turn the camera off and then on again. 	–
Images are blurred.	<ul style="list-style-type: none"> Use the flash. 	23
	<ul style="list-style-type: none"> Enable electronic VR. 	83
	<ul style="list-style-type: none"> Use a tripod to stabilize the camera (using the self-timer at the same time is more effective). 	24

Problem	Cause/Solution	
Bright specks appear in images captured with flash.	The flash is reflecting off particles in the air. Set the flash mode setting to  Flash off .	23
Flash does not fire.	<ul style="list-style-type: none"> The flash mode is set to  Flash off. Choose a style is set to a function that disables the flash. 	23 27
Digital zoom cannot be used.	Digital zoom cannot be used when using certain settings in other functions.	42
No sound when the shutter is released.	<ul style="list-style-type: none"> Turn sounds on or off in Change sounds is set to Turn sounds off, or Pick a shutter sound is set to  in the shooting menu. Shutter sound is not heard when Choose a style is set to Take a series of pictures. Do not block the speaker. 	34 29 1
AF-assist illuminator does not light.	Off is selected for AF assist in the camera settings menu. AF-assist illuminator may not light depending on the current settings, even when Auto is selected.	84
Images appear smeared.	The lens is dirty. Clean the lens.	103
Colors are unnatural.	Hue is not adjusted properly.	27, 33
Randomly spaced bright pixels ("noise") appear in image.	The subject is dark and the shutter speed is too slow, or ISO sensitivity is too high. Noise can be reduced by using the flash.	23
Images are too dark (underexposed).	<ul style="list-style-type: none"> The flash mode is set to  Flash off. The flash window is blocked. The subject is beyond the range of the flash. Adjust exposure compensation. 	23 14 117 33
Images are too bright (overexposed).	Adjust exposure compensation.	33
Skin tones are not softened.	<ul style="list-style-type: none"> In some shooting conditions, facial skin tones may not be softened. For images containing four or more faces, try using Make skin prettier in Add makeup in the playback menu. 	39 50

Problem	Cause/Solution	
Saving images takes time.	<p>It may take more time to save images in the following situations:</p> <ul style="list-style-type: none"> • When the noise reduction function is in operation, such as when shooting in a dark environment • When Choose a style is set to Shoot night scenes, Take a series of pictures, Shoot backlit scenes, Add a neon effect, or Add a cartoon effect • When the skin softening function is applied while shooting 	<p>–</p> <p>27, 29, 30</p> <p>39</p>
A ring-shaped belt or rainbow-colored stripe appears in the monitor or images.	<p>When shooting with backlighting or when a very strong light source (such as sunlight) is in the frame, a ring-shaped belt or rainbow-colored stripe (ghosting) may occur. Change the position of the light source, or frame the picture so that the light source does not enter the frame, and try again.</p>	<p>–</p>

Playback Issues

Problem	Cause/Solution	
File cannot be played back.	<ul style="list-style-type: none"> • This camera may not be able to play back images saved with another make or model of digital camera. • This camera cannot play back movies recorded with another make or model of digital camera. • This camera may not be able to play back data edited on a computer. 	<p>–</p>
Cannot zoom in on image.	<ul style="list-style-type: none"> • Playback zoom cannot be used with movies, and images with an image size of 160 × 120 or smaller. • When viewing small images, the playback zoom ratio that is displayed may not match the actual image zoom ratio. • This camera may not be able to zoom in on images captured with another make or model of digital camera. 	<p>–</p>

Problem	Cause/Solution	
Cannot record messages.	<ul style="list-style-type: none"> • Messages cannot be attached to movies. • Delete the message for an image before recording a new one. • Messages cannot be attached to images captured with other cameras. 	– 48 –
Cannot edit images.	<ul style="list-style-type: none"> • Some images cannot be edited. Images that have already been edited may not be edited again. • There is not enough free space on the memory card or in the internal memory. • This camera is unable to edit images captured with other cameras. • Editing functions used for images are not available for movies. 	49, 60, 64, 66, 74 – – –
Cannot rotate image.	This camera cannot rotate images captured with another make or model of digital camera.	–
Cannot delete image.	<ul style="list-style-type: none"> • Images cannot be deleted while image lock is set. Remove image lock. • Graded images and images added to favorites are protected. Remove the grades or remove the images from favorites. 	20 59, 61, 63, 65
Images are not displayed on TV.	<ul style="list-style-type: none"> • A computer or printer is connected to the camera. • The memory card contains no images. • Remove the memory card to play back images in the internal memory. 	– – 8
Nikon Transfer 2 does not start when the camera is connected.	<ul style="list-style-type: none"> • The camera is off. • The battery is exhausted. • The USB cable is not correctly connected. • The camera is not recognized by the computer. • The computer is not set to start Nikon Transfer 2 automatically. For more information about Nikon Transfer 2, refer to help information contained in ViewNX 2. 	– 87, 89 89, 96 – –
The PictBridge startup screen is not displayed when the camera is connected to a printer.	With some PictBridge-compatible printers, the PictBridge startup screen may not be displayed and it may be impossible to print images when Auto is selected for Charge by computer in the camera settings menu. Set Charge by computer to Off and reconnect the camera to the printer.	87

Problem	Cause/Solution	
Images to be printed are not displayed.	<ul style="list-style-type: none"> • The memory card contains no images. • Remove the memory card to print images in the internal memory. 	– 8
Cannot select paper size with the camera.	<p>The camera cannot be used to select the paper size in the following situations, even when printing from a PictBridge-compatible printer. Use the printer to select the paper size.</p> <ul style="list-style-type: none"> • The printer does not support the paper sizes specified by the camera. • The printer automatically selects the paper size. 	–

File Names

Images, movies, or messages are assigned file names as follows.

File name: DSCN0001.JPG

(1) (2) (3)

(1) Identifier	<p>Not shown on the screen of the camera.</p> <ul style="list-style-type: none">• DSCN: Original still images, movies• DSCA: Message• DSCB: Message (reply)• SSCN: Small picture copies• RSCN: Cropped copies• FSCN: Images created by an image editing function other than crop and small picture, photo albums
(2) File number	<p>Assigned in ascending order, starting with "0001" and ending with "9999."</p> <ul style="list-style-type: none">• A new folder is created each time a series of images are captured using Shoot at intervals, and the images are saved in that folder with file numbers starting with "0001."
(3) Extension	<p>Indicates file format.</p> <ul style="list-style-type: none">• .JPG: Still images• .MOV: Movies• .WAV: Messages (File number is the same as the image to which the message is attached.)

Optional Accessories

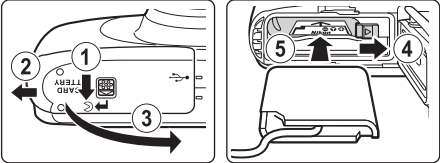
Battery charger	Battery Charger MH-66 It takes about 1 hour and 50 minutes to charge a fully exhausted battery.
AC adapter	AC Adapter EH-62G (connect as shown)  Make sure that the power connector cable is fully inserted in the power connector slot before inserting the AC adapter into the battery chamber. <ul style="list-style-type: none">• While using the AC adapter, the battery-chamber/memory card slot cover cannot be closed. Do not pull the power connector cable. If the cable is pulled, the connection between the camera and power source is interrupted, and the camera turns off.

Accessories are not waterproof.

Availability may vary with country or region.

See our website or brochures for the latest information.

Specifications

Nikon COOLPIX S33 Digital Camera

Type	Compact digital camera
Number of effective pixels	13.2 million (Image processing may reduce the number of effective pixels.)
Image sensor	$\frac{1}{3}$ -in. type CMOS; approx. 14.17 million total pixels
Lens	NIKKOR lens with 3 \times optical zoom
Focal length	4.1–12.3 mm (angle of view equivalent to that of 30–90 mm lens in 35mm [135] format)
f/-number	f/3.3–5.9
Construction	6 elements in 5 groups
Digital zoom magnification	Up to 4 \times (angle of view equivalent to that of approx. 360 mm lens in 35mm [135] format)
Vibration reduction	Electronic VR (movies)
Motion blur reduction	Electronic VR (still images)
Autofocus (AF)	Contrast-detect AF
Focus range	<ul style="list-style-type: none">• [W]: Approx. 5 cm (2 in.)–∞, [T]: Approx. 50 cm (1 ft 8 in.)–∞• Shoot close-ups, Photograph food, Shoot under water, Mirror, Add a bubble effect, Add a neon effect, Add a cartoon effect, Take soft pictures, Create a diorama effect, Shoot a movie miniature, Highlight colors: Approx. 5 cm (2 in.) (wide-angle position)–∞ (All distances measured from center of front surface of the protective glass)
Focus-area selection	Center, face detection, target finding AF
Monitor	6.7 cm (2.7-in.), approx. 230k-dot, TFT LCD with anti-reflection coating and 5-level brightness adjustment
Frame coverage (shooting mode)	Approx. 96% horizontal and vertical (compared to actual picture)
Frame coverage (playback mode)	Approx. 100% horizontal and vertical (compared to actual picture)

Storage	
Media	Internal memory (approx. 25 MB), SD/SDHC/SDXC memory card
File system	DCF and Exif 2.3 compliant
File formats	Still images: JPEG Voice messages: WAV Movies: MOV (Video: H.264/MPEG-4 AVC, Audio: PCM stereo)
Image size (photo size)	<ul style="list-style-type: none"> • 13 megapixels [4160 × 3120] • 4 megapixels [2272 × 1704] • 2 megapixels [1600 × 1200]
ISO sensitivity (Standard output sensitivity)	ISO 125–1600
Exposure	
Metering mode	Matrix, center-weighted (digital zoom less than 2×), spot (digital zoom 2× or more)
Exposure control	Programmed auto exposure and exposure compensation (–2.0 – +2.0 EV in steps of 1 EV)
Shutter	
Speed	<ul style="list-style-type: none"> • $\frac{1}{2000}$–1 s • 4 s (Choose a style is set to Photograph fireworks)
Aperture	
Range	Electronically-controlled ND filter (–2 AV) selection 2 steps (f/3.3 and f/6.6 [W])
Self-timer	10 s, smile timer
Flash	
Range (approx.) (ISO sensitivity: Auto)	[W]: 0.3–3.1 m (1–10 ft) [T]: 0.6–1.7 m (2 ft–5 ft 6 in.)
Flash control	TTL auto flash with monitor preflashes
Interface	
USB connector	Micro-USB connector (do not use any USB cable other than the UC-E21), Hi-Speed USB <ul style="list-style-type: none"> • Supports Direct Print (PictBridge)
HDMI output connector	HDMI micro connector (Type D)

Supported languages	Arabic, Bengali, Bulgarian, Chinese (Simplified and Traditional), Czech, Danish, Dutch, English, Finnish, French, German, Greek, Hindi, Hungarian, Indonesian, Italian, Japanese, Korean, Marathi, Norwegian, Persian, Polish, Portuguese (European and Brazilian), Romanian, Russian, Serbian, Spanish, Swedish, Tamil, Telugu, Thai, Turkish, Ukrainian, Vietnamese
Power sources	<ul style="list-style-type: none"> • One Rechargeable Li-ion Battery EN-EL19 (included) • AC Adapter EH-62G (available separately)
Charging time	Approx. 1 h 40 min (when using Charging AC Adapter EH-71P and when no charge remains)
Battery life¹	
Still images	Approx. 220 shots when using EN-EL19
Movies (actual battery life for recording)²	Approx. 1 h 25 min when using EN-EL19
Tripod socket	1/4 (ISO 1222)
Dimensions (W × H × D)	Approx. 109.5 × 67.0 × 37.6 mm (4.4 × 2.7 × 1.5 in.) (excluding projections)
Weight	Approx. 180 g (6.3 oz) (including battery and memory card)
Operating environment	
Temperature	-10°C – +40°C (14°F–104°F) (for land use) 0°C–40°C (32°F–104°F) (for underwater use)
Humidity	85% or less (no condensation)
Waterproof	JIS/IEC protection class 8 (IPX8) equivalent (under our testing conditions) Capacity to shoot pictures underwater up to a depth of 10 m (33 ft) and for 60 minutes
Dustproof	JIS/IEC protection class 6 (IP6X) equivalent (under our testing conditions)
Shockproof	Cleared our testing conditions ³ compliant with MIL-STD 810F Method 516.5-Shock

- Unless otherwise stated, all figures assume a fully-charged battery and an ambient temperature of $23 \pm 3^{\circ}\text{C}$ ($73.4 \pm 5.4^{\circ}\text{F}$) as specified by the Camera and Imaging Products Association (CIPA).
- 1 Battery life may vary depending on conditions of use, such as the interval between shots or the length of time that menus and images are displayed.
 - 2 Individual movie files cannot exceed 4 GB in size or 29 minutes in length. Recording may end before this limit is reached if camera temperature becomes elevated.
 - 3 Dropped from a height of 1.5 m (5 ft) onto a surface of 5 cm (2 in.) thick plywood (changes in appearance, such as paint peeling off and deformation of the drop shock portion and waterproof performance are not subject to the test). These tests do not guarantee that the camera will be free from damage or trouble under all conditions.

Rechargeable Li-ion Battery EN-EL19

Type	Rechargeable lithium-ion battery
Rated capacity	DC 3.7 V, 700 mAh
Operating temperature	0°C – 40°C (32°F – 104°F)
Dimensions (W × H × D)	Approx. 31.5 × 39.5 × 6 mm (1.3 × 1.6 × 0.3 in.)
Weight	Approx. 14.5 g (0.5 oz)

Charging AC Adapter EH-71P

Rated input	AC 100–240 V, 50/60 Hz, MAX 0.2 A
Rated output	DC 5.0 V, 1.0 A
Operating temperature	0°C – 40°C (32°F – 104°F)
Dimensions (W × H × D)	Approx. 55 × 22 × 54 mm (2.2 × 0.9 × 2.2 in.) (excluding plug adapter) For Argentina: Approx. 55 × 63 × 59 mm (2.2 × 2.5 × 2.4 in.) For Brazil: Approx. 55 × 67 × 59 mm (2.2 × 2.7 × 2.4 in.) For Korea: Approx. 55 × 67 × 59 mm (2.2 × 2.7 × 2.4 in.)
Weight	Approx. 48 g (1.7 oz) (excluding plug adapter) For Argentina: Approx. 73 g (2.6 oz) For Brazil: Approx. 70 g (2.5 oz) For Korea: Approx. 70 g (2.5 oz)

- Nikon will not be held liable for any errors this manual may contain.
- The appearance of this product and its specifications are subject to change without notice.

Approved Memory Cards

The following Secure Digital (SD) memory cards have been tested and approved for use in this camera.

- Memory cards with an SD Speed Class rating of 6 or faster are recommended for recording movies. When using a memory card with a lower Speed Class rating, movie recording may stop unexpectedly.

	SD memory card	SDHC memory card	SDXC memory card
SanDisk	–	4 GB, 8 GB, 16 GB, 32 GB	64 GB, 128 GB
TOSHIBA	–	4 GB, 8 GB, 16 GB, 32 GB	64 GB
Panasonic	2 GB	4 GB, 8 GB, 16 GB, 32 GB	64 GB
Lexar	–	8 GB, 16 GB, 32 GB	64 GB, 128 GB

- Contact the manufacturer for details on the above cards. We cannot guarantee camera performance when using memory cards made by other manufacturers.
- If you use a card reader, make sure that it is compatible with your memory card.

Trademark Information

- Windows is either a registered trademark or trademark of Microsoft Corporation in the United States and/or other countries.
- Adobe, the Adobe logo, and Reader are either trademarks or registered trademarks of Adobe Systems Incorporated in the United States and/or other countries.
- SDXC, SDHC, and SD Logos are trademarks of SD-3C, LLC.



- PictBridge is a trademark.
- HDMI, HDMI logo and High-Definition Multimedia Interface are trademarks or registered trademarks of HDMI Licensing LLC.



- All other trade names mentioned in this manual or the other documentation provided with your Nikon product are the trademarks or registered trademarks of their respective holders.

AVC Patent Portfolio License

This product is licensed under the AVC Patent Portfolio License for the personal and non-commercial use of a consumer to (i) encode video in compliance with the AVC standard ("AVC video") and/or (ii) decode AVC video that was encoded by a consumer engaged in a personal and non-commercial activity and/or was obtained from a video provider licensed to provide AVC video. No license is granted or shall be implied for any other use.

Additional information may be obtained from MPEG LA, L.L.C.

See <http://www.mpegla.com>.

FreeType License (FreeType2)







Portions of this software are copyright © 2012 The FreeType Project (<http://www.freetype.org>). All rights reserved.

MIT License (HarfBuzz)



Portions of this software are copyright © 2015 The HarfBuzz Project (<http://www.freedesktop.org/wiki/Software/HarfBuzz>). All rights reserved.

Index

Symbols

-  Point and shoot..... 22
-  Playback mode..... 17
-  Camera settings menu..... 79
-  ( movie-record) button... 1, 75
-  (shooting/playback mode) button..... 2, 17

A

- AC adapter 89, 115
- Add a bubble effect  26, 30
- Add a cartoon effect  26, 30
- Add a diorama effect 55
- Add a fisheye effect 53
- Add a neon effect  26, 30
- Add makeup 50
- Add starbursts..... 54
- AF-assist illuminator 1, 84
- Always fire flash..... 23
- Aperture value 15
- Auto flash..... 23
- Auto off..... 15
- Autofocus..... 39

B

- Battery..... 7, 9, 13
- Battery chamber 2
- Battery charger 10, 115
- Battery level 13
- Battery-chamber/memory card slot cover 2, 7
- Brightness..... 33
- Brush..... x
- Button sound..... 34

C

- Camera settings..... 80
- Camera settings menu 79

- Change colors (playback mode) 55
- Change colors (shooting mode) 33
- Change sounds..... 34
- Charge by computer 87
- Charge lamp..... 2, 9
- Choose a size 36
- Choose a style 26
- Compression ratio..... 36
- Computer 90, 96
- Conformity marking 88
- Copy 71
- Create a diorama effect  26, 31
- Crop 43

D



- Date and time..... 11, 80
- Date format..... 11, 80
- Date stamp..... 82
- Daylight saving time 12, 80
- Decorate (playback mode)..... 57
- Decorate (shooting mode)..... 32
- Delete 18
- Digital zoom 16
- Direct print..... 90, 92









E

- Electronic VR..... 83
- Erase..... 45
- Erase recordings..... 48
- Exchange messages 46
- Exposure compensation..... 33
- Eyelet for camera strap 1

F

- Face detection 38
- Favorites..... 62

File name.....	114	M	
Firmware version.....	88	Make photo albums.....	51
Flash	1, 23	Memory card.....	7, 102, 120
Flash lamp	2, 23	Memory card slot.....	2, 7
Flash mode	23	Menu background.....	12, 86
Flash off.....	23	Microphone (stereo).....	1
Flexible buttons	5	Micro-USB connector	
Focus.....	38	2, 89, 91, 92, 96
Focus area.....	14	Mirror 	26, 30
Focus indicator	3	Monitor	2, 3, 103
Focus lock.....	40	Monitor brightness.....	82
Format internal memory	85	Movie frame size	37
Format memory cards	8, 85	Movie length.....	75
Formatting	8, 85	Movie playback.....	75
Full-frame playback mode	17	Movie recording.....	75
G		Multi selector	2
Grade pictures.....	58	N	
Grading.....	58	Nikon Transfer 2.....	97
H		Number of exposures remaining	
Have fun with pictures	45	13, 36
HDMI cable	90, 91	O	
HDMI micro connector.....	2, 89	Optical zoom.....	16
Highlight colors (playback mode)		Optional accessories.....	115
.....	56	P	
Highlight colors (shooting mode)		Paper size.....	93, 94
.....	33	Photo size.....	36
I		Photograph fireworks 	26, 29
Image lock.....	20	Photograph food 	26, 27
Imprinting date and time	82	PictBridge	90, 92
Internal memory	8	Picture play.....	49
L		Play recordings	48
Language.....	86	Playback	17, 78
Leave a message (recording a		Playback menu.....	45
message)	46	Playback mode.....	17
Leave a reply (recording a message)		Playback zoom	17, 43
.....	47	Power switch/power-on lamp	
Lens.....	1, 116	1, 11

- Pressing halfway 15
 Print 90, 93, 94
 Printer 90, 92
- R**
 Rechargeable battery 9
 Rechargeable Li-ion battery 7, 9
 Recording movies 75
 Remaining movie recording time
 75, 76
 Reset all 88
 Restrict image deletion 20
 Retouch 71
 Rotate pictures 73
- S**
 Saturation 33
 Self-timer 24
 Self-timer lamp 1, 24
 Shoot a movie miniature 
 26, 31
 Shoot at intervals  26, 28
 Shoot backlit scenes  26, 29
 Shoot close-ups  26, 27
 Shoot night scenes  26, 27
 Shoot under water  26, 27
 Shooting 14
 Shooting menu 21
 Shutter sound 34
 Shutter speed 15
 Shutter-release button 1, 14
 Slide show 67
 Small picture 74
 Smile timer 25
 Soften pictures 54
 Speaker 1
 Strap i
- I**
 Take a series of pictures  26, 29
- Take soft pictures  26, 31
 Telephoto 16
 Thumbnail playback 17, 44
 Toy camera 53
 Tripod socket 2, 118
 TV 90, 91
- U**
 Underwater face framing 
 26, 28
 USB cable 90, 92, 96
 Using skin softening 39
- V**
 Variety menu 81
 View 45
 View by date 66
 View graded pictures 60
 ViewNX 2 96
 Vividness 33
 Volume 48, 78
- W**
 Welcome screen 80
 Wide-angle 16
- Z**
 Zoom 16
 Zoom in 16
 Zoom out 16



No reproduction in any form of this manual, in whole or in part (except for brief quotation in critical articles or reviews), may be made without written authorization from NIKON CORPORATION.

NIKON CORPORATION

© 2015 Nikon Corporation



CT4L01(11)

6MN56511-01

Download from www.Softmanuals.com. All Manuals Search And Download.

Free Manuals Download Website

<http://myh66.com>

<http://usermanuals.us>

<http://www.somanuals.com>

<http://www.4manuals.cc>

<http://www.manual-lib.com>

<http://www.404manual.com>

<http://www.luxmanual.com>

<http://aubethermostatmanual.com>

Golf course search by state

<http://golfingnear.com>

Email search by domain

<http://emailbydomain.com>

Auto manuals search

<http://auto.somanuals.com>

TV manuals search

<http://tv.somanuals.com>