

Nikon

En

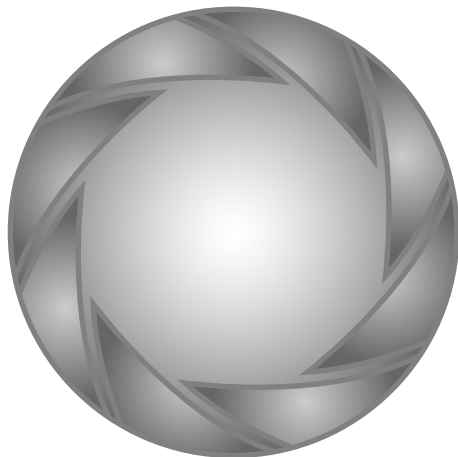

The ***Nikon*** Guide to Digital Photography
with the
COOLPIX 4500
DIGITAL CAMERA





Shoot, View, and Enjoy

A Flowchart Guide to Using Your Camera



STEP 1—Ready the camera

Getting ready	▶ First Steps		9
Camera setup	▶ The Set-up Menu		121



STEP 2—Take pictures

Snapshots (auto mode)	▶ Taking Pictures		18
Creative photography	▶ Scene Mode		44
Custom shots and movies	▶ The Shooting Menu		91

STEP 3—Play them back...

Basic playback	▶ Basic Playback		27
Manage pictures	▶ The Playback Menu		133

...and delete unwanted pictures

Delete individual pictures	▶ Basic Playback		27
Delete pictures after shooting	▶ Keep or Delete		71
Delete multiple pictures	▶ The Playback Menu: Delete		133

STEP 4—Install camera software

Install software	▶ <i>Quick Start Guide</i> (provided)	—
Get to know Nikon View 5	▶ <i>Nikon View 5 Reference Manual</i> (provided on CD)	—

STEP 5—Enjoy your pictures

Copy, edit, view, or print	▶ Connecting to a Computer		32
View pictures on a television screen	▶ Connecting to a Television or VCR		40

Product Documentation

The documentation for this product includes the manuals listed below. Please be sure to read all instructions thoroughly to get the most from your camera.

Quick-Start Guide

The *Quick-Start Guide* takes you through the process of unpacking and setting up your Nikon digital camera, taking your first pictures, installing software, and transferring pictures to your computer.

Guide to Digital Photography

The *Guide to Digital Photography* (this manual) provides complete operating instructions for your camera.

Nikon View 5 Reference Manual

The *Nikon View 5 Reference Manual* can be found in electronic format on the reference CD provided with your camera. For information on viewing the *Reference Manual*, see "Connections" in this manual.

Overview



Getting to Know the COOLPIX4500



First Steps



Taking Pictures



Basic Playback



Connecting to a Computer



Connecting to a Television or VCR



Beyond Point-and-Shoot



More About Playback



Index to Menu Options



Using Camera Menus



The Shooting Menu



The Set-up Menu



The Playback Menu



Technical Notes



Index



For Your Safety

To prevent damage to your Nikon product or injury to yourself or to others, read the following safety precautions in their entirety before using this equipment. Keep these safety instructions where all those who use the product will read them.

The consequences that could result from failure to observe the precautions listed in this section are indicated by the following symbol:



This icon marks warnings, information that should be read before using your Nikon product to prevent possible injury.

WARNINGS



Do not look at the sun through the viewfinder

Viewing the sun or other strong light source through the viewfinder could cause permanent visual impairment.



Turn off immediately in the event of malfunction

Should you notice smoke or an unusual smell coming from the equipment or from the AC adapter (available separately), unplug the AC adapter and remove the battery immediately, taking care to avoid burns. Continued operation could result in injury. After removing the battery, take the equipment to a Nikon-authorized service center for inspection.



Do not use in the presence of flammable gas

Do not use electronic equipment in the presence of flammable gas, as this could result in explosion or fire.



Do not place strap around neck

Placing the camera strap around your neck could result in strangulation. Special care should be taken to avoid placing the strap around the neck of an infant or child.



Do not disassemble

Touching the product's internal parts could result in injury. In the event of a malfunction, the product should be repaired only by a qualified technician. Should the product break open as the result of a fall or other accident, remove the battery and/or AC adapter and then take the product to a Nikon-authorized service center for inspection.



Observe proper precautions when handling batteries

Batteries may leak or explode if improperly handled. Observe the following precautions when handling batteries for use in this product:

- Be sure the product is off before replacing the battery. If you are using an AC adapter, be sure it is unplugged.
- Use only a rechargeable Nikon EN-EL1 lithium-ion battery (supplied) or a six-volt 2CR5 (DL245) lithium battery (available separately).
- The EN-EL1 is for use only with selected Nikon digital cameras. Do not use the EN-EL1 in equipment not approved for use with this battery.
- When inserting the battery, do not attempt to insert it upside down or backwards.

- Do not short or disassemble the battery.
- Do not expose the battery to flame or to excessive heat.
- Do not immerse in or expose to water.
- Do not transport or store with metal objects such as necklaces or hairpins.
- Batteries are prone to leakage when fully discharged. To avoid damage to the product, be sure to remove the battery when no charge remains.
- When the battery is not in use, attach the terminal cover and store in a cool place.
- Immediately after use, or when the product is used on battery power for an extended period, the battery may become hot. Before removing the battery, turn the camera off and allow the battery to cool.
- Discontinue use immediately should you notice any changes in the battery, such as discoloration or deformation.

 **Use appropriate cables**

When connecting cables to the input and output jacks, use only the cables provided or sold by Nikon for the purpose, to maintain compliance with product regulations.

 **The lens section**

When rotating the lens section, care should be exercised to avoid catching your fingers, hair, clothing, or other objects between the lens section and the camera body.

 **Keep out of reach of children**

Particular care should be taken to prevent infants from putting the battery or other small parts into their mouths.

 **Removing memory cards**

Memory cards may become hot during use. Observe due caution when removing memory cards from the camera.

 **CD-ROMs**

The CD-ROMs on which the software and manuals are distributed should not be played back on audio CD equipment. Playing CD-ROMs on an audio CD player could cause hearing loss or damage the equipment.

 **Observe caution when operating the flash**

Using the flash close to your subject's eyes could cause temporary visual impairment. Particular care should be observed if photographing infants, when the flash should be no less than one meter (39") from the subject.

 **When using the viewfinder**

When operating the diopter adjustment control with your eye to the viewfinder, care should be taken not to put your finger in your eye accidentally.

 **Avoid contact with liquid crystal**

Should the monitor break, care should be taken to avoid injury due to broken glass and to prevent liquid crystal from the monitor touching the skin or entering the eyes or mouth.

Notices

- No part of the manuals included with this product may be reproduced, transmitted, transcribed, stored in a retrieval system, or translated into any language in any form, by any means, without Nikon's prior written permission.
- Nikon reserves the right to change the specifications of the hardware and software described in these manuals at any time and without prior notice.
- Nikon will not be held liable for any damages resulting from the use of this product.
- While every effort has been made to ensure that the information in these manuals is accurate and complete, we would appreciate it were you to bring any errors or omissions to the attention of the Nikon representative in your area (address provided separately).

Notice for customers in the U.S.A.

Federal Communications Commission (FCC) Radio Frequency Interference Statement

This equipment has been tested and found to comply with the limits for a Class B digital device, pursuant to Part 15 of the FCC rules. These limits are designed to provide reasonable protection against harmful interference in a residential installation. This equipment generates, uses, and can radiate radio frequency energy and, if not installed and used in accordance with the instructions, may cause harmful interference to radio communications. However, there is no guarantee that interference will not occur in a particular installation. If this equipment does cause harmful interference to radio or television reception, which can be determined by turning the equipment off and on, the user is encouraged to try to correct the interference by one or more of the following measures:

- Reorient or relocate the receiving antenna.
- Increase the separation between the equipment and receiver.
- Connect the equipment into an outlet on a circuit different from that to which the receiver is connected.
- Consult the dealer or an experienced radio/television technician for help.

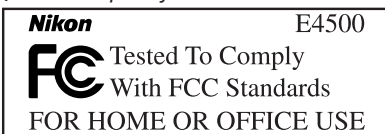

CAUTIONS

Modifications

The FCC requires the user to be notified that any changes or modifications made to this device that are not expressly approved by Nikon Corporation may void the user's authority to operate the equipment.

Interface Cables

Use the interface cables sold or provided by Nikon for your equipment. Using other interface cables may exceed the limits of Class B Part 15 of the FCC rules.

Nikon Inc.,
1300 Walt Whitman Road,
Melville, New York
11747-3064, U.S.A.
Tel.: 631-547-4200

Notice for customers in Canada

CAUTION

This class B digital apparatus meets all requirements of the Canadian Interference Causing Equipment Regulations.

ATTENTION

Cet appareil numérique de la classe B respecte toutes les exigences du Règlement sur le matériel brouilleur du Canada.

Notice Concerning Prohibition of Copying or Reproduction

Note that simply being in possession of material that has been digitally copied or reproduced by means of a scanner, digital camera or other device may be punishable by law.

• Items prohibited by law from being copied or reproduced

Do not copy or reproduce paper money, coins, securities, government bonds, or local government bonds, even if such copies or reproductions are stamped "Sample."

The copying or reproduction of paper money, coins, or securities which are circulated in a foreign country is prohibited.

Unless the prior permission of the government has been obtained, the copying or reproduction of unused postage stamps or post cards issued by the government is prohibited.

The copying or reproduction of stamps issued by the government and of certified documents stipulated by law is prohibited.

• Cautions on certain copies and reproductions

The government has issued cautions on copies or reproductions of securities issued by private companies (shares, bills, checks, gift certificates, etc.), commuter passes, or coupon tickets, except when a minimum of necessary copies are to be provided for business use by a company. Also, do not copy or reproduce passports issued by the government, licenses issued by public agencies and private groups, ID cards, and tickets, such as passes and meal coupons.

• Comply with copyright notices

The copying or reproduction of copyrighted creative works such as books, music, paintings, woodcut prints, maps, drawings, movies, and photographs is prohibited except when it is done for personal use at home or for similar restricted and non-commercial use.

Trademark Information

Apple, the Apple logo, Macintosh, Mac OS, PowerBook, and QuickTime are registered trademarks of Apple Computer, Inc. Finder, iMac, and iBook are trademarks of Apple Computer, Inc. IBM and Microdrive are registered trademarks of International Business Machines Corporation. Microsoft and Windows are registered trademarks of Microsoft Corporation. Pentium is a trademark of Intel Corporation. Internet is a trademark of Digital Equipment Corporation. CompactFlash is a trademark of SanDisk Corporation. Lexar Media is a trademark of Lexar Media Corporation. Adobe and Acrobat are registered trademarks of Adobe Systems Inc. Zip is a registered trademark of Iomega Corporation in the U.S. and other countries. All other trade names mentioned in this manual or the other documentation provided with your Nikon product are trademarks or registered trademarks of their respective holders.

Table of Contents

Product Documentation	i
For Your Safety	ii
Notices	iv
Introduction: Getting Started	1
Overview: About This Manual	2
Getting to Know the COOLPIX4500: The Parts of the Camera and Their Functions	4
Where to Find It—Parts of the COOLPIX4500	4
How to Use It—Camera Controls and Displays	6
First Steps: Getting Ready to Use Your Camera	9
Step 1—Attach the Camera Strap	9
Step 2—Insert the Battery	10
Step 3—Insert the Memory Card	12
Step 4—Choose a Language	14
Step 5—Set the Time and Date	15
Tutorial: Basic Photography and Playback	17
Taking Pictures: The Basics	18
Step 1—Ready the Camera	18
Step 2—Choose Auto Mode	19
Step 3—Adjust Camera Settings (Optional)	20
Step 4—Frame the Picture	20
Step 5—Focus and Shoot	24
Step 6—Put the Camera Away	26
Basic Playback: Quick Review and Playback	27
Quick Review	28
Full-Screen Playback	29
Thumbnail Playback	30
Connections: Connecting to External Devices	31
Connecting to a Computer: Nikon View 5	32
Before You Begin: Installing Nikon View 5	32
Making the Connection: Connecting to Your Computer	34
Connecting to a Television or VCR: Television Playback	40
Beyond Point-and-Shoot: Camera Controls	41
Shooting-Mode Selection: Shooting and Exposure Modes	42
Scene Mode	44
P: Programmed Auto	52
S: Shutter-Priority Auto	53
A: Aperture-Priority Auto	54
M: Manual	55

Focus Mode: Focusing Near and Far	57
Delaying Shutter Release: Self-Timer Mode	58
Autofocus	59
Manual Focus	61
Optical and Digital Zoom: Framing Pictures	62
Flash Mode: Flash Photography	64
The Sync Terminal	66
Making Movies (P, S, A, and M): Movie Mode	68
Exposure Compensation: Bright, Dark, and High-Contrast Subjects	69
Sensitivity (P, S, A, and M): Reacting Faster to Light	70
Keep or Delete: Picture Review	71
More About Playback: Playback Options	73
Taking a Closer Look: Playback Zoom	74
Creating a Small Copy of a Picture: Small Picture	75
Movie Playback	77
Adding Audio Commentary: Voice Memo	78
Photo Information	79
Menu Guide: Camera Menu Options	81
Index to Menu Options	82
Using Camera Menus: Basic Menu Operations	88
The Shooting Menu: Shooting Options	91
Keeping Colors True: <i>White Balance</i>	92
Measuring Light: <i>Metering</i>	95
Taking a Sequence of Shots: <i>Continuous</i>	96
Getting Sharper Pictures: <i>BSS (Best Shot Selector)</i>	98
Adjusting Contrast and Brightness: <i>Image Adjustment</i>	99
Controlling Color: <i>Saturation Control</i>	100
Making Effective Use of Memory: <i>Image Quality and Size</i>	101
Storing Menu Settings: <i>User Setting</i>	104
Making Edges More Distinct: <i>Image Sharpening</i>	105
Settings for Optional Converter Lenses: <i>Lens</i>	106
Controlling Exposure: <i>Exposure Options</i>	108
Controlling Focus: <i>Focus Options</i>	110
Controlling Zoom: <i>Zoom Options</i>	112
Controlling the Flash: <i>Speedlight Options</i>	114
Varying Settings Automatically: <i>Auto Bracketing</i>	116
Avoiding "Grainy" Photographs: <i>Noise Reduction</i>	118
Restoring Default Settings: <i>Reset All</i>	119

The Set-up Menu: Camera Setup	121
Adjusting Monitor Settings: <i>Monitor Options</i>	122
Customizing Camera Controls: <i>Controls</i>	123
Conserving Battery Power: <i>Auto Off</i>	125
File Numbering: <i>Seq. Numbers</i>	126
Audio Confirmation: <i>Shutter Sound</i>	127
Formatting Memory Cards: <i>CF Card Format</i>	128
Setting the Time and Date: <i>Date</i>	129
Confirming Shutter Release: <i>Shot Confirmation</i>	129
Storing Photo Info in a Separate File: <i>info.txt</i>	129
Choosing a Video Standard: <i>Video Mode</i>	130
Choosing a Language: <i>Language</i>	130
Protecting Images from Deletion: <i>Disable Delete</i>	131
Choosing a USB Option: <i>USB</i>	131
The Playback Menu: Managing Pictures	133
Deleting Pictures: <i>Delete</i>	133
Selecting a Folder for Playback: <i>Folders</i>	136
Automated Playback: <i>Slide Show</i>	138
Changing Vertical Perspective: <i>Perspective Control</i>	140
Choosing a Size for Small Pictures: <i>Small Pic.</i>	142
Safeguarding Valuable Pictures: <i>Protect</i>	143
Hiding Pictures During Playback: <i>Hide Image</i>	144
Ordering Prints: <i>Print Set</i>	145
Selecting Images for Transfer: <i>Auto Transfer</i>	147
Technical Notes: Camera Care, Options, and Resources	149
Optional Accessories	150
Caring for the Camera and Battery	152
Web Resources	155
Troubleshooting	155
Specifications	161
Index	165

Introduction

Getting Started

Overview



2-3



Getting to Know the COOLPIX4500



4-8



First Steps



9-16



This chapter is divided into the following sections:

Overview

Read this section for a description of how this manual is organized and for an explanation of the symbols and conventions used.

Getting to Know the COOLPIX4500

Bookmark this section and refer to it as you read through the manual for information on the names and functions of camera parts.

First Steps

This section details the steps you will take when using your camera for the first time:

STEP 1	Attach the Camera Strap		9
STEP 2	Insert the Battery		10-11
STEP 3	Insert the Memory Card		12-13
STEP 4	Choose a Language		14
STEP 5	Set the Time and Date		15-16

Thank you for your purchase of a COOLPIX4500 digital camera. This manual has been written to help you enjoy taking digital pictures with your COOLPIX4500. Read this manual thoroughly before use, and keep it handy when using the product.

Use Only Nikon Brand Electronic Accessories

Your Nikon COOLPIX digital camera is designed to the highest standards and includes complex electronic circuitry. Only Nikon brand electronic accessories (including battery chargers, batteries, and AC adapters) certified by Nikon specifically for use with your Nikon digital camera are engineered and proven to operate within the operational and safety requirements of this electronic circuitry.

THE USE OF NON-NIKON ELECTRONIC ACCESSORIES COULD DAMAGE YOUR CAMERA AND MAY VOID YOUR NIKON WARRANTY.

For more information about Nikon brand accessories, contact your local authorized Nikon dealer.

To make it easier to find the information you need, the following symbols and conventions are used:



This icon marks cautions, information that you should read before use to prevent damage to your camera.



This icon marks tips, additional information you may find helpful when using your camera.



This icon marks notes, information that you should read before using your camera.



This icon indicates that more information is available elsewhere in this manual.



Life-Long Learning

As part of Nikon's "Life-Long Learning" commitment to ongoing product support and education, continually-updated information is available on-line at the following sites:

- For users in the U.S.A.: <http://www.nikonusa.com/>
- For users in Europe: <http://www.nikon-euro.com/>
- For users in Asia, Oceania, the Middle East, and Africa:
<http://www.nikon-asia.com/>

Visit these sites to keep up-to-date with the latest product information, tips, answers to frequently-asked questions (FAQs), and general advice on digital imaging and photography. Additional information may be available from the Nikon representative in your area. See the URL below for contact information:
<http://www.nikon-image.com/eng/>

Getting to Know the COOLPIX4500

The Parts of the Camera and Their Functions

Take a few moments to familiarize yourself with camera controls and displays. You may find it helpful to bookmark this section and refer to it as you read through the rest of the manual.

Where to Find It—Parts of the COOLPIX4500

The parts of the camera are identified below. For more information on the function of each part, refer to the page numbers listed.

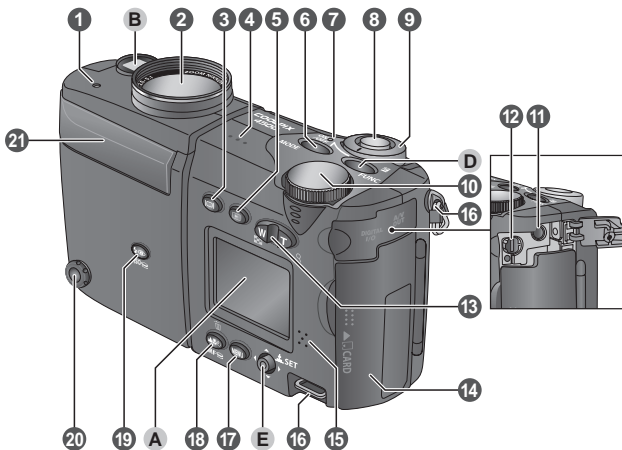

- | | | | |
|---|--------|--|------------|
| 1 Self-timer lamp | 58 | 9 Power switch | 18, 26 |
| 2 Lens | 9, 154 | 10 Command dial | |
| 3 (monitor) button | 23 | 11 Audio/video (A/V) out connector (under cover) | 40 |
| 4 Microphone | 68, 78 | 12 USB connector (under cover) | 35 |
| 5 (quick review/playback) button | 27 | 13 Zoom (/) buttons | 30, 62, 74 |
| 6 MODE (exposure mode)/ SMALL PIC. button | 43, 75 | 14 Memory card-slot cover | 12 |
| 7 Power-on lamp | 18, 26 | 15 Speaker | 77, 78 |
| 8 Shutter-release button | 24 | 16 Eyelets for camera strap (x2) | 9 |

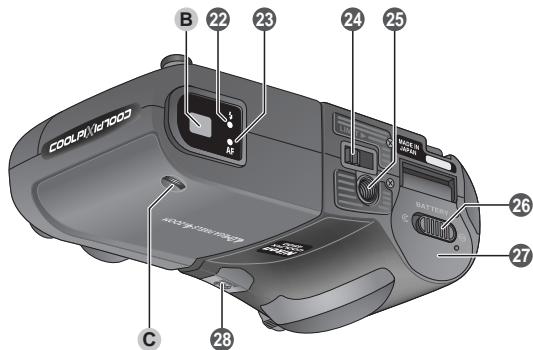

- 17 MENU button 44, 88
- 18 (focus mode) button 57
- MF (manual focus) button 61
- (delete) button .. 29, 30, 71, 78
- 19 (flash mode) button 65
- ISO (sensitivity) button 70
- 20 Sync terminal 66
- Removing the sync terminal cover

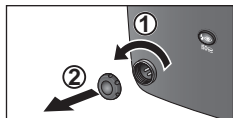

- 21 Built-in Speedlight 21, 64
- Speedlight raised

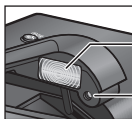

Flash window
Photocell

- 22 Flash-ready lamp (red) 7, 24
- 23 Autofocus lamp (green) 7, 24
- 24 Swivel limit switch 21
- 25 Tripod socket
- 26 Battery-chamber cover latch ... 10
- 27 Battery-chamber cover 10
- 28 DC-in connector cover

- A Monitor 6
- B Viewfinder 7
- C Diopter adjustment dial 8
- D FUNC / (exposure compensation) button 8, 69, 123
- Voice memo button 78
- E Multi selector 8, 88, 110



How to Use It—Camera Controls and Displays

A The Monitor

Photographs can be framed in the *monitor* or viewfinder. During shooting, the monitor shows the view through the camera lens together with icons indicating the status of the following camera settings:

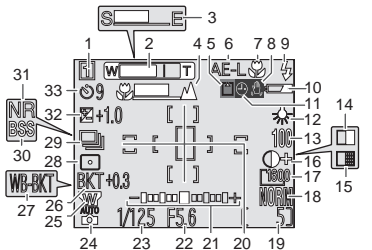

1 User Setting no. (User Set) ..	104
2 Zoom indicator	62
3 Progress bar (Ultra HS)	97
4 Manual focus indicator	61
5 Recording indicator	25
6 Exposure lock	50, 108, 124
7 Focus mode	57
8 Camera shake icon	45
9 Flash mode	65
10 Battery level indicator ¹	18
11 "Date not set" icon ²	16
12 White balance	92
13 Sensitivity-gain (ISO) indicator ³	70
14 Black-and-white mode indicator	100
15 Sepia mode indicator	100
16 Image adjustment	99
17 Image size	103
18 Image quality	102
19 Number of exposures remaining/ length of movie	18, 68
20 Focus areas/spot metering target	95, 110
21 Exposure display	55
22 Aperture	54, 55
23 Shutter speed	53, 55
24 Exposure/scene mode	42, 44
25 Converter lens setting	106
26 Bracketing indicator	117
27 White-balance bracketing indicator	117
28 Metering mode	95
29 Continuous shooting mode	96
30 Best Shot Selector (BSS)	98
31 Noise reduction	118
32 Exposure compensation ...	69, 109
33 Self-timer indicator	58

¹ Appears only when battery is running low.

² Appears when clock-calendar has not been set.

³ Appears at sensitivity (ISO equivalency) other than AUTO. ISO displayed when sensitivity is raised above ISO 100 at setting of AUTO.

The monitor is also used to play pictures back. When a picture is played back full screen, information about the image is shown superimposed on the photo.

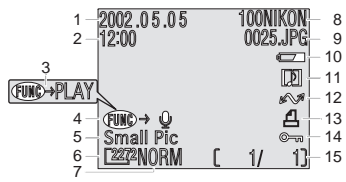

- 1 Date of recording 15
- 2 Time of recording 15
- 3 Voice memo playback guide... 78
- 4 Voice memo recording guide.. 78
- 5 Small picture indicator 75
- 6 Image size 103

- 7 Image quality 102
- 8 Folder 136
- 9 File number and type 79
- 10 Battery-level indicator* 18
- 11 Voice memo icon 78
- 12 Transfer icon 147
- 13 Print-order icon 145
- 14 Protect icon 143
- 15 Current frame number/total number of frames visible in current folder

* Appears only when battery is running low.

B The Viewfinder

Like the monitor, the *viewfinder* can be used to frame photographs. Use the viewfinder when bright ambient lighting makes it difficult to see the view in the monitor.

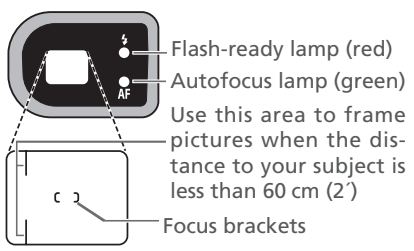

When your subject is within 90 cm (2'11") of the camera, the final picture will differ slightly from the image seen in the viewfinder. Use the smaller of the two frames in the viewfinder or frame pictures in the monitor. Pictures should also be framed in the monitor when using digital zoom, an image size of 3 : 2, or an optional lens converter.

The flash-ready (red) and autofocus (green) lamps next to the viewfinder offer visual confirmation of flash status and focus.





C The Diopter Adjustment Dial

If the image in the viewfinder seems out of focus, rotate the viewfinder *diopter adjustment dial* until the image in the viewfinder is clearly in focus.





D The FUNC Button

By default, the **FUNC** button functions as an exposure compensation button in shooting mode ( 69) and in playback mode as a record button for recording audio commentary ( 78). Other functions can be assigned to the **FUNC** button using the **FUNC** option in the setup menu ( 123).



E The Multi Selector

The *multi selector* can be pressed up, down, left, or right to navigate the camera menus ( 88), select the focus area ( 110), and to scroll through and select pictures during playback. When menus are displayed, pressing the center of the multi selector puts your selections into effect.



Before using your camera for the first time, complete the steps on the following pages.

Step 1—Attach the Camera Strap

Attach the camera strap as shown. Repeat for the second eyelet.

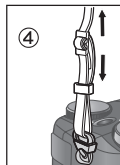
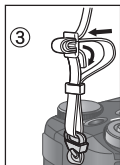
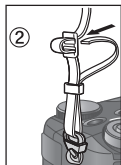
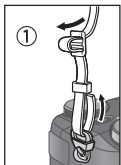

To avoid losing the lens cap, attach it to the camera strap using the cord supplied with your camera. When removing or replacing the lens cap, press the latch as shown.

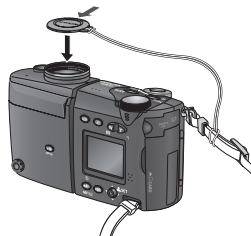

Step 2—Insert the Battery

Your Nikon digital camera takes a single rechargeable Nikon EN-EL1 lithium-ion battery (provided) or non-rechargeable 2CR5 (DL245) lithium battery (available separately).

2.1 Charge the battery

The EN-EL1 is not fully charged at shipment. A battery charger is provided with the camera; we recommend that you charge the battery before use. Instructions for charging the battery may be found in the instruction manual included with the charger.

2.2 Open the battery-chamber cover

If the camera is on a tripod, you will need to remove the tripod before opening the cover. Slide the battery-chamber cover latch to the open position (1) and flip the battery-chamber cover open (2).

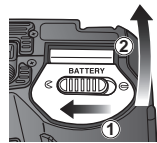

✓ Read Battery Warnings

Read and follow all warnings and instructions supplied by the battery manufacturer.

💡 Alternative Power Sources

In addition to the rechargeable Nikon EN-EL1 lithium battery included with your camera, the COOLPIX4500 can be used with non-rechargeable 2CR5 (DL245) lithium batteries, available at a variety of retail outlets. To power your camera continuously for extended periods, use an EH-21 AC adapter/battery charger or EH-53 AC adapter (both available separately).



Connecting AC adapter to COOLPIX4500 DC-in connector

2.3 Insert the battery

Insert a fully-charged EN-EL1 or new 2CR5 (DL245) battery as shown in the label on the underside of the battery-chamber cover. The power-on lamp will light briefly when the battery is inserted.

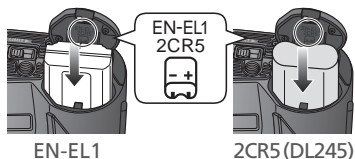

2.4 Close the battery-chamber cover

Close the battery chamber cover (1) and slide the latch to the closed position (⊖; 2). To prevent the battery being dislodged during operation, be sure that the battery-chamber cover is properly latched.

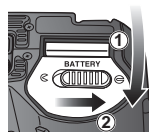

The Clock Battery

The camera's internal clock-calendar is powered by a separate, rechargeable power source, which is charged as necessary when the main battery is installed or the camera powered by an AC adapter (available separately). After charging for about ten hours, this power source can provide roughly three days of back-up power. If the main battery has been removed for an extended period, or removed before charging is complete, a flashing  icon may appear in the monitor, indicating that the clock needs to be reset.

Step 3—Insert the Memory Card

Your Nikon digital camera uses CompactFlash™ (CF) memory cards or IBM Microdrive® memory cards to store pictures. See “Technical Notes: Optional Accessories” (📖 151) for a list of approved memory cards

3.1 Turn the camera off

Make sure that the power-on lamp is off before inserting or removing memory cards. Rotating the power switch in the direction shown turns the camera on and off.



3.2 Insert the memory card

Open the card-slot cover (see (1) below) and make sure the eject button is pressed all the way down (2).

Memory cards are labeled with an arrow (▲) showing the direction of insertion. Holding the card with this label facing the card-slot cover, insert the card in the direction of the arrow (3), sliding it in until it is firmly in place.

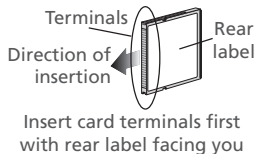
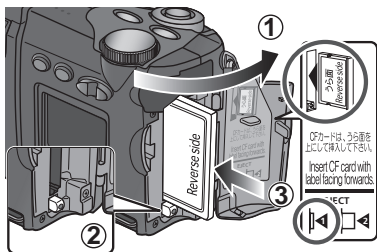

3.3 Close the card slot cover

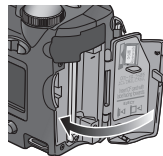

Closing the Card-Slot Cover

If the eject button is up when the card-slot cover is closed, closing the cover will partially eject the memory card, causing errors when the camera is turned on. Be sure the eject button is down (i.e., in position ) before inserting memory cards.

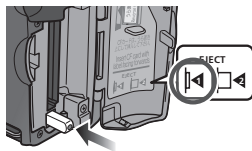

Formatting Memory Cards

The memory card supplied with your camera is formatted at shipment. Other memory cards, however, must be formatted before first use. For information on formatting memory cards, see “The Setup Menu: Formatting Memory Cards” ( 128).

Removing Memory Cards

Memory cards can be removed without loss of data when the camera is off. To remove memory cards, turn the camera off and open the card-slot cover. Press the eject button to pop it up to position  (1), then press it again to partially eject the card (2). You can then remove the card by hand (3).

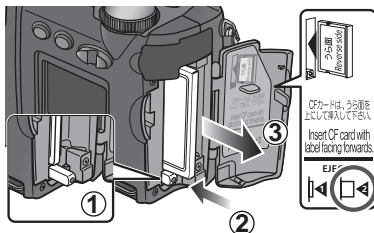

Step 4—Choose a Language

Camera menus and messages can be displayed in your choice of German, English, French, Japanese, and Spanish.



4.1

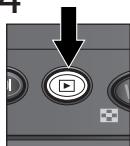

Rotate power switch in direction shown to turn camera on. Power-on lamp will light.

4.2



Press  button. If message appears in monitor, proceed to Step 4.3. If photo is displayed in top left corner of monitor, press  button again to enter playback mode.

4.3

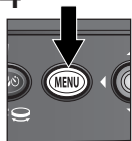

Display playback menu

4.4

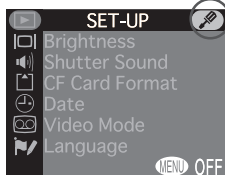

Display set-up menu 

4.5

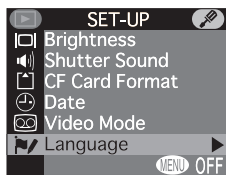

Highlight  Language

4.6

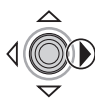

Display options

4.7

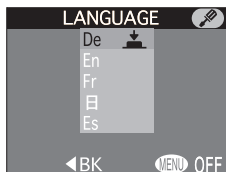

Choose language from **Deutsch** (German), **English**, **Français** (French), **日** (Japanese), or **Español** (Spanish)

4.8

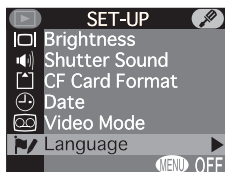

Make selection and return to setup menu. If you have yet to set the time and date, proceed to Step 5.1.

Step 5—Set the Time and Date

Information on the time and date of recording is included with all photographs and movies taken with your Nikon digital camera. To set the camera's internal clock to the correct time and date, display the set-up menu as described in steps 4.1–4.4 of "Choosing a Language" and then follow the steps below:

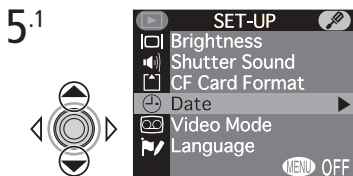

Highlight Date

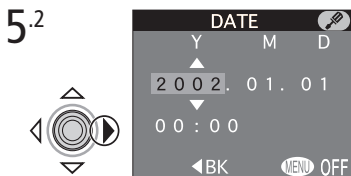

Display DATE menu

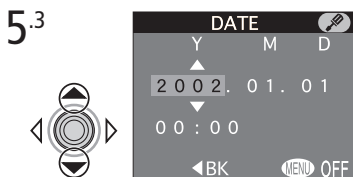

Edit Year

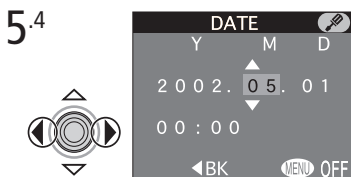

Highlight next item. Repeat steps 5.3–5.4 to edit Month, Day, hour, and minute.

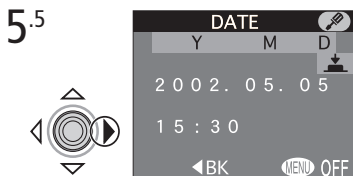

Highlight Y M D

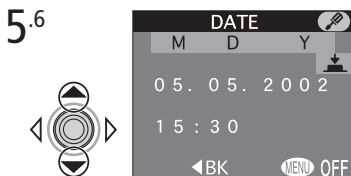

Choose order in which year, month, and day will be displayed

5.7

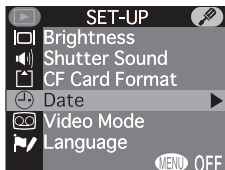

Save changes to settings and return to setup menu. To exit menus, press MENU button.

Any pictures taken before the time and date have been set will have a time stamp of "0000.00.00 00:00." If the time and date have not been set, a flashing  ("date not set") icon will be displayed in the top right corner of the monitor during shooting.

Tutorial

Basic Photography and Playback

Taking Pictures



18–26



Basic Playback



27–30



This chapter takes you through the basic steps involved in taking pictures and playing them back.

Taking Pictures

Read this section for a step-by-step guide to the basics of taking pictures with the COOLPIX4500:

STEP 1	Ready the Camera		18–19
STEP 2	Choose Auto Mode		19
STEP 3	Adjust Settings (Optional)		20
STEP 4	Frame the Picture		20–23
STEP 5	Focus and Shoot		24–25
STEP 6	Put the Camera Away		26

Basic Playback

This section describes how to view pictures in the monitor.

This section details the basic steps involved in taking pictures in  (auto) mode. In this automatic, “point-and-shoot” mode, the majority of settings are controlled by the camera in response to lighting conditions and focus distance, producing the best possible results in most situations.

Step 1—Ready the Camera

- 1.1 Remove the lens cap
Press the latch and remove the cap as shown.



- 1.2 Turn the camera on
Rotate the power switch as shown. When the power-on lamp lights, the camera is ready to shoot.



- 1.3 Check the indicators in the monitor
Before shooting, check the battery level (A) and the number of exposures remaining (B).

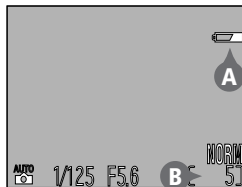

Auto Power Off

To save power, the camera will turn off automatically if no operations are performed for the period of time specified in the **Auto Off** menu ( 125). When the camera turns off, the power-on lamp will go out. The camera can be reactivated using the power switch.

Battery level is displayed as follows:



Display	Meaning	Camera status
NO ICON	Battery fully charged.	Camera functions normally.
	Low battery. Charge EN-EL1 as soon as possible or ready new 2CR5 (DL245) battery.	As above, except that only a limited number of shots can be taken in "continuous" mode (📷 96).
Warning !! Battery exhausted*	Battery exhausted. Charge EN-EL1 and reinsert, or use new 2CR5 (DL245) battery.	Shutter release disabled.

*Flash-ready and autofocus lamps next to viewfinder blink slowly when battery is exhausted.

If the message "Out of memory" appears in the monitor, the memory card is full. Delete pictures (📷 133), use a new memory card, or choose a lower quality or image size (📷 101).

Step 2—Choose Auto Mode

The description in this section assumes that the camera is in  (auto) mode, a "point-and-shoot" mode in which the majority of settings are controlled by the camera.

The camera is set to  mode at shipment. If the  icon is not displayed in the bottom left corner of the monitor when you turn the camera on, choose  mode as follows:

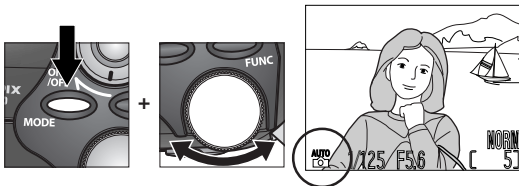

Press MODE button and rotate command dial until  icon is displayed

Step 3—Adjust Camera Settings (Optional)

The following table shows the default settings for **AUTO** mode. For more information, refer to the page numbers in the rightmost column.

Setting	Default	Description	
Flash mode	Auto	Built-in Speedlight pops up and fires automatically when lighting is poor.	64–67
Focus mode	Autofocus	Camera focuses automatically at distances over 30 cm/1' (50 cm/1'8" at the widest angle).	57–58
Image quality	NORMAL	Pictures compressed for balance between image quality and file size that is ideal for snapshots.	101–102
Image size	2,272 × 1,704	Pictures are 2,272 × 1,704 pixels in size.	101–103
Continuous	Single	One shot taken each time shutter-release button is pressed.	96–97

Step 4—Frame the Picture

4.1 Adjust the lens angle

From a position parallel to the camera body, the lens section can be rotated forward 210° or 90° back towards the monitor. To frame a quick arms-length self-portrait, rotate the lens to point in the same direction as the monitor (in this position, the monitor shows a mirror image of what will appear in the final photograph).

When rotating the lens section, do not use force, and do not attempt to rotate the lens section past the limits specified above.

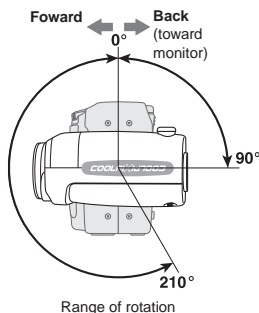

4.2 Ready the camera

Pictures can be framed in the monitor (A) or viewfinder (B). To prevent your pictures from being blurred by inadvertent camera movement (camera shake), hold the camera steadily in both hands. In auto mode, the built-in Speedlight pops up automatically when lighting is poor. Do not place your fingers on top of the built-in Speedlight.

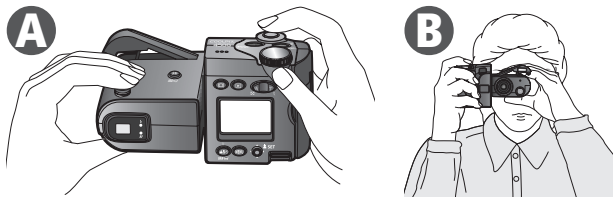

The Built-in Speedlight

If the flash mode is set to auto (the default setting), red-eye reduction, or slow sync and additional light is required for correct exposure, the built-in Speedlight will pop up automatically when the shutter-release button is pressed halfway. At a setting of Anytime Flash (fill flash), the built-in Speedlight will pop up whenever the shutter-release button is pressed halfway. Do not attempt to raise the Speedlight by hand.

If your finger or another object obstructs the Speedlight, preventing it from popping up when a picture is taken, a message will appear in the monitor, and the flash-ready lamp will flicker.

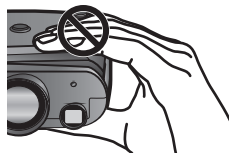

Swivel Limit

To prevent the lens section from rotating more than 90° forward, slide the swivel limit switch as shown at right. This prevents unintended rotation when a converter lens (available separately) is attached.

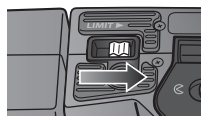

4.3 Frame your subject

Use the zoom buttons to frame your subject against the background.



Zoom out



Zoom in

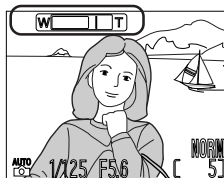



Indicator in monitor shows amount of zoom while either button is pressed

When the camera is zoomed all the way in, hold the **D** button down for about two seconds to enlarge the image digitally (digital zoom;  63). When digital zoom is in effect, the autofocus lamp next to the viewfinder will blink and the zoom indicator will turn yellow to warn you to frame pictures in the monitor.

Monitor or Viewfinder?

Use the monitor to confirm camera settings at a glance while at the same time viewing an image that shows how the final picture will appear. This is particularly important when the image in the viewfinder does not accurately reflect what will appear in the final picture, for example when:

- focusing at ranges of less than 90 cm (2'11")
- using digital zoom ( 63), an image size setting of 3 : 2 ( 103), or an optional converter lens ( 150)

When using the monitor, you also have the advantage of being able to frame pictures with the camera held at almost any angle. You can even point the camera at yourself and frame a quick self-portrait in the monitor.

The viewfinder can be used when bright ambient lighting conditions make the display in the monitor difficult to see. When framing pictures in the viewfinder at ranges of around 60 cm (2') or less, be sure to use the smaller of the two frames in the viewfinder display.



Use this frame at ranges of around 60 cm (2') or less

Don't Block the Shot

To avoid dark or partially obscured pictures, keep your fingers and other objects away from the lens and flash window.

Controlling the Monitor

Press the  button to hide indicators and turn the monitor on and off.

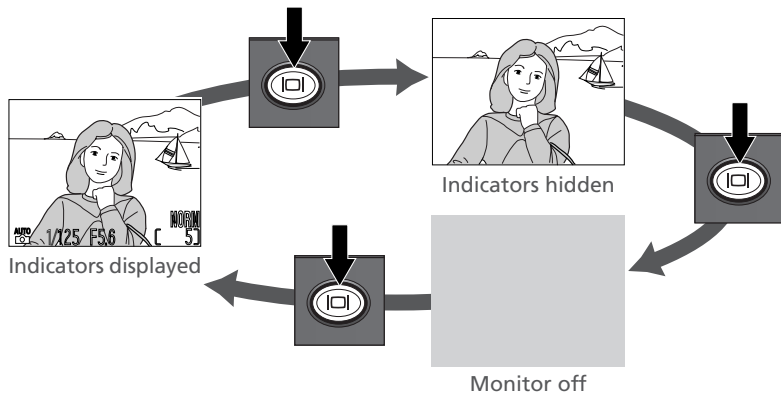



Step 5—Focus and Shoot

The COOLPIX4500 has a two-stage shutter-release button.

5.1 Focus

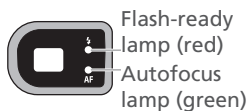
Press the shutter-release button halfway to set focus and exposure. In  mode, the camera will focus on the subject in the center focus area, shown by the focus brackets in the viewfinder. Focus will remain locked at this distance while the shutter-release button is pressed halfway. If your subject is poorly lit and the flash is set to auto, the flash will pop up automatically and begin charging. Check the status of the autofocus (green) and flash-ready (red) lamps next to the viewfinder.



Flash-ready lamp (red)	On	Flash will fire when picture is taken.
	Blinks rapidly	Flash charging. Remove finger briefly from shutter-release button, then try again.
	Flickers	<ul style="list-style-type: none"> Flash is off and subject poorly lit. Shutter speed will slow and pictures may be blurred. Finger or other object placed on top of built-in Speedlight, preventing it from popping up. Remove object from built-in Speedlight.
	Off	Flash off or not required.
Autofocus lamp (green)	On	Subject in focus.
	Flickers	Camera unable to focus on subject in focus brackets. See "Autofocus" ( 59).
Both lamps blink together slowly		Battery exhausted. Replace with fully-charged EN-EL1 or new 2CR5 (DL245) battery.

5.2 Take the picture



Smoothly press the shutter-release button the rest of the way down to take a picture.



During Recording

While pictures are being recorded to the memory card, a  icon will be displayed in the monitor and the autofocus lamp (green) will blink.

Pictures taken while earlier images are being recorded are stored in a temporary memory buffer. When the buffer is full, an hourglass  icon will be displayed and the shutter release will be disabled.

Do not turn the camera off, remove the memory card, or remove or disconnect the power source while  or  is displayed or while the green autofocus lamp is blinking.

Step 6—Put the Camera Away

6.1 Turn the camera off

If the power lamp is on, turn the camera off by rotating the power switch as shown. The power-on lamp will go out. To save battery power, make sure that the power-on lamp is off before putting the camera away.



6.2 Lower the built-in Speedlight

If the built-in Speedlight is raised, push it gently back to the closed position, pressing straight down on the top of the Speedlight. Do not apply force to the front, back, or sides, as this could damage the Speedlight.

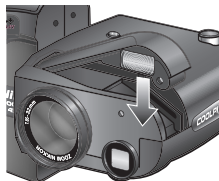

6.3 Return the lens section to the storage position

Rotate the lens section to the position shown at right.

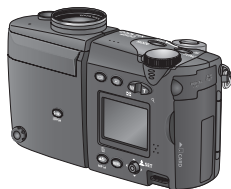

6.4 Replace the lens cap

To protect the lens, replace the lens cap before putting the camera away.

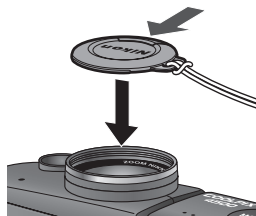

Basic Playback

Quick Review and Playback

With a digital camera, you can view pictures immediately after they are taken. You can view the results of earlier attempts while setting up your next shot and use what you see to change camera settings or choose a better angle.

To view pictures, press the  button.

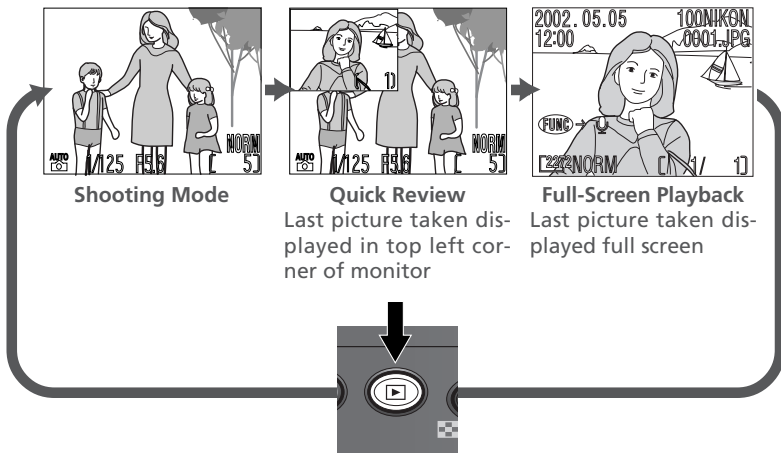

To end quick review or full-screen playback and focus the camera for the next shot, press the shutter-release button halfway.

✓ During Playback

While pictures are being read from the memory card, the green autofocus lamp next to the viewfinder will blink. *Do not eject the memory card or remove or disconnect the power source until the lamp has stopped blinking.* Removing the card or cutting power in these circumstances could result in loss of data or in damage to the camera or card.

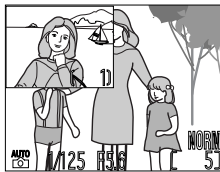

Quick Review

Pictures are displayed in the top left corner of the monitor, allowing you to confirm the results of previous attempts while setting up your next shot. All controls function as they do in shooting mode, with the following exceptions:



To	Press	Description
View other pictures		Press the multi selector down to or right to view pictures in the order recorded, up or left to go back.
View current picture full screen		Enter full-screen playback (see opposite) with the current picture displayed full screen.

When the Memory Card Contains No Pictures

If no pictures are available for playback or all images on the memory card are hidden ( 144), a message will be displayed when the  button is pressed to enter quick review. Press the  button again or press the shutter-release button halfway to return to shooting mode.

Full-Screen Playback

In full-screen playback, you can perform a variety of operations on the pictures stored on the memory card. In addition to the controls listed below, you can also use the options in the playback menu (▶ 133).

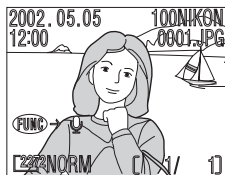



To	Press	Description
View other pictures		Press the multi selector down to or right to view pictures in the order recorded, up or left to go back. Keep multi selector pressed to scroll rapidly to the desired frame number.
View multiple pictures		Press the () button to display up to nine pictures at a time as small thumbnail previews (see following page).
Delete current picture		<p>A confirmation dialog will be displayed. Press multi selector up or down to highlight option, press center to select.</p> <ul style="list-style-type: none"> • Select No to exit without deleting picture • Select Yes to delete picture
Return to shooting mode	/ Shutter release	End playback and return to shooting mode.









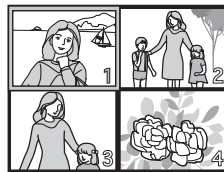



For more information on:

73 Playback

Thumbnail Playback

Pressing the  () button in full-screen playback displays a menu of up to nine thumbnail images. The following operations can be performed while thumbnails are displayed:

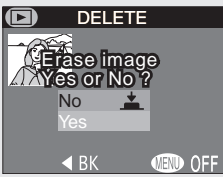

To	Press	Description
Highlight pictures		Press the multi selector up, down, left, or right to highlight thumbnails.
Page through images		Rotate command dial to scroll through images a page at a time.
Change number of pictures displayed	 () /  ()	With four thumbnails displayed, press the  button once to view nine thumbnail images. Press  () to “zoom in” from nine thumbnails to a four-thumbnail view or, when four thumbnails are displayed, to view highlighted picture full size.
Delete highlighted picture	 ()	<p>A confirmation dialog will be displayed. Press multi selector up or down to highlight option, press center to select.</p>  <ul style="list-style-type: none"> • Select No to exit without deleting picture • Select Yes to delete picture
Return to shooting mode	 / Shutter release	End playback and return to shooting mode.

Connections

Connecting to External Devices

Connecting to a
Computer



32–39



Connecting to a
Television or VCR



40



This chapter provides information on connecting your camera to a computer and to a television or videocassette recorder (VCR).

Connecting to a Computer

Read this section to learn how to copy pictures from the camera memory card to your computer using Nikon View 5.

Connecting to a Television or VCR

This section details how you can view pictures and menus on a television screen.

Your Nikon digital camera stores pictures as digital data. Instead of making the trip to a developer and getting negatives, you can simply copy your pictures to a computer for long-term storage using the Nikon View 5 software provided with your camera. Once transferred to your computer, your pictures can be viewed, printed, sent to your acquaintances via e-mail, or saved to a Zip disk or other removable media for delivery to a photofinisher. Any copies stored on the memory card after transfer can be deleted to make way for new pictures, which you can then add to the growing digital photo album on your computer.

Before You Begin: Installing Nikon View 5

Before copying pictures to your computer, you will need to install Nikon View 5, an application that allows you to transfer pictures from the camera memory card to a computer hard disk and view them on the computer monitor. To install Nikon View 5, you must have a computer running one of the following operating systems:

Windows	Pre-installed versions of Windows XP Home Edition, Windows XP Professional, Windows 2000 Professional, Windows Millennium Edition (Me), or Windows 98 Second Edition (SE).
Macintosh	Mac OS 9.0, 9.1, 9.2, Mac OS X (10.1.2 or later). Only models with built-in USB ports supported.

The first step to installing Nikon View 5 is to read the installation instructions. These are included on the reference CD provided with your camera.



1 Insert the reference CD

After turning on your computer and waiting for the operating system to start up, place the reference CD in a CD-ROM drive.



Under Mac OS 9, the reference CD will open automatically on the desktop. If you are using Mac OS X, double-click the **Nikon** icon to open the reference CD. Windows users will need first to double-click the **My Computer** icon and then the **Nikon** icon to open the reference CD window.

2 Install Adobe Acrobat Reader

The installation instructions are in Portable Document Format (PDF). To view the instructions, you will need Adobe Acrobat Reader 4.0 or later. If you have already installed this version of Acrobat, proceed to Step 3.

To install Adobe Acrobat Reader, open the folder for the language of your choice and double-click the installer icon. The installer start-up screen will be displayed; follow the on-screen instructions to complete installation.

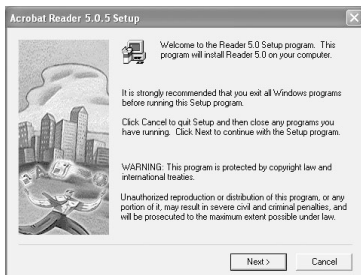

Start-up screen (Windows)

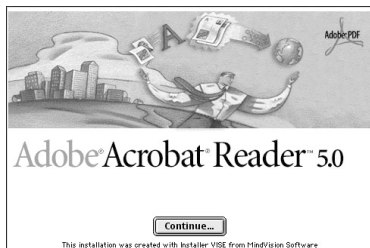

Start-up screen (Macintosh)

3 Read installation instructions for Nikon View 5

Once you have installed Adobe Acrobat Reader, double-click the **INDEX.pdf** icon in the root directory of the reference CD to view a clickable index of the documentation available for Nikon View 5. Follow the links to view the installation instructions for your computer system. If desired, you can print the installation instructions using the **Print...** command in the Acrobat **File** menu, and follow along during installation of Nikon View 5.

Already Have Nikon View?

In order to transfer pictures to your computer using the UC-E1 USB cable, the COOLPIX4500 requires the version of Nikon View 5 provided with the camera. If you have a version of Nikon View that was included with another Nikon digital camera, you will need to upgrade to the version provided with the COOLPIX4500.

Making the Connection: Connecting to Your Computer

Once you have installed Nikon View 5, you are ready to transfer photographs and movies to your computer. Pictures can be transferred via a direct USB connection between the camera and computer, or by removing the memory card from the camera and inserting it in a card reader or PC card slot.

Direct Connection: Connecting Your Camera by Cable

If your computer has a built-in USB interface, you can connect it to your camera using the UC-E1 cable provided.

1 Turn the computer on



Windows 2000 Professional, Windows Millennium Edition (Me), Windows 98 Second Edition (SE), Mac OS 9

When connecting the camera to a computer running one of the above operating systems, do not select **PTP** for the **USB** option in the camera setup menu (131). If **PTP** is selected, the computer will display a dialog stating that it has found new hardware or that the drivers for the device can not be used. Click **Cancel** to exit the dialog. Disconnect the camera and select **Mass Storage** from the camera **USB** menu, then reconnect the camera as described above.



Windows XP Home Edition, Windows XP Professional, Windows 2000 Professional

When installing, uninstalling, or running Nikon View 5 under Windows XP Home Edition or Windows XP Professional, log in as the "Computer administrator". When installing, uninstalling, or running Nikon View 5 under Windows 2000 Professional, log in to the Administrator account.

2 Connect the camera and computer

Connect the UC-E1 USB cable as shown below. Use the flat connector for connection to the computer, and connect the other end of the cable to the camera's USB connector. Do not connect the camera via a USB hub or keyboard.

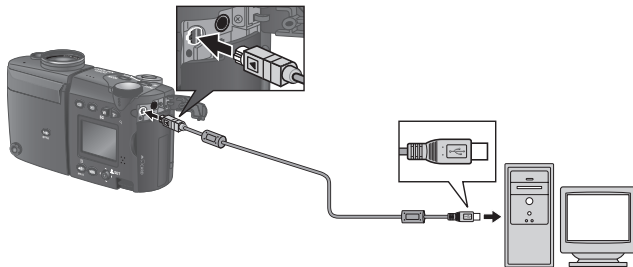

3 Turn the camera on

Turn the camera on. Nikon View 5 will detect the camera and start automatically. For details, see the *Nikon View 5 Reference Manual* (on CD). While the UC-E1 USB cable is connected, the camera monitor will remain off, and all controls except the power switch will be inactive.

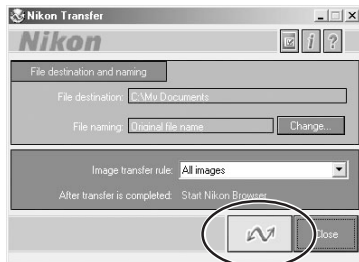

Before Connecting the Camera

Be sure to install Nikon View 5 *before* connecting your camera.

Use a Reliable Power Source

When transferring data between the camera and the computer, be sure that the battery is fully charged. If in doubt, recharge the battery before beginning transfer or use the optional EH-21 AC adapter/battery charger or EH-53 AC adapter.

4 Transfer pictures to your computer

To copy all pictures on the memory card to your computer, select **All images** from the **Image transfer rule** menu in Nikon View 5 and click the  button to begin transfer. While pictures are being copied to the computer, do not:

- Disconnect the USB cable.
- Turn the camera off.
- Remove the memory card.

5 View pictures



When transfer is complete, the pictures that have been copied to your computer's hard disk will be displayed in Nikon Browser. See the *Nikon View 5 Reference Manual* (on CD) for details of the operations that can be performed.

6 Remove the camera from the system

If you are using Windows XP Home Edition, Windows XP Professional, or Mac OS X (version 10.1.2 or later) with the camera **USB** option set to **PTP** ( 131), you can turn the camera off and disconnect the USB cable once transfer is complete.





Panorama Assist/Ultra HS

Before transferring pictures for the first time, click the **Change...** button in the Nikon Transfer window and check **Copy folder names from camera**. This will ensure that each sequence of pictures created at settings of **Panorama Assist** ( 50) or **Ultra HS** ( 96) will be copied to a separate folder.



Selecting Pictures for Transfer

To copy only pictures marked for transfer using the **Auto Transfer** option in the playback menu ( 147), select **Images marked for transfer** from the **Image transfer rule** menu before clicking the  button in the Nikon Transfer window.

If the camera **USB** option is set to **Mass Storage** (the default option), you must remove the camera from the system as follows before disconnecting the cable or turning the camera off:

Windows XP Home Edition/Windows XP Professional

Click the “Safely Remove Hardware” icon  in the taskbar and select **Safely remove USB Mass Storage Device** from the menu that appears.



Windows 2000 Professional

Click the “Unplug or Eject Hardware” icon  in the taskbar and select **Stop USB Mass Storage Device** from the menu that appears.

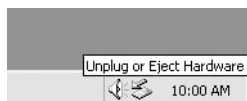

Windows Millennium Edition (Me)

Click the “Unplug or Eject Hardware” icon  in the taskbar and select **Stop USB Disk** from the menu that appears.



Windows 98 Second Edition (SE)

In My Computer, click with the right mouse button on the removable disk corresponding to the camera and select **Eject** from the menu that appears.



Mac OS X

Drag the “NO_NAME” camera volume into the Trash.



Mac OS X



Mac OS 9

Mac OS 9

Drag the “untitled” camera volume into the Trash.

Reading Pictures from Memory Cards

If you have a CompactFlash™ card reader or your computer is equipped with a PC card slot, you can transfer pictures directly from the memory card. Before inserting the memory card in a card reader or card slot, turn the camera off and remove the card from the camera.

1 Turn the computer on

Turn the computer on and wait for the operating system to start up.

2 Insert the memory card

If you are using a PC card slot, insert the memory card into a PC card adapter (see note below), and then insert the adapter into the PC card slot. If you are using a card reader, insert the memory card directly into the card reader. If installed, Nikon View 5 will detect cards from Nikon digital cameras and start automatically. See the *Nikon View 5 Reference Manual* (on CD) for information on transferring pictures to your computer.

CompactFlash™ Card Readers

Before using a card reader, be sure to read all documentation provided by the manufacturer.

PC Card Adapter

To read CompactFlash™ memory cards using a PC card slot, you will require an EC-AD1 PC-card adapter (shown at right), available separately from Nikon.



Removing the Memory Card

Be sure that transfer is complete before removing memory cards from the card reader or PC card slot.

Before removing the memory card from a PC card slot or card reader, you will need to remove the card from the system:

Windows XP Home Edition/Windows XP Professional

Click the “Safely Remove Hardware” icon () in the taskbar and remove the memory card from the system.

Windows 2000 Professional/Windows Millennium Edition (Me)

Click the “Unplug or Eject Hardware” icon () in the taskbar and remove the memory card from the system.

Windows 98 Second Edition (SE)

In My Computer, right click on the removable disk corresponding to the memory card and select **Eject** from the menu that appears.

Mac OS X

Drag the “NO_NAME” volume that represents the memory card into the Trash.

Mac OS 9

Drag the “untitled” volume that represents the memory card into the Trash.

Connecting to a Television or VCR

Television Playback

Using the audio/video cable included with your camera, you can connect the COOLPIX4500 to a television or VCR.

1 Connect the cable to the camera

Connect the black plug to the A/V OUT connector on the camera.

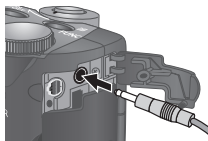

2 Connect the cable to the video device

Connect the yellow plug to the video-in jack on the television or VCR. Connect the white plug to the audio-in jack.

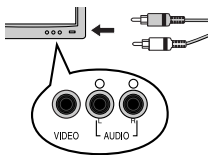

3 Tune the television to the video channel

4 Turn the camera on

The television will perform the functions normally performed by the camera monitor, and the camera monitor will turn off.

5 Press the button twice to enter full-screen playback

Pictures will be played back on the television screen.



Use an AC Adapter

To eliminate drain on the batteries during extended playback, connect the camera to an optional EH-21 AC adapter/battery charger or EH-53 AC adapter.



Choosing a Video Mode 130

The **Video Mode** item offers a choice of NTSC and PAL standards for video output. Be sure that the standard selected matches that of any video device to which you connect the camera.

Beyond Point-and-Shoot

Camera Controls

Read this chapter for advice on the most frequently-used shooting controls, including:

Shooting-Mode Selection (📷 42–56)

Focus Mode (📷 57–61)

Optical and Digital Zoom (📷 62–63)

Flash Mode (📷 64–67)

Making Movies (📷 68)

Exposure Compensation (📷 69)













Sensitivity (📷 70)

Keep or Delete (📷 71)

Shooting-Mode Selection

Shooting and Exposure Modes

The shooting modes available with the COOLPIX4500 range from simple “point-and-shoot” modes (AUTO and scene) to modes such as programmed auto and manual that put you in control of all or most camera settings. The options available in the shooting menu depend on the mode selected.

Mode	Description	Menu
 Auto mode ( 19)	A full auto, “point-and-shoot” mode suited to snapshots or other occasions on which you want to take a quick shot without worrying about camera settings.	Pressing MENU button displays image quality and size menu ( 101).
 Scene mode ( 44)	The COOLPIX4500 offers a choice of sixteen “scene” modes for common subjects and shooting situations.	Scene menu controls scene selection and image quality and size ( 101).
P Programmed auto ( 52)	Camera sets shutter speed and aperture for best exposure. Flexible program ( 52) and exposure compensation ( 69) offer a degree of control over exposure settings.	In these modes, you have access to all settings in the shooting and setup menus ( 88). Changes to menu settings apply to all four modes.
S Shutter-priority auto ( 53)	You control shutter speed; camera sets aperture automatically for best results.	
A Aperture-priority auto ( 54)	You control aperture; camera sets shutter speed automatically for best results.	
M Manual ( 55)	You control both shutter speed and aperture.	

Press the **MODE** button and rotate the command dial to cycle through shooting modes as shown below.

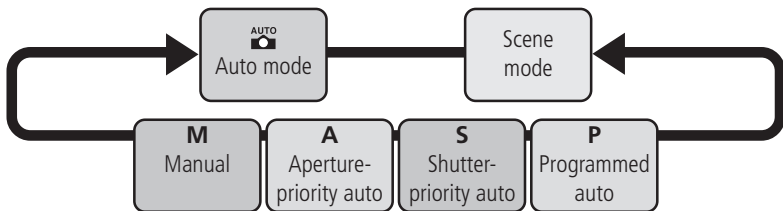
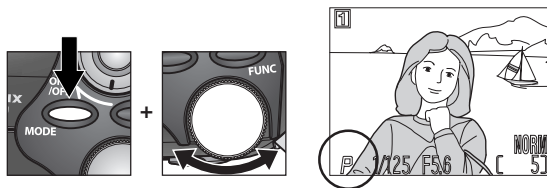

Scene Mode

Depending on the subject, scene mode may not always produce the desired results. If you are unsatisfied with pictures taken in scene mode, choose  (auto) and try again.

Scene Mode

The COOLPIX4500 offers a choice of sixteen “scene” modes for common subjects and shooting situations. To choose a scene:

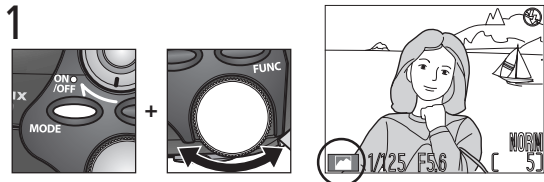
- 

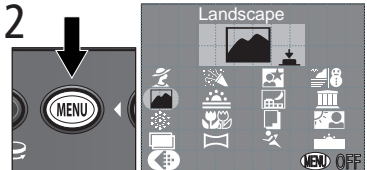

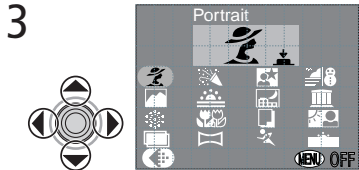
Pressing MODE button, rotate command dial until icon for the last selected scene is displayed.
- 

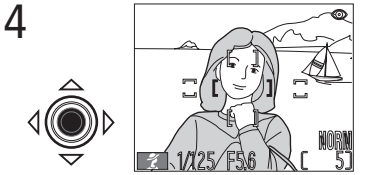
Menu of scene options displayed
- 

Highlight desired scene (highlighted scene shown by caption and large icon at top of monitor)
- 

Make selection and return to shooting mode. Selected scene displayed in monitor.

Image Quality and Size

Image quality and size can be adjusted in scene mode by highlighting  and pressing the center of the multi selector to display the IMAGE SIZE & QUALITY menu ( 88).

































Depending on the scene selected, restrictions may apply to flash (64) and focus mode (57). The table of scene choices on the pages that follow lists the flash and focus mode settings possible in each scene. If in doubt about the meanings of the icons used, consult the following table:























Icon	Flash mode (⚡)	Icon	Focus mode (👁️)
None	Auto	None	Autofocus (Auto)
⚡	Flash Cancel (off)	▲	Infinity
👁️	Auto with red-eye reduction	🌸	Macro close-up
⚡	Anytime Flash (fill flash)	🕒	Self-timer
🌟	Slow sync		



In scenes in which the flash turns off (⚡) automatically, shutter speeds slow and pictures may be blurred by inadvertent camera movement (“camera shake”). At shutter speeds of $1/30$ s or slower, a 🌟 (camera shake) icon appears in the monitor. While use of a tripod is recommended, other methods that may be successful in preventing blurring are indicated by the “Blur” rating:













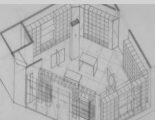

- ★ Support the camera steadily in both hands with your elbows against your torso.
- ★★ Use a tripod or place the camera on a flat, level surface such as a wall or table.

Scene	Description	⚡ (64)	👁️ (57)	Blur
👤 Portrait	Use for portraits. Main subject stands out clearly while background details are softened, lending the composition a sense of depth.  <ul style="list-style-type: none"> • Degree to which background details are softened depends on the amount of light available • Focus area can be selected manually using multi selector (110). 	Any	Auto, 🕒	—

Scene	Description	  (64)	  (57)	Blur
 Party/ Indoor	Use for shots that include details of the background behind the main subject, or to capture the effects of candlelight and other indoor background lighting. 	Any	Auto, 	★
 Night Portrait	Use for shots that provide a natural balance between the main subject and the background when shooting portraits against a backdrop of night scenery. 		Auto, 	★
 Beach/ Snow	Vividly captures the brightness of such subjects as snowfields, beaches, or sunlight expanses of water. 	Any	Any	—
 Landscape	Use for vivid landscape shots that enhance outlines, colors, and contrast in such subjects as skyscapes and forests. 		 	—
 Sunset	Preserves the deep hues seen in sunsets and sunrises. 	     ★	Auto,  	★
 Night Landscape	A slow shutter speed is used to produce stunning night landscapes. Noise reduction turns on automatically. 		 	★★

Scene	Description	  (64)	  (57)	Blur
 Museum	<p>Use indoors where flash photography is prohibited (for example in museums and art galleries) or in other settings in which you do not want to use the flash.</p> <ul style="list-style-type: none"> • The Best Shot Selector (BSS;  98) turns on automatically, reducing the effects of inadvertent camera movement. • Photography may be prohibited altogether in some settings. Be sure to obtain permission first. 		Auto,  	★
 Fireworks Show	<p>Slow shutter speeds are used to capture the expanding burst of light from a firework.</p>			★★
 Close Up	<p>Use to capture vivid colors in close-up shots of flowers, insects, and other small objects, with the background artistically blurred.</p> <ul style="list-style-type: none"> • Minimum focus distance varies with zoom position. When camera is zoomed in to middle zoom position, focus mode indicator () in monitor will turn yellow. At this position, camera can focus on objects as close as 2 cm (0.8") from the lens. • Focus area can be selected manually using multi selector ( 110). 	     *	 	★













* Default is off (). Flash modes shown in brackets are available when Speedlight has been raised by pressing  button. At these settings, Speedlight always fires regardless of brightness of subject.

Scene	Description	 (64)	 (57)	Blur
 Copy	Provides clear pictures of text or drawings on a white board, business card, or printed matter.  • Colored text and drawings may not show up well in the final picture.	 ,  , 	Any [†]	—
 Back Light	Use when your subject is lit from behind and their features are in shadow, or when your subject is in the shade but the background is brightly lit. The flash will fire automatically to “fill in” (illuminate) shadows. 		Auto, 	—
 Multiple Exposure	Two successive exposures are combined to form a single image. Take the first exposure normally.  The shot will appear in the monitor superimposed on the view through the lens. Use this as a guide to compose a multiple exposure, then press the shutter-release button to record the picture.	 ,  , 	Any	—

[†] When autofocus is selected, minimum focus distance is about 70 cm (2'4") from lens. Use macro close-up at shorter ranges. At zoom positions in which monitor focus mode indicator () is displayed in yellow, minimum focus distance is 2 cm (0.8").

Tips on Creating a Multiple Exposure

Exposure compensation () 69) may be needed to create the desired effect. As a rule of thumb, exposure compensation should be set to around -1.0 EV. We recommend, however, that you view the results in the monitor, taking additional shots at different settings if necessary. Exposure compensation may not be required if the background is completely black and your subject is positioned in different areas of the frame in each of the two shots.

Scene	Description	 (64)	 (57)	Blur
 Panorama Assist	 Use to take a series of photographs that you will later join to form a single scene (for example, a panorama or 360° virtual-reality image). For more information, see “Taking Pictures for a Panorama” on the following page.		Any	—
 Sports	High shutter speeds freeze motion for dynamic sports shots. 		Any	—
 Dusk/Dawn	Preserves the colors seen in the weak natural light before sunrise or after sunset. Noise reduction turns on automatically. 		Auto, 	★

Multiple Exposure and Panorama Assist

If the lens is rotated to point in the direction of the monitor at settings of **Multiple Exposure** or **Panorama Assist**, pictures will be inverted during recording and playback.

Noise Reduction

“Noise” in the form of randomly-spaced, brightly-colored pixels tends to appear in pictures taken at slow shutter speeds. This effect is particularly noticeable in dark areas of the picture. At a settings of **Night Landscape** and **Dawn/Dusk**, pictures taken at shutter speeds of $\frac{1}{4}$ s or slower are processed to reduce noise (note that this increases the time needed to process pictures before they are saved to the memory card). **NR** is displayed when noise reduction is in effect.

Taking Pictures for a Panorama

1



Highlight  (Panorama Assist)

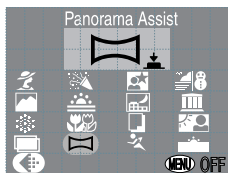

2



Press center of multi selector. Default pan direction is displayed.

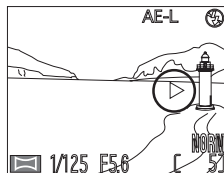

3



Right to left

Top to bottom

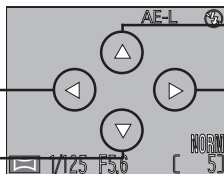

Bottom to top

Left to right

Select how the photographs will be joined together. This is the direction you will pan the camera between each shot.

4



Take first photograph. White balance and exposure settings for this photograph will apply to all photographs in series.

5

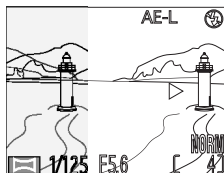

About one third of photograph will appear in monitor superimposed over view through lens. If you are panning from left to right, the picture will be displayed on the left side of the monitor. AE-L icon in monitor turns white to show that exposure has been set with first shot.



Use a Tripod

Using a tripod makes it easier to compose shots so that they overlap.

6

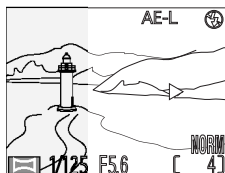

Compose next shot to overlap with previous picture.

7



Take next photograph. Repeat Steps 6 and 7 until all shots in series have been taken.

8



Press center of multi selector to end series. New folder will be created with name consisting of "P_" followed by a three-digit number assigned automatically by camera (e.g., "P_001"), and all photographs in series stored in this folder.

Panorama Assist

The panning direction can not be changed after the first photograph is taken. When taking shots of landscapes with **Panorama Assist**, we recommend that you do not raise the built-in Speedlight.

Viewing Photographs Taken in Panorama Mode

Each time a new series of pictures is begun at a setting of **Panorama Assist**, a folder will be created with a name consisting of "P_" followed by a three-digit number assigned automatically by the camera (e.g., "P_001"), and all pictures in the series stored in this folder. To view photographs taken at a setting of **Panorama Assist**, select the appropriate folder from the playback **Folders** menu, or select **All Folders**  136).

P: Programmed Auto

In programmed auto, the camera automatically adjusts shutter speed (in the range $1\text{--}1/_{2,300}$ s) and aperture according to the amount of light available, producing optimal exposures in most situations. Adjustments to exposure can be made using exposure compensation (📷 69) or exposure bracketing (📷 116).



Flexible Program

In programmed auto, different combinations of shutter speed and aperture can be selected by rotating the command dial (flexible program). Each combination of shutter speed and aperture will produce the same exposure. When flexible program is in effect, an asterisk (“*”) will appear next to the exposure-mode indicator in the monitor.

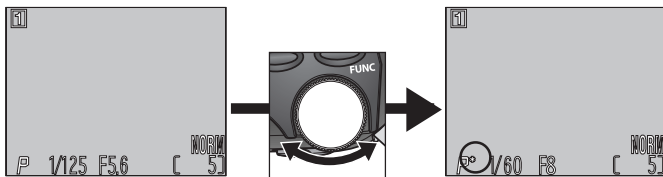

The default values for shutter speed and aperture can be restored by rotating the command dial until the asterisk is no longer displayed next to the exposure-mode indicator. Default values are also restored when another shooting mode is selected, playback is activated, or the camera is turned off.

S: Shutter-Priority Auto

In shutter-priority auto, you control shutter-speed by rotating the command dial, while the camera automatically adjusts aperture to produce optimal exposure. Shutter speed can be set to values between 8 s to $\frac{1}{2000}$ s in increments equivalent to 1 EV (one step).

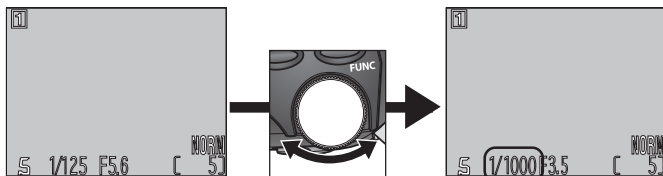

Shutter-Speed Limitations

At **Continuous** settings of **Ultra HS** and **Movie** ( 96), the camera takes a fixed number of frames per second. Shutter speed can not be set to values slower than the frame advance rate ($\frac{1}{30}$ s and $\frac{1}{15}$ s, respectively).

Exposure Warning

If the photograph would be under- or over-exposed at the shutter-speed selected in shutter-priority auto or the aperture selected in aperture-priority auto, the shutter speed or aperture display in the monitor will flash when the shutter-release button is pressed halfway. Choose another setting and try again.

Noise

At shutter speeds of $\frac{1}{4}$ s or slower, the shutter-speed indicator in the monitor will turn yellow to show that mottling (“noise”) may appear in the final photograph. We recommend that you either choose a faster shutter speed or turn noise reduction on ( 118).

A: Aperture-Priority Auto

In aperture-priority auto, you control aperture by rotating the command dial, while the camera automatically adjusts shutter-speed in the range $8\text{ s} - \frac{1}{2300}\text{ s}$ to produce optimal exposure. Aperture varies in increments equivalent to $\frac{1}{3}\text{ EV}$ ($\frac{1}{3}$ step).

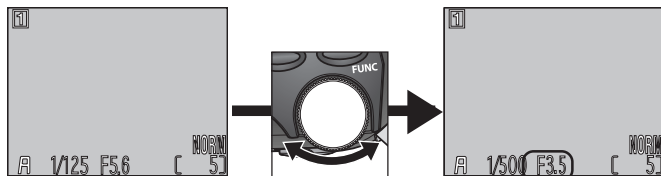

Faster Shutter Speeds

For shutter speeds faster than $\frac{1}{2000}\text{ s}$, choose an exposure mode of aperture-priority auto, select a smaller aperture (larger f-number), and zoom the camera all the way out. If lighting is sufficient, shutter speeds of up to $\frac{1}{2300}\text{ s}$ can be achieved.



Aperture and Zoom

The maximum and minimum values for aperture are the maximum and minimum values for the camera lens, adjusted for the current zoom setting. Higher f-numbers (smaller apertures) can be achieved by zooming the camera in, lower f-numbers (larger apertures) by zooming the camera out. Unless **On** is chosen for **Fixed Aperture** in the **Zoom Options** sub-menu (📷 113), aperture will change as the camera is zoomed in or out. If, for example, you choose the second-highest aperture setting with the camera zoomed all the way out, the camera will vary the f-number to maintain aperture at the second-highest setting for the current zoom position as you zoom the camera in.

M: Manual

In manual exposure mode, you control both shutter speed and aperture. Shutter speed can be set to values between 8 s and $\frac{1}{2000}$ s in increments equivalent to 1 EV (one step), or the shutter can be held open indefinitely for a long time-exposure of up to five minutes (BULB). Aperture can be adjusted in increments equivalent to $\frac{1}{3}$ EV ($\frac{1}{3}$ step).

- 1 After choosing manual as the exposure mode, remove your finger from the **MODE** button.
- 2 Press the **MODE** button to select shutter speed or aperture in the monitor, where the selected item is shown in green. The item selected will change each time the **MODE** button is pressed.
- 3 Rotate the command dial to set the selected item (aperture or shutter speed) to the desired value. The amount the photograph would be under- or over-exposed at the selected setting is shown in the exposure display.

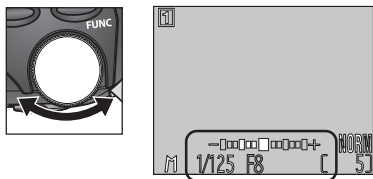
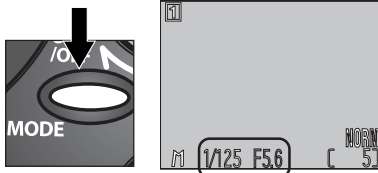

Exposure display shows values from -2 to $+2$ EV in increments of $\frac{1}{3}$ EV.

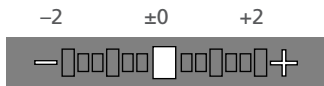

The Shutter-Speed Display

If the shutter-speed display turns red at a setting of $\frac{1}{2000}$ s, adjust aperture while checking exposure in the exposure display.

4 Press the **MODE** button to select the other item (shutter speed or aperture).

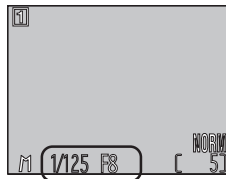
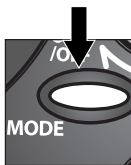

5 Rotate the command dial to choose a value that will produce the desired exposure. If necessary, repeat steps 4 and 5 until the desired combination of shutter speed and aperture has been achieved.

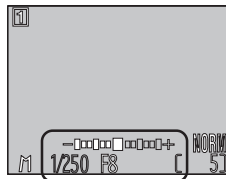
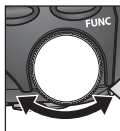

Long Time-Exposures (BULB)





When manual exposure mode is selected and CONTINUOUS set to **Single** (📷 96), shutter speed can be set to BULB for long time-exposures of up to five minutes. With shutter speed selected in the monitor, rotate the command dial until the shutter-speed display shows BULB. At this setting, the shutter will remain open while the shutter-release button is pressed. To prevent blurring caused by camera shake, we recommend that you use a tripod and a remote shutter release such as the MC-EU1 remote cord. We also recommend that you turn **Noise Reduction** on (📷 118) to reduce mottling (“noise”).





Focus Mode

Focusing Near and Far

Choose a focus mode according to your subject and composition.

Option	Description
NO ICON Autofocus	Camera automatically adjusts focus according to distance to subject. Use with subjects 30 cm/1' (50 cm/1'8" at widest angle) or more from lens.
 Infinity	Focus fixed at infinity, allowing camera to focus on distant scenes through foreground objects such as a window. Flash disabled.
 Macro close-up	In middle zoom range,  icon in monitor turns yellow and camera can focus on objects as close as 2 cm (0.8", measured from lens). Use for close-ups.
 Self-timer  58)	Combines macro close-up (see above) at distances of 2 cm (0.8") or more with shutter release delay of 10 s or 3 s. Use for self-portraits or to reduce blurring caused by camera shake.

To choose a focus mode, press the  button repeatedly until the desired setting is displayed in the monitor. The options available in scene mode depend on the scene selected ( 44).

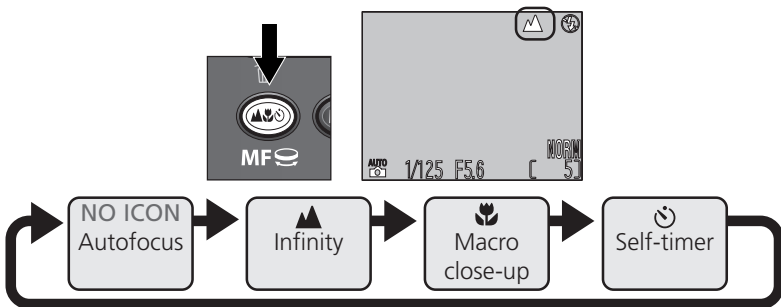

Macro Close-Up

We recommend that you frame pictures in the monitor when using macro close-up.

The flash may be unable to light the entire subject at distances under 50 cm (1'8"). Take a test picture and verify the results in the monitor.



Delaying Shutter Release: Self-Timer Mode

The self-timer can be used for photographs in which you wish to appear yourself or to prevent photographs from being blurred by camera movement that occurs when the shutter-release button is pressed. To use the self-timer:

1 Position the camera

Mount the camera on a tripod (recommended) or rest it on a flat, stable surface.

2 Select a self-timer mode

Press the  button until the self-timer icon () is displayed. The macro close-up icon () will also be displayed to indicate that the camera can focus at distances of 2 cm (0.8") or more.

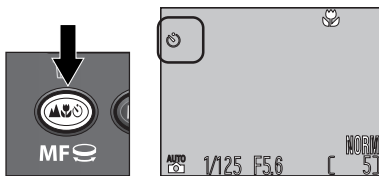

3 Compose the photograph

Adjust camera settings and frame the picture.



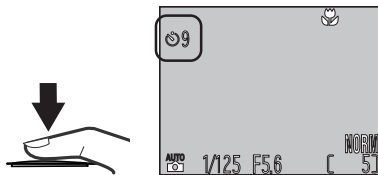

4 Start the timer

Press the shutter-release button all the way down to activate the timer. Press once for a ten-second delay, twice for a three-second delay. To stop the timer, press the shutter-release button a third time.



The self-timer lamp next to the lens will start to blink when the shutter-release button is pressed, and continue to blink until one second before the photo is taken. The self-timer lamp will stay lit during the final second to warn that the shutter is about to be released.

Autofocus

In autofocus and macro close-up modes, the camera adjusts focus automatically. In  mode or at a scene setting of **Close Up**, the camera adjusts focus continuously while the monitor is on (*continuous autofocus*;  111). When the monitor is off, the camera does not focus until the shutter-release button is pressed halfway (*single autofocus*;  111). In either case, focus locks when the shutter-release button is pressed halfway, and remains locked as long as the button is held in this position (*focus lock*;  60). In **P**, **S**, **A**, and **M** modes, single autofocus is used whether the monitor is on or off, although the **Focus Options: Auto-Focus Mode** item in the SHOOTING menu can be used to enable continuous autofocus when the monitor is on ( 111).



Getting Good Results with Autofocus

Autofocus performs best when:

- There is contrast between the subject and the background. For example, autofocus may not perform well on subjects that are the same color as the background.
- The subject is evenly lit.

Autofocus does not perform well when:

- You attempt to focus simultaneously on two or more objects at different distances from the camera. For example, autofocus may not perform well when photographing an object inside a cage, because the bars of the cage will be closer to the camera than the main subject, and both the bars and the main subject will be in the focus area.
- The subject is very dark (the subject should not, however, be too much brighter than the background).
- The subject is moving rapidly.

If the camera is unable to focus using autofocus, the autofocus lamp next to the viewfinder will flicker when the shutter-release button is pressed halfway. Use focus lock ( 60) to focus on another subject at the same distance, or use manual focus ( 61).

Choose the Center Focus Area

We recommend that you select the center focus area when using focus lock.

Focus and Exposure Lock

Once the camera has focused, focus and exposure will remain locked while the shutter-release button is pressed halfway. This can be used to change the composition after focusing on your subject, or to focus on another object at the same distance and recompose your picture with your subject in the frame.

1

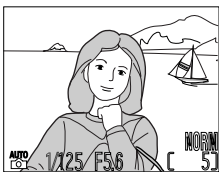

Press shutter-release button halfway. Autofocus lamp (green) next to viewfinder lights when camera has focused.

2

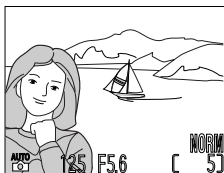

Keeping shutter-release button pressed halfway, recompose picture. Do not change distance to subject while focus lock is in effect.

3



Smoothly press shutter-release button all the way down to take picture



Autoexposure Lock

Pressing the shutter-release button halfway locks exposure as well as focus. To use spot or center-weighted metering to meter a subject that is not in the center of the frame, compose your photograph with the subject in the metered area, then press the shutter-release button halfway to lock focus and exposure. Recompose your photograph and press the shutter-release button the rest of the way down to shoot. If the **Controls: AE-L, AF-L** option in the setup menu is set to **AE-L** (📷 124), exposure can be locked without locking focus by pressing the center of the multi selector while the shutter-release button is pressed halfway. Exposure will remain locked as long as the multi selector is held in this position, even if you remove your finger from the shutter-release button. **AE-L** indicator in monitor turns white when exposure lock is in effect.

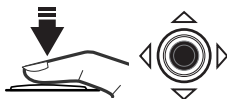

Manual Focus

In **P**, **S**, **A**, and **M** modes, manual focus can be used in place of autofocus for situations in which you are unable to achieve the desired results using autofocus.

- 1 Press the **MF** button and rotate the command dial until the manual focus display appears in the monitor.
- 2 Using this display as your guide, continue to rotate the command dial until your subject is in focus.

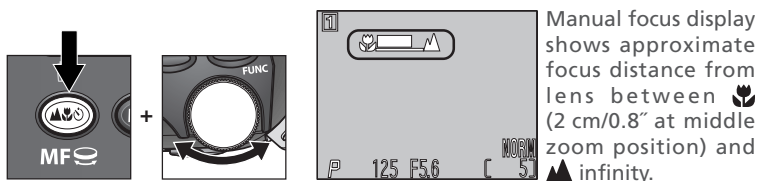

Unless **Off** is selected for **Focus Options: Focus Confirmation** (111), focus confirmation will turn on automatically when manual focus is in effect, and objects that are in focus will be outlined sharply in the monitor.

Manual focus can be cancelled by pressing the **MF** button to select a new focus mode.

Notes on Manual Focus

- When using the self-timer, be sure that the self-timer is selected (58) *before* selecting a focus distance. Changing the focus mode after setting the focus distance will cancel manual focus.
- Use autofocus (59) when an optional converter lens is attached (106). In manual focus mode, the actual focus distance will differ from that shown in the monitor.
- When manual focus is set to the end of the manual focus indicator, the camera may be unable to focus at some zoom positions. If the camera is unable to focus at the current zoom position, the manual focus display in the monitor will turn red. Zoom the camera in or out until the manual focus display no longer appears in red.
- If you adjust zoom after focusing, you will need to focus again at the new zoom position.

Your Nikon digital camera offers two kinds of zoom: optical zoom, in which the camera's telescoping lens can be used to magnify the subject up to 4 \times , and digital zoom, in which digital processing is used to further magnify the image up to 4 \times for a total magnification of up to 16 \times .

Optical Zoom

Photos can be framed in the viewfinder or monitor using the zoom button.

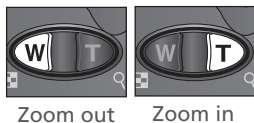

Indicator in monitor displays amount of zoom while either button is pressed

Optical zoom can not be adjusted while recording movies. Digital zoom can be used.

Optical vs. Digital Zoom

In digital zoom, data from the camera's image sensor are processed digitally, enlarging the center portion of the image to fill the frame. Unlike optical zoom, digital zoom does not increase the amount of detail visible in the photograph. Instead, details visible at maximum zoom are enlarged, producing a slightly "grainy" image. Digital zoom also differs from optical zoom in that its effects are visible only in the monitor, not the viewfinder, meaning that the monitor must be on before digital zoom can be used.

Digital Zoom



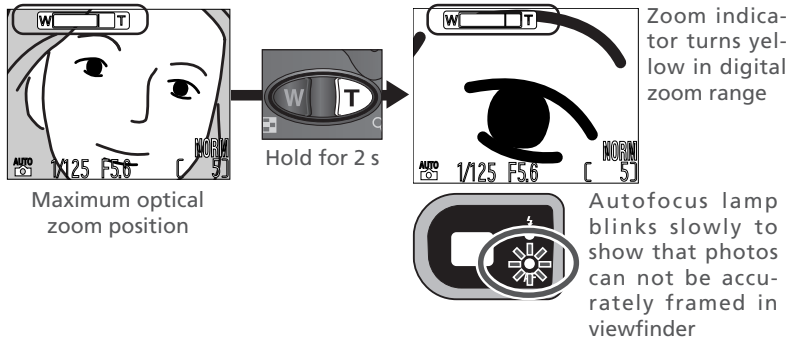

At the maximum optical zoom position, holding the **T** end of the zoom button down for two seconds triggers digital zoom.







The camera can be zoomed in and out in the digital zoom range by pressing the **T** and **W** buttons. To cancel digital zoom, press **W** until the zoom indicator turns white or turn the camera off.

Restrictions on Digital Zoom





Digital zoom can only be used when the monitor is on. Digital zoom is not available when:

- The monitor is off
- Image quality is set to **HI** ( 102)
- **Black&White** or **Sepia** is selected in the **Saturation Control** sub-menu ( 100)
- **Multi-Shot 16** or **Ultra HS** is selected in the **Continuous** sub-menu ( 96)
- **Off** is selected for **Zoom Options: Digital Tele** in the shooting menu ( 112)

The flash mode can be chosen from the following five options.

Option	Description
 NO ICON Auto	When lighting is poor, built-in Speedlight will pop up automatically when shutter-release button is pressed halfway, and flash will fire when picture is taken.
 Flash Cancel (off)	Flash will not fire even when lighting is poor.
 Auto with red-eye reduction	Same as Auto, except that flash fires several times at low intensity before main flash, minimizing “red-eye.” Use for portraits (works best when subjects are well within range of flash and looking at flash). Because a slight delay occurs after the shutter-release button is fully pressed to allow red-eye reduction to take effect, this setting is not recommended with subjects that are moving erratically or in other situations in which you want the camera to react quickly.
 Anytime Flash (fill flash)	Flash fires whenever photo is taken. Use to “fill-in” (illuminate) shadows and back-lit subjects.
 Slow Sync	Auto flash combined with slow shutter speed. Use to capture both subject and background at night or under dim light.

Auto Flash Off

The flash turns off automatically when focus is set to infinity ( 57), an option other than **Single** is chosen for **Continuous** ( 96), **BSS** ( 98) is **On**, a setting other than **Normal** is selected in the **Lens** menu ( 106), or **Internal Off** is selected for **Speedlight Cntrl** ( 115).

The Flash-Ready Lamp

A short pause is required between exposures for the flash system to charge. If the shutter-release button is pressed halfway while the flash is charging, the flash-ready lamp next to the viewfinder will flicker. Remove your finger briefly from the shutter-release button and try again.

The flash mode is controlled with the  button.

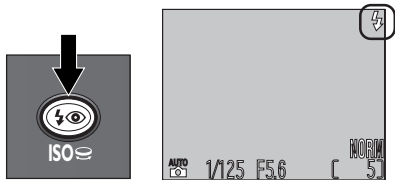

Press  repeatedly until desired mode is displayed in monitor



The flash mode changes as shown below. The options available in scene mode depend on the scene selected ( 44).



To protect the built-in Speedlight, we recommend that it be lowered when not in use.

Using the Built-in Speedlight

Do not attempt to raise the Speedlight by hand. Failure to observe this precaution could damage the Speedlight. When lowering the Speedlight, push it gently back to the closed position, pressing straight down on the top of the Speedlight. Do not apply force to the front, back, or sides, as this could damage the Speedlight. Be careful not to catch your hair, fingers, or other objects in the Speedlight.

The Speedlight can be raised by pressing the  button when the **Speedlight Opt.: Pop Up** option in the SHOOTING menu is set to **Manual** ( 114). When **Auto** is selected, the Speedlight will pop up automatically when required. The following flash modes are available when **Speedlight Opt.: Pop Up** is set to **Manual**:

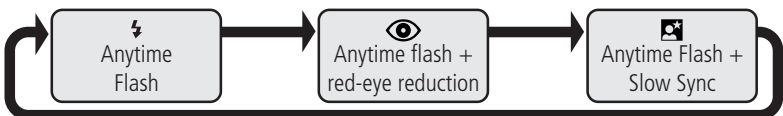

The Sync Terminal

Optional Speedlights mounted on an SK-E900 flash bracket can be attached via the camera's sync terminal. The following SB-series Speedlights (available separately) can be used: 80DX, 30, 28DX, 28, 26, 25, 24, 22, and 22s.

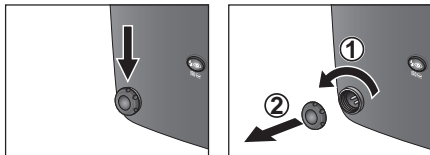

Remove sync terminal cover and attach flash bracket sync cord. Illustration at right shows COOLPIX4500 with SK-E900 flash bracket and optional Speedlight.

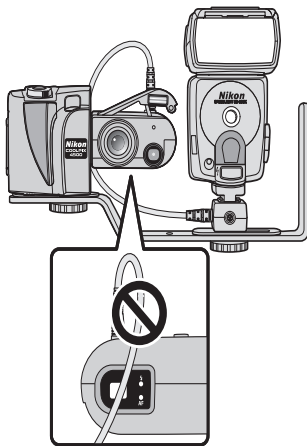

Using an Optional Speedlight

A ferrite core is provided with the COOLPIX4500. Before using an optional Speedlight, be sure to attach this core to the sync cord adjacent to the camera lead (see figure A, above at right). To prevent the sync cord from blocking the viewfinder, connect it as shown above (B).

Notes on the Built-in Speedlight

In **AUTO** and scene modes, or when **Auto** is selected for the **Popup** option in the shooting menu for **P**, **S**, **A**, or **M** mode (114), the built-in Speedlight will pop up automatically. Do not prevent the built-in Speedlight from popping up by placing your fingers or other objects on top of the Speedlight.

When the built-in Speedlight is raised, keep your fingers and other objects away from the flash window and photocell. If a shot seems dark even though the flash fired, this may indicate that you accidentally blocked the flash window; check that the flash is unobstructed and try again.

Set the flash mode for the optional Speedlight to TTL. At this setting, the optional Speedlight will be controlled by the camera in response to camera flash mode and **Speedlight Opt.** settings. Refer to flash-bracket and Speedlight manuals for detailed instructions. Even if **Internal Off** is selected in the **Speedlight Cntrl** menu, the built-in Speedlight will pop up automatically when an optional Speedlight is used to allow control of flash output by the camera photocell. When the built-in Speedlight is raised, do not block the photocell with your fingers or other objects.

Before using an optional Speedlight, set the zoom head to an angle wider than 28 mm. At smaller angles, the flash may not be able to light the entire subject. We recommend that you take a test shot and view the results in the monitor; if the results are not satisfactory, try zooming the camera in or adjusting the illuminating angle.

The COOLPIX4500 does not support power zoom or AF-assist illumination.



Use Only Nikon Flash Accessories

Use only Nikon Speedlights. Negative voltages or voltages over 250 V applied to the camera's sync terminal could not only prevent normal operation, but damage the sync circuitry of the camera or flash. Before using a Nikon Speedlight not included in the list on the previous page, contact a Nikon-authorized service representative for more information.

Close-Ups

The built-in Speedlight may be unable to light the entire subject at distances under 50 cm (1'8"). Take a test picture and verify the results in the monitor.

When Lighting Is Poor

When lighting is poor and the flash is off () or set to slow sync (), shutter speed slows and photos may be affected by "noise" in the form of randomly-spaced, brightly-colored pixels. At shutter speeds below $1/4$ s, noise can be reduced using the **Noise Reduction** option ( 118) in the shooting menu (**P**, **S**, **A**, and **M** modes only).

At shutter speeds slower than $1/30$ s, a  (camera shake) icon will appear in the monitor. Use of a tripod is recommended to prevent blurring caused by inadvertent camera movement.

Making Movies (P, S, A, and M)

Movie Mode

In **P**, **S**, **A**, and **M** modes, the COOLPIX4500 can record movies up to thirty-five seconds in length at a rate of about fifteen frames per second, with sound recorded via the camera's built-in microphone. Each frame is 320 × 240 pixels in size (QVGA). To record a movie:

- 1 Choose an exposure mode of **P**, **S**, **A**, or **M**.
- 2 In the shooting menu, select **Continuous: Movie** (📹 96). When you return to shooting mode, the exposure count display will show the length of the movie that can be recorded.

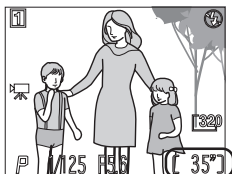
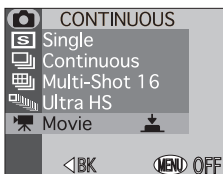

- 3 Press the shutter-release button all the way down to begin recording. If **Auto-Focus Mode** (📷 111) is set to **Single AF** (the default setting), focus will lock when the shutter-release button is pressed. During recording, optical zoom is disabled; only digital zoom can be used. If lens section is rotated to point in the same direction as the monitor, the image in the monitor will be inverted and the movie will be recorded upside down.

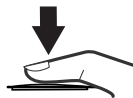

- 4 Press the shutter-release button all the way down a second time to end recording (recording will end automatically thirty-five seconds after recording starts or if no more memory is available on the memory card). The movie will be stored as a QuickTime movie file with a file name ending in ".MOV".



Movies can not be recorded unless the monitor is on. The flash turns off automatically in movie mode.

For more information on:

77 Playing movies back

Exposure Compensation



Bright, Dark, and High-Contrast Subjects

To obtain the desired results with certain subject compositions (for example, when large areas of the frame are very bright, very dark, or contain areas of strong contrast), it may be necessary to alter exposure from the value suggested by the camera. This can be done using exposure compensation.

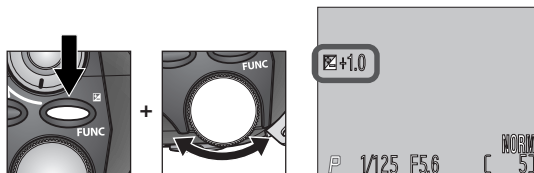
Exposure compensation can be set to values between -2.0 EV (underexposure) and $+2.0$ EV (overexposure) in increments of $1/3$ EV. Rotate the command dial while pressing the  button.



The FUNC Button

The function assigned to the  button can be changed using the **Controls: FUNC** option in the setup menu. Note that if a function other than exposure compensation is assigned, exposure compensation can only be set using the **Exposure Options: Exp. +/-** option in the shooting menu ( 109).

Choosing an Exposure Compensation Value

The camera may set exposure too low if large areas of the frame are very bright (containing, for example, sunlit expanses of water, sand, or snow) or the background is much brighter than the main subject. If the image in the monitor is too dark, choose a positive value for exposure compensation. Similarly, the camera may set exposure too high if large areas of the frame are very dark (containing, for example, an expanse of dark green leaves) or the background is much darker than the main subject. If the image in the monitor is too bright, raise exposure compensation until the desired effect is achieved.

Cancelling Exposure Compensation

To cancel exposure compensation, select a value of ± 0 . In  and scene modes, exposure compensation can also be cancelled by turning the camera off or selecting another shooting mode.

Sensitivity (P, S, A, and M)

Reacting Faster to Light

In **P**, **S**, **A**, and **M** modes, sensitivity (ISO equivalency) can be raised above the default level (roughly equivalent to ISO 100) according to your subject and lighting conditions.

Sensitivity can be set to ISO 100, 200, 400, or 800 equivalent or AUTO. If AUTO is selected, the camera will automatically raise sensitivity above the default value when lighting is poor. To select a setting for sensitivity, first select **P**, **S**, **A**, or **M** mode. Press the  button and rotate the command dial to cycle through settings as shown below. The current setting is displayed in the monitor.

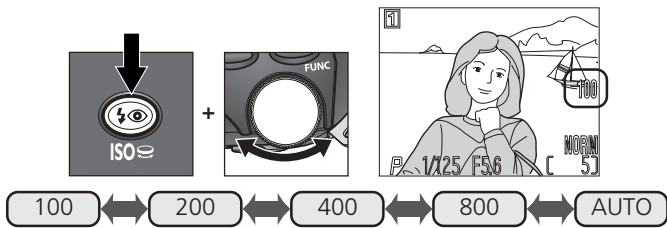



When sensitivity is set to AUTO, an **ISO** icon will appear in the monitor when sensitivity is above ISO 100 equivalent. In manual and shutter-priority auto exposure modes, AUTO is equivalent to a setting of 100, and sensitivity will not be raised when lighting is poor.

ISO 200 and Above

The higher the sensitivity, the more likely your pictures are to be affected by “noise” in the form of randomly-spaced, brightly-colored pixels. We recommend that you choose a setting of 100 except when high shutter speeds are required. When 800 is selected, the ISO indicator in the monitor will turn red to indicate that pictures taken at this setting will likely contain appreciable amounts of noise. We recommend that **Image Sharpening** ( 105) be turned off at this setting to avoid heightening the effects of noise. A setting of 800 is recommended only to capture natural lighting under low light conditions or when a fast shutter speed is required to avoid blur.

When image quality is set to **HI**, or when **Ultra HS** or **Movie** is selected in the **Continuous** menu, the picture you have just taken will be displayed briefly in the monitor after each shot, giving you the opportunity to delete the picture before it has been recorded to the memory card.

To delete the picture, press the  () button. A confirmation dialog will be displayed. Press the multi selector up or down to highlight the desired option, then press the multi selector to make the selection.

- Select **No** to return to shooting mode and save the picture to the memory card.
- Select **Yes** to delete the picture and return to shooting mode.

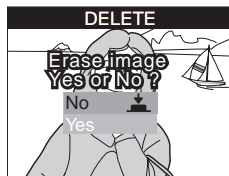
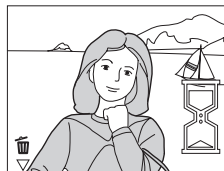

Disable Delete

Pictures can not be deleted when **On** is selected for the **Disable Delete** option in the setup menu ( 131).

More About Playback

Playback Options

During playback, you can use the multi selector and the buttons on the back of the camera to perform the operations described in the following sections:

Taking a Closer Look: Playback Zoom (👁️ 74)



Creating a Small Copy of a Picture: Small Picture (👁️ 75–76)

Movie Playback (👁️ 77)





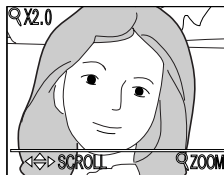

Adding Audio Commentary: Voice Memo (👁️ 78)

Photo Information (👁️ 80)

Taking a Closer Look: Playback Zoom

Use the  () button to zoom in on photos displayed in full-screen playback.



To	Press	Description
Zoom photo in	 ()	Zoom increases each time button is pressed, to a maximum of 6.0 ×. While image is zoomed in,  icon and zoom ratio are displayed in upper left corner of monitor.
View other areas of image		Press the multi selector to scroll to areas of the image not visible in the monitor.
Cancel zoom		Press  to cancel zoom.

Notes on Playback Zoom

To view other pictures on the memory card, cancel zoom and use the multi selector.

Additional time may be required to display pictures taken at an image quality setting of **HI**.

Playback zoom can not be used to view movies, copies created with the small picture function, or pictures taken at a setting of **Ultra HS**.

Creating a Small Copy of a Picture: Small Picture

Pressing the **MODE (SMALL PIC.)** button in full-screen playback creates a small copy of the current picture. Before creating a copy, choose a size using the **Small Pic.** option in the playback menu. Copies can be 640 × 480, 320 × 240, 160 × 120, 96 × 72 pixels in size and automatically have an image quality of **BASIC**, making them ideal for distribution by e-mail or for use in web pages.

To create a small copy of the picture currently displayed in full-screen playback:

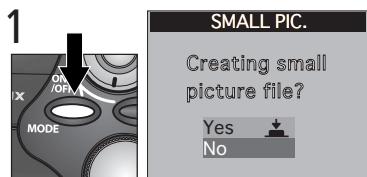

Press **MODE (SMALL PIC.)** button to display confirmation dialog

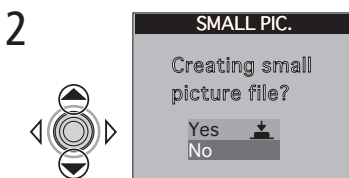

Highlight **Yes** (to exit without creating copy, highlight **No** and press center of multi selector)

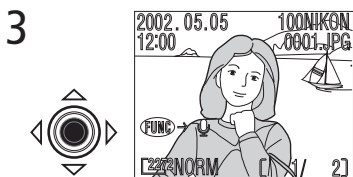

Press center of multi selector to create small copy and return to playback mode with original picture displayed

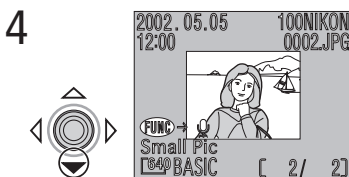

To view copy, press multi selector down. Copy will have same time and date of creation as original.

Once created, copies are independent of the original: deleting a copy has no effect on the original, deleting the original no effect on the copy. Copies are stored on the memory card as independent files with names of the form "SSCNnnnn.JPG," where "nnnn" is a four-digit number assigned automatically by the camera. Print and protect attributes for copies must be set separately from the originals.

When displayed in full-screen playback, copies will occupy roughly one-quarter of the monitor and are surrounded by a gray frame. In thumbnail playback, copies are indicated by a gray border. Copies can not be viewed using playback zoom (Z 74); pressing the Q (D) button when a copy is displayed has no effect.

Restrictions on Small Picture

The small picture function described in this section can not be used in quick review.

Copies can not be created from movies or from pictures taken at a setting of **Ultra HS** or an image quality setting of **HI**. Additional copies of an image can not be created from a small picture file; pressing the **MODE (SMALL PIC.)** button when a copy is displayed will have no effect. Pressing the **MODE** button will also have no effect if there is not enough space for the copy on the memory card.

The COOLPIX4500 may not be able to create small copies from images taken with another make of camera.







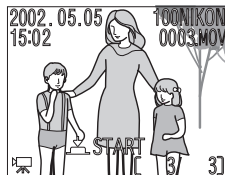

Viewing Small Picture Files on Other Cameras

Copies created with the small picture function may not display correctly when viewed on other models of Nikon digital camera. You may also not be able to transfer copies from other models of Nikon digital camera to a computer.

Movie Playback

Movies are indicated by a  icon. In full-frame playback, movies can be viewed using the multi-selector. Movies can not be played back when thumbnails are displayed.



To	Press	Description
Start playback		Press center of multi selector to start playback. When movie ends, final frame is displayed for one second, followed by a still image of the first frame.
Pause/resume playback		Pressing center of multi selector while playback is in progress pauses display. To resume playback, press center again.
Rewind movie one frame		When movie is paused, pressing the multi selector up or left rewinds the movie one frame.
Advance movie one frame		When movie is paused, pressing the multi selector down or right advances the movie one frame. If the last frame of the movie is displayed, pressing the multi selector down or right ends movie playback and displays the first frame of the movie.
Raise volume		Volume indicator ( ,  , or ) is displayed in monitor when zoom buttons are pressed.
Lower volume		

Inverted Playback

Movies recorded with the lens pointing in the same direction as the monitor will be played back upside down.

Adding Audio Commentary: Voice Memo

This function can be used to record a brief voice memo for the picture currently displayed in full-screen playback. The memo is saved to the memory card as a sound file. Once a voice memo has been added to a picture, a  icon will appear on the picture during playback.















To	Press	Description
Record memo	REC (FUNC)	If voice memo can be recorded, (FUNC) → U will be displayed in monitor. Memo of up to 20 s can be recorded while FUNC button is held down. During recording, REC blinks and length of memo that can be recorded is displayed in monitor. Recording ends after 20 s or when FUNC button is released.
Play memo	PLAY (FUNC)	If a voice memo has been recorded for current picture,  will be displayed during playback. Press FUNC button to play recording back. Playback ends when entire recording has been played back or FUNC button is pressed a second time.
Pause/resume playback		To pause playback, press center of multi selector while playback is in progress. Press again to resume.
Delete memo	 (MOS)	Pressing  while memo is being played back displays confirmation dialog. Press multi selector up or down to highlight option, press center to select. <div data-bbox="367 1036 611 1218" style="border: 1px solid black; padding: 5px; margin: 10px 0;"> <p style="text-align: center;">DELETE</p> <p> Erase recording Yes or No ?</p> <p style="text-align: center;">No  Yes </p> <p style="text-align: center;">◀ BK MENU OFF</p> </div> <ul style="list-style-type: none"> • Select No to exit without deleting voice memo • Select Yes to delete voice memo
Raise volume		Volume indicator ( ,  , or ) is displayed in monitor when zoom buttons are pressed.
Lower volume		

Photo Information

Rotate the command dial to view photo information. The following information is available:

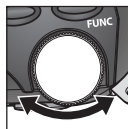

File Information

1	2002.05.05	100NIKON	8
2	12:00	0025.JPG	9
			10
3			11
4			12
5	Small Pic		13
6			14
7	NORM [1/ 1]		15

- 1 Date recorded
- 2 Time recorded
- 3 Voice memo playback guide
- 4 Voice memo recording guide
- 5 Small picture

- 6 Image size
- 7 Image quality
- 8 Folder
- 9 File number and type
- 10 Battery level indicator
- 11 Voice memo icon
- 12 Transfer icon
- 13 Print-order icon
- 14 Protect icon
- 15 Current frame number/total number of frames visible in current folder

Shooting Information, Page 1

1	CAMERA	: E4500
2	FIRM VER	: E4500V1.0
3	METERING	: MATRIX
4	MODE	: P
5	SHUTTER	: 1/125
6	APERTURE	: F4.2

- 1 Camera type
- 2 Firmware version (only for pictures taken with COOLPIX4500)
- 3 Metering method
- 4 Exposure mode
- 5 Shutter speed
- 6 Aperture

Image File and Folder Names

Pictures are stored in files with names that begin with a four letter identifier ("SSCN" for pictures created with the small picture option, "TSCN" for pictures created with **Perspective Control**, and "DSCN" for all other pictures) followed by a four-digit file number assigned by the camera. Each file name ends in a three-letter extension: ".TIF" for photos taken at an image quality of **HI**, ".JPG" for other photographs, ".MOV" for movies, and ".WAV" for voice memos. Picture files are stored in folders created automatically by the camera and named with a three digit folder number.

Shooting Information, Page 2

1 EXP +/- : 0.0
 2 FOCAL LENGTH: f7.85mm
 3 FOCUS : AF
 4 SPEED LIGHT : OFF
 5 IMG ADJUST : AUTO
 6 SENSITIVITY : AUTO

- 1 Exposure compensation
- 2 Focal length
- 3 Focus mode
- 4 Flash status
- 5 Image adjustment
- 6 Sensitivity (ISO equivalency)

Shooting Information, Page 3

1 WHITEBAL : AUTO
 2 SATURATION : 0
 3 SHARPNESS : AUTO
 4 DIGITAL TELE : X1.00
 5 CONVERTER : OFF
 6 FILE SIZE : 912KB

- 1 White balance
- 2 Color saturation
- 3 Sharpening
- 4 Digital zoom
- 5 Lens-converter status
- 6 File size

Exposure Information

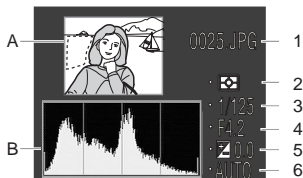

- A Flashing border in thumbnail preview marks brightest areas of image (highlights)
- B Histogram showing distribution of tones in image: horizontal axis gives pixel brightness, with dark tones to left and bright tones to right, vertical axis gives number of pixels of each brightness in image

- 1 File no. and type
- 2 Metering method
- 3 Shutter speed
- 4 Aperture
- 5 Exposure compensation
- 6 Sensitivity

Focus Confirmation



- 1 File no. and type
- 2 Focal length
- 3 Shutter speed
- 4 Aperture
- 5 Focus mode
- 6 Noise reduction
- 7 Focus confirmation (areas of image that are in focus are sharply outlined, and active focus area is shown in red)

Menu Guide

Camera Menu Options

Changes to a variety of camera settings are made with the help of menus that appear in the camera monitor. This chapter is divided into the following five sections:

Index to Menu Options

An overview of the options available in the camera menus.

Using Camera Menus

This section describes basic menu operations.

The Shooting Menu

This menu contains a number of options for fine-tuning shooting settings.

The Set-up Menu

This menu is used for basic camera setup.

The Playback Menu

The playback menu contains options for managing images stored on memory cards.

Index to Menu Options



82–87



Using Camera Menus



88–90



The Shooting Menu



91–120



The Set-up Menu



121–132



The Playback Menu



133–148



Index to Menu Options



IMAGE SIZE & QUALITY (AUTO and Scene Modes)

Pressing the MENU button in **AUTO** mode displays a menu where you can adjust image quality and size. In scene mode, the image size and quality menu can be accessed by selecting from the scene menu.



IMAGE QUALITY

Set image quality.

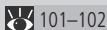

FINE

NORMAL

BASIC

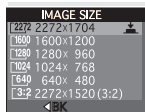
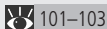

IMAGE SIZE

Specify the dimensions of the image in pixels.



2272×1704

640× 480

1600×1200

2272×1520 (3:2)

1280× 960

(**AUTO** mode only)

1024× 768



SHOOTING MENU (P, S, A, and M Modes)

In **P**, **S**, **A**, and **M** modes, the shooting menu contains the options listed below. A icon next to a menu item indicates that the selection can be made directly from the main menu using the command dial.



WHITE BALANCE

Match white balance to your light source.

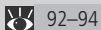

A-WB Auto

White Bal Preset

Fluorescent

Daylight

Cloudy

Incandescent

Speedlight



METERING

Control how the camera sets exposure.



Matrix

Spot

Center-Weighted

Spot AF Area

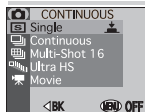

CONTINUOUS

Take photos one at a time or in sequence or make movies.



Single

Continuous

Movie

Multi-Shot 16

Ultra HS

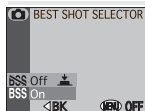

BEST SHOT SELECTOR

Use when pictures could be blurred by inadvertent camera movement.



Off

On



IMAGE ADJUSTMENT

Raise or lower brightness or contrast.



Auto

Normal

More Contrast

Less Contrast

SATURATION CONTROL
 +2 Maximum
 +1 Enhanced
 0 Normal
 -1 Moderate
 -2 Minimum
 Black&White
 Sepia

SATURATION CONTROL
 Control color in your pictures.

100

IMAGE QUALITY
 HI
 FINE FINE
 NORM NORMAL
 BASIC

IMAGE QUALITY
 Set image quality.

101–102

IMAGE SIZE
 2272 2272 x 1704
 1600 1600 x 1200
 1280 1280 x 960
 1024 1024 x 768
 640 640 x 480
 3:2 2272 x 1520 (3:2)

IMAGE SIZE
 Specify the dimensions of the image in pixels.

101–103

USER SETTING
 1 A-WB A
 2
 3

USER SETTING
 Store different combinations of menu settings in one of three banks.

104

IMAGE SHARPENING
 A Auto
 High
 Normal
 Low
 Off

IMAGE SHARPENING
 Heighten or reduce the sharpness of outlines.

105

LENS
 Normal
 Wide Adapter
 Telephoto1
 Telephoto2
 Fisheye1
 Fisheye2

LENS
 Choose these options when using an optional lens converter.

106–107

EXPOSURE OPTION
 OFF AE Lock
 0.0 Exp. +/-

EXPOSURE OPTIONS
 Additional options for setting exposure.

108–109

FOCUS OPTIONS
 AF Area Mode
 S-AF Auto-Focus Mode
 MF Focus Confirmation

FOCUS OPTIONS
 Options for autofocus.

110–111

ZOOM OPTIONS
 ON Digital Tele
 Startup Position
 OFF Fixed Aperture

ZOOM OPTIONS
 Options for optical and digital zoom.

112–113

+2 Maximum
 +1 Enhanced
 0 Normal
 -1 Moderate
 -2 Minimum
 Black&White
 Sepia

HI
 FINE
 NORMAL
 BASIC

2272x1704
 1600x1200 640x 480
 1280x 960 2272x1520 (3:2)
 1024x 768

1
 2
 3

A Auto
 High Off
 Normal
 Low

Normal
 Wide Adapter Fisheye1
 Telephoto1 Fisheye2
 Telephoto2 Slide Copy Adptr



AE Lock Off/On/Reset
 Exp. +/- -2.0 - +2.0



AF Area Mode Auto/Manual/Off
 Auto-Focus Mode Continuous AF/Single AF
 Focus Confirmation MF/On/Off

Digital Tele On/Off
 Startup Position Last Position/Wide
 Fixed Aperture Off/On

SPEEDLIGHT OPT.

SPEEDLIGHT OPT.
 Options for the built-in Speedlight and for optional Speedlights.  114–115

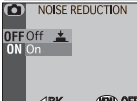
AUTO BRACKETING

AUTO BRACKETING
 Automatically vary exposure or white balance over a series of pictures.  116–117

NOISE REDUCTION

NOISE REDUCTION
 Reduce “noise,” a mottling effect that occurs at slow shutter speeds.  118

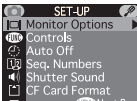
RESET ALL

RESET ALL
 Reset settings for the current User Set to their default values.  119–120



SET-UP

SET-UP
 Monitor Options
 Controls
 Auto Off
 Seq. Numbers
 Shutter Sound
 CF Card Format



SET-UP Menu (P, S, A, and M Modes)



The setup menu can be accessed from the shooting menu in **P**, **S**, **A**, and **M** modes.

MONITOR OPTIONS

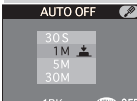
MONITOR OPTIONS
 Control the monitor.  122

CONTROLS

CONTROLS
 Assign function to FUNC. button and center of multi-selector.  123–124

AUTO OFF

AUTO OFF
 Specify how long monitor will remain on before turning off to save power.  125

SEQ. NUMBERS

SEQ. NUMBERS
 Control how the camera names picture files.  126

Pop-Up ▶ Auto/Manual
Variable Power ▶ –2.0 – +2.0
Speedlight Cntrl ▶ Internal/Off/Int&ExtActive

Off ▶ 3, ±0.3/3, ±0.7/
On ▶ 3, ±1.0/5, ±0.3/
WB Bracketing ▶ 5, ±0.7/5, ±1.0

Off
On

No
Reset

Display Mode ▶ Monitor On/Review Only/
 Preview Only/Monitor Off
Brightness ▶ 5 levels

FUNC ▶  / Continuous /
 QUAL / WB / Metering
AE-L,AF-L ▶ AE-L&AF-L/AE-L/AF-L

30 S
1 M
5 M
30 M

On
Off
Reset

SHUTTER SOUND SHUTTER SOUND
Control beep produced to confirm operations.

Off
On

◀BK MENU OFF

127

▶

Off

On

CF CARD FORMAT CF CARD FORMAT
Format memory cards for use in the COOLPIX4500.

WARNING!
All images will be deleted!

No
Format

◀BK MENU OFF

128

▶

No

Format

DATE DATE
Set time and date.

Y M D
2 0 2 . 0 1 . 0 1
0 0 : 0 0

◀BK MENU OFF

129

▶

Year, Month, Day, hour, minute, order of display for year, month, and day

SHOT CONFIRMATION SHOT CONFIRMATION
Control whether self-timer lamp fires to confirm shutter release.

Off
On

◀BK MENU OFF

129

▶

Off

On

INFO.TXT INFO.TXT
Save photo information in text format.

Off
On

◀BK MENU OFF

129

▶

Off

On

VIDEO MODE VIDEO MODE
Choose the standard for video output.

NTSC
PAL

◀BK MENU OFF

130

▶

NTSC

PAL

LANGUAGE LANGUAGE
Choose the language in which menus and messages will be displayed.

De
En
Fr
Es
J

◀BK MENU OFF

130

▶

De (German)

En (English)

Fr (French)

J (Japanese)

Es (Spanish)

DISABLE DELETE DISABLE DELETE
Disable all delete and format options.

Off
On

◀BK MENU OFF

131

▶

Off

On

USB USB
Choose USB option used when camera is connected to a computer.

PTP
Mass Storage

◀BK MENU OFF

131–132

▶

PTP

Mass Storage



PLAYBACK MENU

The playback menu contains options for managing the images stored on the memory card. It is available in playback mode.

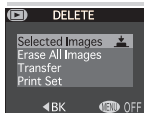

DELETE
Delete all or selected images; reset transfer or print marking. 133–135

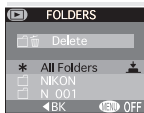

FOLDERS
Select a folder for playback; delete folders. 136–137



SLIDE SHOW
Play images back in an automatic slide show. 138–139

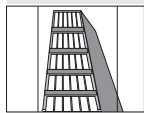

PERSPECTIVE CONTROL
Creates copy of existing image with altered vertical perspective. 140–142



SMALL PIC.
Specify size of pictures created with small picture option. 142



PROTECT
Protect selected pictures from accidental deletion. 143

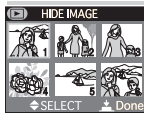

HIDE IMAGE
Hide pictures during playback. 144



PRINT SET
Select pictures for printing on a DPOF-compatible device. 145–146

Selected Images ▶ Select pictures.

Erase All Images

Transfer

Print Set

Delete ▶ Select folder.

All Folders

(Folder name)

Start

Frame Intvl ▶ 2 S/3 S/5 S/10 S

Image transform.

640 640 × 480

320 320 × 240

160 160 × 120

96 96 × 72

▶ Select pictures.

▶ Select pictures.

▶ Select pictures; specify number of copies.

AUTO TRANSFER
 Selected Photos
 All Photos
 ◀ BK INFO OFF

AUTO TRANSFER
 Select images for transfer to a computer.
 147–148

- Selected Photos ▶ Select pictures.
- All Photos

SET-UP
 Brightness
 Shutter Sound
 CF Card Format
 Date
 Video Mode
 Language
 INFO OFF

SET-UP Menu (Playback Mode)
 The options below can be accessed from both the playback and shooting menus.

BRIGHTNESS
 Increase or lower monitor brightness.
 ◀ BK INFO OFF

122

- 5 levels

SHUTTER SOUND
 Control beep produced to confirm operations.
 Off
 On
 ◀ BK INFO OFF

127

- Off
- On

CF CARD FORMAT
 WARNING !
 All images will be deleted !
 No
 Format
 ◀ BK INFO OFF

CF CARD FORMAT
 Format memory cards for use in the COOLPIX4500.
 128

- No
- Format

DATE
 Set time and date.
 Y M D
 2 0 0 2 . 0 1 . 0 1
 0 0 : 0 0
 ◀ BK INFO OFF

129

- Year, Month, Day, hour, minute, order of display for year, month, and day

VIDEO MODE
 Choose the standard for video output.
 NTSC
 PAL
 ◀ BK INFO OFF

130

- NTSC
- PAL

LANGUAGE
 Choose the language in which menus and messages will be displayed.
 De
 En
 Fr
 Es
 ◀ BK INFO OFF

130

- De (German)
- En (English)
- Fr (French)
- Es (Spanish)
- Et (Japanese)

The menu options available in shooting mode differ from those that can be accessed in playback mode. In **P**, **S**, **A**, and **M** modes, you have access to the shooting menu and all setup menu options; in playback mode, you can access the playback menu and a restricted set of setup menu options. In **AUTO** and scene modes, you have access to image quality and size options.

1 Display menu



Display menu for current operating mode.

AUTO mode: image size and quality menu

Scene mode: scene menu (to display image size and quality menu, highlight  and press center of multi selector)

P, S, A, M modes: shooting menu

Playback mode: playback menu



The Main Menu

To exit the IMAGE SIZE & QUALITY, SHOOTING, PLAYBACK, or SET-UP menus and return to shooting or playback mode, press the multi selector to the left when the main menu is displayed.

B

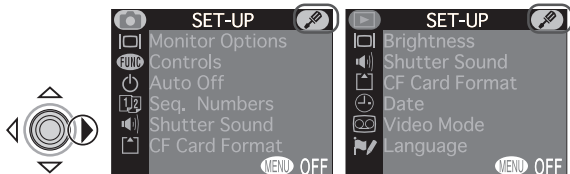

In **P**, **S**, **A**, **M**, and playback modes, you can select the setup menu by pressing the multi selector to the right to highlight . Press multi selector left to return to shooting (**P**, **S**, **A**, and **M**, modes) or playback menu (playback mode).

2 Activate the selected menu

To activate the selected menu, press the multi selector down (**P**, **S**, **A**, **M**, and playback modes only).



3 Select the desired page

If the selected menu has more than one page of options, you can view the next page by pressing the **MENU** button.

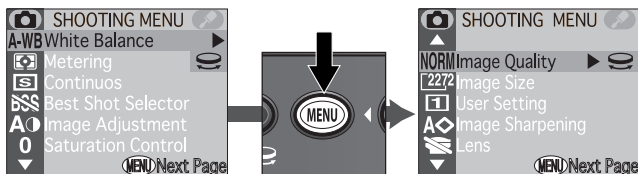

You can also scroll between pages by pressing the multi selector up and down.

When the last page of options is displayed, **MENU OFF** will appear at the bottom of the monitor. Press the **MENU** button to exit the menus and return to shooting or playback mode.

4 Make a selection

A.1



Highlight menu item

A.2

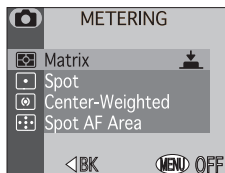

Display options

A.3

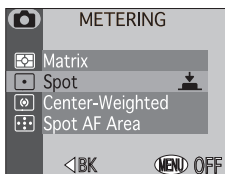

Highlight option. If sub-menu of options is available, repeat steps A.2 and A.3 to make highlight selection in sub-menu.

A.4



Make selection

Making Selections with the Command Dial

If a  icon appears next to a menu item, you can make a selection by rotating the command dial.

B.1

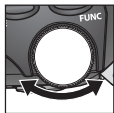

Rotate command dial

B.2



Stop when icon for desired option is displayed

5 Exit the menus

To exit the menus and return to shooting or playback mode, press the **MENU** button until **MENU OFF** is displayed in the bottom of the monitor, then press the MENU button again.



The Shooting Menu

Shooting Options

The shooting menu is available only in **P**, **S**, **A**, and **M** modes, and only when the camera is in shooting mode.

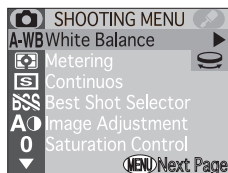

Page 1



Page 2

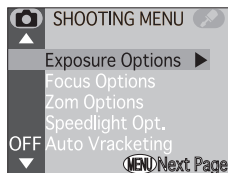

Page 3

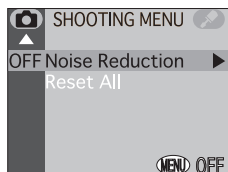

Page 4

Option	
White Balance	92–94
Metering	95
Continuous	96–97
Best Shot Selector	98
Image Adjustment	99
Saturation Control	100
Image Quality	101–102
Image Size	101–103
User Setting	104
Image Sharpening	105
Lens	106–107
Exposure Options	108–109
Focus Options	110–111
Zoom Options	112–113
Speedlight Opt.	114–115
Auto Bracketing	116–117
Noise Reduction	118
Reset All	119

Keeping Colors True: *White Balance*





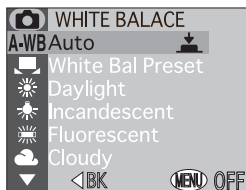

What Is “White Balance”?

The color of the light reflected by an object depends on the color of the light source. The human brain is able to detect and compensate for such changes in color, with the result that a white object will look white to humans whether viewed in sunlight, under overcast skies, or indoors under incandescent or fluorescent lighting. To a camera, however, the “whites” produced by these different sources of light vary in color, some being slightly blue and others yellow or red. A digital camera can adjust colors according to lighting so that colors that appear white to the human eye also appear white when viewed in the final photograph. This adjustment is called “white balance.”

Choosing a White Balance Setting

In **P**, **S**, **A**, and **M** modes, white balance can be adjusted using the white-balance option in the SHOOTING menu (in  and scene modes, white balance is adjusted automatically).



Option	Description
 A-WB Auto	White balance automatically adjusted to suit lighting conditions. Best choice in most circumstances.
 White Bal Preset	White object used as reference to set white balance under unusual lighting conditions.
 Daylight	White balance adjusted for direct sunlight.
 Incandescent	For use with incandescent lighting.
 Fluorescent	For use with most types of fluorescent lighting.
 Cloudy	Use for pictures taken under cloudy skies.
 Speedlight	White balance adjusted to match light produced by Nikon Speedlights.

Fine-Tuning White Balance

At settings other than **A-WB (Auto)** and **☐ (White Bal Preset)**, white balance can be “fine tuned” by highlighting the desired setting and rotating the command dial to select an option from a sub-menu. Adjustments range from -3 to +3 in increments of one; raising white balance tends to give images a blue cast, while lowering white balance generally makes photos appear slightly yellow or red. In the case of **☀ (Fluorescent)**, the sub-menu offers a choice of bulb types (see table at right).

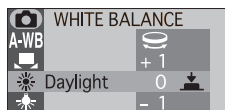

Option	Bulb Type
FL1	White (W)
FL2	Daylight White (Neutral [N])
FL3	Daylight (D)

☐ Confirming White Balance

At settings other than **A-WB (A-WB)**, a white-balance icon appears in the monitor.

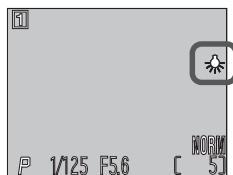

Preset White Balance

Preset white balance is used when shooting under mixed lighting or to compensate for light sources with a strong color cast (for example, to make pictures taken under a lamp with a red shade look as though they had been taken under white light). When  (**White Bal Preset**) is selected from the white-balance menu, the camera will zoom in and the menu at right will appear in the monitor.

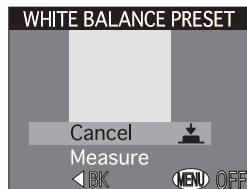





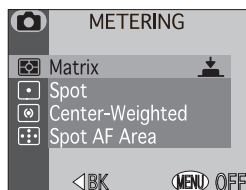

Option	Description
Cancel	Recalls the most recent setting for preset white balance from memory and sets white balance to this value.
Measure	To measure a new value for white balance, place a white object, such as a piece of paper, under the lighting that will be used in the final photograph. Frame this object so that it fills the square in the center of the menu shown above. Highlight Measure and press the center of the multi selector to measure a new value for white balance (shutter will be released and camera will return to original zoom position, but no picture will be recorded).

Measuring Light: *Metering*

The metering menu offers a choice of four metering methods that determine how the camera sets exposure (in  and scene modes, matrix metering is used).



Option	Description
 Matrix	Compares measurements from 256 areas of frame with library of typical compositions to produce optimal exposure for entire image. Best choice in most circumstances.
 Spot	Camera measures light in area shown by square in center of monitor. Only about $\frac{1}{32}$ of entire frame is metered. Ensures that subject in metering target will be correctly exposed even when background is much brighter or darker. Can be used with autoexposure lock ( 108) to meter off-center subjects.
 Center-Weighted	Camera meters light in entire frame but assigns a weight of 80% to area in center of frame occupying roughly $\frac{1}{4}$ of total. Classic meter for portraits; preserves background details while letting lighting conditions at center of frame determine exposure. Can be used with autoexposure lock ( 108) to meter off-center subjects.
 Spot AF Area	Camera measures light in current focus area only. Useful when you want to use spot metering with manual or automatic focus-area selection ( 110) to meter an off-center subject.

Confirming the Metering Method

At settings other than **Matrix**, the current metering method is indicated by an icon in the monitor.



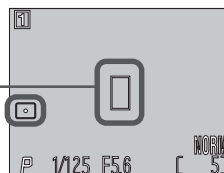

Spot-metering target

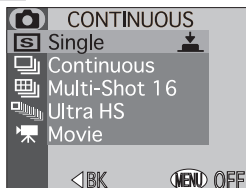

Taking a Sequence of Shots: *Continuous*

The options in the “continuous” menu determine whether the camera takes one picture each time the shutter-release button is pressed or records a continuous sequence of pictures while the shutter-release button is held down. A movie option is available for making short videos with sound.



Option	Description
 Single	Camera records one picture each time shutter-release button is pressed.
 Continuous	Camera records pictures at a rate of about three frames every two seconds (1.5 fps)* while shutter-release button is held down. Not available at HI image quality.
 Multi-Shot 16	Each time the shutter-release button is pressed, the camera takes sixteen consecutive “thumbnail” images 568 × 426 pixels in size and combines them into a collage measuring 2272 × 1704 pixels. This option is available only at a size of 2272 × 1704 and FINE , NORMAL , or BASIC image quality.
 Ultra HS	Camera records up to seventy NORMAL -quality pictures 320 × 240 pixels in size (QVGA) at a rate of about thirty frames per second while shutter-release button is held down. Each sequence of pictures is stored in its own folder.
 Movie	Camera records QVGA (320 × 240 pixel) movie, with sound recorded via built-in microphone. Recording starts at rate of about 15 fps when shutter-release button is pressed, ends after 35 s or when shutter-release button is pressed again.

* Rate of 1.5 fps is for image size of **2272 × 1704**. Shooting will slow when memory buffer fills.

Focus, Exposure, and White Balance

At settings other than **Single** and **Movie**, focus, exposure, and white balance are determined by the first picture in each series.

Ultra HS/Movie

At a setting of **Ultra HS**, the zoom indicator in the monitor moves from **S** (start) to **E** (end) as recording progresses. The exposure-count display shows the number of seventy-pictures sequences that can be recorded. At a setting of **Movie**, the exposure-count display shows the length of the movie that can be recorded, in seconds.



With each sequence of pictures taken at **Ultra HS**, the camera creates a new folder in which all pictures in the sequence are stored. Each folder will have a name consisting of "N_" followed by a three-digit number assigned automatically by the camera. Pictures can be played back by selecting the appropriate folder or **All Folders** from the playback **Folders** menu.

Movie and **Ultra HS** are only available when the monitor is on. If the monitor is off, the camera will revert to **Single** until the monitor is turned on. If lens section is rotated to point in the same direction as the monitor during recording, the image in the monitor will be inverted and movies and photographs will be recorded upside down.

While **Movie** or **Ultra HS** is in effect, bracketing will turn off. At a setting of **Movie**, focus confirmation will also turn off. Selecting **ON** for BSS cancels **Movie** and **Ultra HS**.

Using a Flash

At settings other than **Single**, the built-in Speedlight turns off automatically. Optional Speedlights connected to via a flash bracket can be used at settings other than **Movie** and **Ultra HS**.

Confirming the Continuous Setting

At settings other than **Single**, the current continuous setting is indicated by an icon in the monitor.



Getting Sharper Pictures: *BSS (Best Shot Selector)*

The “Best Shot Selector” (BSS) is recommended for situations in which inadvertent camera movement can produce blurred pictures, for example when:

- the camera is zoomed in or a teleconverter is used for telephoto photography
- you are taking close-up shots at short range
- the flash can not be used although lighting is poor

BSS may not produce the desired results with a moving subject or if you change the composition while the shutter-release button is pressed all the way down.



Option	Description
Off	BSS off; camera functions normally.
On	Camera takes photos as long as the shutter-release button is held down, to a maximum of ten. These images are then compared and the sharpest photo (the image with the highest level of detail) saved to the memory card. The flash turns off, and focus distance, exposure, and auto white balance are determined by the first photograph in the series.

Restrictions on BSS

BSS can not be used in combination with bracketing, noise reduction, or CONTINUOUS settings other than **Single**. The flash can not be used when BSS is in effect.

Confirming BSS

When BSS is on, a **BSS** icon appears in the monitor.



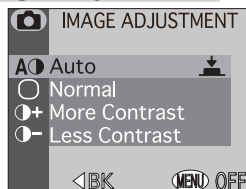

Adjusting Contrast and Brightness: *Image Adjustment*

This option is used to adjust brightness and contrast according to the shooting situation or how the picture will be used.



Option	Description
Auto	Camera automatically adjusts brightness and contrast according to shooting conditions.
Normal	Camera performs same standard brightness and contrast adjustment on all images. Recommended for images that will later be retouched on a computer.
More Contrast	Image processed to emphasize difference between light and dark areas, enhancing contrast. Useful under overcast skies or when shooting landscapes and other low-contrast subjects.
Less Contrast	Image processed to decrease difference between light and dark areas, reducing contrast. Recommended when light is very bright, creating strong shadows on subject.

Viewing the Current Image Adjustment Setting



At settings other than **Auto**, an image-adjustment icon appears in the monitor. When **Saturation Control** (100) is set to **Black&White** or **Sepia**, the image-adjustment icon is replaced by a  or  icon.

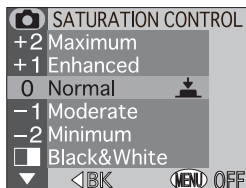

Controlling Color: Saturation Control

Saturation control is used to heighten or reduce the vividness of colors.



Option	Description
+2 Maximum	Use for a vivid, photoprint effect when taking pictures that will be printed "as is," without further editing.
+1 Enhanced	
0 Normal	Best choice in most circumstances.
-1 Moderate	Vividness of colors is reduced. Suitable for pictures that will later be retouched on a computer.
-2 Minimum	
 Black&White	Pictures recorded in black-and-white. Black-and-white images require the same amount of memory as color images. Monitor shows view through lens in black-and-white.
 Sepia	Pictures recorded as monochrome sepia images. Sepia images require the same amount of memory as color images. Monitor shows view through lens in sepia.

Black-and-White/Sepia

At settings of **Black&White** and **Sepia**, the current setting is shown in the monitor and indicators are displayed in green.

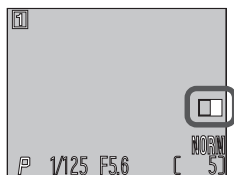

Making Effective Use of Memory: Image Quality and Size

Together, image quality and size determine how much space each photograph occupies on the memory card. This in turn determines the total number of photographs that can be stored. To get an idea of how different settings for image quality and size affect the number of images that can be stored on a memory card, view the following table, which shows the approximate number of photographs that can be stored on 16 MB, 64 MB, and 128 MB cards at different combinations of image quality and size.

Card	Image Quality	Image Size					
		2272 × 1704	1600 × 1200	1280 × 960	1024 × 768	640 × 480	2272 × 1520 (3 : 2)
16 MB Card	HI	1	—	—	—	—	1
	FINE	8	16	24	37	86	9
	NORMAL	16	31	47	69	144	17
	BASIC	32	59	86	121	229	34
64 MB Card	HI	5	—	—	—	—	6
	FINE	33	65	100	151	347	36
	NORMAL	65	125	190	278	578	71
	BASIC	130	236	347	488	918	139
128 MB Card	HI	10	—	—	—	—	12
	FINE	66	130	201	304	698	73
	NORMAL	132	253	383	560	1163	144
	BASIC	261	475	698	981	1847	280

* Figures are approximate. The file size of JPEG-compressed images varies with the scene recorded.

Image Quality

To reduce the amount of memory that each shot occupies, pictures taken at settings other than HI are compressed as they are saved to the memory card. Compression selectively reduces the quality of the image; the more the picture is compressed, the more noticeable this loss of quality is likely to be. The actual effect depends on the size of the picture when printed or displayed and on the type of subject.



Option	Compression ratio (approx.)	File format	Description
HI (P, S, A, M modes only)	No compression	TIFF	Maximum image quality. Use when fidelity is of paramount importance. Only available at image sizes of 2272 × 1704 and 2272 × 1520.
FINE	1 : 4	JPEG	Fine image quality, suitable for enlargements or high-quality prints.
NORMAL	1 : 8	JPEG	Normal image quality, suited to most applications.
BASIC	1 : 16	JPEG	Basic image quality, suitable for photographs that will be distributed by e-mail or used in web pages.



Confirming Image Quality and Size Settings

The current image quality and size settings are displayed in the monitor. Image size is not displayed at a setting of **2272 × 1704**.

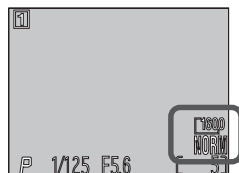
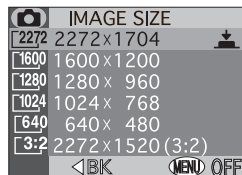

Image Size

Image size refers to the physical dimensions of the image, measured in pixels. Smaller sizes require less space to store, making them suited to distribution by e-mail and the web. Conversely, the larger the image, the larger the size at which it can be printed without becoming noticeably “grainy.” Choose an image size according to the space available on the memory card and the task at hand.



Option	Description
2272 × 1704	Size when printed at 300 dpi is about 19 × 14 cm (7½" × 5½").
1600 × 1200	Size when printed at 300 dpi is about 13 × 10 cm (5" × 4").
1280 × 960	Size when printed at 300 dpi is about 10 × 8 cm (4" × 3").
1024 × 768	Suited to printing at smaller sizes (for example, as an illustration in a letter or report), or to display on monitors 17" or larger.
640 × 480	Can be displayed full screen on 13" monitors. Suited to distribution by e-mail or the web.
2272 × 1520 (3 : 2)*	The top and bottom of the frame are cropped out to produce a picture of the same proportions as photographs taken with a 35-mm film camera. The autofocus lamp blinks slowly to show that photographs can not be accurately framed in the viewfinder.

*Not available in scene mode.

Print Size

The size of pictures when printed depends on the resolution of the printer (the higher the resolution, the smaller the final print size).

Storing Menu Settings: User Setting

This option allows you to store up to three combinations of white balance, metering, “continuous,” image adjustment, saturation control, image sharpening, and lens settings for different situations and recall them as desired. By default, changes to these settings are stored as User Setting 1. To store a different combination of settings in another user settings bank:

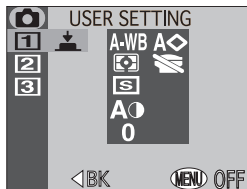

- 1 Press the multi selector up or down to highlight the desired user settings bank (user setting 1, 2, or 3). Settings for the current bank are displayed to the right of the menu, with items that differ from defaults shown in red. Press the center of the multi selector to put your choice into effect and return to the shooting menu (the user settings bank can also be selected directly from the shooting menu using the command dial).
- 2 Adjust white balance, metering, “continuous,” image adjustment, saturation control, image sharpening, and lens settings as desired. All changes to these settings will be stored in the current bank, remaining in memory even when the camera is turned off. The selected settings will be restored the next time you choose the bank from the **User Setting** menu. Only settings in the current bank will be affected when settings are reset (119).

Confirming User Setting





In **P**, **S**, **A**, and **M** modes, the current bank number is shown in the monitor.

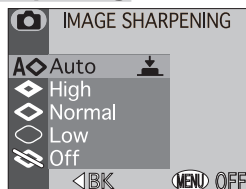

Making Edges More Distinct: *Image Sharpening*

This option controls whether pictures are processed for increased sharpness, and to what degree. Because this processing takes place only as the pictures are being saved to the memory card, the effects of sharpening can not be previewed in the monitor before shooting.



Option	Description
A  Auto	Camera sharpens edges for optimal results; adjustment performed differs from image to image.
 High	Photos processed to increase sharpness, making edges more distinct.
 Normal	Camera performs same standard level of sharpening on all photos.
 Low	Amount of sharpening reduced below normal level for a softer effect.
 Off	No sharpening performed.

When taking pictures that will later be retouched, choose settings of **Normal** or **Low**.

Confirming Image Sharpening

At settings other than **Auto**, an image-sharpening icon appears in the monitor.

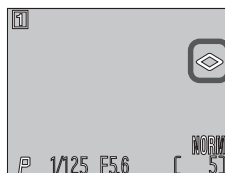

Settings for Optional Converter Lenses: *Lens*

The lens menu is used to select combinations of settings suited to different converter lenses (available separately). For complete information on use and handling, see the documentation provided with your converter lens.



Option	Use with	Description
Normal	—	No modifications are made to settings.
Wide Adapter	WC-E63 ^{1,2}	Zoom set to widest angle; can be adjusted manually.
Telephoto1	TC-E2 ^{1,2}	Zoom set to maximum optical zoom position; can be adjusted manually.
Telephoto2	TC-E3ED ^{1,2}	Zoom set to maximum optical zoom position; can be adjusted manually.
Fisheye1 (Creates circular image)	FC-E8 ³	<ul style="list-style-type: none"> • Zoom fixed at widest angle. • Focus fixed at infinity.⁴ • Metering fixed at center-weighted.
Fisheye2	FC-E8 ³	<ul style="list-style-type: none"> • Zoom fixed at middle position. • Focus mode fixed at autofocus.⁴
<input type="checkbox"/> Slide Copy Adptr	ES-E28 ³	<ul style="list-style-type: none"> • Zoom set to middle position. • Focus mode fixed at macro close-up.⁴ • Exposure compensation set to +0.7 EV; can be adjusted manually.⁵ • Image adjustment set to Less Contrast; can be adjusted manually.

¹ Built-in Speedlight turns off. External flash accessories can still be used.

² Use autofocus. Results will not accurately reflect selected focus distance when manual focus or infinity is used.

³ Both built-in and optional Speedlights turn off automatically.

⁴ Self-timer can be used.

⁵ When **Positive** selected in sub-menu.

Slide Copy Adapter

Selecting **Slide Copy Adptr** displays the menu shown at right.



Option	Description
<input type="checkbox"/> Positive	Use when making photographs from color film.
Inverse Color	Use when examining film negatives in the monitor.

Slide Copy Adapter: Inverse Color

The **Inverse Color** option requires a bright light source. If lighting is insufficient, the image in the monitor will be too bright. Should you notice excessive “noise” in the form of randomly spaced bright pixels, set image sharpening to **Off** or **Low** (105).

Inverse Color is intended for use only when examining film negatives in the monitor, and the quality of the image produced will vary widely with the type and make of film used. We recommend that you use a film scanner such as the Nikon COOLSCAN to obtain high-quality digital images from negative film.

Swivel Limit

To prevent the lens section from rotating more than 90 ° forward, slide the swivel limit switch as shown at right. This prevents unintended rotation when a converter lens is attached.

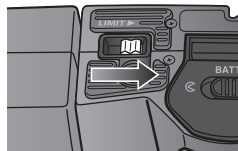

Confirming the Lens Setting

At settings other than **Normal**, a converter lens icon appears in the monitor.

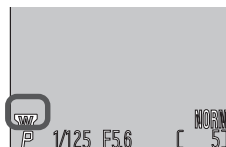

Controlling Exposure: Exposure Options

The exposure options sub-menu contains two options: one for fixing exposure at the value selected by the camera, the other for altering exposure from the value suggested by the camera.



AE Lock

This option is used to take a series of photographs with the same exposure and white balance.



Option	Description
Off	Restores normal exposure and white balance.
On	The first photo taken after On is selected sets shutter speed, aperture, sensitivity, and white balance for all subsequent photographs. The flash is turned off while AE lock is in effect.
Reset	Clears existing exposure settings. The first photograph taken after this option is selected sets shutter speed, aperture, sensitivity, and white balance for all subsequent photographs.

Confirming AE-Lock Settings

The **AE-L** (AE-Lock) icon in the monitor turns yellow when **On** or **Reset** is chosen from the **AE-Lock** menu. Once exposure has been set, this icon will turn white.



Exp. +/-

The **Exp. +/-** (exposure compensation) menu allows you to alter exposure from the value suggested by the camera. Exposure can be adjusted in the range -2.0 EV to $+2.0$ EV in increments of $\frac{1}{3}$ EV. Choose negative values to make your pictures darker, positive values to make them brighter.

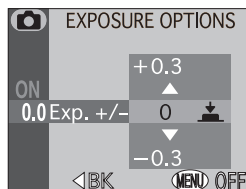

Confirming Exposure Compensation

At values other than ± 0 , exposure compensation is displayed in the monitor.

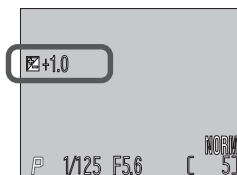

Controlling Focus: Focus Options



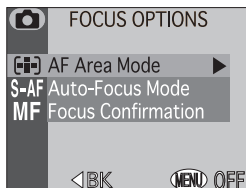

The focus options sub-menu contains options controlling focus-area selection and focus mode, and an option for confirming focus visually in the monitor.

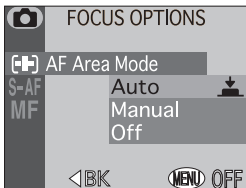

Focus-Area Selection: AF Area Mode

The setting chosen for this option determines how the focus area is selected in **P**, **S**, **A**, and **M** modes. The chosen setting applies only when the monitor is on; while the monitor is off or digital zoom is in effect, **AF-Area Mode** is set to **Off** and the center focus area is used.



Option	Description
 Auto	Camera automatically selects focus area containing subject closest to camera. Selected focus area is displayed in red in monitor when shutter-release button is pressed halfway. This setting minimizes the risk of your photograph being out of focus when your subject is moving erratically or in other situations where there is little time to check focus.
 Manual	User selects focus area manually using multi selector. This option can be used instead of focus lock ( 60) to focus on a relatively motionless subject that is not at the center of the frame.
 Off	Center focus area (shown by focus brackets in viewfinder) is used. No focus area indicators are shown in monitor. This option can be used in combination with focus lock to focus on an off-center subject.

Spot AF Area Metering (95)

Manual and auto focus-area selection can be used in combination with spot AF-area metering to meter exposure only in the selected focus area.

Auto-Focus Mode

This option controls whether the camera adjusts focus continuously, or only when the shutter-release button is pressed halfway. The chosen setting applies only when the monitor is on; when the monitor is off, the camera focuses only when the shutter-release button is pressed halfway.

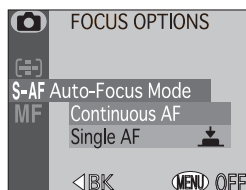

Option	Description
Continuous AF	Camera adjusts focus continuously until shutter-release button is pressed halfway, minimizing time needed to focus before photo is taken. Note, however, that photos can be taken even when camera is not in focus; check autofocus lamp before shooting.
Single AF	Camera focuses when shutter-release button is pressed halfway. If monitor is off, photos can only be taken when camera is in focus. Choose this setting to save batteries.

Focus Confirmation

This option provides visual confirmation of focus by sharply outlining in the monitor the areas of the frame that are in focus. Focus confirmation affects only the view in the monitor; no indicators of focus appear in the final photograph.

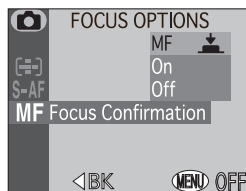

Option	Description
MF	Areas of the image that are in focus will be sharply outlined in the monitor when manual focus is used (61).
On	Areas of the image that are in focus will be sharply outlined in the monitor in all focus modes.
Off	No indication of focus is given.

Controlling Zoom: Zoom Options

This sub-menu contains three options for controlling optical and digital zoom.

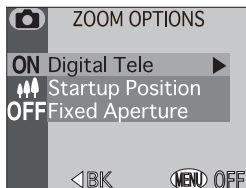

Digital Tele

This sub-menu is used to turn digital zoom on and off. If **On** is selected, the camera enters digital zoom mode when the **D** button is held down for more than two seconds at the maximum optical zoom position (digital zoom does not take effect if monitor is off). If **Off** selected, pressing the **D** button at the maximum optical zoom position has no effect.

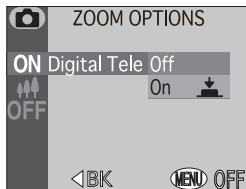

Startup Position

This option determines the starting zoom position when the camera is turned on.



Option	Description
OFF ← Last Position	Camera zooms to the position it was last in before being turned off.
↑↑↑ Wide	Camera zooms out to widest angle.

Fixed Aperture

Normally, aperture changes with the zoom position. If desired, you can set the camera to maintain the *f*-number selected in aperture-priority or manual exposure modes as you zoom in or out.

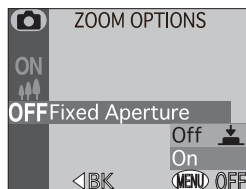

Option	Description
Off	Aperture changes as you zoom in or out.
On	In aperture-priority and manual exposure modes, aperture is fixed at selected <i>f</i> -number as camera is zoomed in or out. Note that the selected <i>f</i> -number may exceed the camera's exposure range at the new zoom position; to prevent this, choose an <i>f</i> -number from about <i>f</i> /5 to around <i>f</i> /7.

Controlling the Flash: *Speedlight Options*



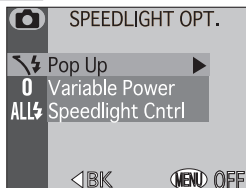

This sub-menu contains three options for controlling built-in and external Speedlights.

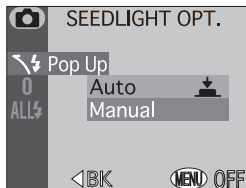

Popup Settings for the Built-in Speedlight: *Pop-Up*

This option controls whether the built-in Speedlight pops up automatically.



Option	Description
 Auto	Built-in Speedlight pops up automatically when required.
 Manual	Built-in Speedlight pops up only when  button is pressed. Flash mode can be adjusted when built-in Speedlight is raised; note, however, that flash mode can not be set to  (off). Flash fires with every shot, regardless of brightness of subject.

Controlling Flash Output: *Variable Power*

This sub-menu is used to adjust flash output. Flash output can be lowered or raised by from -2.0 EV to $+2.0$ EV in increments of $\frac{1}{3}$ EV.

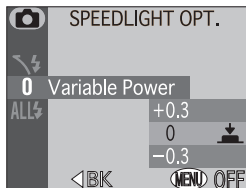

Options for Optional Speedlights: *Speedlight Cntrl*

This sub-menu is used to control the built-in Speedlight when using optional Nikon Speedlights connected to the camera's sync terminal (🔌 66).

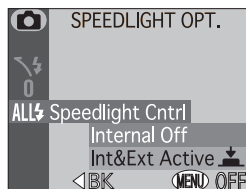











Option	Description
 Internal Off	Built-in Speedlight turns off; only optional Speedlights will fire.
ALL⚡ Int&Ext Active	Built-in Speedlight fires at same time as optional Speedlights. When no optional Speedlights are connected, built-in Speedlight functions normally.

Using an Optional Speedlight

Flash control for optional Speedlights is performed using the photocell on the built-in Speedlight, which pops up automatically when required in **AUTO** mode or when **Auto** (the default setting) is selected for **Pop Up**. Do not block the built-in Speedlight with your fingers or other objects. When the built-in Speedlight is raised, keep your fingers and other objects away from the photocell.

Flash-Mode Indicators for Optional Speedlights

When **Internal Off** is selected in the **Speedlight Cntrl** sub-menu, a  icon appears next to the flash-mode indicator to show that built-in Speedlight is off. Flash mode for the optional Speedlight is set by pressing the  button (🔌 64), and the flash mode for the optional Speedlight is shown as at right.

Flash Mode	Icon
Auto	A 
Flash Cancel (off)	
Auto with red-eye reduction*	 
Anytime Flash (fill flash)	 
Slow sync	 

* Red-eye reduction performed by built-in Speedlight. Be sure built-in Speedlight is raised.

Varying Settings Automatically: Auto Bracketing

In some situations, you may find it difficult to select appropriate exposure-compensation and white-balance settings, and yet not have time to check the results and adjust settings after each shot. Auto bracketing can be used to vary these settings automatically over a series of photographs, “bracketing” a selected exposure-compensation or white-balance setting.

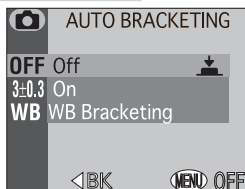

Off

Select **Off** to restore normal exposure and white balance.

On

The camera varies exposure with each shot; the number of shots in each sequence and the amount of exposure compensation performed are selected from the sub-menu shown at right. Bracketing is performed by varying shutter speed (**A** and **M** modes), aperture (**S** mode), or shutter speed and aperture (**P** mode). No bracketing is performed if the amount of exposure compensation would exceed the limits of the camera's exposure system.

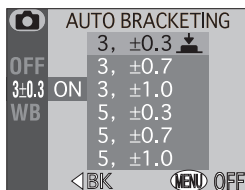

Option	No. of shots	Exposure increment	Bracketing order
3, ±0.3	3	± $\frac{1}{3}$ EV	0, +0.3, -0.3
3, ±0.7	3	± $\frac{2}{3}$ EV	0, +0.7, -0.7
3, ±1.0	3	±1 EV	0, +1.0, -1.0
5, ±0.3	5	± $\frac{1}{3}$ EV	0, +0.7, +0.3, -0.3, -0.7
5, ±0.7	5	± $\frac{2}{3}$ EV	0, +1.3, +0.7, -0.7, -1.3
5, ±1.0	5	±1 EV	0, +2.0, +1.0, -1.0, -2.0





WB Bracketing

White-balance bracketing can be used if you are uncertain whether the option selected in the white balance menu will produce the desired results, or if you want to experiment with different white balance settings without confirming the view in the monitor before each shot. When this option is in effect, the camera creates three pictures with each shot: one image with the selected white balance value, one image with a reddish cast, and one image with a bluish cast.

Recording Time

Because the camera takes three shots each time the shutter-release button is pressed, the time required to save images to the memory card is approximately tripled when white-balance bracketing is used.

Restrictions on Bracketing

Autoexposure bracketing can not be used when: **BSS** ( 98), **AE-Lock** ( 108), or **Noise Reduction** ( 118) is on, or **Multi-shot 16**, **Ultra HS**, or **Movie** is selected for **Continuous** ( 96).

White-balance bracketing can not be used when: **BSS** or **Noise Reduction** is on, image quality is set to **HI** ( 102), or a setting other than **Single** is chosen for **Continuous**.

Confirming Autoexposure Bracketing

While bracketing is in effect, a **BKT** icon appears in the monitor next to the selected exposure increment.

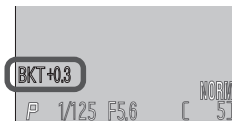

Confirming White Balance Bracketing

While white-balance bracketing is in effect, a **WB-BKT** icon appears in the monitor.



Avoiding “Grainy” Photographs: Noise Reduction

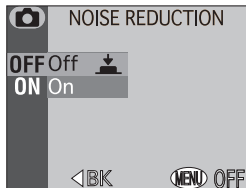

At shutter speeds slower than $\frac{1}{4}$ s, “noise” in the form of randomly-spaced, brightly-colored pixels may appear in pictures, particularly in shadows. To reduce noise at slow shutter speeds, select **On** from the noise reduction menu.



Recording Time

Turning noise reduction on more than doubles the amount of time needed to save pictures to the memory card.

Restrictions on Noise Reduction

Noise reduction can not be used in combination with **BSS** ( 98), **Auto Bracketing** ( 116), or **Continuous** settings other than **Single** ( 96).

Confirming Noise Reduction

While noise reduction is in effect, an **NR** icon appears in the monitor.

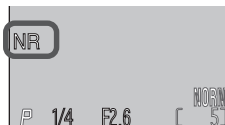

Restoring Default Settings: *Reset All*

The **Reset All** option is used to reset settings for the current User Set to their default values. The items listed on the following page are also reset for all User Sets and for playback mode.

Choosing **Reset** restores the following shooting options for the current User Set to their default values. With the exception of the settings listed on the following page, settings in other User Sets are unaffected. Choose **No** to exit the menu, leaving settings unchanged.

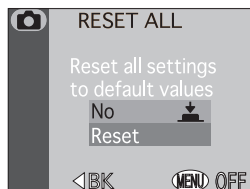

Setting	Default
White balance	Auto*
Metering	Matrix
Continuous	Single

*Fine-tuning reset to 0.

Setting	Default
Image adjustment	Auto
Saturation control	Normal
Image sharpening	Auto
Lens	Normal

In addition, the following items are reset for all User Sets and playback mode. **Reset All** does not affect image quality or size, User Setting, FUNC, sequential numbers, date, info.txt, video mode, language, and USB settings.

Setting	Default
Best Shot Selector*	Off
Exposure Options	
AE Lock	Off
Exposure Compensation	0
Focus Options	
AF-Area Mode	Auto
Auto-Focus Mode	Single AF
Focus Confirmation	MF
Zoom Options	
Digital Tele	On
Startup Position	Wide
Fixed Aperture	Off
Speedlight Options	
Pop Up	Auto
Variable Power	0
Speedlight Control	Int&Ext Active
Auto Bracketing	Off
Noise Reduction	Off

Setting	Default
Monitor Options	
Display Mode	Monitor On
Brightness	Middle
Controls	
AE-L, AF-L	AE-L & AF-L
Auto Off	1 M
Shutter Sound	On
Shot Confirmation	Off
Disable Delete	Off
Slide Show	
Frame Interval	3 s

* If BSS has been adjusted in other User Sets, the BSS settings for these sets will not be affected. The BSS setting for the current User Set will be reset.

The Set-up Menu

Camera Setup

The options available in the set-up menu depend on the operating mode.

The SET-UP Menu (P, S, A, M)

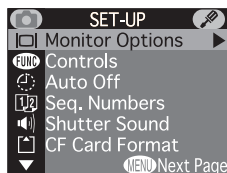

Page 1

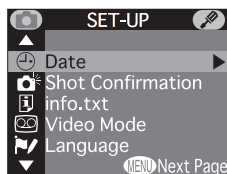

Page 2

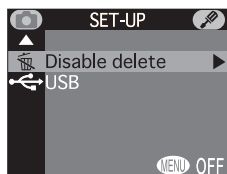

Page 3

The SET-UP Menu (Playback)

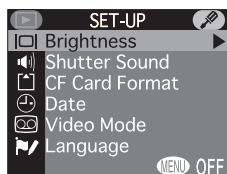

Option	
Monitor Options	122
Controls	123–124
Auto Off	125
Seq. Numbers	126
Shutter Sound	127
CF Card Format	128
Date	129
Shot Confirmation	129
info.txt	129
Video Mode	130
Language	130
Disable Delete	131
USB	131–132



Option	
Brightness	122
Shutter Sound	127
CF Card Format	128
Date	129
Video Mode	130
Language	130

Adjusting Monitor Settings: *Monitor Options*

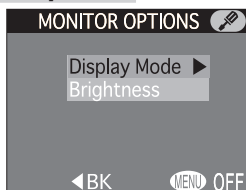
The monitor options menu is used to set monitor brightness. In **P**, **S**, **A**, and **M** modes, it contains an option for specifying whether and when the monitor will turn on automatically.



Controlling the Monitor: *Display Mode (P, S, A, M Only)*

This option specifies whether the monitor will turn on automatically when the camera is turned on and whether pictures are displayed in the monitor after shooting (“picture review”) in **P**, **S**, **A**, and **M** modes. Regardless of the setting chosen, the monitor can be turned on or off at any time by pressing the  button. In  and scene modes, the camera is automatically set to **Monitor On**.



Option	Monitor on at startup	Picture review
Monitor On	Yes	On
Review Only	No	On
Preview Only	Yes	Off
Monitor Off	No	Off

Adjusting Monitor Brightness: *Brightness*

This option controls monitor brightness. Press the multi selector up or down to increase or decrease the brightness of the monitor by moving the arrow to the right of the display up or down. The results of any changes are immediately visible in the center of the display.



Customizing Camera Controls: **FUNC** Controls



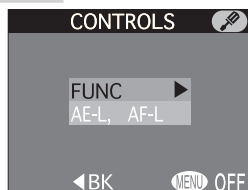



The options in the **Controls** sub-menu determine the functions assigned to the **FUNC** button and the center of the multi selector in shooting mode.

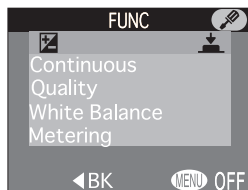

FUNC

You can choose the function assigned to the **FUNC** button, making it possible to adjust the following settings without accessing the camera menus:



Option	Description
	Exposure compensation can be set by pressing the FUNC button and rotating the command dial ( 69).
Continuous	The “continuous” setting ( 96) can be set by pressing the FUNC button and rotating the command dial.
Quality	Image quality ( 102) can be set by pressing the FUNC button. Image size ( 103) can be set by pressing the FUNC button and rotating the command dial.
White Balance	White balance ( 92) can be set by pressing the FUNC button and rotating the command dial.
Metering	MeteringI ( 95) can be set by pressing the FUNC button and rotating the command dia.

AE-L, AF-L

By default, both focus and exposure are locked when the center of the multi selector is pressed in shooting mode. The options in the **AE-L, AF-L** menu can be used to set the center of the multi selector to lock only one of focus and exposure.



Option	Description
AE-L&AF-L	Pressing center of multi selector locks both focus and exposure.
AE-L	Pressing center of multi selector locks exposure only. Focus is locked when shutter-release button is pressed halfway.
AF-L	Pressing center of multi selector locks focus only. Exposure is locked when shutter-release button is pressed halfway.

When the multi selector is used to lock auto-exposure, **AE-L** is displayed in the monitor in white.

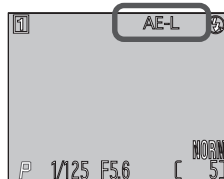

Conserving Battery Power: ⌚ Auto Off

When operated on battery power, the camera will turn off automatically if no operations are performed for a specified period of time. The time limit for auto power off can be chosen from thirty seconds, one minute (the default setting), five minutes, and thirty minutes using the **Auto Off** menu. When the camera turns off, the power lamp will go out. Use the power switch to turn the camera on again.

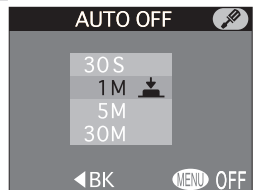

When powered by an AC adapter (available separately), the camera will turn off if no operations are performed for thirty minutes, regardless of the setting in the **Auto Off** menu.

File Numbering: *The Seq. Numbers Menu*

The camera assigns each picture a file name consisting of "DSCN" followed by a four-digit number assigned automatically by the camera (e.g., "DSCN0001.JPG"). This option controls how files are numbered.



Option	Description
On	When this option is selected, the camera assigns all subsequent file numbers sequentially in ascending order, starting from the last number used. If the memory card is formatted or a new card inserted in the camera, file numbering will continue from the last number used.
Off	The camera does not store the last file number used. When another memory card is inserted or a new folder is created, numbering starts from the lowest number available.
Reset	Clears the current file number from memory. Sequential numbering begins again from the lowest number available.

File Numbering

File numbering starts over from 0001 if a picture is taken when the current folder contains a file numbered 9999. The camera will create a new folder by adding one to the current folder number (for example, if the current folder is "100NIKON," the new folder will be named "101NIKON"). The new picture will be numbered 0001 and stored in the new folder. Each folder can hold up to 200 pictures. If file numbering reaches 9999 when the card contains a folder numbered 999, no more pictures can be stored on the card, even if sufficient memory remains. Insert a new memory card or format the current card.

Panorama Assist

Regardless of the option selected for **Seq. Numbers**, each sequence of pictures created at a setting of **Panorama Assist** ( 50) is stored in its own folder, with file numbering beginning from 0001.

Audio Confirmation: **Shutter Sound**

The **Shutter Sound** sub-menu controls the “beep” made by the camera’s speaker.

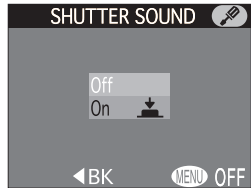

Option	Description
Off	Confirmation and warning beeps disabled. Voice memos and sound recorded with movies can still be played back.
On	<p><i>The camera beeps once to confirm that:</i></p> <ul style="list-style-type: none"> • the camera has been turned on • the shutter-release button has been pressed all the way down to release the shutter • manual focus has been activated or a converter-lens option selected in the LENS menu • images have been deleted or the memory card formatted • changes have been made to image status with the Hide Image, Protect, Print Set, or Auto Transfer items in the playback menu • Shutter Sound has been set to On <p><i>The camera beeps twice to warn that:</i></p> <ul style="list-style-type: none"> • the camera is not in focus when the shutter-release button is pressed halfway (only when monitor off) • the memory card is full

Resetting File Numbering to 0001

To reset file numbering to 0001, insert an empty memory card or format the current memory card before selecting **Reset**. Note that formatting the memory card deletes all data it may contain, including hidden and protected images.

Formatting Memory Cards: CF Card Format

The memory card provided with your camera is formatted at shipment. If you purchase additional memory cards for added storage, you will however need to format the cards before first use to ensure that they work properly in your camera. Formatting memory cards is also an effective way of deleting all pictures on the card.

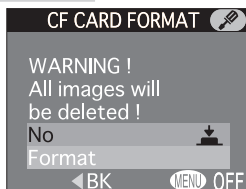

Option	Description
No	Exit without formatting card.
Format	<i>Formatting begins as soon as you press the center of the multi selector to select this option.</i> Formatting can not be interrupted.

During Formatting

Do not remove the memory card, remove the battery, or unplug the AC adapter (available separately) while formatting is in progress.

Before Formatting

Formatting memory cards permanently deletes all data they contain, including protected pictures and any other data that may be on the card. Before formatting, be sure to transfer to a computer any pictures you would like to keep.

Disable Delete

Memory cards can not be formatted when **Disable Delete** ( 131) is on.

Setting the Time and Date: **Date**

This option is used to set the camera to the current date and time. For more information, see “Introduction: First Steps” ( 15).

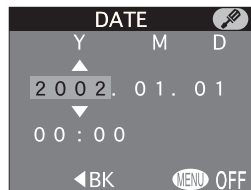

Confirming Shutter Release: **Shot Confirmation**

If **On** is selected for this option, the self-timer lamp will light to confirm that the shutter has been released. The self-timer lamp will not light if the flash has fired.

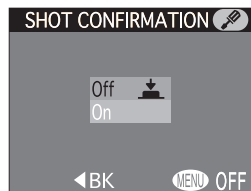

Storing Photo Info in a Separate File: **info.txt**

While **On** is selected in the **info.txt** menu, the following information about each image recorded is stored in an independent text file (“info.txt”):

- File number and type
- Camera type and firmware version
- Metering method
- Exposure mode
- Shutter speed
- Aperture
- Exposure compensation
- Focal length and digital zoom
- Image adjustment
- Sensitivity (ISO equivalency)
- White balance
- Sharpening
- Date of recording
- Image size and quality
- Saturation control
- Focus area



The info.txt file is stored in the same folder as the image. When the contents of the memory card are viewed from a computer, this file can be read with a text browser such as Notepad or SimpleText. Images are listed in the order recorded, separated by a blank line.

Choosing a Video Standard: *Video Mode*

The **Video Mode** menu is used to select the standard used for video output. Adjust this setting to match the standard used in any video device to which you connect the camera ( 40).

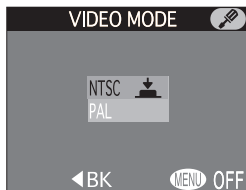

Option	Description
NTSC	Use when connecting camera to NTSC devices.
PAL	Use when connecting camera to PAL devices.

Choosing a Language: *Language*

This option is used to choose the language in which camera menus and messages are displayed. For more information, see “Introduction: First Steps” ( 14).



Protecting Images from Deletion: **Disable Delete**

The **Disable Delete** option is used to protect images from accidental deletion. Select **On** to disable all operations or menu options that delete or erase images, including deletion with the  button, the **Delete** option in the playback menu, and the **CF Card Format** option in the setup menu. When **Off** is selected, images can be deleted and memory cards formatted normally.

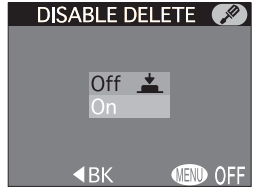

Choosing a USB Option: **USB**

Use this option to select the USB option used when your camera is connected to a computer  34). Your camera supports two options: PTP (Picture Transfer Protocol) and Mass Storage.

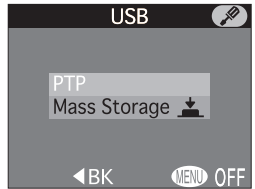

Protocol	Description
<p style="text-align: center;">PTP</p>	<p>Select this option when using PTP to transfer pictures to your computer. PTP is supported only under Windows XP Home Edition, Windows XP Professional, and Mac OS X (version 10.1.2 or later).</p>
<p style="text-align: center;">Mass Storage</p>	<p>If this option is selected, the camera will function as a mass storage device when connected to a computer. The Mass Storage option is supported under Windows XP Home Edition, Windows XP Professional, Windows 2000 Professional, Windows Millennium Edition (Me), Windows 98 Second Edition (SE), Mac OS X (version 10.1.2 or later), and Mac OS 9.0, 9.1, 9.2.</p>

Windows 2000 Professional, Windows Millennium Edition (Me), Windows 98 Second Edition (SE), Mac OS 9

Do *not* select **PTP** when connecting the COOLPIX4500 to a computer running one of the above operating systems (there is no need to change the USB setting when using the camera for the first time, as **Mass Storage** is selected at shipment).

If you have already changed the USB setting to **PTP**, be sure to select **Mass Storage** before connecting the camera to your computer.

If you have connected the camera to a computer running one of the above operating systems with **PTP** selected in the **USB** menu, disconnect the camera as described below. Be sure to select **Mass Storage** in the **USB** menu before reconnecting the camera.

Windows 2000 Professional

A dialog will be displayed welcoming you to the “Found New Hardware Wizard.” Click **Cancel** to close the dialog, and then disconnect the camera.

Windows Millennium Edition (Me)

After displaying a message stating that the hardware information database is being updated, the computer will start the “Add New Hardware Wizard.” Click **Cancel** to exit the wizard, and then disconnect the camera.

Windows 98 Second Edition (SE)

The “Add New Hardware Wizard” will be displayed. Click **Cancel** to exit the wizard, and then disconnect the camera.

Mac OS 9

A dialog will be displayed stating that the computer is unable to use the driver needed for the “Nikon Digital Camera E4500_PTP” USB device. Click **Cancel** to close the dialog, and then disconnect the camera.

The Playback Menu

Managing Pictures

The playback menu contains the following options for managing the pictures on the memory card:



Option	
Delete	133–135
Folders	136–137
Slide Show	138–139
Perspective Control	140–142
640 Small Pic.	142
Protect	143
Hide Image	144
Print Set	145–146
Auto Transfer	147–148

Deleting Pictures: *Delete*

The **Delete** menu contains the following options:

Option	Description
Selected Images	Delete selected photographs and movies.
Erase All Images	Delete all pictures.
Transfer	Reset transfer marking for all pictures.
Print Set	Cancel the current print order.

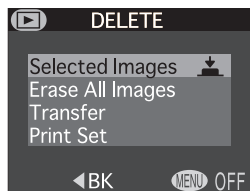

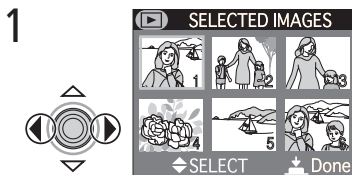

Deleting Selected Pictures: *Selected Images*

Choosing **Selected Images** displays the pictures on the memory card as small thumbnail images. To choose pictures for deletion:

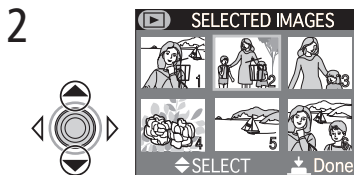

Highlight picture



Press multi selector up or down to select picture for deletion. Selected pictures are marked by  icon and red border. Repeat steps 1 and 2 to select additional pictures. To deselect picture, highlight and press multi selector up or down. To exit without deleting pictures, press MENU button.

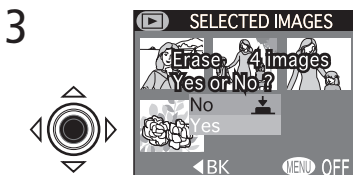

Press center of multi selector to display a confirmation dialog. Press multi selector up or down to highlight option, press center to put choice into effect:

- Select **No** to return to playback menu without deleting pictures
- Select **Yes** to delete all selected pictures



Before Deletion

Once deleted, pictures can not be recovered. Be sure that any pictures you would like to keep have been transferred to your computer.

Deleting All Pictures: *Erase All Images*

Selecting **Erase All Images** from the delete menu displays the confirmation dialog shown at right.



Option	Description
No	Exit without deleting pictures.
Yes	Delete all pictures on memory card. Pictures that are hidden or protected will not be deleted.

Removing Transfer Marking from All Images: *Transfer*

Selecting **Transfer** from the delete menu removes transfer marking from all images. No confirmation dialog is displayed.



Cancelling the Current Print Order: *Print Set*

Selecting **Print Set** from the delete menu cancels the current print order and removes print marking from all images. No confirmation dialog is displayed.

Disable Delete

Pictures can not be deleted when **Disable Delete** ( 131) is on.

Hidden and Protected Pictures

Pictures marked with a  icon are protected and can not be selected for deletion. Pictures hidden with the **Hide Image** ( 144) option are not displayed in the **Delete > Selected Images** menu and can not be deleted.

Print Set

Selecting **Print Set** also removes transfer marking from all images.

Selecting a Folder for Playback: *Folders*

During shooting, pictures are stored in folders created automatically by the camera. The **Folders** menu is used to select folders for playback and to delete folders created at settings of **Panorama Assist** (👁 50) or **Ultra HS** (👁 96).

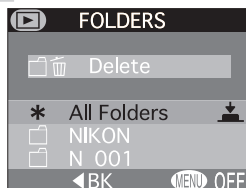

Option	Description
Delete	Select this item to delete folders created at settings of Panorama Assist and Ultra HS .
All Folders	Select this option to display all pictures on the memory card during playback.
NIKON	Pictures taken at settings of Panorama Assist and Ultra HS will not be played back.
(N_ddd)	Each series of pictures taken at a setting of Ultra HS is stored in a separate folder with a name consisting of "N_" followed by a three-digit number assigned automatically by the camera. These folders are listed at the end of the Folders menu. To view only the pictures in a specific series, select the appropriate folder from the list.
(P_ddd)	Each series of pictures taken at a setting of Panorama Assist is stored in a separate folder with a name consisting of "P_" followed by a three-digit number assigned automatically by the camera. These folders are listed at the end of the Folders menu. To view only the pictures in a specific series, select the appropriate folder from the list.

Deleting Folders: *Delete*

Select **Delete** to delete folders created at settings of **Panorama Assist** and **Ultra HS**. Folders with the name NIKON can not be deleted.

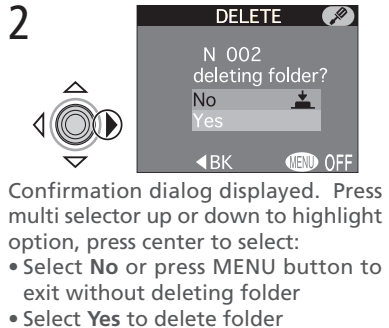
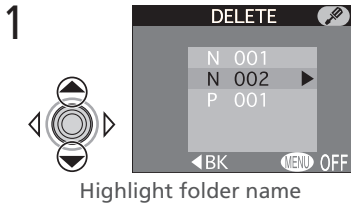

Hidden and Protected Images

If the selected folder contains hidden or protected images, the folder will not be deleted. Any images it contains that are neither hidden nor protected will, however, be deleted.



Disable Delete

Folders can not be deleted when **Disable Delete** ( 131) is on.

Automated Playback: Slide Show

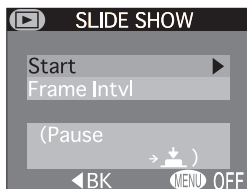
The slide-show option in the playback menu is used for automated sequential playback. To start a slide show, highlight **Start** and press the multi selector to the right. All pictures in the current folder that have not been hidden using **Hide Image** will be played back one after the other in the order recorded, with a pause between each picture. Movies will be displayed as still images showing the movie's first frame. While the slide show is in progress, the following operations can be performed:

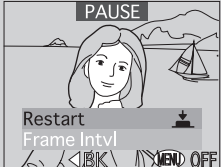

To	Press	Description
Pause slide show		Press center of multi selector to pause slide show and display dialog shown at right. To restart slide show, select Restart . To end slide show and return to playback menu, press multi selector to the left. Press MENU button to end slide show and return to full-screen playback. <div data-bbox="695 543 946 729" style="border: 1px solid black; padding: 5px; margin-top: 10px;"> <p style="text-align: center; background-color: #333; color: white; padding: 2px;">PAUSE</p>  </div>
Go forward or back one frame		Press the multi selector up or left to go back one frame, down or right to skip to the next frame.
End slide show	MENU	Press the MENU button to end the slide show and return to full-screen playback.

Once all pictures have been shown, the slide show will pause with the first picture in the folder displayed.

Small Picture

Copies created using the small picture option ( 75) will not be played back during a slide show.

Changing the Display Interval

The slide show menu and pause dialog both contain a **Frame Intvl** option for changing the length of time each picture in the slide show is displayed. To change the display interval, highlight **Frame Intvl** and press the multi selector to the right. The menu of interval settings shown at right will be displayed; highlight the desired setting and press the center of the multi selector.

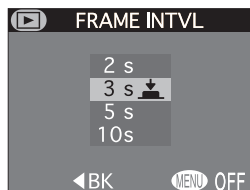

Frame Interval

Owing to differences in the file size of the pictures in the slide show and the speed at which they can be read from the memory card, the actual interval may differ from the value shown in the menu.

Auto Off

If no operation is performed for more than half an hour during a slide show, the camera will turn off automatically to save power, and the power-on lamp will go out.

Changing Vertical Perspective: *Perspective Control*

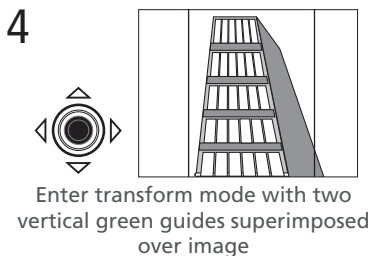
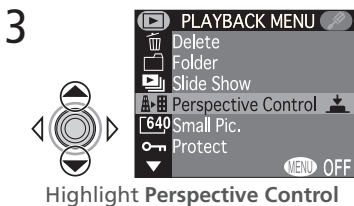
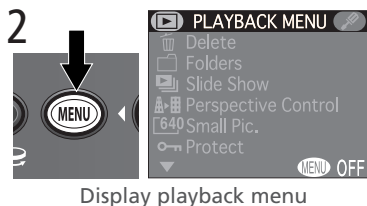
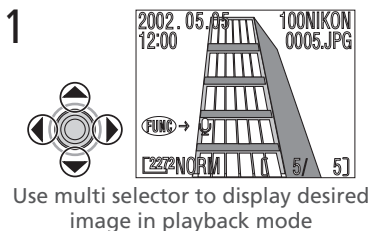
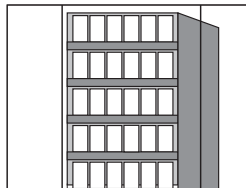

This option can be used to transform a photograph to change the apparent vertical perspective, making pictures taken from a high or low angle look as though they had been taken from eye level. The transformed image is saved separately from the original.

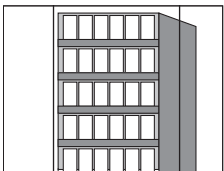

Restrictions on Perspective Control

Perspective control can not be performed on pictures taken at **Continuous** settings of **Ultra HS** or **Movie**, pictures taken at an image quality of **HI**, or copies created with the small picture or **Perspective Control** options. The COOLPIX4500 may not be able to transform images taken with another make of camera.

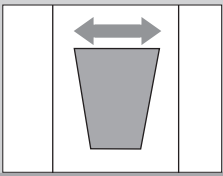
- 5   Transform image as described below, Guides offer visual confirmation of apparent change in perspective.

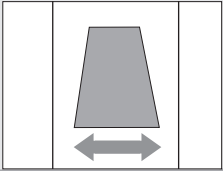
To	Press	Description
Stretch top of image		Press multi selector up to stretch top of image horizontally, reducing distortion in pictures taken from a low angle. 
Stretch bottom of image		Press multi selector down to stretch bottom of image horizontally, reducing distortion in pictures taken from a high angle. 

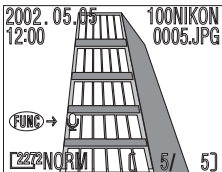
- 6  

Save transformed image and return to playback mode with original image displayed. Note that about forty seconds may be required for creation of transformed image.

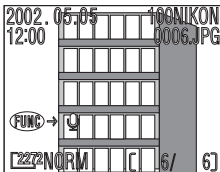
- 7  

To view transformed image, press multi selector down. Transformed image will have same image size, quality, and time and date of creation as original.

Once created, transformed images are independent of the original: deleting the transformed image has no effect on the original, deleting the original has no effect on the transformed image. Transformed images are stored on the memory card as independent files with names of the form "TSCNnnnn," where "nnnn" is a four-digit number assigned automatically by the camera. The print and protect attributes of the original will not be reflected in the transformed image and must be set separately.

Choosing a Size for Small Pictures: *Small Pic.*

This option controls the size of pictures created with the small picture option (P. 75). Choose from 640 × 480, 320 × 240, 160 × 120, and 96 × 72.

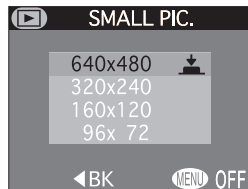



Perspective Control

Stretching the image produces a slightly "grainy," uneven appearance, an effect which increases the more the image is stretched.

The transformed image is the same size as the original. Any portions of the image that do not fit in the original dimensions will be cropped.

Safeguarding Valuable Pictures: *Protect*

Selecting **Protect** from the playback menu displays the menu shown at right, where you can select pictures to protect from accidental deletion. Protected files can not be deleted using the  () button or the options in the **Delete** menu. Note, however, that protected pictures *will* be deleted when a memory card is formatted.

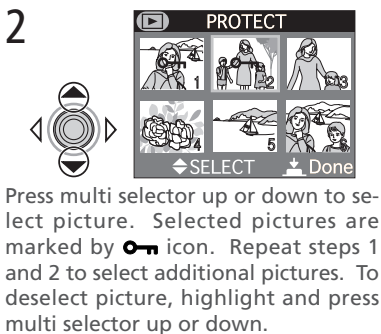
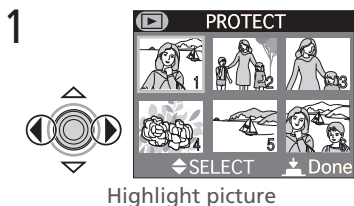
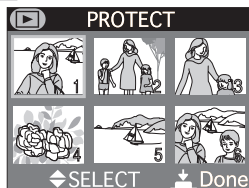

Hiding Pictures During Playback: *Hide Image*

When creating a slide show or showing photographs to an audience, you may want to use the **Hide Image** option to hide some of the pictures in the current folder. Hidden pictures are only visible in the **Hide Image** menu. They can not be deleted using the  button or the options in the **Delete** menu.

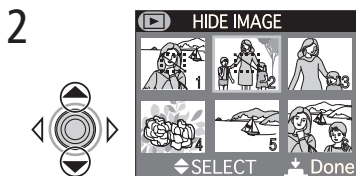
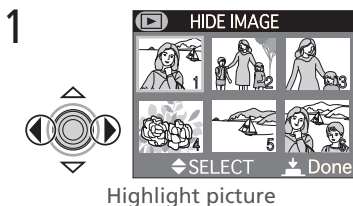
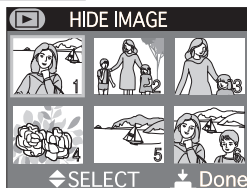

Press multi selector up or down to select picture. Selected pictures are marked by  icon. Repeat steps 1 and 2 to select additional pictures. To deselect picture, highlight and press multi selector up or down.



Press center of multi selector to complete operation. To exit without changing hidden status of pictures, press MENU button.

"All images are hidden"

If all the pictures in the folder currently selected for playback are hidden, the message "All images are hidden" will be displayed in full-screen playback. No pictures can be played back until another folder has been selected or **Hide Image** is used to reveal some of the pictures in the current folder.

Ordering Prints: *Print Set*

Selecting **Print Set** from the playback menu displays the menu shown at right. Here you can specify photographs to be printed, the number of prints, and the information to be included on each print. This information is stored on the memory card in Digital Print Order Format (DPOF). Once a print order has been created, the memory card can be removed from the camera and inserted in any DPOF-compatible device—be it your personal photo printer or a photofinisher's print system—and images printed directly from the card.

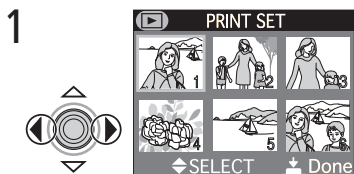
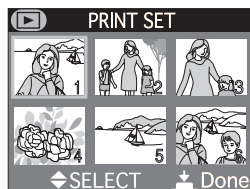

Highlight picture

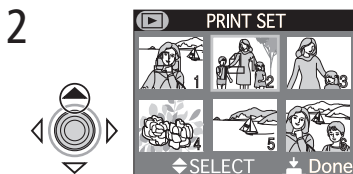

Press multi selector up to select picture. Selected pictures are marked by icon.

Cancelling the Print Order

To cancel the current print order when it is no longer needed, select **Print Set** from the **Delete** sub-menu (133). Note that this will also remove transfer marking from all images.

3

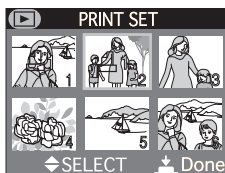

Use multi selector to specify number of prints. Press up to increase (maximum 9), down to decrease. To deselect image, press multi selector down when number of prints is 1. Repeat steps 1–3 to select additional images. To exit without altering print order, press MENU button.

4

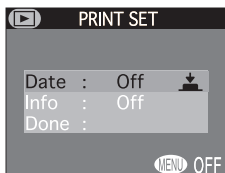

Press center of multi selector to complete operation and display menu of print options. To highlight option, press multi selector up or down.

- To print date of recording on all selected pictures, highlight **Date** and press center of multi selector. **On** will appear next to item.
- To print shutter speed and aperture on all selected pictures, highlight **Info** and press center of multi selector. **On** will appear next to item.
- To turn selected item off, highlight and press center of multi selector.
- To complete print order and return to playback, highlight **Done** and center of multi selector. To exit without altering print order, press MENU button.

Selecting Images for Transfer: *Auto Transfer*

When transferring images to a computer using Nikon View 5, you can choose to transfer only pictures that have been selected for transfer using the **Auto Transfer** option (📷 36).

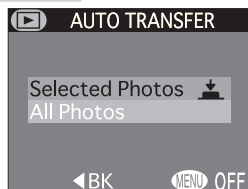

Option	Description
Selected Photos	Select pictures for transfer from a list of thumbnails.
All Photos	Select all pictures for transfer.

Selecting Pictures for Transfer: *Selected Photos*

Choosing **Selected Photos** displays the pictures on the memory card as small thumbnail images. To choose the pictures for transfer to a computer:

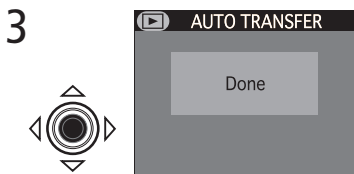
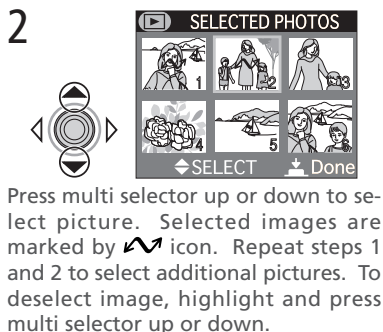
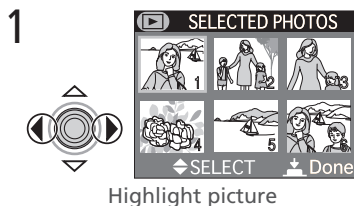

Selecting All Pictures for Transfer: *All Photos*

Selecting **All Photos** displays the confirmation dialog shown at right.



Option	Description
No	Exit without changing transfer status of pictures.
Yes	Select all pictures on the memory card for transfer to a computer.

Marking All Images for Transfer

While the **All Photos** option can be used to select all pictures on the memory card for transfer to a computer, note that no more than 999 pictures can be marked for transfer ( 147). If the memory card contains more pictures, Nikon View 5 can be used to transfer all pictures on the memory card. See the *Nikon View 5 Reference Manual* (on CD) for details.

Marking Pictures for Transfer with Other Cameras

Pictures selected for transfer with another model of Nikon digital camera can not be transferred when the memory card is inserted in the COOLPIX4500. Use the COOLPIX4500 to reselect the images.

Removing Transfer Marking from All Images

To remove transfer marking from all pictures on the memory card, select **Transfer** from the **Delete** menu ( 133).

Technical Notes

Camera Care, Options, and Resources

This chapter provides a list of optional accessories available for the COOLPIX4500, tips on cleaning and storing your camera, information on where to get help on line, troubleshooting advice, and camera specifications.

Optional Accessories

At the time of writing, the following options were available for the COOLPIX 4500. Contact your retailer or local Nikon representative for details.

Rechargeable battery EN-EL1 Li-ion batteries

**AC adapters/
battery chargers**

- EH-21 AC adapter/battery charger
- EH-53 AC adapter
- MH-53 battery charger
- MH-53C battery charger (plugs into vehicle cigarette-lighter socket)

Carrying case CS-CP10 soft case

**CompactFlash™ memory
card adapters**

EC-AD1 PC-card adapter

Lens adapter ring

UR-E7 lens adapter ring for WC-E68

**Converter lenses
and lens adapters**

- FC-E8 fisheye converter (0.21 ×)
- WC-E63 wide-angle converter (0.63 ×)
- WC-E68 wide-angle converter (0.68 ×)
(requires UR-E7 lens adapter ring)
- TC-E2 telephoto converter (2 ×)
- TC-E3ED telephoto converter (3 ×)
- ES-E28 slide copy adapter

Monitor hood

HL-CP10 LCD hood

**Flash brackets and adapters
(required for optional
Speedlights)**

- SK-E900 multi-flash bracket unit
- AS-E900 multi-flash adapter

Macro light

MACRO COOL-LIGHT SL-1

Approved Memory Cards

In addition to the memory card included with your camera and the Nikon EC-CF series of memory cards, the following memory cards have been tested and approved for use in the COOLPIX4500:

<i>SanDisk</i>	SDCFB series	16 MB, 32 MB, 48 MB, 64 MB, 96 MB, 128 MB
<i>Lexar Media</i>	4× USB series	8 MB, 16 MB, 32 MB, 48 MB, 64 MB, 80 MB
	8× USB series	8 MB, 16 MB, 32 MB, 48 MB, 64 MB, 80 MB
	10× USB series	128 MB, 160 MB
<i>IBM</i>	Microdrive	DSCM-10512 (512 MB), DSCM-11000 (1 GB)

Operation is not guaranteed with other makes of memory card. For more details on the above cards, please contact the manufacturer.

Caring for the Camera and Battery

To ensure continued enjoyment of your Nikon product, observe the following precautions when using or storing the device:

✓ **Keep dry**

This product is not waterproof, and may malfunction if immersed in water or exposed to high levels of humidity. Rusting of the internal mechanism can cause irreparable damage.

✓ **Do not drop**

The product may malfunction if subjected to strong shocks or vibration.

✓ **Handle all moving parts with care**

Do not apply force to the lens, to the monitor, or to the battery, card, or connector covers. These parts are especially susceptible to damage.

✓ **Avoid sudden changes in temperature**

Sudden changes in temperature, such as occur when entering or leaving a heated building on a cold day, can cause condensation inside the device. To prevent condensation, place the device in a carrying case or a plastic bag before exposing it to sudden changes in temperature.

✓ **Turn the product off before removing or disconnecting the power source**

Do not unplug the product or remove the battery while the product is on, or while images are being recorded or deleted. Forcibly cutting power to the product in these circumstances could result in loss of data or in damage to product memory or internal circuitry. To prevent an accidental interruption of power, avoid carrying the product from one location to another while the AC adapter is connected.

✓ **Keep away from strong magnetic fields**

Do not use or store this device in the vicinity of equipment that generates strong electromagnetic radiation or magnetic fields. Strong static charges or the magnetic fields produced by equipment such as radio transmitters could interfere with the monitor, damage data stored on the memory card, or affect the product's internal circuitry.

Storage

When the camera will not be used for an extended period, return the lens section to its original position and remove the battery and store it in a cool, dry place. To prevent mold or mildew, store the camera in a dry, well-ventilated area. For long-term storage, place the camera in a plastic bag containing a desiccant (note that desiccant gradually loses its capacity to absorb moisture and should be replaced at regular intervals). Do not store your camera with naphtha or camphor moth balls or in locations that:

- are poorly ventilated or damp
- are next to equipment that produces strong electromagnetic fields, such as televisions or radios
- are exposed to temperatures above 50 °C/122 °F (for example, near a space heater or in a closed vehicle on a hot day) or below -10 °C (14 °F)
- are subject to humidities of over 60%

To prevent mold or mildew, take the camera out of storage at least once a month. Turn the camera on and release the shutter a few times before putting the camera away again.



Tips and Tricks for Handling Batteries

Some tips to ensure that your camera is always ready to shoot:

- When you turn the camera on, check the battery-level displayed in the monitor to determine whether the battery needs to be replaced. A warning will be displayed when the battery needs to be replaced.
- Ready a spare battery and keep it fully charged when taking photographs on important occasions. Depending on your location, you may find it difficult to purchase replacement batteries on short notice.
- On cold days, the capacity of batteries tends to decrease. Be sure the battery is fully charged before taking photographs outside in cold weather. Keep a spare battery in a warm place and exchange the two as necessary. Once warmed, a cold battery may recover some of its charge.
- Should the battery terminals become dirty, wipe them off with a clean, dry cloth before use.

Cleaning

Lens

One key to cleaning the lens is to not touch it with your fingers. Use a *blower* (typically a small device with a rubber bulb attached to one end that you pump to produce a stream of air out the other) to remove dust or lint. To remove fingerprints or other stains that can not be removed with a blower, wipe the lens with a soft cloth, using a spiral motion that starts in the center of the lens and works out to the edges.

Monitor

Do not apply pressure to the monitor, as this could cause damage or malfunction. Dust or lint adhering to the monitor can be removed with a blower brush. Stains can be removed by rubbing the surface lightly with a soft cloth or chamois leather.

Body

Use a blower to remove dust and lint, then wipe gently with a soft, dry cloth. After using the camera at the beach or seaside, wipe off any sand or salt with a cloth lightly dampened with fresh water, then dry thoroughly.

Do not use alcohol, thinner, or other volatile chemicals.

Avoid Contact with Liquid Crystal

Should the monitor break, care should be taken to avoid injury due to broken glass and to prevent the liquid crystal from the monitor touching the skin or entering the eyes or mouth.

Notes on the Monitor

The monitor may contain a few pixels that are always lit or that do not light. This is a characteristic common to all TFT LCD monitors and does not indicate a malfunction. Images recorded with the product will not be affected.

When you frame bright subjects, vertical comet-like streaks that whiten toward either end may appear in the monitor. This phenomenon, known as “smear,” does not appear in the final photograph and does not indicate a malfunction. Some smearing may appear in movies.

Web Resources

At the time of writing, the following on-line resources were available for users of Nikon digital imaging equipment:

For Product Information and Tips









- For users in the USA: <http://www.nikonusa.com/>
- For users in Europe: <http://www.nikon-euro.com/>
- For users in Asia, Oceania, the Middle East, and Africa:
<http://www.nikon-asia.com/>







For Contact Information

Contact information for the Nikon representative in your area may be found at:
<http://www.nikon-image.com/eng/>

Troubleshooting

If your camera fails to function as expected, check the list of common problems below before consulting your retailer or Nikon representative. Refer to the page numbers listed in the rightmost column for information on solving the problems listed here.











Problem	Possible cause	
Monitor is blank	• Power-on lamp is not lit: camera is off () 18), camera has powered off automatically () 124), battery is not inserted or battery-chamber cover is not closed () 10), battery is exhausted () 19), or AC adapter (available separately) is not properly connected () 11).	
	• Monitor is off. Press  button.	23
	• Camera is connected to television or VCR.	40
	• USB cable is connected	36
	• Optional MC-EU1 remote cord is connected and data are being transferred	150
Camera turns off immediately	<ul style="list-style-type: none"> • Battery is low. • Battery is cold. 	19 152
No indicators appear in monitor	<ul style="list-style-type: none"> • Indicators are hidden. Press  button until indicators are displayed. • Slide show is in progress. 	23 122



Problem	Possible cause	
Monitor is hard to read	<ul style="list-style-type: none"> • Ambient lighting is too bright: use viewfinder or move to a darker location or use optional HL-CP10 LCD hood. • Monitor is dirty. • Display options require adjustment. 	150 154 123
Can not change lens angle	<ul style="list-style-type: none"> • Lens rotation is limited by swivel limit switch. 	21
No photo is taken when shutter-release button is fully pressed	<ul style="list-style-type: none"> • Battery is exhausted. • Message "Out of memory" displayed: not enough memory remaining. • Flash-ready lamp flickers: flash is charging. • Message "Card is not formatted" displayed: memory card is not formatted for use in COOLPIX4500. • Message "No card present" displayed: no memory card in camera. 	19 19 24 158 13
Picture is in monitor is upside down	Lens section rotated to point in same direction as monitor at setting of Ultra HS , Movie , Panorama Assist , or Multiple Exposure (image will also be inverted during playback).	49, 68
Can not adjust zoom	<ul style="list-style-type: none"> • Fisheye1 or Fisheye2 is selected for Lens option in shooting menu. 	106
Photos are too dark (underexposed)	<ul style="list-style-type: none"> • Flash is off. • Flash window is blocked. • Subject is outside range of flash. • Exposure compensation is too low. 	64 21 162 69
Photos are too bright (overexposed)	<ul style="list-style-type: none"> • Exposure compensation is too high. 	69
Photos are out of focus	<ul style="list-style-type: none"> • Subject was not in focus area when shutter-release button was pressed halfway. • Autofocus lamp flickers: camera unable to focus. • Manual focus distance does not match distance to subject. 	110 24 161
Photos are blurred	Camera shook during shot: increase shutter speed. If shutter speed can not be increased without underexposure, use the flash ( 61), raise sensitivity (ISO equivalency;  70), or select a larger aperture ( 54). To minimize blur at low shutter speeds, use the Best-Shot Selector (BSS;  98), use the self-timer ( 58), or use a tripod.	53

Problem	Possible cause	
Randomly-spaced bright pixels ("noise") appear in image	<ul style="list-style-type: none"> • Sensitivity raised above 100. • Shutter speed too slow. If making a long time-exposure of $\frac{1}{4}$ s or longer, turn noise reduction on. To increase shutter speed, use the flash. 	70 118
Flash does not fire	<ul style="list-style-type: none"> • Built-in Speedlight is stowed. • Flash is off. Note that built-in Speedlight turns off automatically when: Landscape, Night Landscape, Museum, Fireworks Show, or Panorama Assist is selected in scene mode (44); focus is set to (infinity; 57); a setting other than Single is selected for Continuous (96); the Best-Shot Selector (BSS) is on (98); a setting other than Normal is selected for Lens (106); AE Lock is on (108); or Speedlight Cntrl is set to Internal Off (115). • Battery level is low. 	21 19
Colors are unnatural	<ul style="list-style-type: none"> • White balance does not match light source. • Saturation control is too low or too high. 	92 100
Image can not be played back	<ul style="list-style-type: none"> • Image has been overwritten or renamed by a computer or other make of camera. 	—
Cannot zoom in	<ul style="list-style-type: none"> • Picture is a movie, small picture, or was created at Ultra HS. 	74
Can not create small picture	<ul style="list-style-type: none"> • Camera is in quick review • Picture recorded at image quality of HI • Picture recorded at Continuous setting of Ultra HS or Movie • Picture is a small picture 	29 102 96 75
Perspective Control option is not available	<ul style="list-style-type: none"> • Attempt to perform perspective control on picture created using Perspective Control 	140
TV does not mirror image in monitor	<ul style="list-style-type: none"> • Video cable not correctly connected. • Television not tuned to video channel. • Video Mode setting does not match video device. 	40 40 130
Nikon View 5 does not start when camera connected or memory card inserted	<ul style="list-style-type: none"> • Camera is off, AC adapter (available separately) is not properly connected, or battery is dead. • Interface cable not correctly connected, or card not properly inserted in card reader, card adapter, or card slot. • PTP selected for USB option in setup menu (Windows 2000 Professional, Windows Me, Windows 98SE, Mac OS 9) See <i>Nikon View 5 Reference Manual</i> for more information. 	— 34 35 132

Error Messages

The following table lists the error messages and other warnings that appear in the monitor and how to deal with them.

Display	Problem	Solution	
 (Flashes)	Clock calendar not set.	Set clock calendar to current date and time.	15
Warning !! Battery exhausted	Battery exhausted.	Turn camera off and replace battery.	19
Speedlight is in the closed position	Built-in Speedlight obstructed by finger or other object.	Remove obstruction from Speedlight and press shutter-release button halfway.	21
 WARNING !! Please wait for camera to finish recording	Camera turned off or  button pressed while pictures are being saved.	Message clears from display automatically when recording is complete.	—
 No card present	Camera can not detect memory card.	Turn camera off and confirm that memory card is correctly inserted.	12
 This card cannot be used	Error accessing memory card.	<ul style="list-style-type: none"> • Use approved card. • Check that connectors are clean. If card is damaged, contact retailer or Nikon representative. 	12
 WARNING !! This CF card cannot be read			—
 Card is not formatted Format No 	Memory card has not been formatted for use in COOLPIX4500.	Press multi selector up to highlight Format and press to right to format card, or turn camera off and replace card.	128
 Out of memory	<ul style="list-style-type: none"> • Insufficient memory to record pictures at current settings • Insufficient memory to record changes to print order or transfer marking 	<ul style="list-style-type: none"> • Reduce quality or size. • Delete photographs. • Insert new memory card. • Cancel print order or remove transfer marking 	101 133 12 145 147

Display	Problem	Solution	
 Image cannot be saved	<ul style="list-style-type: none"> • Error encountered while saving photo. • Memory card not formatted for use in camera. • Camera has run out of folder or file numbers 	<ul style="list-style-type: none"> • Reformat memory card or insert new memory card. • Insert new memory card or delete pictures. 	128 19, 29
Card contains no images	Card contains no images.	Press shutter-release button or  button once to return to shooting mode.	18
All images are hidden	All images in current folder are hidden.	<ul style="list-style-type: none"> • Select another folder • Change hidden status of images 	136 144
File contains no image data	File created by computer or different make of camera.	Delete file or reformat memory card.	133 128
Cannot delete file	<ul style="list-style-type: none"> • Attempt to delete protected picture. • Attempt to delete picture created by computer or another make of camera. 	<ul style="list-style-type: none"> • Remove protection from picture • Format memory card 	143 128
The folder cannot be deleted	Folder contains pictures that are protected, hidden, or not created with COOLPIX4500.	Folder can only be deleted if all pictures in folder are neither hidden nor protected.	143 144
System error	Error has occurred in camera's internal circuitry.	Turn camera off, unplug optional AC adapter (if using) or remove and re-insert battery, and turn camera on. If error persists, contact retailer or Nikon representative.	18

 **A Note on Electronically-Controlled Cameras**

In extremely rare instances, unusual characters may appear in the monitor and the camera may stop functioning. In most cases, this phenomenon is caused by a strong external static charge. Turn the camera off, remove and replace the battery, and turn the camera on again, or, if you are using an AC adapter (available separately), disconnect and reconnect the adapter and turn the camera on again. In the event of continued malfunction, contact your retailer or Nikon representative. Note that disconnecting the power source as described above may result in loss of any data not recorded to the memory card at the time the problem occurred. Data already recorded to the memory card will not be affected.

Specifications

Type	E4500 digital camera
Effective pixels	4.0 million
CCD	$\frac{1}{1.8}$ " high-density CCD; total pixels: 4.13 million
Image size (pixels)	<ul style="list-style-type: none"> • 2272 × 1704 • 1600 × 1200 • 1280 × 960 • 1024 × 768 • 640 × 480 • 2560 × 1520 (3 : 2)
Lens	4 × Zoom Nikkor
Focal length	F = 7.85 – 32 mm (35-mm [135] camera format equivalent: 38 – 155 mm)
f/-number	f/2.6 – f/5.1
Construction	Ten elements in eight groups
Digital zoom	4.0 ×
Autofocus (AF)	Contrast-detect through-the-lens (TTL) AF
Focus range (measured from lens)	30 cm/1'1" – ∞ (50 cm/1'8" at widest zoom position); approximately 2 cm/0.8" (middle zoom position) – ∞ in macro and manual focus modes
Focus-area selection	Five-area multi AF and spot AF available
Viewfinder	Real-image zoom viewfinder with LED indication
Magnification	0.34 – 1.27 ×
Frame coverage	Approximately 80%
Diopter adjustment	–2 – +2 m ⁻¹
Monitor	1.5", 110,000-dot, low temperature polysilicon TFT LCD with brightness adjustment
Frame coverage	Approximately 97% vertical and 97% horizontal

Storage	
Media	Type I and II CompactFlash™ (CF) cards and Microdrives
File system	Compliant with Design rule for Camera File systems (DCF), Exif 2.2, and Digital Print Order Format (DPOF)
File formats	Compressed: JPEG-baseline-compliant (FINE-, NORMAL-, and BASIC-quality images) Uncompressed: TIFF-RGB (HI-quality images) Movies: QuickTime
Exposure	
Metering	Four mode through-the-lens (TTL) metering: <ul style="list-style-type: none"> • 256-segment matrix • Spot • Center-weighted • AF spot
Exposure control	Programmed auto with flexible program, shutter-priority auto, aperture-priority auto, manual, exposure compensation (-2.0 – +2.0 EV in steps of $\frac{1}{3}$ EV), autoexposure bracketing
Range (ISO 100 equivalent)	W: -2.2 – +17.0 EV T: -0.3 – +18.1 EV
Shutter	Mechanical and charge-coupled electronic shutter
Speed	$1 - \frac{1}{2300}$ s (programmed auto, scene); $8 - \frac{1}{2000}$ s (shutter-priority auto); $8 - \frac{1}{2300}$ s (aperture-priority auto); Bulb (up to 5 min.) and $8 - \frac{1}{2000}$ s (manual exposure mode)
Aperture	Seven-blade iris diaphragm
Range	Ten settings in steps of $\frac{1}{3}$ EV
Sensitivity	ISO equivalent approximately 100, 200, 400, 800, or Auto
Self-timer	Ten- or three-second duration
Built-in Speedlight	Equipped with automatic pop-up
Range	W: 0.5 – 1.6 m (1'8" – 5'3") T: 0.5 – 3 m (1'8" – 9'10")
Sync method	Automatic sync control

Sync terminal	Connects to SK-E900 multi-flash bracket unit
Compatible Speedlights	Nikon SB-series 80DX, 30, 28DX, 28, 26, 25, 24, 22, and 22s
Interface	USB
Video output	User can choose from NTSC and PAL
I/O terminals	<ul style="list-style-type: none"> • DC input • Audio/video (A/V) output • Data output (USB)
Power sources	<ul style="list-style-type: none"> • Rechargeable Nikon EN-EL1 lithium-ion battery (supplied) or six-volt 2CR5 (DL245) lithium battery (available separately) • EH-21 AC adapter/battery charger (available separately) • EH-53 AC adapter (available separately)
Battery life (EN-EL1)	Approximately 100 minutes (as measured at room temperature [20 °C/68 °F] under standard Nikon test conditions: monitor on, zoom adjusted with each shot, flash used in approximately one third of photographs, image quality set to NORMAL, image size 2272 × 1704)
Tripod socket	1/4" (ISO 1222)
Dimensions (W × H × D)	130 × 73 × 50 mm (5.1" × 2.9" × 2.0")
Weight	Approximately 360 g (12.8 oz) without battery and memory card
Operating Environment	
Temperature	0 – 40 °C (32 – 104 °F)
Humidity	Less than 85% (no condensation)

System requirements (Nikon View 5): Windows

OS	Pre-installed versions of Windows XP Home Edition, Windows XP Professional, Windows 2000 Professional, Windows Millennium Edition (Me), Windows 98 Second Edition (SE)
Models	Only models with built-in USB ports supported
CPU	300 MHz Pentium or better
RAM	64 MB or more recommended
Hard-disk space	25 MB required for installation, with additional free disk space of 10 MB plus double the capacity of camera memory card available on system disk when Nikon View 5 is running.
Video resolution	800 × 600 or better with High Color (True Color recommended)
Miscellaneous	CD-ROM drive required for installation

System requirements (Nikon View 5): Macintosh

OS	Mac OS 9.0, Mac OS 9.1, Mac OS 9.2, Mac OS X (10.1.2 or later)
Models	iMac, iMac DV, Power Mac G3 (Blue & White), Power Mac G4 or later, iBook, PowerBook G3 or later; only models with built-in USB ports supported
RAM	64 MB or more recommended
Hard-disk space	25 MB required for installation, with additional free disk space of 10 MB plus double the capacity of camera memory card available on start-up disk when Nikon View 5 is running.
Video resolution	800 × 600 or better with thousands of colors (millions of colors recommended)
Miscellaneous	CD-ROM drive required for installation

Symbols

- 104
- 100, 200, 400, 800, 70**
- (delete) button, 29,30,71,78
- (exposure compensation) button, 69
- (flash mode) button, 65
- (focus mode) button, 57
- (monitor) button, 23
- (playback) button, 27
- button, 30
- button, 62
- 18
- 16
- 57
- 64
- 69
- 44-48
- 92
- 95
- 96
- 99
- 100
- 105
- 106
- 78
- 145
- 143
- 147
- 144
- A**
- A. See exposure mode, aperture-priority auto
- Accessories. See optional accessories
- AE. See autoexposure
- AE-L. See **AE Lock**
- AE-L, AF-L**, 60,124
- AE Lock**, 60,108

- AF. See autofocus
- AF Area Mode**, 110
- Aperture, 54. See also exposure mode
- Audio. See movies; voice memo
- Audio/Visual. See television playback
- . See shooting mode, auto
- AUTO. See flash mode; sensitivity
- Auto Bracketing**, 116-117
- Autoexposure bracketing, 117
- lock, 108. See also **AE Lock**
- Autofocus, 111
 - continuous, 111
 - single, 111
- Autofocus lamp. See lamp, green
- Auto-Focus Mode**, 111
- Auto Off**, 125
- Auto Transfer**, 147-148
- A/V OUT. See television playback
- B**
- Backlight**, 48
- BASIC, 102
- Battery, 10-11
 - storing, 153
- Beach/Snow**, 46
- Best Shot Selector**, 98
- BKT. See **Auto Bracketing**
- Black-and-white, 100
- Brightness**, 99,121
- Brightness
 - of monitor. See **Brightness** of photographs. See **Image Adjustment**
- BSS. See **Best Shot Selector**
- BULB. See long time-exposure
- C**
- Camera strap, 9
- CF card. See memory card
- CF Card Format**, 128
- Clock-calendar, 15

- Close ups. See **Close Up**; focus mode, macro close-up
- Color
 - in photographs. See **Saturation Control**; white balance
- Command dial, 4
- CompactFlash™ card. See memory card
- Compression. See image quality
- Computer. See Nikon View 5; transfer
- Continuous**, 96-97
- Contrast. See **Image Adjustment**
- Controls**, 123
- Copy**, 48
- Copying images. See transfer
- D**
- Date**, 15-16
- Dawn/Dusk**, 49
- DCF, 160
- Delete**, 133-135
- Deleting images
 - from playback menu, 133-135
 - in full-frame playback, 29
 - in quick review, 29
- Design rule for Camera File systems. See DCF
- Digital Print Order Format. See DPOF
- Digital Tele**, 112
- Diopter adjustment, 8
- Disable Delete**, 131
- Display Mode**, 122
- DPOF, 145
- E**
- Error messages, 158-159
- Exp. +/-**, 109
- Exposure compensation, 69,109
- Exposure count display, 53

Exposure information. *See* photo information

Exposure metering. *See* **Metering**

Exposure mode, 42-56
 aperture-priority auto, 54
 manual, 55-56
 programmed auto, 52
 flexible program, 52
 shutter-priority auto, 53

Exposure Options, 109

F

Files. *See* image files

FINE, 102

Fireworks Show, 47

Fixed Aperture, 113

Flash, built-in, 21,65

Flash, optional, 150

Flash mode, 64-71

Flash-ready lamp. *See* lamp, red

Flexible program. *See* exposure mode, programmed auto

Focus. *See* autofocus; focus area; focus lock; focus mode; manual focus

Focus area, 111

Focus Confirmation, 111

Focus information. *See* **Focus Confirmation**; photo information

Focus lock, 60. *See also* **AE-L/AF-L**

Focus mode, 57-61
 autofocus. *See* autofocus
 infinity, 57. *See also* manual focus
 macro close-up, 57. *See also* manual focus
 manual. *See* manual focus

Focus Options, 110

Folders, 136-137

Folders, 137

Panorama Assist, 49

Ultra HS, 96

Formatting. *See* memory card

FUNC, 123

FUNC button, 8

H

HI, 102

Hide Image, 144

Highlights. *See* photo information

Histogram. *See* photo information

I

Image Adjustment, 99

Image files, 79

file name and type, 79

Image Quality, 102

Image Sharpening, 105

Image size, 103

and print size, 103

Image Size, 103

Infinity. *See* focus mode; manual focus

info.txt, 129

Information. *See* photo information

ISO. *See* sensitivity

J

JPG. *See* image files

JPEG. *See* image quality

L

Lamp, green, 7,24

Lamp, red, 7,24

Landscape, 46

Language, 14,130

Lens, 9,154

Lens cap, 9

Lens, converter, 106-107

Long time-exposure, 56

M

M. *See* exposure mode, manual

Macro close-up. *See* focus mode

Manual focus, 61

Memory card, 12-13

approved cards, 151

capacity of, 19

formatting, 128

insertion and removal of, 12-13

reading images from, 27

MENU button, 44,88

Menus, 81-148

Metering, 95

MF button, 5,61

Microdrive®. *See* memory card

Microphone, built-in,4,78

MODE button, 4,43

Monitor, 5,6-7

brightness, 122

indicators, 6-7

framing photographs in, 22

turning on and off, 23

Monitor Options, 122

Monochrome. *See* black-and-white; sepia

MOV. *See* image files; movies

Movies, 68,77

playing back, 77

recording, 68

Multiple Exposure, 48

Multi selector, 5,8

Museum, 47

N

Night Landscape, 46

Night Portrait, 46

Nikon View 5, 32-39

system requirements for, 164

Noise, 49

Noise Reduction, 118

NORMAL, 101-102

NR. *See* NOISE REDUCTION

NTSC. *See* **Video Mode**

O

On/off. See **Auto Off**; power switch
 Optional accessories, 150

P

P. See exposure mode, programmed auto.
 PAL, 40, 130. See also **Video Mode**

Panorama Assist, 49

Panoramas 50-51

Party/Indoor, 46**Perspective Control**, 140-142

Photocell, 5

Photo information, 79, 129. See also **info.txt**

Playback, 73-79. See also quick review

movie, 77

thumbnail, 30

zoom, 74

PLAYBACK menu, 133-148

Portrait, 45

power-on lamp, 18, 26

Power switch, 4

Print Set, 145-146

Programmed auto exposure. See exposure mode

Protect, 143**Q**

Quality. See image quality

Quick review, 28

QuickTime. See movies

QVGA. See **Continuous**

R

Red-eye reduction. See flash mode

Reset All, 119-120**S**

S. See exposure mode, shutter-priority auto

Saturation Control, 100

Self-portrait. See monitor; self-timer

Self-timer, 58

Self-timer lamp, 58

Sensitivity, 70

Sepia, 100

Seq. Numbers, 126

SET-UP menu, 121-132

SHOOTING menu, 91-120

Shooting mode, 42-56

Auto, 22

P, S, A, M, 52-56

Scene, 44-49

Shot Confirmation, 129

Shutter-release button, 4, 24

Shutter release delay. See self-timer

Shutter Sound, 127

Shutter speed, 53. See also exposure mode

Size. See image size

Slide-copy adapter, 106-107

Slide Show, 138-39**Small Pic.**, 75-76, 142**SMALL PIC.** button, 4, 75

Small picture, 75

Speaker, built-in, 4, 77, 78

Specifications, 161-164

Speedlight. See flash

Speedlight Cntrl, 115**Speedlight Opt.**, 114-115**Sports**, 49

Strap. See camera strap

Sunset, 46

Sync terminal. See flash, optional

Swivel limit switch, 21

T

T. See zoom, indicator

T. See zoom, button

Telephoto. See **Lens**; zoom

Television playback, 40

Thumbnail display, 30

TIF. See image files

TIFF. See image quality

Time and date. See **Date**

Time exposure. See long time-exposure

Transfer, 147

marking images for, 147

Troubleshooting, 154-156

U

Ultra HS. See **Continuous**; folders

USB, 131-132. See also transfer

User Setting, 104**V****Variable Power**, 114

VCR. See television playback

Video Mode, 40, 130

Voice memo, 78

W

W. See zoom, indicator

W. See zoom, button

WB-BKT. See white balance, bracketing

Web resources, 154

White balance, 92-94

bracketing, 117

fine tuning, 93

preset, 94

Wide angle. See **LENS**; zoom

Z

Zoom

button, 4, 30, 62, 74

digital, 63

indicator, 22, 62-63

Zoom Options, 112-113

Nikon

NIKON CORPORATION

Fuji Bldg., 2-3 Marunouchi 3-chome,
Chiyoda-ku, Tokyo 100-8331, Japan

Printed in Japan
S2H05000501(11)
6MAA2311-05

Free Manuals Download Website

<http://myh66.com>

<http://usermanuals.us>

<http://www.somanuals.com>

<http://www.4manuals.cc>

<http://www.manual-lib.com>

<http://www.404manual.com>

<http://www.luxmanual.com>

<http://aubethermostatmanual.com>

Golf course search by state

<http://golfingnear.com>

Email search by domain

<http://emailbydomain.com>

Auto manuals search

<http://auto.somanuals.com>

TV manuals search

<http://tv.somanuals.com>