

Industrial Microscopes ECLIPSE

LV150 LV150A LV100D

Specifications and equipment are subject to change without any notice or obligation on the part of the manufacturer. April 2005. ©2000-05 NIKON CORPORATION



WARNING

TO ENSURE CORRECT USAGE, READ THE CORRESPONDING MANUALS CAREFULLY BEFORE USING YOUR EQUIPMENT.



NIKON CORPORATION
Fuji Bldg., 2-3, Marunouchi 3-chome, Chiyoda-ku,
Tokyo 100-8331, Japan
www.nikon.com/



ISO 14001 Certified
NIKON INSTRUMENT CO., LTD.



ISO 9001 Certified
NIKON CORPORATION
Instruments Company



ISO 14001 Certified
NIKON CORPORATION
Yokohama Plant

NIKON INSTRUMENT CO., LTD.

Parale Mitsui Bldg., 8, Higashida-cho, Kawasaki-ku,
Kawasaki, Kanagawa 210-0005, Japan
phone: +81-44-223-2175 fax: +81-44-223-2182
<http://www.nikon-instruments.jp/eng/>

NIKON INSTRUMENTS (SHANGHAI) CO., LTD.

CHINA phone: +86-21-5836-0050 fax: +86-21-5836-0030
(Beijing office)

CHINA phone: +86-10-5869-2255 fax: +86-10-5869-2277

NIKON SINGAPORE PTE LTD

SINGAPORE phone: +65-6559-3618 fax: +65-6559-3668

NIKON MALAYSIA SDN. BHD.

MALAYSIA phone: +60-3-78763887 fax: +60-3-78763387

NIKON INSTRUMENTS EUROPE B.V.

P.O. Box 222, 1170 AE Badhoevedorp, The Netherlands
phone: +31-20-44-96-222 fax: +31-20-44-96-298
<http://www.nikon-instruments.com/>

NIKON FRANCE S.A.S.

FRANCE phone: +33-1-45-16-45-16 fax: +33-1-45-16-00-33

NIKON GMBH

GERMANY phone: +49-211-9414-0 fax: +49-211-9414-322

NIKON INSTRUMENTS S.p.A.

ITALY phone: +39-55-3009601 fax: +39-55-300993

NIKON AG

SWITZERLAND phone: +41-43-277-2860 fax: +41-43-277-2861

NIKON UK LTD.

UNITED KINGDOM phone: +44-20-8541-4440 fax: +44-20-8541-

NIKON INSTRUMENTS INC.

1300 Walt Whitman Road, Melville, N.Y. 11747-3064, U.S.A.
phone: +1-631-547-8500; +1-800-52-NIKON (within the U.S.A. only) fax: +1-631-547-0306
<http://www.nikonusa.com/>

NIKON CANADA INC.

CANADA phone: +1-905-625-9910 fax: +1-905-625-0103

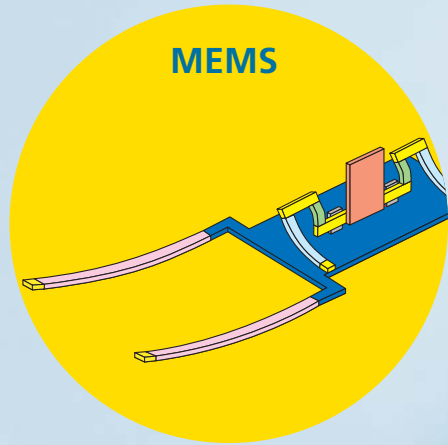

MEMS

- Printer heads
- Micro sensors
- Optical switches
- GMR heads for HDD



Versatility

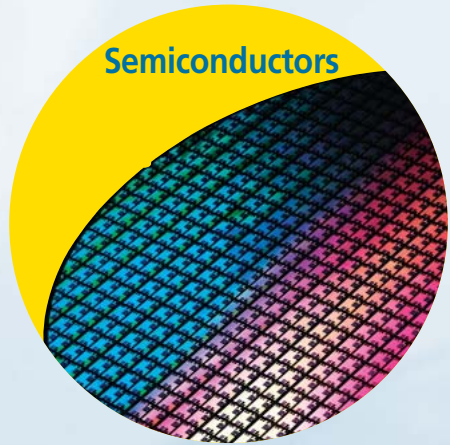

Semiconductors

- Bare wafers
- Lithography process
- Probe, test processes
- Post-dicing

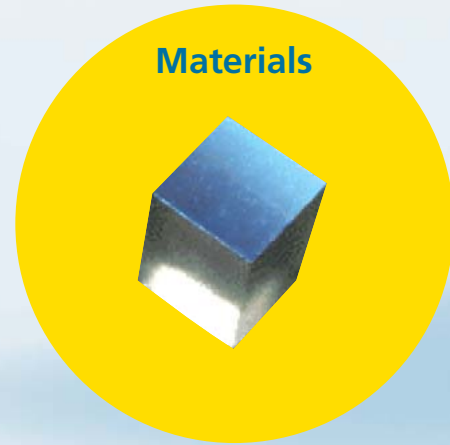

Materials

- Macromolecules, monomeric materials
- Organic/inorganic materials
- Polymers
- Thin film
- Magnetic materials
- Crystals
- Metallurgy



Extend your vision



Packages

- LF/TAB
- WL-CSP
- QFP
- SIP
- BGA, CSP, FC



Casts and parts

- OA equipment parts
- Cell phones, PDAs, DSC, PC parts
- Automobiles, aeronautics



LV150



LV150A



LV100D



Versatility



Extend your vision



Optical performance



Improved performance

A modular microscopy system for breadth and depth



PCB

- Medium/small PCB
- FPC
- Interposer substrates

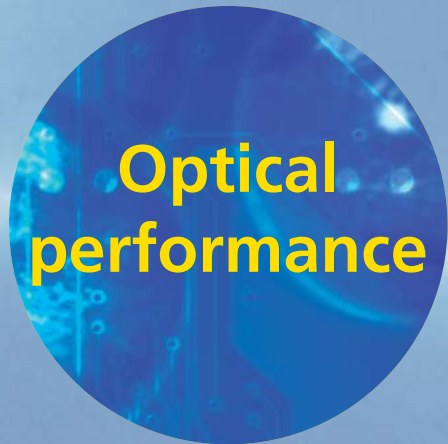

Optical performance



Precision molds

- Precision molds

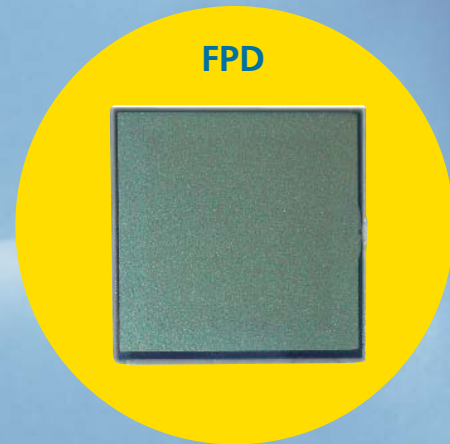

FPD

- LCD, color filters
- Polarizing filters
- Organic EL



Improved performance

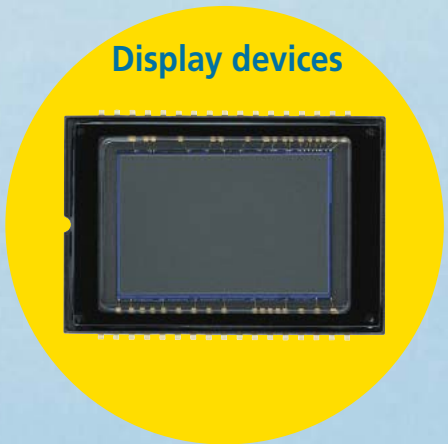

Display devices

- CCD
- CMOS
- LCOS
- DMD

Versatility

The modular design of the Eclipse LV series allows an unprecedented level of versatility. The Eclipse LV series offers flexibility that enables it to cover a wide variety of products and applications, extending from development and quality control to inspection in the manufacturing process. Users will recognize the superb performance of the Eclipse LV series when inspecting semiconductors, FPD, packages, electronics substrates, materials (material science), medical devices, cast/metallic/ceramic parts, precision molds, MEMS, telecommunications devices, and a wide variety of other samples.

Accepts taller samples

The maximum sample height can be increased to 82mm from 47mm by inserting the LV-CR Column Riser 35 between the main body and arm of the microscope. This feature is useful for viewing the surfaces of precision molds, optical materials and other thick samples.

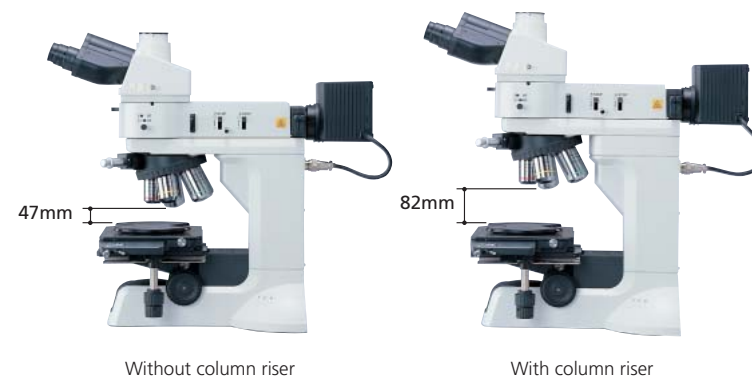

Non-Nikon stages (LV150 or LV150A only)

Use of non-Nikon stages, such as the Suruga Seiki B23-60CR, in combination with the LV-SUB Substage 2 allows the microscope to handle taller samples of up to 116.5 mm, thereby enabling the observation of fiber ends and other tools.



Combination of LV-150 with LV-SUB Substage 2 and Suruga Seiki B23-60CR stage

Modular design



LV150 standard combination

Extensive range of industrial stages and accessories

Users can select suitable models based on sample and stage stroke. All stages are highly durable with triple-plate design.

Compact industrial stage: LV-S32 3x2 Stage

The newly designed LV-S32 3x2 is a compact stage for industrial microscopes. Its triple-plate design ensures durability, stability and ease of use, even when heavy samples such as metallic materials are observed. The standard glass plate makes this stage suitable for episcopic and diascope illumination.



LV-S32 3x2 Stage
Stroke: 75 x 50 mm



LV-S64 6x4 Stage
Stroke: 150 x 100 mm

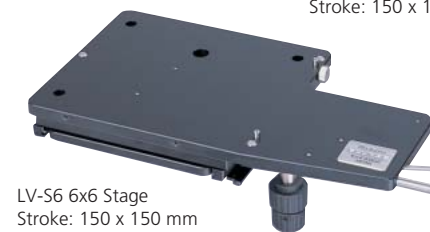

LV-S6 6x6 Stage
Stroke: 150 x 150 mm

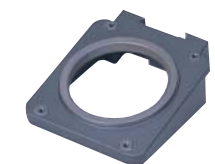

LV-SUB Stage
(exclusive for LV150/LV150A)

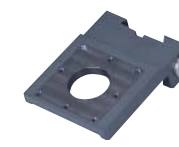

LV-SUB Substage 2
(exclusive for LV150/LV150A)



L-S6WH Wafer Holder 6
(for LV-S6 6x6 Stage)

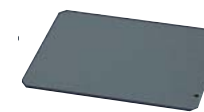

L-S6PL ESD Plate
(for LV-S6 6x6 Stage)



LV-S32PL ESD Plate
(for LV-S32 3x2 Stage)



LV-S32SGH Slideglass Holder
(for LV-S32 3x2 Stage)

Appropriate holder and substage are selected based on sample and stage combination.

Dia base unit for diascope illumination

In the Eclipse LV series, the LV-DIA Dia Base is available for diascope illumination OEM use. Users can now take full advantage of the modular design. A UN2 transformer is used for the power supply.

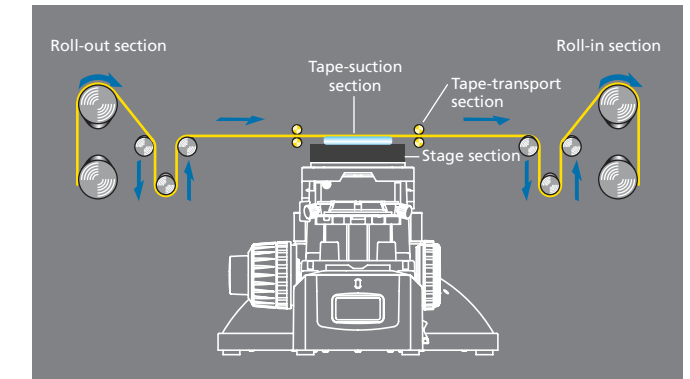

An example of LV-DIA Dia Base built into a taped sample inspection system



LV-DIA Dia Base

Versatility

Extend your vision

A wide variety of observation methods is available with the Eclipse LV series. Observations with first-order compensator, UV polarizing, and epi-fluorescence observations with UV excitation, in addition to brightfield, darkfield, DIC, simple polarizing, epi-fluorescence (excitation using visible light) and double-beam interferometry are all possible. Two new light sources also have been developed: high-intensity, low power-consumption 12V-50W halogen light source and adjustable high-intensity mercury-fiber light source.

Universal epi-illuminator: LV-UEPI

The LV-UEPI universal epi-illuminator enables brightfield, darkfield, simple polarizing and DIC observations. Field and aperture diaphragms are automatically opened when the observation is switched from brightfield to darkfield, and return to their original position when switched back to brightfield.



- Brightfield
- Darkfield
- Simple polarizing
- DIC

Universal epi-illuminator 2: LV-UEPI2

The LV-UEPI2 universal episcopic illuminator is equipped with advanced optics suited to a wide variety of observation methods—brightfield, darkfield, DIC and epi-fluorescence—and automatically sets optimal illumination in accordance with the field and aperture diaphragm, shutter, and filters, including diffuser and ND. This design enables the operator to concentrate on the observation.



- Brightfield
- Darkfield
- Simple polarizing
- Observation with first-order compensator
- UV polarizing epi-fluorescence
- DIC
- Epi-fluorescence (UV excitation possible)

High-intensity 12V-50W halogen light source:

LV-LH50PC Precentered Lamphouse

Although the LV-LH50PC Precentered Lamphouse is 12V-50W, the brightness is equivalent to or higher than that of 12-100W types. The low power-consumption halogen light source contributes to the compact design of the microscope while also being friendly to the environment. Focus drift due to heat from the illuminator is substantially reduced.

Auto optimal illumination selection

	Field diaphragm	Aperture diaphragm	Shutter	UV-cut filter
BF	Any diameter	Any diameter	Open	Insert
DF	Open	Open	Open	Insert
FL1	Any diameter	Any diameter	Open	—
FL2	Any diameter	Any diameter	Open	—

Optical Performance

Transmission wavelength coverage extended to UV

CFI LU Plan Fluor series

The new CFI LU Plan Fluor series covers transmission wavelength ranges up to UV. These objective lenses are suitable for various research, analysis and examination needs, while maintaining Nikon's commitment to high NA and long working distance. Only one kind of objective lens is needed for brightfield, darkfield, simple polarizing, observation with first-order compensator, DIC and UV epi-fluorescence observations. These objective lenses, which offer high resolution and easy-to-use performance, can be combined not only with microscopes but also with other equipment for even greater versatility.

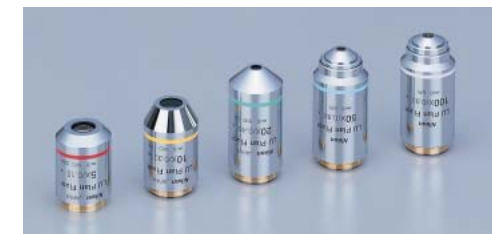

CFI60 LU Plan Fluor EPI series



CFI60 LU Plan Fluor BD series

Objective lenses with correction ring

CFI L Plan EPI CR series

The CFI60 series now includes the CFI L Plan EPI CR series to cope with the thinner coverglass used in liquid crystal displays, and highly integrated, and dense devices. Coverglass correction can be continuously made from 0 mm up to 1.2 mm (0-0.7 mm and 0.6-1.3 mm for 100x) with the correction ring. The 100x objective lens offers 0.85 high NA, while enabling high-contrast imaging of cells and patterns without being affected by the coverglass.



CFI60 L Plan EPI CR series of objective lenses with correction ring

Environmentally friendly

The eco glass used in the CFI LU Plan Fluor and L Plan EPI CR series does not contain harmful substances such as lead and arsenic.

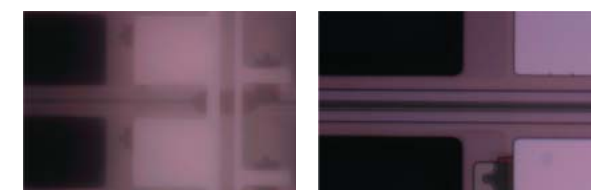

Without correction (50x)

With correction at 0.7 mm (50x)

CFI60 Series Objectives

Model	Magnification	NA	Working Distance (mm)
CFI L Plan EPI	2.5X	0.075	8.8
CFI LU Plan Fluor EPI	5X	0.15	23.5
New	10X	0.30	17.3
	20X	0.45	4.5
	50X	0.80	1.0
	100X	0.90	1.0
CFI LU Plan EPI ELWD	20X	0.40	13.0
	50X	0.55	10.1
	100X	0.80	3.5
CFI L Plan EPI SLWD	20X	0.35	24.0
	50X	0.45	17.0
	100X	0.70	6.5
CFI LU Plan Apo EPI	100X	0.95	0.4
	150X	0.95	0.3
CFI L Plan Apo EPI WI	150X	1.25	0.25

Model	Magnification	NA	Working Distance (mm)
CFI LU Plan Fluor BD	5X	0.15	18.0
New	10X	0.30	15.0
	20X	0.45	4.5
	50X	0.80	1.0
	100X	0.90	1.0
CFI LU Plan BD ELWD	20X	0.40	13.0
	50X	0.55	9.8
	100X	0.80	3.5
CFI LU Plan Apo BD	100X	0.90	0.51
	150X	0.90	0.4

Model	Magnification	NA (mm)	Working Distance (mm)	Glass Thickness Correction Range
CFI L Plan EPI CR New	20x	0.45	10.9-10.0	0-1.2mm
CFI L Plan EPI CR New	50x	0.7	3.9-3.0	0-1.2mm
CFI L Plan EPI CRA New	100x	0.85	1.2-0.85	0-0.7mm
CFI L Plan EPI CRB New	100x	0.85	1.3-0.95	0.6-1.3mm

Improved performance

Usability has been vastly improved as has durability and rigidity.

Tilting trinocular eyepiece tube



LV-TT2 Tilting Trinocular Eyepiece Tube

The newly developed LV-TT2 tilting trinocular eyepiece tube (erect image) offers comfort to all users, regardless of their stature or viewing position. The optical path changeover of 100:0/20:80 allows the simultaneous use of a monitor.

Thorough ESD protection



All parts of the microscope that might be touched, including the body, tube and stage, have been insulated. This improves anticontamination and prevents samples from being harmed by static electricity, thereby improving yields.

Electrostatic decay time: 1000-10V, within 0.2 sec.

Highly durable motorized nosepiece



LV-NU5A Nosepiece

The LV-NU5A motorized universal quintuple nosepiece is 10 times more durable than its predecessor and can be used with the LV150A. In combination with the LV-NCNT motorized nosepiece controller, it can also be used in other devices.

Manual nosepiece

A variety of manual nosepieces are available to suit all needs.

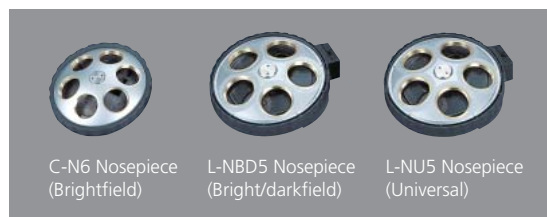

C-N6 Nosepiece (Brightfield) L-NBD5 Nosepiece (Bright/darkfield) L-NU5 Nosepiece (Universal)

Highly rigid, vibration-free body

The use of structural analysis during the design process has improved rigidity and antivibration parameters to yield clear images even at high magnification.

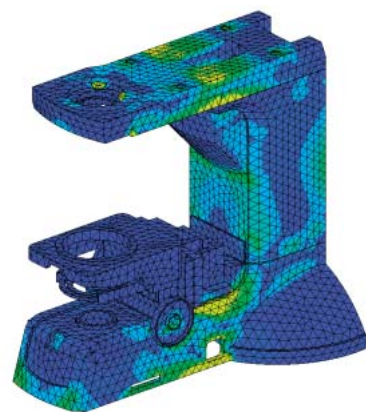

Observation Methods

Brightfield

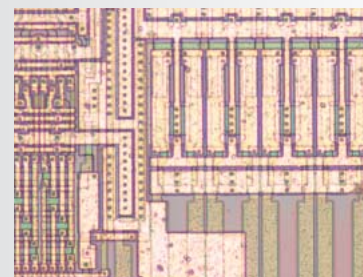

The antireflective design applied to the objective lenses and light source ensures bright, high-contrast images.

Darkfield

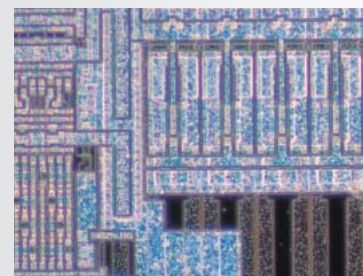

Nikon's unique "Fly-eye Lens" used in the darkfield illuminator yields a threefold increase in brightness over previous models. This allows high-sensitivity detection of defects and height gaps in samples.

Nomarski DIC

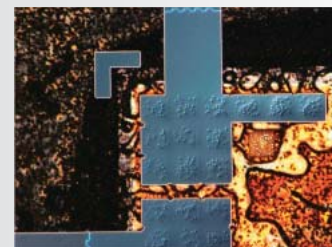

L-DIC DIC Prism (standard)



L-DIHC DIC Prism (high contrast)



YM-PO Polarizer L-AN Analyzer L-DIC DIC Prism L-DIHC High-contrast DIC Prism

Standard or high contrast DIC sliders can be selected to suit the sample. This method is useful for the surface observations of various devices and precision molds.

Double-beam interferometry equipment (measures minute height gaps)



Michelson (TI) and Mirau (DI) types of episcopic double-beam interferometry can be carried out. A filar micrometer eyepiece can be used to examine or measure samples while avoiding direct contact.



Episcopic Two-beam Interferometry Equipment TI/DI

Simple polarizing

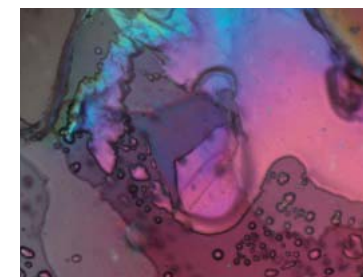

In addition to simple polarizing, a lambda plate can be inserted into the optical path to achieve observations with a first-order compensator. This is useful for liquid crystal inspections (when used in combination with the LV-UEPI 2).



YM-PO Polarizer L-AN Analyzer



LV-PO Polarizer LV-FLAN FL Analyzer LV-AP λ Plate

Epi-fluorescence

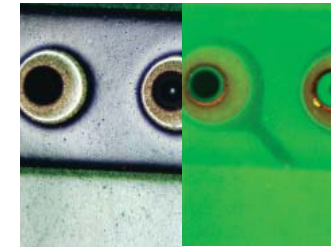

Brightfield Epi-fluorescence B-2A

UV, V, BV, B or G excitation fluorescence filter blocks can be selected. This method is perfect for the observation of OEL, ion migration and other substrate uses.



Fluorescence filter blocks



LV-UV Polarizer LV-FLAN FL Analyzer

Diascopic illumination

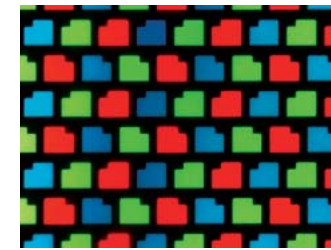

Diascopic illumination is used to observe optical parts, FPD and other samples that transmit light.



Condenser

LV150/LV150A

(Episcopic illumination type)



Applications

Semiconductor (IC wafer)

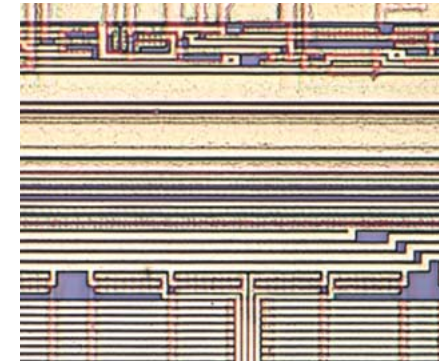

Brightfield

Semiconductor (IC wafer)

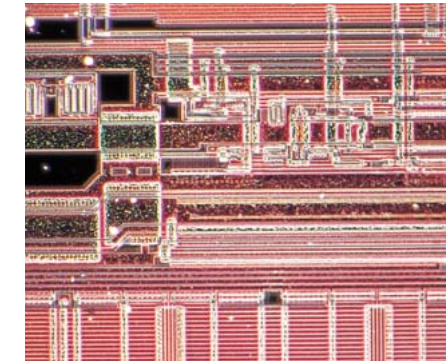

Darkfield

MEMS (optical switch)

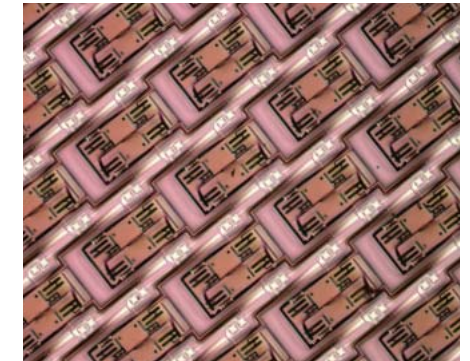

Brightfield

Micro bump

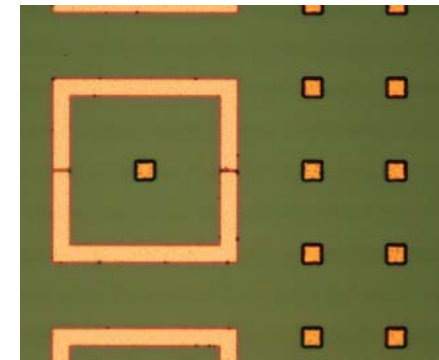

Brightfield

Compact disc (CD)

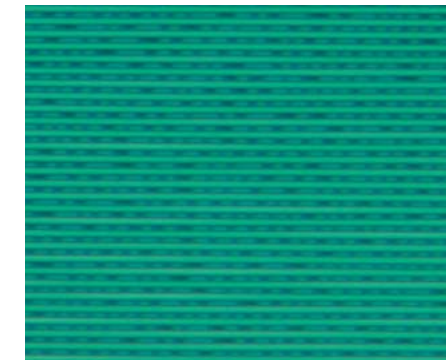

Simple polarizing

Image sensor (CCD)

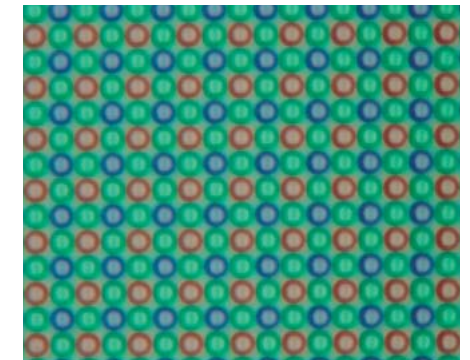

Brightfield

PCB (ion migration)



Brightfield

PCB (ion migration)

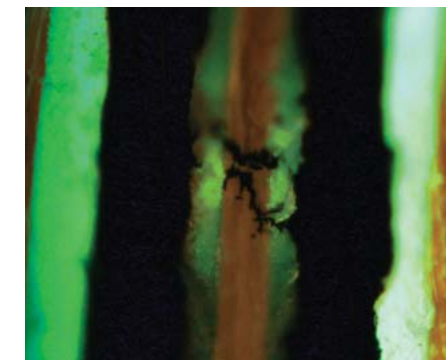

Epi-fluorescence

Precision mold

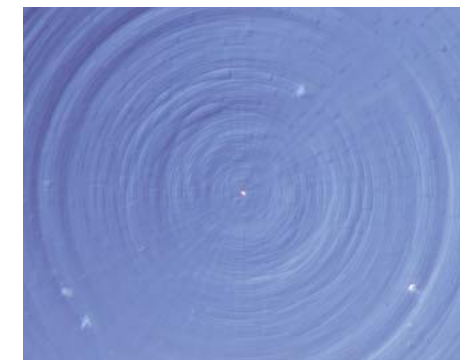

DIC

LV100D

(Episcopic/diascopic illumination type)



LV-T13 Trinocular Tube
A trinocular tube with an optical path changeover of 100:0/0:100.

LV-LH50PC 12V-50W Lamphouse
A low power-consumption 12V-50W halogen light source equivalent to or higher than the 12V-100W type.

CFI-series eyepiece

LV-UEPI2
The LV-UEPI2 illuminator enables brightfield, darkfield, DIC, simple polarizing, and UV excitation epi-fluorescence observations.

Nosepiece
Selectable from C-N6 (brightfield), L-NBD5 (bright/darkfield) and L-NU5 (universal) nosepieces.

LV-S32 3x2 Stage
This small, industrial-use stage has a triple-plate design and can be used for episcopic and diascopic illumination.

LV100D
The LV100D microscope is capable of episcopic and diascopic illumination.

CFI LU Plan Fluor Series
These objective lenses feature high NA, long working distances and an extended transmission wavelength range.

Applications

LCD (color filter)

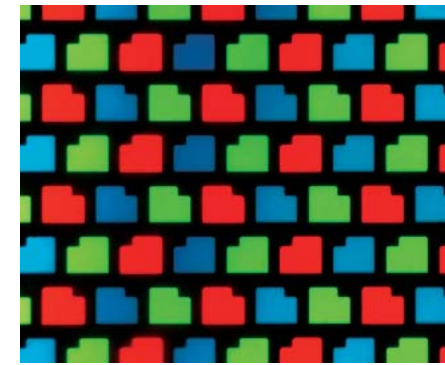

Diascopic brightfield

LCD (conductive particle)

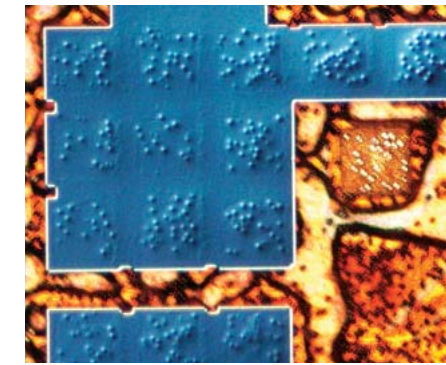

DIC

Test reticle

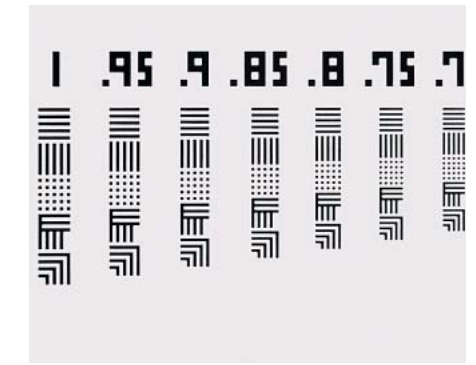

Diascopic brightfield

リシャ輝石??

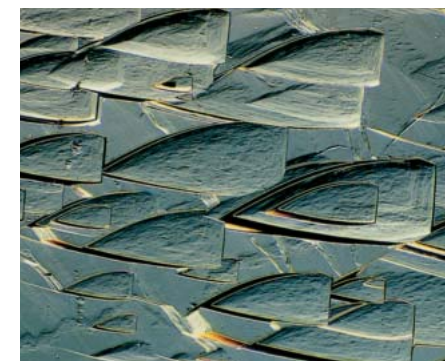

DIC

Carbon paper

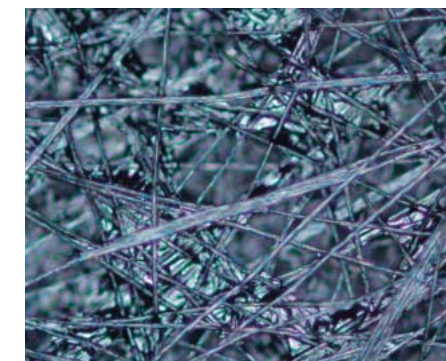

Brightfield

Nodular graphite cast iron

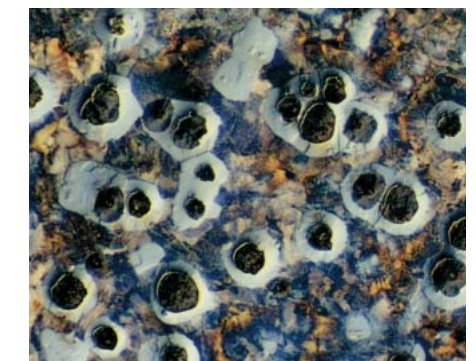

DIC

Tourmaline



Brightfield

Tourmaline

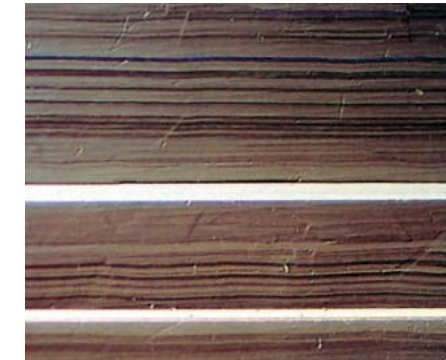

DIC

Tourmaline

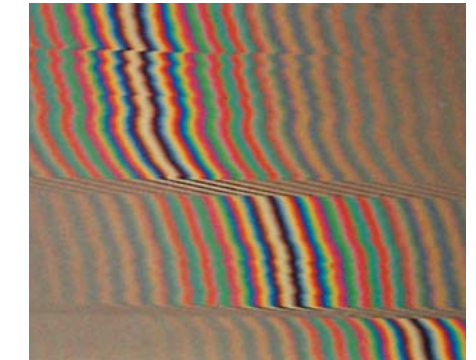

Double-beam interferometry

Eye-piece tubes



LV-T13 Trinocular Eyepiece Tube ESD



LV-TT2 Tilting Trinocular Eyepiece Tube

Eye-pieces

Model	F.O.V.	Remarks
CFI 10x	22	
CFI 10xM	22	Photomask included
CFI 10xCM : for C-TE binocular ergo tube	22	Crosshairs and micrometer included
CFI 12.5x	16	
CFI 15x	14.5	
CFI UW 10x	25	
CFI UW 10xM	25	Photomask included
Micrometer eyepiece 10xN	20	Stroke 10 mm Main scale: 0.1 mm/increments Sub scale: 0.01 mm/increments

Nosepieces



C-N6 Nosepiece (Brightfield) L-NBD5 Nosepiece (Bright/darkfield) L-NU5 Nosepiece (Universal) LV-NU5A Motorized Nosepiece (Universal)

Objective lenses



CFI LU PLAN FLUOR EPI series CFI L PLAN EPI CR series



CFI LU PLAN FLUOR BD series

Objective adapters



LU objective Adapter M32-25 C-OA 15mm Adapter

Diascopic illumination condensers



LWD Achromat Slide Achromat (Swing-out??) 2-100x C-C Abbe C-C Achro DF (Dry)

Illuminators



LV-UEPI



LV-UEPI2

Double Port



Y-IDP Double Port (Beamsplit 45:55/0:100)
Y-IDP Double Port 0/100 (Beamsplit 100:0/0:100)

Polarizing/DIC accessories

Simple Polarizing



YM-PO Polarizer L-AN Analyzer

Observation with first-order compensator



LV-PO Polarizer LV-FLAN FL Analyzer LV-AP λ Plate

UV polarizing epi-fluorescence



LV-UV Polarizer LV-FLAN FL Analyzer

DIC



YM-PO Polarizer L-AN Analyzer L-DIC DIC Prism L-DIC High-contrast DIC Prism

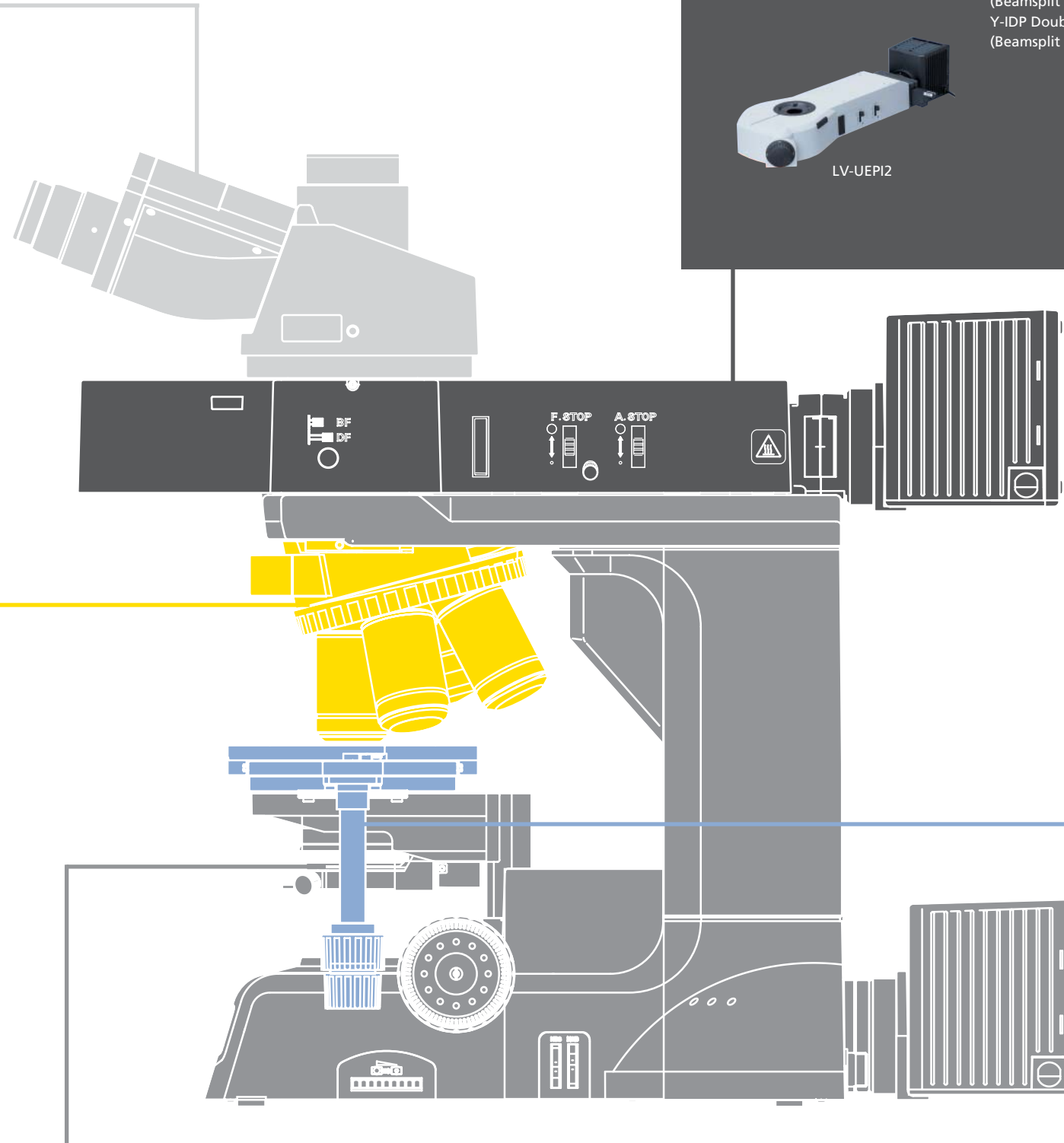

Substages (LV150/LV150A)

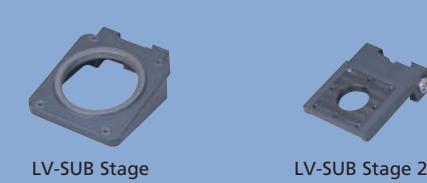

LV-SUB Stage LV-SUB Stage 2

Stages

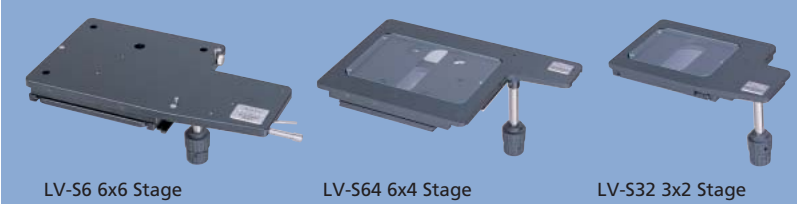

LV-S6 6x6 Stage LV-S64 6x4 Stage LV-S32 3x2 Stage

Holders

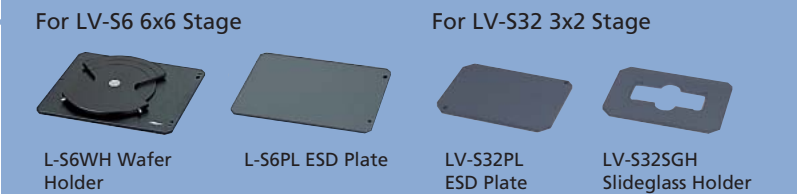

L-S6WH Wafer Holder L-S6PL ESD Plate LV-S32PL ESD Plate LV-S32SGH Slideglass Holder

Micrometers

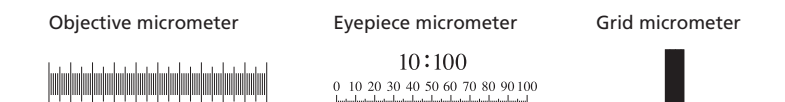

Objective micrometer Eyepiece micrometer 10:100 Grid micrometer

ACCESSORIES

Digital Sight

The Digital Sight series is a powerful imaging system for monitoring/capturing images taken under brightfield, darkfield, DIC, epi-fluorescence, and other observation methods.

Standalone type

This type comes with an LCD monitor, making it convenient for on-screen monitoring without a PC and applications that require long/multiple exposures.



Real imaging camera—DS-2Mv-L1

- Live image display at 30fps max.
- Image size: 1600 x 1200 pixels
- 6.3" TFT monitor
- Analog RGB output
- CompactFlash card slot
- USB mass-storage-class compatible
- Direct print function (Pict bridge compatible) optional^{*1}
- Ethernet (100BASE/TX) port^{*2}



*1: A CP900DC dedicated printer and C-mount adapter are necessary. Provided with real 10 mode (10X printing).

*2: FTP Client/Server, HTTP Server Telnet Server functions provided.

Camera control software for DS-L1/DS-U1

Scene mode—optimal imaging with a single mouse click

Optimal imaging parameters have been preset for each sample type, therefore anyone, regardless of experience, can easily perform photography of the highest level.



A host of measuring tools

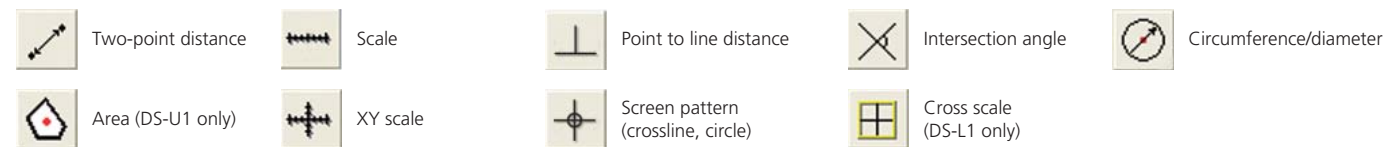

*Dedicated ACT-2U camera control software is necessary when using the DS-U1.

Camera heads

Select the best type to match your sample and use.

For brightfield, darkfield, DIC observations

DS-2MBW



- Image size: 1600 x 1200 pixels
- 15 fps (30 max.)
- Superb movie

DS-5M



- Image size: 2560 x 1920 pixels
- True-to-life recording of minute images

For fluorescence observations (that require long exposure)

DS-2MBWc



- Image size: 1600 x 1200 pixels
- Sensitivity approx. 5 times greater than predecessors
- Includes a Peltier device
- Brilliant images with minimum noise

DS-5Mc



- Image size: 2560 x 1920 pixels
- Includes a Peltier device
- Brilliant images with minimum noise



Dedicated camera control software ACT-2U



Ultrahigh-definition Digital Camera DXM1200F

The DXM1200F produces true-to-life, extremely high-quality images with up to approximately 12 million output pixels. It meets the demanding requirements of professional users and is excellent for image analysis in advanced R&D fields.

- Approx. 12 million output pixels comparable to film high-end cameras, thanks to Nikon's exclusive micro-step high-density imaging technology
- Live image display at a frame rate of 12 fps max.
- The wide exposure latitude produces true-to-life images regardless of brightness level.



Camera control software

ACT-1

Minimizes fatigue during large-volume, extended time shooting.

All essential sections, including ① live image preview, ② captured image window, ③ thumbnail, and ④ image capture parameter setting panel, are simultaneously displayed on a single screen, enabling users to easily understand image capture procedures. The size of the parameter setting panel has been reduced to leave more space for image display.

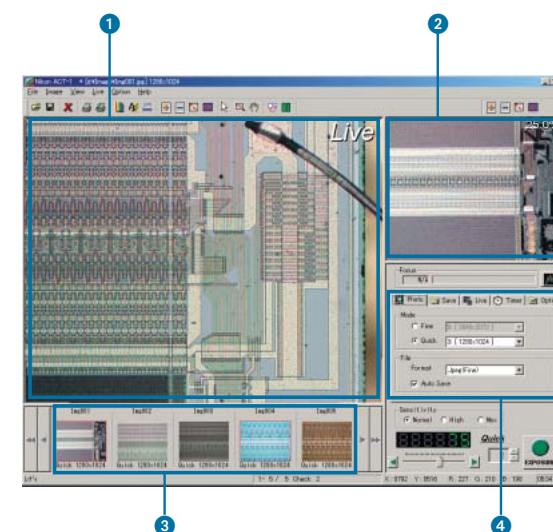

Option: camera control software

ACT-2

The optional ACT-2U software offers the following arrays of convenient measurement tools.

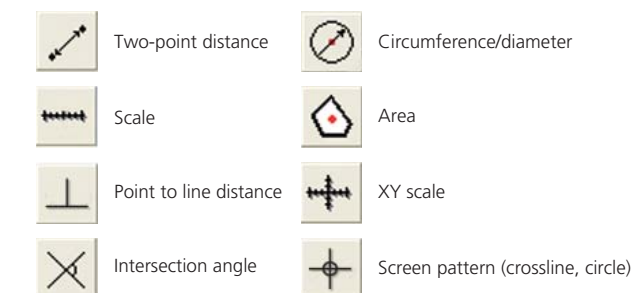

Dimensional diagrams

LV150A/LV150

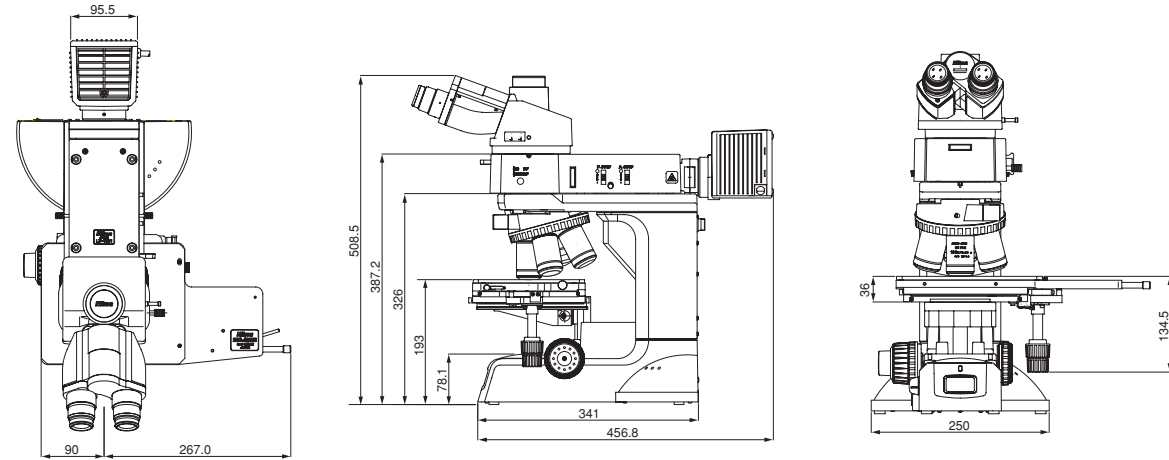

LV100D

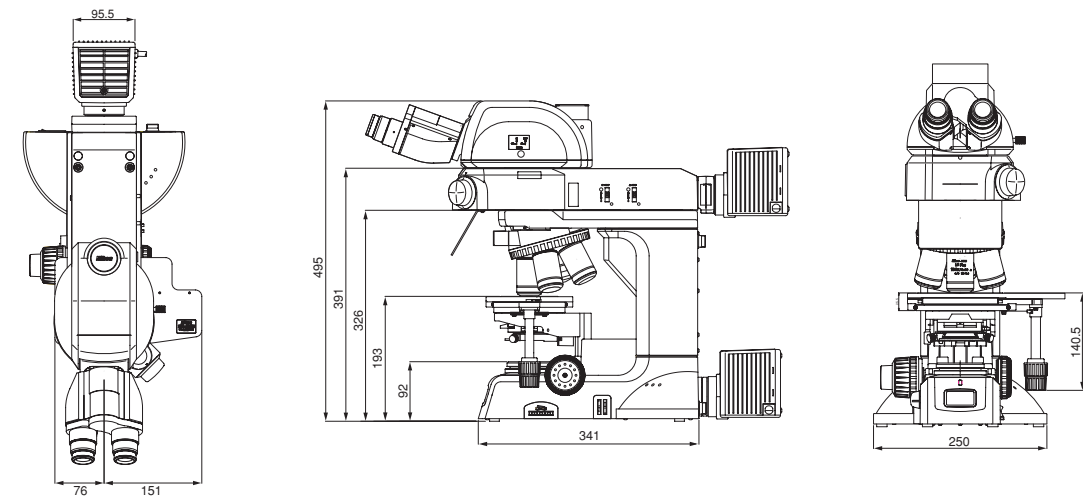

LV-UEPI Universal Epi-illuminator

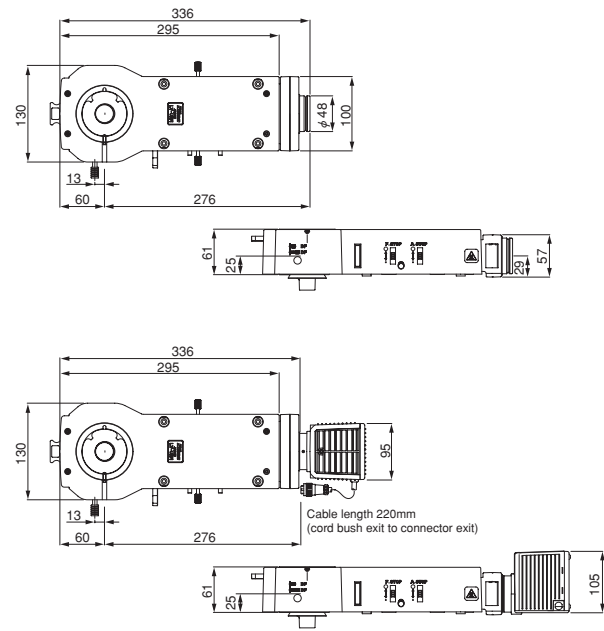

LV-UEPI2 Universal Epi-illuminator 2

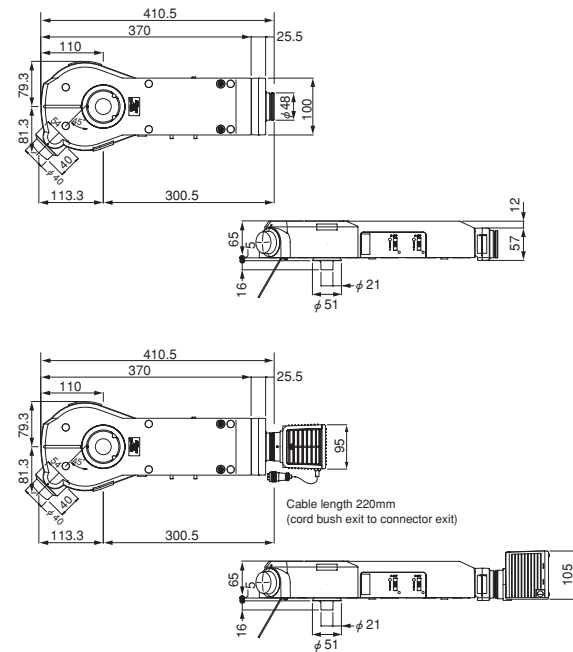

LV-TI3 Trinocular Tube ESD

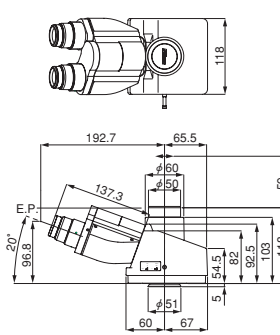

LV-TT2 Tilting Trinocular Tube

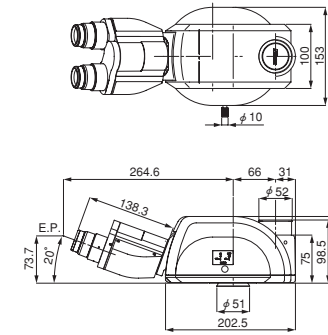

LV-CR Column Riser 35

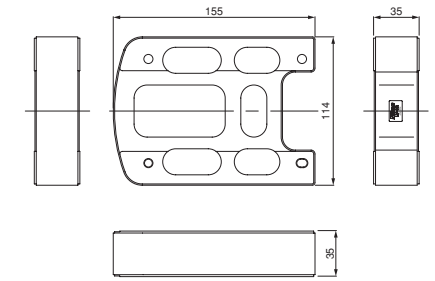

LV-S6 6x6 Stage

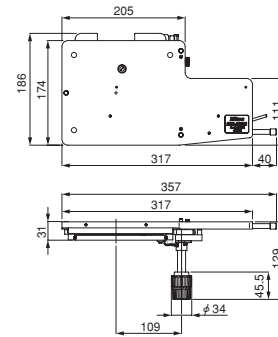

LV-S64 6x4 Stage

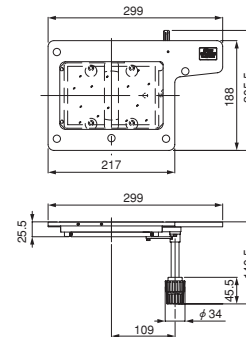

LV-S32 3x2 Stage

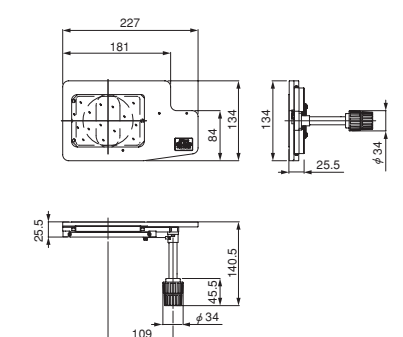

LV-SUB Stage

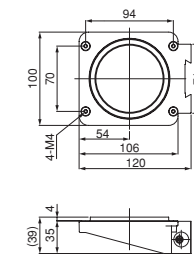

LV-SUB Stage 2

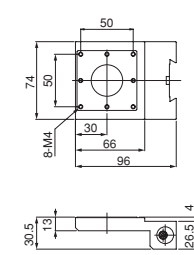

LV-S32PL ESD Plate

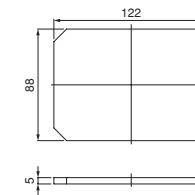

LV-S32SGH Slideglass Holder

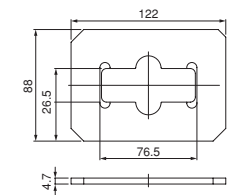

LV-NU5A Nosepiece

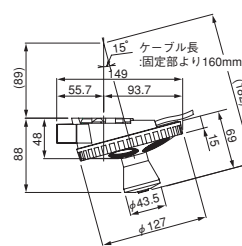

LV-NCNT Nosepiece Controller

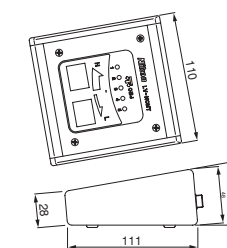

LV-DIA Dia Dase

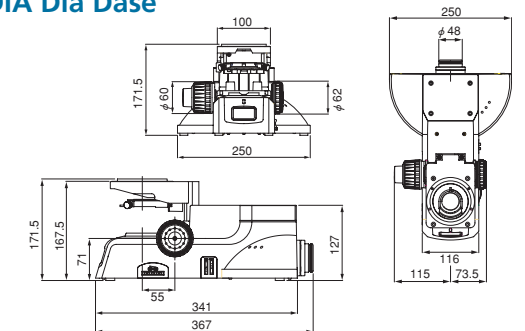

Polarizers/analyzers/ λ plate

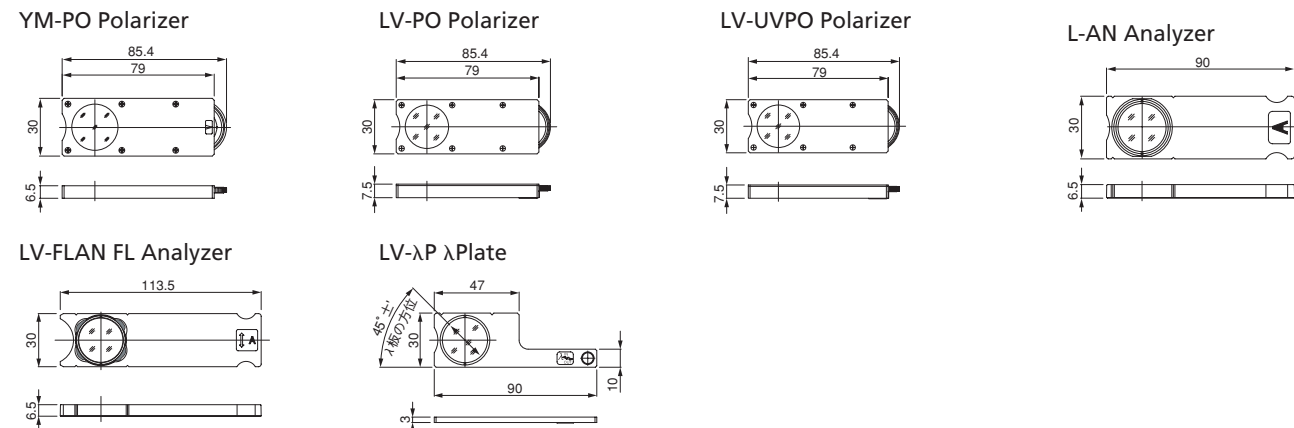

Objective lenses

CFI LU PLAN FLUOR

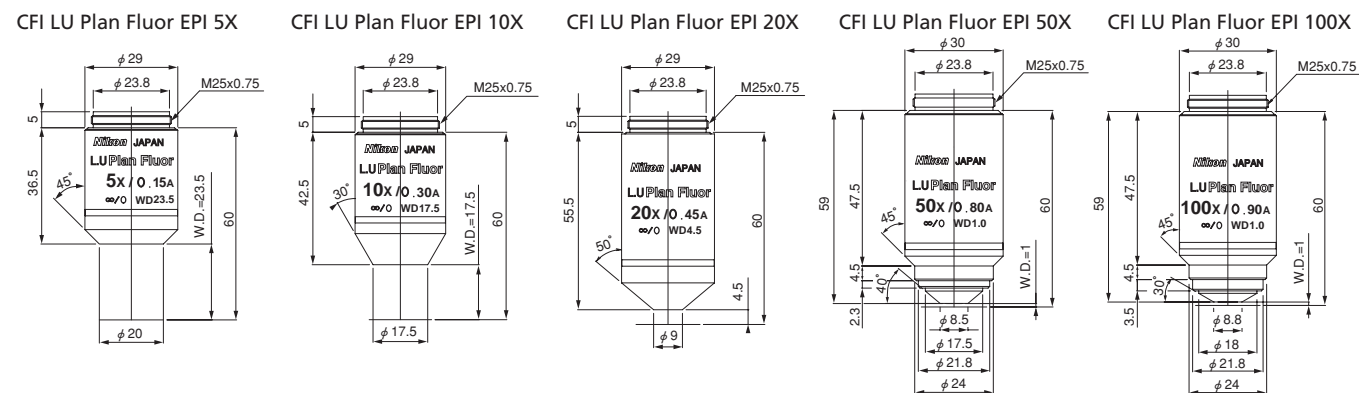

CFI LU PLAN FLUOR BD

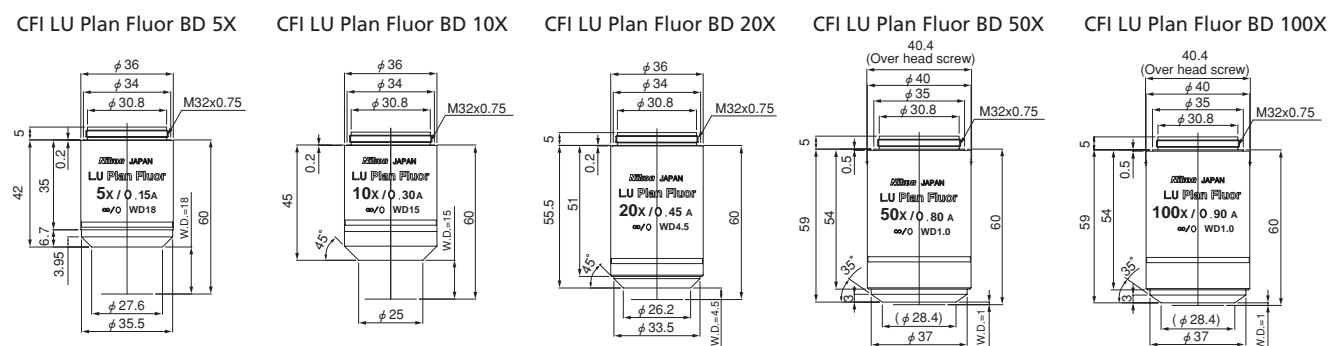

CFI L PLAN EPI CR

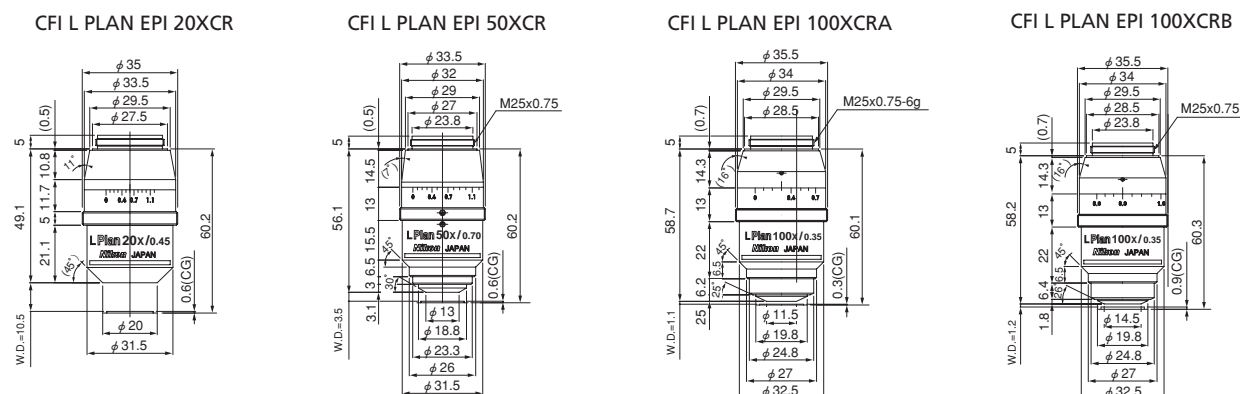

Main specifications

LV150/150A

Main body	Baseless type (spacer insertable between arm and stand); Max. sample height 47mm (when configured with 3x2 stage/6x4 stage), 82mm with column riser, 116.5mm with Suruga Seiki B23-60CR; 12V-50W brightness control transformer built in
Focusing section	Coaxial coarse/fine focus knob, left: coarse/fine, right: fine; Stroke 40mm, coarse 14.0mm/rotation (torque adjustable, with refocusing mechanism), fine focusing 0.1mm/rotation (1mm/increments)
Nosepiece	C-N6 Nosepiece (brightfield, sextuple), L-NBD5 Nosepiece (bright/darkfield quintuple, with flare prevention), L-NU5 Nosepiece (universal quintuple, with flare prevention), LV-NU5A Nosepiece (for LV150A, high-durability motorized universal quintuple, with flare prevention)
Episcopic illuminator LV-U EPI	12V-50W high-intensity halogen lamp (ESD-applied); Field (centerable) and aperture diaphragms synchronized with B/D changeover; ϕ 25mm filter (NCB11, ND16, ND4) insertable; Polarizer/analyzer mountable
Episcopic illuminator LV-U EPI2	12V-50W high-intensity halogen lamp (ESD-applied); 120W high-intensity mercury-fiber illuminator (with brightness control, no centering necessary) mountable; Centerable field and aperture diaphragms synchronized with B/D changeover; f25mm filter (NCB11, ND16, ND4) insertable; Polarizer/analyzer/plate insertable, excitation balancer insertable
Eyepiece tube	LV-TI3 Trinocular (erect image, F.O.V. 22/25), LV-TT2 Tilting Trinocular (erect image, F.O.V. 22/25), Y-TF Trinocular (inverted image, F.O.V. 22/25), Y-TB Binocular (inverted image, F.O.V. 22), C-TE Tilting Binocular (inverted image, F.O.V. 22)
Stage	LV-S32 3x2 Stage (stroke: 75x50 mm including glass plate), ESD-applied (excluding glass plate) LV-S64 6x4 Stage (stroke: 150x100 mm including glass plate), ESD-applied (excluding glass plate) LV-S6 6x6 Stage (stroke: 150x150 mm; only for episcopic illumination)
Eyepiece	CFI eyepiece series
Objective lens	CFI60 series
Electrostatic decay time	1000-10V, within 0.2 sec.
Power consumption	1.2A/75W
Weight	Approx. 8.6kg

LV100D

Main body	Baseless type (spacer insertable between arm and stand); Max. sample height 29mm, 64mm with column riser; 12V-50W brightness control transformer built in
Focusing section	Coaxial coarse/fine focus knob, left: coarse/fine, right: fine; Stroke 30mm, coarse 14.0mm/rotation (torque adjustable, with refocusing mechanism), fine focusing 0.1mm/rotation (1mm/increments)
Nosepiece	C-N6 Nosepiece (brightfield, sextuple), L-NBD5 Nosepiece (bright/darkfield quintuple, with flare prevention), L-NU5 Nosepiece (universal quintuple, with flare prevention)
Episcopic illuminator LV-U EPI	12V-50W high-intensity halogen lamp (ESD-applied); Field (centerable) and aperture diaphragms synchronized with B/D changeover; f25mm filter (NCB11, ND16, ND4) insertable; Polarizer/analyzer insertable
Episcopic illuminator LV-U EPI2	12V-50W high-intensity halogen lamp (ESD-applied); 120W high-intensity mercury-fiber illuminator (with brightness control, no centering necessary) mountable; Centerable field and aperture diaphragms synchronized with B/D changeover; f25mm filter (NCB11, ND16, ND4) insertable; Polarizer/analyzer/plate insertable, excitation balancer insertable
Diascopic illuminator	12V-50W high-intensity halogen lamp; Field (centerable) and aperture diaphragms synchronized with B/D changeover; Filters (ND8, NCB11) insertable
Eyepiece tube	LV-TI3 Trinocular (erect image, F.O.V. 22/25), LV-TT2 Tilting Trinocular (erect image, F.O.V. 22/25), Y-TF Trinocular (inverted image, F.O.V. 22/25), Y-TB Binocular (inverted image, F.O.V. 22), C-TE Tilting Binocular (inverted image, F.O.V. 22)
Stage	LV-S32 3x2 Stage (stroke: 75x50 mm including glass plate) LV-S64 6x4 Stage (stroke: 150x100 mm including glass plate)
Eyepiece	CFI eyepiece series
Objective lens	CFI60 series
Electrostatic decay time	1000-10V, within 0.2 sec.
Power consumption	1.2A/75W
Weight	Approx. 9.4kg

System diagram

LV150/LV150A

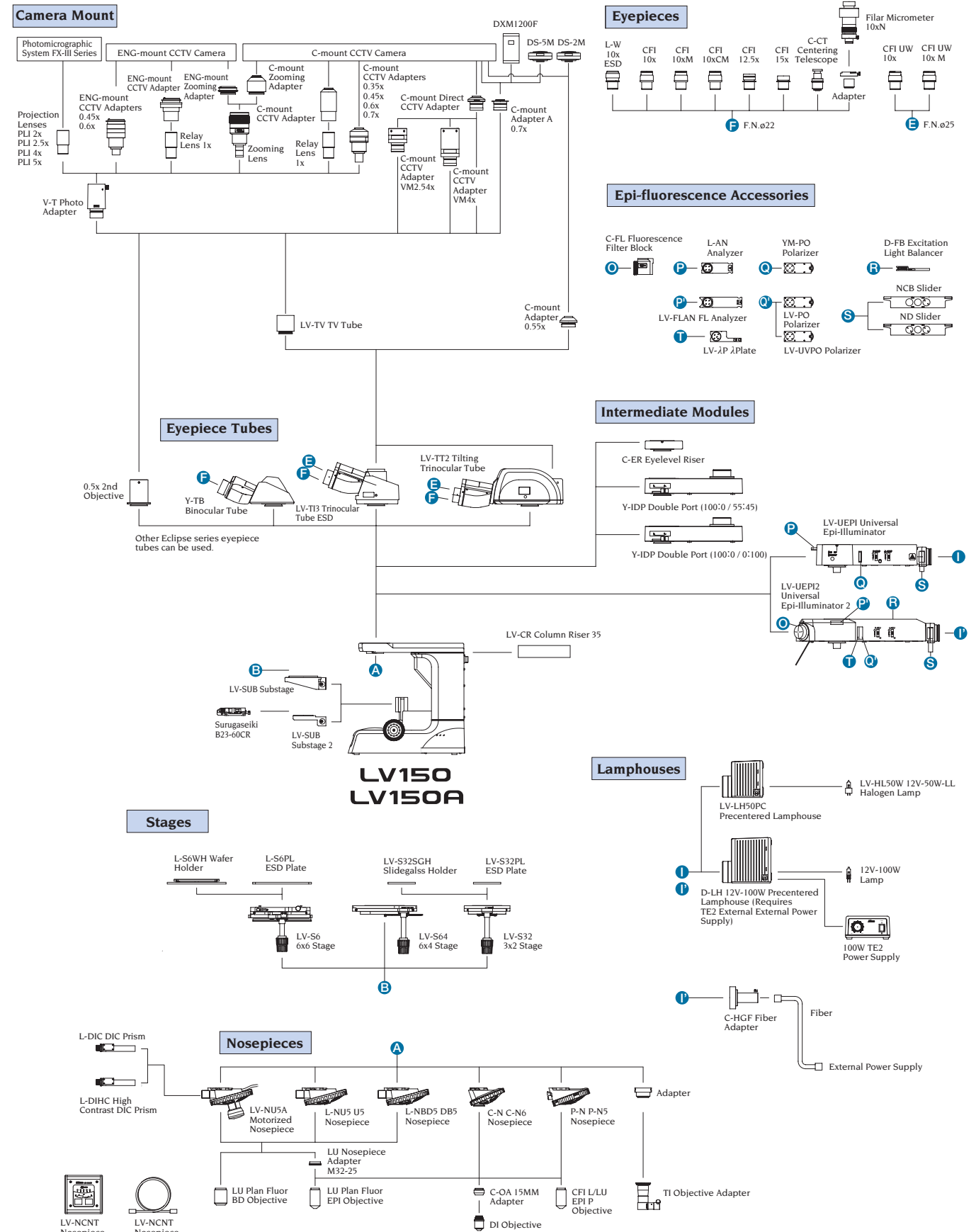

LV100D

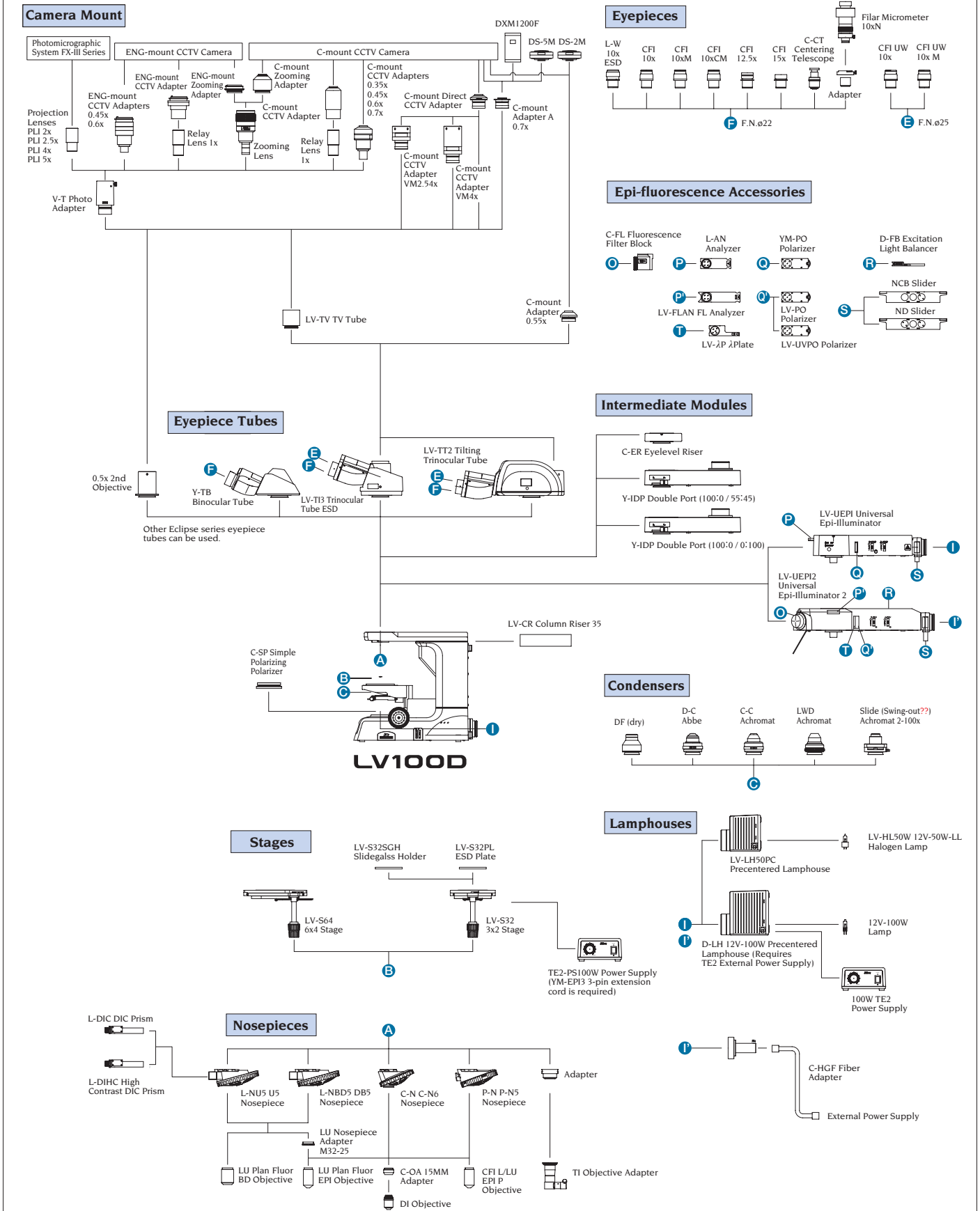

Free Manuals Download Website

<http://myh66.com>

<http://usermanuals.us>

<http://www.somanuals.com>

<http://www.4manuals.cc>

<http://www.manual-lib.com>

<http://www.404manual.com>

<http://www.luxmanual.com>

<http://aubethermostatmanual.com>

Golf course search by state

<http://golfingnear.com>

Email search by domain

<http://emailbydomain.com>

Auto manuals search

<http://auto.somanuals.com>

TV manuals search

<http://tv.somanuals.com>