

Table of Contents



Usage Notice	3
Safety Information	3
Class B emissions limits	3
Important Safety Instruction	3
Precautions	5
Eye Safety Warnings	7
Introduction	8
Product Features	8
Package Overview	9
Product Overview	10
Main Unit	10
Control Panel	11
Rear View	12
Remote Control	13
Installation	14
Connecting the Projector	14
Connect to Computer / Notebook	14
Connect to Video Sources	15
Installing or Removing the Optional Lens	16
Removing the Existing Lens From the Projector	16
Installing the New Lens	17
Powering On/Off the Projector	18
Powering On the Projector	18
Powering Off the Projector	20
Warning Indicator	20
Adjusting the Projected Image	21
Adjusting the Projector's Height	21
Adjusting Projected Image Position Using Lens Shift	21
Adjusting the vertical image position	22
Adjusting the horizontal image position	23
Lens Shift Range Diagram	23
Adjusting the Zoom / Focus	24
Adjusting Projection Image Size (XGA)	25
Adjusting Projection Image Size (WXGA)	26
Adjusting Projection Image Size (WUXGA)	27
User Controls	28
Control Panel	28
Remote Control	29
On-screen Display Menus	31
How to operate	31
Menu Tree	32
Image	34
Display	40
Setup	43
Options	56
LAN_RJ45	65



Table of Contents

Appendices	75
Troubleshooting	75
Image Problems	75
Intermission Problems	77
HDMI Q & A	78
Projector Status Indication	79
Remote Control Problems	80
Audio Problems	80
Replacing the Lamp	81
Cleaning the Projector	83
Compatibility Modes	84
Video Compatibility	84
Video timing detail describe	84
Computer Compatibility - VESA standards	85
RS232 Commands	88
RS232 Protocol Function List	89
Telnet Commands	93
AMX Device Discovery commands	93
PJLink™ supported commands	94
Trademarks	96
Ceiling Installation	97
Optoma Global Offices	98
Regulation & Safety notices	100
Operation conditions	101

Safety Information

	The lightning flash with arrow head within an equilateral triangle is intended to alert the user to the presence of uninsulated "dangerous voltage" within the product's enclosure that may be of sufficient magnitude to constitute a risk of electric shock to persons.
	The exclamation point within an equilateral triangle is intended to alert the user to the presence of important operating and maintenance (servicing) instructions in the literature accompanying the appliance.

WARNING: TO REDUCE THE RISK OF FIRE OR ELECTRIC SHOCK, DO NOT EXPOSE THE PROJECTOR TO RAIN OR MOISTURE. DANGEROUS HIGH VOLTAGES ARE PRESENT INSIDE THE ENCLOSURE. DO NOT OPEN THE CABINET.

REFER SERVICING TO QUALIFIED PERSONNEL ONLY.

Class B emissions limits

This Class B digital apparatus meets all requirements of the Canadian Interference-Causing Equipment Regulations.

Important Safety Instruction

1. Read these instructions –before using this projector.
2. Keep these instructions –for future reference.
3. Follow all instructions.
4. Install in accordance with the manufacturer's instructions :
 - A. **Do not block any ventilation openings.** To ensure reliable operation of the projector and to protect it from overheating, put the projector in a position and location that will not interfere with its proper ventilation. For example, do not place the projector on a bed, sofa, carpet, or similar surface that may block the ventilation openings. Do not put it in an enclosure, such as a bookcase or a cabinet that may keep air from flowing through its ventilation openings.
 - B. **Do not use this projector near water or moisture.** To reduce the risk of fire or electric shock, do not expose the projector to rain or moisture.
 - C. **Do not install near any heat sources,** such as radiators, heaters, stoves or other apparatus (including amplifiers) that produce heat.
5. Clean only with a dry cloth.
6. Only use attachments/accessories specified by the manufacturer.
7. Refer all servicing to qualified service personnel. Servicing is required when the projector has been damaged in any way, such as:
 - Power supply cord or plug is damaged.
 - Liquids have spilled or objects have fallen into the apparatus.
 - The projector has been exposed to rain or moisture, does not operate normally, or has been dropped.

Usage Notice

Do not attempt to service this projector yourself. Opening or removing covers may expose you to dangerous voltages or other hazards. Please call Optoma to be referred to an authorized service center near you.

8. Do not let objects or liquids enter the projector as they may touch dangerous voltage points or short-out parts that could result in a fire or electric shock.
9. See projector enclosure for safety related markings.
10. The projector should not be adjusted or repaired by anyone except properly qualified service personnel.

Precautions



Please follow all warnings, precautions and maintenance as recommended in this user's guide.



❖ When the lamp reaches the end of its life, the projector will not turn back on until the lamp module has been replaced. To replace the lamp, follow the procedures listed under "Replacing the Lamp" on page 81.

- ■ Warning - Do not look into the projector's lens when the lamp is on. The bright light may damage your eyes.
- ■ Warning - To reduce the risk of fire or electric shock, do not expose this projector to rain or moisture.
- ■ Warning - Please do not open or disassemble the projector as this may cause electric shock.
- ■ Warning - When replacing the lamp, please allow unit to cool down, and follow all replacement instructions. See page 81.
- ■ Warning - This projector will detect the life of the lamp itself. Please be sure to change the lamp when it shows warning messages.
- ■ Warning - Use the "Lamp Reset" function from the on-screen display "Options | Lamp Setting" menu after replacing the lamp module (see page 63).
- ■ Warning - When switching the projector off, please ensure the cooling cycle has been completed before disconnecting the power. Allow 90 seconds for the projector to cool down.
- ■ Warning - Do not use the lens cap when projector is in operation.
- ■ Warning - When the lamp is approaching the end of its life, the message "Lamp is approaching the end of its useful life" displays on the screen. Please contact your local reseller or service center to change the lamp as soon as possible.

Usage Notice

Do:

- ❖ Turn off the product before cleaning.
- ❖ Use a soft cloth moistened with a mild detergent to clean the display housing.
- ❖ Disconnect the power plug from the AC outlet if the product is not being used for a long period of time.

Do not:

- ❖ Block the ventilation slots and openings on the unit.
- ❖ Use abrasive cleaners, waxes or solvents to clean the unit.
- ❖ Use under the following conditions:
 - In extremely hot, cold or humid environments. Ensure that the ambient room temperature is within 5-40 °C and relative humidity is 10-85% (max.), non-condensing.
 - In areas susceptible to excessive dust and dirt.
 - Near any appliance that generates a strong magnetic field.
 - In direct sunlight.

Eye Safety Warnings



- Avoid staring directly into the projector's beam of light at all times.
- Minimize standing facing into the beam. Keep your back to the beam as much as possible.
- Using a stick or laser pointer is recommended to avoid the need for the presenter to enter the beam.
- Ensure that projectors are located out of the line of sight from the screen to the audience; this ensures that, when presenters look at the audience, they do not also have to stare at the projector lamp. The best way to achieve this is by ceiling-mounting the projector rather than placing it on floor or table top.
- When projector is used in a classroom, adequately supervise students when they are asked to point out something on the screen.
- In order to minimize the lamp power needed, use room blinds to reduce ambient light levels.

Product Features

This product is a single chip 0.7" XGA, 0.67 WUXGA and 0.65" WXGA series DLP® projector. Outstanding features include:

- ◆ Texas Instruments Single chip DLP® Technology
- ◆ Computer Compatibility:
 - Apple Macintosh, iMac, and VESA Standards:
UXGA, SXGA+, SXGA, WXGA, XGA, SVGA, VGA
- ◆ Video Compatibility:
 - NTSC, NTSC4.43
 - PAL/PAL-M/PAL-N/SECAM
 - SDTV and EDTV compatible
 - HDTV compatible (720p, 1080i, 1080p)
- ◆ Auto source detection with user definable settings
- ◆ Fully featured IR remote control with wired remote control
- ◆ User friendly multilingual On Screen Menu
- ◆ Advanced digital keystone correction and high quality full screen image re-scaling
- ◆ User friendly control panel
- ◆ Macintosh and PC compatible
- ◆ HDMI compatible
- ◆ Closed Captioning equipped
- ◆ DisplayPort compatible
- ◆ Full 3D Support
- ◆ Eco AV Mute
- ◆ Wireless dongle support (via VGA port)
- ◆ USB Charger

Package Overview

This projector comes with all the items shown below. Check to make sure your unit is complete. Contact your dealer immediately if anything is missing.



Projector with lens cap

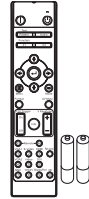

IR Remote Control
(with 2 x AAA Batteries)



Option Lens
(Standard lens/
Long throw lens/
Short throw lens)



Power Cord 1.8m

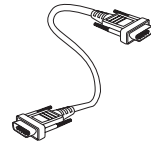

VGA Cable 1.8m



❖ Due to the difference in applications for each country, some regions may have different accessories.

For European warrant information please visit www.optomaeurope.com

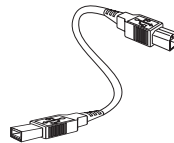

USB Cable
(A to B) 1.8m
(optional)

Documentation:

- User's Manual
- Warranty Card
- Quick Start Card
- WEEE Card

Product Overview Main Unit

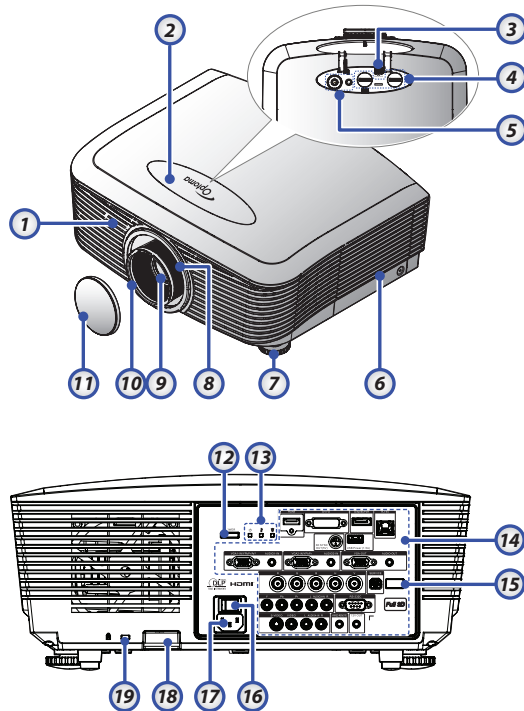

- | | |
|--|------------------------------|
| 1. Front IR Receiver | 10. Focus |
| 2. Top Cover | 11. Lens CAP |
| 3. Lens Release Button | 12. Power Button |
| 4. Vertical and Horizontal Lens
Shift Adjustment Controls | 13. LED Indicators |
| 5. Control Panel | 14. Input/Output Connections |
| 6. Lamp Cover | 15. Back IR Receiver |
| 7. Tilt-Adjustment foot | 16. Main Power Switch |
| 8. Zoom | 17. Power Socket |
| 9. Lens | 18. Security Bar |
| | 19. Kensington™ Lock |

Control Panel

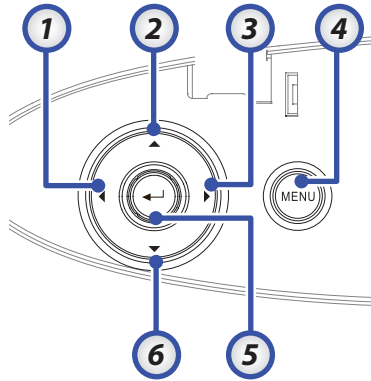

1. Source / ◀
2. Keystone + / ▲
3. Re-Sync / ▶
4. Menu
5. Enter
6. Keystone - / ▼

Rear View



❖ AUDIO2-IN:
Share with DVI
& BNC audio
input.

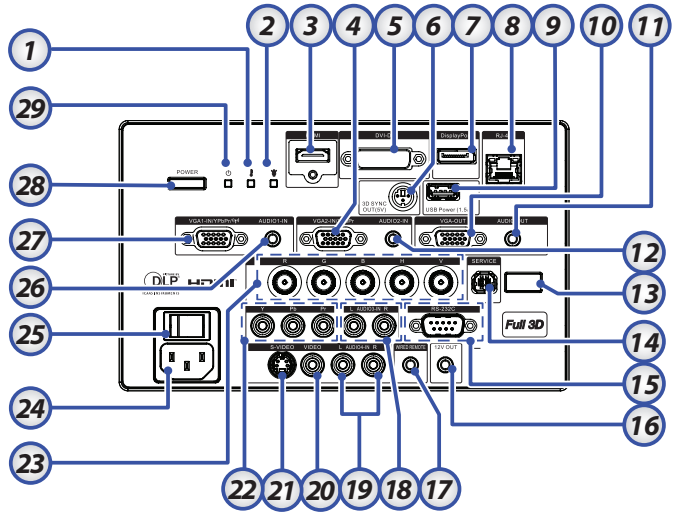

- | | |
|---------------------------------|--|
| 1. Temp LED | 16. 12V OUT Connector |
| 2. Lamp LED | 17. WIRED REMOTE (3.5mm jack) |
| 3. HDMI Connector | 18. AUDIO IN L/R RCA (YPbPr) Connectors |
| 4. VGA 2/ YPbPr Connector | 19. AUDIO IN L/R RCA (Video/ S-Video) Connectors |
| 5. DVI-D Connector | 20. VIDEO Connector |
| 6. 3D SYNC OUT | 21. S-VIDEO Connector |
| 7. DisplayPort | 22. YPbPr Connectors |
| 8. RJ-45 Connector | 23. BNC Connectors |
| 9. USB Power | 24. Power Socket |
| 10. VGA OUT | 25. Main Power Switch |
| 11. AUDIO OUT 3.5mm Jack | 26. AUDIO IN (VGA1) Connector |
| 12. AUDIO 2 IN (VGA2) Connector | 27. VGA 1/ SCART/ YPbPr Connector |
| 13. Back IR Receiver | 28. Power Button |
| 14. SERVICE | 29. Power LED |
| 15. RS-232 Connector | |

Remote Control



❖ Due to the difference in applications for each country, some regions may have different accessories.

1. Power On
2. Audio
3. Function 2 (Assignable)
4. Enter
5. Four Directional Select Keys
6. Display mode
7. AV Mute
8. V Keystone +/-
9. Information Panel
10. S-Video/2 (Number Button for password input)
11. Re-Sync
12. HDMI/3
13. DVI/6
14. 3D/0
15. DisplayPort/9
16. Video/5
17. YPbPr/8
18. BNC/7
19. VGA-2/4
20. VGA-1/1
21. Remote code 01~99
22. Remote code All
23. 12V Trigger On/Off
24. Format (Aspect Ratio)
25. Menu
26. Function 1 (Assignable)
27. Test Pattern
28. Power Off

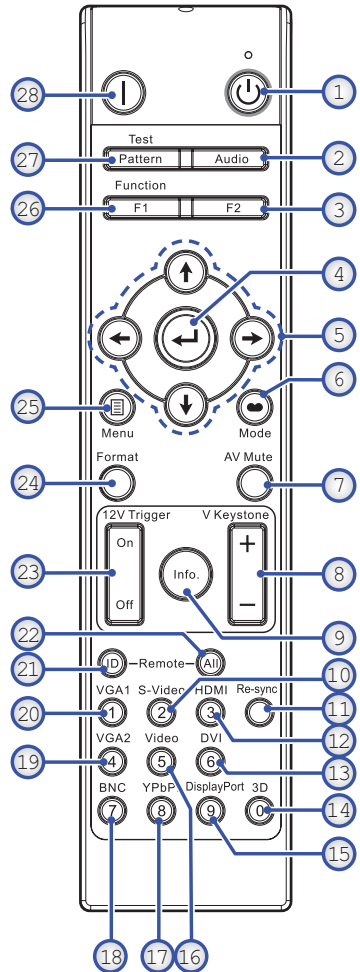

Connecting the Projector Connect to Computer / Notebook

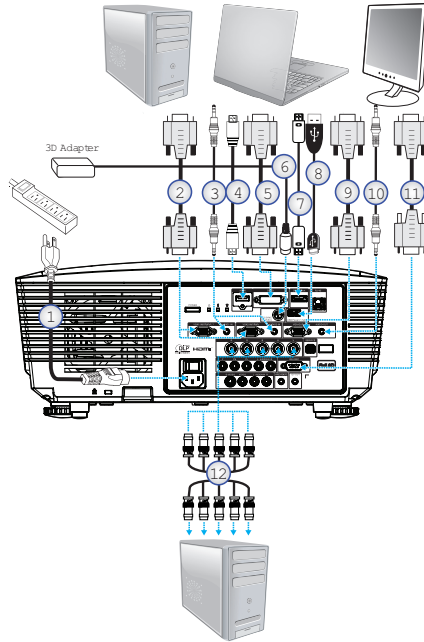

❖ Due to the difference in applications for each country, some regions may have different accessories.

❖ AUDIO2-IN: Share with DVI & BNC audio input.

1. Power Cord
2. VGA Cable
3. Audio-in Cable *
4. HDMI Cable *
5. DVI-D Cable *
6. 3D Sync Cable *
7. DisplayPort Cable *
8. USB Power Charger *
9. VGA-out Cable (Available for VGA1 VGA signal loop through)
10. Audio-out (Optional RCA to 3.5mm jack cable)
11. RS-232 Cable *
12. BNC Cable *

*(Optional accessory)

Connect to Video Sources



❖ Due to the difference in applications for each country, some regions may have different accessories.

❖ AUDIO2-IN: Share with DVI & BNC audio input.

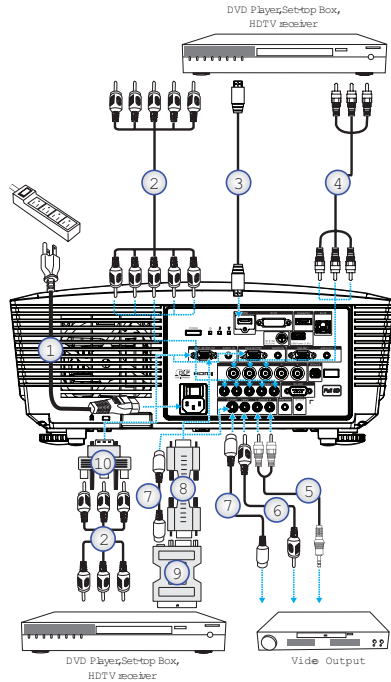

1. Power Cord
 2. Component Cable *
 3. HDMI Cable *
 4. BNC Cable *
 5. Audio-in Cable *
 6. Video Cable *
 7. S-Video Cable *
 8. VGA Cable
 9. SCART to RGB & S-Video Adapter *
 10. RGB to Component Adapter *
- *(Optional accessory)

Installing or Removing the Optional Lens

Caution

- Do not shake or place excessive pressure on the projector or the lens components as the projector and lens components contain precision parts.
- Before removing or installing the lens, be sure to turn off the projector, wait until the cooling fans stop, and turn off the main power switch.
- Do not touch the lens surface when removing or installing the lens.
- Keep fingerprints, dust or oil off the lens surface. Do not scratch the lens surface.
- Work on a level surface with a soft cloth under it to avoid scratching.
- If you remove and store the lens, attach the lens cap to the projector to keep off dust and dirt.

Removing the Existing Lens From the Projector

1. Push down and release the top cover to open.
2. Push the LENSE RELEASE button to the unlock position.
3. Grasp the lens.
4. Rotate the lens counterclockwise. The existing lens will be disengaged.



❖ Removal of the plastic body cap before inserting a lens for the first time.

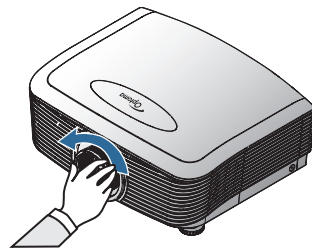
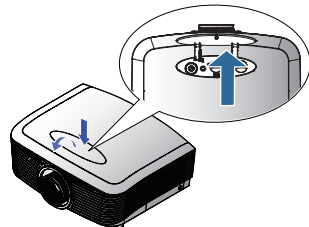

5. Pull out the existing lens slowly.

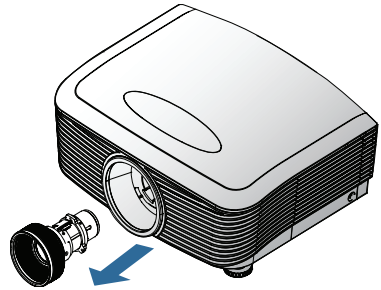

Installing the New Lens

Remove both end caps from the lens.



❖ Electrical contact pins should be in the direction as shown in the picture.

1. Align the notches and correctly position the electrical contact pad as shown in the picture.

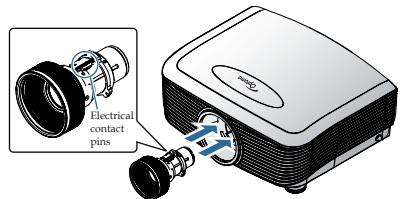

2. Rotate the lens clockwise until you feel it click into place.

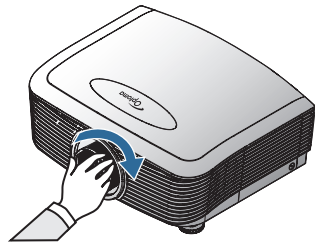

Powering On/Off the Projector

Powering On the Projector

1. Remove the lens cover.
2. Connect the power cord to the projector.
3. Turn On the connected devices.
4. Ensure the Power LED turns red and then press the power button to turn On the projector.
The Power LED will now flash blue.



- ❖ Turn on the projector first and then select the signal sources.

The startup screen will display in approximately 30 seconds. The first time you use the projector, you can select your preferred language and Power Mode setup after the startup screen display.



If the connected device is a PC, ensure the display is set to output to the projector via the connected output. (Check the user manual of the PC to determine the appropriate Fn key combination to change display output.)

Installation

See Security Setting on page 46 if security lock is enabled.



5. If more than one input device is connected, press the "Source" button sequentially to switch between devices.
For direct source selection, see page 29.

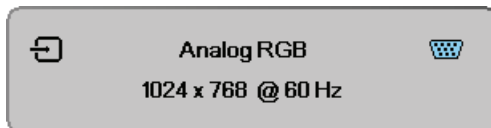

Powering Off the Projector

1. Press **POWER** to turn off the projector lamp, a message displays on the projector's screen.



Power Off?

Press power key again.

2. Press **POWER** again to confirm, otherwise the message disappears after 15 seconds.
3. The cooling fans continue to operate for about 180 seconds for cooling cycle and the Power Led will turn blue. When the light is solid red, the projector has entered standby mode.
(If you wish to turn the projector back on, you must wait until the projector has completed the cooling cycle and has entered standby mode. Once in standby mode, simply press **POWER** to restart the projector.)
4. Turn off the main power switch. Disconnect the power cord from the electrical outlet and the projector.
5. Do not turn on the projector immediately following a power off procedure.

Warning Indicator

- ❖ When the LAMP LED indicator lights red, the projector will automatically shut itself down. Please contact your local reseller or service center. See pages 79-80.
- ❖ When the TEMP LED is on a steady (not flashing) red, the projector will automatically shut itself down. Under normal conditions, the projector can be switched on again after it has cooled down. If the problem persists, you should contact your local dealer or our service center. See pages 79-80.
- ❖ When the TEMP LED flashes red, it indicates the fan has failed. Please contact your local dealer or our service center. See pages 79-80.

Adjusting the Projected Image Adjusting the Projector's Height

The projector is equipped with elevator foot for adjusting the image height.

To raise the image:

Use screw in foot ❶ to rise the image to the desired height angle and fine-tune the display angle.

To lower the image:

Use screw in foot ❶ to lower the image to the desired height angle and to fine-tune the display angle.

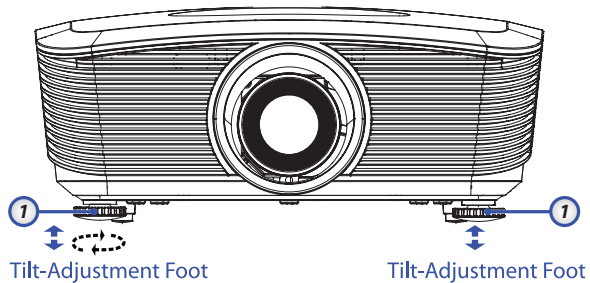

Adjusting Projected Image Position Using Lens Shift



- ❖ Suggest to loosen the screw before lens shift adjustment and tighten up after finished adjustment.

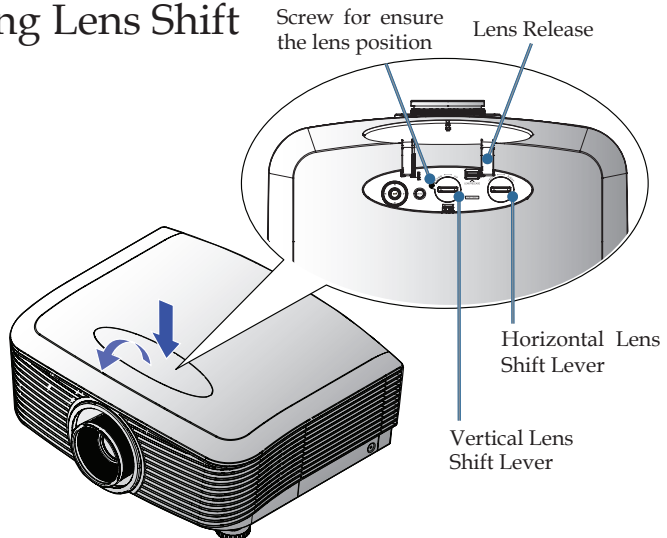

Installation

The Lens Shift function can be used to adjust the position of the projected image either horizontally or vertically within the range detailed below.

Adjusting the vertical image position

The vertical image height can be adjusted between 50% and -10% for XGA, 55% and -15% for WXGA/WUXGA of offset position. Please consult the Lens Shift Range diagram below for further clarification.

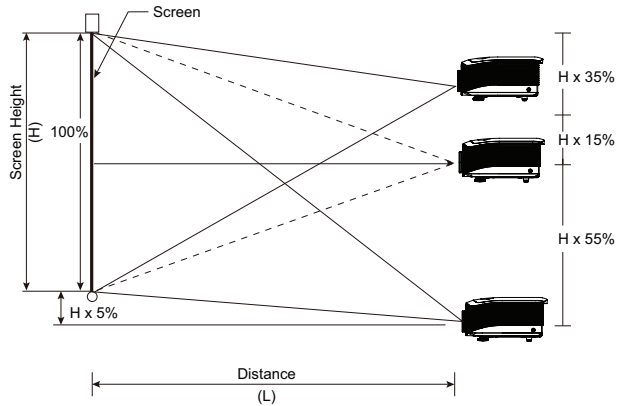

WXGA/WUXGA

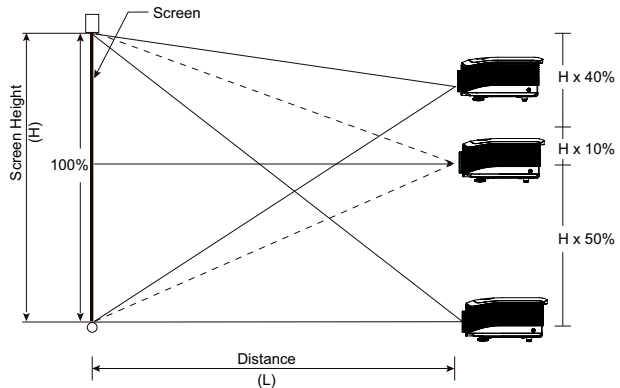

XGA

Adjusting the horizontal image position

With the lens in the center position the horizontal image position can be adjusted to the left or right by up to a maximum of 5% of the image width. Please consult the Lens Shift Range diagram below for further clarification.

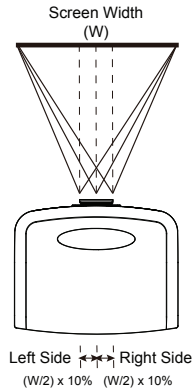

Lens Shift Range Diagram

When W and H at 0% offset position
 The max. H up shift= $H \times 55\%$
 The max. H down shift= $H \times 15\%$
 The max. W shift= $W \times 5\%$

When max. W shift is $W \times 5\%$
 Max. H shift= $H \times 50\%$
 When max. H shift is $H \times 55\%$
 Max. W shift= $H \times 0\%$

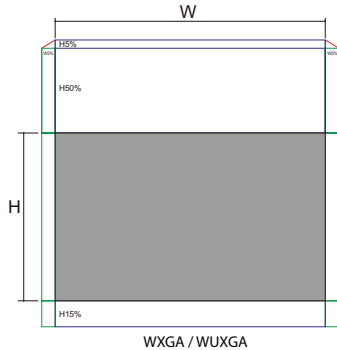

When W and H at 0% offset position
 The max. H up shift= $H \times 50\%$
 The max. H down shift= $H \times 10\%$
 The max. W shift= $W \times 5\%$

When max. W shift is $W \times 5\%$
 Max. H shift= $H \times 45\%$
 When max. H shift is $H \times 50\%$
 Max. W shift= $H \times 0\%$

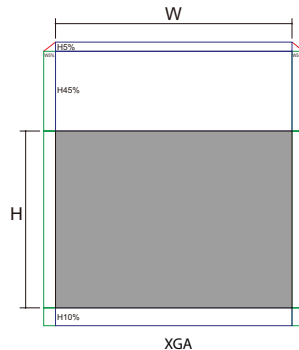

Installation

Adjusting the Zoom / Focus

You may turn the zoom ring to zoom in or out. To focus the image, rotate the focus ring until the image is clear. The projector will focus at distances. See pages 25-27.

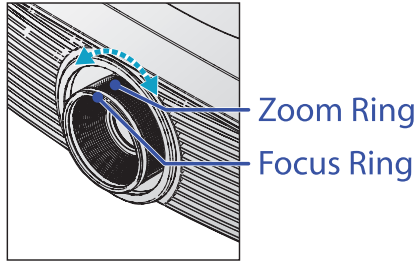

Use the keystone buttons to correct image distortion. They can be found on the remote control and on the projector's control panel.

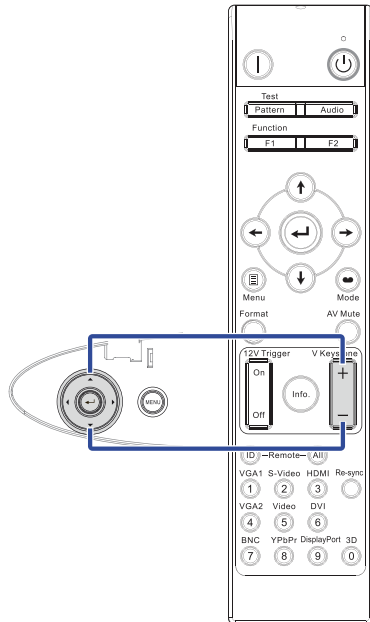

Adjusting Projection Image Size (XGA)

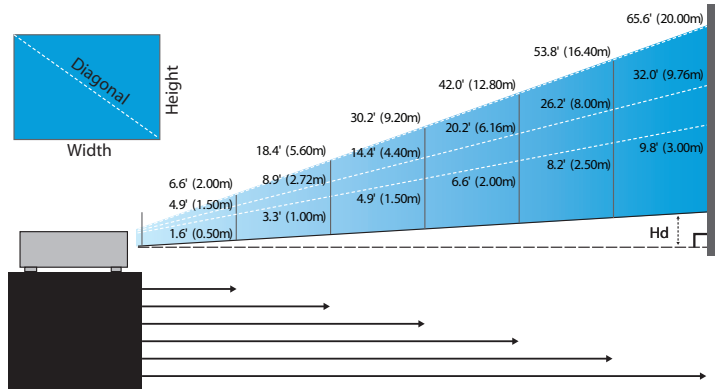

STD lens: offset=50%

Screen (Diagonal)	Max.	46.1" (117.2cm)	83.7" (212.5cm)	135.3" (343.8cm)	189.5" (481.3cm)	246.1" (625.0cm)	300.2" (762.5cm)
	Min.	36.9" (93.8cm)	66.9" (170.0cm)	108.3" (275.0cm)	151.6" (385.0cm)	196.9" (500.0cm)	240.2" (610.0cm)
Screen size	Max (WxH).	36.9"x27.7" 93.8x70.3cm	66.9"x50.2" 170.0x127.5cm	108.3"x81.2" 275.0x206.3cm	151.6"x113.7" 385.0x288.8cm	196.9"x147.6" 500.0x375.0cm	240.2"x180.1" 610.0x457.5cm
	Min. (WxH)	29.5"x22.1" 75.0x56.3cm	53.5"x40.2" 136.0x102.0cm	86.6"x65.0" 220.0x165.0cm	121.3"x90.9" 308.0x231.0cm	157.5"x118.1" 400.0x300.0cm	192.1"x144.1" 488.0x366.0cm
Distance		4.9' (1.50m)	8.9' (2.72m)	14.4' (4.40m)	20.2' (6.16m)	26.2' (8.00m)	32.0' (9.76m)

Long lens: offset=50%

Screen (Diagonal)	Max.	49.2" (125.0cm)	137.8" (350.0cm)	226.4" (575.0cm)	315.0" (800.0cm)	403.5" (1025.0cm)	492.1" (1250.0cm)
	Min.	32.8" (83.3cm)	91.9" (233.3cm)	150.9" (383.3cm)	210.0" (533.3cm)	269.0" (683.3cm)	328.1" (833.3cm)
Screen size	Max (WxH).	39.4"x29.5" 100.0x75.0cm	110.2"x82.7" 280.0x210.0cm	181.1"x135.8" 460.0x345.0cm	252.0"x189.0" 640.0x480.0cm	322.8"x242.1" 820.0x615.0cm	393.7"x295.3" 1000.0x750.0cm
	Min. (WxH)	26.2"x19.7" 66.7x50.0cm	73.5"x55.1" 186.7x140.0cm	120.7"x90.6" 306.7x230.0cm	168.0"x126.0" 426.7x320.0cm	215.2"x161.4" 546.7x410.0cm	262.5"x196.9" 666.7x500.0cm
Distance		6.6' (2.00m)	18.4' (5.60m)	30.2' (9.20m)	42.0' (12.80m)	53.8' (16.40m)	65.6' (20.00m)

Short lens: offset=50%

Screen (Diagonal)	30.8" (78.1cm)	61.5" (156.3cm)	92.3" (234.4cm)	123.0" (312.5cm)	153.8" (390.6cm)	184.5" (468.8cm)
Screen size	24.6"x18.5" 62.5x46.3cm	49.2"x36.9" 125.0x93.8cm	73.8"x55.4" 187.5x40.6cm	98.4"x73.8" 250.0x187.5cm	123.0"x92.3" 312.5x234.4cm	147.6"x110.7" 375.0x281.5cm
Distance	1.6' (0.50m)	3.3' (1.00m)	4.9' (1.50m)	6.6' (2.00m)	8.2' (2.50m)	9.8' (3.00m)

Adjusting Projection Image Size (WXGA)

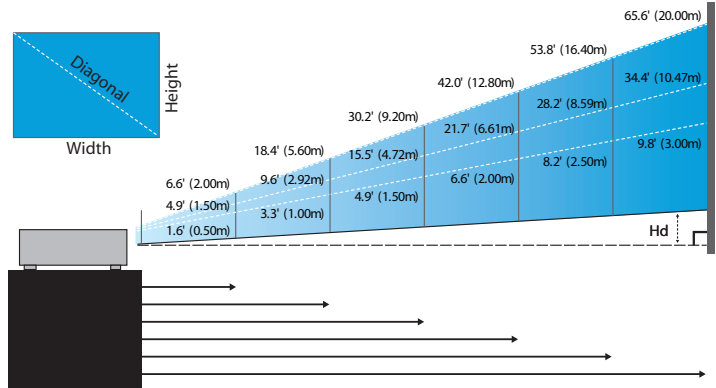

STD lens: offset=55%

Screen (Diagonal)	Max.	43.0" (109.2cm)	83.7" (212.6cm)	135.3" (343.6cm)	189.4" (481.2cm)	246.2" (625.3cm)	300.1" (762.1cm)
	Min.	34.3" (87.1cm)	66.8" (169.6cm)	107.9" (274.2cm)	151.2" (384.0cm)	196.5" (499.0cm)	239.5" (608.2cm)
Screen size	Max (WxH).	36.5"x22.8" 92.6x57.9cm	71.0"x44.4" 180.2x112.7cm	114.7"x71.7" 291.4x182.1cm	160.6"x100.4" 408.0x255.0cm	208.8"x130.5" 530.2x331.4cm	254.4"x159.0" 646.3x403.9cm
	Min. (WxH)	29.1"x18.2" 73.9x46.2cm	56.6"x35.4" 143.8x89.9cm	91.5"x57.2" 232.5x145.3cm	128.2"x80.1" 325.6x203.5cm	166.6"x104.1" 423.2x264.5cm	203.1"x126.9" 515.8x322.4cm
Hd	Max.	1.1" (2.9cm)	2.2" (5.6cm)	3.6" (9.1cm)	5.0" (12.8cm)	6.5" (16.6cm)	8.0" (20.2cm)
	Min.	0.9" (2.3cm)	1.8" (4.5cm)	2.9" (7.3cm)	4.0" (10.2cm)	5.2" (13.2cm)	6.3" (16.1cm)
Distance		4.9' (1.50m)	9.6' (2.92m)	15.5' (4.72m)	21.7' (6.61m)	28.2' (8.59m)	34.4' (10.47m)

Long lens: offset=55%

Screen (Diagonal)	Max.	45.7" (116.2cm)	128.1" (325.3cm)	210.4" (534.4cm)	292.7" (743.6cm)	375.1" (952.7cm)	457.4" (1161.8cm)
	Min.	30.4" (77.3cm)	85.2" (216.5cm)	140.0" (355.7cm)	194.8" (494.9cm)	249.6" (634.1cm)	304.4" (773.3cm)
Screen size	Max (WxH).	38.8"x24.2" 98.5x61.6cm	108.6"x67.9" 275.9x172.4cm	178.4"x111.5" 453.2x283.3cm	248.2"x155.2" 630.5x394.1cm	318.1"x198.8" 807.9x504.9cm	387.9"x242.4" 985.2x615.8cm
	Min. (WxH)	25.8"x16.1" 65.6x41.0cm	72.3"x45.2" 183.6x114.8cm	118.8"x74.2" 301.6x188.5cm	165.2"x103.3" 419.7x262.3cm	211.7"x132.3" 537.7x336.1cm	258.2"x161.4" 655.7x409.8cm
Hd	Max.	1.2" (3.1cm)	3.4" (8.6cm)	5.6" (14.2cm)	7.8" (19.7cm)	9.9" (25.2cm)	12.1" (30.8cm)
	Min.	0.8" (2.0cm)	2.3" (5.7cm)	3.7" (9.4cm)	5.2" (13.1cm)	6.6" (16.8cm)	8.1" (20.5cm)
Distance		6.6' (2.00m)	18.4' (5.60m)	30.2' (9.20m)	42.0' (12.80m)	53.8' (16.40m)	65.6' (20.00m)

Short lens: offset=55%

Screen (Diagonal)	28.7" (72.8cm)	57.3" (145.6cm)	86.0" (218.4cm)	114.6" (291.2cm)	143.3" (364.0cm)	172.0" (436.8cm)
Screen size	24.3"x15.2" 61.7x38.6cm	48.6"x30.4" 123.5x77.2cm	72.9"x45.6" 185.2x115.7cm	97.2"x60.8" 246.9x154.3cm	121.5"x75.9" 308.6x192.9cm	145.8"x91.1" 370.4x231.5cm
Hd	0.8" (1.9cm)	1.5" (3.9cm)	2.3" (5.8cm)	3.0" (7.7cm)	3.8" (9.6cm)	4.6" (11.6cm)
Distance	1.6' (0.50m)	3.3' (1.00m)	4.9' (1.50m)	6.6' (2.00m)	8.2' (2.50m)	9.8' (3.00m)

Adjusting Projection Image Size (WUXGA)

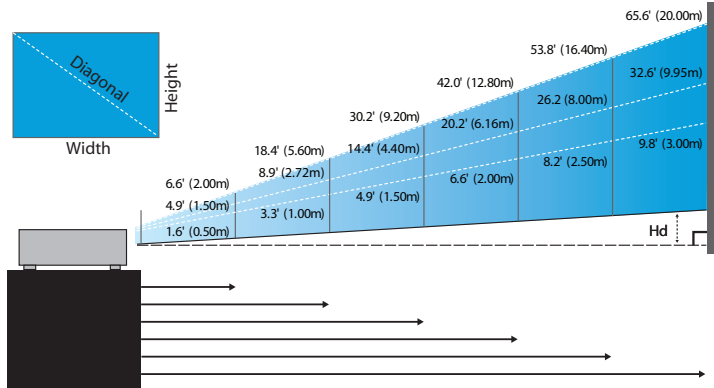

STD lens: offset=55%

Screen (Diagonal)	Max.	45.2" (114.9cm)	82.0" (208.3cm)	132.6" (336.9cm)	185.7" (471.7cm)	241.2" (612.6cm)	300.0" (761.9cm)
	Min.	36.1" (91.7cm)	65.4" (166.2cm)	105.8" (268.8cm)	148.2" (376.4m)	192.4" (488.8cm)	239.4" (608.0cm)
Screen size (WxH)	Max	38.3"x24.0" 97.4x60.9cm	69.5"x43.5" 176.6x110.4cm	112.5"x70.3" 285.7x178.6cm	157.5"x98.4" 400.0x250.0cm	204.5"x127.8" 519.5x324.7cm	254.4"x159.0" 646.1x403.8cm
	Min.	30.6"x19.1" 77.7x48.6cm	53.5"x34.7" 140.9x88.1cm	89.8"x56.1" 228.0x142.5cm	125.7"x78.3" 319.2x199.5cm	163.2"x102.0" 414.5x259.1cm	203.0"x126.9" 515.5x322.2cm
Hd	Max.	1.2" (3.0cm)	2.2" (5.5cm)	3.5" (8.9cm)	4.9" (12.5cm)	6.4" (16.2cm)	7.9" (20.2cm)
	Min.	1.0" (2.4cm)	1.7" (4.4cm)	2.8" (7.1cm)	3.9" (10.0cm)	5.1" (13.0cm)	6.3" (16.1cm)
Distance		4.9' (1.50m)	8.9' (2.72m)	14.4' (4.40m)	20.2' (6.16m)	26.2' (8.00m)	32.6' (9.95m)

Long lens: offset=55%

Screen (Diagonal)	Max.	48.1" (122.2cm)	134.7" (342.2cm)	221.3" (562.1cm)	307.9" (782.1cm)	394.5" (1002.1cm)	481.1" (1222.0cm)
	Min.	32.0" (81.3cm)	89.7" (227.7cm)	147.3" (374.1cm)	204.9" (520.5cm)	262.6" (666.9cm)	320.2" (813.3cm)
Screen size (WxH)	Max	40.8"x25.5" 103.6x64.8cm	114.2"x71.4" 290.2x181.3cm	187.7"x117.3" 476.7x297.9cm	261.1"x163.2" 663.2x414.5cm	334.5"x209.1" 849.7x531.1cm	408.0"x255.0" 1036.0x647.7cm
	Min.	27.2"x17.0" 69.0x43.1cm	76.0"x47.5" 193.1x120.7cm	124.9"x78.1" 317.2x198.3cm	173.8"x108.6" 441.4x275.9cm	222.6"x139.2" 565.5x353.4cm	271.5"x169.7" 689.7x431.0cm
Hd	Max.	1.3" (3.2cm)	3.6" (9.1cm)	5.9" (14.9cm)	8.2" (20.7cm)	10.5" (26.6cm)	12.7" (32.4cm)
	Min.	0.8" (2.2cm)	2.4" (6.0cm)	3.9" (9.9cm)	5.4" (13.8cm)	7.0" (17.7cm)	8.5" (21.6cm)
Distance		6.6' (2.00m)	18.4' (5.60m)	30.2' (9.20m)	42.0' (12.80m)	53.8' (16.40m)	65.6' (20.00m)

Short lens: offset=55%

Screen (Diagonal)	30.1" (76.6cm)	60.3" (153.1cm)	90.4" (229.7cm)	120.6" (306.3cm)	150.7" (382.9cm)	180.9" (459.4cm)
Screen size (WxH)	25.6"x16.0" 64.9x40.6cm	51.1"x32.0" 129.9x81.2cm	76.7"x47.9" 194.8x121.8cm	102.3"x63.9" 259.7x162.3cm	127.8"x79.9" 324.7x202.9cm	153.4"x95.9" 389.6x243.5cm
Hd	0.8" (2.0cm)	1.6" (4.1cm)	2.4" (6.1cm)	3.2" (8.1cm)	4.0" (10.1cm)	4.8" (12.2cm)
Distance	1.6' (0.50m)	3.3' (1.00m)	4.9' (1.50m)	6.6' (2.00m)	8.2' (2.50m)	9.8' (3.00m)

Control Panel

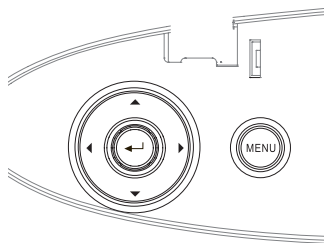

Using the Control Panel

▲/Keystone+ (Up arrow)	<ul style="list-style-type: none">• Adjust the image Keystone positively.• Navigates and changes settings in the OSD.
◀/Source (Left arrow)	<ul style="list-style-type: none">• Press Source to select an input signal.• Navigates and changes settings in the OSD.
Enter	Confirm your item selection.
▶/Re-Sync (Right arrow)	<ul style="list-style-type: none">• Automatically synchronizes the projector to the input source.• Navigates and changes settings in the OSD.
Menu	Press Menu to launch the on-screen display (OSD) menu. To exit OSD, Press Menu again.

Remote Control

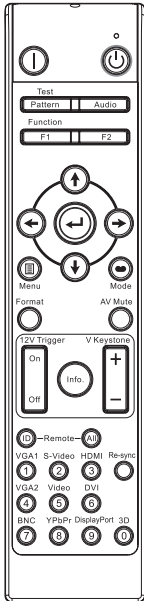

❖ Due to the difference in applications for each country, some regions may have different accessories.

Using the Remote Control

Power Off	Refer to the “Powering Off the Projector” on page 20.
Power On 	Refer to the “Powering On the Projector” on page 18.
Test Pattern	Refer to the “Test Pattern” on page 57.
Audio	Refer to the “Audio Settings” on page 44.
Function 1 (F1)	Refer to the “Function 1” on page 60.
Function 2 (F2)	Refer to the “Function 2” on page 60.
Four Directional Select Keys	Use ▲▼◀▶ to select items or make adjustments to your selection.
Enter	Confirm your item selection.
Menu	Press Menu to launch the on-screen display (OSD) menu. To exit OSD, Press Menu again.
Mode	Refer to the “Display Mode” on page 34.
Format	Refer to the “Format” on page 40.
AV Mute	Momentarily turns off/on the audio and video.
12V Trigger On/Off	Refer to the “12V Trigger” on page 57.
Info.	Refer to the “Information” on page 58.
V Keystone +/-	Adjusts image distortion caused by tilting the projector. (±30 degrees)

User Controls

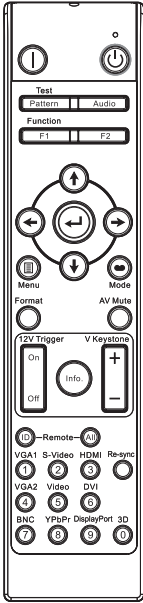

❖ Due to the difference in applications for each country, some regions may have different accessories.

Using the Remote Control

Remote ID	Press until Power LED is flashing then press 01~99 to set the particular remote code.
Remote All	Press to set remote code to all.
VGA1	Press VGA1 to choose source from VGA- IN connector.
S-Video	Press S-Video to choose S-Video source.
HDMI	Press HDMI to choose HDMI source.
Re-sync	Automatically synchronizes the projector to the input source.
VGA2	Press VGA2 to choose source from VGA- IN connector.
Video	Press Video to choose Composite video source.
DVI	Press DVI to choose source from DVI-D connector.
BNC	Press BNC to choose BNC source.
YPbPr	Press YPbPr to choose YPbPr source.
DisplayPort	Press DisplayPort to choose DisplayPort source.
3D	Press 3D to turn on/off 3D menu.

On-screen Display Menus

The Projector has multilingual On-screen Display menus that allow you to make image adjustments and change a variety of settings. The projector will automatically detect the source.

How to operate

1. To open the OSD menu, press **Menu** on the Remote Control or Projector Keypad.
2. When OSD is displayed, use ◀▶ keys to select any item in the main menu. While making a selection on a particular page, press ▼ or **Enter** to enter sub menu.
3. Use ▲▼ keys to select the desired item and adjust the settings by ▶ key.
4. Select the next item to be adjusted in the sub menu and adjust as described above.
5. Press **Enter** to confirm, and the screen will return to the main menu.
6. To exit, press **Menu** again. The OSD menu back to last level projector will automatically save the new settings.

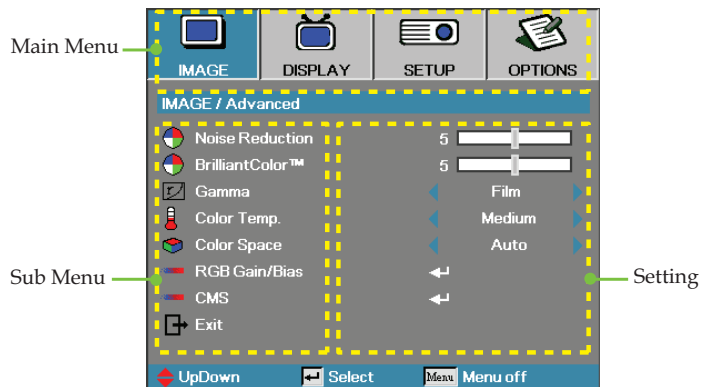

Menu Tree

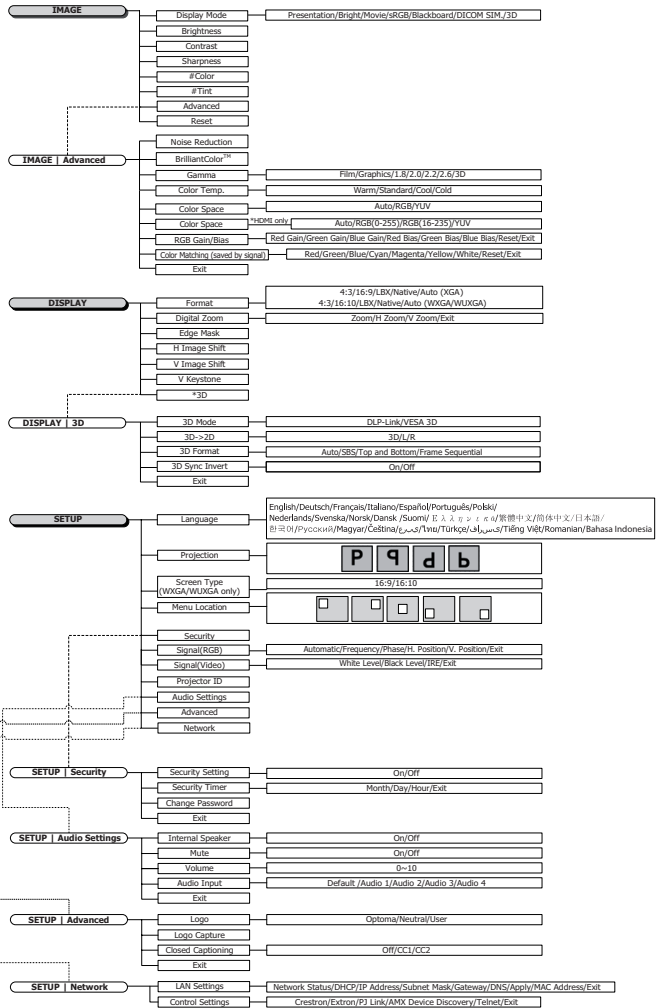

❖ (#) “Color” and “Tint” is only supported in for YUV video sources..

❖ (*) “3D” is only available when a compatible signal is supplied..

User Controls

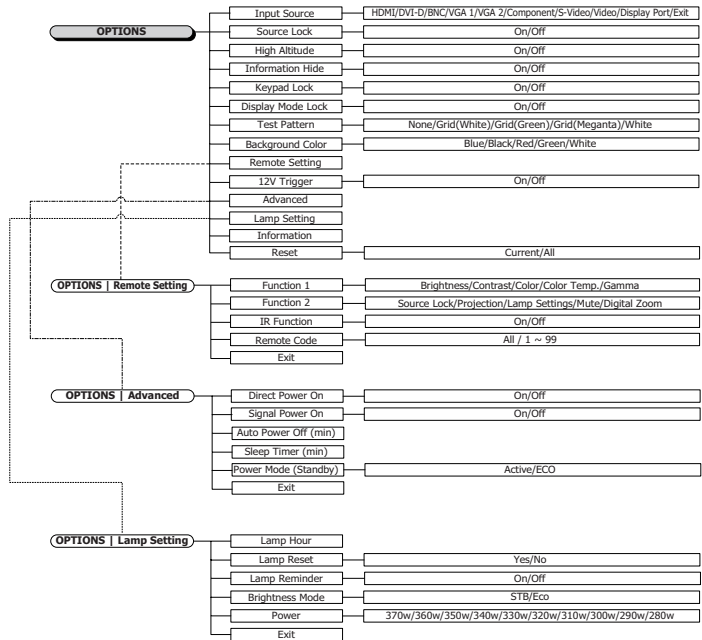

Image

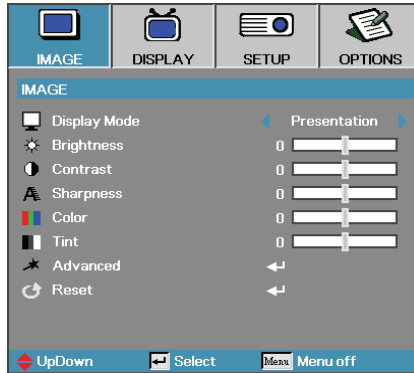

Display Mode

There are many factory presets optimized for various types of images.

- ▶ Presentation: Good color and brightness from PC input.
- ▶ Bright: Maximum brightness from PC input.
- ▶ Movie: For home theater.
- ▶ sRGB: Standardised accurate color.
- ▶ Blackboard: This mode should be selected to achieve optimum color settings when projecting onto a blackboard (green).
- ▶ DICOM SIM: This display mode simulates the grayscale/gamma performance of equipment used for "Digital Imaging and Communications in Medicine" (DICOM).

Important: This mode should NEVER be used for medical diagnosis, it is for education/training purposes only.

- ▶ 3D: User adjustable setting for 3D viewing.

Brightness

Adjust the brightness of the image.

- ▶ Press ◀ to darken image.
- ▶ Press ▶ to lighten the image.

Contrast

The contrast controls the degree of difference between the lightest and darkest parts of the picture.

- ▶ Press ◀ to decrease the contrast.
- ▶ Press ▶ to increase the contrast.

Image

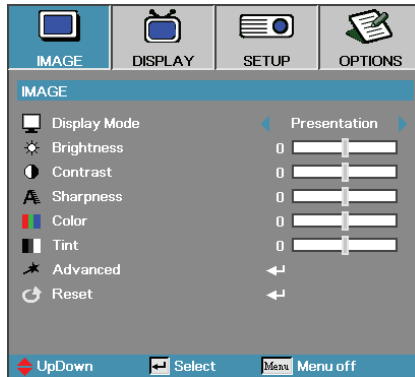

Sharpness

Adjusts the sharpness of the image.

- ▶ Press ◀ to decrease the sharpness.
- ▶ Press ▶ to increase the sharpness.

Color

Adjusts a video image from black and white to full color saturation.

- ▶ Press ◀ to decrease the amount of color in the image.
- ▶ Press ▶ to increase the amount of color in the image.

Tint

Adjusts the color balance of red and green.

- ▶ Press ◀ to increase the amount of green in the image.
- ▶ Press ▶ to increase the amount of red in the image.

Advanced

Enter the Advanced menu. Select advanced display options such as Noise Reduction, BrilliantColor™, Gamma, Color Temp., Color Space, RGB Gain/Bias, Color Matching, and Exit. See page 36 for more information.

Image | Advanced

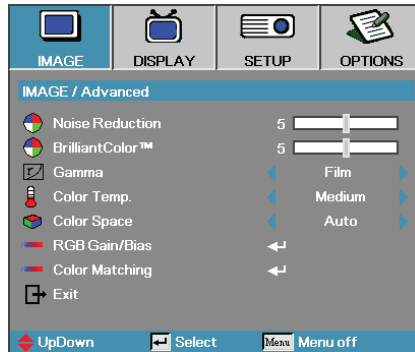

Noise Reduction

The motion Adaptive Noise Reduction reduces the amount of visible noise in interlaced signals. The range is from "0" to "10". (0=Off)

BrilliantColor™

This adjustable item utilizes a new color-processing algorithm and system level enhancements to enable higher brightness while providing true, more vibrant colors in picture. The range is from 0 to 10. If you prefer a stronger enhanced image, adjust toward the maximum setting. For a smoother, more natural image, adjust toward the minimum setting.

Gamma

Choose the Gamma type from Film, Graphics, 1.8, 2.0, 2.2, 2.6 or 3D.

Color Temp

Adjust the color temperature. Cold temperature, the screen looks colder; with Warm temperature, the screen looks warmer.

Color Space

Select an appropriate color matrix type from AUTO, RGB, YUV.

- ▶ For HDMI only: Select color matrix from Auto, RGB (0-255), RGB (16-235), YUV.

RGB Gain/Bias

This setting is used to adjust the balance of red, green and blue in grays/white. Enter the RGB Gain/Bias menu. Select the Red/Green/Blue Gain for brightness adjustments and Bias for contrast adjustments for the whole picture. See page 37 for more details

Color Matching

Enter the Color Matching menu. See page 38 for more details.

Image | Advanced | RGB Gain/ Bias

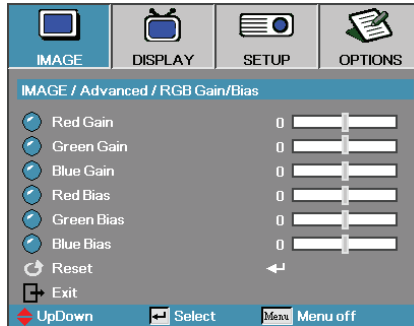

This setting is used to adjust the balance of red, green and blue in grays/white.

Gain

Set RGB Gain to adjust the Brightness of the follow in brighter shades:

- ▶ Red – balance the gain value for red.
- ▶ Green – balance the gain value for green.
- ▶ Blue – balance the gain value for blue.

Bias

Set RGB Bias to adjust the Brightness of the follow in darker shades:

- ▶ Red – balance the bias value for red.
- ▶ Green – balance the bias value for green.
- ▶ Blue – balance the bias value for blue.

Image | Advanced | Color Matching

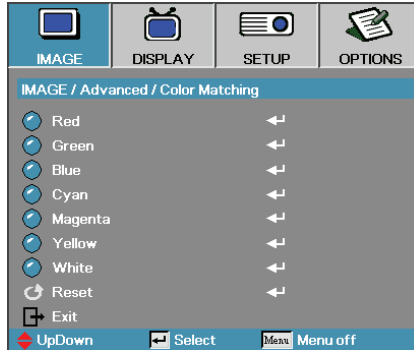

Colors (Except White)

Press ▲▼ to select a color and press Enter to adjust the hue, saturation, and gain settings.



- ❖ Green, Blue, Cyan, Yellow, Magenta can be separate adjust by each color HSG.

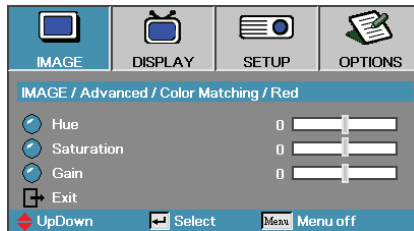

Press ▲▼ to select Hue, Saturation, or Gain and press ◀▶ to adjust the settings.

Image | Advanced | Color Matching

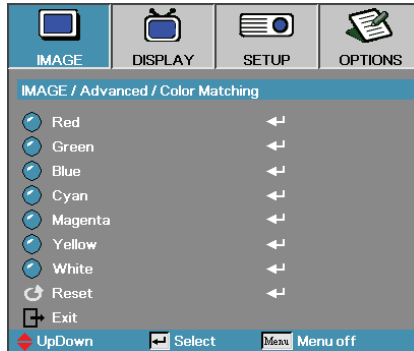

White

Press ▲▼ to select White and press Enter.



❖ White can be adjust Red, Green, Blue color by each.

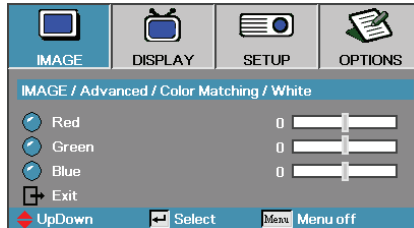

Press ▲▼ to select Red, Green, or Blue and press ◀▶ to adjust the settings.

Reset

Reset all Color Setting values to the factory default.

Display

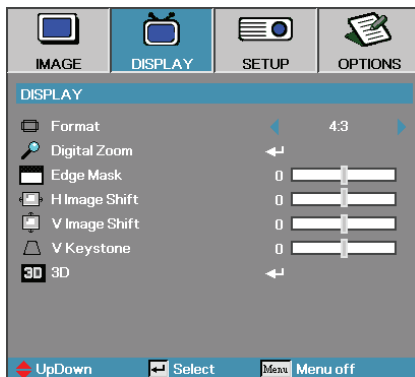

Format

Use this function to choose your desired aspect ratio.

- ▶ 4:3: This format is for 4x3 input sources not enhanced for Wide screen TV.
- ▶ 16:9 (XGA) | 16:10 (WXGA/WUXGA): This format is for 16x9 input sources, like HDTV and DVD enhanced for Wide screen TV.
- ▶ LBX: This format is for non-16x9, letterbox source and for users who use an external 16x9 lens to display 2.35:1 aspect ratio using full resolution.
- ▶ Native: Depends on the resolution of the input source - No scaling is performed.
- ▶ Auto: Automatically selects the appropriate format.

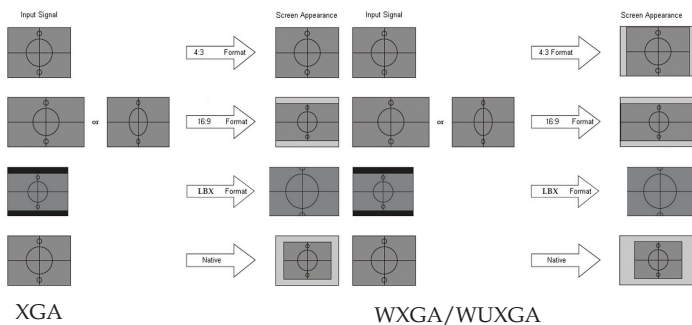

Display

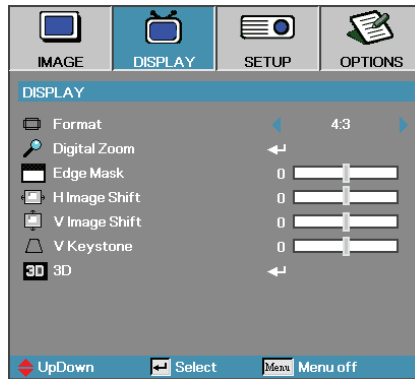

Digital Zoom

- ▶ Press ◀ to reduce the size of the image.
- ▶ Press ▶ to magnify an image on the projected screen.

Edge Mask

Edge Mask function removes the noise in a video image. Edge Mask the image to remove video encoding noise on the edge of video source.

H Image Shift

Shifts the projected image position horizontally.

- ▶ Press ◀ to move the image left on the projected screen.
- ▶ Press ▶ to move the image right on the projected screen.

V Image Shift

Shifts the projected image position vertically.

- ▶ Press ▶ to move the image up on the projected screen.
- ▶ Press ◀ to move the image down on the projected screen.

V Keystone

Press ◀ or ▶ to compensate for vertical images distortion when the projector is positioned at an angle to the screen.

3D

Enter the 3D menu. Select 3D options such as 3D Mode, 3D->2D, 3D Format, and 3D Sync Invert. See page 42 for more information.

Display | 3D

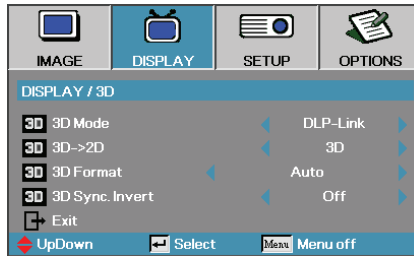

3D Mode

- ▶ DLP Link: Select DLP Link to use optimized settings for DLP Link 3D Glasses.
- ▶ VESA 3D: Select VESA 3D to use optimized settings for IR-based 3D images.

3D→2D

Press ◀ or ▶ to select projector display 3D content in 2D (Left) or 2D(Right) without using 3D glasses to enjoy 3D content. This setting can also be used for dual projector passive 3D installations.

3D Format

- ▶ Auto: When a 3D identification signal is detected, the 3D format is selected automatically. (For HDMI 1.4 3D sources only)
- ▶ SBS: Display 3D signal in Side-by-Side format.
- ▶ Top and Bottom: Display 3D signal in Top and Bottom format.
- ▶ Frame Sequential: Display 3D signal in Frame Sequential format.

3D Sync. Invert

Press ◀ or ▶ to enable or disable the 3D Sync invert function to invert images.

Setup

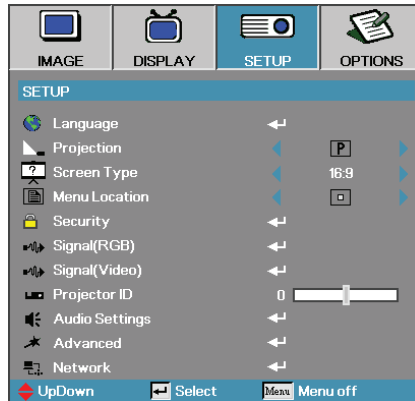

Language

Enter the Language menu. Select the multilingual OSD menu.
See page 45 for more information.

Projection

Select projection method:

- ▶ **P** Front Desktop
The factory default setting.
- ▶ **9** Rear Desktop
When you select this function, the projector reverses the image so you can project from behind a translucent screen.
- ▶ **d** Front Ceiling
When you select this function, the projector turns the image upside down for ceiling-mounted projection.
- ▶ **b** Rear Ceiling
When you select this function, the projector reverses and turns the image upside down at same time. You can project from behind a translucent screen with ceiling mounted projection.

Screen Type (WXGA/WUXGA only)

Press ◀▶ to set the aspect ratio to 16:9 or 16:10. This function only supports WXGA/WUXGA.

Menu Location

Choose the menu location on the display screen.

Setup

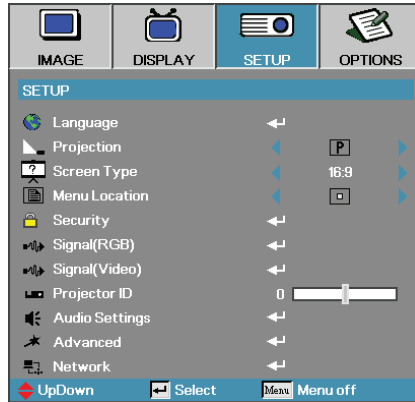

Security

Enter the Security menu. Access the projector's security features. See page 46 for more information.

Signal (RGB)

Enter the Signal (RGB) menu. Set projector signal properties. The function is available when input source is support VGA 1/VGA 2/BNC. See page 49 for more information.

Signal(Video)

Enter the Signal (Video) menu. Set projector signal properties. The function is available when input source is support Video signal. See page 50 for more information.

Projector ID

Select a two digit projector ID from All through 99.

Audio Settings

Enter the Audio menu. Set audio level properties. See page 51 for more information.

Advanced

Enter the Advanced menu. Select the screen display during startup. See page 52 for more information.



Network

Allows access to controls for web, PJ-Link, and IP commands. See page 53 for more information.

Setup | Language



Language

Choose the multilingual OSD menu. Press **ENTER** () into the sub menu and then use the Left () or Right () key to select your preferred language.

Setup | Security

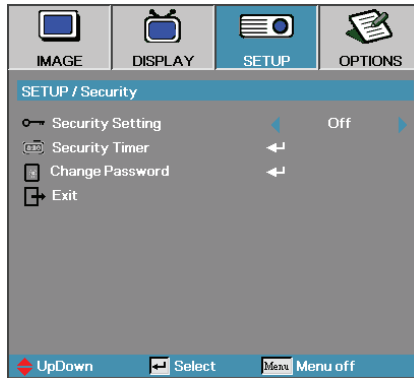

- ❖ The default password: 1, 2, 3, 4, 5.

Security Setting

Enable or disable the security password.

- ▶ Enabled – the current password is required to power on the projector and access the Security menu.
- ▶ Disabled – no password is required for any function.

When security is enabled, the following screen displays at startup and before access to the Security menu is allowed:

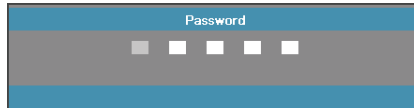

Setup | Security

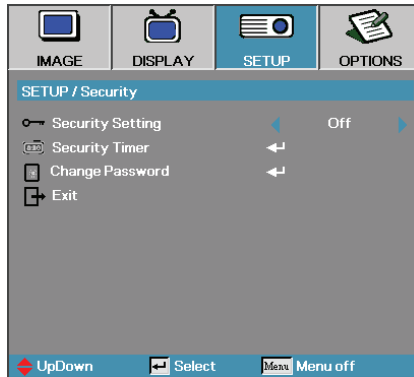

Security Timer

Enter the Security Timer sub menu.

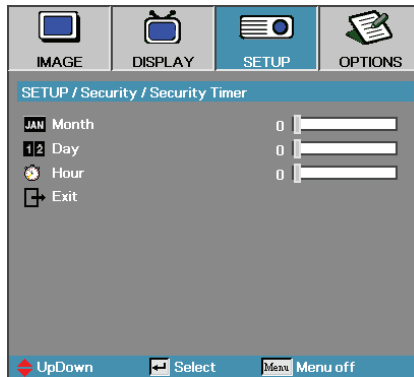

- ❖ No password is required to access Setup | Security unless the Security Timer or Security Setting are enabled.

Enter the Months, Days, and hours that the projector can be used without entering the password. Exiting to the Setup menu activates the Security Timer.

Once activated, the projector requires a password on the specified dates and times to allow power on and access to the security menu.

If the projector is in use and the Security Timer is active, the following screen displays 60 seconds before the password is required.

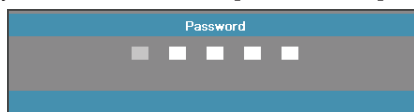

Setup | Security

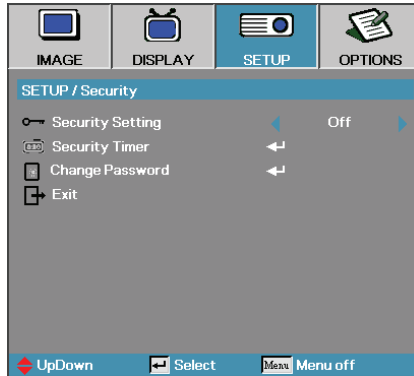

- ❖ If the incorrect password is entered three times, the device auto shutdowns after 10 seconds.

Change Password

Use this submenu to change the security password for the projector.

1. Select Change Password from the Security submenu. The Confirm Change Password dialog box displays.
2. Select Yes.

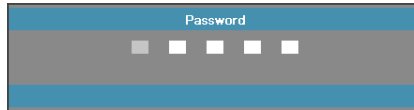

3. Enter the default password <1> <2> <3> <4> <5>. A second password screen displays.

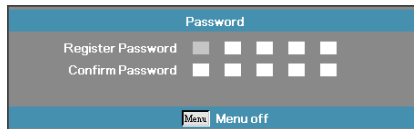

4. Enter the new password twice for verification.



- ❖ If the new passwords do not match, the password screen redisplay.

Setup | Signal (RGB)

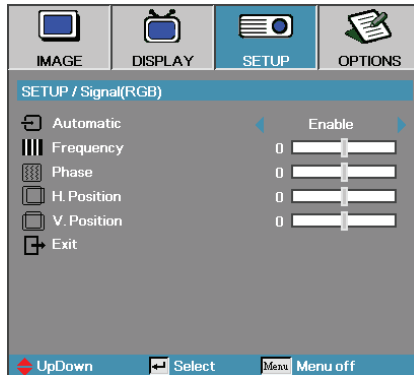

Automatic

Set Automatic to On or Off to lock or unlock the Phase and Frequency features.

- ▶ Off – disable auto lock.
- ▶ On – enable auto lock.

Frequency

Change the display data frequency to match the frequency of your computer's graphics card. If you experience a vertical flickering bar, use this function to make an adjustment.

Phase

Phase synchronizes the signal timing of the display with the graphics card. If you experience an unstable or flickering image, use this function to correct it.

H. Position

- ▶ Press ◀ to move the image left.
- ▶ Press ▶ to move the image right.

V. Position

- ▶ Press ▼ to move the image down.
- ▶ Press ▲ to move the image up.

Setup | Signal (Video)

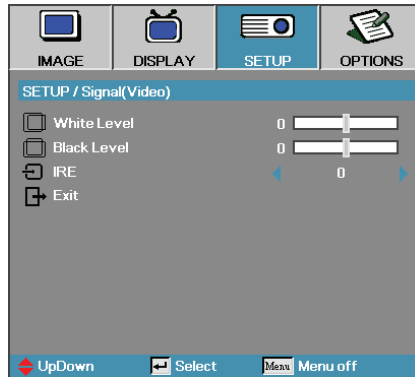

White Level

Allow user to adjust Black Level when input source is Video or S-Video signals. Press ◀▶ to adjust the White Level.

Black Level

Allow user to adjust Black Level when input source is Video or S-Video signals. Press ◀▶ to adjust the Black Level.

IRE

Press ◀▶ to adjust measurement of video signals.

Setup | Audio Settings



Internal Speaker

- ▶ Off – turn off the internal speaker.
- ▶ On – turn on the internal speaker.

Mute

Toggle the audio on or off.

- ▶ Off – the speaker volume and audio out are turned on.
- ▶ On – the speaker volume and audio out are turned off.

Volume

Press ◀ to decrease the volume.

Press ▶ to increase the volume.

Audio Input

Press ◀▶ to select audio source input.

Setup | Advanced



Logo

Select the screen to display during startup.

- ▶ Optoma – the supplied default startup screen.
- ▶ Neutral – is Background Color.
- ▶ User – customized screen capture using the Logo Capture function.

Logo Capture

Capture a displayed screen to use as the startup screen.

1. Display the desired screen on the projector.
2. Select Logo Capture from the Advanced menu.
A confirmation screen displays.

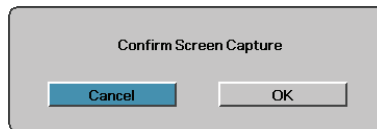

3. Select **OK**. Screen capture in progress will display.
When finished, Screen capture Succeeded will display.
The captured screen is saved as User in the logo menu.

Closed Captioning

Select the screen to display closed captioning

- ▶ Off – the supplied default setting.
- ▶ CC1/CC2 – closed captioning type select.



❖ Only one startup screen can be saved at once. Subsequent captures overwrite previous files limited in 1920 x 1200 (Refer Appendices Timing Table)

Setup | Network



LAN Settings

Enter the LAN Settings menu. See page 54 for more information.

Control Settings

Enter the Control Settings menu. See page 55 for more information.

Setup | LAN Settings



❖ Network sub-menu can only be accessed if a network cable is connected.

If the connection is successful, the OSD display will show the following dialogue box.

- ▶ Network State – to display network information.
- ▶ DHCP:
 - On: Assign an IP address to the projector from the DHCP server automatically.
 - Off: Assign an IP address manually.
- ▶ IP Address – Select an IP address
- ▶ Subnet Mask – Select subnet mask number.
- ▶ Gateway – Select the default gateway of the network connected to the projector.
- ▶ DNS – Select DNS number.
- ▶ Apply – Press **Enter** to apply the selection.
- ▶ MAC Address – Read only.

Setup | Control Settings

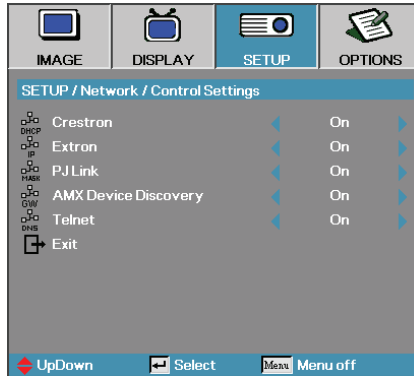

Crestron

Press ◀▶ to check to enable/disable Crestron.

Extron

Press ◀▶ to check to enable/disable Extron.

PJ Link

Press ◀▶ to check to enable/disable PJ Link.

AMX Device Discovery

Press ◀▶ to check to enable/disable AMX Device Discovery.

Telnet

Press ◀▶ to check to enable/disable Telnet.

Options

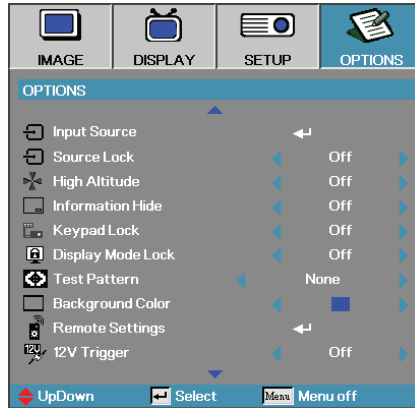

Input Source

Enter the Input Source submenu. Select the sources to scan for at startup. See page 59 for more information.

Source Lock

Lock the current source as the only available source, even if the cable is unplugged.

- ▶ On—only the current source is recognized as an input source.
- ▶ Off—all sources selected in **Options | Input Source** are recognized as an input source.

High Altitude

Adjust the fan speed to reflect the environment.

- ▶ On—increases fan speed for high temperature, humidity, or altitude.
- ▶ Off—regular fan speed for normal conditions.

Information Hide

Suppress informational messages on the projected screen.

- ▶ On—no status messages appear on screen during operation.
- ▶ Off—status messages appear as normal on screen during operation.

Options

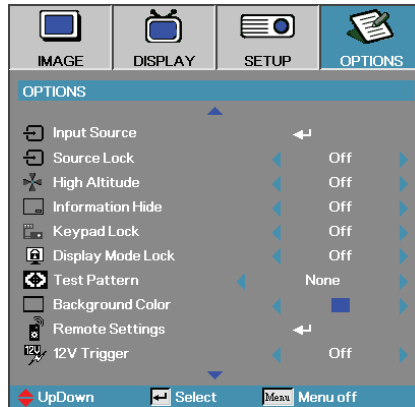

Keypad Lock

Lock the buttons on the projector top panel.

- ▶ On—a warning message displays to confirm keypad lock.

 Hold *ENTER* key on keypad for 5 seconds to unlock keypad

- ▶ Off—projector keypad functions as normal.

Display Mode Lock

Press ◀▶ to select display mode function whether lock or not. When Display Mode Lock set to On, the Display Mode function can't be adjusted by user.

Test Pattern

Display a test pattern. There are Grid (White, Green, Magenta), White and None.

Background Color

Select the desired background color for the projected image when no source is detected.

Remote Settings

Enter the Remote settings. See page 60 for more information.

12V Trigger

Press ◀▶ to select 12V Trigger whether output or not.

Options

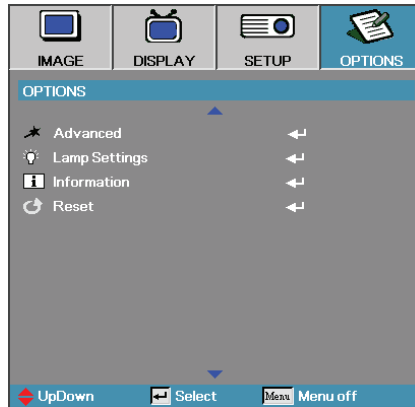

Advanced

Enter the Advanced menu. See pages 61 for more details.

Lamp Setting

Enter the Lamp Setting menu. See pages 63-64 for more details.

Information

Show the projector information.

Reset

Reset all Options to default factory settings.



- ❖ When Power mode (Standby) is set to Eco, the VGA & Audio pass-through, RS232 and RJ45 will be deactivated when the projector is in standby.

Options | Input Source



- ❖ If all sources are deselected, the projector cannot display any images. Always leave at least one source selected.

Input Source

Use this option to enable / disable input sources. Press ▲ or ▼ to select a source, then press ◀ or ▶ to enable / disable it. Press ↵ (**Enter**) to finalize the selection. The projector will not search inputs that are de-selected.

Options | Remote Settings

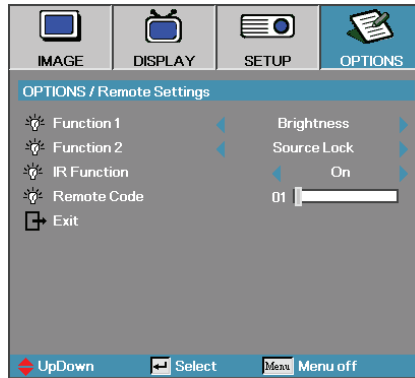

Function 1

Set **F1** key as a hotkey for Brightness, Contrast, Color, Color Temp. or Gamma function.

Function 2

Set **F2** key as a hotkey for Source Lock, Projection, Lamp Settings, Mute, Digital Zoom or Volume function.

IR Function

Enable or Disable projector's IR function.

Remote Code

Press ◀▶ to set Remote custom code and press ◀ (Enter) to change to the setting.

Options | Advanced

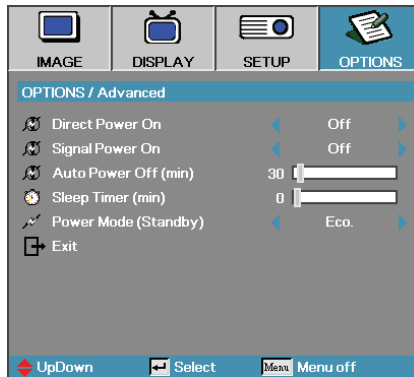

Direct Power On

Enable or disable Direct Power On.

- ▶ On—the projector powers on automatically when AC power is supplied.
- ▶ Off—the projector must be powered on as normal.

Signal Power On

Enable or disable Signal Power On.

- ▶ On—the projector powers on automatically when an active signal is detected.
- ▶ Off—disable the power on trigger by active signal is detected.



1. Only available on Standby Mode is Active.
2. If projector is turned off with keeping input the signal source (the last image source showing on screen), it will not re-start unless:
 - a. Terminate the last image source and input any signal source again.
 - b. Unplug and re-plug the projector power again.
3. Signal power on will ignore “source lock” setting.

Auto Power Off (min)

Set the Auto Power Off interval. The projector powers off the lamp after 30 minutes of no signal by default. The following warning is displayed 60 seconds before power off.

The projector will automatically shutdown after 60 sec.

Options | Advanced

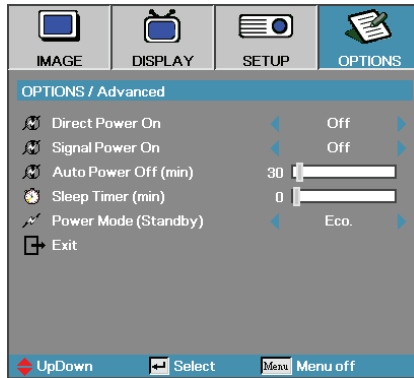

Sleep Timer (min)

Set the Sleep Timer interval. The projector powers off after the specified time period of inactivity (regardless of signal). The following warning is displayed 60 seconds before power off.

The projector will automatically shutdown after 60 sec.

Power Mode (Standby)

- ▶ Eco.: Choose "Eco." to save power dissipation further $< 0.5W$.
- ▶ Active: Choose "Active" to return to normal standby and the VGA out port will be enabled.

Options | Lamp Setting

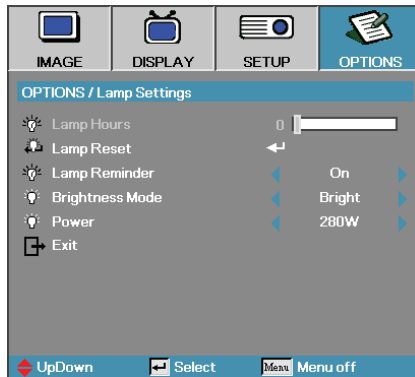

Lamp Hour

Displays the number of hours the lamp has been active. This item is for display only.

Lamp Reset

After replacing the lamp, reset the lamp counter to accurately reflect the new lamp's life span.

1. Select Lamp Reset.

A confirmation screen displays.

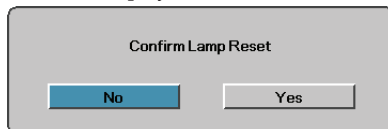

2. Select **Yes** to reset the lamp counter to zero.

Lamp Reminder

Enable or disable the lamp life span reminder.

- ▶ On – a warning message displays when remaining lamp life is less than 30 hours.



- ▶ Off – no warning message displays.

Options | Lamp Setting



Brightness Mode

Select the lamp brightness mode.

- ▶ Bright – the default setting.
- ▶ Eco – lower brightness setting to conserve lamp life.

Power

Press ◀▶ to select the lamp mode for 370W brightness or 280W brightness to save lamp life. The function is only available when Brightness Mode is Power.

LAN_RJ45



- ❖ Projector connects to LAN, please use Ethernet Normal Cable.
- ❖ Peer-to-peer (PC connects to Projector directly), please use Ethernet Crossover Cable.

For simplicity and ease of operation, the Optoma projector provides diverse networking and remote management features.

The LAN/RJ45 function of the projector through a network, such as remotely manage: Power On/Off, Brightness and Contrast settings. Also, projector status information, such as: Video-Source, Sound-Mute, etc.

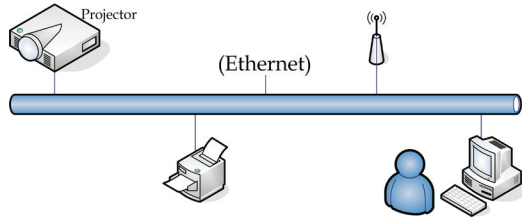

Wired LAN Terminal functionalities

The projector can be controlled by a PC (Laptop) or other external device via LAN/RJ45 port and compatible with Crestron / Extron / AMX (Device Discovery) / PJLink.

- ▶ Crestron is a registered trademark of Crestron Electronics, Inc. of the United States.
- ▶ Extron is a registered trademark of Extron Electronics, Inc. of the United States.
- ▶ AMX is a registered trademark of AMX LLC of the United States.
- ▶ PJLink applied for trademark and logo registration in Japan, the United States of America, and other countries by JBMIA.

Supported External Devices

This projector is supported by the specified commands of the Crestron Electronics controller and related software (ex, RoomView®).

<http://www.crestron.com/>

This projector is compliant to support Extron device(s) for reference.

<http://www.extron.com/>

This projector is supported by AMX (Device Discovery).

<http://www.amx.com/>

This projector supports all commands of PJLink Class1 (Version 1.00).

<http://pjlink.jbmia.or.jp/english/>

For more detail of information about the diverse types of external devices which can be connected to the LAN/RJ45 port and remote/control the projector, as well as the related control commands supporting for each external device, kindly please get contact with the Support-Service directly.

User Controls

LAN RJ45

1. Connect an RJ45 cable to RJ45 ports on the projector and the PC (Laptop).

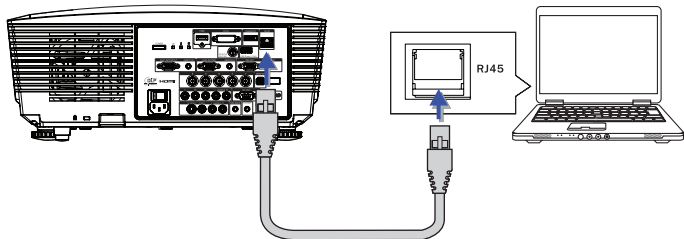

2. On the PC (Laptop), select Start -> Control Panel-> Network Connections.

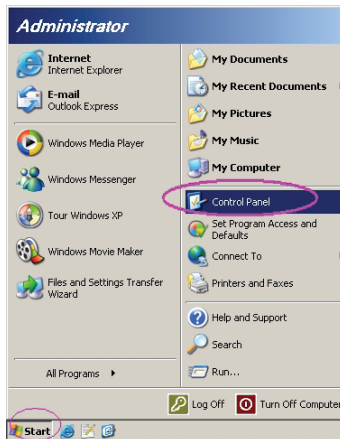

3. Right Click on your Local Area Connection, and select Property.

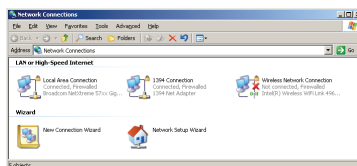

4. In the Properties window, select the **General** tab, and select **Internet Protocol (TCP/IP)**.

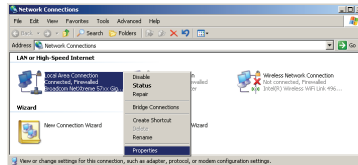

5. Click **Properties**.

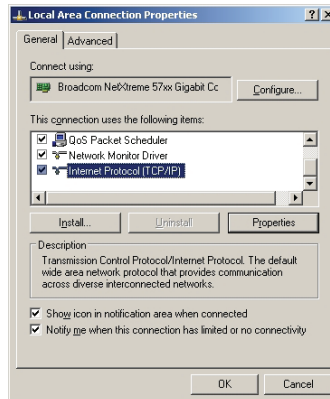

6. Fill in the IP address and Subnet mask, then press **OK**.

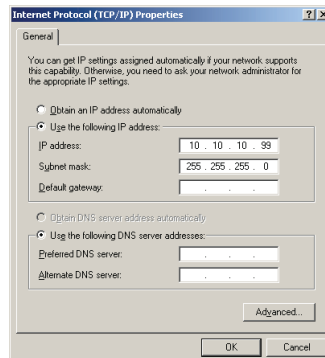

User Controls

7. Press the **Menu** button on the projector.
8. Select OSD-> SETUP-> Network Settings-> Lan Settings.
9. After getting into Network Status, input the following:

- ▶ DHCP: Off
- ▶ IP Address: 10.10.10.10
- ▶ Subnet Mask: 255.255.255.0
- ▶ Gateway: 0.0.0.0
- ▶ DNS: 0.0.0.0

10. Press **↵ (Enter)** / **▶** to confirm settings.

11. Open a web browser (ex, Microsoft Internet Explorer with Adobe Flash Player 9.0 or higher).

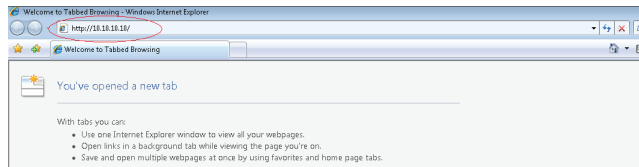

12. In the Address bar, input the IP address: 10.10.10.10.

13. Press **↵ (Enter)** / **▶**.

The projector is setup for remote management. The LAN/RJ45 function displays as follows.



- ❖ For more information, please visit <http://www.crestron.com>

Optoma

Admin > Information	
Information	
Alert Settings	
Crestron	
Model Name	
System	
System Status	Power On
Display Source	No Source
Stand Hours	0
Image	Presentation
Error Status	No Error
LAN Status	
IP address	10.10.10.10
Subnet mask	255.255.255.0
Default gateway	0.0.0.0
DNS Server	0.0.0.0
MAC address	
Version	
LAN Version	
F/W Version	

Crestron Copyright 2013 by Optoma Corp

User Controls



The screenshot shows a configuration tool interface with a light grey background. It is divided into several sections:

- Crestron Control:** Fields for IP Address, IP ID, and Control Port, with a 'Control Set' button.
- Projector:** Fields for Projector Name (FJ01), Location (RM01), and Assigned To (Sir), with a 'Set' button.
- Network Config:** A checkbox for 'DHCP Enabled' and fields for IP Address (10.10.10.10), Subnet Mask (255.255.255.0), Default Gateway (0.0.0.0), and DNS Server (0.0.0.0), with a 'Net Set' button.
- User Password:** A checkbox for 'User Enabled', fields for Password and Confirmed, and a 'User Set' button.
- Admin Password:** A checkbox for 'Admin Enabled', fields for Password and Confirmed, and an 'Admin Set' button.

 A 'Tools Exit' button is located at the bottom center.

Category	Item	Input-Length
Crestron Control	IP Address	15
	IP ID	3
	Port	5
Projector	Projector Name	10
	Location	10
	Assigned To	10
Network Configuration	DHCP (Enabled)	(N/A)
	IP Address	15
	Subnet Mask	15
	Default Gateway	15
	DNS Server	15
User Password	Enabled	(N/A)
	New Password	10
	Confirm	10
Admin Password	Enabled	(N/A)
	New Password	10
	Confirm	10

For more information, please visit <http://www.crestron.com>.

Preparing Email Alerts

1. Make sure that user can access the homepage of LAN RJ45 function by web browser (for ex-ample, Microsoft Internet Explorer v6.01/v8.0).
2. From the Homepage of LAN/RJ45, click **Alert Settings**.

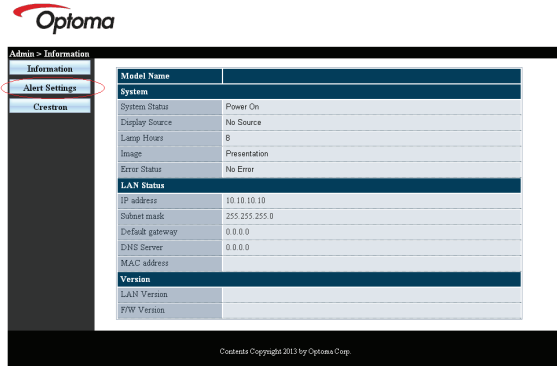

3. By default, these input boxes in Alert Settings are blank.



4. For Sending alert mail, input the following:
 - ▶ The **SMTP** field is the mail server for sending out email (SMTP protocol). This is a required field.
 - ▶ The **To** field is the recipient's email address (for example, the projector administrator). This is a required field.
 - ▶ The **Cc** field sends a carbon copy of the alert to the specified email address. This is an optional field (for example, the projector administrator's assistant).



❖ Fill in all fields as specified. User can click **Send Test Mail** to test what setting is correct. For successful sending an email alert, you must select alert conditions and enter a correct email address.

- ▶ The **From** field is the sender's email address (for example, the projector administrator). This is a required field.
- ▶ Select the alert conditions by checking the desired boxes.

Optoma

Admin > Alert Settings

Information	SMTP setting	Email Setting	Alert Condition
Alert Settings	Server Address: mail.comp.com	To: rcv1@mail.comp.com	<input type="checkbox"/> Fan Error
Crestion	Server: [empty]	Cc: rcv2@mail.comp.com	<input checked="" type="checkbox"/> Lamp Error
	Port: 25	Subject: Projector Warning Information I	<input checked="" type="checkbox"/> High Temp. Error
	Title: Sender US	From: send@mail.comp.com	<input type="button" value="Apply"/> <input type="button" value="Send Test Mail"/>
	Name: [empty]	<input type="button" value="Mail Address Apply"/>	
	Password: ****		
	<input type="button" value="Mail Server Apply"/>		

Copyright © 2013 by Optoma Corp.

RS232 by Telnet Function

Besides projector connected to RS232 interface with "Hyper-Terminal" communication by dedicated RS232 command control, there is alternative RS232 command control way, so called "RS232 by TELNET" for LAN/RJ45 interface.

Quick Start-Guide for “RS232 by TELNET”

Check and get the IP-Address on OSD of the projector.
Make sure that laptop/PC can access the web-page of the projector.
Make sure that “Windows Firewall” setting to be disabled in case of
“TELNET” function filtering out by laptop/PC.



1. Start => All Programs => Accessories => Command Prompt.

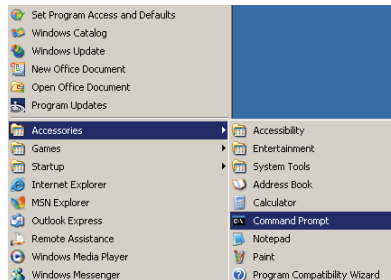

2. Input the command format like the below:
telnet ttt.xxx.yyy.zzz 23 (“Enter” key pressed)
(ttt.xxx.yyy.zzz: IP-Address of the projector)
3. If Telnet-Connection ready, and user can have RS232 command input, then “Enter” key pressed, the RS232 command will be workable.

How to have TELNET enabled in Windows VISTA / 7

By default installation for Windows VISTA, "TELNET" function is not included. But end-user can have it by way of "Turn Windows features On or Off" to be enabled.

1. Open "Control Panel" in Windows VISTA.

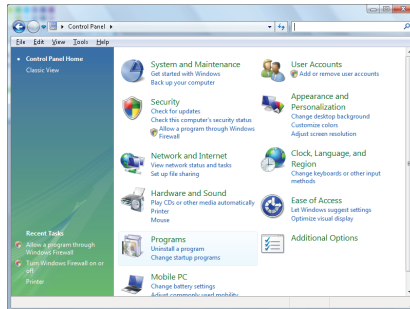

2. Open "Programs".

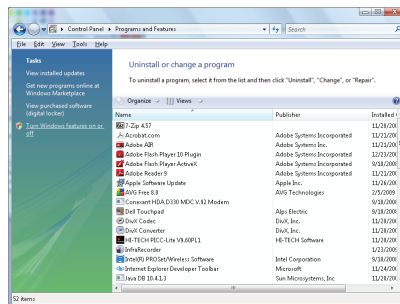

3 Select “Turn Windows features on or off” to open.

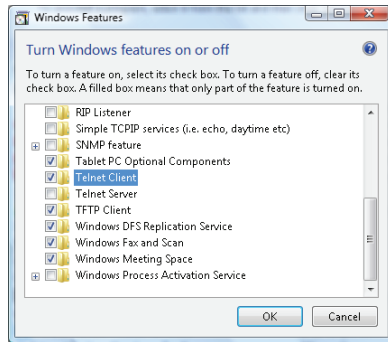

4. Have “Telnet Client” option checked, then press “OK” button.

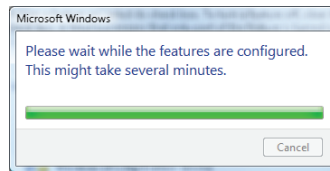

Specsheet for “RS232 by TELNET” :

1. Telnet: TCP.
2. Telnet port: 23 (for more detail, kindly please get contact with the service agent or team).
3. Telnet utility: Windows “TELNET.exe” (console mode).
4. Disconnection for RS232-by-Telnet control normally: Close Windows Telnet utility directly after TELNET connection ready.

Limitation 1 for Telnet-Control: there is less than 50 bytes for successive network payload for Telnet-Control application.

Limitation 2 for Telnet-Control: there is less than 26 bytes for one complete RS232 command for Telnet-Control.

Limitation 3 for Telnet-Control: Minimum delay for next RS232 command must be more than 200 (ms).

(* In Windows XP built-in “TELNET.exe” utility, “Enter” key pressed will have “Carriage-Return” and “New-Line” code.)

Troubleshooting

If you experience a problem with your projector, please refer to the following information. If a problem persists, please contact your local reseller or service center.

Image Problems

No image appears on-screen

- ▶ Ensure all the cables and power connections are correctly and securely connected as described in the **Installation** section.
- ▶ Ensure all the pins of connectors are not bent or broken.
- ▶ Check if the projection lamp has been securely installed. Please refer to the **Replacing the Lamp** section.
- ▶ Make sure you have removed the lens cap and the projector is switched on.

Partial, scrolling or incorrectly displayed image

- ▶ Press **Re-Sync** on the remote.
- ▶ If you are using a PC:
For Windows 95, 98, 2000, XP:
 1. Open the **My Computer** icon, the **Control Panel** folder, and then double click on the **Display** icon.
 2. Select the **Settings** tab.
 3. Verify that your display resolution setting is lower than or equal to UXGA (1600 x 1200).
 4. Click on the **Advanced Properties** button.
If the projector is still not projecting the whole image, you will also need to change the monitor display you are using. Refer to the following steps.
 5. Verify the resolution setting is lower than or equal to UXGA (1600 x 1200).
 6. Select the **Change** button under the **Monitor** tab.
 7. Click on **Show all devices**. Next, select **Standard monitor types** under the SP box; choose the resolution mode you need under the "Models" box.
 8. Verify that the resolution setting of the monitor display is lower than or equal to UXGA (1600 x 1200). (*)

- ▶ If you are using a Notebook:
 1. First, follow the steps above to adjust resolution of the computer.
 2. Press the toggle output settings. Example: [Fn]+[F4]

Acer ⇒	[Fn]+[F5]	IBM/Lenovo ⇒	[Fn]+[F7]
Asus ⇒	[Fn]+[F8]	HP/Compaq ⇒	[Fn]+[F4]
Dell ⇒	[Fn]+[F8]	NEC ⇒	[Fn]+[F3]
Gateway ⇒	[Fn]+[F4]	Toshiba ⇒	[Fn]+[F5]

Mac Apple:
System Preference ⇒ Display ⇒ Arrangement ⇒ Mirror display

If you experience difficulty changing resolutions or your monitor freezes, restart all equipment including the projector.

The screen of the Notebook or PowerBook computer is not displaying your presentation

- ▶ If you are using a Notebook:

Some Notebooks may deactivate their own screens when a second display device is in use. Each has a different way to be reactivated. Refer to your computer's manual for detailed information.

Image is unstable or flickering

- ▶ Use **Phase** to correct it. See page 49 for more information.
- ▶ Change the monitor color setting on your computer.

Image has vertical flickering bar

- ▶ Use **Frequency** to make an adjustment. See page 49 for more information.
- ▶ Check and reconfigure the display mode of your graphic card to make it compatible with the projector.

Image is out of focus

- ▶ Make sure the lens cap is removed.
- ▶ Adjusts the Focus Ring on the projector lens.
- ▶ Make sure the projection screen is between the required distances from the projector. See pages 25-27 for more information.

The image is stretched when displaying 16:9 DVD title

When you play anamorphic DVD or 16:9 DVD, the projector will show the best image in 16:9 format in OSD. If you play 4:3 format DVD title, please change the format as 4:3 in projector OSD. If the image is still stretched, you will also need to adjust the aspect ratio by referring to the following:

- ▶ Please setup the display format as 16:9 (wide) aspect ratio type on your DVD player.

Image is too small or too large

- ▶ Adjust the Zoom Ring on the top of the projector.
- ▶ Move the projector closer to or further from the screen.
- ▶ Press **Menu** button on the remote control or projector panel, go to **Display | Format** and try the different settings.

Image has slanted sides

- ▶ If possible, reposition the projector so that it is centered on the screen and below the bottom of the screen.
- ▶ Press **Keystone +/-** on the remote control until the sides are vertical.

Image is reversed

- ▶ Select **Setup | Projection** from the OSD and adjust the projection direction.

Intermission Problems

The projector stops responding to all controls

- ▶ If possible, turn off the projector, then unplug the power cord and wait at least 60 seconds before reconnecting power.

Lamp burns out or makes a popping sound

- ▶ When the lamp reaches its end of life, it will burn out and may make a loud popping sound. If this happens, the projector will not turn on until the lamp module has been replaced. To replace the lamp, follow the procedures in Replacing the Lamp on page 81.

HDMI Q & A

What is the difference between a “Standard” HDMI cable and a “High-Speed” HDMI cable?

Recently, HDMI Licensing, LLC announced that cables would be tested as Standard or High-Speed cables.

- ▶ Standard (or “category 1”) HDMI cables have been tested to perform at speeds of 75Mhz or up to 2.25Gbps, which is the equivalent of a 720p/1080i signal.
- ▶ High Speed (or “category 2”) HDMI cables have been tested to perform at speeds of 340Mhz or up to 10.2Gbps, which is the highest bandwidth currently available over an HDMI cable and can successfully handle 1080p signals including those at increased color depths and/or increased refresh rates from the Source. High-Speed cables are also able to accommodate higher resolution displays, such as WQXGA cinema monitors (resolution of 2560 x 1600).

How do I run HDMI cables longer than 10 meters?

- ▶ There are many HDMI Adopters working on HDMI solutions that extend a cable’s effective distance from the typical 10 meter range to much longer lengths. These companies manufacture a variety of solutions that include active cables (active electronics built into cables that boost and extend the cable’s signal), repeaters, amplifiers as well as CAT5/6 and fiber solutions.

How can I tell if a cable is an HDMI certified cable?

- ▶ All HDMI products are required to be certified by the manufacturer as part of the HDMI Compliance Test Specification. However, there may be instances where cables bearing the HDMI logo are available but have not been properly tested. HDMI Licensing, LLC actively investigates these instances to ensure that the HDMI trademark is properly used in the market. We recommend that consumers buy their cables from a reputable source and a company that is trusted.

For more detail information check:

<http://www.hdmi.org/learningcenter/faq.aspx#49>

Projector Status Indication

Message	Power LED	Power LED	Temp LED	Lamp LED
	□ ○	□ ○	□ ↓	□ ↓
	(Blue)	(Red)	(Red)	(Red)
Operating	On	0	0	0
Warm up or Cooling down	Flashing (0.5 sec)	0	0	0
Standby	0	On	0	0
T1 temperature over temperature	0	Flashing	On	0
Thermal break	0	4	0	0
Lamp error	0	Flashing	0	On
Fan error	0	Flashing	Flashing	0
Lamp door open	0	7	0	0
DMD error	0	8	0	0
Color wheel error	0	9	0	0

* Power LED will be ON when OSD appears and OFF when OSD disappears.

The digit represents the number of led blinks.

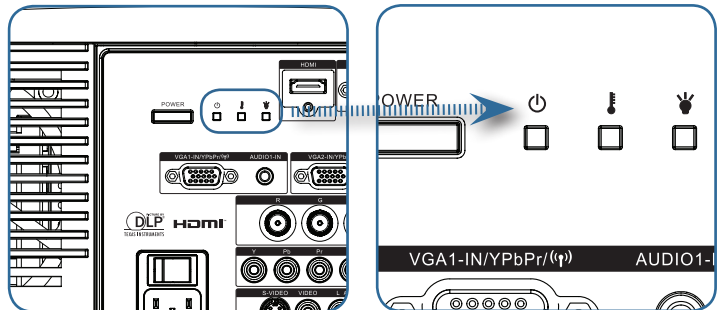

Message Reminders

- ▶ Replacing the lamp:

 **Lamp is approaching the end of its useful life**

- ▶ Out of range: (see the following for more information)



Signal out of range
lower image resolution.

Remote Control Problems

If the remote control does not work

- ▶ Check the operating angle for the remote control is approximately $\pm 15^\circ$.
- ▶ Make sure there are no obstructions between the remote control and the projector. Move to within 7m (23 ft) of the projector.
- ▶ Make sure the batteries are inserted correctly.
- ▶ Replace weak batteries in the remote control.

Audio Problems

There is no sound

- ▶ Adjust the volume on the remote control.
- ▶ Adjust the volume of the audio source.
- ▶ Check the audio cable connection.
- ▶ Test the source audio output with other speakers.
- ▶ Have the projector serviced.

The sound is distorted

- ▶ Check the audio cable connection.
- ▶ Test the source audio output with other speakers.
- ▶ Have the projector serviced.

Replacing the Lamp

The projection lamp should be replaced when it burns out. It should only be replaced with a certified replacement part, which you can order from your local dealer.

Important:

- ▶ The lamp contains a certain amount of mercury and should be disposed of according to local ordinance regulations.
- ▶ Avoid touching the glass surface of the new lamp, doing so may shorten its operation life.



Warning:

- ▶ Be sure to turn off and unplug the projector at least an hour before replacing the lamp. Failure to do so could result in a severe burn.

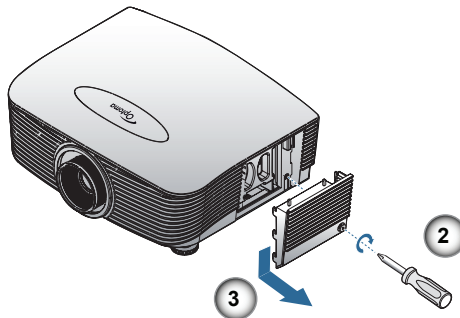
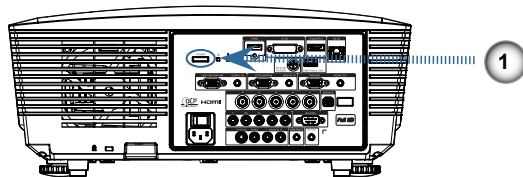

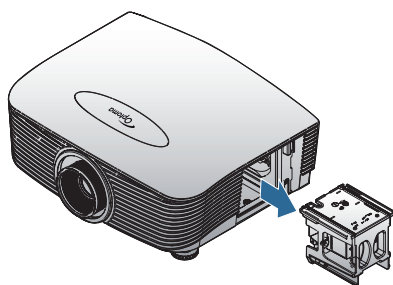
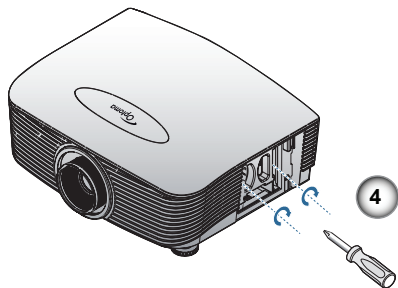

1. Switch off the power to the projector by pressing the Power button.
2. Allow the projector to cool down at least 30 minutes.
3. Disconnect the power cord.
4. Unlock the lamp cover.
5. Pull up and remove the cover.
6. Use a screwdriver to remove the screws from the lamp module.
7. Pull out the lamp module.

To replace the lamp module, reverse the previous steps.

After replacing the lamp, the lamp hours counter must be reset. See page 63 for more information.

Cleaning the Projector

Cleaning the projector to remove dust and grime will help ensure trouble-free operation.

Warning:

- ▶ Be sure to turn off and unplug the projector at least an hour before cleaning. Failure to do so could result in a severe burn.
- ▶ Use only a dampened cloth when cleaning. Do not allow water to enter the ventilation openings on the projector.
- ▶ If a little water gets into the projector interior while cleaning, leave unplugged in a well-ventilated room for several hours before using.
- ▶ If a lot of water gets into the projector interior when cleaning, have the projector serviced.

Cleaning the Lens

You can purchase optic lens cleaner from most camera stores. Refer to the following to clean the projector lens.

1. Apply a little optic lens cleaner to a clean soft cloth.
(Do not apply the cleaner directly to the lens.)
2. Lightly wipe the lens in a circular motion.

Caution:

- ▶ Do not use abrasive cleaners or solvents.
- ▶ To prevent discoloration or fading, avoid getting cleaner on the projector case.

Cleaning the Case

Refer to the following to clean the projector case.

1. Wipe off dust with a clean dampened cloth.
2. Moisten the cloth with warm water and mild detergent (such as used to wash dishes), and then wipe the case.
3. Rinse all detergent from the cloth and wipe the projector again.

Caution:

To prevent discoloration or fading of the case, do not use abrasive alcohol-based cleaners.

Compatibility Modes

Video Compatibility

NTSC	NTSC M/J, 3.58MHz, 4.43MHz	
PAL	PAL B/D/G/H/I/M/N, 4.43MHz	
SECAM	SECAM B/D/G/K/K1/L, 4.25/4.4 MHz	
SDTV	480i/p, 576i/p	
HDTV	720p(50/60Hz), 1080i(50/60Hz), 1080P(50/60Hz)	

Video timing detail describe



❖ For wide screen resolution (WXGA), the compatibility support is dependent on Notebook/PC models.

Signal	Resolution	Refresh Rate(Hz)	Notes
TV(NTSC)	720 X 480	60	For Composite Video/S-Video
TV(PAL, SECAM)	720 X 576	50	
SDTV(480i)	720 X 480	60	For Component
SDTV(480p)	720 X 480	60	
SDTV(576i)	720 X 576	50	
SDTV(576p)	720 X 576	50	
HDTV(720p)	1280 X 720	50/60	
HDTV(1080i)	1920 X 1080	50/60	
HDTV(1080p)	1920 X 1080	24/50/60	

Computer Compatibility - VESA standards

Computer Signal (Analog RGB Compatible)

Signal	Resolution	Refresh Rate(Hz)	Notes for Mac
VGA	640 x 480	60/67/72/85	Mac 60/72/85
SVGA	800 x 600	56/60 ^(*) /72/ 85/120 ^(*)	Mac 60/72/85
XGA	1024 x 768	50/60 ^(*) /70/ 75/85/120 ^(*)	Mac 60/70/75/85
HDTV (720p)	1280 x 720	50/60 ^(*) /120 ^(*)	Mac 60
WXGA	1280 x 768	60/75/85	Mac 60/75/85
	1280 x 800	50/60	Mac 60
WXGA	1366 x 768	60	
SXGA	1280 x 1024	60/75/85	Mac 60/75
SXGA+	1400 x 1050	60	
UXGA	1600 x 1200	60	
HDTV (1080p)	1920 x 1080	24/50/60	Mac 60
WUXGA	1920 x 1200 ^(*)	60/50	Mac 60

(*1) 1920 x 1200 @60Hz only support RB(reduced blanking).

(*2) To support frame sequential 3D.



❖ Native resolution supports 50Hz.

Input Signal for HDMI/DVI-D

Signal	Resolution	Refresh Rate(Hz)	Notes for Mac
VGA	640 x 480	60	Mac 60/72/85
SVGA	800 x 600	60 ^{(*)2} /72/85/ 120 ^{(*)2}	Mac 60/72/85
XGA	1024 x 768	50/60 ^{(*)2} /70/ 75/85/120 ^{(*)2}	Mac 60/70/75/85
SDTV(480i)	720 x 480	60	
SDTV(480p)	720 x 480	60	
SDTV(576i)	720 x 576	50	
SDTV(576p)	720 x 576	50	
WSVGA (1024 x 600)	1024 x 600	60 ^{(*)2}	
HDTV(720p)	1280 x 720	50 ^{(*)2} /60/ 120 ^{(*)2}	Mac 60
WXGA	1280 x 768	60/75/85	Mac 75
	1280 x 800	60/50	Mac 60
WXGA	1366 x 768	60	
SXGA	1280 x 1024	60/75/85	Mac 60/75
SXGA+	1400 x 1050	60	
UXGA	1600 x 1200	60	
HDTV (1080i)	1920 x 1080	50/60	
HDTV (1080p)	1920 x 1080	24/30/50/60	Mac 60
WUXGA	1920 x 1200 ^{(*)1}	60/50	Mac 60

(*1) 1920 x 1200 @60Hz only support RB(reduced blanking).

(*2) To support frame sequential 3D.

True 3D Video Compatibility table

Input Resolutions	Input timing		
HDMI 1.4a 3D Input	1280 x 720p @50Hz	Top - and - Bottom	
	1280 x 720p @60Hz	Top - and - Bottom	
	1280 x 720p @50Hz	Frame packing	
	1280 x 720p @60Hz	Frame packing	
	1920 x 1080i @50Hz	Side- by-Side (Half)	
	1920 x 1080i @60Hz	Side- by-Side (Half)	
	1920 x 1080p @24Hz	Top - and - Bottom	
	1920 x 1080p @24 Hz	Frame packing	
HDMI 1.3	1920 x 1080i @50Hz	Side-by-Side (Half)	SBS mode is on
	1920 x 1080i @60Hz		
	1280 x 720p @50Hz		
	1280 x 720p @60Hz		
	1920 x 1080i @50Hz	Top-and- Bottom	TAB mode is on
	1920 x 1080i @60Hz		
	1280 x 720P @50Hz		
	1280 x 720P @60Hz		
480i	HQFS		

RS232 Commands

RS232 Connector

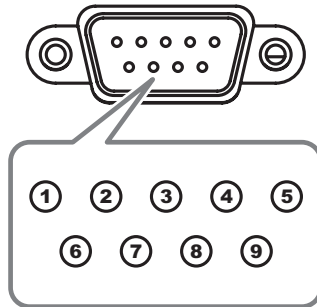

Pin No	Specification
1	N/A
2	RXD
3	TXD
4	DTR
5	GND
6	DSR
7	RTS
8	CTS
9	N/A

RS232 Protocol Function List

RS232 Commands

Baud Rate : 9600
 Data Bits : 8
 Parity : None
 Stop Bits : 1
 Flow Control : None
 UART16550 FIFO: Disable
 Projector Return (Pass): F
 Projector Return (Fail): F

Note : There is a <CR> after all ASCII commands
 0D is the HEX code for <CR> in ASCII code

XX=01-99, projector's ID, XX=00 is for all projectors

SEND to projector

232 ASCII Code	HEX Code	Function	Description
-XX00 1	7E 30 30 30 20 31 0D	Power ON	
-XX00 0	7E 30 30 30 20 30 0D	Power OFF	
-XX00 1 ~ mnnn	7E 30 30 30 20 31 20 a 0D	Power ON with Password	(0/2 for backward compatible) ~mnnn = ~0000 (a=7E 30 30 30) ~9999 (a=7E 39 39 39)
-XX01 1	7E 30 30 30 31 20 31 0D	Resync	
-XX02 1	7E 30 30 30 32 20 31 0D	AV Mute	On
-XX02 0	7E 30 30 30 32 20 30 0D		Off (0/2 for backward compatible)
-XX03 1	7E 30 30 30 33 20 31 0D	Mute	On
-XX03 0	7E 30 30 30 33 20 30 0D		Off (0/2 for backward compatible)
-XX04 1	7E 30 30 30 34 20 31 0D	Freeze	
-XX04 0	7E 30 30 30 34 20 30 0D	Unfreeze	(0/2 for backward compatible)
-XX05 1	7E 30 30 30 35 20 31 0D	Zoom Plus	
-XX06 1	7E 30 30 30 36 20 31 0D	Zoom Minus	
-XX12 1	7E 30 30 31 32 20 31 0D	Direct Source Commands	HDMI
-XX12 2	7E 30 30 31 32 20 32 0D		DVI-D
-XX12 4	7E 30 30 31 32 20 34 0D		BNC
-XX12 5	7E 30 30 31 32 20 35 0D		VGA1
-XX12 6	7E 30 30 31 32 20 36 0D		VGA 2
-XX12 8	7E 30 30 31 32 20 38 0D		VGA1 Component
-XX12 9	7E 30 30 31 32 20 39 0D		S-Video
-XX12 10	7E 30 30 31 32 20 31 30 0D		Video
-XX12 13	7E 30 30 31 32 20 31 33 0D		VGA 2 Component
-XX12 14	7E 30 30 31 32 20 31 34 0D		Component
-XX12 20	7E 30 30 31 32 20 32 30 0D		DisplayPort
-XX20 1	7E 30 30 32 30 20 31 0D	Display Mode	Presentation
-XX20 2	7E 30 30 32 30 20 32 0D		Bright
-XX20 3	7E 30 30 32 30 20 33 0D		Movie
-XX20 4	7E 30 30 32 30 20 34 0D		sRGB
-XX20 5	7E 30 30 32 30 20 35 0D		User
-XX20 7	7E 30 30 32 30 20 37 0D		Blackboard
-XX20 13	7E 30 30 32 30 21 33 0D		DICOM SIM.
-XX20 9	7E 30 30 32 30 20 39 0D		3D
-XX21 n	7E 30 30 32 31 20 a 0D	Brightness	n = -50 (a=2D 35 30) ~ 50 (a=35 30) n = -50 (a=2D 35 30) ~ 50 (a=35 30)
-XX23 n	7E 30 30 32 33 20 a 0D	Sharpness	n = 1 (a=31) ~ 15 (a=31 35)
-XX44 n	7E 30 30 34 34 20 a 0D	Tint	n = -50 (a=2D 35 30) ~ 50 (a=35 30)
-XX45 n	7E 30 30 34 35 20 a 0D	Color	n = -50 (a=2D 35 30) ~ 50 (a=35 30)
-XX327 n	7E 58 58 33 32 37 20 a 0D	Color Matching	Red Hue n=-127(a=2d 31 32 37)-127(a=31 32 37)
-XX328 n	7E 58 58 33 32 38 20 a 0D		Green Hue n=-127(a=2d 31 32 37)-127(a=31 32 37)
-XX329 n	7E 58 58 33 32 39 20 a 0D		Blue Hue n=-127(a=2d 31 32 37)-127(a=31 32 37)
-XX330 n	7E 58 58 33 33 20 a 0D		Cyan Hu n=-127(a=2d 31 32 37)-127(a=31 32 37)
-XX331 n	7E 58 58 33 33 31 20 a 0D		Yellow Hue n=-127(a=2d 31 32 37)-127(a=31 32 37)
-XX332 n	7E 58 58 33 33 32 20 a 0D		Magenta Hue n=-127(a=2d 31 32 37)-127(a=31 32 37)
-XX333 n	7E 58 58 33 33 33 20 a 0D		Cyan Hue n=-127(a=2d 31 32 37)-127(a=31 32 37)
-XX334 n	7E 58 58 33 33 34 20 a 0D		Red Saturation n=-127(a=2d 31 32 37)-127(a=31 32 37)
-XX335 n	7E 58 58 33 33 35 20 a 0D		Green Saturation n=-127(a=2d 31 32 37)-127(a=31 32 37)
-XX336 n	7E 58 58 33 33 36 20 a 0D		Blue Saturation n=-127(a=2d 31 32 37)-127(a=31 32 37)
-XX337 n	7E 58 58 33 33 37 20 a 0D		Cyan Saturation n=-127(a=2d 31 32 37)-127(a=31 32 37)
-XX338 n	7E 58 58 33 33 38 20 a 0D		Yellow Saturation n=-127(a=2d 31 32 37)-127(a=31 32 37)
-XX339 n	7E 58 58 33 33 39 20 a 0D		Magenta Saturation n=-127(a=2d 31 32 37)-127(a=31 32 37)
-XX340 n	7E 58 58 33 34 30 20 a 0D		Red Gain n=-127(a=2d 31 32 37)-127(a=31 32 37)
-XX341 n	7E 58 58 33 34 31 20 a 0D		Green Gain n=-127(a=2d 31 32 37)-127(a=31 32 37)
-XX342 n	7E 58 58 33 34 32 20 a 0D		Blue Gain n=-127(a=2d 31 32 37)-127(a=31 32 37)
-XX343 n	7E 58 58 33 34 33 20 a 0D		Yellow Gain n=-127(a=2d 31 32 37)-127(a=31 32 37)
-XX344 n	7E 58 58 33 34 34 20 a 0D		Magenta Gain n=-127(a=2d 31 32 37)-127(a=31 32 37)
-XX345 n	7E 58 58 33 34 35 20 a 0D		White/R n = -50 (a=2D 35 30) ~ 50 (a=35 30)
-XX346 n	7E 58 58 33 34 36 20 a 0D		White/G n = -50 (a=2D 35 30) ~ 50 (a=35 30)
-XX347 n	7E 58 58 33 34 37 20 a 0D		White/B n = -50 (a=2D 35 30) ~ 50 (a=35 30)
-XX348 n	7E 30 30 32 31 35 20 31 0D	Reset	
-XX24 n	7E 30 30 32 34 20 a 0D	RGB Gain/Bias	Red Gain n = -50 (a=2D 35 30) ~ 50 (a=35 30)
-XX25 n	7E 30 30 32 35 20 a 0D		Green Gain n = -50 (a=2D 35 30) ~ 50 (a=35 30)
-XX26 n	7E 30 30 32 36 20 a 0D		Blue Gain n = -50 (a=2D 35 30) ~ 50 (a=35 30)
-XX27 n	7E 30 30 32 37 20 a 0D		Red Bias n = -50 (a=2D 35 30) ~ 50 (a=35 30)
-XX28 n	7E 30 30 32 38 20 a 0D		Green Bias n = -50 (a=2D 35 30) ~ 50 (a=35 30)
-XX29 n	7E 30 30 32 39 20 a 0D		Blue Bias n = -50 (a=2D 35 30) ~ 50 (a=35 30)
-XX33 n	7E 30 30 33 33 20 a 0D		Reset n = -50 (a=2D 35 30) ~ 50 (a=35 30)
-XX34 n	7E 30 30 33 34 20 a 0D	BrilliantColor™	n = 1 (a=31) ~ 10 (a=31 30)
-XX196 n	7E 30 30 31 39 36 20 a 0D	Noise Reduction	n = 1 (a=31) ~ 10 (a=31 30)
-XX35 1	7E 30 30 33 35 20 31 0D	Gamma	Filem
-XX35 3	7E 30 30 33 35 20 33 0D		Graphics
-XX35 5	7E 30 30 33 35 20 35 0D		1.8
-XX35 6	7E 30 30 33 35 20 36 0D		2.0
-XX35 7	7E 30 30 33 35 20 37 0D		2.2



Due to the difference application for each model. Function is dependent on the model purchased.

Appendices

-XX35 8	7E 30 30 33 35 20 38 0D			2.6
-XX35 9	7E 30 30 33 35 20 39 0D			3D
-XX36 3	7E 30 30 33 36 20 30 0D	Color Temp.		Warm
-XX36 0	7E 30 30 33 36 20 31 0D			Standard
-XX36 1	7E 30 30 33 36 20 32 0D			Cool
-XX36 2	7E 30 30 33 36 20 33 0D			Cold
-XX37 1	7E 30 30 33 37 20 31 0D	Color Space		Auto
-XX37 2	7E 30 30 33 37 20 32 0D			RGB(0-255)
-XX37 3	7E 30 30 33 37 20 33 0D			YUV
-XX37 4	7E 30 30 33 37 20 34 0D			RGB(16 - 235)
-XX73 n	7E 30 30 37 33 20 a 0D	Signal (RGB)		Frequency n = -5 (a=2D 35) - 5 (a=35) By signal
-XX74 n	7E 30 30 37 34 20 a 0D			Phase n = 0 (a=30) - 31 (a=33 31) By signal
-XX91 1	7E 30 30 39 31 20 31 0D			Automatic Enable
-XX91 0	7E 30 30 39 31 20 30 0D			Disable
-XX75 n	7E 30 30 37 35 20 a 0D			H. Position n = -5 (a=2D 35) + 5 (a=35) By timing
-XX76 n	7E 30 30 37 36 20 a 0D			V. Position n = -5 (a=2D 35) - 5 (a=35) By timing
-XX200 n	7E 30 30 32 30 30 20 a 0D	Signal(Video)		White Level
-XX201 n	7E 30 30 32 30 30 21 a 0D			Black Level
-XX204 1	7E 30 30 32 30 30 21 31 0D			0
-XX204 0	7E 30 30 32 30 30 21 30 0D			7.5
-XX60 1	7E 30 30 36 30 20 31 0D	Format		4:3
-XX60 2	7E 30 30 36 30 20 32 0D			16:9
-XX60 3	7E 30 30 36 30 20 33 0D			16:10(WXGA-WUXGA Model)
-XX60 5	7E 30 30 36 30 20 35 0D			LBX
-XX60 6	7E 30 30 36 30 20 36 0D			Native
-XX60 7	7E 30 30 36 30 20 37 0D			Auto
-XX62 n	7E 30 30 36 32 20 a 0D	Digital Zoom	Zoom	n = -5 (a=2D 35) - 25 (a=32 35)
-XX504 n	7E 58 58 35 30 34 20 a 0D			H Zoom n = 0 (a=30) - 100 (a=31 30 30)
-XX505 n	7E 58 58 35 30 35 20 a 0D			V Zoom n = 0 (a=30) - 100 (a=31 30 30)
-XX61 n	7E 30 30 36 31 20 a 0D	Edge mask		n = 0 (a=30) - 10 (a=31 30)
-XX63 n	7E 30 30 36 33 20 a 0D	H Image Shift		n = -100 (a=2D 31 30 30) - 100 (a=31 30 30)
-XX64 n	7E 30 30 36 34 20 a 0D	V Image Shift		n = -100 (a=2D 31 30 30) - 100 (a=31 30 30)
-XX66 n	7E 30 30 36 36 20 a 0D	V Keystone		n = -40 (a=2D 34 30) - 40 (a=34 30)
-XX230 1	7E 30 30 32 33 30 20 31 0D			3D Mode
-XX230 3	7E 30 30 32 33 30 20 33 0D			3D
-XX400 0	7E 30 30 34 30 30 20 30 0D	3D ->2D		IR
-XX400 1	7E 30 30 34 30 30 20 31 0D			L
-XX400 2	7E 30 30 34 30 30 20 32 0D			R
-XX400 3	7E 30 30 34 30 30 20 33 0D			Auto
-XX405 0	7E 30 30 34 30 35 20 31 0D	3D Format		SBS
-XX405 1	7E 30 30 34 30 35 20 32 0D			Top and Bottom
-XX405 2	7E 30 30 34 30 35 20 33 0D			Frame sequential
-XX405 3	7E 30 30 34 30 35 20 34 0D			
-XX231 0	7E 30 30 32 33 31 20 30 0D	3D Sync Invert		On
-XX231 1	7E 30 30 32 33 31 20 31 0D			Off
-XX70 1	7E 30 30 37 30 20 31 0D	Language		English
-XX70 2	7E 30 30 37 30 20 32 0D			German
-XX70 3	7E 30 30 37 30 20 33 0D			French
-XX70 4	7E 30 30 37 30 20 34 0D			Italian
-XX70 5	7E 30 30 37 30 20 35 0D			Spanish
-XX70 6	7E 30 30 37 30 20 36 0D			Portuguese
-XX70 7	7E 30 30 37 30 20 37 0D			Polish
-XX70 8	7E 30 30 37 30 20 38 0D			Dutch
-XX70 9	7E 30 30 37 30 20 39 0D			Swedish
-XX70 10	7E 30 30 37 30 20 31 30 0D			Norwegian/Danish
-XX70 11	7E 30 30 37 30 20 31 31 0D			Finnish
-XX70 12	7E 30 30 37 30 20 31 32 0D			Greek
-XX70 13	7E 30 30 37 30 20 31 33 0D			Traditional Chinese
-XX70 14	7E 30 30 37 30 20 31 34 0D			Simplified Chinese
-XX70 15	7E 30 30 37 30 20 31 35 0D			Japanese
-XX70 16	7E 30 30 37 30 20 31 36 0D			Korean
-XX70 17	7E 30 30 37 30 20 31 37 0D			Russian
-XX70 18	7E 30 30 37 30 20 31 38 0D			Hungarian
-XX70 19	7E 30 30 37 30 20 31 39 0D			Czechoslovak
-XX70 20	7E 30 30 37 30 20 32 30 0D			Arabic
-XX70 21	7E 30 30 37 30 20 32 31 0D			Thai
-XX70 22	7E 30 30 37 30 20 32 32 0D			Turkish
-XX70 23	7E 30 30 37 30 20 32 33 0D			Farsi
-XX70 25	7E 30 30 37 30 20 32 35 0D			Vietnamese
-XX70 26	7E 30 30 37 30 20 32 36 0D			Indonesian
-XX70 27	7E 30 30 37 30 20 32 37 0D			Romanian
-XX71 1	7E 30 30 37 31 20 31 0D	Projection		Front-Desktop
-XX71 2	7E 30 30 37 31 20 32 0D			Rear-Desktop
-XX71 3	7E 30 30 37 31 20 33 0D			Front-Ceiling
-XX71 4	7E 30 30 37 31 20 34 0D			Rear-Ceiling
-XX72 1	7E 30 30 37 32 20 31 0D	Menu Location		Top Left
-XX72 2	7E 30 30 37 32 20 32 0D			Top Right
-XX72 3	7E 30 30 37 32 20 33 0D			Centre
-XX72 4	7E 30 30 37 32 20 34 0D			Bottom Left
-XX72 5	7E 30 30 37 32 20 35 0D			Bottom Right

(WXGA/WUXGA Model)

-XX90 1	7E 30 30 39 31 20 31 0D	Screen Type		16:10
-XX90 0	7E 30 30 39 31 20 30 0D			16:9
-XX77 n	7E 30 30 37 37 20 aabccc 0D	Security	Security Timer	Month/Day/Hour n = mm/dd/hh mm= 00 (aa=30 30) - 12 (aa=31 32) dd = 00 (bb=30 30) - 30 (bb=33 30) hh= 00 (cc=30 30) - 24 (cc=32 34)
-XX78 1	7E 30 30 37 38 20 31 0D		Security Settings	On
-XX78 0 -nmmn	7E 30 30 37 38 20 32 20 a 0D			Off(0/2 for backward compatible)
	-nmmn = -0000 (a=7E 30 30 30 30)			-9999 (a=7E 39 39 39 39)
-XX79 n	7E 30 30 37 39 20 a 0D	Projector ID		n = 00 (a=30 30) - 99 (a=39 39)
-XX80 1	7E 30 30 38 30 20 31 0D	Mute	On	
-XX80 0	7E 30 30 38 30 20 30 0D			Off (0/2 for backward compatible)
-XX310 0	7E 30 30 33 31 30 20 30 0D	Internal Speaker	Off	
-XX310 1	7E 30 30 33 31 30 20 31 0D			On
-XX81 n	7E 30 30 38 31 20 a 0D	Volume(Audio)		n = 0 (a=30) - 10 (a=31 30)
-XX89 0	7E 30 30 38 39 20 30 0D	Audio Input		Default
-XX89 1	7E 30 30 38 39 20 31 0D			Audio1
-XX89 3	7E 30 30 38 39 20 33 0D			Audio2
-XX89 4	7E 30 30 38 39 20 34 0D			Audio3
-XX89 5	7E 30 30 38 39 20 35 0D			Audio4
-XX82 1	7E 30 30 38 32 20 31 0D	Logo	Optima	
-XX82 2	7E 30 30 38 32 20 32 0D		User	
-XX82 3	7E 30 30 38 32 20 33 0D		Neutral	
-XX83 1	7E 30 30 38 33 20 31 0D	Logo Capture		
-XX88 0	7E 30 30 38 38 20 30 0D	Closed Captioning	Off	
-XX88 1	7E 30 30 38 38 20 31 0D		cc1	
-XX88 2	7E 30 30 38 38 20 32 0D		cc2	
-XX87 1	7E 30 30 38 37 20 31 0D	Network Status(Read only Return: :Oka, a=0/1 Disconnected/ Connected.		IP Address(Read only Return: "Okaaa_bbb_ccc_ddd"
-XX87 3	7E 30 30 38 37 20 33 0D			Off
-XX454 0/2	7E 30 30 34 35 34 20 30(32) 0D	Crestron	On	
-XX454 1	7E 30 30 34 35 34 20 31 0D			Off
-XX455 0/2	7E 30 30 34 35 35 20 30(32) 0D	Extron	Off	On
-XX455 1	7E 30 30 34 35 35 20 31 0D			On
-XX456 0/2	7E 30 30 34 35 36 20 30(32) 0D	PJLink	Off	On
-XX456 1	7E 30 30 34 35 36 20 31 0D			On
-XX457 0/2	7E 30 30 34 35 37 20 30(32) 0D	AMX Device Discovery	Off	On
-XX457 1	7E 30 30 34 35 37 20 31 0D			On
-XX458 0/2	7E 30 30 34 35 38 20 30(32) 0D	Telnet	Off	On
-XX458 1	7E 30 30 34 35 38 20 31 0D			On
-XX459 0/2	7E 30 30 34 35 38 20 30(32) 0D	HTTP	Off	On
-XX459 1	7E 30 30 34 35 38 20 31 0D			On
-XX39 1	7E 30 30 33 39 20 31 0D	Input Source	HDMI	
-XX39 2	7E 30 30 33 39 20 32 0D			DVI-D
-XX39 3	7E 30 30 33 39 20 34 0D			BNC
-XX39 5	7E 30 30 33 39 20 35 0D			VGA1
-XX39 6	7E 30 30 33 39 20 36 0D			VGA2
-XX39 8	7E 30 30 33 39 20 38 0D			Component
-XX39 9	7E 30 30 33 39 20 39 0D			S-video
-XX39 10	7E 30 30 33 39 20 31 30 0D			Video
-XX39 15	7E 30 30 33 39 20 31 35 0D			DisplayPort
-XX100 1	7E 30 30 31 30 20 30 31 0D	Source Lock	On	
-XX100 0	7E 30 30 31 30 20 30 30 0D		Off (0/2 for backward compatible)	
-XX101 1	7E 30 30 31 30 21 30 31 0D	High Altitude	On	
-XX101 0	7E 30 30 31 30 21 30 30 0D		Off (0/2 for backward compatible)	
-XX102 1	7E 30 30 31 30 32 20 31 0D	Information Hide	On	
-XX102 0	7E 30 30 31 30 32 20 30 0D		Off (0/2 for backward compatible)	
-XX103 1	7E 30 30 31 30 33 20 31 0D	Keypad Lock	On	
-XX103 0	7E 30 30 31 30 33 20 30 0D		Off (0/2 for backward compatible)	
-XX348 0	7E 30 30 33 34 38 20 30 30 0D	Display Mode Lock	Off (0/2 for backward compatible)	
-XX348 1	7E 30 30 33 34 38 20 31 0D		On	
-XX185 0	7E 30 30 31 39 35 20 30 0D	Test Pattern	None	
-XX195 1	7E 30 30 31 39 35 20 31 0D			Grid(White)
-XX195 3	7E 30 30 31 39 35 20 33 0D			Grid(Green)
-XX195 4	7E 30 30 31 39 35 20 34 0D			Grid(Magenta)
-XX185 2	7E 30 30 31 39 35 20 32 0D			White
-XX192 0	7E 30 30 31 39 32 20 30 0D	12V Trigger	Off	
-XX192 1	7E 30 30 31 39 32 20 31 0D		On	
-XX192 2	7E 30 30 31 39 32 20 30 0D		On	Auto 3D
-XX192 3	7E 30 30 31 39 32 20 33 0D		Off	
-XX11 0	7E 30 30 31 31 20 30 0D	IR Function	Off	
-XX11 1	7E 30 30 31 31 20 31 0D		On	
-XX104 1	7E 30 30 31 30 34 20 31 0D	Background Color		Blue
-XX104 2	7E 30 30 31 30 34 20 32 0D			Black
-XX104 3	7E 30 30 31 30 34 20 33 0D			Red
-XX104 4	7E 30 30 31 30 34 20 34 0D			Green
-XX104 5	7E 30 30 31 30 34 20 35 0D			White
-XX105 1	7E 30 30 31 30 35 20 31 0D	Advanced	Direct Power On	On
-XX105 0	7E 30 30 31 30 35 20 30 0D			Off (0/2 for backward compatible)
-XX113 0	7E 30 30 31 31 33 20 30 0D		Signal Power On	Off
-XX113 1	7E 30 30 31 31 33 20 31 0D			On
-XX106 n	7E 30 30 31 30 36 20 a 0D		Auto Power Off (min)	n = 0 (a=30) - 180 (a=31 38 30)

Appendices

(5 minutes for each step).

-XX107 n 7E 30 30 31 30 37 20 a 0D

Sleep Timer (min)

n = 0 (a=30) ~ 995 (a=39 39 35)

(30 minutes for each step).

-XX114 1 7E 30 30 31 31 34 20 31 0D
-XX114 0 7E 30 30 31 31 34 20 30 0D

Power Mode(Standby)

Active (<=5.5W)
Eco. (0/2 for backward compatible)

-XX109 1 7E 30 30 31 30 39 20 31 0D
-XX109 0 7E 30 30 31 30 39 20 30 0D
-XX110 1 7E 30 30 31 31 30 20 31 0D
-XX110 2 7E 30 30 31 31 30 20 32 0D
-XX110 5 7E 30 30 31 31 30 20 35 0D
-XX326 n 7E 30 30 33 32 36 20 a 0D

Lamp Reminder

On
Off (0/2 for backward compatible)

Brightness Mode

Bright

Eco

Power

Power

350W/340W/330W/320W/310W/300W/290W/280W

(n=0)=1/n=2/n=3(n=4)=5/n=6/n=7/n=8)

Lamp Reset

Yes

No (0/2 for backward compatible)

-XX111 1 7E 30 30 31 31 31 20 31 0D
-XX111 0 7E 30 30 31 31 31 20 30 0D

-XX112 1 7E 30 30 31 31 32 20 31 0D Reset

Yes

-XX99 1 7E 30 30 39 39 20 31 0D RS232 Alert Reset

Reset

System Alert

-XX210 n

7E 30 30 32 30 30 20 n 0D Display message on the OSD

n: 1-30 characters

SEND to emulate Remote

-XX140 10 7E 30 30 31 34 30 20 31 30 0D
-XX140 11 7E 30 30 31 34 30 20 31 31 0D
-XX140 12 7E 30 30 31 34 30 20 31 32 0D
-XX140 13 7E 30 30 31 34 30 20 31 33 0D
-XX140 14 7E 30 30 31 34 30 20 31 34 0D
-XX140 15 7E 30 30 31 34 30 20 31 35 0D
-XX140 16 7E 30 30 31 34 30 20 31 36 0D
-XX140 17 7E 30 30 31 34 30 20 31 37 0D
-XX140 18 7E 30 30 31 34 30 20 31 38 0D
-XX140 19 7E 30 30 31 34 30 20 31 39 0D
-XX140 20 7E 30 30 31 34 30 20 32 30 0D
-XX140 21 7E 30 30 31 34 30 20 32 31 0D
-XX140 28 7E 30 30 31 34 30 20 32 38 0D
-XX140 47 7E 30 30 31 34 30 20 34 37 0D

Up

Left

Enter (for projection MENU)

Right

Down

Keystone +

Keystone -

Volume +

Volume -

Brightness

Menu

Zoom

Contrast

Source

SEND from projector automatically

232 ASCII Code	HEX Code	Function	Projector Return	Description
----------------	----------	----------	------------------	-------------

when Standby/Warming/Cooling/Out of Range/Lamp fall/Fan Lock/Over Temperature/Lamp Hours Running Out/Cover Open

INFOn n: 0/1/2/3/4/6/7/8/ = Standby/Warming/Cooling/Out of Range/Lamp fall/Fan Lock/Over Temperature/Lamp Hours Running Out/Cover Open

READ from projector

232 ASCII Code	HEX Code	Function	Projector Return	Description
----------------	----------	----------	------------------	-------------

-XX121 1 7E 30 30 31 32 31 20 31 0D Input Source Commands OKn n: 0/1/2/3/4/5/7/10/15 = None/DVI/VGA1/VGA2/S-Video/Video/BNC/HDMI/Component/DisplayPort

-XX122 1 7E 30 30 31 32 32 20 31 0D Software Version OKdddd dddd: FW version

-XX123 1 7E 30 30 31 32 33 20 31 0D Display Mode OKn n: 0/1/2/3/4/7/9/12

None/Presentation/Bright/Movie/sRGB/Blackboard/DICOM SIM./SD

-XX124 1 7E 30 30 31 32 34 20 31 0D Power State OKn n: 0/1 = Off/On

-XX125 1 7E 30 30 31 32 35 20 31 0D Brightness OKn

-XX126 1 7E 30 30 31 32 36 20 31 0D Contrast OKn

-XX127 1 7E 30 30 31 32 37 20 31 0D Format OKn n: 1/2/3/5/6/7 =4/3/16/9/16/10/LBx/Native/Auto

*16.9 or 16:10 depend on Screen Type setting

-XX128 1 7E 30 30 31 32 38 20 31 0D Color Temperature OKn n: 3/0/1/2 = Warm/Standard/Cool/Cold

-XX129 1 7E 30 30 31 32 39 20 31 0D Projection Mode OKn n: 0/1/2/3 = Front-Desktop/ Rear-Desktop/ Front-Ceiling/ Rear-Ceiling

-XX150 1 7E 30 30 31 35 30 20 31 0D Information OKabbbccddd a: 0/1 = Off/On
bbb: LampHour
cc: source 00/01/02/03/04/05/07/10/15 =

None/DVI/VGA1/VGA2/S-Video/Video/BNC/HDMI/Component/DisplayPort

ddd: FW version

e: Display mode 0/1/2/3/4/7/9/10=

None/Presentation/Bright/Movie/sRGB/Blackboard/SD/DICOM.

-XX151 1 7E 30 30 31 35 31 20 31 0D Model name OKn n:1/2/3=X605/X605/EH505

-XX108 1 7E 30 30 31 30 38 20 31 0D Lamp Hours OKbbbb bbbb: LampHour

-XX108 2 7E 30 30 31 30 38 20 31 0D Cumulative Lamp Hours OKbbbbbb bbbbb: (5 digits) Total Lamp Hours

-XX87 1 7E 30 30 38 37 20 31 0D Network Status OKn n=0/1

Disconnected/Connected

-XX87 3 7E 30 30 38 37 20 33 0D IP Address OKaaa_bbb_ccc_ddd

Telnet Commands

- ▶ Port: support 3 ports of 23/1023/2023
- ▶ Multi-connections: Projector could receive commands from different ports at the same time
- ▶ Command Format: Follow RS232 command format (support both of ASCII and HEX)
- ▶ Command Response: Follow RS232 return message.

Lead Code	Projector ID		Command ID			Space	Variable	Carriage Return
~	X	X	X	X	X		n	CR
Fix code One Digit~	00		Defined by Optoma 2 or 3 Digit. See the Follow content			One Digit	Per item Definition	Fix code One Digit



- ❖ For wide screen resolution (WXGA), the compatibility support is dependent on Notebook/PC models.

AMX Device Discovery commands

- ▶ DP : 239.255.250.250
- ▶ Port No. : 9131
- ▶ Each UDP broadcast information as below are updated around 40 seconds

Command	Description	Remark (Parameter)
Device-UUID	MAC address (Hex value without ':' separator)	12 digits
Device-SKDClass	The Duet DeviceSdk class name	VideoProjector
Device-Make	Maker name	MakerPXLW
Device-Model	Model name	Projector

Command	Description	Remark (Parameter)
Config-URL	Device's IP address LAN IP address is shown up if LAN IP address is valid. Wireless LAN IP address is shown up if Wireless LAN IP address is valid.	http://xxx.xxx.xxx.xxx/index.html
Revision	The revision must follow a major.minor.micro scheme. The revision is only increased if the command protocol is modified.	1.0.0



- ❖ For wide screen resolution (WXGA), the compatibility support is dependent on Notebook/PC models.
- ❖ This AMX function is only to support AMX Device Discovery.
- ❖ The broadcast information only send out through valid interface.
- ❖ Both LAN and Wireless LAN interfaces could be supported at the same time.
- ❖ If "Beacon Validator" was used. Please take care below information.

PJLink™ supported commands

The table below shows commands to control the projector using the PJLink™ protocol.

Command Description Remark (Parameter)

Command	Description	Remark (Parameter)
POWR	Power control	0 = Standby
		1 = Power on
POWR?	Inquiry about the power state	0 = Standby
		1 = Power on
		2 = Cooling down
		3 = Warming up
INPT	INPT Input switching	11 = VGA1



❖ This projector is fully compliant to the specifications of JBMIA PJLink™ Class 1. It supports all the commands defined by PJLink™ Class 1, and the compliance has been verified with the PJLink™ standard specifications Version 1.0.

Command	Description	Remark (Parameter)
INPT?	Inquiry about input switching	12 = VGA2
		13 = Component
		14 = BNC
		21 = VIDEO
		22 = S-VIDEO
		31 = HDMI 1
		32 = HDMI 2
AVMT	Mute control	30 = Video and audio mute disable
AVMT?	Inquiry about the mute state	31 = Video and audio mute enable
ERST?	Inquiry about the error state	1st byte: Fan error, 0 or 2
		2nd byte: Lamp error, 0 to 2
		3rd byte: Temperature error, 0 or 2
		4th byte: Cover open error, 0 or 2
		5th byte: Filter error, 0 or 2
		6th byte: Other error, 0 or 2
		0 to 2 mean as follows: 0 = No error detected, 1 = Warning, 2 = Error
LAMP?	Inquiry about the lamp state	1st value (1 to 5 digits): Cumulative LAMP operating time (This item shows a lamp operating time (hour) calculated based on that LAMP MODE is LOW.)
		2nd value: 0 = Lamp off, 1 = Lamp on
INST?	Inquiry about the available inputs	The following value is returned. "11 12 21 22 31 32"
NAME?	Inquiry about the projector name	The projector name set on the NETWORK menu or the ProjectorView Setup window is returned
INF1?	Inquiry about the manufacturer name	"Optoma" is returned.
INF2?	Inquiry about the model name	"EH7700" is returned.

Command	Description	Remark (Parameter)
INF0?	Inquiry about other information	No other information is available. No parameter is returned.
CLSS?	Inquiry about the class information	"1" is returned.

Trademarks

- ▶ DLP is trademarks of Texas Instruments.
- ▶ IBM is a trademark or registered trademark of International Business Machines Corporation.
- ▶ Macintosh, Mac OS X, iMac, and PowerBook are trademarks of Apple Inc., registered in the U.S. and other countries.
- ▶ Microsoft, Windows, Windows Vista, Internet Explorer and PowerPoint are either a registered trademark or trademark of Microsoft Corporation in the United States and/or other countries.
- ▶ HDMI, the HDMI Logo and High-Definition Multimedia Interface are trademarks or registered trademarks of HDMI Licensing LLC.
- ▶ AMX Device Discovery
The projector is monitored and controlled by the control system of AMX.
- ▶ Crestron RoomView Connected™
The projector is monitored and controlled by the control system and software of Crestron Electronics, Inc.
- ▶ PJLink™
PJLink trademark is a trademark applied for registration or is already registered in Japan, the United States of America and other countries and areas.
This projector supports standard protocol PJLink™ for projector control and you can control and monitor projector's operations using the same application among projectors of different models and different manufacturers.
- ▶ Other product and company names mentioned in this user's manual may be the trademarks or registered trademarks of their respective holders.
- ▶ About Crestron RoomView Connected™
Electronics, Inc. to facilitate configuration of the control system of Crestron and its target devices.

For details, see the website of Crestron Electronics, Inc.

URL <http://www.crestron.com>

URL <http://www.crestron.com/getroomview/>

Ceiling Installation



- ❖ Damage to the projector as a result of incorrect installation voids the warranty.

To prevent damage to your projector please use the recommended mounting package for installation.

To ensure compliance, only use a UL Listed ceiling mount and screws that meet the following specifications:

- ▶ Screw Type: M4
- ▶ Maximum screw length: 11 mm
- ▶ Minimum screw length: 9 mm

Refer to the following diagram to ceiling mount the projector.



- ❖ Ensure at least 10cm clearance between the ceiling and the underside of the projector.
- ❖ Avoid locating the projector near heat sources such as air conditioning and heaters. Excess heat may cause the projector to power off.

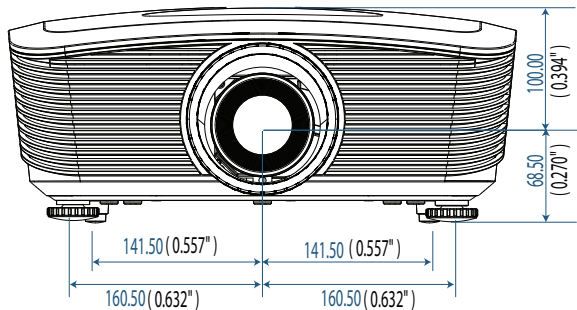
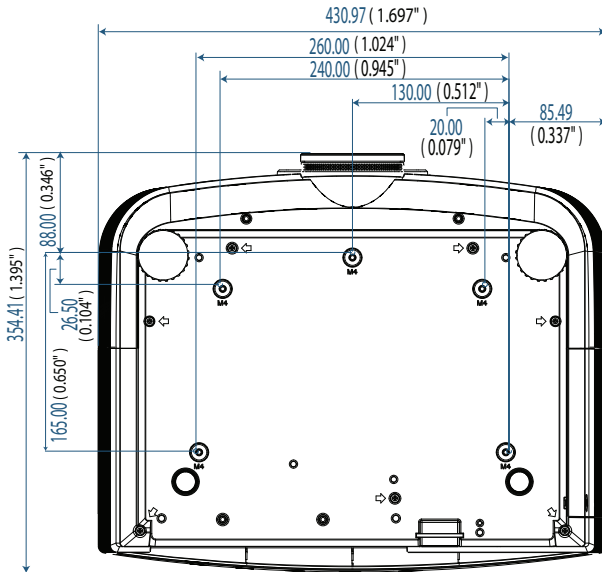

Optoma Global Offices

For service or support please contact your local office.

USA

3178 Laurelview Ct.
Fremont, CA 94538, USA
Tel : 888-289-6786
www.optomausa.com

Fax : 510-897-8601
Service : services@optoma.com

Canada

2420 Meadowpine Blvd., Suite #105
Mississauga, ON, L5N 6S2, Canada
Tel : 888-289-6786
www.optoma.ca

Fax : 510-897-8601
Service : services@optoma.com

Europe

42 Caxton Way, The Watford Business Park
Watford, Hertfordshire, WD18 8QZ, UK
Tel : +44 (0) 1923 691 800
www.optoma.eu
Service Tel : +44 (0)1923 691865

Fax : +44 (0) 1923 691 888
Service : service@tsc-europe.com

France

Bâtiment E 81-83 avenue Edouard Vaillant
92100 Boulogne Billancourt, France
Tel.: +33 1 41 46 12 20
Service : savoptoma@optoma.fr

Fax : +33 1 41 46 94 35

Spain

C/ José Hierro,36 Of. 1C
28522 Rivas VaciaMadrid, Spain
Tel.: +34 91 499 06 06

Fax : +34 91 670 08 32

Deutschland

Werftstrasse 25 D40549
Düsseldorf, Germany
Tel : +49 (0) 211 506 6670
Service : info@optoma.de

Fax : +49 (0) 211 506 66799

Scandinavia

Optoma Scandinavia AS
Lerpeveien 25
3040 Drammen
Norway

PO.BOX 9515
3038 Drammen
Norway

Tel : +4732988990

Fax : +4732988999

Service : info@optoma.no

Latin America

3178 Laurelview Ct.
Fremont, CA 94538, USA
Tel : 888-289-6786

Fax : 510-897-8601

www.optomausa.com.br

Service : www.optomausa.com.mx

Korea

WOOMI TECH.CO.,LTD
4F,Minu Bldg.3.tw3-14, Kangnam-Ku, seoul,135-815, KOREA
Tel : +82+2+34430004

Fax : +82+2+34430005

Japan

東京都足立区綾瀬3-25-18
株式会社オーエスエム
サポートセンター:0120-46-5040
E-mail : info@osscreen.com

www.os-worldwide.com

Taiwan

231, 新北市新店區北新路3段215號12樓

Tel : +886-2-8911-8600

Fax : +886-2-8911-9770

www.optoma.com.tw

asia.optoma.com

Service : services@optoma.com.tw

Hong Kong

Unit A, 27/F Dragon Centre, 79 Wing Hong Street,
Cheung Sha Wan, Kowloon, Hong Kong

Tel : +852-2396-8968

Fax : +852-2370-1222

www.optoma.com.hk

China

5F, No. 1205, Kaixuan Rd., Changning District
Shanghai, 200052, China

Tel : +86-21-62947376

Fax : +86-21-62947375

www.optoma.com.cn

Regulation & Safety notices

This appendix lists the general notices of your projector.

FCC notice

This device has been tested and found to comply with the limits for a Class B digital device pursuant to Part 15 of the FCC rules. These limits are designed to provide reasonable protection against harmful interference in a residential installation. This device generates, uses, and can radiate radio frequency energy and, if not installed and used in accordance with the instructions, may cause harmful interference to radio communications.

However, there is no guarantee that interference will not occur in a particular installation. If this device does cause harmful interference to radio or television reception, which can be determined by turning the device off and on, the user is encouraged to try to correct the interference by one or more of the following measures:

- ▶ Reorient or relocate the receiving antenna.
- ▶ Increase the separation between the device and receiver.
- ▶ Connect the device into an outlet on a circuit different from that to which the receiver is connected.
- ▶ Consult the dealer or an experienced radio/television technician for help.

Notice: Shielded cables

All connections to other computing devices must be made using shielded cables to maintain compliance with FCC regulations.

Caution

Changes or modifications not expressly approved by the manufacturer could void the user's authority, which is granted by the Federal Communications Commission, to operate this projector.

Operation conditions

This device complies with Part 15 of the FCC Rules. Operation is subject to the following two conditions:

1. This device may not cause harmful interference, and
2. This device must accept any interference received, including interference that may cause undesired operation.

Notice: Canadian users

This Class B digital apparatus complies with Canadian ICES-003.

Remarque à l'intention des utilisateurs canadiens

Cet appareil numérique de la classe B est conforme à la norme NMB-003 du Canada.

Declaration of Conformity for EU countries

- ▶ EMC Directive 2004/108/EC (including amendments)
- ▶ Low Voltage Directive 2006/95/EC
- ▶ R & TTE Directive 1999/5/EC (if product has RF function)

Disposal instructions



Do not throw this electronic device into the trash when discarding. To minimize pollution and ensure utmost protection of the global environment, please recycle it.

Free Manuals Download Website

<http://myh66.com>

<http://usermanuals.us>

<http://www.somanuals.com>

<http://www.4manuals.cc>

<http://www.manual-lib.com>

<http://www.404manual.com>

<http://www.luxmanual.com>

<http://aubethermostatmanual.com>

Golf course search by state

<http://golfingnear.com>

Email search by domain

<http://emailbydomain.com>

Auto manuals search

<http://auto.somanuals.com>

TV manuals search

<http://tv.somanuals.com>