



Table of Contents

Table of Contents	1
Usage Notice.....	2
Safety Information	2
Precautions.....	3
Eye Safety Warnings	5
Introduction.....	6
Product Features	6
Package Overview.....	7
Product Overview	8
Main Unit.....	8
Control Panel	9
Connection Ports	10
Remote Control with Mouse Function and Laser Pointer	11
Installation	12
Connecting the Projector	12
Connect to Computer/Notebook	12
Connect to Video	13
Powering On/Off the Projector.....	14
Powering On the Projector.....	14
Powering Off the projector	15
Warning Indicator.....	15
Adjusting the Projected Image.....	16
Adjusting the Projector's Height.....	16
Adjusting the Projector's Zoom / Focus	17
Adjusting Projected Image Size	18
User Controls	19
Control Panel & Remote Control	19
On-Screen Display Menus.....	23
How to operate	23
Menu Tree.....	24
Image	25
Display	30
Setup.....	34
Options.....	46
Appendices.....	49
Troubleshooting.....	49
Image Problems	49
Intermission Problems	52
Projector Status Indication	52
Remote Control Problems	53
Replacing the Lamp.....	55
Compatibility Modes	57
RS232 Commands and Protocol Function List.....	58
Ceiling Mount Installation	61
Optoma Global Offices	62
Regulation & Safety notices	64

Safety Information

	The lightning flash with arrow head within an equilateral triangle is intended to alert the user to the presence of uninsulated "dangerous voltage" within the product's enclosure that may be of sufficient magnitude to constitute a risk of electric shock to persons.
	The exclamation point within an equilateral triangle is intended to alert the user to the presence of important operating and maintenance (servicing) instructions in the literature accompanying the appliance.

WARNING: TO REDUCE THE RISK OF FIRE OR ELECTRIC SHOCK, DO NOT EXPOSE THE PROJECTOR TO RAIN OR MOISTURE. DANGEROUS HIGH VOLTAGES ARE PRESENT INSIDE THE ENCLOSURE. DO NOT OPEN THE CABINET. REFER SERVICING TO QUALIFIED PERSONNEL ONLY.

Class B emissions limits

This Class B digital apparatus meets all requirements of the Canadian Interference-Causing Equipment Regulations.

Important Safety Instruction

1. Read these instructions -before using this projector.
 2. Keep these instructions -for future reference.
 3. Follow all instructions.
 4. Install in accordance with the manufacturer's instructions :
 - A. Do not block any ventilation openings.** To ensure reliable operation of the projector and to protect it from overheating, put the projector in a position and location that will not interfere with its proper ventilation. For example, do not place the projector on a bed, sofa, carpet, or similar surface that may block the ventilation openings. Do not put it in an enclosure, such as a bookcase or a cabinet that may keep air from flowing through its ventilation openings.
 - B. Do not use this projector near water or moisture.** To reduce the risk of fire or electric shock, do not expose the projector to rain or moisture.
 - C. Do not install near any heat sources,** such as radiators, heaters, stoves or other apparatus (including amplifiers) that produce heat.
 5. Clean only with a dry cloth.
 6. Only use attachments/accessories specified by the manufacturer.
 7. Refer all servicing to qualified service personnel. Servicing is required when the projector has been damaged in any way:
 - Such as power supply cord or plug is damaged.
 - Liquid has been spilled or objects have fallen into the apparatus.
 - The projector has been exposed to rain or moisture, does not operate normally, or has been dropped.
- Do not attempt to service this projector yourself. Opening or removing covers may expose you to dangerous voltages or other hazards. Please call Optoma to be referred to an authorized service center near you.
8. Do not let objects or liquids enter the projector -as they may touch dangerous voltage points or short-out parts that could result in a fire or electric shock.
 9. See projector enclosure for safety related markings.
 10. The projector should not be adjusted or repaired by anyone except properly qualified service personnel.

Precautions



Please follow all warnings, precautions and maintenance as recommended in this user's guide.

- Warning- Do not look into the projector's lens when the lamp is on. The bright light may damage your eyes.
- Warning- To reduce the risk of injury to the eyes, do not look directly into the laser light on the remote control and do not point the laser light into anyone eyes. This remote control is equipped with a Class II laser that emits radiation.
- Warning- To reduce the risk of fire or electric shock, do not expose this projector to rain or moisture.
- Warning- Please do not open or disassemble the projector as this may cause electric shock.
- Warning- When replacing the lamp, please allow unit to cool down, and follow all replacement instructions. See pages 55-56.
- Warning- This projector will detect the life of the lamp itself. Please be sure to change the lamp when it shows warning messages.
- Warning- Use the "Lamp Reset" function from the on-screen display "Options | Lamp Settings" menu after replacing the lamp module (refer to page 48).
- Warning- When switching the projector off, please ensure the cooling cycle has been completed before disconnecting the power. Allow 90 seconds for the projector to cool down.
- Warning- Do not close the lens door when projector is in operation.
- Warning- When the lamp is approaching to the end of its life time, the message " " will show on the screen. Please

Note

- ❖ When the lamp reaches the end of its life, the projector will not turn back on until the lamp module has been replaced. To replace the lamp, follow the procedures listed under "Replacing the Lamp" section on pages 55-56.

Usage Notice



Replacement Suggested!

Lamp is approaching the end of its useful life

contact your local reseller or service center to change the lamp as soon as possible.



Do:

- ■ Turn off the product before cleaning.
- ■ Use a soft cloth moistened with a mild detergent to clean the display housing.
- ■ Disconnect the power plug from the AC outlet if the product is not being used for a long period of time.



Don't:

- ■ Do not block the ventilation slots and openings on the unit.
- ■ Do not use abrasive cleaners, waxes or solvents to clean the unit.
- ■ Do not use under the following conditions:
 - In extremely hot, cold or humid environments.
 - ▶ Ensure that the ambient room temperature is within 5°C - 35°C / 41°F - 95°F.
 - ▶ Relative Humidity is 5°C - 35°C / 41°F - 95°F, 80% (Max.), non-condensing
 - In areas susceptible to excessive dust and dirt.
 - Near any appliance that generates a strong magnetic field.
 - In direct sunlight.

Eye Safety Warnings



- ■ Avoid staring directly into the projector's beam of light at all times.
- ■ Minimize standing facing into the beam. Keep your back to the beam as much as possible.
- ■ Using a stick or laser pointer is recommended to avoid the need for the presenter to enter the beam.
- ■ Ensure that projectors are located out of the line of sight from the screen to the audience; this ensures that, when presenters look at the audience, they do not also have to stare at the projector lamp. The best way to achieve this is by ceiling-mounting the projector rather than placing it on floor or table top.
- ■ When projector is used in a classroom, adequately supervise students when they are asked to point out something on the screen.
- ■ In order to minimize the lamp power needed, use room blinds to reduce ambient light levels.

Product Features

*This product is an XGA single chip 0.7" DLP® projector.
Outstanding features include:*

- ◆ True XGA, 1024 x 768 addressable pixels
- ◆ Texas Instruments Single chip DLP® Technology
- ◆ NTSC/NTSC4.43/PAL/PAL-M/PAL-N/SECAM and HDTV compatible (480i/p, 576i/p, 720p, 1080i, 1080p)
- ◆ Auto source detection with user definable settings
- ◆ Full function IR remote mouse control with laser pointer
- ◆ User friendly multilingual On Screen Menu
- ◆ Advanced digital keystone correction and high quality full screen image re-scaling
- ◆ User friendly control panel
- ◆ Two built-in speaker with 5 Watt amplifier
- ◆ 6 dedicated audio inputs
- ◆ UXGA, WXGA, SXGA, SXGA+ compression and VGA, SVGA re-sizing
- ◆ Macintosh and PC compatible
- ◆ HDMI and DVI-D support (HDCP compliant)
- ◆ Horizontal and Vertical Lens Shift
- ◆ Power Zoom and Power Focus
- ◆ Support Network function

Package Overview

This projector comes with all the items shown below. Check to make sure your unit is complete. Contact your dealer immediately if anything is missing.



Projector



Power Cord 1.8m



VGA Cable 1.8m



USB Cable 1.8m



IR Remote Control



RS232 Cable 1.8m
(available in USA and
ASIA regions only)



Note
Due to the difference in applications for each country, some regions may have different accessories.



2 x AAA Batteries

Documentation :

- User's Manual
- Warranty Card
- Quick Start Card
- WEEE Card

Introduction

Product Overview

Main Unit

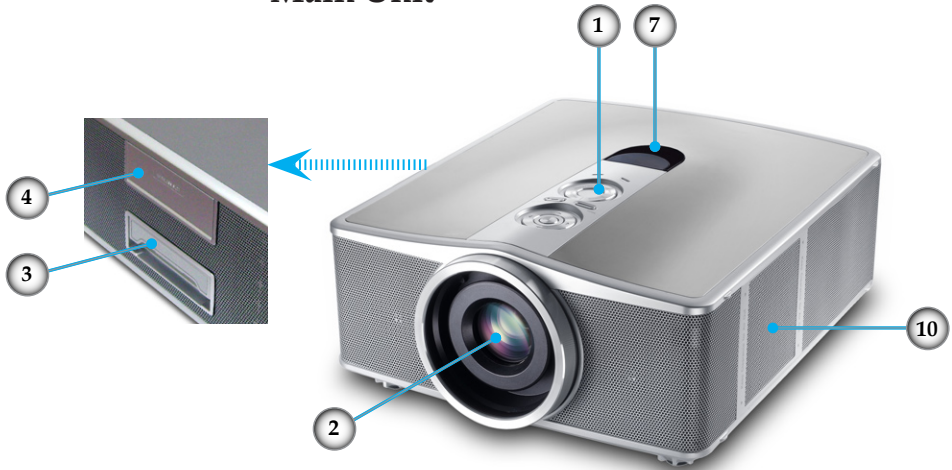

1. Control Panel
2. Zoom Lens
3. Carry Bar
4. Wireless Module (Optional)
5. Lamp Door
6. Elevator Feet
7. IR Receiver
8. Connection Ports
9. Power Socket
10. Air Exhaust Vent

Introduction

Control Panel

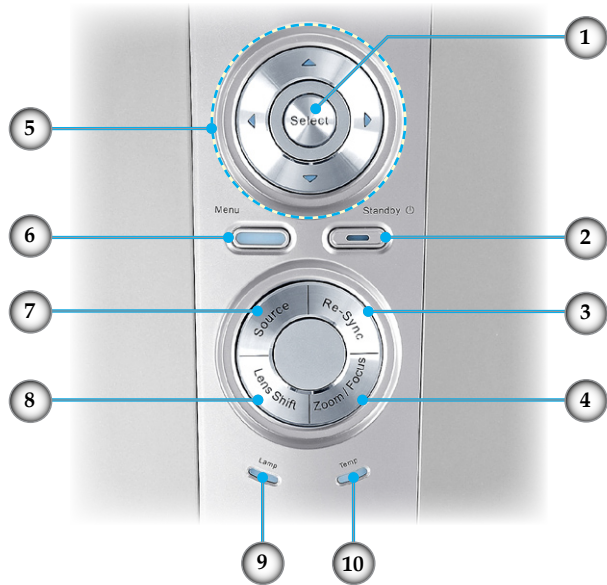

1. Enter/Select
2. Power Button/Power LED
3. Re-Sync
4. Zoom/Focus
5. Four Directional Select Keys
6. Menu
7. Source
8. Lens Shift
9. Lamp LED
10. Temp LED

Introduction

Connection Ports

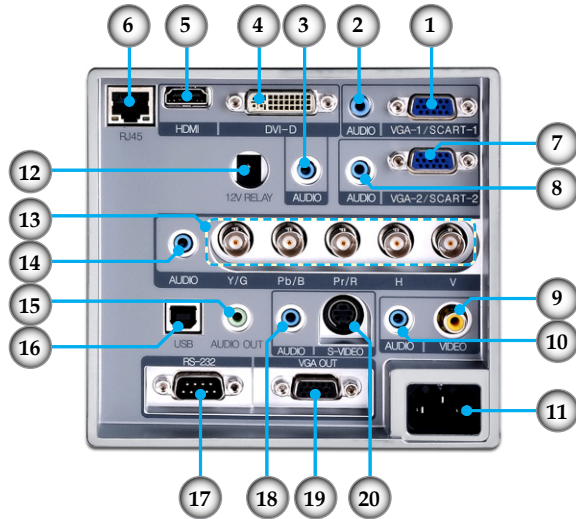

1. VGA-1/SCART-1 Input Connector (PC Analog Signal/ Component Video/HDTV/SCART)
2. Audio-In (for VGA1-In Connector)
3. Audio-In (for DVI-D Connector)
4. DVI-D Input Connector (PC Digital and HDCP)
5. HDMI Connector (HDCP)
6. Networking Connector RJ45
7. VGA-2/SCART-2 Input Connector (PC Analog Signal/ Component Video/HDTV/SCART)
8. Audio-In (for VGA2-In Connector)
9. Composite Video Input Connector
10. Audio-In (for Video Connector)
11. Power Socket
12. +12V Relay Connector
13. BNC Input Connector (YPbPr/RGBHV)
14. Audio-In (for BNC Connector)
15. Audio-Out Connector
16. USB Connector (Connect to PC for Remote Mouse function)
17. RS-232 Connector
18. Audio-In (for S-Video Connector)
19. VGA-Out Connector (Monitor Loop-through Output)
20. S-Video Input Connector

Remote Control with Mouse Function and Laser Pointer

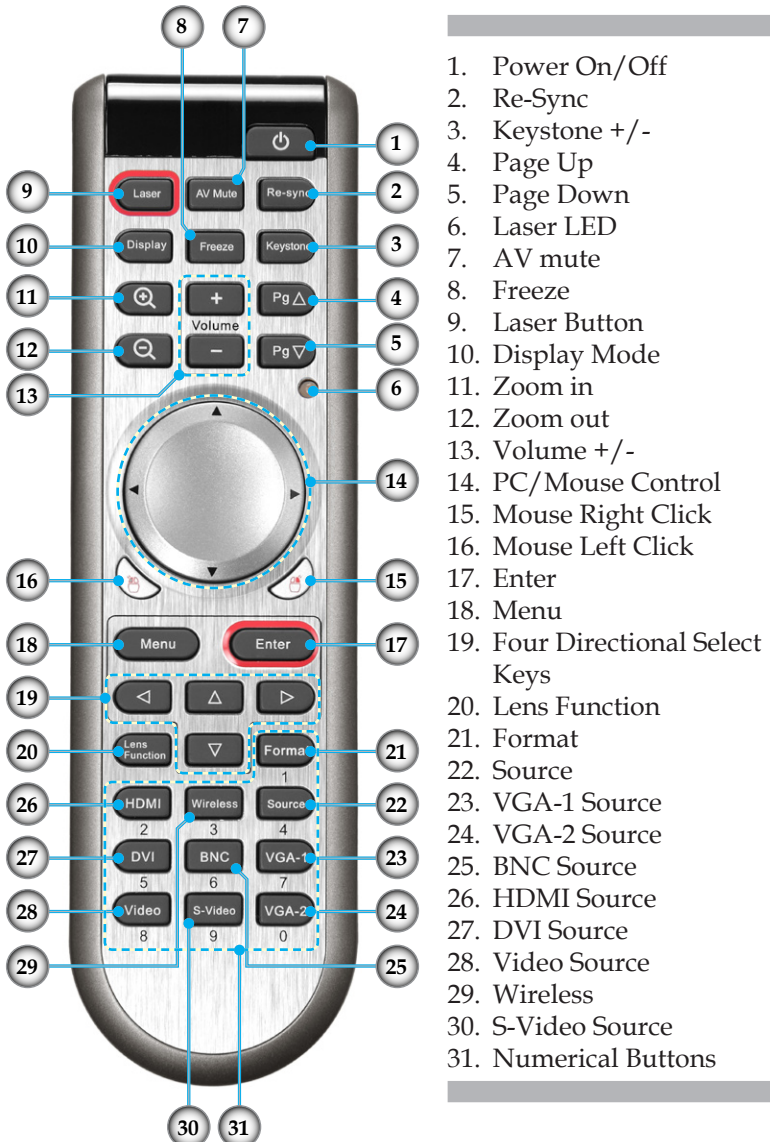

Connecting the Projector

Connect to Computer/Notebook

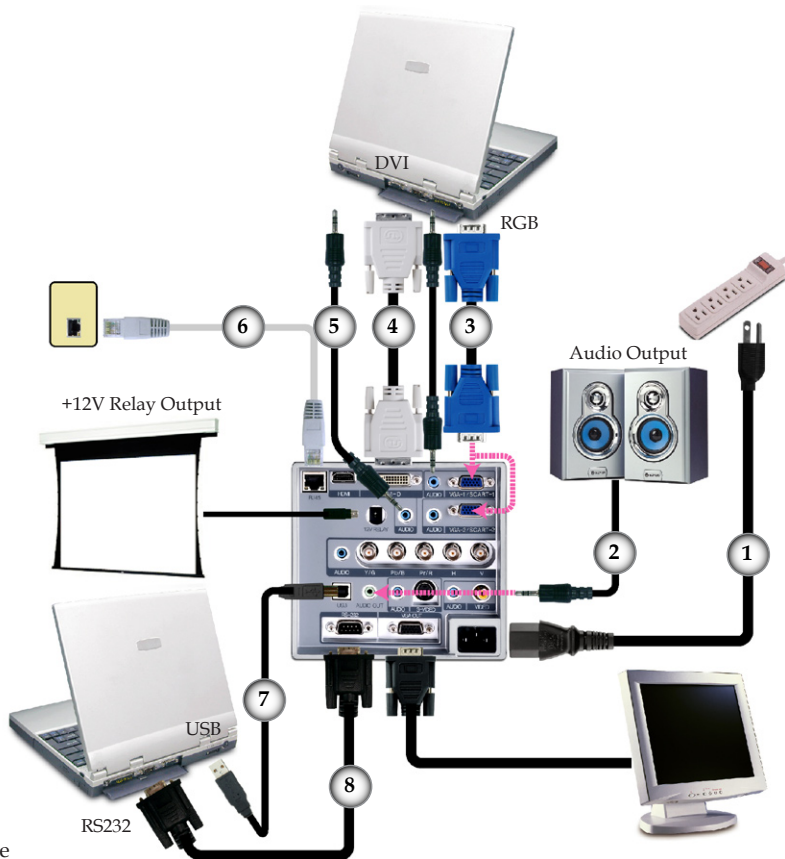

Note
Due to the difference in applications for each country, some regions may have different accessories.

- 1..... Power Cord
- 2..... Audio Output Cable
- 3..... VGA Cable
- 4..... DVI Cable (Optional Accessory)
- 5..... Audio Input Cable (Optional Accessory)
- 6..... Network Cable
- 7..... USB Cable
- 8..... RS232 Cable (Optional Accessory)

Installation

Connect to Video

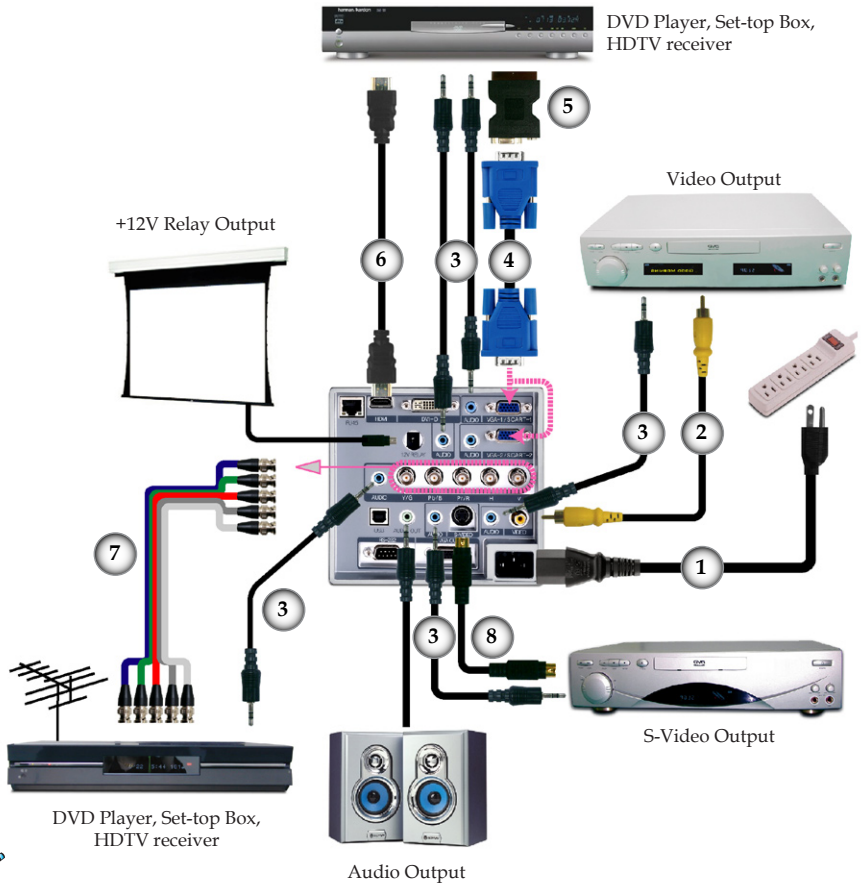

Note

Due to the difference in applications for each country, some regions may have different accessories.

- | | |
|--------|--|
| 1..... | Power Cord |
| 2..... | Composite Video Cable (Optional Accessory) |
| 3..... | Audio Input Cable (Optional Accessory) |
| 4..... | VGA Cable |
| 5..... | SCART RGB/S-Video Adaptor (Optional Accessory) |
| 6..... | HDMI Cable |
| 7..... | BNC Cable (Optional Accessory) |
| 8..... | S-Video Cable |

Powering On/Off the Projector

Powering On the Projector

1. Remove the lens cap. ❶
2. Ensure that the power cord and signal cable are securely connected. ❷ The Power LED lights red.
3. Turn on the lamp by pressing “Power/Standby” button either on the top of the projector or pressing “Power” button on the remote. The Power LED will turn blue.

The startup screen will display in approximately 10 seconds. The first time you use the projector, you can select your preferred language from quick menu after the startup screen display.

4. Turn on your source (computer, notebook, video player, etc.). The projector will detect your source automatically.
- ❖ If you connect multiple sources at the same time, press the “Source” button on the control panel or direct source key on the remote control to switch between inputs.

Note

- ❖ Turn on the projector first and then select the signal sources.



Lens Cap



Power/Standby

Powering Off the Projector

1. Press the “Power/Standby” button to turn off the projector lamp, you will see a message displayed on the projector’s screen.

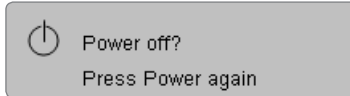

2. Press the “Power/Standby” button again to confirm, otherwise the message will disappear after 15 seconds. When you press “Power/Standby” button second, the system will show the timing countdown on the screen.
3. The cooling fans continue to operate for about 10 seconds for cooling cycle. When the Power LED turn red, the projector has entered standby mode.
If you wish to turn the projector back on, you must wait until the projector has completed the cooling cycle and has entered standby mode. Once in standby mode, simply press “Power/Standby” button to restart the projector.
4. Disconnect the power cord from the electrical outlet and the projector.
5. Do not turn on the projector immediately following a power off procedure.

Warning Indicator

- ❖ When the “LAMP” indicator lights red, the projector will automatically shut itself down. Please contact your local reseller or service center. See pages 62-63.
- ❖ When the “TEMP” indicator lights red, it indicates the projector has overheated. The projector will automatically shut itself down.
Under normal conditions, the projector can be switched on again after it has cooled down. If the problem persists, you should contact your local dealer or our service center. See pages 62-63.
- ❖ When the “TEMP” indicator flashes red, it indicates the fan has failed. Please contact your local dealer or our service center. See pages 62-63.

Adjusting the Projected Image

Adjusting the Projector's Height

The projector is equipped with elevator feet for adjusting the image height.

To raise/lower the image:

1. Locate the elevator foot you wish to modify on the under side of the projector.
2. Rotate the elevator foot counter clockwise to raise the projector or clockwise to lower it. Repeat with the remaining feet as needed.
3. Reset the projector on its feet and re-adjust as needed.



Elevator Feet



Adjusting the Projector's Zoom / Focus

The projector will focus at distances from 3.9 to 39.4 feet (1.2 to 12.0 meters).



- ❖ See Page 41 for more information.



■ Adjusting the Projector' Zoom

1. Press "Zoom/Focus" button, you can see the "Unlock zoom/focus?" message on the screen.
2. Press "Yes" and ▲▼ the backlight will turn green, then you can use ▲ or ▼ to zoom in or zoom out.



■ Adjusting the Projector' Focus

1. Press "Zoom/Focus" button, you can see the "Unlock zoom/focus?" message on the screen.
2. Press "Yes" and ◀▶ the backlight will turn red, then you can use ◀ or ▶ to focus the image.

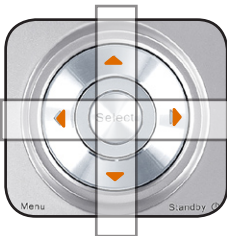

■ Adjusting the Projector' Lens Shift

1. Press "Lens Shift" button, you can see the "Unlock lens shift?" message on the screen.
2. Press "Yes" and ▲▼◀▶ the backlight will turn orange, then you can use ▲▼◀▶ to shift the projected image.

Installation

Adjusting Projection Image Size

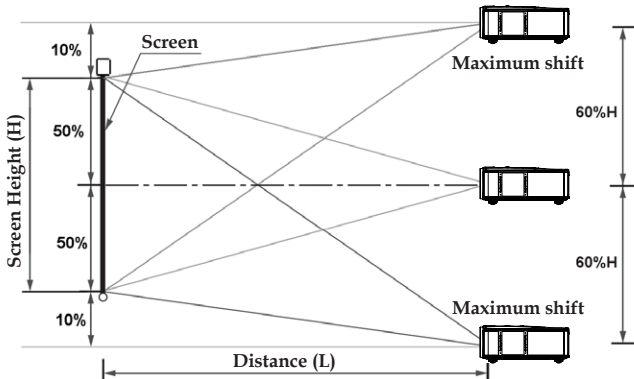

Vertical Direction

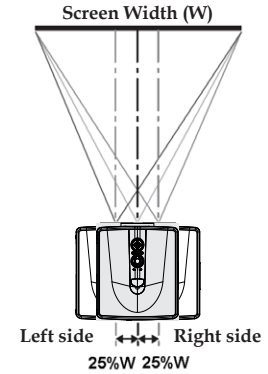

Horizontal Direction

Lens Shift Range

XGA (1024 x 768)	Standard Lens (1.2m~12m)				Long Throw Lens (1.8m~20m)			
Screen Size	Throw Distance (L)				Throw Distance (L)			
4:3	Wide		Tele		Wide		Tele	
Throw Ratio	2.00		2.40		2.90		5.50	
(inch)	(m)	(feet)	(m)	(feet)	(m)	(feet)	(m)	(feet)
30	1.2	4.0	1.5	4.8	1.8	5.8	3.4	11.0
60	2.4	8.0	2.9	9.6	3.5	11.6	6.7	22.0
100	4.1	13.3	4.9	16.0	5.9	19.3	11.2	36.6
150	6.1	20.0	7.3	24.0	8.8	29.0	16.8	55.0
200	8.1	26.6	9.8	32.0	11.8	38.6	22.4	73.3
250	10.2	33.3	12.2	40.0	14.7	48.3	27.9	91.6
300	12.2	40.0	14.6	48.0	17.7	58.0	33.5	109.9

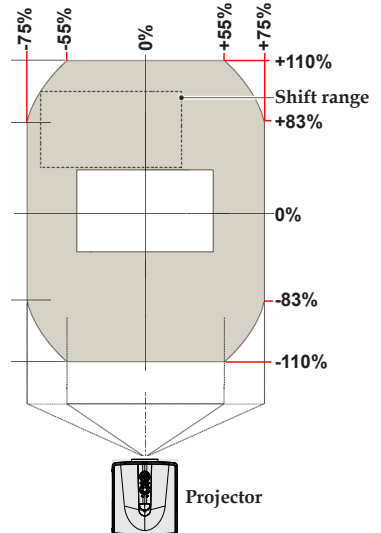

❖ This graph is for user's reference only.

Control Panel & Remote Control

There are two ways for you to control the functions:
Control Panel and Remote Control.



Using the Control Panel



⏻ Power/Stand-by	Refer to the "Power On/Off the Projector" section on pages 14-15.
Power LED	Indicate the projector's status.
Lamp LED	Indicate the projector's lamp status.
Temp LED	Indicate the projector's temperature status.
Menu	Press "Menu" to launch the on-screen display (OSD) menu. To exit OSD, Press "Menu" again.
Enter/Select	Confirm your item selection.
Source	Press "Source" to select an input signal.
Re-Sync	Automatically synchronizes the projector to the input source.
Four Directional Select Keys	Use ▲ ▼ ◀ ▶ to select items or make adjustments to your selection.

User Controls

Using the Control Panel

- Zoom/Focus** Adjusts zoom/focus. After pressing this button, you will see the message “
” displayed on the screen. Press “Yes” to adjust zoom/focus. If you want to adjust the zoom, press ▲ or ▼ and the backlight will turn green. If you want to adjust the focus, press ◀ or ▶ and the backlight will turn red.
- Lens Shift** Shifts the projected image. After pressing this button, you will see the message “
” displayed on the screen. Press “Yes” and ▲ ▼ ◀ ▶ the backlight will turn orange, then you can use ▲ ▼ ◀ ▶ to shift the projected image.



Using the Remote Control

- Power** Refer to the “Power On/Off the Projector” section on pages 14-15.
- Laser Button** Aim the remote at the viewing screen, press and hold this button to activate the laser pointer.
- Laser Indicator LED** Indicate the laser’s status.
- PC/Mouse control (*)** The PC/Mouse control can be used to control mouse movement. The mouse function is enabled using the USB cable to connect your computer and the projector.
- L Button (*)** Mouse left click.
- R Button (*)** Mouse right click.
- Pg▲ Page up (*)** Use this button to page up.
- Pg▼ Page down (*)** Use this button to page down.

User Controls



Using the Remote Control

Re-Sync	Automatically synchronizes the projector to the input source.
Keystone	Adjusts image distortion caused by tilting the projector.
AV Mute	Momentarily turns off/on the audio and video.
Freeze	Press "Freeze" to pause the screen image. Press this button again to unlock.
Volume +/-	Adjusts to increase/decrease the volume.
Display Mode	Select the display mode from Presentation, Bright, Movie, sRGB, User1 and User2.
Zoom in	Zoom in to magnify the digital image.
Zoom out	Zoom out to reduce the digital image.
Enter	Confirm your item selection.
Menu	Press "Menu" to launch the on-screen display (OSD) menu. To exit OSD, Press "Menu" again.
Four Directional Select Keys	Use ▲ ▼ ◀ ▶ to select items or make adjustments to your selection.
Format	Display the "Format" section of the on-screen display menu to select the desired aspect ratio.
Lens Function	Display the "Lens Function" section of the on-screen display menu. See page 17 for more information.
Source	Press "Source" to select an input signal.
Wireless	Press "Wireless" to choose wireless source. (only functional with optional wireless module)

Note

(*): Mouse controls require USB connection to computer

User Controls



Using the Remote Control

HDMI	Press "HDMI" to choose source from HDMI connector.
BNC	Press "BNC" to choose source from YPbPr/RG-BHV connector.
DVI	Press "DVI" to choose source from DVI-D source.
VGA-1	Press "VGA-1" to choose source from VGA-1/SCART-1 connector.
Numerical Buttons	Press "0~9" to input a password in the "Security settings".
S-Video	Press "S-Video" to choose S-Video source.
VGA-2	Press "VGA-2" to choose source from VGA-2/SCART-2 connector.
Video	Press "Video" to choose Composite video source.

Using the USB Remote Mouse Control

The remote control for this projector can be used as a remote mouse control with the USB cable.



When the projector is connected to PC via the USB cable, the remote will work as a mouse for control.

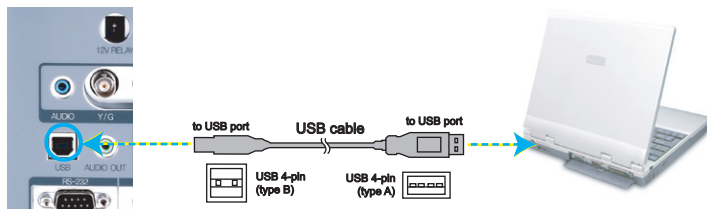

On-Screen Display Menus

The Projector has a multi-lingual On-Screen Display menu which allows adjustments to the projector settings. The projector will automatically detect the source.

How to operate

1. To open the OSD menu, press “Menu” on the Remote Control or Projector Keypad.
2. When OSD is displayed, use ◀▶ keys to select any item in the main menu. While making a selection on a particular page, press ▼ or “Enter” key to enter sub menu.
3. Use ▲▼ keys to select the desired item and adjust the settings by ◀▶ key.
4. Select the next item to be adjusted in the sub menu and adjust as described above.
5. Press “Enter” to confirm, and the screen will return to the main menu.
6. To exit, press “Menu” again. The OSD menu will close and the projector will automatically save the new settings.

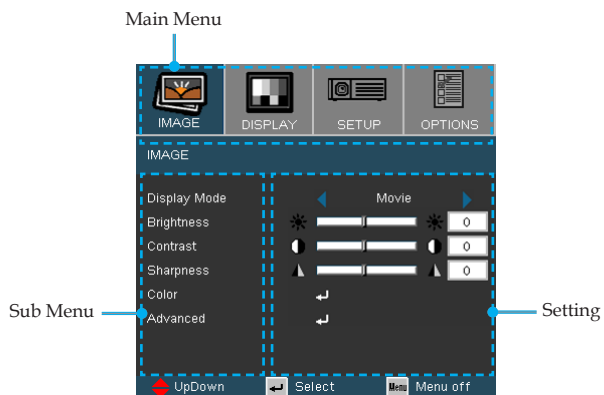

Image

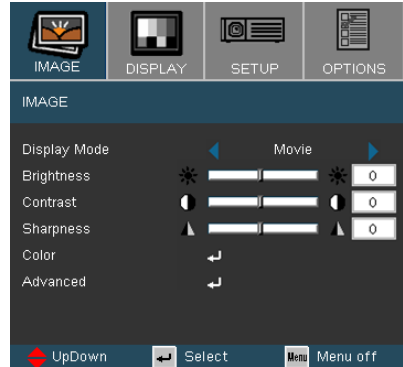

Display Mode

There are many factory presets optimized for various types of images.

- ▶ Presentation: Good color and brightness from PC input.
- ▶ Bright: Maximum brightness from PC input.
- ▶ Movie: For home theater.
- ▶ sRGB: Standardized accurate color.
- ▶ User1: User's own settings.
- ▶ User2: The initial default settings of this mode is from Movie mode. Any further adjustments by the user in User2 will be saved in this mode for future use.

Brightness

Adjust the brightness of the image.

- ▶ Press the ◀ to darken image.
- ▶ Press the ▶ to lighten the image.

Contrast

The contrast controls the degree of difference between the lightest and darkest parts of the picture. Adjusting the contrast changes the amount of black and white in the image.

- ▶ Press the ◀ to decrease the contrast.
- ▶ Press the ▶ to increase the contrast.

Sharpness

Adjust the sharpness of the image.

- ▶ Press the ◀ to decrease the sharpness.
- ▶ Press the ▶ to increase the sharpness.

Image | Color

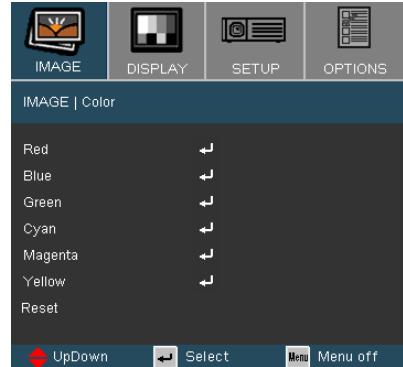

Color

Adjust the Red, Green, Blue, Cyan, Magenta and Yellow colors or returns to the factory default settings for advanced adjustment of the individual colors. Every colors can be adjusted as below.



■ Hue

Adjust the color balance of red and green.

- ▶ Press the ◀ to increase the amount of green in the image.
- ▶ Press the ▶ to increase the amount of red in the image.

■ Saturation

Adjust a video image from black and white to fully saturated color.

- ▶ Press the ◀ to decrease the amount of color in the image.
- ▶ Press the ▶ to increase the amount of red in the image.

■ Gain

Use ◀ or ▶ to adjust Red, Green, Blue, Cyan, Magenta and Yellow colors for brightness (Gain).

Reset

Choose “Yes” to return the factory default settings for color adjustments.

Image | Advanced

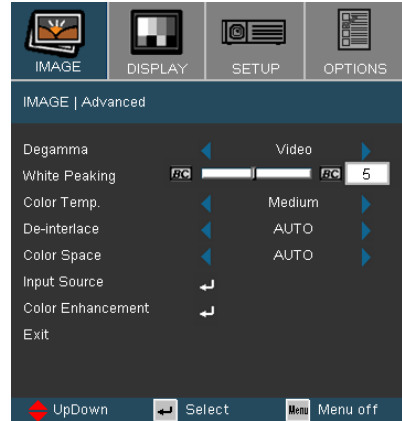

Degamma

This allows you to choose a degamma table that has been fine-tuned to bring out the best image quality for the input.

- ▶ Film: for home theater.
- ▶ Video: for video or TV source.
- ▶ Graphics: for image source.
- ▶ PC: for PC or computer source.

White Peaking

This adjustable item utilizes a new color-processing algorithm and system level enhancements to enable higher brightness while providing true, more vibrant colors in picture. The range is from "0" to "10". If you prefer a stronger enhanced image, adjust toward the maximum setting. For a smoother, more natural image, adjust toward the minimum setting.

Color Temp.

Adjust the color temperature. At "Cold" temperature, the screen looks colder; at "Warm" temperature, the screen looks warmer.

De-interlace (*)

This function converts an interlaced video signal into a progressive signal.

- ▶ Auto: Automatically switch the mode of Deinterlace.
- ▶ Video: Switch Deinterlace mode to video mode for video source or TV source.
- ▶ Film: Switch Deinterlace mode to film mode for video source or TV source.



Remark (*): It only support when source is composite, S-video, and 480i/576i via component.

User Controls

Color Space

Select an appropriate color matrix type from AUTO, RGB or YUV.

Input Source

Enable input sources. Press ◀ or ▶ into the next menu as below and then use ▲ or ▼ to select. Press “Enter” to finalize the selection. The projector will not search inputs that are de-selected.

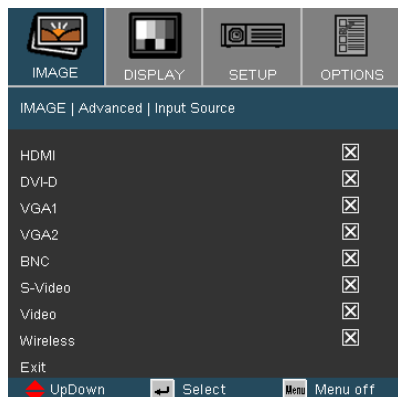
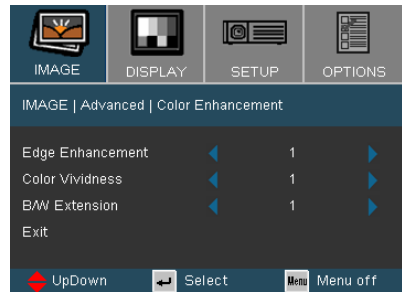

Image | Advanced | Color Enhancement



Edge Enhancement (*)

You can use the "Off", 1~5 to adjust the Edge Enhancement in the image.

Color Vividness (*)

This adjustable item utilizes a new color-processing algorithm and enhancements to enable the picture's vividness to be significantly increased.

B/W Extension (*)

Black and White Extension can stretch the black and white levels to automatically increase the contrast of input image. There are many preset modes that allow the user to obtain different image effects. (0: Off/1:On).



Remark (*): It can not support when source is composite, S-video, and 480i/576i via component.

Display

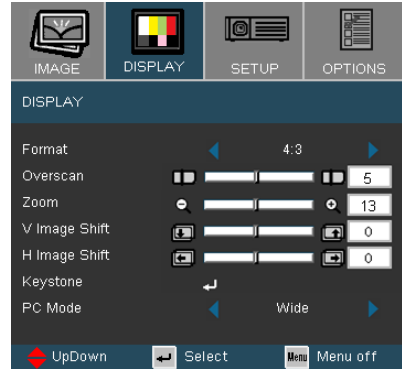

Format

Use this function to choose your desired aspect ratio.

- ▶ 4:3: This format is for 4x3 input sources not enhanced for Wide screen TV.
- ▶ 16:9 I: This format is for 16x9 input sources, like HDTV and DVD enhanced for Wide screen TV. (576i/p)
- ▶ 16:9 II: This format is for 16x9 input sources, like HDTV and DVD enhanced for Wide screen TV.(480i/p)
- ▶ Window: When a 4:3 image is bigger than a 16:9 screen, select the “Window” mode to fit the image onto the screen without changing the projection distance.

Source	480i/p	576i/p	720p	1080i/p	PC
4:3	Scale to 1024 x 768				
16:9 I	Scale to 1024 x 576				
16:9 II	Scale to 854 x 480				
Window	Scale to 800 x 600				

User Controls

Overscan

Overscan function removes the noise in a video image. Overscan the image to remove video encoding noise on the edge of video source.

Zoom

- ▶ Press the ◀ to reduce the size of an image.
- ▶ Press the ▶ to magnify an image on the projection screen.

V Image Shift

Shift the projected image position vertically(Digital).

H Image Shift

Shift the projected image position horizontally(Digital).

PC Mode

This mode is only functional when the projector unit is used with a PC signal, either via an Analog or Digital connector.

- ▶ Wide: If your PC output is a wide screen format resolution you must select this setting.

Examples of Wide screen resolutions are: 720 x 400 / 854 x 480 / 1280 x 720 / 1280 x 768.

- ▶ Normal: If your PC output is a Normal (4:3) resolution you must select this setting.

Examples of Normal resolutions are: 640 x 480 / 800 x 600 / 1024 x 768 / 1152 x 870 (for MAC) / 1280 x 1024 / 1400 x 1050.*

*All supported resolutions are listed on page 57.



- ❖ "PC Mode" function is only supported under RGB source.

Display | Keystone

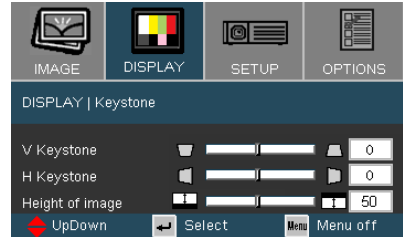

V Keystone

Press the ◀ or ▶ to adjust image distortion vertical and makes a squarer image.

H Keystone

Press the ◀ or ▶ to adjust image distortion horizontal and makes a squarer image.

Height of Image

Press the ◀ or ▶ to fine-adjust the vertical position of the image to fit the screen size better

User Controls

Setup | Language



Language

Choose the multilingual OSD menu. Press ◀ or ▶ into the sub menu and then use the ▲ or ▼ key to select your preferred language. Press "Enter" to finalize the selection.

Setup



Projection



Front-Desktop

The factory default setting.



Rear-Desktop

When you select this function, the projector reverses the image so you can project behind a translucent screen.



Front-Ceiling

When you select this function, the projector turns the image upside down for ceiling-mounted projection.



Rear-Ceiling

When you select this function, the projector reverses and turns the image upside down at same time. You can project from behind a translucent screen with ceiling mounted projection.

Menu Location

Choose the menu location on the display screen.

Mute

- ▶ Choose the "On" to turn mute on.
- ▶ Choose the "Off" to turn mute off.

User Controls

Volume

- ▶ Press the ◀ to decrease the volume.
- ▶ Press the ▶ to increase the volume.

RS232

- ▶ RS232: Allows RS232 control of an individual projector.
- ▶ Network: Allows projector control via web browser (Internet Explorer) using the network. (Default setting)



Projector ID

ID definition can be set up by menu (range 00~99), and allow user control an individual projector by RS232. For more related information, please refer page 59-60.

Setup | Signal

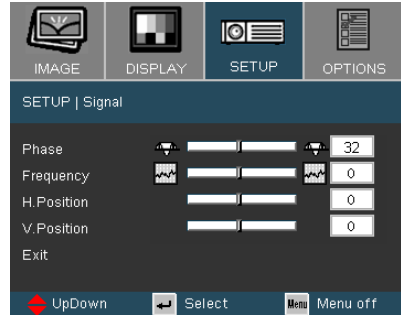

Phase

“Phase” synchronizes the signal timing of the display with the graphic card. If you experience an unstable or flickering image, use this function to correct it.

Frequency

“Frequency” changes the display data frequency to match the frequency of your computer’s graphic card. If you experience a vertical flickering bar, use this function to make an adjustment.

H. Position

- ▶ Press the ◀ to move the image left.
- ▶ Press the ▶ to move the image right.

V. Position

- ▶ Press the ◀ to move the image down.
- ▶ Press the ▶ to move the image up.

Setup | Security Setting

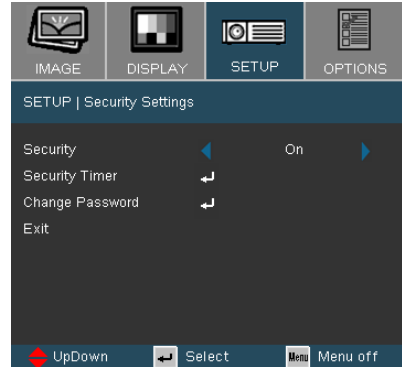

Security

- ▶ On: Choose "On" to use security verification when the turning on the projector.
- ▶ Off: Choose "Off" to be able to switch on the projector without password verification.

Security Timer

Can be select the time (Month/Day/Hour) function to set the number of hours the projector can be used. Once this time has elapsed you will be requested to enter your password again.

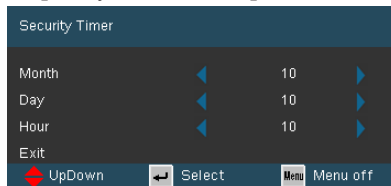





User Controls

■ First Time:

1. The Password is 4 digits, DEFAULT VALUE is "1234". (first time)
2. Use number buttons on the remote to select your password, and then press "" key to confirm your selection.

Change Password

1. Press "" to input old password.
2. Use number button to enter current password, and then press "" key again to reveal next OSD menu.
3. Scroll down to highlight Password, and then press "" to activate.
4. Enter new password (4 digits in length) using the number buttons on the remote, then press "" to confirm.
5. Enter new password again and press "" to confirm.

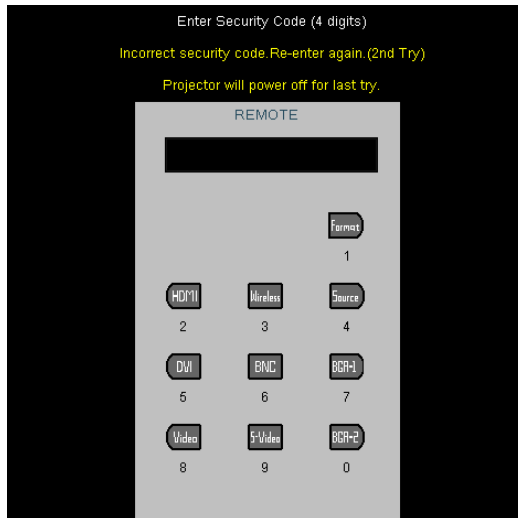

Setup | Advanced

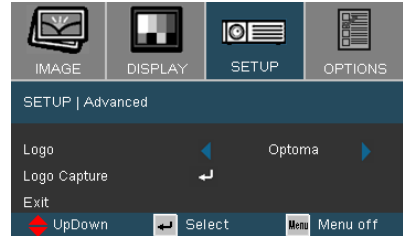

Logo

Use this function to select your desired startup screen. If you change the setting from one to another, when you exit the OSD menu, the new setting will take effect on next open.

- ▶ Optoma: The default startup screen of Optoma projector.
- ▶ User: Use memorize picture from “Logo Capture” function.

Logo Capture

Press “Enter” to immediately capture a picture what on the display screen.

Setup | Lens Function

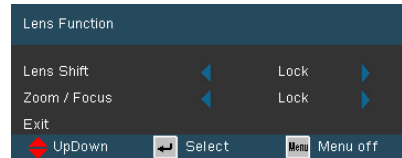

Lens Shift

Shift the projected image.

- ▶ Lock: This function can not be used by user.
- ▶ Unlock: This function can be used by user.

Zoom/Focus

Adjust zoom/focus function on the projected image.

- ▶ Lock: This function can not be used by user.
- ▶ Unlock: This function can be used by user.

Setup | Network

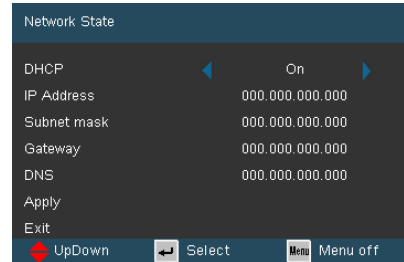

DHCP

Use this function to select your desired startup screen. If you change the setting from one to another, when you exit the OSD menu, the new setting will take effect on next open.

- ▶ On: Assign an IP address to the projector from the DHCP server automatically.
- ▶ Off: Assign an IP address manually.

IP Address

Select an IP address.

Subnet Mask

Select subnet mask number.

Gateway

Select the default gateway of the network connected to the projector.

DNS

Select DNS number.

Apply

Press to confirm the settings.

User Controls

How to use web browser to control your projector

1. Fill in a new IP, a subnet mask, a gateway and a DNS in the dialogue box.

Network State

DHCP	On
IP Address	000.000.000.000
Subnet mask	000.000.000.000
Gateway	000.000.000.000
DNS	000.000.000.000

Apply
Exit

UpDown Select Menu Menu off

2. Then choose apply and press “Enter” button to activate the configuration process.
3. Open your web browser and type in from the OSD LAN screen then the web page will display as below:

Home Control Panel Network Setting Alert Setting Logout

Welcome to the Optoma Projector Web Server
IP: 10.0.50.100

Projector Status

System Status: Power ON
Display Source: None
Lamp Hours: 0 hr
Display Mode:
Error Status:
FW Version: B003

Power OFF

4. Open “Control Panel” to control your projector.

Home Control Panel Network Setting Alert Setting Logout

Control Panel

Power OFF

Brightness Mode OFF Re-sync
Source Lock ON AV Mute
Freeze Information Hide ON
Logo Capture Signal Power ON
High Altitude ON Keypad Lock ON
Volume Mute ON

SOURCE
Source: None

IMAGE
Display Mode: Bright
Brightness: 004
Contrast: 003
Sharpness: 000
White Peaking: 10
Degamma: PC
Color temp: Medium
Color Space: Auto

DISPLAY
Display Format: 4.3
Overscan: 000
PC Mode: Normal
V. Image Shift: 000
H. Image Shift: 000

V. Keystone: 000
H. Keystone: 000

SETUP
Projection: Front
Menu Location: Center
Volume: 08
Projector ID: 00
Logo: Optoma
Phase: 16
Tracking: 000

OPTIONS
Background Color: Black
Auto Power OFF: 000
Sleep timer: 000

User Controls

For example: Use Microsoft Internet Explorer (IE) web browser to control the projector, the IP address is `http:// 10.0.50.100`.

Step 1: Find an IP Address (10.0.50.100) from LAN function of projector.

IP Address	10.0.50.100
------------	-------------

Step 2: Select apply and press "Enter" button to submit function or press "menu" key to exit.

Step 3: To open Network Connections, click Start, click Control Panel, click Network and Internet Connections, and then click Network Connections. Click the connection you want to configure, and then, under Network Tasks , click Change settings of this connection.

Step 4: On the General tab, under This connection uses the following items, click Internet Protocol (TCP/IP), and then click "Properties."

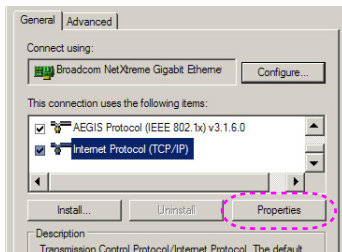

Step 5: Click Use the following IP address, and type in as below:

- 1) IP address: 10.0.50.XXX
- 2) Subnet mask: 255.255.0.0
- 3) Default gateway: 10.0.50.254

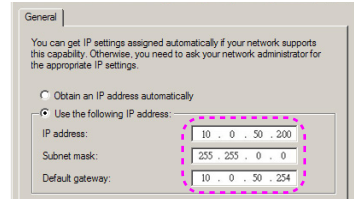

Step 6: To open Internet Options, click IE web browser, click Internet Options, click the Connections tab and click "LAN Settings..."

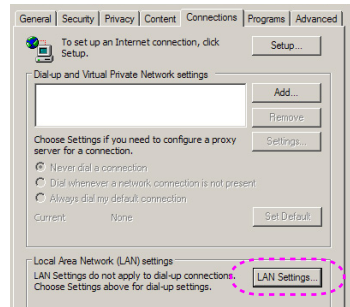

Step 7: The Local Area Network (LAN) Setting dialog box appears, In the Proxy Server area, cancel the Use a proxy server for your LAN check box., then click "OK" button twice.

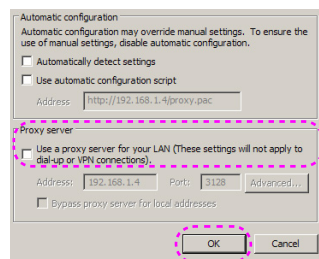

User Controls

Step 8: Open your IE and type in the IP address of 10.0.50.100 in the URL then press "Enter" key. The web page will display as below:

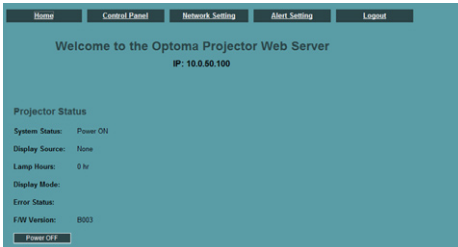

Step 9: Open "Control Panel" to control your projector.

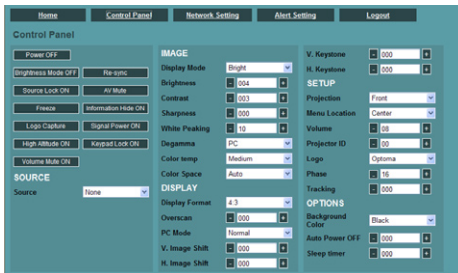

Options

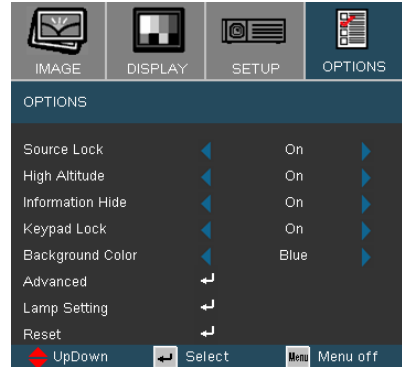

Source Lock

- ▶ On: The projector will search specified connection port.
- ▶ Off: The projector will search for other signals if the current input signal is lost.

High Altitude

Choose "On" to turn on High Altitude mode. Operates the fans at full speed continuously to allow for proper high altitude cooling of the projector.

Information Hide

- ▶ On: Choose "On" to hide the searching message.
- ▶ Off: Choose "Off" to show the searching message.

Keypad Lock

When the keypad lock function is on, the control panel will be locked, but the projector can still be operated by the remote control. If canceling this function, use the remote control and select this function to "Off".

Background Color

Use this feature to display a "Black", "Red", "Blue", "Green" or "White" screen when no signal is available.

Reset

Choose "Yes" to return the display parameters on all menus to the factory default settings.

Options | Advanced

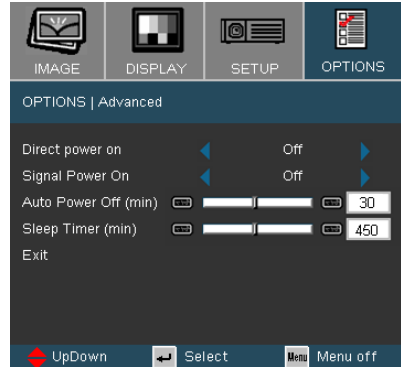

Direct Power On

- ▶ On: The projector will automatically power on when AC power is supplied, without pressing the "Power/Standby" key on the projector control panel or "Power" key on the remote control.
- ▶ Off: Turn on the projector to normal mode.

Signal Power On

- ▶ On: The projector will automatically power on when any signal is supplied, without turn on the power key on the input equipment control panel or "Power" key on the remote control.
- ▶ Off: Turn on the projector to normal mode.

Auto Power Off

Set the countdown timer interval. The countdown timer will start, when there is no signal being sent to the projector. Then projector will automatically power off when the countdown has finished (in minutes).

Sleep Timer

Set the countdown timer interval. The timer will begin, with or without a signal input. Then the projector will automatically power off then the sleep timer countdown has finished. (in minutes)

Options | Lamp Settings

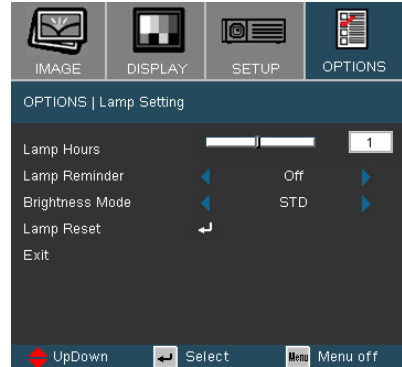

Lamp Hours

Display the projection time.

Lamp Reminder

Choose this function to show or to hide the warning message when the changing lamp message is displayed. The message will appear 30 hours before suggested replacement of lamp.

Brightness Mode

- ▶ STD: Choose "STD" to dim the projector lamp which will lower power consumption and extend the lamp life by up to 130%.
- ▶ Bright: Choose "Bright" to increase the brightness.

Lamp Reset

Reset the lamp life hour after replacing the lamp.

Troubleshooting

*If you experience a problem with your projector, please refer to the following information. If a problem persists, please contact your local reseller or service center.
(See pages 62-63 for details)*

Image Problems

[?] No image appears on-screen

- ▶ Ensure all the cables and power connections are correctly and securely connected as described in the "Installation" section.
- ▶ Ensure all the pins of connectors are not bent or broken.
- ▶ Check if the projection lamp has been securely installed. Please refer to the "Replacing the lamp" section.
- ▶ Make sure you have opened the lens door and the projector is switched on.
- ▶ Ensure that the "AV Mute" feature is not turned on.

[?] Partial, scrolling or incorrectly displayed image

- ▶ Press "Re-Sync" on the remote control or control panel.
- ▶ If you are using a PC:

For Windows 95, 98, 2000, XP:

1. Open the "My Computer" icon, the "Control Panel" folder, and then double click on the "Display" icon.
2. Select the "Settings" tab.
3. Verify that your display resolution setting is lower than or equal to UXGA (1600 x 1200). (*)
4. Click on the "Advanced Properties" button.

If the projector is still not projecting the whole image, you will also need to change the monitor display you are using. Refer to the following steps.

5. Verify the resolution setting is lower than or equal to UXGA (1600 x 1200) resolution.

Note

- ❖ (*) The resolution XGA (1024 x 768) is recommended for computer signal.

Appendices



❖ (*) The resolution XGA (1024 x 768) is recommend for computer signal.

6. Select the "Change" button under the "Monitor" tab.
 7. Click on "Show all devices". Next, select "Standard monitor types" under the SP box; choose the resolution mode you need under the "Models" box.
 8. Verify that the resolution setting of the monitor display is lower than or equal to UXGA (1600 x 1200) (*)
- ▶ If you are using a Notebook:
1. First, follow the steps above to adjust resolution of the computer.
 2. Press the toggle output settings. Example: [Fn]+[F4]

Acer ⇒	[Fn]+[F5]	IBM/Lenovo ⇒	[Fn]+[F7]
Asus ⇒	[Fn]+[F8]	HP/Compaq ⇒	[Fn]+[F4]
Dell ⇒	[Fn]+[F8]	NEC ⇒	[Fn]+[F3]
Gateway ⇒	[Fn]+[F4]	Toshiba ⇒	[Fn]+[F5]

Mac Apple:
System Preference ⇒ Display ⇒ Arrangement ⇒ Mirror display

- ▶ If you experience difficulty changing resolutions or your monitor freezes, restart all equipment including the projector.

[?] The screen of the Notebook or PowerBook computer is not displaying your presentation

- ▶ If you are using a Notebook PC
Some Notebook PCs may deactivate their own screens when a second display device is in use. Each has a different way to be reactivated. Refer to your computer's manual for detailed information.

[?] Image is unstable or flickering

- ▶ Use "Phase" to correct it. See page 37 for more information.
▶ Change the monitor color setting on your computer.

[?] Image has vertical flickering bar

- ▶ Use "Frequency" to make an adjustment. See page 37 for more information.
▶ Check and reconfigure the display mode of your graphic card to make it compatible with the projector.

[?] Image is out of focus

- ▶ Make sure the lens cap is remove.
- ▶ Adjust the Focus Ring on the projector lens.
- ▶ Make sure the projection screen is between the required Standard lens 3.9 to 41.0 feet (1.2 to 12.5 meters)/Tele lens 13.1 to 58.0 feet (4.0 to 17.7 meters).

[?] The image is stretched when displaying 16:9 DVD title

When you play anamorphic DVD or 16:9 DVD, the projector will show the best image in 16:9 format on projector side.

If you play 4:3 format DVD title, please change the format as 4:3 in projector OSD.

If the image is still stretched, you will also need to adjust the aspect ratio by referring to the following:

- ▶ Please setup the display format as 16:9 (wide) aspect ratio type on your DVD player.

[?] Image is too small or too large

- ▶ Adjust the Zoom Ring on the top of the projector.
- ▶ Move the projector closer to or further from the screen.
- ▶ Press [Menu] button on the remote control or projector panel, go to "Display → Format" and try the different settings.

[?] Image has slanted sides

- ▶ If possible, reposition the projector so that it is centered on the screen and below the bottom of the screen.
- ▶ Press [Keystone] button on the remote control or press [▲/▼] on the projector panel, until the sides are vertical on the remote control.

[?] Image is reversed

- ▶ Select "Setup → Projection" from the OSD and adjust the projection direction.



❖ Use of Keystone is not recommended.

Intermission Problems

- [?] The projector stops responding to all controls**
 - ▶ If possible, turn off the projector, then unplug the power cord and wait at least 60 seconds before reconnecting power.
- [?] Lamp burns out or makes a popping sound**
 - ▶ When the lamp reaches its end of life, it will burn out and may make a loud popping sound. If this happens, the projector will not turn on until the lamp module has been replaced. To replace the lamp, follow the procedures in the “Replacing the Lamp” section on pages 55-56.

Projector Status Indication

[?] LED lighting message

Message	Power/Standby LED		Temp-LED	Lamp-LED
	(Blue)	(Red)	(Red)	(Red)
Standby State (Input power cord)	○	☀	○	○
Standby State (Burn in Mode)	○	☀	☀	☀
Power on (Press power button)	☀	○	○	○
Power off (Cooling)	○	○	○	○
Error (Over Temp.)	☀	○	☀	○
Error (Fan fail)	☀	○	Flashing	○
Error (Lamp fail)	☀	○	○	☀
Download Mode	☀	○	☀	☀



Steady light ⇨ ☀

No light ⇨ ○

[?] Message Reminders

▶ Fan failed:



▶ Temperature warning:

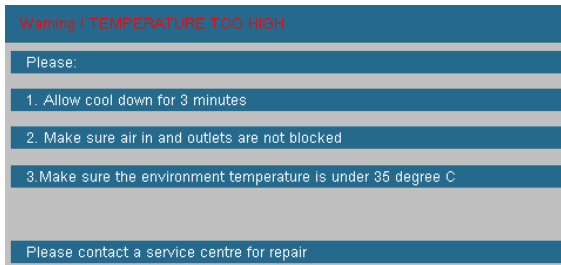

▶ Replacing the lamp:

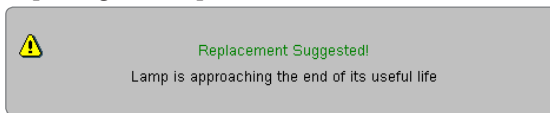

▶ Status message for searching source:

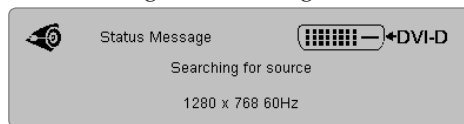

Remote Control Problems

[?] If the remote control does not work

- ▶ Check the operating angle for the remote control is approximately $\pm 22.5^\circ$.

Appendices

- ▶ Make sure there are no obstructions between the remote control and the projector. Move to within 6 m (20 ft) of the projector.
- ▶ Make sure the batteries are inserted correctly.
- ▶ Replace weak batteries in the remote control.

Replacing the lamp



The projector automatically detects the lamp life. When the lamp life is nearing the end of use, you will receive a warning message.



Replacement Suggested!

Lamp is approaching the end of its useful life

When you see this message, please contact your local reseller or service center to change the lamp as soon as possible. Make sure the projector has been cooled down for at least 30 minutes before changing the lamp.

-  **Warning:** If ceiling mounted, please use caution when opening the lamp access panel. It is recommended to wear safety glasses if changing the bulb when ceiling mounted. "Caution must be used to prevent any loose parts from falling out of projector."
-  **Warning:** Lamp compartment may be hot! Allow it to cool down before changing the lamp!
-  **Warning:** To reduce the risk of personal injury, do not drop the lamp module or touch the lamp bulb. The bulb may shatter and cause injury if it is dropped.

Appendices

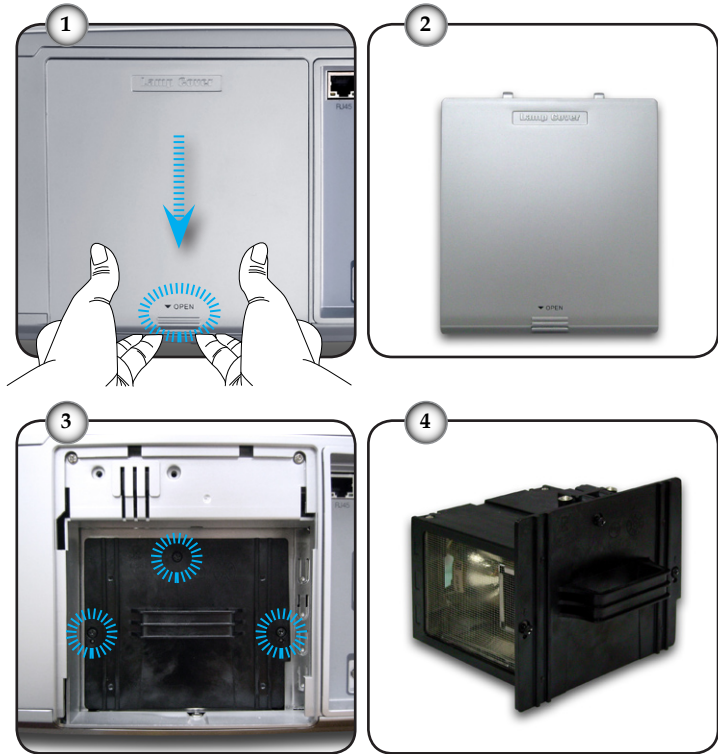

○ Lamp Replacement Procedure: ○

1. Switch off the power to the projector by pressing the "Power/Standby" button.
 2. Allow the projector to cool down for at least 30 minutes.
 3. Disconnect the power cord.
 4. Press OPEN and then pull down the lamp cover carefully. ❶
 5. Open the lamp cover. ❷
 6. Use a screwdriver to remove the 3 screws from the lamp module. ❸
 7. Remove the lamp module. ❹
- To replace the lamp module, reverse the previous steps.
8. Turn on the projector and use "Lamp Reset" after the lamp module is replaced.
- Lamp Reset: (i) Press "Menu" → (ii) Select "Options" → (iii) Select "Lamp settings" → (iv) Select "Lamp reset" → (v) Select "On".

Compatibility Modes

► Computer Compatibility

Mode	Resolution	V-Sync (Hz)	
		Analog	Digital
VGA	640 x 350	70, 85	***
VGA	640 x 400	85	***
VGA	640 x 480	60, 72, 75, 85	60, 72, 75, 85
VGA	720 x 400	70, 85	70
SVGA	800 x 600	56, 60, 72, 75, 85	60, 72, 75
XGA	1024 x 768	60, 70, 75, 85	60, 70, 75
* SXGA	1152 x 864	70, 75, 85	***
* SXGA	1280 x 1024	60, 75, 85	60, 75
* SXGA+	1400 x 1050	60	60
* UXGA	1600 x 1200	60	60
Wide	1280 x 720	***	50, 60
Power Book G4, VGA	640 x 480	60, 72, 75, 85	
Power Book G4, SXGA	800 x 600	60, 75, 85	
Power Book G4, XGA	1024 x 768	60, 70, 75, 85	
* Power Book G4, WXGA	1280 x 768	60, 70	
* Power Book G4, HD	1280 x 720	60	
* Power Book G4, HD	1280 x 1024	60, 75	
* Power Book G4, SXGA+	1400 x 1050	60	
* Power Book G4, UXGA	1600 x 1200	60	
Power G4, VGA	640 x 480	72, 75, 85	
Power G4, SXGA	800 x 600	60, 75, 85	
Power G4, XGA	1024 x 768	60, 70, 75, 85	
* Power G4, WXGA	1280 x 768	60	
* Power G4, HD	1280 x 1024	60, 75	
* Power G4, UXGA	1600 x 1200	60	
i MAC	1024 x 768	60	***



1. "*" compressed computer image.
2. For widescreen resolution (WXGA), the compatibility support is dependent on Notebook/PC models.

► Video Compatibility

NTSC	M (3.58MHz), 4.43 MHz, 480i/p @60Hz
PAL	B, D, G, H, I, M, N, 576i/p @50Hz
SECAM	B, D, G, K, K1, L
HDTV	480p, 576p, 720p, 1080i (50/60 Hz)

RS232 Commands and Protocol Function List

RS232 Pin Assignments

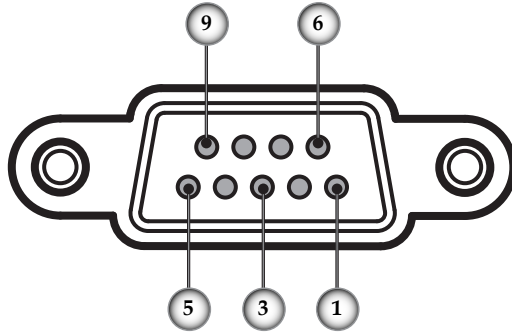

Pin no.	Name	I/O (From Projector Side)
1	NC	—
2	RXD	IN
3	TXD	OUT
4	NC	—
5	NC	—
6	NC	—
7	RS232	RTS
8	RS232	CTS
9	NC	—

RS232 Protocol Function List



Baud Rate : 9600
 Data Bits : 8
 Parity : None
 Stop Bits : 1
 Flow Control : None
 UART16550 FIFO : Disable
 Projector Return (Pass) : P
 Projector Return (Fail) : F
 XX=01-99, projector's ID,
 XX=00 is for all projectors



1. There is a <CR> after all ASCII commands.
2. 0D is the HEX code for <CR> in ASCII code.

SEND to projector			
232 ASCII HEX Code	Function		Description
-XX00 1	7E 30 30 30 20 31 0D	Power ON	
-XX00 2	7E 30 30 30 20 32 0D	Power OFF	
-XX00 1-nmmn		Power On with Password	
-XX01 1	7E 30 30 30 31 20 31 0D	Resync	
-XX02 1	7E 30 30 30 32 20 31 0D	AV Mute	On
-XX02 2	7E 30 30 30 32 20 32 0D		Off
-XX03 1	7E 30 30 30 33 20 31 0D	Mute	On
-XX03 2	7E 30 30 30 33 20 32 0D		Off
-XX04 1	7E 30 30 30 34 20 31 0D	Freeze	
-XX04 2	7E 30 30 30 34 20 32 0D	Unfreeze	
-XX05 1	7E 30 30 30 35 20 31 0D	Zoom Plus	
-XX06 1	7E 30 30 30 36 20 31 0D	Zoom Minus	
-XX07 1	7E 30 30 30 37 20 31 0D	Up (Pan under zoom)	
-XX08 1	7E 30 30 30 38 20 31 0D	Down (Pan under zoom)	
-XX09 1	7E 30 30 30 39 20 31 0D	Left (Pan under zoom)	
-XX10 1	7E 30 30 31 30 20 31 0D	Right (Pan under zoom)	
-XX11 1	7E 30 30 31 32 20 31 0D	Direct Source Selector	HDMI
-XX11 2	7E 30 30 31 32 20 32 0D		DVI-D
-XX11 3	7E 30 30 31 32 20 33 0D		BNC
-XX11 4	7E 30 30 31 32 20 34 0D		VGA 1
-XX11 5	7E 30 30 31 32 20 35 0D		VGA 2
-XX11 6	7E 30 30 31 32 20 36 0D		VGA 1 SCART
-XX11 7	7E 30 30 31 32 20 37 0D		VGA 1 Component
-XX11 8	7E 30 30 31 32 20 38 0D		S-Video
-XX11 9	7E 30 30 31 32 20 39 0D		Video
-XX11 10	7E 30 30 31 32 20 3A 0D		Wireless
-XX11 11	7E 30 30 31 32 20 3B 0D		VGA 2 SCART
-XX11 12	7E 30 30 31 32 20 3C 0D		VGA 2 Component
-XX11 13	7E 30 30 31 32 20 3D 0D		
-XX20 1	7E 30 30 32 30 20 31 0D	Display Mode	Presentation
-XX20 2	7E 30 30 32 30 20 32 0D		Bright
-XX20 3	7E 30 30 32 30 20 33 0D		Movie
-XX20 4	7E 30 30 32 30 20 34 0D		sRGB
-XX20 5	7E 30 30 32 30 20 35 0D		User 1
-XX20 6	7E 30 30 32 30 20 36 0D		User 2
-XX21 n	7E 30 30 32 31 20 a 0D	Brightness	n=-50 (a=2D 35 30) ~ +50 (a= 35 30)
-XX22 n	7E 30 30 32 32 20 a 0D	Contrast	n=-50 (a= 2D 35 30) ~ +50 (a= 35 30)
-XX23 n	7E 30 30 32 33 20 a 0D	Sharpness	n=-16 (a= 2D 31 36) ~ +15 (a= 31 35)
-XX170 n	7E 30 30 31 37 30 20 a 0D	Color	n=-100 (a= 2D 30 30) ~ 100 (a= 31 30 30)
-XX171 n	7E 30 30 31 37 31 20 a 0D		Red Saturation n=0 (a= 30) ~ 199 (a= 31 39 39)
-XX27 n	7E 30 30 32 37 20 a 0D		Red Gain n=0 (a= 30) ~ 199 (a= 31 39 39)
-XX172 n	7E 30 30 31 37 32 20 a 0D		Green Hue n=-100 (a= 2D 30 30) ~ 100 (a= 31 30 30)
-XX173 n	7E 30 30 31 37 33 20 a 0D		Green Saturation n=0 (a= 30) ~ 199 (a= 31 39 39)
-XX28 n	7E 30 30 32 38 20 a 0D		Green Gain n=0 (a= 30) ~ 199 (a= 31 39 39)
-XX174 n	7E 30 30 31 37 34 20 a 0D		Blue Hue n=-100 (a= 2D 30 30) ~ 100 (a= 31 30 30)
-XX175 n	7E 30 30 31 37 35 20 a 0D		Blue Saturation n=0 (a= 30) ~ 199 (a= 31 39 39)
-XX29 n	7E 30 30 32 39 20 a 0D		Blue Gain n=0 (a= 30) ~ 199 (a= 31 39 39)
-XX176 n	7E 30 30 31 37 36 20 a 0D		Cyan Hue n=-100 (a= 2D 30 30) ~ 100 (a= 31 30 30)
-XX177 n	7E 30 30 31 37 37 20 a 0D		Cyan Saturation n=0 (a= 30) ~ 199 (a= 31 39 39)
-XX30 n	7E 30 30 33 30 20 a 0D		Cyan Gain n=0 (a= 30) ~ 199 (a= 31 39 39)
-XX178 n	7E 30 30 31 37 38 20 a 0D		Yellow Hue n=-100 (a= 2D 30 30) ~ 100 (a= 31 30 30)
-XX179 n	7E 30 30 31 37 39 20 a 0D		Yellow Saturation n=0 (a= 30) ~ 199 (a= 31 39 39)
-XX31 n	7E 30 30 33 31 20 a 0D		Yellow Gain n=0 (a= 30) ~ 199 (a= 31 39 39)
-XX180 n	7E 30 30 31 38 30 20 a 0D		Magenta Hue n=-100 (a= 2D 30 30) ~ 100 (a= 31 30 30)
-XX181 n	7E 30 30 31 38 31 20 a 0D		Magenta Saturation n=0 (a= 30) ~ 199 (a= 31 39 39)
-XX32 n	7E 30 30 33 32 20 a 0D		Magenta Gain n=0 (a= 30) ~ 199 (a= 31 39 39)
-XX33 1	7E 30 30 33 33 20 a 0D		Reset
-XX34 n	7E 30 30 33 34 20 a 0D	White Peaking	n=0 (a= 30) ~ 10 (a= 31 30)
-XX35 1	7E 30 30 33 35 20 31 0D	Degamma	Film
-XX35 2	7E 30 30 33 35 20 32 0D		Video
-XX35 3	7E 30 30 33 35 20 33 0D		Graphics
-XX35 4	7E 30 30 33 35 20 34 0D		PC
-XX36 1	7E 30 30 33 36 20 31 0D	Color Temp.	Warm
-XX36 2	7E 30 30 33 36 20 32 0D		Medium
-XX36 3	7E 30 30 33 36 20 33 0D		Cold
-XX37 1	7E 30 30 33 37 20 31 0D	Color Space	Auto
-XX37 2	7E 30 30 33 37 20 32 0D		RGB
-XX37 3	7E 30 30 33 37 20 33 0D		YUV
-XX39 1	7E 30 30 33 39 20 31 0D	Input Source	HDMI
-XX39 2	7E 30 30 33 39 20 32 0D		DVI-D
-XX39 3	7E 30 30 33 39 20 34 0D		BNC
-XX39 4	7E 30 30 33 39 20 35 0D		VGA 1
-XX39 6	7E 30 30 33 39 20 36 0D		VGA 2
-XX39 9	7E 30 30 33 39 20 39 0D		S-Video
-XX39 10	7E 30 30 33 39 20 31 30 0D		Video
-XX39 11	7E 30 30 33 39 20 31 31 0D		Wireless
-XX60 1	7E 30 30 36 30 20 31 0D	Format	4:3
-XX60 2	7E 30 30 36 30 20 32 0D		16:9-1
-XX60 3	7E 30 30 36 30 20 33 0D		16:9-B
-XX60 4	7E 30 30 36 30 20 34 0D		Window
-XX61 n	7E 30 30 36 31 20 a 0D	Overscan	n=0 (a= 30) ~ 10 (a= 31 30)
-XX62 n	7E 30 30 36 32 20 a 0D	Zoom	n=0 (a= 30) ~ 25 (a= 32 35)
-XX63 n	7E 30 30 36 33 20 a 0D	H Image Shift	n=-50 (a= 2D 35 30) ~ 50 (a= 35 30)
-XX64 n	7E 30 30 36 34 20 a 0D	V Image Shift	n=-50 (a= 2D 35 30) ~ 50 (a= 35 30)
-XX65 n	7E 30 30 36 35 20 a 0D	H Keystone	n=-40 (a= 2D 34 30) ~ 40 (a= 34 30)
-XX66 n	7E 30 30 36 36 20 a 0D	V Keystone	n=-40 (a= 2D 34 30) ~ 40 (a= 34 30)
-XX67 1	7E 30 30 36 37 20 31 0D	PC Mode	Normal
-XX67 2	7E 30 30 36 37 20 32 0D		Wide
-XX70 1	7E 30 30 37 30 20 31 0D	Language	English
-XX70 2	7E 30 30 37 30 20 32 0D		German
-XX70 3	7E 30 30 37 30 20 33 0D		French
-XX70 4	7E 30 30 37 30 20 34 0D		Italian
-XX70 5	7E 30 30 37 30 20 35 0D		Spanish
-XX70 6	7E 30 30 37 30 20 36 0D		Portuguese
-XX70 7	7E 30 30 37 30 20 37 0D		Polish
-XX70 8	7E 30 30 37 30 20 38 0D		Dutch
-XX70 9	7E 30 30 37 30 20 39 0D		Swedish
-XX70 10	7E 30 30 37 30 20 31 30 0D		Norwegian/Danish
-XX70 11	7E 30 30 37 30 20 31 31 0D		Finnish
-XX70 12	7E 30 30 37 30 20 31 32 0D		Greek
-XX70 13	7E 30 30 37 30 20 31 33 0D		Traditional Chinese
-XX70 14	7E 30 30 37 30 20 31 34 0D		Simplified Chinese
-XX70 15	7E 30 30 37 30 20 31 35 0D		Japanese
-XX70 16	7E 30 30 37 30 20 31 36 0D		Korean
-XX70 17	7E 30 30 37 30 20 31 37 0D		Russian
-XX70 18	7E 30 30 37 30 20 31 38 0D		Hungarian
-XX70 19	7E 30 30 37 30 20 31 39 0D		Czechoslovak
-XX70 20	7E 30 30 37 30 20 32 30 0D		Arabic

Appendices

SEND to projector

232 ASCII HEX Code	Function	Projector Return	Description
-XX71 1	7E 30 30 37 31 20 31 0D	Projection	Front-Desktop
-XX71 2	7E 30 30 37 31 20 32 0D		Rear-Desktop
-XX71 3	7E 30 30 37 31 20 33 0D		Front-Ceiling
-XX71 4	7E 30 30 37 31 20 34 0D		Rear-Ceiling
-XX72 1	7E 30 30 37 32 20 31 0D	Menu Location	Top Left
-XX72 2	7E 30 30 37 32 20 32 0D		Top Right
-XX72 3	7E 30 30 37 32 20 33 0D		Centre
-XX72 4	7E 30 30 37 32 20 34 0D		Bottom Left
-XX72 5	7E 30 30 37 32 20 35 0D		Bottom Right
-XX73 n	7E 30 30 37 33 20 a 0D	Signal	Frequency
-XX74 n	7E 30 30 37 34 20 a 0D		Phase
-XX75 n	7E 30 30 37 35 20 a 0D		H. Position
-XX76 n	7E 30 30 37 36 20 a 0D		V. Position
-XX77 n	7E 30 30 37 37 20 31 abcdef 0D	Security	Security Timer
			Month/Day/Hour n=mmddhh mm=00 (aa=30 30) - 99 (aa=39 39) dd = 00 (aa=30 30) - 29 (aa=32 39) hh = 00 (aa=30 30) - 23 (aa=32 33)
-XX78 1	7E 30 30 37 38 20 31 0D	Security Settings	On
-XX78 2	7E 30 30 37 38 20 32 0D		Off
-XX79 n	7E 30 30 37 39 20 31 a 0D	Projector ID	n= 00 (aa=30 30) - 99 (aa=39 39)
-XX80 1	7E 30 30 38 30 20 31 0D	Mute	On
-XX80 2	7E 30 30 38 30 20 32 0D		Off
-XX81 n	7E 30 30 38 31 20 31 a 0D	Volume	n=0 (a=30) - 16 (a=31 36)
-XX82 1	7E 30 30 38 32 20 31 0D	Logo	Optoma
-XX82 2	7E 30 30 38 32 20 32 0D		User
-XX83 1	7E 30 30 38 33 20 31 0D	Logo Capture	
-XX84 1	7E 30 30 38 34 20 31 0D	Lens Shift	Lock
-XX84 2	7E 30 30 38 34 20 32 0D		Unlock
-XX85 1	7E 30 30 38 35 20 31 0D	Zoom/Focus	Lock
-XX85 2	7E 30 30 38 35 20 32 0D		Unlock
-XX100 1	7E 30 30 31 30 30 20 31 0D	Source Lock	On
-XX100 2	7E 30 30 31 30 30 20 32 0D		Off
-XX101 1	7E 30 30 31 30 31 20 31 0D	High Altitude	On
-XX101 2	7E 30 30 31 30 31 20 32 0D		Off
-XX102 1	7E 30 30 31 30 32 20 31 0D	Information Hide	On
-XX102 2	7E 30 30 31 30 32 20 32 0D		Off
-XX103 1	7E 30 30 31 30 33 20 31 0D	Keypad Lock	On
-XX103 2	7E 30 30 31 30 33 20 32 0D		Off
-XX104 1	7E 30 30 31 30 34 20 31 0D	Background Color	Blue
-XX104 2	7E 30 30 31 30 34 20 32 0D		Black
-XX104 3	7E 30 30 31 30 34 20 33 0D		Red
-XX104 4	7E 30 30 31 30 34 20 34 0D		Green
-XX104 5	7E 30 30 31 30 34 20 35 0D		White
-XX105 1	7E 30 30 31 30 35 20 31 0D	Advanced	Direct Power On
-XX105 2	7E 30 30 31 30 35 20 32 0D		On
-XX113 1	7E 30 30 31 31 33 20 31 0D	Signal Power On	On
-XX113 2	7E 30 30 31 31 33 20 32 0D		Off
-XX106 n	7E 30 30 31 30 36 20 a 0D	Auto Power Off (min)	n= 0 (a= 30) - 999 (a= 39 39 39)
-XX107 n	7E 30 30 31 30 37 20 a 0D		n= 0 (a= 30) - 999 (a= 39 39 39)
-XX108 1	7E 30 30 31 30 38 20 31 0D	Lamp Setting	Lamp Hour
-XX109 1	7E 30 30 31 30 39 20 31 0D		Lamp Reminder
-XX109 2	7E 30 30 31 30 39 20 32 0D		On
-XX110 1	7E 30 30 31 30 20 31 0D	Brightness Mode	Off
-XX110 2	7E 30 30 31 30 20 32 0D		Bright
-XX111 1	7E 30 30 31 31 20 31 0D	Lamp Reset	Yes
-XX111 2	7E 30 30 31 31 20 32 0D		No
-XX112 1	7E 30 30 31 31 32 20 31 0D	Reset	Yes
-XX112 2	7E 30 30 31 31 32 20 32 0D		No

SEND to Remote

-XX140 1	7E 30 30 31 34 30 20 31 0D	Power	
-XX140 2	7E 30 30 31 34 30 20 32 0D	Re-sync	
-XX140 3	7E 30 30 31 34 30 20 33 0D	Keystone	
-XX140 4	7E 30 30 31 34 30 20 34 0D	AV Mute	
-XX140 5	7E 30 30 31 34 30 20 35 0D	Freeze	
-XX140 6	7E 30 30 31 34 30 20 36 0D	Display	
-XX140 7	7E 30 30 31 34 30 20 37 0D	Zoom in	
-XX140 8	7E 30 30 31 34 30 20 38 0D	Zoom out	
-XX140 9	7E 30 30 31 34 30 20 39 0D	Volume +	
-XX140 10	7E 30 30 31 34 30 20 31 0D	Volume -	
-XX140 11	7E 30 30 31 34 30 20 31 0D	Enter (for projection MENU)	
-XX140 12	7E 30 30 31 34 30 20 31 32 0D	Menu	
-XX140 13	7E 30 30 31 34 30 20 31 33 0D	Left	
-XX140 14	7E 30 30 31 34 30 20 31 34 0D	Up	
-XX140 15	7E 30 30 31 34 30 20 31 35 0D	Right	
-XX140 16	7E 30 30 31 34 30 20 31 36 0D	Down	
-XX140 17	7E 30 30 31 34 30 20 31 37 0D	Forms Function	
-XX140 18	7E 30 30 31 34 30 20 31 38 0D	Lens (1)	
-XX140 19	7E 30 30 31 34 30 20 31 39 0D	IDM1 (2)	
-XX140 20	7E 30 30 31 34 30 20 32 30 0D	Wireless (3)	
-XX140 21	7E 30 30 31 34 30 20 32 31 0D	Source (4)	
-XX140 22	7E 30 30 31 34 30 20 32 32 0D	DVI (5)	
-XX140 23	7E 30 30 31 34 30 20 32 33 0D	BNC (6)	
-XX140 24	7E 30 30 31 34 30 20 32 34 0D	VGA-1 (7)	
-XX140 25	7E 30 30 31 34 30 20 32 35 0D	Video (8)	
-XX140 26	7E 30 30 31 34 30 20 32 36 0D	S-Video (9)	
-XX140 27	7E 30 30 31 34 30 20 32 37 0D	VGA-2 (0)	

SEND from projector automatically

232 ASCII HEX Code	Function	Projector Return	Description
When in Standby/Warming/Cooling/Out of Range/Lamp fail		INFOn	n : 0/1/2/3/4 = Standby/Warming/Cooling/Out of Range/Lamp Fail

READ from projector

232 ASCII HEX Code	Function	Projector Return	Description
-XX121 1	7E 30 30 31 32 31 20 31 0D	Input Source Commands	OKaa aa : 00/01/02/03/04/05/06/07/08=None/DVI/VGA1/VGA2/S-Video/Video/BNC/HDMI/Wireless
-XX122 1	7E 30 30 31 32 32 20 31 0D	Software Version	OKaaaa
-XX123 1	7E 30 30 31 32 33 20 31 0D	Display Mode	OKa a : 0/1/2/3/4/5=Presentation/Bright/Movie/RGB/User1/User2
-XX124 1	7E 30 30 31 32 34 20 31 0D	Power State	OKa a : 1/0=On/Off
-XX125 1	7E 30 30 31 32 35 20 31 0D	Brightness	OKn n : -50 to 50
-XX126 1	7E 30 30 31 32 36 20 31 0D	Contrast	OKn n : -50 to 50
-XX127 1	7E 30 30 31 32 37 20 31 0D	Aspect Ratio	OKa a : 0/1/2/3/4=1/3/16:9/1/6:9/1/Window
-XX128 1	7E 30 30 31 32 38 20 31 0D	Color Temperature	OKa a : 0/1/2=Warm/Medium/Cold
-XX129 1	7E 30 30 31 32 39 20 31 0D	Projection Mode	OKa a : 0/1/2/3=Front-Desktop/Rear-Desktop/Front-Ceiling/Rear-Ceiling
-XX150 1	7E 30 30 31 35 30 20 31 0D	Information	OKbbbbbccccddd bbbbb: Lamp Hour cc: source 00/01/02/03/04/05/06/07/08=None/DVI/VGA1/VGA2/S-Video/Video/BNC/HDMI/Wireless dddd: FW version e : Display mode 0/1/2/3/4/5=Presentation/Bright/Movie/RGB/User1/User2 n : 0 EP783
-XX151 1	7E 30 30 31 35 31 20 31 0D	Model name	OKn

Ceiling Mount Installation

1. To prevent damaging your projector, please use Optoma's recommended mount package for installation.
2. If you wish to use a third party ceiling mount kit, please ensure the screws used to attached a mount to the projector met the following specifications:

- ▶ Screw type: M6
- ▶ Maximum screw length: 8.5mm
- ▶ Minimum screw length: 6.5mm

Note

- ❖ Please note that damage resulting from incorrect installation will invalidate the warranty.



Warning:

1. If you buy the ceiling mount from other company, please ensure that there is at least 10cm distance between the bottom cover of the projector and the ceiling.
2. Avoid placing the projector near sources of heat such air-conditioning units and heaters otherwise it may overheat and shut down automatically.
3. Ceiling mounting shall be mounting on metal or concrete.

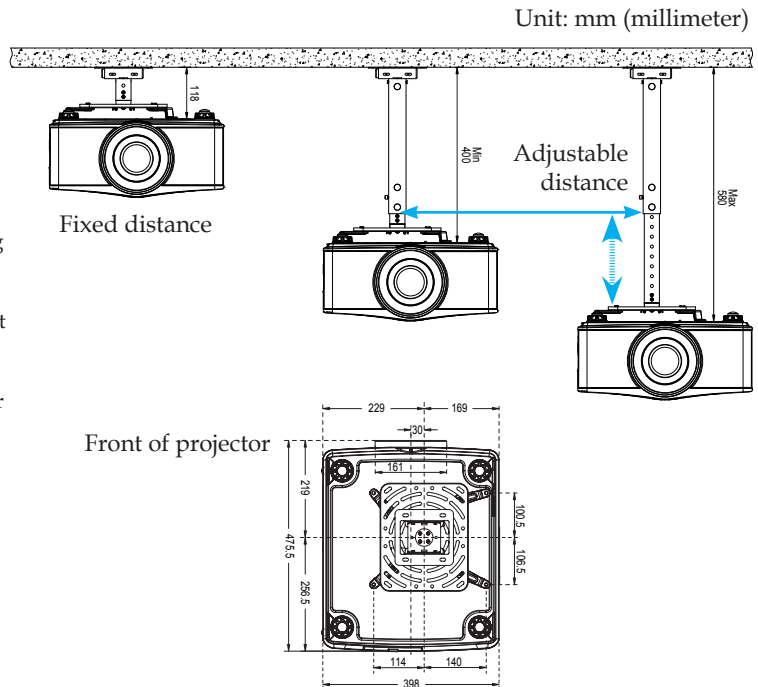

Optoma Global Offices

For service or support please contact your local office.

USA

715 Sycamore Drive
Milpitas, CA 95035, USA
www.optomausa.com

Tel : 408-383-3700
Fax : 408-383-3702
Service : services@optoma.com

Canada

5630 Kennedy Road, Mississauga,
ON, L4Z 2A9, Canada
www.optoma.ca

Tel : 905-361-2582
Fax : 905-361-2581

Europe

42 Caxton Way, The Watford Business Park
Watford, Hertfordshire,
WD18 8QZ, UK
www.optoma.eu
Service Tel : +44 (0)1923 691865

Tel : +44 (0) 1923 691 800
Fax : +44 (0) 1923 691 888
Service : service@tsc-europe.com

Optoma France

Bâtiment E
81-83 avenue Edouard Vaillant
92100 Boulogne Billancourt, France

Tel.: +33 1 41 46 12 20
Fax : +33 1 41 46 94 35
Service : savoptoma@optoma.fr

Optoma Spain

Paseo de la Castellana
135 7 Planta
Madrid, Spain

Tel.: +34 91 790 67 01
+34 91 790 67 02
Fax : + 34 91 790 68 69

Optoma Deutschland

Werttstrasse 25
D40549 Düsseldorf,
Germany

Tel : +49 (0) 211 506 6670
Fax : +49 (0) 211 506 66799
Service : info@optoma.de

Optoma Scandinavia

Grev Wedels Plass 2
3015 Drammen
Norway

Tel : +47 32 26 89 90
Fax : +47 32 83 78 98
Service : info@optoma.no

Latin America

715 Sycamore Drive
Milpitas, CA 95035, USA
www.optoma.com.br

Tel : 408-383-3700
Fax : 408-383-3702
www.optoma.com.mx

Korean

WOOMI TECH.CO.,LTD.

4F,Minu Bldg.33-14, Kangnam-Ku, Tel : +82+2+34430004

seoul,135-815, KOREA

Fax : +82+2+34430005

Japanese

東京都足立区綾瀬3-25-18

株式会社オーエスエム

サポートセンター:0120-46-5040

E-mail : info@osscreen.com

www.os-worldwide.com

Taiwan

5F., No. 108, Minchiuan Rd.

Shindian City,

Taipei Taiwan 231, R.O.C.

www.optoma.com.tw

Tel : +886-2-2218-2360

Fax : +886-2-2218-2313

Service : services@optoma.com.tw

asia.optoma.com

Hong Kong

Unit A, 27/F Dragon Centre,

79 Wing Hong Street,

Cheung Sha Wan,

Kowloon, Hong Kong

Tel : +852-2396-8968

Fax : +852-2370-1222

www.optoma.com.hk

China

5F, No. 1205, Kaixuan Rd.,

Changning District

Shanghai, 200052, China

Tel : +86-21-62947376

Fax : +86-21-62947375

www.optoma.com.cn

Regulation & Safety notices

This appendix lists the general notices of your projector.

FCC notice

This device has been tested and found to comply with the limits for a Class B digital device pursuant to Part 15 of the FCC rules. These limits are designed to provide reasonable protection against harmful interference in a residential installation. This device generates, uses, and can radiate radio frequency energy and, if not installed and used in accordance with the instructions, may cause harmful interference to radio communications.

However, there is no guarantee that interference will not occur in a particular installation. If this device does cause harmful interference to radio or television reception, which can be determined by turning the device off and on, the user is encouraged to try to correct the interference by one or more of the following measures:

- Reorient or relocate the receiving antenna.
- Increase the separation between the device and receiver.
- Connect the device into an outlet on a circuit different from that to which the receiver is connected.
- Consult the dealer or an experienced radio/television technician for help.

Notice: Shielded cables

All connections to other computing devices must be made using shielded cables to maintain compliance with FCC regulations.

Caution

Changes or modifications not expressly approved by the manufacturer could void the user's authority, which is granted by the Federal Communications Commission, to operate this device.

Operation conditions

This device complies with Part 15 of the FCC Rules. Operation is subject to the following two conditions:

1. This device may not cause harmful interference, and
2. This device must accept any interference received, including interference that may cause undesired operation.

Notice: Canadian users

This Class B digital apparatus complies with Canadian ICES-003.

Remarque à l'intention des utilisateurs canadiens

Cet appareil numérique de la classe B est conforme à la norme NMB-003 du Canada.

Declaration of Conformity for EU countries

- EMC Directive 2004/108/EC (including amendments)
- Low Voltage Directive 2006/95/EC
- R & TTE Directive 1999/5/EC (if product has RF function)

Disposal instructions



Do not throw this electronic device into the trash when discarding. To minimize pollution and ensure utmost protection of the global environment, please recycle it.

Free Manuals Download Website

<http://myh66.com>

<http://usermanuals.us>

<http://www.somanuals.com>

<http://www.4manuals.cc>

<http://www.manual-lib.com>

<http://www.404manual.com>

<http://www.luxmanual.com>

<http://aubethermostatmanual.com>

Golf course search by state

<http://golfingnear.com>

Email search by domain

<http://emailbydomain.com>

Auto manuals search

<http://auto.somanuals.com>

TV manuals search

<http://tv.somanuals.com>