

ixtreme M5850 Service Guide

PRINTED IN TAIWAN

Revision History

Please refer to the table below for the updates made on ixtrème M5850 series guide.

Date	Chapter	Updated

Copyright

Copyright © 2010 by Acer Incorporated. All rights reserved. No part of this publication may be reproduced, transmitted, transcribed, stored in a retrieval system, or translated into any language or computer language, in any form or by any means, electronic, mechanical, magnetic, optical, chemical, manual or otherwise, without the prior written permission of Acer Incorporated.

Disclaimer

The information in this guide is subject to change without notice. Acer Incorporated makes no representations or warranties, either expressed or implied, with respect to the contents hereof and specifically disclaims any warranties of merchantability or fitness for any particular purpose. Any Acer Incorporated software described in this manual is sold or licensed "as is". Should the programs prove defective following their purchase, the buyer (and not Acer Incorporated, its distributor, or its dealer) assumes the entire cost of all necessary servicing, repair, and any incidental or consequential damages resulting from any defect in the software.

Conventions

The following conventions are used in this manual:

SCREEN MESSAGES	Denotes actual messages that appear on screen.
NOTE	Gives bits and pieces of additional information related to the current topic.
WARNING	Alerts your to any damage that might result from doing or not doing specific actions.
CAUTION	Gives precautionary measures to avoid possible hardware or software problem.
IMPORTANT	Reminds you to do specific actions relevant to the accomplishment of procedures.

Preface

Before using this information and the product it supports, please read the following general information.

1. This Service Guide provides you with all technical information relating to the BASIC CONFIGURATION decided for Acer's "global" product offering. To better fit local market requirements and enhance product competitiveness, your regional office MAY have decided to extend the functionality of a machine (e.g. add-on card, modem, or extra memory capability). These LOCALIZED FEATURES will NOT be covered in this generic service guide. In such cases, please contact your regional offices or the responsible personnel/channel to provide you with further technical details.
2. Please note WHEN ORDERING FRU PARTS, that you should check the most up-to-date information available on your regional web or channel. If, for whatever reason, a part number change is made, it will not be noted in the printed Service Guide. For ACER-AUTHORIZED SERVICE PROVIDERS, your Acer office may have a DIFFERENT part number code to those given in the FRU list of this printed Service Guide. You MUST use the list provided by your regional Acer office to order FRU parts for repair and service of customer machines.

Introducing the Motherboard	錯誤! 尙未定義書籤。
Features.....	2
Mainboard Components	4
Block Diagram.....	錯誤! 尙未定義書籤。
ixtreme M5850	5
I/O Port Introduction	9
Hardware Specifications and Configurations.....	錯誤! 尙未定義書籤。
Using BIOS.....	16
Setup Utility Menus	錯誤! 尙未定義書籤。
Product Information.....	錯誤! 尙未定義書籤。
Standard CMOS Features.....	錯誤! 尙未定義書籤。
Advanced BIOS Features.....	錯誤! 尙未定義書籤。
Advanced Chipset Features.....	錯誤! 尙未定義書籤。
Integrated Peripherals.....	錯誤! 尙未定義書籤。
Power Management Setup	錯誤! 尙未定義書籤。
PC Health Status.....	錯誤! 尙未定義書籤。
Frequency/Voltage Control	錯誤! 尙未定義書籤。
BIOS Security Features.....	錯誤! 尙未定義書籤。
Load Default Settings.....	錯誤! 尙未定義書籤。
Machine Disassembly and Replacement.....	30
General Information.....	31
Standard Assembly Process	32
Standard Disassembly Process	錯誤! 尙未定義書籤。
Troubleshooting	66
Power-On Self-Test (POST)	67
POST Error Messages List.....	71
Error Symptoms List	73
Undetermined Problems	77
Jumper and Connector Information.....	78
FRU (Field Replaceable Unit) List	92
Exploded Diagram	92
FRU List.....	98

Introducing the Motherboard

Introduction

Thank you for choosing the H67 motherboard. This motherboard is a high performance, enhanced function motherboard designed to support the LGA1155 socket for 2nd Generation Intel® Core™ Family/Pentium®/Celeron® processors for high-end business or personal desktop markets.

This motherboard is based on Intel® H67 Chipset for best desktop platform solution. H67 is a single-chip, highly integrated, high performance Hyper-Threading peripheral controller, unmatched by any other single chip-device controller. This motherboard supports up to 16 GB of system memory with dual channel DDR3 1333/ 1066 SDRAM. Two PCI are supported, fully compliant with PCI rev 2.2 specification at 33MHz. High resolution graphics via PCI Express x16 slot, intended for Graphics Interface, is fully compliant to the PCI Express Base Specification revision 2.0. In addition, one PCI Express slot is supported. It implements an EHCI (Enhanced Host Controller Interface) compliant interface that provides fourteen USB 2.0 ports (six USB 2.0 ports at the back panel and four USB 2.0 headers support additional eight USB 2.0 ports).

The motherboard is equipped with advanced full set of I/O ports in the rear panel, including PS/2 mouse and PS/2 keyboard connectors, one DVI(co-lay HDMI) port, one D_sub (VGA) port, one Lan port, six USB 2.0/3.0 ports, and audio jacks for microphone, line-in and line-out. In addition, this motherboard supports two SATA 6Gb/s connectors and four SATA 3Gb/s connectors.

Features

Operating system

Windows®7 Home Premium x86/x64, Windows® 7 Home Basic x86, Windows®7 Starter x86

Processor

The motherboard uses an LGA1155 type of socket that carries the following

Features:

- | Accommodates 2nd Generation Intel® Core™ Family / Pentium® / Celeron® processors
- | Supports “Hyper-Threading” technology CPU
- | One PCI Express x16 Gen2 port supporting up to 5 GB/s direction peak bandwidth

“Hyper-Threading” technology enables the operating system into thinking it’s hooked up to two processors, allowing two threads to be run in parallel, both on separate “logical” processors within the same physical processor.

Chipset

The Intel H67 Express Chipset is a single-chip with proven reliability and performance.

- | Support one PCI Express slot
- | Integrated two SATA 6.0 Gb/s Host Controller
- | Integrated two SATA 3.0 Gb/s Host Controller
- | Fourteen USB 2.0 ports supported
- | Serial Peripheral Interface (SPI) support
- | Integrated Graphics Support with PAVP 1.5
- | • Intel® High Definition Audio Controller

Memory

- | Supports DDR3 1333/1066 DDR3 SDRAM with Dual-channel architecture
- | Accommodates four unbuffered DIMMs
- | Up to 4 GB per DIMM with maximum memory size up to 16 GB

Onboard LAN

The onboard LAN provides the following features:

- | Supports PCI Express™ 1.1
- | Integrated 10/100 /1000 transceiver
- | Wake-on-LAN and remote wake-up support

Audio

- | 5.1 Channel High Definition Audio Codec
- | ADCs support 44.1k/48k/96kHz sample rate
- | Meets Microsoft WLP 3.10 Vista premium and mobile PCs audio requirements
- | Direct Sound 3D™ compatible

Expansion Options

The motherboard comes with the following expansion options:

- | One PCI Express x16 slot for Graphics Interface
- | Three PCI Express x1 slot
- | Six SATA connectors

Integrated I/O

The motherboard comes with the following expansion options:

- I Two PS/2 ports for mouse and keyboard
- I One VGA port
- I One HDMI port
- I Six USB ports
- I One LAN port
- I Audio jacks for microphone, line-in and line-out

BIOS Firmware

The motherboard uses AMI BIOS that enables users to configure many system features including the following:

- I Power management
- I Wake-up alarms
- I CPU parameters
- I CPU and memory timing
- I Graphic parameters

The firmware can also be used to set parameters for different processor clock speeds.



1. *Some hardware specifications and software items are subject to change without prior notice.*
2. *Due to chipset limitation, we recommend that motherboard be operated in the ambience between 0 and 50 ° C.*

Dimensions and weight

- I 355 (H) x 382.5(D) x 180(W) mm (without bezel)
- I 11.4Kg

Mainboard Components

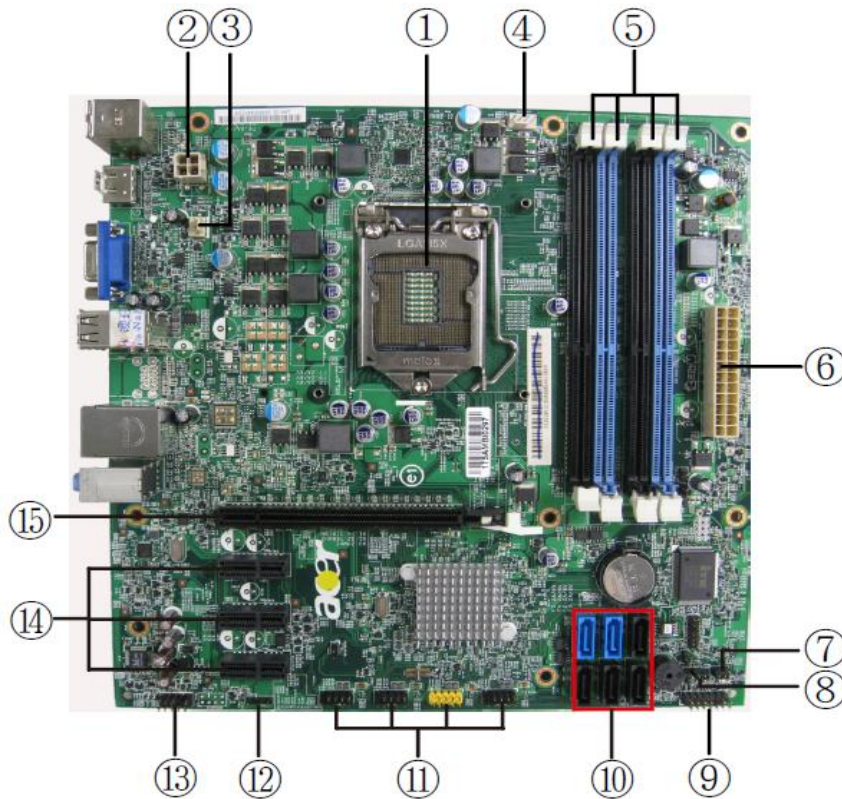

No	Label	Component
1	CPU Socket	AMD socket
2	ATX_12V	Auxiliary 4-pin power connector
3	SYS_FAN	System cooling fan connector
4	CPU_FAN	CPU cooling fan connector
5	DIMM1~4	240-pin DDR3 SDRAM slots
6	ATX1	Standard 24-pin ATX power connector
7	CLR_CMOS	Clear CMOS jumper
8	ME_DISABLE	ME disable header
9	LEDH1	Front panel switch/LED header
10	SATA1~6	Serial ATA connectors
11	F_USB1~4	Front panel USB headers
12	SPDIF_OUT	SPDIF out header
13	F_AUDIO1	Front panel audio header
14	PCIEX1-1~3	PCI Express x1 slot
15	PCIEX16X	PCI Express x16 slot

This concludes Chapter 1. The next chapter explains how to install the motherboard.

Block Diagram

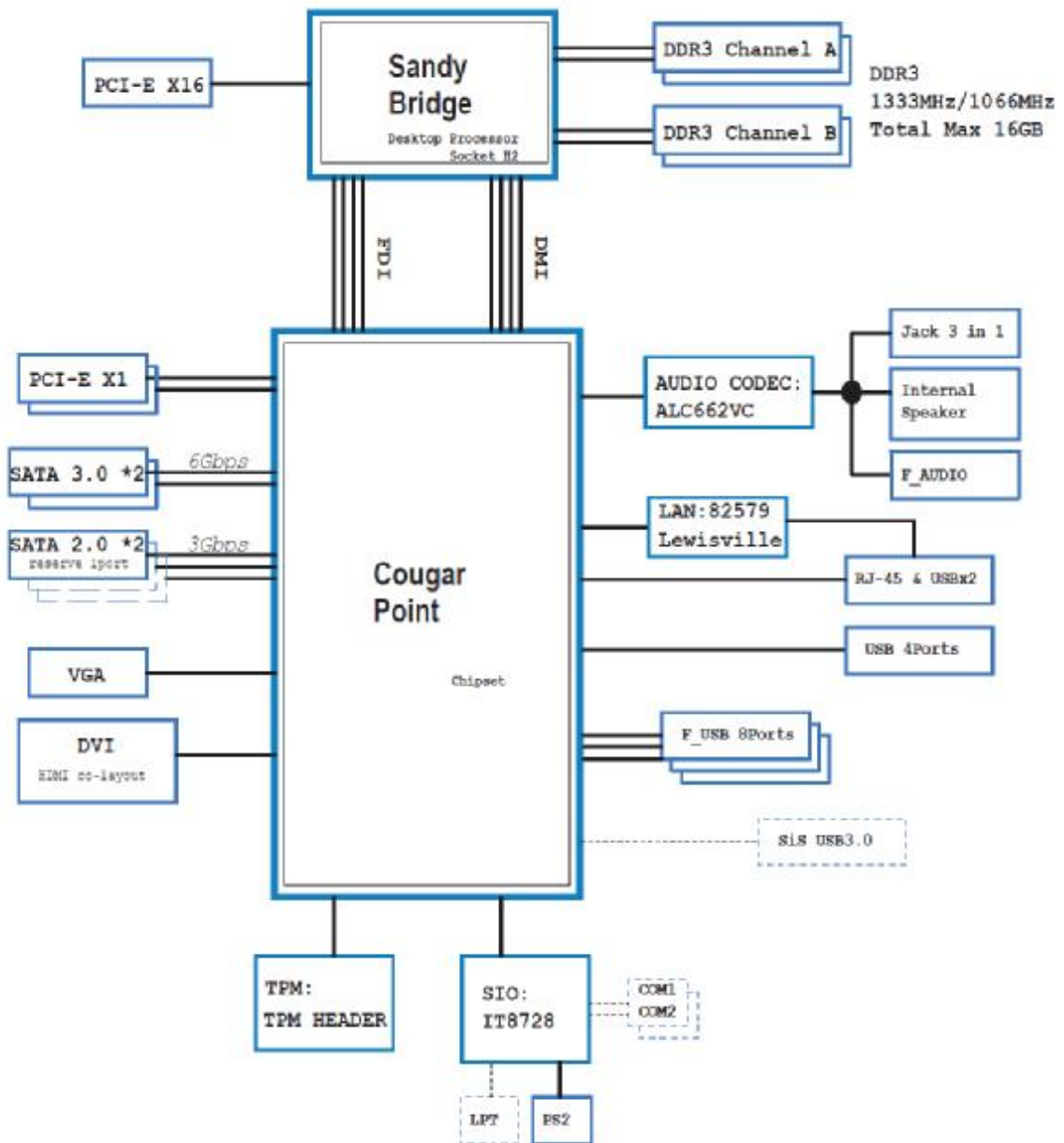





ixtreme M5850

The computer's front panel consists of the following :







Front view

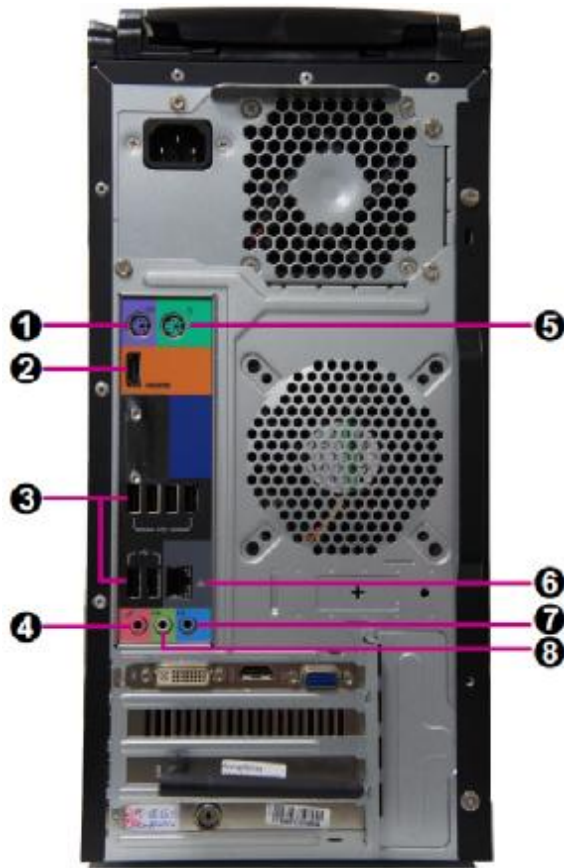

No	Icon	Component	Description
1		USB ports.	Connects to USB 2.0 devices (e.g., USB mouse, USB camera).
2	xD		
3	CF	Compact flash.	
4	MS/MS Pro	MS: Memory Stick MS Pro: Memory Stick PRO	
5	Micro SD	Micro Secure Digital.	
6	SD/MMC	SD Plus: Ultra II SD PLUS Memory Card MMC Plus: MultiMediaCard PLUS	
7		Headphone/Speaker-out/line-out port.	Connects to audio line-in devices (e.g., speakers, headphones).
8		Microphone-in jack.	Accepts input from external microphones.
9		USB ports.	Connects to USB 2.0 devices (e.g., USB mouse, USB camera).

Rear view



No	Icon	Component	Description
1		PS/2 keyboard connector	
2	HDMI	HDMI Port	High Definition Multimedia Interface
3		USB 2.0 ports	Connects to USB 2.0 devices (e.g., USB mouse, USB camera).
4		Microphone jack	Accepts input from external microphones.
5		PS/2 mouse connector	
6		Network port	Lights to indicate the status of wireless LAN communications.
7		Line-in jack	Accepts audio line-out devices (e.g., audio CD player.)
8		Line-out jack	Accepts audio line-in devices (e.g., audio CD player.)

Audio Jack Function Table

Color/Use	Headphone	2CH	4CH	5.1CH
Blue	Line-in	Line-in	Rear Speaker	Rear Speaker
Green	Headphone	Front speaker	Front speaker	Front speaker
Pink	Mic-in	Mic-in	Mic-in	Center & bass

I/O Port Introduction

The backplane of the motherboard has the following I/O ports:

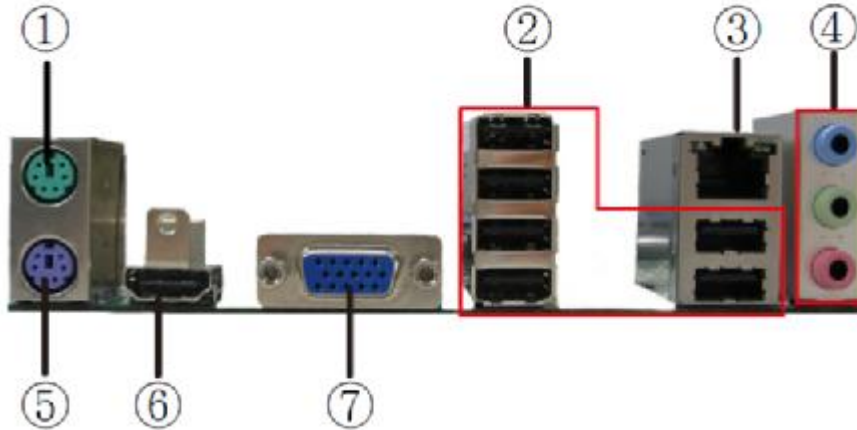

No	Component	Description
1	PS2 Mouse	Use the upper PS/2 port to connect a PS/2 pointing device.
2	USB Ports	Use the USB ports to connect USB devices.
3	LAN Port	Connect an RJ-45 jack to the LAN port to connect your computer to the Network.
4	Line-in / Line-out / Microphone	Use the three audio ports to connect audio devices. The first jack is for stereo line-in signal. The second jack is for stereo line-out signal. The third jack is for microphone.
5	PS2Keyboard	Use the lower PS/2 port to connect a PS/2 keyboard.
6	HDMI Port	Connect the HDMI port to the HDMI devices.
7	VGA Port	Connect your monitor to the VGA port.

System Peripherals

The IXTRME M5850 series computer consist of the system itself, and system peripherals, like a mouse, keyboard, card reader and a set of speakers (optional). This section provides a brief description of the basic system peripherals.

Mouse (PS/2 or USB, manufacturing option)

The included mouse is a standard two-button wheel mouse. Connect the mouse to the PS/2 mouse port or USB port on the back panel of the system.



Keyboard (PS/2 or USB, manufacturing option)

Connect the keyboard to the PS/2 keyboard port or USB port on the back panel of the system.



Speakers

For systems bundled with speakers, before powering on the system, connect the speaker cable to the audio out (external speaker) port on the back panel of the system.

For more detailed information about the speakers, please refer to the included operating instructions.

NOTE: speakers are optional and the appearance might be different depending on the actual product.



Card Reader (Option)

Memory cards are used in a wide selection of digital cameras, PDAs, MP3 players and mobile phones. Selected computers include an "all-in-one" memory card reader that allows you read and write the most common types, such as SD (Secure Digital)[™]/ MMC (Multi Media Card[™]), CF (Compact Flash[®]), xD (XD-PICTURE CARD), Micro SD and MS/MS Pro (Memory Stick[®]).

NOTE: Card reader are optional and the appearance might be different depending on the actual product.

Hardware Specifications and Configurations

Processor

Item	Specification
Type	LGA1155 socket for 2nd Generation Intel® Core™ Family/ Pentium®/Celeron® processors
Socket	socket LGA1155
Speed	Depends on CPU which is configured
FSB	Depends on CPU which is configured

BIOS

Item	Specification
BIOS code programmer	Afudos
BIOS version	P01-A0 (or newer version)
BIOS ROM type	Flash ROM
BIOS ROM size	32MB
BIOS ROM package	32-pin DIP package(SST)
Support protocol	ACPI 2.0, APM 1.2, SMBIOS 2.3, WFM support, ASD
Boot from CD-ROM feature	Yes
Support to LS-120 FDD drive	Yes

NOTE: The BIOS can be overwritten/upgraded by using the flash utility.

BIOS Hotkey List

Item	Specification	Specification
DEL	Enter BIOS Setup Utility	Press while the system is booting to enter BIOS setup Utility.
F12	Enter Boot Menu	Press while the system is booting to enter Boot Menu.

Main Board Major Chips

Item	Specification
Chipset	Intel H67
AGP controller	Intel H67
Super I/O controller	ITE 8728F
Audio controller	Realtek ALC662
LAN controller	Intel 82579V
HDD controller	Intel H67
Keyboard controller	ITE 8728F

System Memory

Item	Specification
Memory slot number	4 slots
Support memory size per socket	1GB to 4GB
Support maximum memory size	16 GB
Support memory type	DDR3 DRAM
Support memory interface	DDR3 1066/1333
Support memory module package	240-pin DIMM
Support parity check feature	Yes
Support to Error Correction Code (ECC) feature	ECC checking with double-bit detect and single-bit correct
Memory module combinations	You can install memory modules in any combination as long as they match the specifications.

NOTE: Dual channel should be enabled always when plug-in 2 same memory size DDRII memory module.

Cache Memory

Item	Specification
First-Level Cache Configurations	
Cache function control	Always enabled
Second-Level Cache Configurations	
L2 Cache RAM size	Up to 2MB per core (exclusive)
L2 Cache RAM speed	One-half the processor core clock frequency
L2 Cache function control	Enable/Disable by BIOS Setup

Video Interface

Item	Specification
Video controller	Intel H67
Video controller resident bus	PCIe
Video Interface	X16

Audio Interface

Item	Specification
Audio controller	Realtek
Audio controller Type	ALC662
Audio Channel	5.1ch
Audio function control	Enable/disable by BIOS Setup
Mono or stereo	5.1 channel
Sampling rate	DACs: 44.1k/48k/96k/192k Hz
MPU-401 UART support	Yes
Microphone jack	Supported
Headphone jack	Supported

IDE Interface

Item	Specification
IDE controller	Intel H67
Number of SATA connector	4
Support bootable CD-ROM	Yes

USB Port

Item	Specification
Universal HCI	USB 2.0/3.0
USB Class	Support legacy keyboard for legacy mode
USB Number	support up to 12 ports

Power Management

Devices	S1 (Idle)	S3 (Suspend to RAM)	S4 (Suspend to Disk)	S5 (Shut Down)
Power Button	Enabled	Enabled	Enabled	Disabled
USB Keyboard	Enabled	Enabled	Enabled	N/A
LAN	Disabled	Disabled	Disabled	Disabled
RTC	Disabled	Enabled	Disabled	Disabled
Modem (Ring)	Disabled	Disabled	Disabled	N/A

Power Management Function (ACPI support function)

Device Standby Mode

- | Independent power management timer for hard disk drive devices (0-15 minutes, time step=1 minute).
- | Hard disk drive goes into Standby mode (for ATA standard interface).
- | Disable V-sync to control the VESA DPMS monitor.
- | Resume method: device activated (Keyboard for DOS, keyboard & mouse for Windows).
- | Resume recovery time: 3-5 sec.

Global Standby Mode

- | Global power management timer (2-120 minutes, time step=10 minute).
- | Hard disk drive goes into Standby mode (for ATA standard interface).
- | Disable H-sync and V-sync signals to control the VESA DPMS monitor.
- | Resume method: Return to original state by pushing external switch button, modem ring in, keyboard and mouse for APM mode.
- | Resume recovery time: 7-10 sec.

Suspend Mode

- | Independent power management timer (2-120 minutes, time step=10 minutes) or pushing external
- | switch button.
- | CPU goes into SMM.
- | CPU asserts STPCLK# and goes into the Stop Grant State.
- | LED on the panel turns amber colour.
- | Hard disk drive goes into SLEEP mode (for ATA standard interface).
- | Disable H-sync and V-sync signals to control the VESA DPMS monitor.
- | Ultra I/O and VGA chip go into power saving mode.
- | Resume method: Return to original state by pushing external switch button, modem ring in, keyboard and mouse for APM mode.
- | Return to original state by pushing external switch button, modem ring in and USB keyboard for ACPI mode.

ACPI

- | ACPI specification 1.0b.
- | S0, S1, S3 and S5 sleep state support.
- | On board device power management support.
- | On board device configuration support.

Using BIOS

About the Setup Utility

The computer uses the latest "American Megatrends Inc." BIOS will support for Windows Plug and Play. The CMOS chip on the motherboard contains the ROM setup instructions for configuring the motherboard BIOS.

The BIOS (Basic Input and Output System) Setup Utility displays the system's configuration status and provides you with options to set system parameters. The parameters are stored in battery-backed-up CMOS RAM that saves this information when the power is turned off. When the system is turned back on, the system is configured with the values you stored in CMOS.

The BIOS Setup Utility enables you to configure:

- | Hard drives, diskette drives and peripherals
- | Video display type and display options
- | Password protection from unauthorized use
- | Power Management features

The settings made in the Setup Utility affect how the computer performs. Before using the Setup Utility, ensure that you understand the Setup Utility options.

This chapter provides explanations for Setup Utility options.

The Standard Configuration

A standard configuration has already been set in the Setup Utility. However, we recommend that you read this chapter in case you need to make any changes in the future.

This Setup Utility should be used:

- | when changing the system configuration
- | when a configuration error is detected and you are prompted to make changes to the Setup Utility
- | when trying to resolve IRQ conflicts
- | When making changes to the Power Management configuration
- | when changing the password or making other changes to the Security Setup

Entering the Setup Utility

When you power on the system, BIOS enters the Power-On Self Test (POST) routines. POST is a series of built-in diagnostics performed by the BIOS. After the POST routines are completed, the following message appears:

Press DEL to enter SETUP

BIOS Setup Utility(Main)

Pressing the **DEL** key accesses the BIOS Setup Utility:

BIOS Setup Utility		
Main	Advanced	Power Security Boot Options Exit
System BIOS Version Build Date	D03 10/28/2010	Set the Date. Use Tab to switch between Date elements.
Processor Genuine Intel(R) CPU 0 @3.10 Core Frequency Count	3.10 GHz 4	[] ← → : Move Enter : Select +/- : Change Opt. F7: Load User default Settings F8: Save as User Default Settings F9: Load Default Settings (When Access Level is Supervisor) F10: Save & Exit Setup
Memory Size	5120MB	
Product Name System Serial Number Asset Tag Number	SX2860	
System Date System Time	[Fri 01 /01/2010] [17:12:01]	
Version 2.02.1205. Copyright (C) 2010, American Megatrends, Inc.		



The default BIOS setting for this motherboard applies for most conditions with optimum performance. It is not suggested to change the default values in the BIOS setup and the manufacture takes no responsibility to any damage caused by changing the BIOS settings.

Date and Time

The Date and Time items show the current date and time on the computer. If you are running a Windows OS, these items are automatically updated whenever you make changes to the Windows Date and Time Properties utility.

BIOS Navigation Keys

The BIOS navigation keys are listed below:

Key	Function
← →	Move
Enter	Select
+/-	Change Opt
F7	Load User default Settings
F8	Save as User Default Settings
F9	Load Default Settings
F10	Save & Exit Setup

Updating the BIOS

You can download and install updated BIOS for this motherboard from the manufacturer's Web site. New BIOS provides support for new peripherals, improvements in performance, or fixes for known bugs. Install new BIOS as follows:

- 1 If your motherboard has a BIOS protection jumper, change the setting to allow BIOS flashing.
- 2 If your motherboard has an item called Firmware Write Protect in Advanced BIOS features, disable it. (Firmware Write Protect prevents BIOS from being overwritten.)
- 3 Create a bootable system disk. (Refer to Windows online help for information on creating a bootable system disk.)
- 4 Download the Flash Utility and new BIOS file from the manufacturer's Website. Copy these files to the system diskette you created in Step 3.
- 5 Turn off your computer and insert the system diskette in your computer's diskette drive. (You might need to run the Setup Utility and change the boot priority items on the Advanced BIOS Features Setup page, to force your computer to boot from the floppy diskette drive first.)
- 6 At the A:\ prompt, type the Flash Utility program name and press <Enter>.
- 7 Type the filename of the new BIOS in the "File Name to Program" text box. Follow the onscreen directions to update the motherboard BIOS.
- 8 When the installation is complete, remove the floppy diskette from the diskette drive and restart your computer. If your motherboard has a Flash BIOS jumper, reset the jumper to protect the newly installed BIOS from being overwritten.

Using BIOS

When you start the Setup Utility, the main menu appears. The main menu of the Setup Utility displays a list of the options that are available. A highlight indicates which option is currently selected. Use the cursor arrow keys to move the highlight to other options. When an option is highlighted, execute the option by pressing <Enter>.

Some options lead to pop-up dialog boxes that prompt you to verify that you wish to execute that option. Other options lead to dialog boxes that prompt you for information.

Some options (marked with a triangle \triangle) lead to submenus that enable you to change the values for the option. Use the cursor arrow keys to scroll through the items in the submenu.

In this manual, default values are enclosed in parenthesis. Submenu items are denoted by a triangle \triangle

BIOS Setup Utility(Advanced)

This option displays basic information about your system.

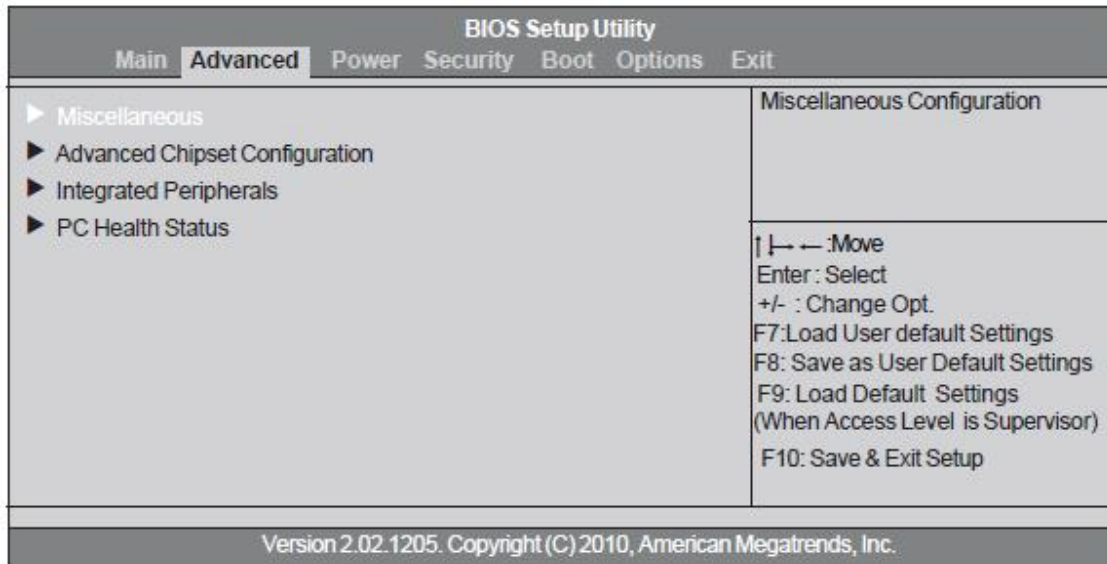

Miscellaneous

Scroll to this item and press <Enter> to view the following screen:

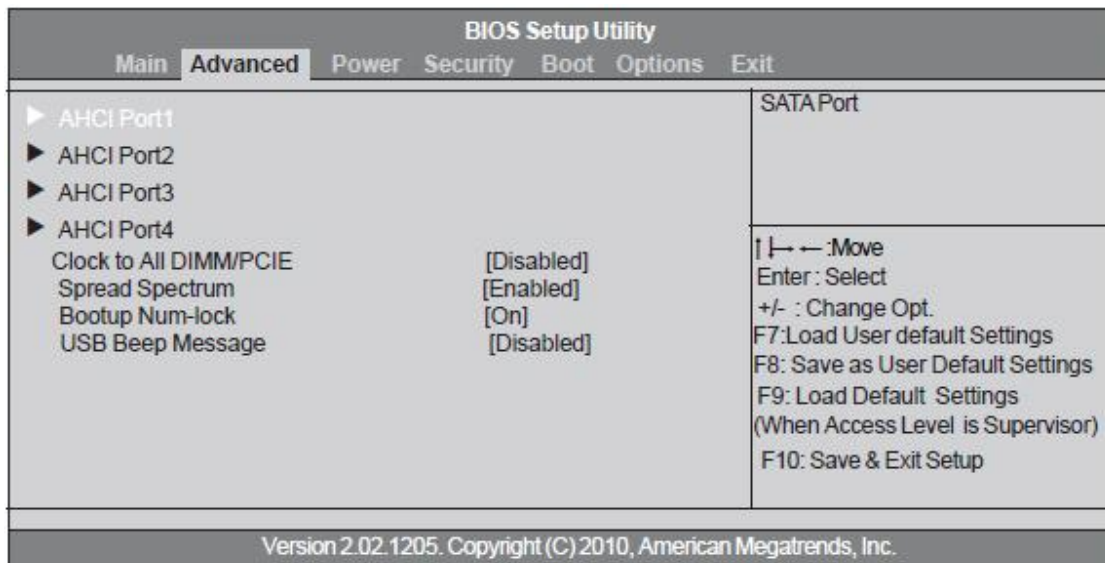

AHCI PORT1~4

This motherboard supports four SATA channels and each channel allows one SATA device to be installed.

Use these items to configure each device on the IDE channel.

Clock to All DIMM/PCIE (Disabled)

This item allows you to enable or disable the Clock to all DIMM/PCIE

Spread Spectrum (Enabled)

If you enable spread spectrum, it can significantly reduce the EMI (Electro-Magnetic interference) generated by the system and voltage according to its temperature.

Bootup Num-lock (On)

This item determines if the Num Lock key is active or inactive at system start-up time.

USB Beep Message (Disabled)

This item disables/enables the beep during USB device enumeration.

Press <Esc> to return to the Advanced BIOS Features page.

Advanced Chipset Configuration

This page sets up more advanced information about your system. Handle this page with caution. Any changes can affect the operation of your computer.

BIOS Setup Utility		
Main	Advanced	Power Security Boot Options Exit
Intel EIST	[Enabled]	Enable or Disable Onboard LAN
Intel Turbo Boost	[Enabled]	
Intel AES-NT	[Disabled]	
Intel XD Bit	[Enabled]	
Intel VT	[Enabled]	
Video Memory Size	[32KB]	[← → : Move
DVMT Mode	[DVMT]	Enter : Select
DVMT/Fixed Memory Size	[256MB]	+/- : Change Opt.
		F7: Load User default Settings
		F8: Save as User Default Settings
		F9: Load Default Settings
		(When Access Level is Supervisor)
		F10: Save & Exit Setup

Version 2.02.1205. Copyright (C) 2010, American Megatrends, Inc.

Intel EIST(Enabled)

This item allows users to enable or disable the EIST(Enhanced Intel SpeedStep technology).

Intel Turbo Boost(Enabled)

This item enables or disables Intel Turbo Boost.

Intel AES-NT(Disabled)

This item allows users to enable or disable the Intel AES-NT.

Intel XD Bit

This item allows users to enable or disable the Intel XD Bit. *Intel VT(Enabled)*

Intel VT

This item allows you to enable or disable the Intel Virtualizationa Technology(Intel VT) function.

Video Memory Size(32KB)

This item applies to chipset/motherboards capable of the HyperMemory Support.

DVMT Mode(DVMT)

DVMT is Dynamic Video Memory Technology. This item helps you select video mode.

DVMT/Fixed Memory Size(256MB)

When set to Fixed Mode, the graphics driver will reserve a fixed portion of the system memory as graphics memory. When set to DVMT Mode, the graphics chip will dynamically allocate system memory as graphics memory, according to system and graphics requirements.

Press <Esc> to return to the Advanced BIOS Features page.

Integrated Peripherals

This page sets up some parameters for peripheral devices connected to the system.

BIOS Setup Utility		
Main	Advanced	Power Security Boot Options Exit
Onboard SATA Controller	[Enabled]	Onboard SATA Controller
Onboard SATA Mode	[AHCI]	
Onboard USB Controller	[Enabled]	
Legacy USB Support	[Enabled]	
USB Storage Emulation	[Auto]	
Onboard Graphics Controller	[Enabled]	↑ ← → : Move
Onboard Audio Controller	[Enabled]	Enter : Select
Onboard LAN Controller	[Enabled]	+/- : Change Opt.
Onboard LAN Option ROM	[Disabled]	F7: Load User default Settings
		F8: Save as User Default Settings
		F9: Load Default Settings
		(When Access Level is Supervisor)
		F10: Save & Exit Setup

Version 2.02.1205. Copyright (C) 2010, American Megatrends, Inc.

Onboard SATA Controller (Enabled)

This item allows you to enable or disable the onboard SATA controller.

Onboard SATA Mode (AHCI)

Use this item to select the mode of the Serial ATA.

Onboard USB Controller (Enabled)

Use this item to enable or disable the onboard USB controller. We recommend users keep the default value.

Legacy USB Support (Enabled)

Use this item to enable or disable support for legacy USB devices. Disabling it might cause the USB devices not to work properly.

USB Storage Emulation (Auto)

If Auto, USB device equal or less than 2GB will be emulated as Floppy and remaining as hard drive.

Forced FDD option can be used to force a HDD formatted drive to boot as FDD(Ex. ZIP drive).

Onboard Graphics Controller (Enabled)

This item allows you to enable or disable the onboard controller.

Onboard Audio Controller (Enabled)

This item enables or disables the onboard audio controller.

Onboard LAN Controller (Enabled)

This option allows you to control the onboard LAN device.

Onboard LAN Option ROM (Disabled)

This item enables or disables the onboard LAN option ROM function

Press <Esc> to return to the Advanecd BIOS Features page.

PC Health Status

On motherboards support hardware monitoring, this item lets you monitor the parameters for critical voltages, temperatures and fan speeds.

BIOS Setup Utility		
Main	Advanced	Power Security Boot Options Exit
CPU Temperature (PECI Mode)	:59	Enable or Disable Onboard LAN
System Temperature	:34°C	
PCH Temperature	:128	
CPU Fan Speed	:1130 RPM	
System Fan Speed	:N/A	
CPU Core	:1.260V	↑ ↓ ← → : Move
+1.05V	:1.068V	Enter : Select
+3.30V	:3.346V	+/- : Change Opt.
+5.00V	:5.027V	F7: Load User default Settings
+12.0V	:12.030V	F8: Save as User Default Settings
5VSB	:5.040V	F9: Load Default Settings
VBAT	:3.192V	(When Access Level is Supervisor)
Smart Fan	[Enabled]	F10: Save & Exit Setup

Version 2.02.1205. Copyright (C) 2010, American Megatrends, Inc.

CPU Temperature (PECI Mode)

This item shows the CPU temperature.

System Temperature

This item shows the system temperature.

PCH Temperature

This item shows PCH temperature.

System Component Characteristics

These items display the monitoring of the overall inboard hardware health events, such as System & CPU temperature, CPU voltage, CPU & system fan speed,...etc.

- CPU Fan Speed
- System Fan Speed
- CPU Core
- + 1.05V
- + 3.30V
- + 5.00 V
- + 12.0V
- 5VSB
- VBAT

Smart Fan (Enabled)

This item enables or disables the smart fan function.

Press <Esc> to return to the Advanced BIOS Features page.

BIOS Setup Utility(Power)

This page sets up some parameters for system power management operation.

BIOS Setup Utility						
Main	Advanced	Power	Security	Boot	Options	Exit
ACPI Suspend Mode		[S3(STR)]				
Deep Power off Mode		[Enabled]				
Power on by RTC Alarm		[Disabled]				
Power on by PCIE Devices		[Disabled]				
Wake up by PS/2 KB/Mouse		[Enabled]				
Wake up by USB KB/Mouse		[Enabled]				
Restore On AC Power Loss		[Last State]				
						↑ ← → : Move Enter : Select +/- : Change Opt. F7: Load User default Settings F8: Save as User Default Settings F9: Load Default Settings (When Access Level is Supervisor) F10: Save & Exit Setup
Version 2.02.1205. Copyright (C) 2010, American Megatrends, Inc.						

APCI Suspend Mode(S3(STR))

Use this item to define how your system suspends. In the default, S3(STR), the suspend mode is suspend to RAM, i.e., the system shuts down with the exception of a refresh current to the system memory.

Deep Power off Mode (Enabled)

This item allows users to enable or disable the Deep Power off Mode.

Power on by RTC Alarm (Disabled)

This system can be turned off with a software command. If you enable this item, the system can automatically resume at a fixed time based on the system RTC (realtime clock). Use the items below this one to set the date and time of the wake-up alarm. You must use an ATX power supply in order to use this feature.

Power on by PCIE Devices (Disabled)

This system can be turned off with a software command. If you enable this item, the system can automatically resume if there is an incoming call on the PCIE LAN card. You must use an ATX power supply in order to use this feature. Use this item to do wake-up action if inserting the PCIE card.

Wake up by PS/2 KB/Mouse(Enabled)

This item enables or disables you to allow keyboard or mouse activity to awaken the system from power saving mode.

Wake up by USB KB/Mouse(Enabled)

This item enables or disables you to allow keyboard or mouse activity to awaken the system from power saving mode.

Restore On AC Power Loss (Last State)

This item defines how the system will act after AC power loss during system operation. When you set Off, it will keep the system in Off state until the power button is pressed.

BIOS Setup Utility(Security)

This page enables you to set setup administrator and password.

BIOS Setup Utility						
Main	Advanced	Power	Security	Boot	Options	Exit
Supervisor Password:			Not Installed			
User Password :			Not Installed			
Change Supervisor Password			[Press Enter]			
				↑ ← → : Move Enter : Select +/- : Change Opt. F7: Load User default Settings F8: Save as User Default Settings F9: Load Default Settings (When Access Level is Supervisor) F10: Save & Exit Setup		
Version 2.02.1205. Copyright (C) 2010, American Megatrends, Inc.						

Supervisor Password (Not Installed)

This item indicates whether a supervisor password has been set. If the password has been installed, *Installed* displays. If not, *Not Installed* displays.

User Password

This item allows you to change user password.

Change Supervisor Password (Press Enter)

You can select this option and press <Enter> to access the sub menu. You can use the sub menu to change the supervisor password.

BIOS Setup Utility(Boot options)

This page enables you to set the keyboard NumLock state.

BIOS Setup Utility		
Main	Advanced	Power Security Boot Options Exit
Set Boot Priority		
1st Boot Device	[UEFI: VTEC USB FLAS...]	
2nd Boot Device	[Hard Disk]	
3rd Boot Device	[CD&DVD]	
4th Boot Device	[Removable Device: Ge...]	
5th Boot Device	[LAN]	
▶ EFI Device Priority	[Press Enter]	↑ ↓ ← → : Move
▶ Hard Disk Priority	[Press Enter]	Enter : Select
▶ Optional Disk Drive priority	[Press Enter]	+/- : Change Opt.
▶ Removable Device Priority	[Press Enter]	F7: Load User default Settings
▶ Network Device Priority	[Press Enter]	F8: Save as User Default Settings
		F9: Load Default Settings (When Access Level is Supervisor)
		F10: Save & Exit Setup
Fast Boot	[Disabled]	
Quiet Boot	[Enabled]	
Halt On	[All, but keyboard]	
Version 2.02.1205. Copyright (C) 2010, American Megatrends, Inc.		

Set Priority Order

This item enables you to set boot priority order.

1st Boot Device/2nd Boot Device/3rd Boot Device

Use these items to determine the device order the computer uses to look for an operating system to load at start-up time.

EFI Device Priority (Press Enter)

Scroll to this item and press <Enter> to view the following screen:

BIOS Setup Utility		
Main	Advanced	Power Security Boot Options Exit
EFI Device Priority		
		↑ ↓ ← → : Move
		Enter : Select
		+/- : Change Opt.
		F7: Load User default Settings
		F8: Save as User Default Settings
		F9: Load Default Settings (When Access Level is Supervisor)
		F10: Save & Exit Setup
Version 2.02.1205. Copyright (C) 2010, American Megatrends, Inc.		

Press <Esc> to return to the Boot Options menu page.

Hard Disk Drive Priority (Press Enter)

Scroll to this item and press <Enter> to view the following screen:

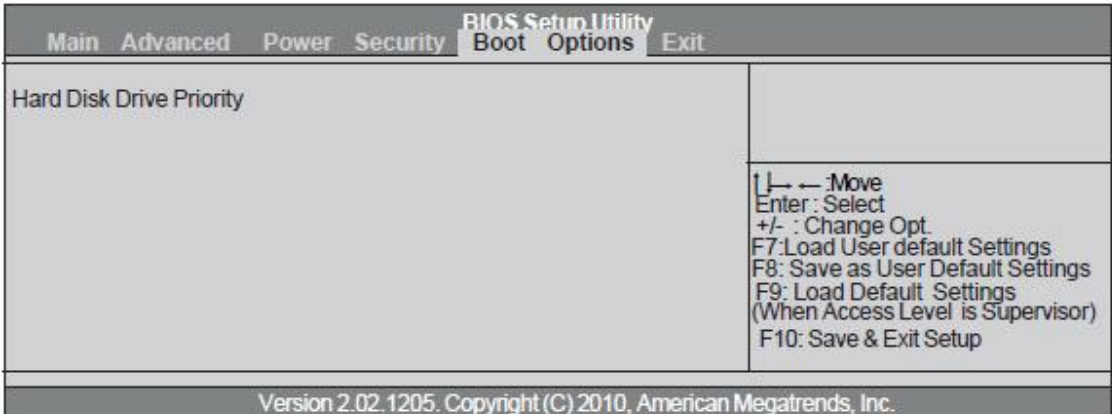

Press <Esc> to return to the Boot Options menu page.

Optical Disk Drive Priority (Press Enter)

Scroll to this item and press <Enter> to view the following screen:

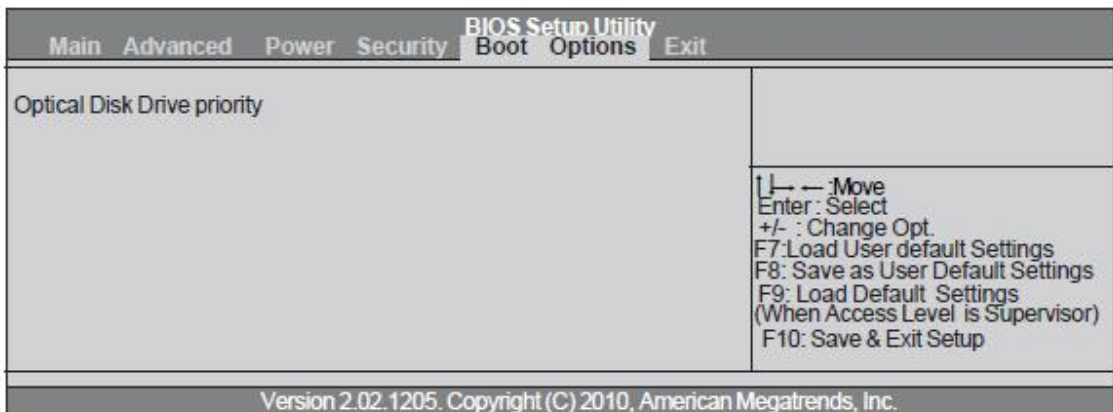

Press <Esc> to return to the Boot Options menu page.

Removable Device Priority (Press Enter)

Scroll to this item and press <Enter> to view the following screen:

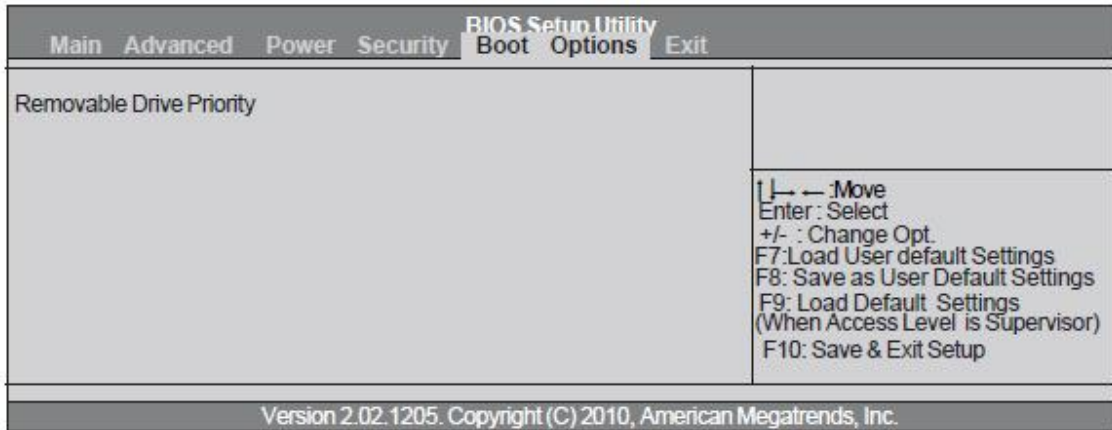

Press <Esc> to return to the Boot Options menu page.

Network Device Priority (Press Enter)

Scroll to this item and press <Enter> to view the following screen:

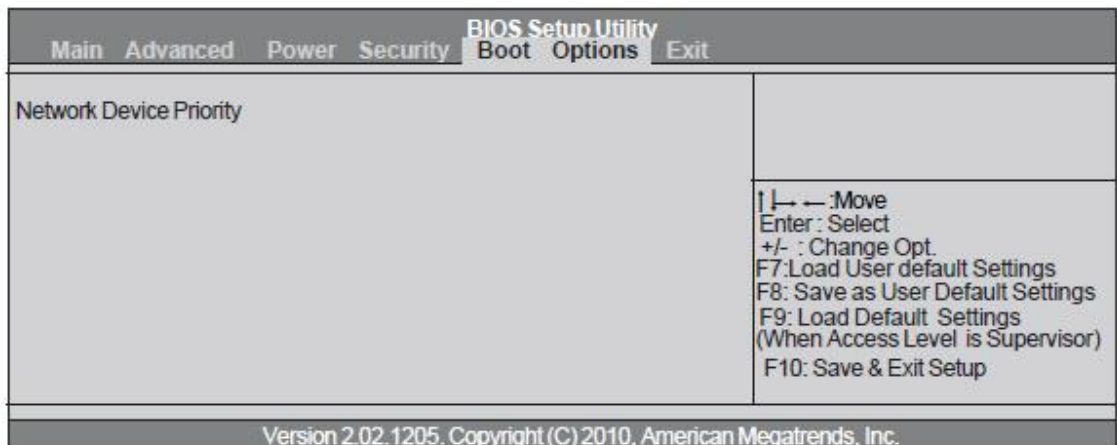

Press <Esc> to return to the Boot Options menu page.

Fast Boot (Disabled)

If you enable this item, the system starts up more quickly by elimination of some of the power on test routines.

Quiet Boot (Enabled)

This item enables or disables quiet boot.

Halt On (All, But Keyboard)

This item defines the operation of the system POST (Power On Self Test) routine. You can use this item to select which types of errors in the POST are sufficient to halt the system.

BIOS Setup Utility(Exit)

This page enables you to exit system setup after saving or without saving the changes.

BIOS Setup Utility						
Main	Advanced	Power	Security	Boot	Options	Exit
Save & Exit Setup Discard Changes and Exit Setup Save Changes Discard Change Load Default Settings Save as User Default Settings Load User Default Settings						Exit system setup after save the changes
						↑ ↓ ← → : Move Enter : Select +/- : Change Opt. F7: Load User default Settings F8: Save as User Default Settings F9: Load Default Settings (When Access Level is Supervisor) F10: Save & Exit Setup
Version 2.02.1205. Copyright (C) 2010, American Megatrends, Inc.						

Save & Exit Setup

Use this item enables you to save the changes that you have made and exit.

Discard Changes and Exit

Use this item enables you to discard any changes that you have made and exit.

Save Changes

Use this item enables you to save the changes that you have made.

Discard Changes

Use this item enables you to discard any changes that you have made.

Load Default Settings

Use this item enables you to restore the system defaults.

Save as User Default Settings

Use this item enables you to save the changes that you have made as user defaults.

Load User Default Settings

Use this item enables you to restore user defaults.



If you have made settings that you do not want to save, use the "Discard Changes and Exit" item and select [OK] to discard any changes you have made.

Machine Disassembly and Replacement

To disassemble the computer, you need the following tools:

- I Wrist grounding strap and conductive mat for preventing electrostatic discharge.
- I Wire cutter.
- I Phillips screwdriver (may require different size).

NOTE: The screws for the different components vary in size. During the disassembly process, group the screws with the corresponding components to avoid mismatches when putting back the components.

General Information

Before You Begin

Before proceeding with the disassembly procedure, make sure that you do the following:

1. Turn off the power to the system and all peripherals.
2. Unplug the AC adapter and all power and signal cables from the system.

Standard Assembly Process

1. Opening the chassis

1.1 Remove the two screws



1.2 Remove side cover



2. Removing front bezel and HDD Cage

2.1 Pushing three hooks

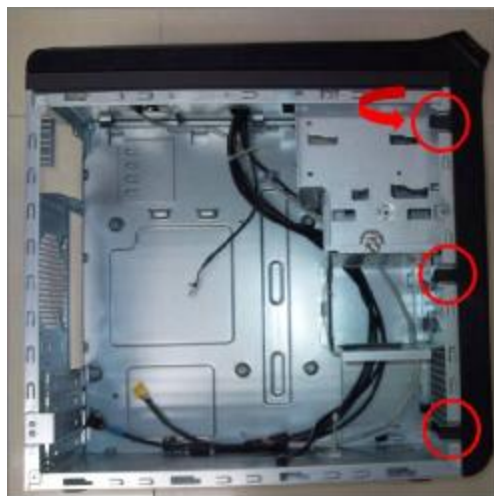

2.2 Disconnect the cable housing then you can remove front bezel.



2.3 Remove the screw

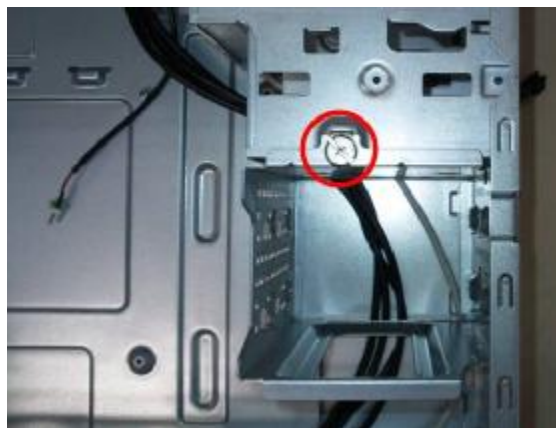

2.4 Pulling out the HDD cage



3. Install the PSU

3.1 Pushing PSU into chassis



3.2 Fix four screws

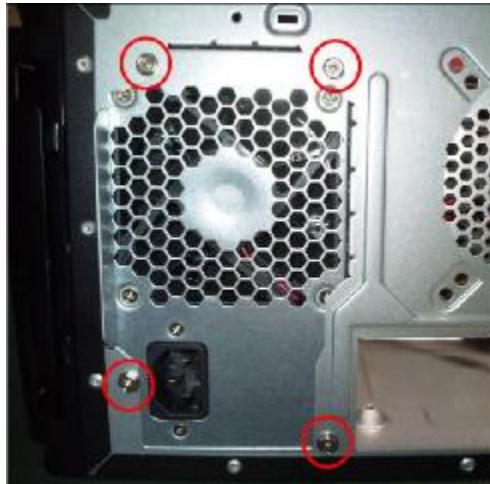

3.3 Connect U's light power cable

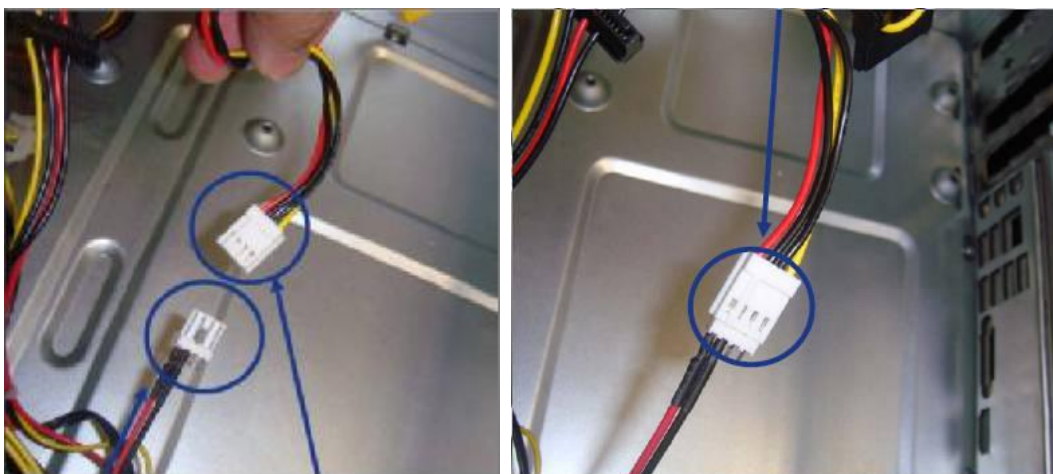

4. Setting the Motherboard

4.1 Motherboard view



4.2 Open the CPU cover and remove the plastic cover



4.3 Put the CPU in the seat and close the cover



4.4 Tie CPU fan cable



4.5 Pulling in CPU fan power cable to MB



4.6 Fix four screws of CPU Cooler connect to MB.



4.7 Open the Memory latch



4.8 Press down the memory



4.9 Memory install rule

	DIMM4	DIMM2	DIMM3	DIMM1
1x1G		1GB		
2x1G		1GB		1GB
3x1G	1GB	1GB		1GB
4x1G	1GB	1GB	1GB	1GB
1x2G		2GB		
2x2G		2GB		2GB
1x1G +1x2G		2GB		1GB



5. Assembly motherboard

5.1 Pushing rear I/O Shield in chassis



5.2 Insert the motherboard and fix eight screws

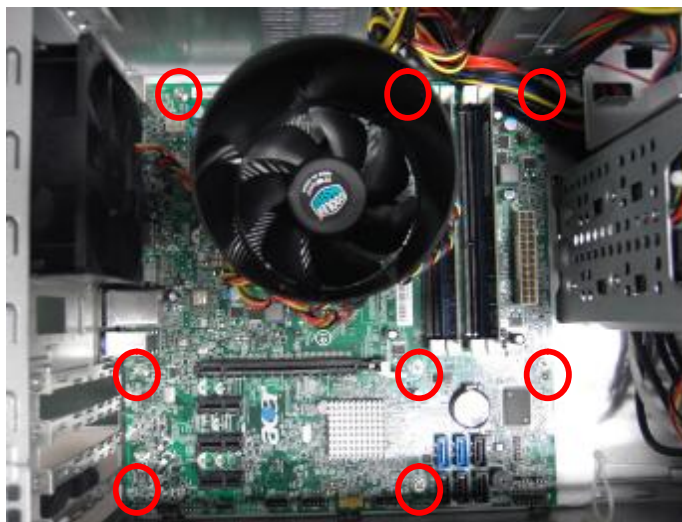

5.3 ATV 12V power cable insert



5.4 ATX power cable insert and the cable need to rotate 3 times.



5.5 Pulling in Audio/Front USB/Top USB/ Card Reader /Front cable to MB and put in cable clip

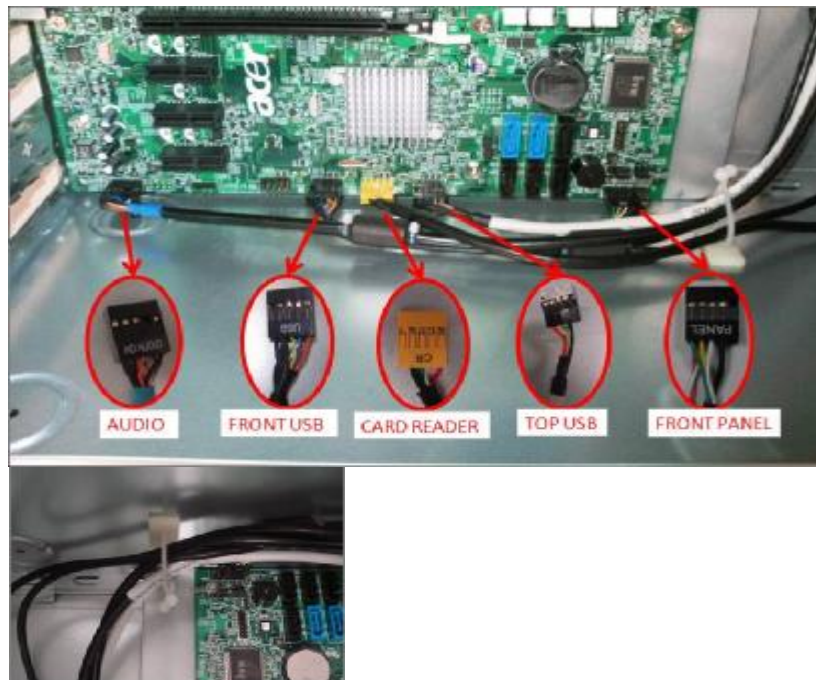

6. Insert the ODD/HDD

6.1 Remove the ODD EMI bracket when SKU need



6.2 Insert the ODD devices

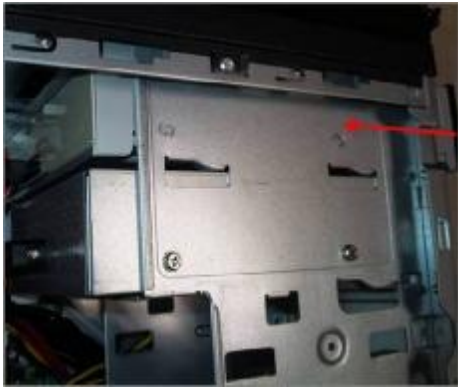

SKU with HDD Carrier



SKU without HDD Carrier

6.3 Fix two screws for each ODD and pulling in ODD SATA cable on Motherboard

ODD Installed on SATA4 when SKU have HDD Carrier

Master ODD Installed on SATA2/ Slave ODD Installed on SATA4 when SKU have no HDD Carrier



SKU with HDD Carrier



SKU without HDD Carrier



6.4 Remove the HDD Carrier



6.5 Install the HDD devices



6.6 Insert the HDD Carrier to Chassis



6.7 Pulling in HDD Carrier SATA cable on Motherboard

HDD Carrier Installed on SATA3



6.8 Fix the four screws for each HDD of HDD cage

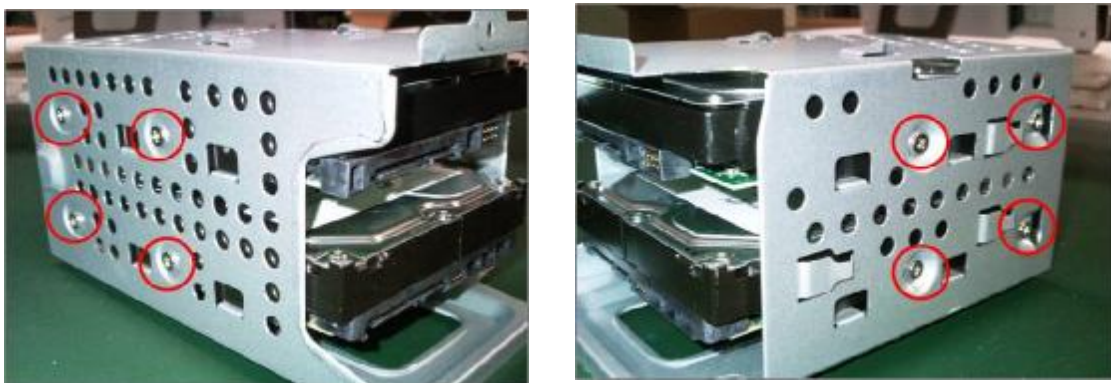

6.9 Put five hooks to Chassis and push HDD Cage down

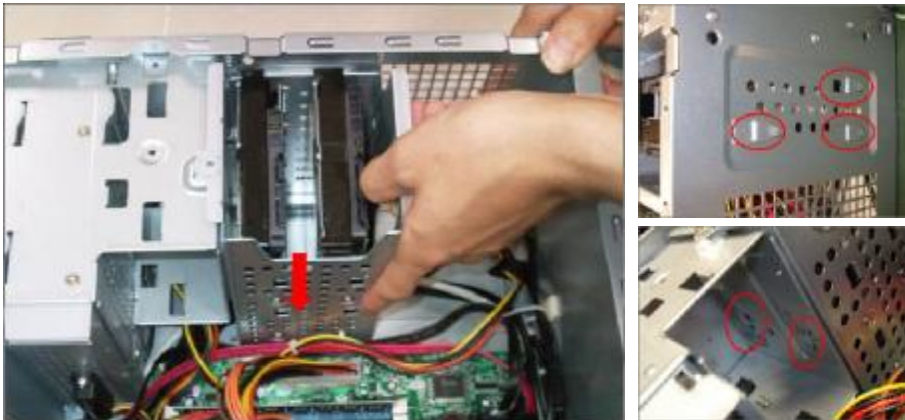

6.10 Fix the screw of HDD cage and Pulling in HDD SATA cable on Motherboard

Master HDD Installed on SATA0

Slave HDD Installed on SATA1 when SKU have HDD Carrier

Slave HDD Installed on SATA2 when SKU have no HDD Carrier

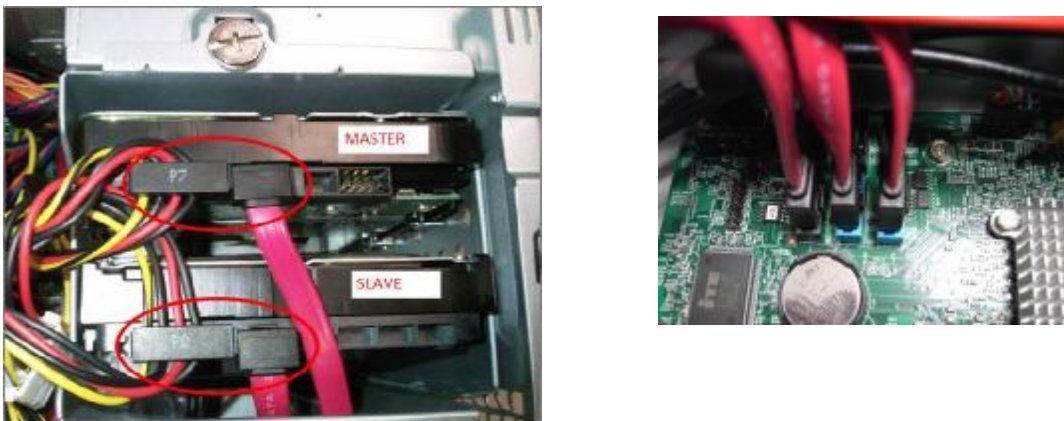

6.11 HDD/ODD install rule

SKU without HDD Carrier

	SATA1	SATA2	SATA3	SATA4
HDD+ ODD	HDD	ODD		
HDD+ ODD*2	HDD	ODD	ODD	
HDD*2+ ODD*2	HDD	ODD	HDD	ODD
HDD+ HDD Carrier+ ODD	HDD	HDD Carrier	ODD	
HDD*2+ HDD Carrier+ ODD	HDD	HDD	HDD Carrier	ODD



7. Close the Front Bezel

7.1 Connect light cable and Insert the cable in chassis



7.2 Insert three hooks to chassis in right side and Clasp three hooks in left side



8. Insert Add-on card

8.1 Remove the bracket



8.2 Rotate the bracket

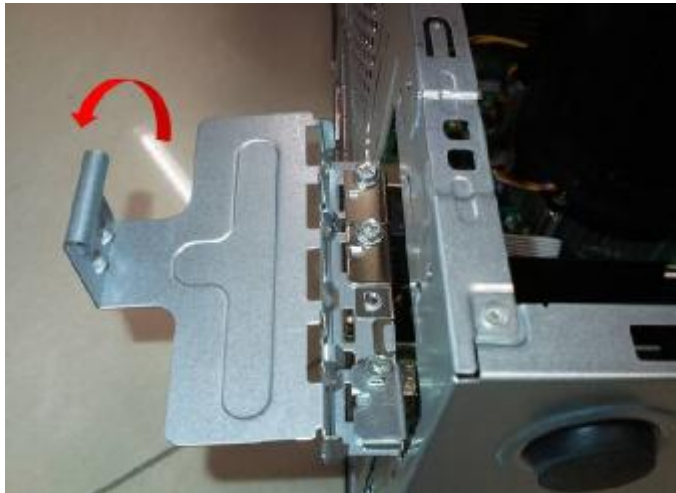

8.3 Install VGA card on motherboard

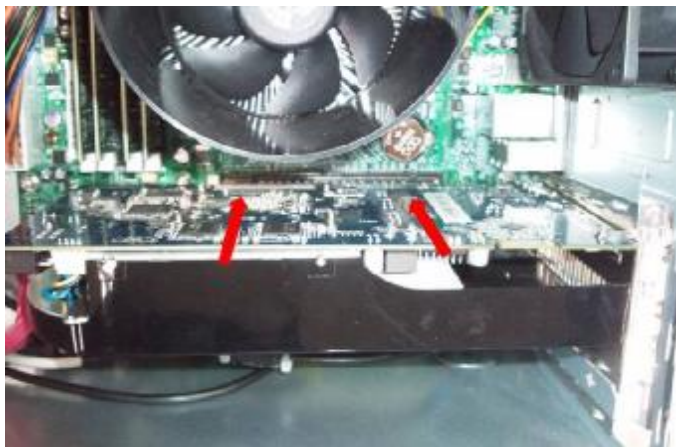

8.4 Connect 6 PIN power cable

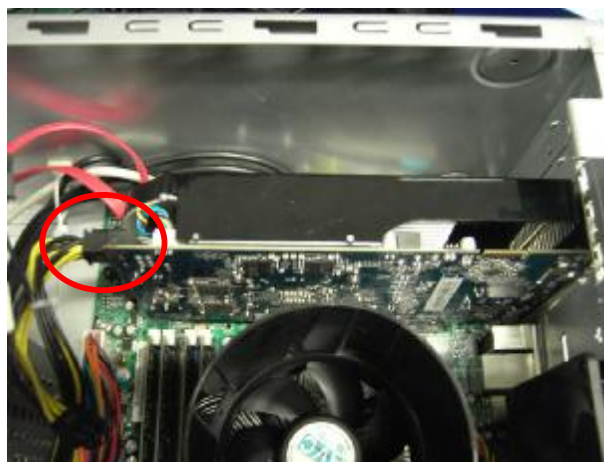

8.5 Install TV / Modem card on motherboard

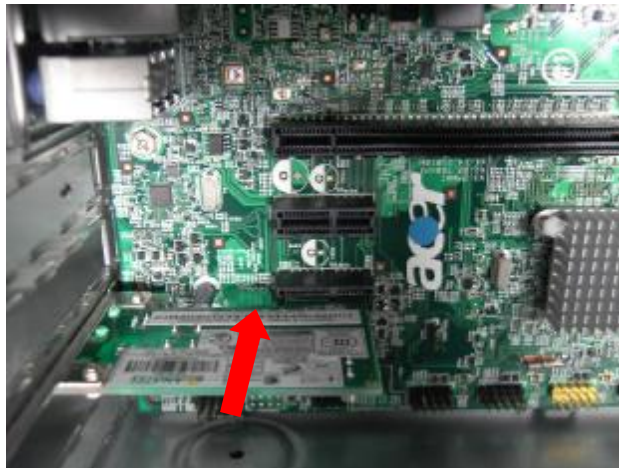

8.6 Install USB 3.0 card on motherboard (option)



8.7 Combination the 15 PIN POWER cable with SATA Connect



8.8 Connect PATA power cable



8.9 Fix the screw



8.10 Close the bracket

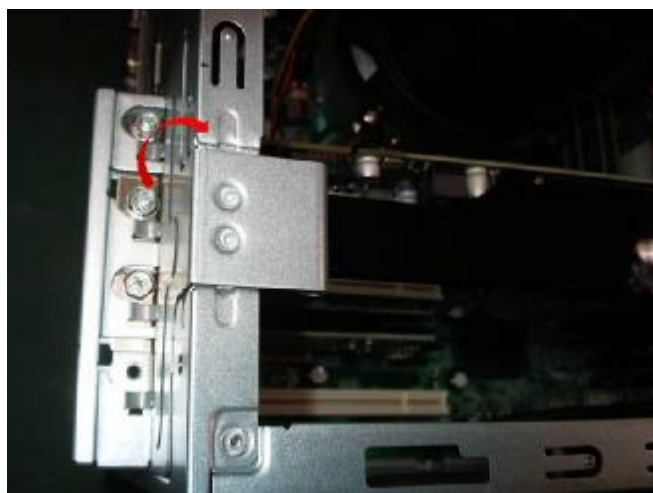

9. Install system fan

9.1 Twist the fan cable



9.2 Insert cable housing to 3 pin in MB and Tie the fan cable with 12V cable



9.3 Fix the four screws



10. Overview



Standard Disassembly Process

1. Opening the computer

- 1.1 Disconnect the three screws fixed in the side-panel.



- 1.2 Remove the side panel

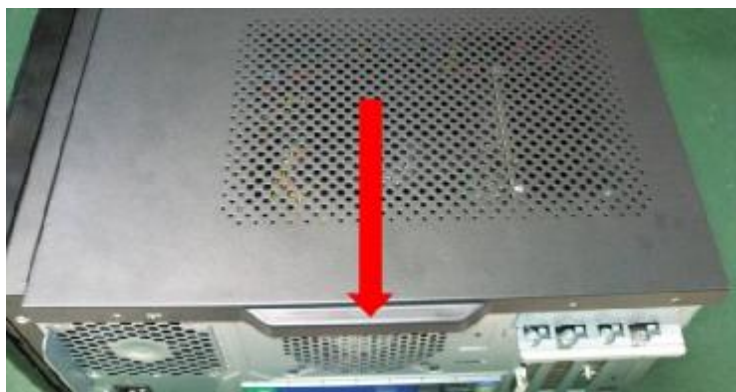

2. Removing the Front Bezel

- 2.1 Remove the three hooks



2.2 Disconnect the cable housing then you can remove front bezel.



3. Removing the Add-on Card

3.1 Rotate the PCI lock.



3.2 Disconnect the screw fixed in the bracket



3.3 Disconnect 6 PIN power cable in VGA Card



3.4 Press the PCI ear lever (highlighted in red) and pull the lever outwards a little to release the PCI latch then remove it.

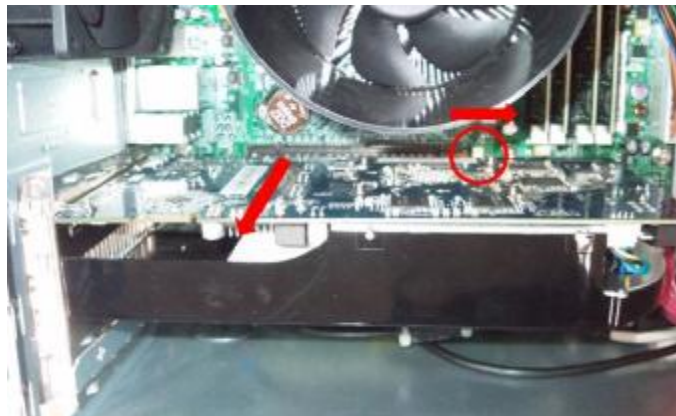

3.5 Disconnect 6 PIN power cable in USB 3.0 Card(option)



-
- 3.6** Pull the lever outwards a little to release the PCI latch then remove the card.



- 3.7** Pull the lever outwards a little to release the PCI latch then remove other add-on card.



4. Removing the HDD

- 4.1** Disconnect the screw fixed in the HDD cage.



4.2 Disconnect the SATA HDD cable and HDD power-cable from the rear of HDD and MB



4.3 Remove the HDD cage



4.4 Disconnect the eight screws fixed in HDD cage side.



5. Removing the ODD

5.1 Disconnect the screw fixed in ODD cage

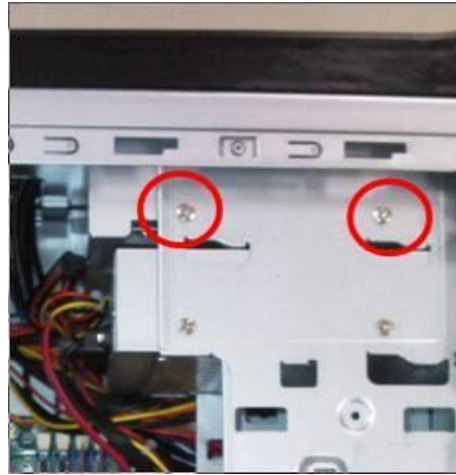

5.2 Disconnect the SATA ODD cable and ODD power-cable from the rear of ODD and MB



5.3 Remove the ODD



6. Removing the System Fan

6.1 Disconnect cable housing and loosen the cable



6.2 Disconnect the four screws fastening fan to the case



7. Removing the Main Board

7.1 Disconnect the 24pin power connector and 4 pin power connector.



7.2 Disconnect the Audio/FRONT USB/TOP USB/ CARD READER /FRONT cable from the main board

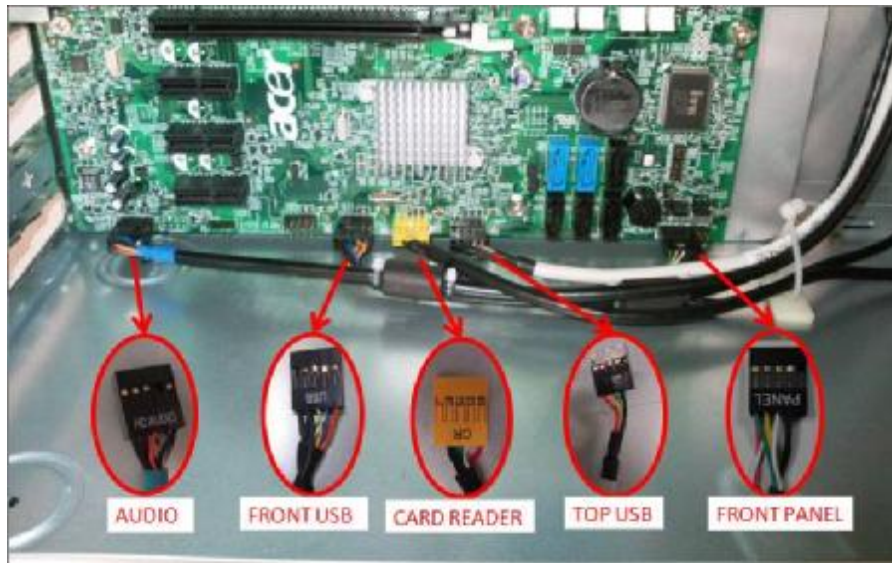

7.3 Disconnect the eight screws fastening the main board to the case and Remove the Main Board

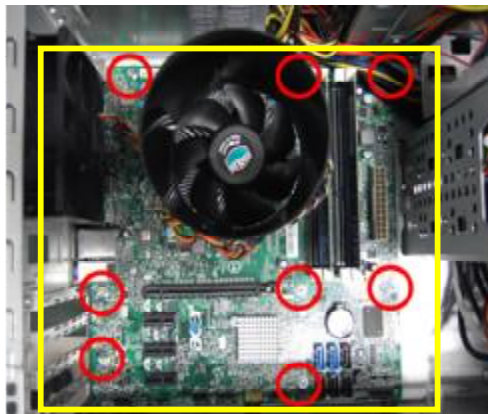

NOTE: Circuit boards >10 cm² has been highlighted with the yellow rectangle as above image shows. Please detach the Circuit boards and follow local regulations for disposal.

7.4 Remove the Rear IO Shield.



7.5 Remove the RTC battery



NOTE: RTC battery has been highlighted with the yellow circle as above image shows. Please detach the RTC battery and follow local regulations for disposal.

7.6 Release the four latch show below then remove the Memory



7.7 Disconnect the CPU cooler power-cable from the main board



7.8 Release the CPU Cooler screw x4 then remove it

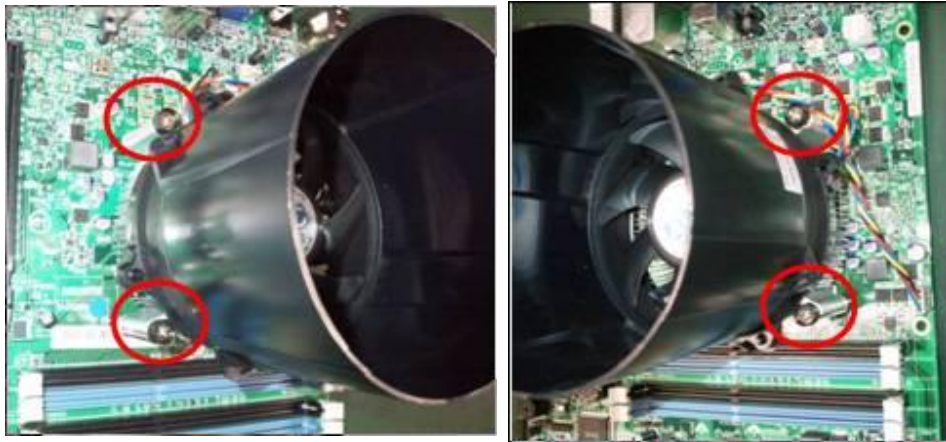

7.9 Remove the CPU



8. Removing the power-supply

8.1 Disconnect the three screws fixed in the rear chassis

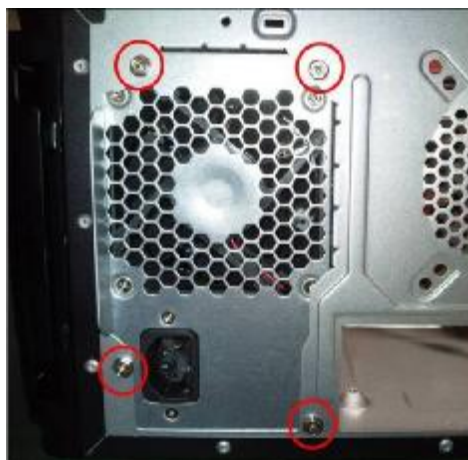

9. Removing the HDD in HDD Carrier

9.1 Push HDD carrier button and cover down slowly



9.2 Press orange latch towards the right, open the handle and pull out HDD Carrier



9.3 Rotate rubber pin in Carrier and removing HDD



9.4 Insert HDD Carrier to case and close the cover



10. Removing FRONT IO/POWER SWITCH PCB/TOP USB/CARD READER

10.1 Cut cable tie

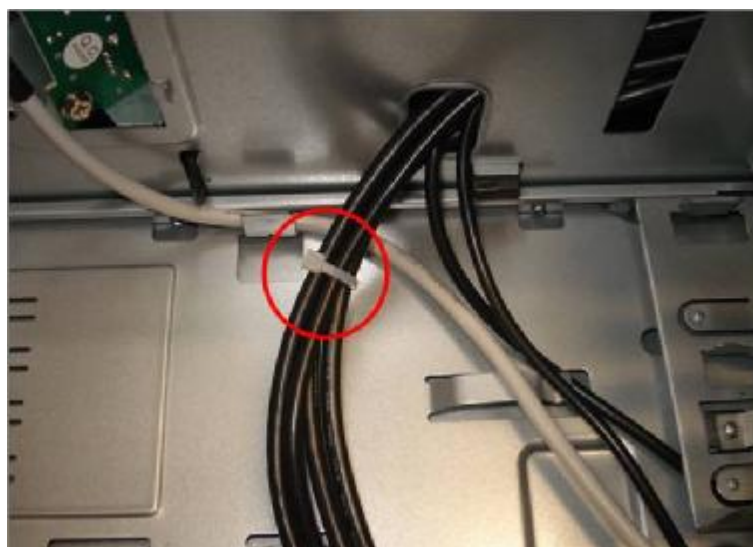

10.2 Press ten hooks on TOP Bezel , disconnect cable and remove it

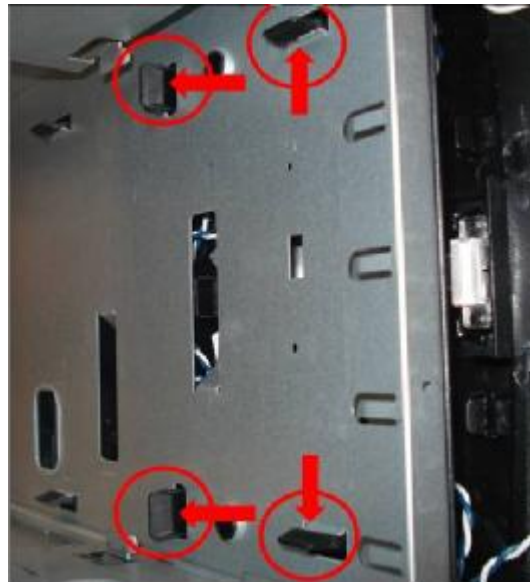
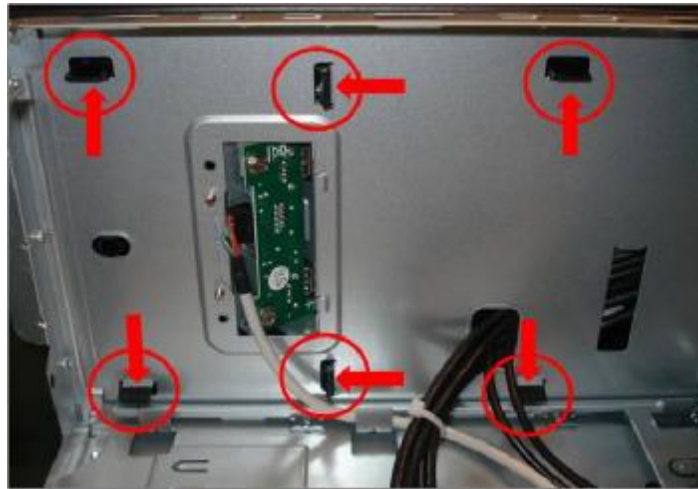

-
- 10.3** Disconnect the two screws fastening **top USB** bracket to the case and the two screws fastening PCB to bracket

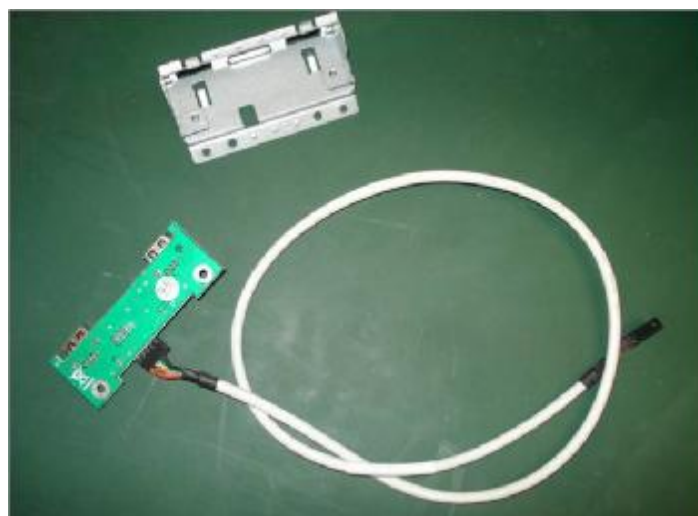
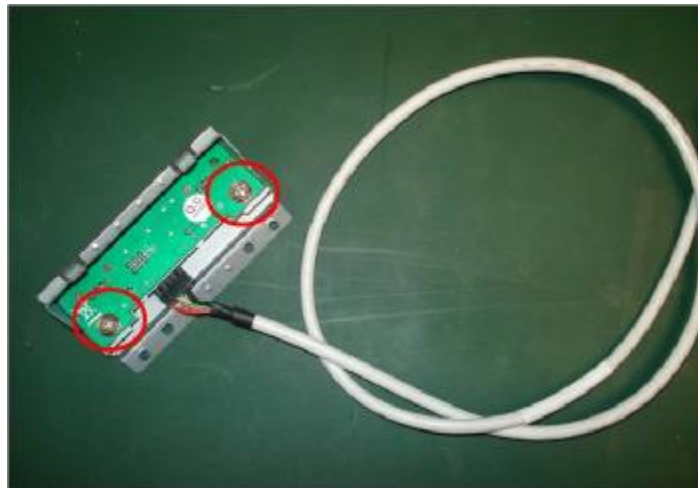

10.4 Press the bottom hook on PCB holder, remove **PCB assembly**; Press two side hooks on PCB holder, remove **POWER SWITCH PCB**



-
- 10.5** Disconnect the screw fastening **FRONT IO** bracket to the case, disconnect the button cable and the screw , then rotate bracket finger outward, and pull out the **FRONT IO**



- 10.6** Disconnect the two screws fastening **Card Reader** bracket to the case, disconnect the button cable and the screw



Troubleshooting

This chapter provides troubleshooting information for the extreme M5850 Service Guide

- I Power-On Self-Test (POST)
- I POST Error Messages List
- I Error Symptoms List
- I Undetermined Problems

Power-On Self-Test (POST)

Each time you turn on the system, the Power-on Self Test (POST) is initiated. Several items are tested during POST, but is for the most part transparent to the user.

The Power-On Self Test (POST) is a BIOS procedure that boots the system, initializes and diagnoses the system components, and controls the operation of the power-on password option. If POST discovers errors in system operations at power-on, it displays error messages on screen, generates a check point code at port 80h or even halts the system if the error is fatal.

The main components on the main board that must be diagnosed and/or initialized by POST to ensure system functionality are as follows:

- | Microprocessor with built-in numeric co-processor and cache memory subsystem
- | Direct Memory Access (DMA) controller
- | Interrupt system
- | Three programmable timers
- | ROM subsystem
- | RAM subsystem
- | CMOS RAM subsystem and real time clock/calendar with battery backup
- | Onboard parallel interface controller
- | Embedded hard disk interface and one diskette drive interface
- | Keyboard and auxiliary device controllers
- | I/O ports
 - | One parallel port
 - | One PS/2-compatible mouse port
 - | One PS/2-compatible keyboard port

NOTE: When Post executes a task, it uses a series of preset numbers called check points to be latched at port 80h, indicating the stages it is currently running. This latch can be read and shown on a debug board.

The following table describes the BIOS common tasks carried out by POST. Each task is denoted by a unique check point number. For other unique check point numbers that are not listed in the table, refer to the corresponding product service guide.

Post Checkpoints List: The list may vary accordingly depending on your BIOS

Checkpoint	Description
03	Disable NMI, Parity, video for EGA, and DMA controllers. Initialize BIOS, POST, Runtime data area. Also initialize BIOS modules on POST entry and GPNV area. Initialized CMOS as mentioned in the Kernel Variable "wCMOSFlags."
04	Check CMOS diagnostic byte to determine if battery power is OK and CMOS checksum is OK. Verify CMOS checksum manually by reading storage area. If the CMOS checksum is bad, update CMOS with power-on default values and clear passwords. Initialize status register A.
05	Initializes the interrupt controlling hardware (generally PIC) and interrupt vector table.
06	Do R/W test to CH-2 count reg. Initialize CH-0 as system timer. Install the POSTINT1Ch handler. Enable IRQ-0 in PIC for system timer interrupt. Traps INT1Ch vector to "POSTINT1ChHandlerBlock."
07	Fixes CPU POST interface calling pointer.

Checkpoint	Description
08	Initializes the CPU. The BAT test is being done on KBC. Program the keyboard controller command byte is being done after Auto detection of KB/MS using AMI KB-5.
C0	Early CPU Init Start -- Disable Cache – Init Local APIC
C1	Set up boot strap processor Information
C2	Set up boot strap processor for POST
C5	Enumerate and set up application processors
C6	Re-enable cache for boot strap processor
C7	Early CPU Init Exit
0A	Initializes the 8042 compatible Key Board Controller.
0B	Detects the presence of PS/2 mouse.
0C	Detects the presence of Keyboard in KBC port.
0E	Testing and initialization of different Input Devices. Also, update the Kernel Variables. Traps the INT09h vector, so that the POST INT09h handler gets control for IRQ1. Uncompress all available language, BIOS logo, and Silent logo modules.
13	Early POST initialization of chipset registers.
20	Relocate System Management Interrupt vector for all CPU in the system.
24	Uncompress and initialize any platform specific BIOS modules. GPNV is
2A	Initializes different devices through DIM.
2C	Initializes different devices. Detects and initializes the video adapter installed in the system that had optional ROMs.
2E	Initializes all the output devices.
31	Allocate memory for ADM module and uncompress it. Give control to ADM module for initialization. Initialize language and font modules for ADM. Activate ADM module.
33	Initializes the silent boot module. Set the window for displaying text information.
37	Displaying sign-on message, CPU information, setup key message, and any OEM specific information.
38	Initializes different devices through DIM. USB controllers are initialized at this point.

Checkpoint	Description
39	Initializes DMAC-1 & DMAC-2.
3A	Initialize RTC date/time.
3B	Test for total memory installed in the system. Also, Check for DEL or ESC keys to limit memory test. Display total memory in the system.
3C	Mid POST initialization of chipset registers.
40	Detect different devices (Parallel ports, serial ports, and coprocessor in CPU, ... etc.) successfully installed in the system and update the BDA, EBDA...etc.
52	Updates CMOS memory size from memory found in memory test. Allocates memory for Extended BIOS Data Area from base memory. Programming the memory hole or any kind of implementation that needs an adjustment in system RAM size if needed.
60	Initializes NUM-LOCK status and programs the KBD typematic rate.
75	Initialize Int-13 and prepare for IPL detection.
78	Initializes IPL devices controlled by BIOS and option ROMs.
7C	Generate and write contents of ESCD in NVRam.
84	Log errors encountered during POST.
85	Display errors to the user and gets the user response for error.
87	Execute BIOS setup if needed / requested. Check boot password if installed.
8C	Late POST initialization of chipset registers.
8D	Build ACPI tables (if ACPI is supported)
8E	Program the peripheral parameters. Enable/Disable NMI as selected
90	Initialize system management interrupt by invoking all handlers. Please note this checkpoint comes right after checkpoint 20h
A1	Clean-up work needed before booting to OS.

Checkpoint	Description
A2	Takes care of runtime image preparation for different BIOS modules. Fill the free area in F000h segment with 0FFh. Initializes the Microsoft IRQ Routing Table. Prepares the runtime language module. Disables the system configuration display if needed.
A4	Initialize runtime language module. Display boot option popup menu.
A7	Displays the system configuration screen if enabled. Initialize the CPU's before boot, which includes the programming of the MTRR's.
A9	Wait for user input at config display if needed.
AA	Uninstall POST INT1Ch vector and INT09h vector.
AB	Prepare BBS for Int 19 boot. Init MP tables.
AC	End of POST initialization of chipset registers. De-initializes the ADM module.
B1	Save system context for ACPI. Prepare CPU for OS boot including final MTRR values.
00	Passes control to OS Loader (typically INT19h).

POST Error Messages List

If you cannot run the diagnostics program tests but did receive a POST error message, use "POST Error Messages List" to diagnose system problems. If you did not receive any error message, look for a description of your error symptoms in "Error Symptoms List" on page 66.

NOTE: When you have deemed it necessary to replace an FRU, and have done so, you must run a total system check to ensure that no other activity has been affected by the change. This system check can be done through the diagnostics program.

NOTE: Check all power supply voltages, switch, and jumper settings before you replace the main board. Also check the power supply voltages if you have a "system no-power" condition.

If you are unable to correct the problem by using the "BIOS Messages List" table and "Error Symptoms List" table, go to "Undetermined Problems".

To diagnose a problem, first find the BIOS error messages in the left column. If directed to a check procedure, replace the FRU indicated in the check procedure. If no check procedure is indicated, the first Action/FRU listed in right column is the most likely cause.

BIOS Messages	Action/FRU
BIOS ROM checksum error - System halted	The checksum of the BIOS code in the BIOS chip is incorrect, indicating the BIOS code may have become corrupt. Contact your system dealer to replace the BIOS.
CMOS Battery Failed	The CMOS battery is no longer functional. Contact your system dealer for a replacement the BIOS.
CMOS Checksum Error- defaults loaded	Checksum of CMOS is incorrect, so the system loads the default equipment configuration. A checksum error may indicate that CMOS has become corrupt. A weak battery may have caused this error. Check the battery and replace if necessary.
CPU at nnnn	Displays the running speed of CPU.
Display switch is set incorrectly	The display switch on the motherboard can be set to either monochrome or color. This message indicates the switch is set to a different setting than indicated in Setup. Determine which setting is correct, and then either turn off the system and change the jumper, or enter Setup and change the Video selection.
Press ESC to skip memory test	The user may press Esc to skip the full memory test.
HARD DISK initializing - Please	Some hard drives require extra time to initialize.
HARD DISK INSTALL FAILURE	Cannot find or initialize the hard drive controller or the drive. Make sure the controller is installed correctly. If no hard drives are installed, be sure the Hard Drive Selection in Setup is set to NONE.
Hard disk(s) diagnosis fail	The system may run specific disk diagnostic routines. This message appears if one or more hard disks return an error when the diagnostics run.

BIOS Messages	Action/FRU
Keyboard Error Or No Keyboard Present	Cannot initialize the keyboard. Make sure the keyboard is attached correctly and no keys are pressed during POST. To purposely configure the system without a keyboard, set the error halt condition in Setup to HALT ON ALL, BUT KEYBOARD. The BIOS then ignores the missing keyboard during POST.
Keyboard is locked out - Unlock the key	This message usually indicates that one or more keys have been pressed during the keyboard tests. Be sure no objects are resting on the keyboard.
Memory Test:	This message displays during a full memory test, counting down the memory areas being tested.
Memory test fail	If POST detects an error during memory testing, additional information appears giving specifics about the type and location of the memory error.
Override enabled - Defaults loaded	If the system cannot boot using the current CMOS configuration, the BIOS can override the current configuration with a set of BIOS defaults designed for the most stable, minimal-performance system operations.
Press TAB to show POST screen	System OEMs may replace the Phoenix Technologies Award BIOS POST display with their own proprietary display. Including this message in the OEM display permits the operator to switch between the OEM display and the default POST display.
Primary master hard disk fail	POST detects an error in the primary master IDE hard drive.
Primary slave hard disk fail	POST detects an error in the secondary master IDE hard drive.
Secondary master hard disk fail	POST detects an error in the primary slave IDE hard drive.
Secondary slave hard disk fail	POST detects an error in the secondary slave IDE hard drive.

Error Symptoms List

NOTE: To diagnose a problem, first find the error symptom in the left column. If directed to a check procedure, replace the FRU indicated in the check procedure. If no check procedure is indicated, the first Action/ FRU listed in right column is the most likely cause.

Error Symptom	Action/FRU
Processor / Processor Fan	
NOTE: Normally, the processor fan should be operative, and the processor clock setting should be exactly set to match its speed requirement before diagnosing any processor problems.	
Processor fan does not run but power supply fan runs.	<ol style="list-style-type: none"> 1. Ensure the system is not in power saving mode. See "Power Management" in chapter 2. 2. With the system power on, measure the voltage of processor fan connector. Its reading should be +12Vdc. Its reading should be +12Vdc. If the reading shows normal, but the fan still does not work, then replace a good fan. 3. Main board.
Processor test failed.	<ol style="list-style-type: none"> 1. Processor. 2. Main board.
Main board and Memory	
NOTE: Ensure the memory modules are installed properly and the contact leads are clean before diagnosing any system problems.	
Memory test failed.	<ol style="list-style-type: none"> 1. See "Memory" 2. Main board
Incorrect memory size shown or repeated during POST.	<ol style="list-style-type: none"> 1. Insert the memory modules in the DIMM sockets properly, then reboot the system. 2. Memory module. 3. Main board.
System works but fails to enter power saving mode when the Power Management Mode is set to Enabled.	<ol style="list-style-type: none"> 1. Enter BIOS Setup and load default settings. In Windows Systems, check settings in Power Management Property of Control Panel. 2. Reload software from Recovery CD.
Blinking cursor only; system does not work.	<ol style="list-style-type: none"> 1. Diskette/IDE drive connection/cables 2. Diskette/IDE disk drives 3. See "Undetermined Problems". 4. Main board
Hard Disk Drive	
NOTE: Ensure hard disk drive is configured correctly in BIOS Setup, cable/jumper are set correctly before diagnosing any hard disk drive problems. (If only one drive is installed, please make sure the drive is connected to master connector or the drive is set to master.)	
Hard disk drive test failed.	<ol style="list-style-type: none"> 1. Enter BIOS Setup and Load default settings. 2. Hard disk drive cable. 3. Hard disk drive. 4. Main board.
Hard disk drive cannot format completely.	<ol style="list-style-type: none"> 1. Enter BIOS Setup and Load default settings. 2. Hard disk drive cable. 3. Hard disk drive. 4. Main board.
Hard disk drive has write error.	<ol style="list-style-type: none"> 1. Enter BIOS Setup and Load default settings. 2. Hard disk drive.
Hard disk drive LED fails to light, but system operates normally.	<ol style="list-style-type: none"> 1. With the system power on, measure the voltage of hard disk LED connector. 2. Hard drive LED cable.

Error Symptom	Action/FRU
CD/DVD-ROM Drive	
NOTE: Ensure CD/DVD-ROM drive is configured correctly in BIOS Setup, cable/jumper are set correctly and its laser beam is clean before diagnosing any CD/DVD-ROM drive problems.	
CD/DVD-ROM drive LED doesn't come on but works normally.	1. CD/DVD-ROM drive
CD/DVD-ROM drive LED flashes for more than 30 seconds before LED shutting off. Software asks to reinstall disc. Software displays a reading CD/DVD error.	1. CD/DVD-ROM may have dirt or foreign material on it. Check with a known good disc. 2. CD/DVD-ROM is not inserted properly. 3. CD/DVD-ROM is damaged.
CD/DVD-ROM drive cannot load or eject when the system is turned on and its eject button is pressed and held.	1. Disconnect all cables from CD/DVD-ROM drive except power cable, then press eject button to try to unload the disk. 2. CD/DVD-ROM drive power. 3. CD/DVD-ROM drive
CD/DVD-ROM drive does not read and there are no messages are displayed.	1. CD may have dirt or foreign material on it. Check with a known good disc. 2. Ensure the CD/DVD-ROM driver is installed properly. 3. CD/DVD-ROM drive.
CD/DVD-ROM drive can play audio CD but no sound output.	1. Ensure the headphone jack of the CD/DVD-ROM has an output. 2. Turn up the sound volume. 3. Speaker power/connection/cable. 4. CD/DVD-ROM drive.
Real-Time Clock	
Real-time clock is inaccurate.	1. Ensure the information in the Standard CMOS Feature of BIOS Setup is set correctly. 2. RTC battery. 3. Main board
Audio	
Audio software program invokes but no sound comes from speakers.	1. Speaker power/connection/cable.
Modem	
Modem ring cannot wake up system from suspend mode.	1. For the External Modem, make sure Power on By Ring in BIOS Setup or Power Management is set to Enabled. For the PCI modem, make sure Wake up by PCI card is set to Enabled. 2. If PCI modem card is used, reinsert the modem card to PCI slot firmly or replace the modem card. 3. In Win 98, ensure the telephone application is configured correctly for your modem and set to receive messages and/or fax.
Data/fax modem software program invokes but cannot receive/send data/fax	1. Ensure the modem card is installed properly.
Fax/voice modem software program invokes but has no sound output. (Data files are received normally; voice from modem cannot be produced, but system sound feature works normally.)	1. Ensure the modem voice-in cable from modem adapter card to main board

Error Symptom	Action/FRU
Video and Monitor	
Video memory test failed. Video adapter failed.	<ol style="list-style-type: none"> 1. Remove all non-factory-installed cards. 2. Load default settings (if screen is readable). 3. Main board
Display problem: - Incorrect colors No high intensity Missing, broken, or incorrect characters Blank monitor (dark) Blank monitor (bright) Distorted image Unreadable monitor Other monitor problems	<ol style="list-style-type: none"> 1. Monitor signal connection/cable. 2. Monitor 3. Video adapter card 4. Main board
Display changing colors.	<ol style="list-style-type: none"> 1. Monitor signal connection/cable 2. Monitor 3. Main board
Display problem not listed above (including blank or illegible monitor).	<ol style="list-style-type: none"> 1. "Monitor" 2. Load default settings (if screen is readable). 3. Main board
Parallel/Serial Ports	
Execute "Load BIOS Default Settings" in BIOS Setup to confirm ports presence before diagnosing any parallel/serial ports problems.	
Serial or parallel port loop-back test failed.	<ol style="list-style-type: none"> 1. Make sure that the LPT# or COM# you test is the same as the setting in BIOS Setup. 2. Loop-back. 3. Main board.
Printing failed.	<ol style="list-style-type: none"> 1. Ensure the printer driver is properly installed. Refer to the printer service manual. 2. Printer. 3. Printer cable. 4. Main board.
Printer problems.	<ol style="list-style-type: none"> 1. Refer to the service manual for the printer.
Keyboard	
Some or all keys on keyboard do not work.	<ol style="list-style-type: none"> 1. Keyboard
Power Supply	
Pressing power switch does not turn off system. (Only unplugging the power cord from electrical outlet can turn off the system.)	<ol style="list-style-type: none"> 1. Ensure the Soft-off by PWR-BTTN. in BIOS Setup of Power Management is not set to Instant-off. 2. Power switch cable assembly
Pressing power switch does not turn on the system.	<ol style="list-style-type: none"> 1. Ensure the power override switch (situated at the back of the machine, just above the connector for the power cable) is not set to OFF. 2. Power switch cable assembly.

Error Symptom	Action/FRU
Executing software shutdown from Windows98 Start menu does not turn off the system. (Only pressing power switch can turn off the system).	<ol style="list-style-type: none">1. Load default settings.2. Reload software from Recovery CD.
No system power, or power supply fan is not running.	<ol style="list-style-type: none">1. Power Supply2. Main board
Other Problems	
Any other problems.	<ol style="list-style-type: none">1. Undetermined Problems

Undetermined Problems

If an error message is present, go to "POST Error Messages List" on page 64. If you did not receive any messages, if the symptom is listed in "Error Symptoms List" on page 66. If you still cannot solve the problem, continue with this check:

1. Check the power supply voltages. If the voltages are correct continue with the following steps:
2. Power off the system unit.
3. Perform the following checks, one by one, until you have isolated the problem FRU.
4. Load default settings in setup.
5. Check all main board jumper positions and switch settings.
6. Check all adapter card jumper positions.
7. Check all device jumper positions.
8. Check all cables and connectors for proper installation.
9. If the jumpers, switches and voltage settings are correct, remove or disconnect the following, one at a time.
10. Non-Acer devices
 - I External devices
 - I Any adapter card (modem card, LAN card or video card, if installed)
 - I CD/DVD-ROM drive
 - I Hard disk drive
 - I DIMM
 - I Processor
 - I Main board
11. Power on the system unit.
12. Repeat steps 2 through 5 until you find the failing device or adapter.

Jumper and Connector Information

Safety Precautions

- | Follow these safety precautions when installing the motherboard
- | Wear a grounding strap attached to a grounded device to avoid damage from static electricity
- | Discharge static electricity by touching the metal case of a safely grounded object before working on the motherboard
- | Leave components in the static-proof bags they came in
- | Hold all circuit boards by the edges. Do not bend circuit boards

Choosing a Computer Case

There are many types of computer cases on the market. The motherboard complies with the specifications for the Micro ATX system case. Firstly, some features on the motherboard are implemented by cabling connectors on the motherboard to indicators and switches on the system case. Make sure that your case supports all the features required. Secondly, this motherboard supports one or two floppy diskette drives and two enhanced IDE drives. Make sure that your case has sufficient power and space for all drives that you intend to install.

Most cases have a choice of I/O templates in the rear panel. Make sure that the I/O template in the case matches the I/O ports installed on the rear edge of the motherboard.

This motherboard carries an Micro ATX form factor of 244 X 244 mm. Choose a case that accommodates this form factor.

Installing the Motherboard in a Case

Refer to the following illustration and instructions for installing the motherboard in a case.

Most system cases have mounting brackets installed in the case, which correspond the holes in the motherboard. Place the motherboard over the mounting brackets and secure the motherboard onto the mounting brackets with screws.

Ensure that your case has an I/O template that supports the I/O ports and expansion slots on your motherboard.

Checking Jumper Settings

This section explains how to set jumpers for correct configuration of the motherboard.

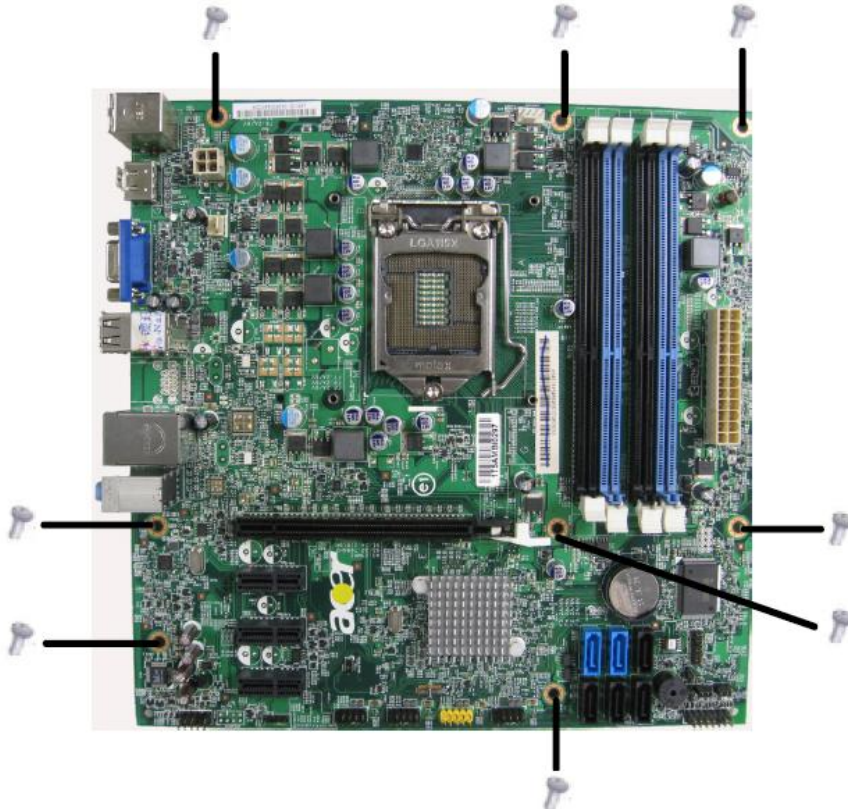

Do not over-tighten the screws as this can stress the motherboard.

Setting Jumpers

Use the motherboard jumpers to set system configuration options. Jumpers with more than one pin are numbered. When setting the jumpers, ensure that the jumper caps are placed on the correct pins.

The illustrations show a 2-pin jumper. When the jumper cap is placed on both pins, the jumper is **SHORT**. If you remove the jumper cap, or place the jumper cap on just one pin, the jumper is **OPEN**.

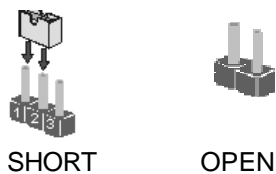

This illustration shows a 3-pin jumper. Pins 1 and 2 are **SHORT**

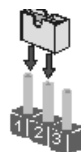

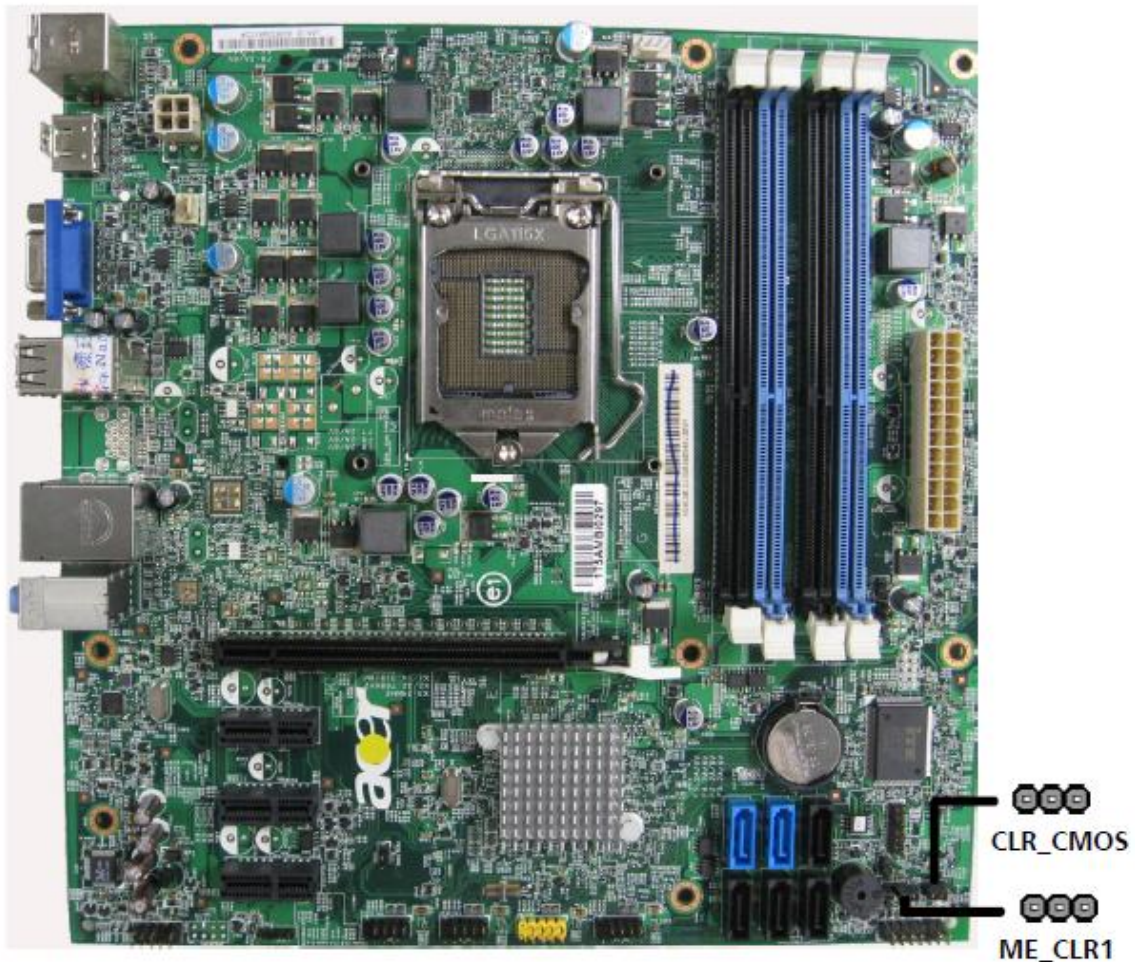

Checking Jumper Settings

The following illustration shows the location of the motherboard jumpers. Pin 1 is labeled.



Jumper Settings

Jumper	Type	Description	Setting (Default)	Illustration
CLR_CMOS	3-pin	CLEAR CMOS	1-2: NORMAL. 2-3: CLEAR Before clearing the CMOS, make sure to turn the system off	1  CLR_CMOS
ME_DISABLE	3-pin	MEDISABLE	1-2: NORMAL. 2-3: CLEAR	1  ME_DISABLE

Connecting Case Components

After you have installed the motherboard into a case, you can begin connecting the motherboard components. Refer to the following:

- 1 Connect the CPU cooling fan cable to **CPU_FAN**.
- 2 Connect the standard power supply connector to **ATX1**
- 3 Connect the auxiliary case power supply connector to **ATX_12V**.
- 4 Connect the case switches and indicator LEDs to the **LEDH1**.
- 5 Connect the system cooling fan connector to **SYS_FAN**.

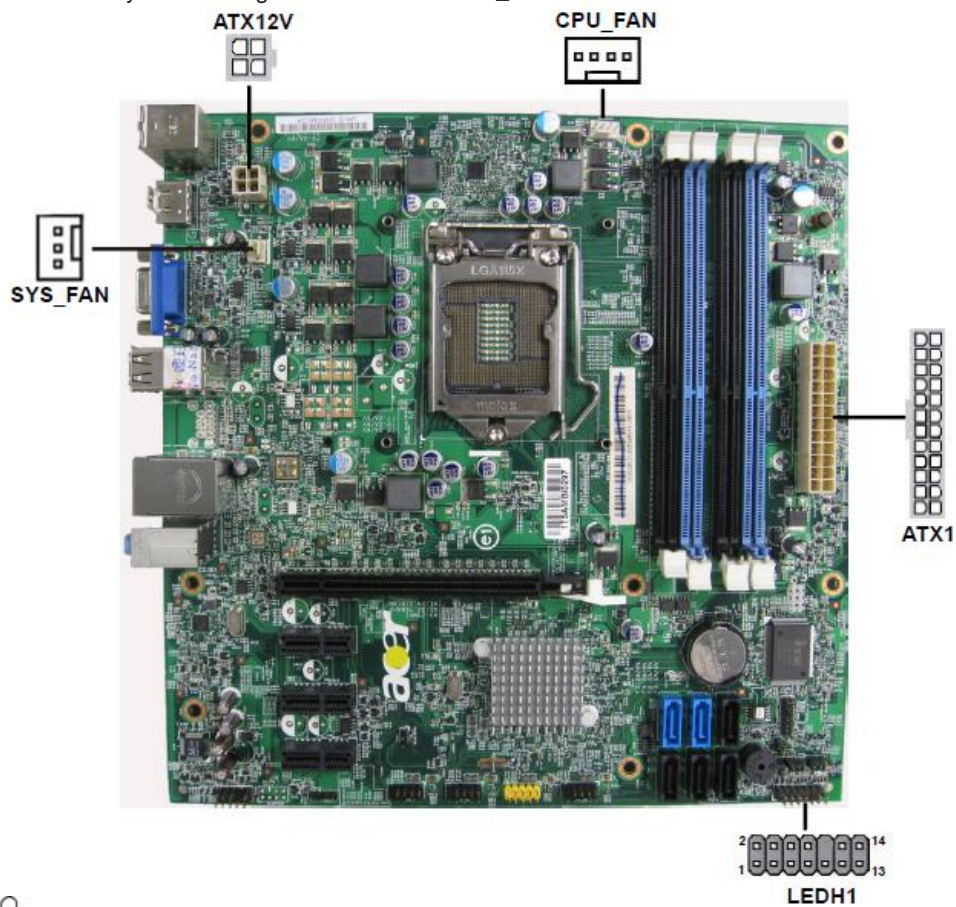

Connecting 24-pin power cable



24-pin power cable

Users please note that when installing 24-pin power cable, the latch of power cable falls on the left side of the ATX_POWER1 connector, just as the picture shows.

CPU_FAN: Cooling Fan Power Connectors

Pin	Signal Name	Function
1	GND	System Ground
2	+12V	Power +12V
3	Sense	Sensor
4	PWM	CPU FAN control

SYS_FAN: Cooling Fan Power Connector

Pin	Signal Name	Function
1	GND	System Ground
2	+12V	Power +12V
3	Sense	Sensor
4	PWM	CPU FAN control

ATX1:ATX 24-pin Power Connector

Pin	Signal Name	Pin	Signal Name
1	+3.3V	13	+3.3V
2	+3.3V	14	-12V
3	Ground	15	COM
4	+5V	16	PS_ON
5	Ground	17	Ground
6	+5V	18	Ground
7	Ground	19	Ground
8	PWRGD	20	-5V
9	+5VSB	21	+5V
10	+12V	22	+5V
11	+12V	23	+5V
12	+3.3V	24	Ground

ATX_12V: ATX 12V Power Connector

Pin	Signal Name
1	Ground
2	Ground
3	+12V
4	+12V

Front Panel Header

The front panel header (PANEL1) provides a standard set of switch and LED headers commonly found on ATX or Micro ATX cases. Refer to the table below for information:

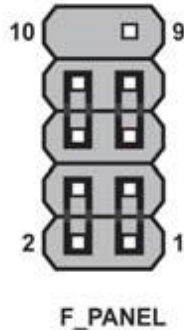

Pin	Signal Name	Function	Pin	Signal Name	Function
1	HD_LED_P	Hard disk LED(+)	2	FP PWR/SLP	*MSG LED(+)
3	HD_LED_N	Hard disk LED(-)	4	FP PWR/SLP	*MSG LED(-)
5	RST_SW_N	Reset Switch(-)	6	PWR_SW_P	Power Switch(+)
7	RST_SW_P	Reset Switch(+)	8	PWR_SW_N	Power Switch(-)
9	RSVD	Reserved	10	Key	No pin

Hard Drive Activity LED

Connecting pins 1 and 3 to a front panel mounted LED provides visual indication that data is being read from or written to the hard drive. For the LED to function properly, an IDE drive should be connected to the onboard IDE interface. The LED will also show activity for devices connected to the SCSI (hard drive activity LED) connector.

Power/Sleep/Message waiting LED

Connecting pins 2 and 4 to a single or dual-color, front panel mounted LED provides power on/off, sleep, and message waiting indication.

Reset Switch

Supporting the reset function requires connecting pin 5 and 7 to a momentary-contact switch that is normally open. When the switch is closed, the board resets and runs POST.

Power Switch

Supporting the power on/off function requires connecting pins 6 and 8 to a momentary-contact switch that is normally open. The switch should maintain contact for at least 50 ms to signal the power supply to switch on or off. The time requirement is due to internal de-bounce circuitry. After receiving a power on/off signal, at least two seconds elapses before the power supply recognizes another on/off signal.

Installing Hardware

Installing the Processor



Caution: When installing a CPU heatsink and cooling fan make sure that you **DO NOT** scratch the motherboard or any of the surface-mount resistors with the clip of the cooling fan. If the clip of the cooling fan scrapes across the motherboard, you may cause serious damage to the motherboard or its components.

On most motherboards, there are small surface-mount resistors near the processor socket, which may be damaged if the cooling fan is carelessly installed.

Avoid using cooling fans with sharp edges on the fan casing and the clips. Also, install the cooling fan in a well-lit work area so that you can clearly see the motherboard and processor socket.

Before installing the Processor

This motherboard automatically determines the CPU clock frequency and system bus frequency for the processor. You may be able to change these settings by making changes to jumpers on the motherboard, or changing the settings in the system Setup Utility. We strongly recommend that you do not over-clock processors or other components to run faster than their rated speed.



Warning: Over-clocking components can adversely affect the reliability of the system and introduce errors into your system. Over-clocking can permanently damage the motherboard by generating excess heat in components that are run beyond the rated limits.

This motherboard has an LGA1156 socket. When choosing a processor, consider the performance requirements of the system. Performance is based on the processor design, the clock speed and system bus frequency of the processor, and the quantity of internal cache memory and external cache memory.

CPU Installation Procedure

The following illustration shows CPU installation components.

- A. Opening of the Load Plate Put your thumb on the tail of the load plate and press the tail down Rotate the load plate to fully open position.
- B. Disengaging of the Load Lever Hold the hook of lever and pull it to the left side to clear retention tab. Rotate the load lever to fully open position.
- C. Removing the Cap Be careful not to touch the contact at any time.
- D. Inserting the Package Grasp the package. Ensure to grasp on the edge of the substrate. Make sure pin 1 indicator is on your bottom-left side. Aim at the socket and place the package carefully into the socket by purely vertical motion.
- E. Closing the Load Plate Rotate the load plate onto the package IHS (Intergrated Heat Spreader). Engage the load lever while pressing down lightly onto the load plate. Secure the load lever with the hook under retention tab.
- F. Fasten the cooling fan supporting base onto the CPU socket on the motherboard.
- G. Make sure the CPU fan is plugged to the CPU fan connector. Please refer to the CPU cooling fan user's manual for more detail installation procedure.



1. *To achieve better airflow rates and heat dissipation, we suggest that you use a high quality fan with 3800 rpm at least. CPU fan and heatsink installation procedures may vary with the type of CPU fan/ heatsink supplied. The form and size of fan/heatsink may also vary.*
2. *DO NOT remove the CPU cap from the socket before installing a CPU.*
3. *Return Material Authorization (RMA) requests will be accepted only if the motherboard comes with the cap on the LGA1155 socket.*



Installing Memory Modules

This motherboard accommodates two memory modules. It can support four 240-pin DR3 1066/1333. The total memory capacity is 16 GB.

DDR3 SDRAM memory module table

Memory	Memory Bus
DDR3 1066	533 MHz
DDR3 1333	667 MHz



Do not remove any memory module from its antistatic packaging until you are ready to install it on the motherboard. Handle the modules only by their edges. Do not touch the components or metal parts. Always wear a grounding strap when you handle the modules.

Installation Procedure

Refer to the following to install the memory modules.

1. This motherboard supports unbuffered DDR3 SDRAM only.
2. Push the latches on each side of the DIMM slot down.
3. Align the memory module with the slot. The DIMM slots are keyed with notches and the DIMMs are keyed with cutouts so that they can only be installed correctly.
4. Check that the cutouts on the DIMM module edge connector match the notches in the DIMM slot.
5. Install the DIMM module into the slot and press it firmly down until it seats correctly. The slot latches are levered upwards and latch on to the edges of the DIMM.
6. Install any remaining DIMM modules.



Installing Serial ATA Hard Drives

To install the Serial ATA (SATA) hard drives, use the SATA cable that supports the Serial ATA protocol. This SATA cable comes with an SATA power cable. You can connect either end of the SATA cable to the SATA hard drive or the connector on the motherboard.



SATA cable (optional)



SATA power cable (optional)

Refer to the illustration below for proper installation:

1. Attach either cable end to the connector on the motherboard.
2. Attach the other cable end to the SATA hard drive.
3. Attach the SATA power cable to the SATA hard drive and connect the other end to the power supply.



This motherboard does not support the "Hot-Plug" function.

Installing Add-on Cards

The slots on this motherboard are designed to hold expansion cards and connect them to the system bus. Expansion slots are a means of adding or enhancing the motherboard's features and capabilities. With these efficient facilities, you can increase the motherboard's capabilities by adding hardware that performs tasks that are not part of the basic system.

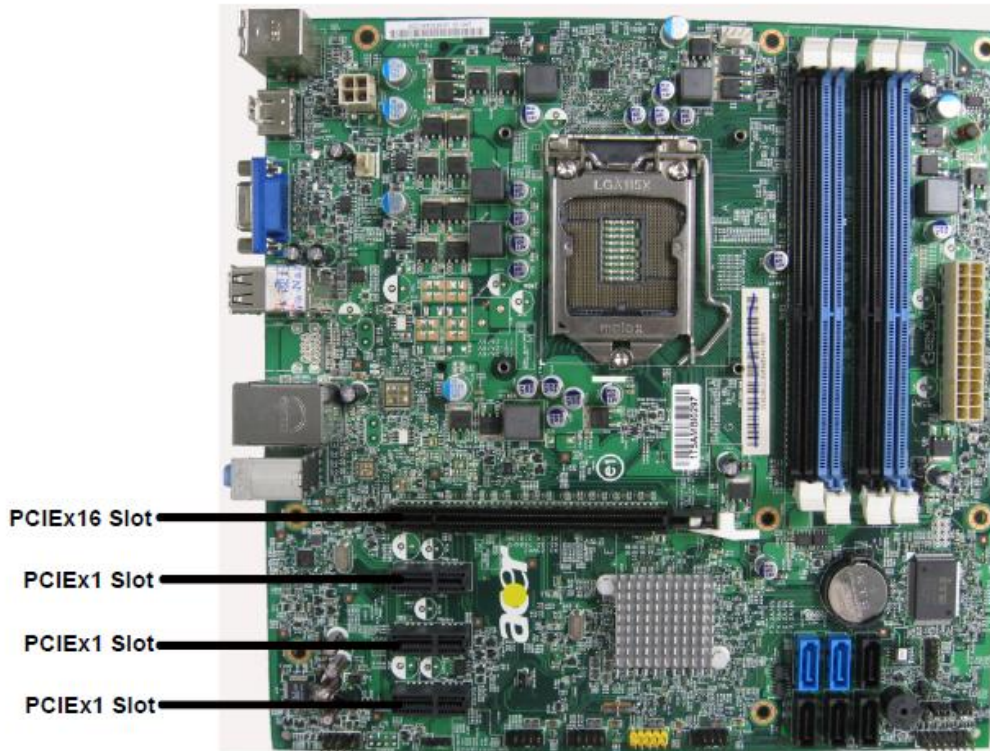

- PCIEX16 Slot*** The PCI Express x16 slot is used to install an external PCI Express graphics card that is fully compliant to the PCI Express Base Specification revision 2.0
- PCIEX1X1~3 Slot*** The PCI Express x1 slot is fully compliant to the PCI Express Base Specification revision 2.0 as well.



Before installing an add-on card, check the documentation for the card carefully. If the card not Plug and Play, you may have to manually configure the card before installation.

Follow these instructions to install an add-on card:

1. Remove a blanking plate from the system case corresponding to the slot you are going to use.
2. Install the edge connector of the add-on card into the expansion slot. Ensure that the edge connector is correctly seated in the slot.
3. Secure the metal bracket of the card to the system case with a screw.



1. For some add-on cards, for example graphics adapters and network adapters, you have to install drivers and software before you can begin using the add-on card.

2. The onboard PCI interface does not support 64-bit SCSI cards.

Connecting Optional Devices

Refer to the following for information on connecting the motherboard's optional devices:

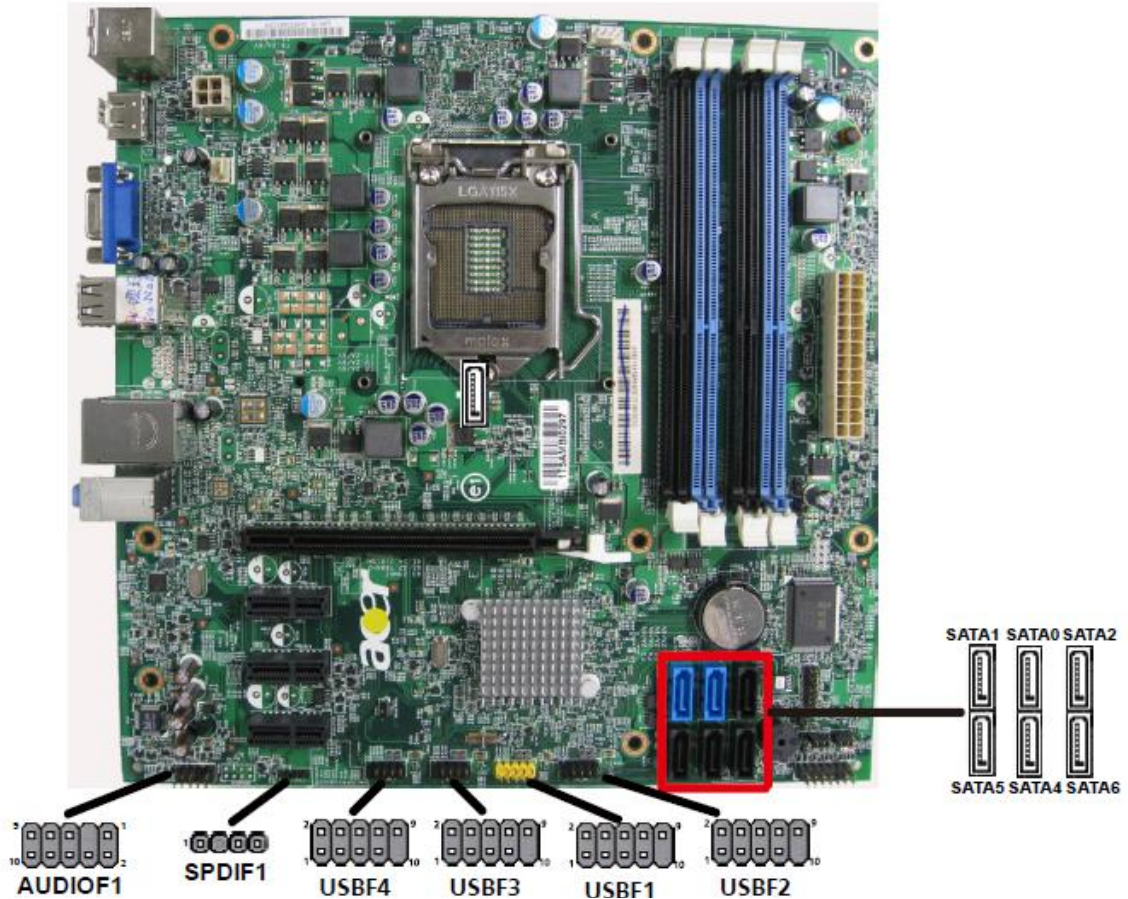

F_AUDIO1: Front Panel Audio header

This header allows the user to install auxiliary front-oriented microphone and line-out ports for easier access.

Pin	Signal Name	Pin	Signal Name
1	PORT 1L	2	AUD_GND
3	PORT 1R	4	PRESENCE#
5	PORT 2R	6	SENSE1_RETURN
7	SENSE_SEND	8	KEY
9	PORT 2L	10	SENSE2_RETURN

SATA 1~6: Serial ATA connectors

These connectors are used to support the new Serial ATA devices for the highest data transfer rates (3 Gb/s), simpler disk drive cabling and easier PC assembly. It eliminates limitations of the current Parallel ATA interface. But maintains register compatibility and software compatibility with Parallel ATA.

Pin	Signal Name	Pin	Signal Name
1	Ground	2	TX+
3	TX-	4	Ground
5	RX-	6	RX+
7	Ground	-	-

SPDIF_OUT1: SPDIF out header(Optional)

This is an optional header that provides an S/PDIF (Sony/Philips Digital Interface) output to digital multimedia device through optical fiber or coaxial connector.

Pin	Signal Name	Function
1	+5VA	5V analog Power
2	Key	No pin
3	SPDIF	SPDIF digital output
4	GND	Ground

F_USB1~4: Front Panel USB headers

The motherboard has four USB ports installed on the rear edge I/O port array. Additionally, some computer cases have USB ports at the front of the case. If you have this kind of case, use auxiliary USB connector to connect the front-mounted ports to the motherboard.

Pin	Signal Name	Function
1	USBPWR	Front Panel USB Power
2	USBPWR	Front Panel USB Power
3	USB_FP_P0-	USB Port0 Negative Signal
4	USB_FP_P1-	USB Port1 Negative Signal
5	USB_FP_P0+	USB Port0 Positive Signal
6	USB_FP_P1+	USB Port1 Positive Signal
7	GND	Ground
8	GND	Ground
9	Key	No pin
10	USB_FP_OC0	Overcurrent signal



Please make sure that the USB cable has the same pin assignment as indicated above. A different pin assignment may cause damage or system hang-up.

FRU (Field Replaceable Unit) List

Exploded Diagram

Chassis_PB 30L w/ HDD carrier ME BOM

Item	Description	Item	Description
1	P5_30L_LFFT_SIDE_COVER	23	P5_30L_MB_STUD_6_32_H6_6
2	P5_30L_PCI_LOCK	24	SCREW_M632-6
3	PCI_SHIELDING	25	RIVET_32_UMBRELLA_HEAD
4	P5_30L_MAIN_CHASSIS	26	RIVET_32_FLAT_HEAD
5	P5_30L_CHASSIS_SUPPORT	27	FRONT-COVER-PB
6	P5_30L_MB_SUPPORT	28	HDD-CARRIER-GEAR
7	PB_RIGHT_SIDE_COVER	29	ODD_DOOR_TOP
8	TOP_USB_ASM	30	CD-AXES
9	TOP_USB_PCB	31	PACKARD_BELL_LOGO
10	POWER_PCB HOLDER	32	ODD_BUTTON_TOP_LOCK
11	POWER_PCB	33	BEZEL-FRONT
12	FRONT_SWITCH_HOLDER	34	CD-DOOR-SPRING
13	FIO_M150_-02-001	35	LED_D5
14	P5_30L_USB_BRACKET	36	TOP-BEZEL-BASE
15	PB-NS_P5_MCR	37	TOP-LENS
16	LED-HOUSING_CLED_1J	38	TOP-BEZEL-BASE_PANEL
17	LED	39	TOP-BEZEL-COVER
18	Clip	40	TOP-BEZEL-FACE
19	P5_30L_ODD_CAGE	41	LIGHT-SWICH
20	P5_30L_HDD_CAGE	42	SPRING_ODD_EJECTION
21	P5_30L_HDD_SCREW_6_32_H9_7	43	POWER_BUTTON
22	CHASSIS FOOT	44	POWER_BUTTON_LENS

Item	Description	Item	Description
45	RAY_LED_5_1	67	HDD-CARRIER- SPRING-PIN
46	LIGHT_BASE	68	hdd-carrier-handle
47	ODD_BUTTON_TOP	69	HDD-CARRIER-LATCH
48	ODD_BUTTON_BOTTOM	70	SWITCH
49	SPRING-03		
50	FRONT-LENS		
51	HDD_LENS		
52	BEZEL-FRONT-PANEL		
53	CILUN-02		
54	PG-07M		
55	YAXIANG-COVER		
56	REVOLVE-GAN		
57	SPRING-03		
58	P5_30L_HDD_CHRRINR_BKT_B		
59	P5_30L_HDD_CHRRINR_BKT_A		
60	P5_30L_HDD_CHRRINR_BKT_EMI		
61	TATA		
62	SCREW_M3		
63	Hdd-carrier-latch		
64	HDD-CARRIER-MAIN		
65	HDD_CARRIER_EMI_BKT		
66	HDD-CARRIER-AXIS-SPRING		

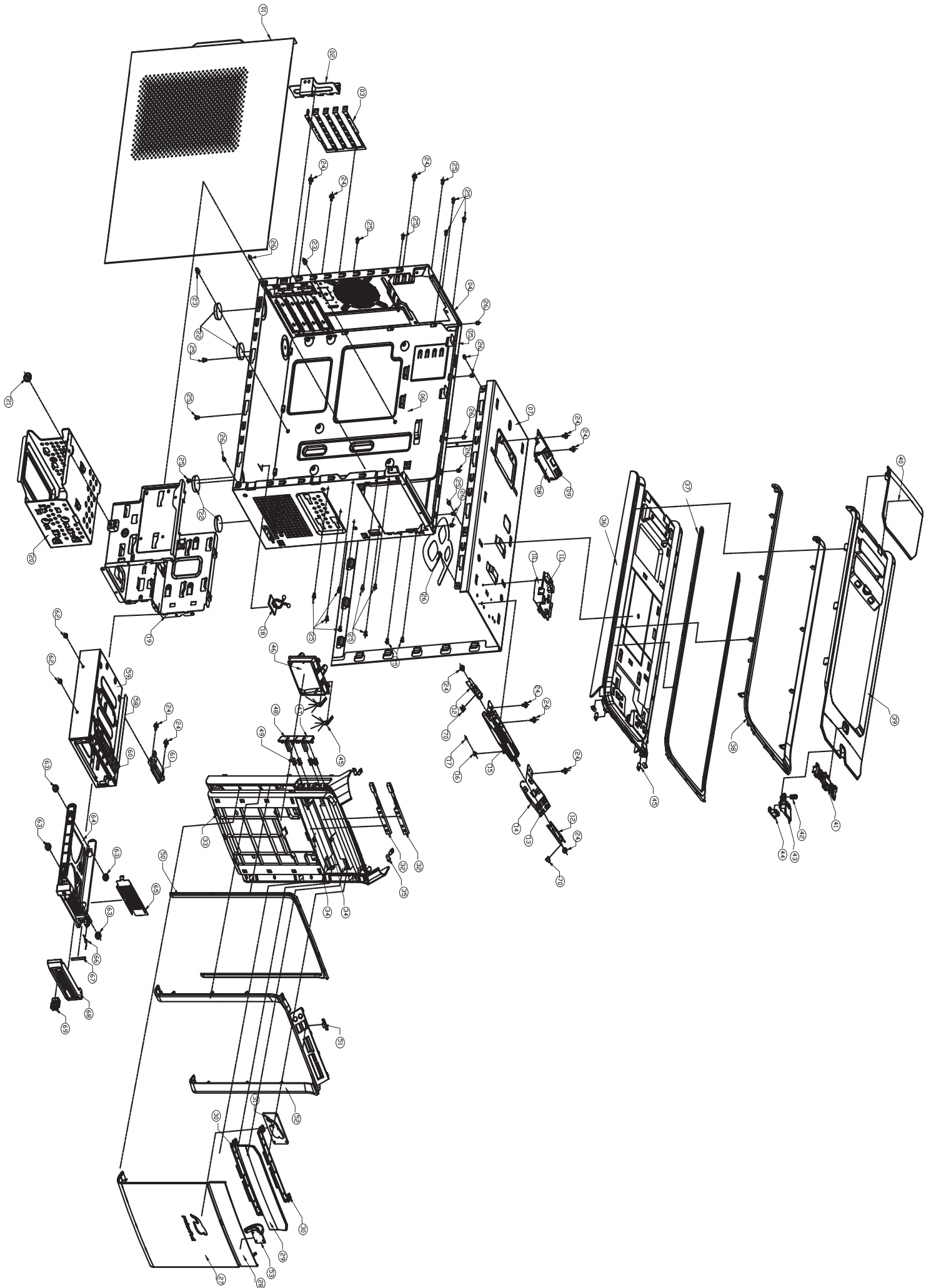

Chassis_PB 30L w/o HDD carrier ME BOM

Item	Description	Item	Description
1	P5_30L_LFFT_SIDE_COVER	24	SCREW_M632-6
2	P5_30L_PCI_LOCK	25	RIVET_32_UMBRELLA_HEAD
3	PCI_SHIELDING	26	RIVET_32_FLAT_HEAD
4	P5_30L_MAIN_CHASSIS	27	FRONT-COVER-PB
5	P5_30L_CHASSIS_SUPPORT	28	ODD_DOOR_BOTTOM
6	P5_30L_MB_SUPPORT	29	ODD_DOOR_TOP
7	PB_RIGHT_SIDE_COVER	30	CD-AXES
8	TOP_USB_ASM	31	PACKARD_BELL_LOGO
9	TOP_USB_PCB	32	ODD_BUTTON_TOP_LOCK
10	POWER_PCB HOLDER	33	BEZEL-FRONT
11	POWER_PCB	34	CD-DOOR-SPRING
12	FRONT_SWITCH HOLDER	35	LED_D5
13	FIO_M150_-02-001	36	TOP-BEZEL-BASE
14	P5_30L_USB_BRACKET	37	TOP-LENS
15	PB-NS_P5_MCR	38	TOP-BEZEL-BASE_PANEL
16	LED-HOUSING_CLED_1J	39	TOP-BEZEL-COVER
17	LED	40	TOP-BEZEL-FACE
18	Clip	41	LIGHT-SWICH
19	P5_30L_ODD_CAGE	42	SPRING_ODD_EJECTION
20	P5_30L_HDD_CAGE	43	POWER_BUTTON
21	P5_30L_HDD_SCREW_6_32_H9_7	44	POWER_BUTTON_LENS
22	CHASSIS FOOT	45	RAY_LED_5_1
23	P5_30L_MB_STUD_6_32_H6_6	46	LIGHT_BASE

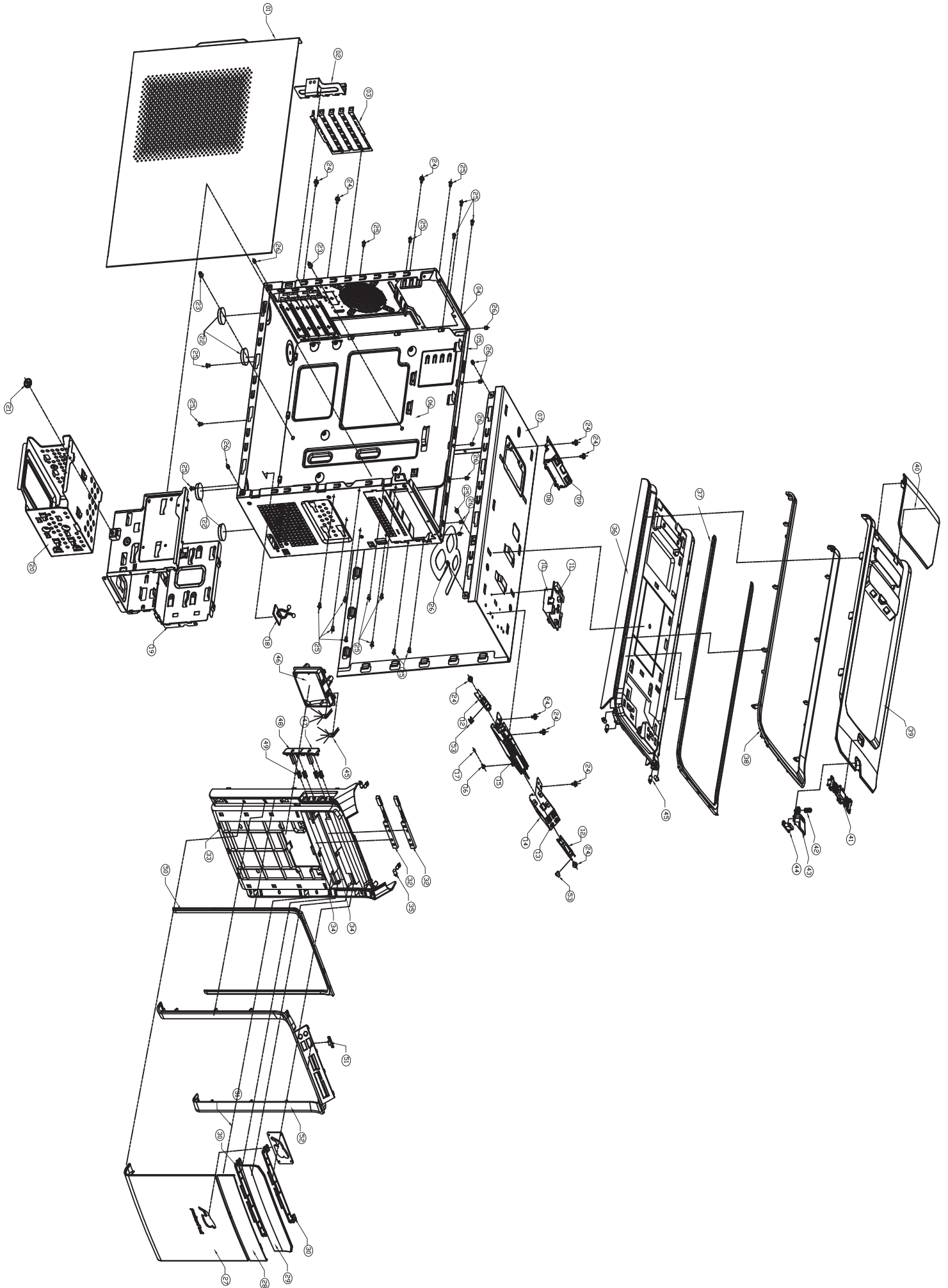

FRU List

The FRU list will be updated later.

Free Manuals Download Website

<http://myh66.com>

<http://usermanuals.us>

<http://www.somanuals.com>

<http://www.4manuals.cc>

<http://www.manual-lib.com>

<http://www.404manual.com>

<http://www.luxmanual.com>

<http://aubethermostatmanual.com>

Golf course search by state

<http://golfingnear.com>

Email search by domain

<http://emailbydomain.com>

Auto manuals search

<http://auto.somanuals.com>

TV manuals search

<http://tv.somanuals.com>