

CD Color Printer II

User's Manual

© 1998 All rights reserved.

Notices: The information in this document is subject to change without notice.

NO WARRANTY OF ANY KIND IS MADE WITH REGARD TO THIS MATERIAL, INCLUDING, BUT NOT LIMITED TO, THE IMPLIED WARRANTIES OF MERCHANTABILITY AND FITNESS FOR A PARTICULAR PURPOSE. No liability is assumed for errors contained herein or for incidental damages in connection with the furnishing, performance, or use of this material. This document contains proprietary information which is protected by copyright. All rights are reserved. No part of this document may be photocopied, reproduced, or translated into another language without the prior written consent.

Trademark Acknowledgments: IBM is a registered trademark of International Business Machines Corporation. Windows is a trademark of Microsoft Corporation. Apple and Macintosh are registered trademarks and QuickDraw and AppleTalk are trademarks of Apple Computer, Inc. All other trademarks are the property of their respective owners. Candela is a registered trademark of Candela Ltd. © 1995 Candela® Color Management Systems.



Printing History

Edition 2.2, #990223, © Copyright 1998, All rights reserved.

FCC Compliance Statement: This device complies with part 15 of the FCC rules. Operation is subject to the following two conditions: (1) this device may not cause harmful interference, and (2) this device must accept any interference received, including interference that may cause undesired operation.

For Users in the United States: This equipment has been tested and found to comply with the limits for a Class B digital device, pursuant to Part 15 of the FCC Rules. These limits are designed to provide reasonable protection against harmful interference in a residential installation. This equipment generates, uses, and can radiate radio frequency energy and, if not installed and used in accordance with the instructions, may cause harmful interference to radio communications. However, there is no guarantee that interference will not occur in a particular installation. If this equipment does cause harmful interference to radio or television reception, which can be determined by turning the equipment off and on, the user is encouraged to try to correct the interference by one or more of the following measures:

- Re-orient or relocate the receiving antenna.
- Increase the separation between the equipment and receiver.
- Connect the equipment into an outlet on a circuit different from that to which the receiver is connected.
- Consult the dealer or an experienced radio/TV technician for help.

Use of a shielded cable is required to comply with the Class B limits of Part 15 of the FCC Rules. You are cautioned that any changes or modifications not expressly approved in this manual could void your authority to operate and/or obtain warranty service for this equipment.

For Users in Canada: This digital apparatus does not exceed the Class B limits for radio noise for digital apparatus set out on the Radio Interference Regulations of the Canadian Department of Communications. Le présent appareil numérique n'émet pas de bruits radioélectriques dépassant les limites applicables aux appareils numériques de la class B prescrites dans le Règlement sur le brouillage radioélectrique édicté par le ministère des Communications du Canada.

For Users in Taiwan:

警告使用者：

這是甲類資訊產品，在居住環境中使用時，可能會造成射頻干擾，在這種情況下，使用者會被要求採取某些適當的對策。

CAUTION!

TO PREVENT FIRE OR SHOCK HAZARD, DO NOT EXPOSE THE UNIT TO RAIN OR MOISTURE. TO REDUCE THE RISK OF ELECTRIC SHOCK, DO NOT REMOVE EXTERIOR PANELS. NO USER-SERVICEABLE PARTS INSIDE. REFER SERVICING TO QUALIFIED SERVICE PERSONNEL. OPERATE THE UNIT ONLY ON 100-120 VAC, 50/60 HZ. FOR PRINTERS THAT HAVE BEEN SHIPPED OUTSIDE OF THE UNITED STATES AND CANADA, OPERATE THE UNIT ONLY ON 220-250 VAC, 50/60 HZ. USE PRINTER ONLY WITH THE POWER SUPPLY LABELED FOR USE WITH THE CD COLOR PRINTER.

Table of Contents

Section 1: Getting Started

- A. Choosing a Good Location.....1
- B. Unpacking and Inspection1
- C. Identifying the Parts.....2
- D. Applying Power.....3

Section 2: Ink Cartridges and Printable CD's

- A. About Ink Cartridges and Printable CD's4
- B. Installing an Ink Cartridge4
- C. Loading Blank CD Media.....6
- D. Printing a Self Test.....8
- E. Replacing or Switching Ink Cartridges.....9

Section 3: Using the CD Color Printer with Windows

- A. Connecting the Printer to Your Computer12
- B. Installing the Printer Driver.....13
- C. Installing the 32-Bit Spooler for Windows 95/98.....15
- D. Setting Up the Printer Driver17
- E. Printing a CD25

Section 4: Using the CD Color Printer with Macintosh

- A. Connecting the Printer to Your Computer27
- B. Installing the Printer Driver.....28
- C. The Chooser.....29
- D. Setting Up the Printer Driver30
- E. Printing a CD35

Section 5: Using the Print Backgrounder for Macintosh

- A. Installing the Backgrounder.....37
- B. Printing with the Backgrounder.....37
- C. The Backgrounder Status Window38
- D. Backgrounder Menus.....39
- E. Problems During a Background Print.....41

Section 6: Interpreting the Printer Indicator Lights.....42

Section 7: Maintaining the Printer

- A. Cleaning the Ink Cartridge Nozzles43
- B. Cleaning the CD Tray and Printer Casing.....43
- C. Clearing a CD Media Jam43
- D. Technical Support44

Section 8: Technical Specifications45

Appendix A: Interfacing Information

- A. Introduction.....46
- B. Centronics-Type Parallel Interface46
- C. Mini 8-Pin Serial Interface.....47
- D. 6-Pin Minicircular Auxiliary Interface.....48

Index49

Section 1: Getting Started

THANK YOU...

...for choosing the CD Color Printer II. This printer is the perfect way for you to label all of your custom CD's quickly, easily, and with a touch of class. The CD Color Printer lets you print razor-sharp text, vibrant spot colors, and even stunning photo-realistic photographs directly onto the surface of printable CD's. Operation is simple, quality is high, and printed images are durable and highly smudge-resistant.

To begin using the printer, please refer to the remainder of this manual. This User's Manual is your complete step-by-step guide to quickly and easily setting up and printing with your new CD Color Printer!

A. CHOOSING A GOOD LOCATION

- Place the printer in a location with adequate air circulation to prevent internal heat build up.
- Do not place the printer near heat sources such as radiators or air ducts or in a place subject to direct sun-light, excessive dust, mechanical vibration or shock.
- Allow for adequate clearance in front of the printer to accommodate the length of the unit with its CD Tray open.

B. UNPACKING AND INSPECTION

While unpacking your printer, inspect the carton to ensure that no damage has occurred during shipping. Make sure that all supplied accessories are included with your unit. The following items should be included:

- Printer
- Power Cord
- Printer Software CD
- Color Ink Cartridge
- Spare Ink Cartridge Holder
- Cardboard CD Templates (5)
- Warranty Statement and Registration Card
- This manual and other printed information

Save the carton and packing materials. They will come in handy when transporting the printer.

C. IDENTIFYING THE PARTS



This illustration shows the extended CD Tray and all of the control buttons and LED indicator lights found on the printer.

The  **Power Button** turns the printer's power ON and OFF. This button also serves to cancel the current print job if a print error occurs and to reset the printer for the next print job.

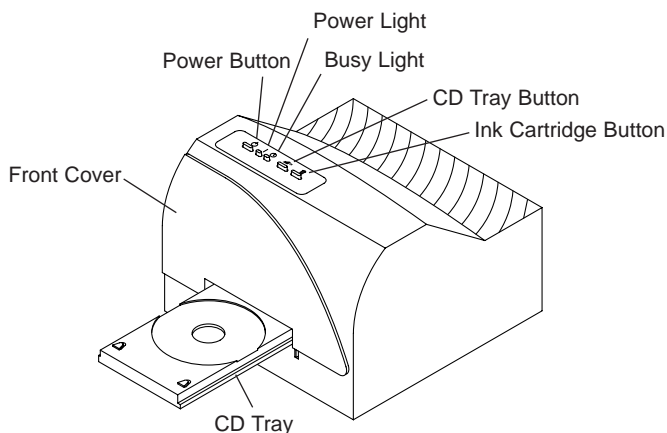
The  **CD Tray Button** opens or closes the CD Tray for loading and ejecting CD's.



The  **Ink Cartridge Button** positions the Cartridge Carrier for easy ink cartridge replacement.

The  **Power Light** indicates that power is ON. The  **Busy Light** indicates that the printer is printing, processing, or is in some way busy. Both of these lights can also indicate several other printer conditions. For complete information on these lights, please refer to Section 6.

This illustration shows the input ports found on the rear panel of the printer. Both a parallel and a serial interface port are provided. If using the printer with Windows, you will use its Parallel Interface Port. If using the printer with an Apple® Macintosh, you will use its Serial Interface Port. Note that the printer's auxiliary port is for factory use only unless otherwise directed. For more information on each of the interface ports, please refer to Appendix A.

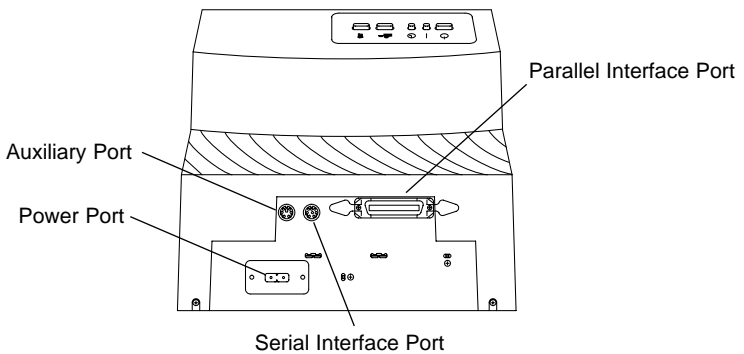

D. APPLYING POWER

1. Locate the power cord supplied with your printer.
2. Place one end of the cord into the power port on the rear panel of the printer.

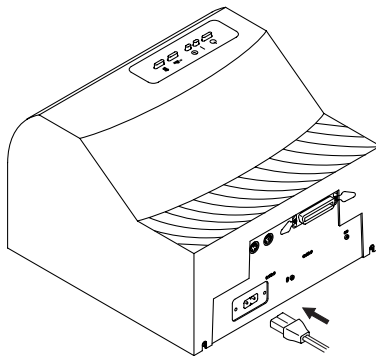

3. Place the other end of the power cord into an available wall outlet. Once the power cord is connected, the printer will automatically turn ON.

Section 2: Ink Cartridges and Printable CD's

A. ABOUT INK CARTRIDGES AND PRINTABLE CD'S

For full-color printing, a 3-color ink cartridge is available. This cartridge contains the three process-color inks of yellow, magenta, and cyan, which combine to produce up to 16.7 million printable colors. A monochrome ink cartridge is also available for fast, inexpensive black and white printing.

With either of these ink cartridges, you can print directly onto virtually any brand of printable-surface CD media. Since different brands of CD's have different printable coatings, however, you may need to adjust the printer driver settings to accommodate your specific brand of CD media. Refer to Section 3 or 4 for further printer driver information.

Due to the wide variety of printable-surface CD media, you may find that certain brands of CD's provide higher print quality than others. For maximum print quality, use CD media authorized by the printer manufacturer. Contact your local CD Color Printer reseller or contact the printer manufacturer directly for selection and pricing on all printer supplies and accessories.

B. INSTALLING AN INK CARTRIDGE

1. With the CD Tray closed, open the printer's front cover by pulling down on its top-left corner.

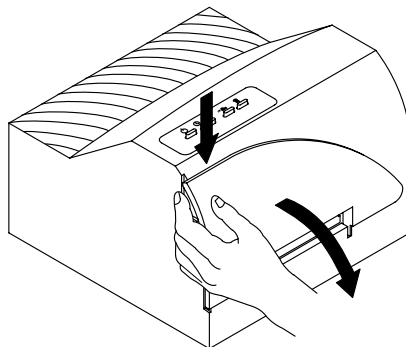

2. Remove the ink cartridge from its packaging.
3. Remove the tape covering the cartridge's printhead.
DO NOT TOUCH THE COPPER AREA!

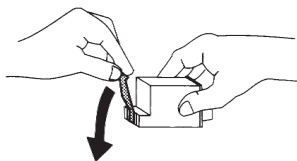

4. Press and release the  Ink Cartridge button to move the carrier to the load position.
5. Insert the ink cartridge into the cartridge carrier, copper-end first.

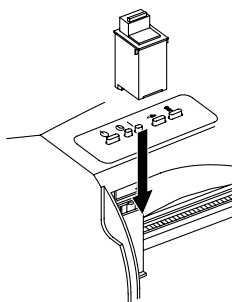

6. Push the cartridge back until it snaps into place.

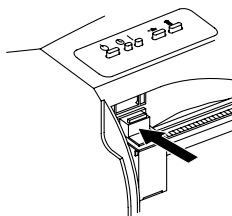

7. Press and release the  Ink Cartridge button again to reset the cartridge carrier.
8. Close the printer's front cover.



NOTE: A Spare Ink Cartridge Holder is included with your printer. This holder provides a convenient place to store an extra ink cartridge and also prevents an opened ink cartridge from drying out. To use this holder, simply insert an Ink Cartridge into the holder, copper-end first, until it snaps into place.

C. LOADING BLANK CD MEDIA

The CD Color Printer is capable of printing onto a variety of CD related media including printable CD's, cardboard CD templates, and jewel case booklets and inserts. Each of these items is loaded one at a time, before the start of each print job.

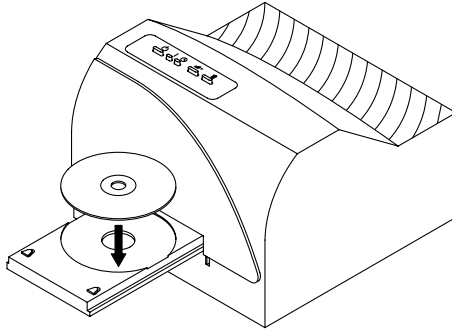
Loading a Blank CD



1. With the printer's front cover shut, press and release the  CD Tray button.
2. Once the CD Tray is fully extended, place the blank CD onto the tray with the printable side facing upward. Handle the CD only along its edges and **DO NOT** touch its printable surface.
3. Press and release the  CD Tray button to close the CD Tray. If you wish, you may also leave the CD Tray open and it will automatically close at the start of the print job. Once the CD has been printed, the CD Tray will automatically re-open so the next blank CD can be loaded.

NOTE: Blank Cardboard CD templates are available for printing inexpensive test prints and can be printed on both sides. Load in the exact same fashion as an actual CD.

Loading a Blank Jewel Case Booklet or Insert

Blank CD jewel case booklets and inserts are available for creating custom jewel case labels. The jewel case booklet is what slips into the top lid of the jewel case. The jewel case insert is what is enclosed along the spine and back of the jewel case. To load either, refer to the following:

1. With the printer's front cover shut, press and release the  CD Tray button.
2. Once the CD Tray is fully extended, place the blank jewel case media into the CD Tray's securing clips as shown below. Be sure to read the instructions printed on the media for a description of which tear-off sections of the media to remove before and/or after printing.

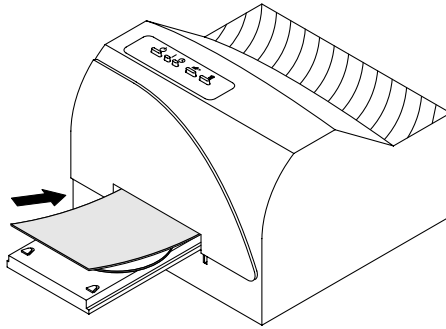

First insert leading edge into printer.

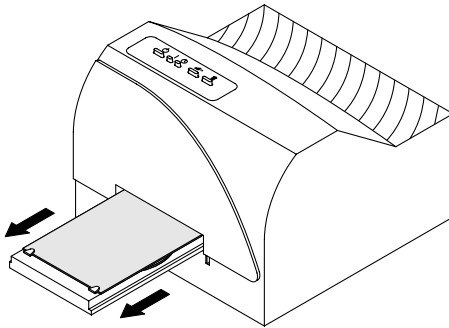

Then, pull back and secure beneath securing clips.



3. Press and release the  CD Tray button to close the CD Tray. If you wish, you may also leave the CD Tray open and it will automatically close at the start of the print job. Once printing is complete, the CD Tray will automatically re-open.

In order for the printer to print properly, CD media must be installed. If you accidentally attempt to print without installing any media, the CD Tray will open and the printer will pause until media is loaded and the CD Tray is closed. When closing the CD Tray, do not manually push on the front of the tray to close it. Instead, always press the  CD Tray button to open or close the CD Tray.

IMPORTANT! *After you have loaded the CD media, you must also select the appropriate Media option from within the printer driver setup window. Please refer to Section 3 or 4 for more information on selecting printer driver settings.*

D. PRINTING A SELF TEST

Now that the printer is set up and print supplies are loaded, a self test should be performed to check for proper operation of the printer. A sample of the self test print is shown below. Refer to the following steps to run a self test:

1. If power is ON, turn it OFF now. The Power light should be OFF. Verify that print supplies are installed and that the CD Tray is closed. Also, disconnect the interface cable from the printer if connected.
2. With the printer's front cover shut, press and hold the  CD Tray button as you turn the printer power ON.
3. Continue to hold the  CD Tray button down for approximately 8 seconds, until you hear the self test begin to print.

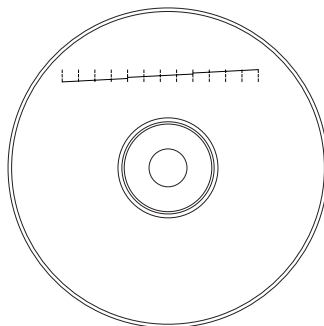

E. REPLACING OR SWITCHING INK CARTRIDGES

Once you begin using your CD Color Printer on a regular basis, you will eventually need to replace an empty ink cartridge or switch between color and monochrome cartridges. **To do this from a Macintosh, Windows 3.1x, or Windows NT, use the same steps described in Part B of this section.** To do this from Windows 95/98, please refer to the following steps:

1. With the CD Tray closed, open the printer's front cover by pulling down on its top-left corner.

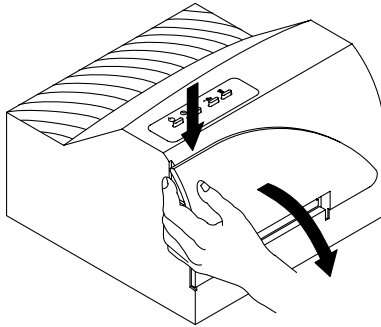

2. If installing a new, replacement ink cartridge, remove the cartridge from its packaging and remove the tape covering the cartridge's printhead. **DO NOT TOUCH THE COPPER AREA!**

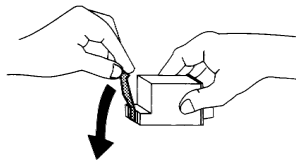

3. If switching between color and monochrome cartridges, simply remove the extra cartridge from the Spare Ink Cartridge Holder by grasping the top of the cartridge and firmly pulling it straight toward you. You will hear the cartridge snap out of position.

4. From within the printer driver setup window, click on the **Cartridge** button and then on the **Change** button to move the carrier to the load position. Note that the printer driver must be installed and that the printer must be connected to your computer (see Section 3) in order to complete this step.
5. Remove the installed ink cartridge by grasping the top of the cartridge and firmly pulling it straight toward you. You will hear the cartridge snap out of position. Remove it from the printer.

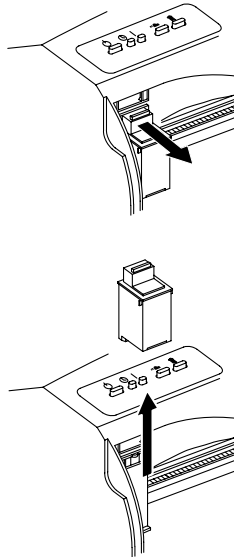

6. Insert the replacement or extra ink cartridge into the cartridge carrier, copper-end first.

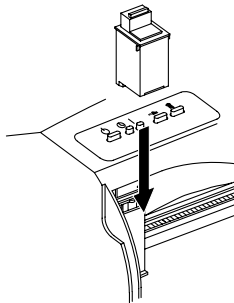

7. Push the cartridge back until it snaps into place.

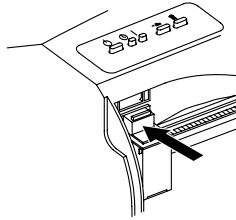

8. Go back to the printer driver setup window and click on either the **New Cartridge Installed** or the **Old Cartridge Installed** button to indicate whether you installed a fresh, new cartridge or simply switched between a previously used color cartridge and a previously used monochrome cartridge. The cartridge carrier will return to its home position. See Section 3-D for more information on these buttons.
9. Close the printer's front cover.

Section 3: Using the CD Color Printer with Windows

A. CONNECTING THE PRINTER TO YOUR COMPUTER

The CD Color Printer is designed to be used with nearly any IBM-PC® or compatible running Windows 3.1x, Windows NT, or Windows 95/98. For best performance, a minimum of a 486/66 computer with 8MB of RAM or higher is recommended.

The printer is equipped with a standard 8-bit Centronics-type parallel port. This port is the means through which it receives data from your computer. To connect the printer to your computer, simply obtain a shielded, bi-directional parallel cable, and refer to the following steps:

NOTE: For faster printing, your computer's parallel port mode should be set to ECP. If you experience problems with this setting or if your computer's parallel port is not ECP compatible, set your computer's parallel port to the standard "Printer Port" setting. Refer to your computer's system documentation for instructions on checking and/or changing the parallel port mode.

1. Connect the Centronics-type parallel side of the cable to the printer. Snap the fastening clips into place.

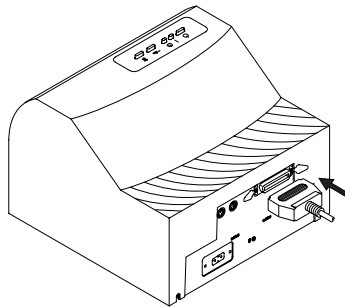

2. Connect the other side to the back of your computer at LPT1, LPT2, or the PARALLEL connector.

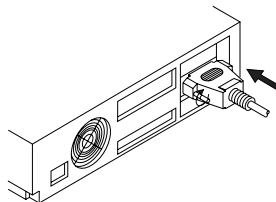

The printer must have its Power light illuminated to receive data. If the light is not on, press the  Power button.

B. INSTALLING THE PRINTER DRIVER

The CD Color Printer can be used with virtually any Windows application program. This is accomplished by installing in Windows what is called a “printer driver.” The printer driver is simply software which gives the printer all the information needed for printing. Use the following steps to install the printer driver.

NOTE: *This section of the Operator’s Manual assumes that you are already familiar with Windows and know how it operates. If you are not yet familiar with Windows, consult the appropriate Microsoft documentation to become familiar with the basics of Windows before proceeding.*

Windows 95/98 or Windows NT

To install the printer driver into Windows 95/98 or Windows NT, refer to the following:

1. Insert the included CD into your computer’s CD-ROM drive.
2. Click the **Start** button, point to **Settings**, and select **Printers**.

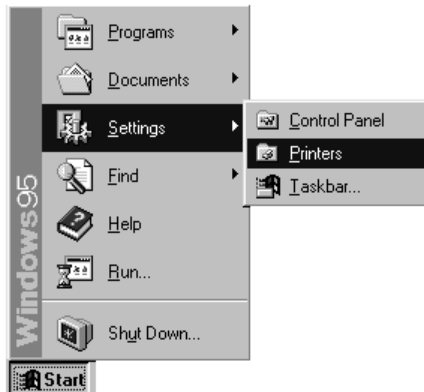

3. Double-click on the **Add Printer** icon. This will launch the Add Printer Wizard. Click **Next**, then click **Next** again.



4. Click the **Have Disk** button.
5. Click **Browse**, select your CD-ROM drive, and open the folder named **Windows and NT Software**.
6. For Windows 95/98, open the **Windows Driver** folder and select the file named **CDCOLOR2.INF**. For Windows NT, open the **NT Driver** folder and select the file named **OEMSETUP.INF**. (*Example:* If you are installing the Windows 95/98 driver, and your CD-ROM drive is drive D:, then you would browse to: D:\Windows and NT Software\Windows Driver. You would then select the file named CDCOLOR2.INF.) Follow the on-screen instructions to complete installation. Once installed, the "CD Color Printer II" icon will appear in the Printer's folder.



CD Color Printer II

IMPORTANT! *Once the printer driver software is installed, the Image Placement values labeled on your printer's rear panel must be entered into the printer driver's Calibrate window (see page 22). These values have been optimized specifically for your printer and allow images to be centered on a CD when printed.*

NOTE: *Before installing updated printer driver versions, always delete the existing printer driver version from your system. To do this, simply select the printer driver icon from within the Printers folder, and press the Delete key.*

C. INSTALLING THE 32-BIT PRINT SPOOLER FOR WINDOWS 95/98

Your CD Color Printer ships with a print utility program called the 32-Bit Print Spooler. This print spooler is for use only with Windows 95 or Windows 98. Once installed, the print spooler is able to process your print jobs and send them to the printer at consistently faster speeds than if sending print jobs through the Windows system print spooler. This is especially true if printing from a somewhat slower computer. As a result, it is highly recommended that you use the 32-Bit Print Spooler when printing from Windows 95 or Windows 98.

The 32-Bit Print Spooler is located on the included Printer Software CD and installs just like any other standard Windows application program. To install the 32-Bit Print Spooler, refer to the following:

1. Insert the included CD into your computer's CD-ROM drive.
2. Close down all other software applications.
3. Click the **Start** button, point to **Settings**, and select **Control Panel**.

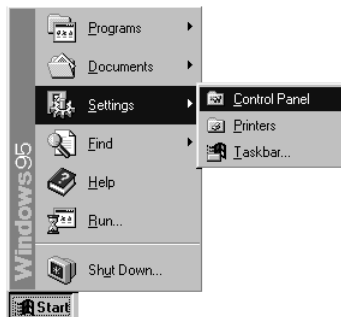

4. Double-click on the **Add/Remove Programs** icon, and select the **Install** button.

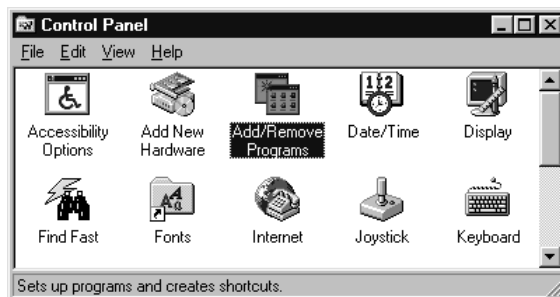

5. Click **Next**, then click on the **Browse** button.
6. Select your CD-ROM drive, open the folder named **Windows and NT Software**, then open the folder named **32 Bit Print Spooler**.
7. Double-click on the **Setup.exe** file, then select the **Finish** button to complete installation. When installed, the 32-Bit Print Spooler icon will appear in the Programs group of the Start menu.



32-Bit Print Spooler

NOTE: Before installing updated 32-Bit Print Spooler versions, always uninstall the existing print spooler version from your system. To do this, simply select 32-Bit Print Spooler from the list of programs in the Add/Remove Programs Properties window and click on the **Add/Remove** button.

To print with the 32-Bit Print Spooler, you must select the **Fast 32-bit Spooler** option from within the printer driver setup window as described in Part D of this section. When this option is selected, the print spooler will automatically open and close with the start and finish of each print job.

NOTE: You can also manually open the 32-Bit Print Spooler simply by selecting its icon from the Programs group of the Start menu.

When the 32-Bit Print Spooler is running, its icon will appear in the Windows 95/98 Task Bar. During a print job, it is sometimes helpful to click on this icon to bring the 32-Bit Print Spooler status window to the foreground of your application. This window provides a number of details about the print jobs being sent to the printer.

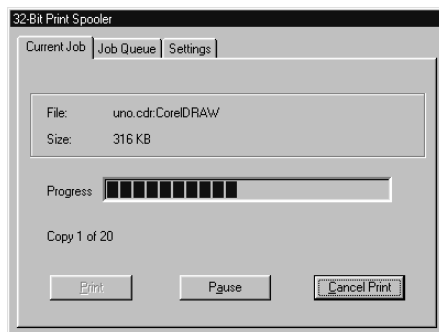

The **Current Job** tab tells you the name and size of the file printing, the progress of the overall print job, as well as the total number of copies left to print. It also provides buttons which allow you to pause or cancel the print job at any time during the printing process.

The **Settings** tab tells you the port and printer to which you are printing and allows you to configure the timeout settings. In most instances, these settings will rarely need to be changed. This tab also provides two other options called **Save last job for reprint** and **Direct to Port Mode**.

When the **Save last job for reprint** option is selected, the 32-Bit Print Spooler will automatically save the last print job you sent to the printer and allow you to instantly reprint the job without the delay of having to reprocess it. The print job will be saved in the spooler until another print job is sent and saved over it. If you do not wish to save the last print job for reprint, deselect this option. To print a saved job, simply select the **Print** button from the spooler's Current Job tab.

The **Direct to Port Mode** option is selected by default. In most instances, this option allows the spooler to send data to the printer at its optimum speed. If, however, you experience problems when printing with this option selected, simply deselect it and try your print job again.

The **Job Queue tab** appears only when a print job is being sent to the printer. This tab tells you the name and status of each job in the queue and shows you the order in which the jobs will print if you have sent multiple jobs to the printer. A control button is also provided which allows you to delete every job listed in the queue. To delete the job currently being printed, simply select the **Cancel Print** button under the Current Job tab.

D. SETTING UP THE PRINTER DRIVER

Once the printer driver has been successfully installed, you will need to set the driver up with the appropriate print options. Refer to the following steps to change or verify your printer driver options:

1. Click the **Start** button, point to **Settings**, and select **Printers**. Then, click on the **CD Color Printer II** icon with the right mouse button and select **Properties** if using Windows 95/98 or **Document Defaults** if using Windows NT.

2. In Windows 95/98, click on the **Details** tab of the Properties window and select the **Setup** button. In Windows NT, click on the **Advanced** tab of the Document Settings window.

NOTE: *Most applications allow you to change these same printer driver options from their "Print" and/or "Printer Setup" screens. This means that you don't have to go back to the main printer setup window each time you want to change a setting or option in the printer driver. These applications will usually give you the same choices and options, but in a slightly altered format.*

3. In Windows 95/98, the CD Color Printer setup screen appears. In Windows NT, the CD Color Printer Document Settings appear. Although each printer driver displays the print options in a slightly different format, the basic options are the same. Refer to the remainder of this section for a description of each printer driver option.

Media

Click on the Media down arrow. A list of media selections appears. Select the **CD** option if printing onto printable CD's. Select **Booklet** if printing onto a jewel case booklet. Select **Insert** if printing onto a jewel case insert. When sizing your images for printing, keep in mind that each type of CD media has the following maximum printable areas:

CD 4.56" round (116mm), Booklet 4.63" x 4.67" (117.7 x 118.5mm), and Insert 4.57" x 5.9" (116 x 150mm). For a complete description of each type of print media and to see how each is installed, refer to Section 2.

Ink Cartridge

Select either **Color** or **Monochrome** according to the type of ink cartridge you have installed.

Print Quality

Select the appropriate print quality option for your image. Keep in mind that **Draft** provides the lowest quality but fastest print, and that **Photo 600 x 300** provides the highest quality but slowest print. You may wish to experiment with these options to see which one is best for your particular CD label.

Dither Mode

Select this option to choose the appropriate dither mode for your image. Select **Optimize for photos** if printing a design primarily composed of photographic images. Select **Optimize for graphics** if mainly printing text, lines, and graphics.

Color Matching

Click on the Color Matching down arrow and choose the color matching option that's right for you. Select **None** if you are more interested in print speed rather than print color, if your image is created in a CMYK color model, if you have already color corrected your image for printing, or if you are using some other third party color matching software.

Select **Algebraic** if you would like the printer driver to make very simple color balance adjustments based on an RGB color model. This option gives you more natural looking images without actually utilizing any specific color matching software.

Select **PrimaColor** to enable color matching profiles written specifically for the CD Color Printer. The PrimaColor by Candela Color Management System automatically adjusts the color of your image according to preconfigured printer profiles and default system profiles. This results in a very precise color match compliant with ICC standards.

Ink Saturation

This option controls the ink saturation of the printed image. When printing onto the printer manufacturer's TuffCoat CD media, this option should be left at its default setting of 100%. When printing onto other brands of printable CD media, you may need to adjust this control in order to optimize the ink saturation for the printable surface of your specific CD media. Click and drag on the slide's box, or click on the left and right arrows to change the ink saturation setting. Moving the slide's box to the left reduces the overall ink saturation, while moving it to the right increases it.

Rotate 180

Select this option to rotate your printed image 180°. Although this option is not relevant when printing onto a CD, it does provide greater flexibility when printing onto a jewel case booklet or insert.

Manual Load

Select this option when you are printing multiple copies of a single design or if using an auto-loader. If you do not select this option when printing multiple copies, the printer has no way of knowing whether or not you have loaded a blank CD and will print each of the selected number of copies onto the same CD. When this option is selected, you must press the  CD Tray button after each new CD blank is loaded. This will close the CD Tray and let the printer know that a fresh CD is installed and ready to be printed.

Write Direct to Port

Select this option to provide faster print processing if printing from Windows 3.1x. When selected, this option allows the printer driver to bypass the Windows 3.1x print manager and to send all print data directly to the printer. This option devotes all of your system resources to the current print job, thereby increasing overall print speed. When the print job is finished, your system resources will again be devoted to the normal function of your on-screen applications.

Depending upon the brand of your computer, you may or may not wish to select this option when printing. For most computers, selecting this option will enhance the rasterizing and printing process. In this case, the **Write Direct to Port** option should be selected. For some computers, however, this option may not be supported by the particular brand of PC and should not be selected.

Fast 32-bit Spooler

Select this option for consistently faster print processing under Windows 95/98. This option is only selectable if operating under Windows 95/98 and if the included 32-Bit Print Spooler software has been installed. When selected, this option allows the printer driver to send all print jobs to the 32-Bit Print Spooler rather than to the Windows system print spooler. See Part C of this section for complete details on the 32-Bit Print Spooler. This option and the 32-Bit Print Spooler software will not function in Windows 3.1x or Windows NT.

Orientation

Select either **Portrait** or **Landscape** according to the orientation of your jewel case booklet/insert design. An icon illustrating each orientation helps you remember the difference between the two. This option does not apply when printing onto a CD.

Cartridge

Select this button to display the type of ink cartridge currently installed, its current ink levels, as well as options for cleaning and changing a cartridge. Note that the ink cartridge type and ink levels can only be reported when operating under Windows 95/98.

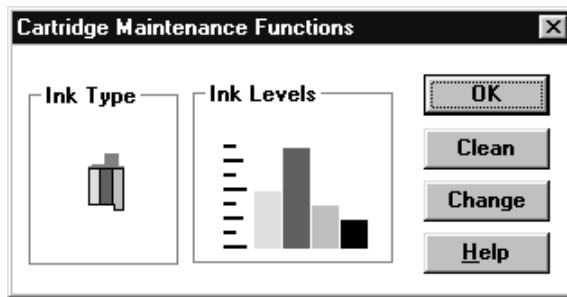

Select the **Clean** button to send a simple test print pattern to the printer. Be sure to have a CD template installed. This test print pattern purges the ink cartridge nozzles and lets you know if any one of the Yellow, Magenta, or Cyan nozzles is clogged. If one of these colors does not appear on the test print, clean the copper end of the cartridge with an alcohol pad, and repeat the cleaning procedure. If after several cleanings a color still does not appear on the test print, the cartridge may be damaged or empty and may need to be replaced.

Select the **Change** button to install a fresh, new ink cartridge or to switch back and forth between a previously used color cartridge and a previously used monochrome cartridge. After the cartridge has been replaced according to the instructions in Section 2-E, select either the **New Cartridge Installed** button or the **Old Cartridge Installed** button accordingly. These selections are necessary for the printer to accurately keep track of ink cartridge ink levels.

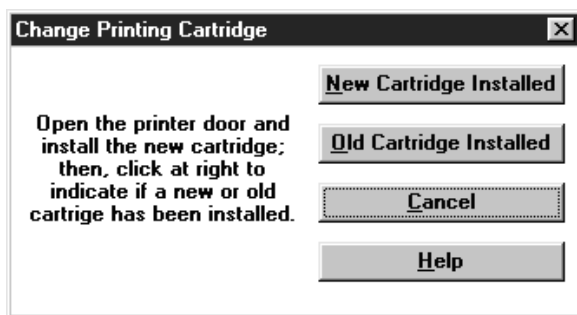

Calibrate

Select this button to display options for fine-tuning the position of your printed image and the size of a CD's non-printable center. This button also allows you to calibrate the offset for bi-directional printing in the Draft Print Quality Mode. The following gives a complete description of each of the Calibration options.

IMPORTANT! *The Image Placement values labeled on your printer's rear panel must be entered into the Vertical and Horizontal boxes prior to printing. These values have been optimized specifically for your printer and allow images to be centered on a CD when printed.*

When facing the printer, the **Vertical** adjustment moves the printed image toward the printer if a positive number is entered and away from the printer if a negative number is entered. The **Horizontal** adjustment moves the printed image toward the left-hand side if a positive number is entered and toward the right-hand side if a negative number is entered. The **Center Size** adjustment enlarges the non-printable center if a positive number is entered and reduces its size if a negative number is entered. As a rule, an adjustment of 12 pixels is equivalent to approximately 1 millimeter. Once you have entered the optimum calibration values, you will most likely not need to change them again. The following diagram illustrates exactly how each of these adjustments affect the printed image.

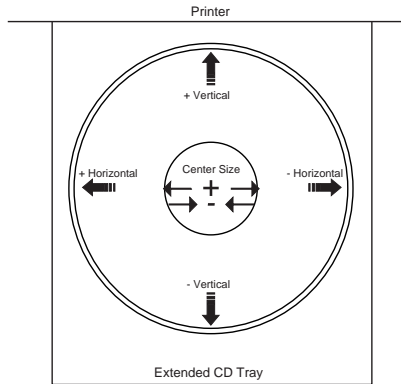

HINT: Notice the direction the Vertical and Horizontal adjustment arrows point within the Calibration window are representative of the direction the printed image moves on the CD.

If you ever wish to verify your factory-recommended Vertical and Horizontal calibration settings, you can run a simple calibration procedure to assure that your images will be centered when printed on a CD. To do this, refer to the following steps:

1. Verify that a cardboard CD template and a color ink cartridge are installed in the printer. Also, verify that the printer is powered ON and that it is connected to your computer.
2. Click on the **Test Print** button of the Image Placement box within the Calibration window. The printer will begin printing the calibration test print.
3. When the print is complete, rotate the CD template 180° in the CD Tray and repeat step 2 using the same CD template.



- When the second run of the print is complete, you should have a test print that looks like the following:

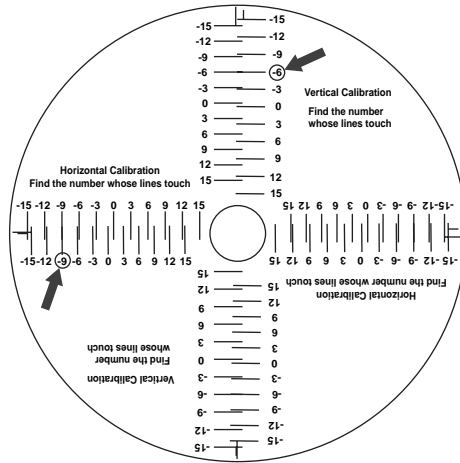

- Along the Vertical axis of the printed CD template, find the number whose lines touch. For example, in the above illustration, the number would be -6. Enter that number into the Vertical box of the Calibration window. Repeat this same step for the Horizontal axis.
- Select the **OK** button. The numbers you entered will stay the same until you change them. Your images should now be centered when printed on a CD.

The Calibration window also displays an **Offset Calibration** option which is selectable only when printing with the **Draft** Print Quality option selected. When printing in Draft quality, the printer will print on both the left and right cartridge movements. Although this is a very fast way to print, it can sometimes make your CD image appear uneven around the edges. To remedy this, the following procedure can be done to optimize Draft quality printing.

- Verify that a cardboard CD template and an ink cartridge are installed in the printer. Also, verify that the printer is powered ON and that it is connected to your computer.
- From the printer driver setup window, select the Ink Cartridge type you have installed (**Color** or **Monochrome**).
- Select the **Calibrate** button, and click on the Offset Calibration's **Test Print** button. The printer will begin printing a calibration test print.

4. After printing is completed, find the line that is the straightest, and enter the number next to this line in the **Offset** box.
5. Select the **OK** button. The number you entered will stay the same until you change it. Printing should now be optimized for Draft quality. Note that it is recommended you repeat this procedure every time a new or different ink cartridge is inserted whenever you are printing in Draft quality.

After your selections have been made, close out of the printer setup window. You are now ready to go to an application program and print. All printer driver selections will stay the same until you change them.

E. PRINTING A CD

Now that you have hooked up the printer, loaded the print supplies, and installed the printer driver, you are ready to print your first CD label. Follow these steps to print your first image:

1. Go to your favorite graphics application program. Or, install and open the Windows CD creation software included with your printer.
2. Open or create the image file you wish to print. If using a program other than the included Windows CD creation software, you will need to create a custom page or canvas size in your program according to the type of label you intend to create. The following tips will help you do this:
 - If creating a label for a **CD**, set your page size to 4.56" x 4.56" (116 x 116mm). Although your image will appear square on screen, the printer driver will automatically crop your image to the round shape of a CD for printing. The driver will also automatically crop out the center 1.6" (41mm) of your image to accommodate a CD's non-printable center hub. If you would like to better visualize where the round outside edge and the round non-printable center of a CD will fall in relation to your image, simply draw one circle with a 4.56" (116mm) diameter and another with a 1.6" (41mm) diameter. Then, center both circles within your active page or canvas area. These circles will serve as a guide while designing your image. Be sure to delete these circles before printing.

- If creating a label for a jewel case **Booklet**, set your page size to 4.63" x 4.67" (117.7 x 118.5mm).
 - If creating a label for a jewel case **Insert**, set your page size to 4.57" x 5.9" (116 x 150mm).
3. Once you have created your image and are ready to print, select **Print Setup** (or the equivalent) from the program's File menu to verify that the printer driver settings are correct for your image. Be sure the proper Media and Ink Cartridge options are selected according to the supplies you have installed in the printer. Once the driver is set, select **Print** from the program's File menu.
 4. The printer driver will then begin to process the image. Depending upon the size of the image and the processing speed of your computer, processing time can take from several seconds to a few minutes.
 5. Once processing is complete, the printer will begin to print. Print time will vary depending on whether you are printing with a color or monochrome cartridge and on which Print Quality setting you selected. When printing is complete, the CD Tray will automatically open and remain fully extended until the next print job is received.

Section 4: Using the CD Color Printer with Macintosh

A. CONNECTING THE PRINTER TO YOUR COMPUTER

The CD Color Printer is designed to be used with any Apple Macintosh supporting Color QuickDraw™ and running system software 7.0 or higher. For best performance, a Macintosh with a 68040 processor and 8MB of RAM (or higher) or a PowerPC™ with 8MB of RAM (or higher) is recommended. The printer driver is accelerated for use with a PowerPC.

The printer is equipped with a high-speed serial port. This port is the means through which the printer receives data from your computer. This port is not AppleTalk™ compatible. To connect the printer to your computer, simply obtain a standard serial cable with an 8 pin mini-DIN connection on each end, and refer to the following steps:

1. Connect one end of the serial cable to the printer.

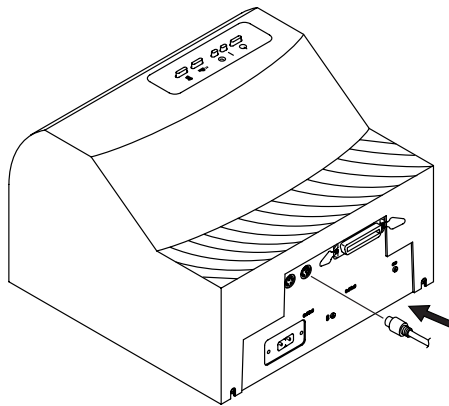

2. Connect the other end of the cable to either the Printer or Modem port of your Macintosh.

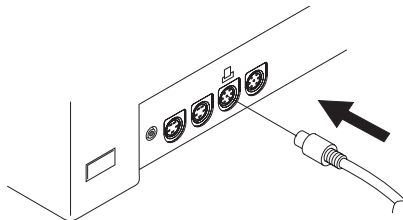

The printer must have its Power light illuminated to receive data. If the light is not on, press the  Power button.

B. INSTALLING THE PRINTER DRIVER

The CD Color Printer can be used with virtually any Macintosh application program. This is accomplished by installing what is called a “printer driver.” The printer driver is simply software which gives the printer all the information needed for printing. Use the following steps to install the printer driver.

NOTE: *This section of the Operator’s Manual assumes that you are already familiar with a Macintosh Operating System (OS) and know how it operates. If you are not yet familiar with a Macintosh OS, consult the appropriate documentation to become familiar with the basics before proceeding.*

1. After starting your Macintosh, insert the supplied Printer Software CD into your computer’s CD-ROM drive, and open the Macintosh Software folder
2. Click on the READ ME file(s) to get the latest information on the driver and the installation process. When you are finished reading, select **Quit** from the File menu.
3. Double-click on the CD Color Printer II Installer icon.

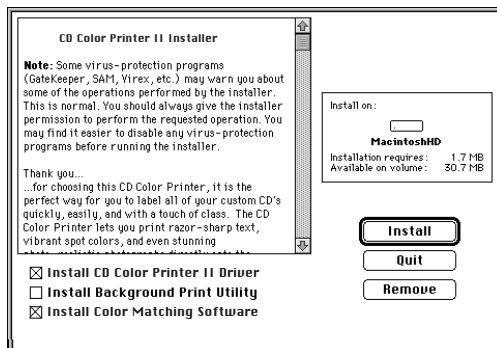

4. When the Installer window appears, select the options you would like the installer program to install. In most instances, the default selections will suffice. For a description of each of these options, refer to the notes found in the box directly above these options (use the up and down arrows to scroll through the notes). Once the desired options are selected, click on **Install**. The

appropriate files will automatically install onto your computer. An alert box will then display indicating that installation is complete.

5. Click on **OK** to exit the installer. Driver installation is now complete.

C. THE CHOOSER

The Chooser is a Desk Accessory in the Apple menu. Before you can use the printer, you need to select the CD Color Printer II driver using the Chooser. This instructs your Macintosh to send print jobs to the CD Color Printer II instead of to some other printer you may already have connected to your system. Refer to the following steps to select the CD Color Printer II driver:

1. Select **Chooser** from the Apple menu.
2. The Chooser displays an icon for all the printer drivers installed in the System Folder. Among these, you should see the icon for the CD Color Printer II driver you just installed. If you do not see the icon, go through the installation procedure again making sure the **Install driver and prefs** option is selected. Once you locate the CD Color Printer II icon, click on the icon to select it.

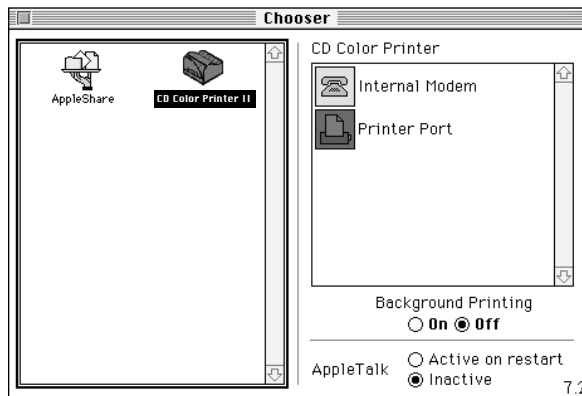

3. Select either the **Modem** or **Printer Port** to indicate to which port the serial interface cable was connected. If the Printer port is selected, AppleTalk should remain inactive while printing unless you are using AppleTalk through your Ethernet port. AppleTalk does not apply when printing with the Modem port selected.

4. Select either **On** or **Off** to enable or disable the printer's Background Printing function. When enabled, this function allows you to work in the foreground of your application program while printing in the background. Please refer to Section 5 for more information on background printing.

The next time you open the Chooser, the selected driver will no longer be highlighted. The Chooser remembers, however, which driver is the current one but does not display it when opened.

D. SETTING UP THE PRINTER DRIVER

Once the printer driver has been successfully installed, you will need to set the driver up with the appropriate print options. To change or verify your printer driver options, select **Page Setup** from the File menu and change the options as follows:

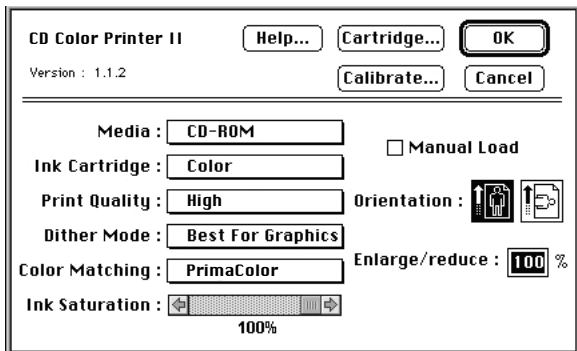

Media

Click on the Media down arrow. A list of media selections appears. Select the **CD** option if printing onto printable CD's. Select **Booklet** if printing onto a jewel case booklet. Select **Insert** if printing onto a jewel case insert. When sizing your images for printing, keep in mind that each type of CD media has the following maximum printable areas:

CD 4.56" round (116mm), Booklet 4.63" x 4.67" (117.7 x 128.5mm), and Insert 4.57" x 5.9" (116 x 150mm). For a complete description of each type of print media and to see how each is installed, refer to Section 2.

Ink Cartridge

Select either **Color** or **Monochrome** according to the type of ink cartridge you have installed.

Print Quality

Select the appropriate print quality option for your image. Keep in mind that **Draft** provides the lowest quality but fastest print, and that **Photo** provides the highest quality but slowest print. You may wish to experiment with these options to see which one is best for your particular CD label.

Dither Mode

Select this option to choose the appropriate dither mode for your image. Select **Best For Photos** if printing a design primarily composed of photographic images. Select **Best For Graphics** if mainly printing text, lines, and graphics.

Color Matching

Click on the Color Matching box and choose the color matching option that's right for you. Select **None** if you are more interested in print speed rather than print color, if you have already color corrected your image for printing, or if you are using some other third party color matching software.

Select **Algebraic** if you would like the printer driver to make very simple color balance adjustments. This option gives you more natural looking images without actually utilizing any specific color matching software.

Select **PrimaColor** to enable color matching profiles written specifically for the CD Color Printer. The PrimaColor by Candela Color Management System automatically adjusts the color of your image according to preconfigured printer profiles and default system profiles. This results in a very precise color match compliant with ICC standards.

Select **ColorSync** to perform a ColorSync™ match on the image to be printed. This option enables ColorSync to color correct your image according to preset printer profiles and the selected system profile. A default system profile is installed into the ColorSync Preferences folder. For best results, however, it is recommended that you use the specific profile for your monitor. To select this profile, select **Control Panels** from the Apple menu, and double-click on **ColorSync System Profile**. Then, click on the **Set Profile...** button, and select the specific profile for your monitor. If you cannot find your monitor's profile, select the default system profile called **Default CD Monitor**. Click on the **Select** button. The profile is now selected.

Ink Saturation

This option controls the ink saturation of the printed image. When printing onto the printer manufacturer's TuffCoat CD media, this option should be left at its default setting of 100%. When printing onto other brands of printable CD media, you may need to adjust this control in order to optimize the ink saturation for the printable surface of your specific CD media. Click and drag on the slide's box, or click on the left and right arrows to change the ink saturation setting. Moving the slide's box to the left reduces the overall ink saturation, while moving it to the right increases it.

Manual Load

Select this option when you are printing multiple copies of a single design or if using an auto-loader. If you do not select this option when printing multiple copies, the printer has no way of knowing whether or not you have loaded a blank CD and will print each of the selected number of copies onto the same CD. When this option is selected, you must press the  CD Tray button after each new CD blank is loaded. This will close the CD Tray and let the printer know that a fresh CD is installed and ready to be printed.

Orientation

Select either **Portrait** or **Landscape** according to the orientation of your jewel case booklet/insert design. An icon illustrating each orientation helps you remember the difference between the two. This option does not apply when printing onto a CD.

Enlarge/reduce

This option alters the size of the printed image between the integers of 25% and 400%. A setting of 100% indicates the document will be printed at actual size. Please note that significantly enlarging or reducing the image may cause the image to appear pixelated or "jaggy" when printed.

Cartridge

Select this button to display options for changing or cleaning an ink cartridge.

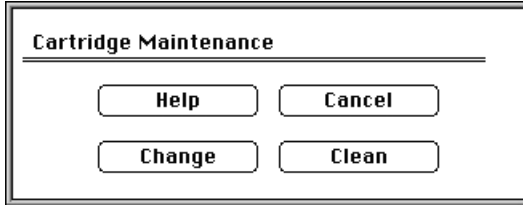

Select the **Change** button to move the printer's ink cartridge carrier to the load position in order to change ink cartridges. Note that pressing the printer's **Ink Cartridge** button serves this same purpose. See Section 2 for further information on changing ink cartridges.

Select the **Clean** button to send a simple test print pattern to the printer. Be sure to have a CD template installed. This test print pattern purges the ink cartridge nozzles and lets you know if any one of the Yellow, Magenta, or Cyan nozzles is clogged. If one of these colors does not appear on the test print, clean the copper end of the cartridge with an alcohol pad, and repeat the cleaning procedure. If after several cleanings a color still does not appear on the test print, the cartridge may be damaged or empty and may need to be replaced.

Calibrate

Select this button to display options for fine-tuning the position of your printed image and the size of a CD's non-printable center.

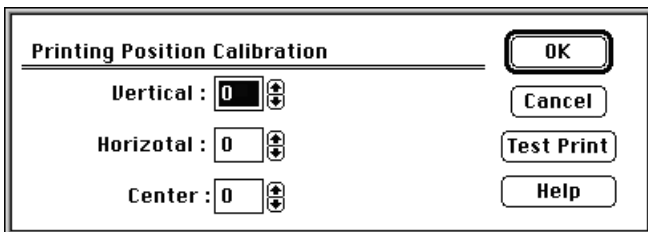

IMPORTANT! *The Image Placement values labeled on your printer's rear panel must be entered into the Vertical and Horizontal boxes prior to printing. These values have been optimized specifically for your printer and allow images to be centered on a CD when printed.*

When facing the printer, the **Vertical** adjustment moves the printed image toward the printer if a positive number is entered and away from the printer if a negative number is entered. The **Horizontal** adjustment moves the printed image toward the left-hand side if a positive number is entered and toward the right-hand side if a negative number is entered. The **Center Size** adjustment enlarges the non-printable center if a positive number is entered and reduces its size if a negative number is entered. As a rule, an adjustment of 12 pixels is equivalent to approximately 1 millimeter. Once you have entered the optimum calibration values, you will most likely not need to change them again. The following diagram illustrates exactly how each of these adjustments affect the printed image.

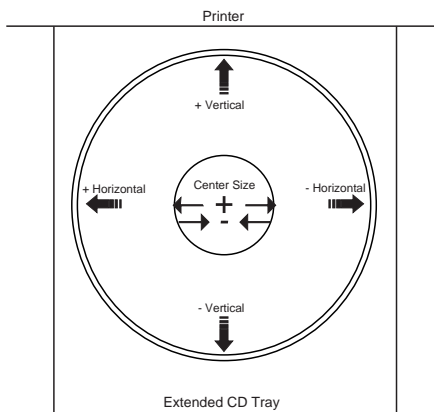

If you ever wish to verify your factory-recommended Vertical and Horizontal calibration settings, you can run a simple calibration procedure to assure that your images will be centered when printed on a CD. To do this, refer to the following steps:

1. Verify that a cardboard CD template and a color ink cartridge are installed in the printer. Also, verify that the printer is powered ON and that it is connected to your computer.
2. Click on the **Test Print** button of the Printing Position Calibration window. The printer will begin printing the calibration test print.
3. When the print is complete, rotate the cardboard CD template 180° in the CD Tray and repeat step 2 using the same CD template.

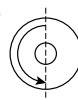

- When the second run of the print is complete, you should have a test print that looks like the following:

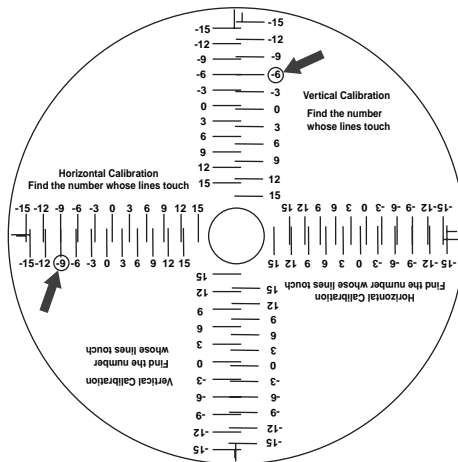

- Along the Vertical axis of the printed CD template, find the number whose lines touch. For example, in the above illustration, the number would be -6. Enter that number into the Vertical box of the Calibration window. Repeat this same step for the Horizontal axis.
- Select the **OK** button. The numbers you entered will stay the same until you change them. Your images should now be centered when printed on a CD.

After your selections have been made, select the **OK** button to save your printer driver selections and to exit the Page Setup window. You are now ready to go to an application program and print. All printer driver selections will stay the same until you change them.

E. PRINTING A CD

Now that you have hooked up the printer, loaded the print supplies, and installed the printer driver, you are ready to print your first CD label. Follow these steps to print your first image:

- Go to your favorite graphics application program.
- Open or create the image file you wish to print. You will need to create a custom page or canvas size in your program according to the type of label you intend to create. The following tips will help you do this:

- If creating a label for a **CD**, set your page size to 4.56" x 4.56" (116 x 116mm). Although your image will appear square on screen, the printer driver will automatically crop your image to the round shape of a CD for printing. The driver will also automatically crop out the center 1.6" (41mm) of your image to accommodate a CD's non-printable center hub. If you would like to better visualize where the round outside edge and the round non-printable center of a CD will fall in relation to your image, simply draw one circle with a 4.56" (116mm) diameter and another with a 1.6" (41mm) diameter. Then, center both circles within your active page or canvas area. These circles will serve as a guide while designing your image. Be sure to delete these circles before printing.
 - If creating a label for a jewel case **Booklet**, set your page size to 4.63" x 4.67" (117.7 x 118.5mm).
 - If creating a label for a jewel case **Insert**, set your page size to 4.57" x 5.9" (116 x 150mm).
3. Once you have created your image and are ready to print, select **Page Setup** (or the equivalent) from the program's File menu to verify that the printer driver settings are correct for your image. Be sure the proper Media and Ink Cartridge options are selected according to the supplies you have installed in the printer. Once the driver is set, select **Print** from the program's File menu.
 4. The printer driver will then begin to process the image. Depending upon the size of the image and the processing speed of your computer, processing time can take from several seconds to a few minutes.
 5. Once processing is complete, the printer will begin to print. Print time will vary depending on whether you are printing with a color or monochrome cartridge and on which Print Quality setting you selected. When printing is complete, the CD Tray will automatically open and remain fully extended until the next print job is received.

Section 5: Using the Print Backgrounder for Macintosh

The printer driver for Macintosh provides a background print utility called the Print Backgrounder. This print utility is turned on or off through the Chooser. When the Backgrounder is turned on, it allows you to conveniently continue working in the foreground of your application while printing in the background. When Backgrounder is turned off, all print jobs are processed immediately in the foreground of your application. The Backgrounder offers many helpful features which are described further in this section.

A. INSTALLING THE BACKGROUNDER

The Backgrounder is installed by selecting the **Install Background Print Utility** option from within the printer driver's installer program. This option is NOT selected by default, so if you did not select the Backgrounder option when installing the printer driver, it is most likely not installed. To install the Backgrounder, simply go through the printer driver installation procedure described in Section 4-B making sure that the **Install Background Print Utility** option is selected. The Backgrounder installs into the Extensions folder of your startup drive. Once installed, Backgrounder will automatically open and close with the start and finish of each print job. To manually open Backgrounder, double-click on the Print Backgrounder icon within the Extensions folder.

B. PRINTING WITH THE BACKGROUNDER

With the Backgrounder turned on in the Chooser, select **Print** from the File menu to print your image. A message appears telling you the image is being spooled to disk for Background/ Later processing. Once the message disappears, background processing has begun so your application is free to be used for other work.

The print job is processed automatically by the Backgrounder. Other documents can be printed and, in turn, will be processed by Backgrounder. While Backgrounder is running, you can quit the current application and start another without disturbing

your print jobs. Backgrounder processes all print jobs in the order in which they were sent to the printer.

C. THE BACKGROUNDER STATUS WINDOW

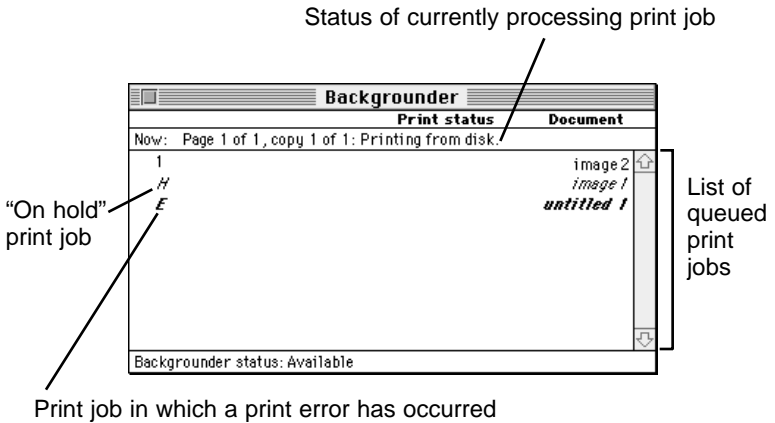

The Backgrounder status window gives you detailed information about the status of the print job currently processing and about each print job waiting in the queue. The status of the job currently processing displays at the top of the status window. The message indicates how much of the job has been processed and displays any other relevant information. This line is blank if, for example, you manually start Backgrounder and no job is currently being processed.

The list of queued jobs displays below the current job in the order in which they were sent to the printer. Some applications, however, may put each page of the document into a separate spool file, creating a different job in the queue for each page. Print jobs are always added to the bottom of the queue. When the job currently processing is complete, the spool file for that job is deleted from the hard disk, and the top-most job in the queue is then processed.

Jobs that are "on hold" are displayed at the bottom of the job list in italic font. A job goes on hold when it has been canceled or when an error is detected during processing. An overall status message about the Backgrounder displays in the lower left corner of the window. The normal message is "Available," indicating that the Backgrounder can process jobs immediately or add them to the queue.

D. BACKGROUNDER MENUS

File menu

Open Status Window and **Close Status Window:** Opens and closes the Backgrounder status window. The Backgrounder continues to work if the status window is closed.

Log Files: The Backgrounder has the ability to create and maintain a sequential history file, or **Log** file, of Backgrounder print jobs. This Log file can be enabled and manipulated with the following commands of the File menu:

New Log File: Selects a new file in which to maintain your ongoing Backgrounder printing log.

Save Copy of Log as: Saves the current Log file to a new file name or location of your specification.

Start Recording Log: Begins logging print history. Before the Log file is started, you are asked to specify a Log file in which to save your processed print job entries. When logging begins, this option dims.

Stop Recording Log: Stops logging print history. This option dims once print logging stops.

Get Info: Provides additional information about the currently selected print job. Click on the processing job or any job in the queue, before selecting Get Info. Double-clicking on a job in the status window is a shortcut for Get Info.

Quit: Exits the Backgrounder. Note that you cannot quit while a job is being processed (see **Stop Processing** on the following page). All jobs in the queue are retained and processed when Backgrounder is next started.

NOTE: *The spool files are stored in the "Spool Folder," inside the "System Folder." If these files are deleted, the corresponding print jobs will be lost, and must be printed again.*

Admin menu

Stop Processing: Stops the Backgrounder from processing any jobs, although it will still receive them and add them to the queue. A dialog box is displayed if Stop Processing is selected while Backgrounder is processing a job, asking when the job should be put on hold. The Backgrounder status box in the

lower left-hand corner of the window indicates that Backgrounder has stopped.

You cannot quit from Backgrounder while it is processing a job. **Stop Processing** must first be selected to cancel the processing job and stop Backgrounder. When Backgrounder stops, the menu changes to **Continue Processing**. When this option is selected, the server starts processing the top job in the queue.

Preferences: Presents a dialog box containing options for fine-tuning the Backgrounder. **Background printing priority** determines how much time your Mac spends processing the image, and how much time it spends in the foreground application (interpreting mouse clicks, key presses, etc.). When the priority is set to **High**, Backgrounder processes the image faster, but the foreground application may become less responsive. With the priority set to **Low**, Backgrounder takes longer to process the image, yet the responsiveness of the other applications is improved.

Jobs menu

All commands in the Jobs menu act on the currently selected job.

Hold: Prevents an individual job from being processed. Jobs that are “on hold” are displayed in italic font at the bottom of the queue. Placing a job on hold is useful if you wish to create a print job at present, yet save its processing until later.

If **Hold** is selected on the job currently processing, the job is canceled before it is placed on hold. Canceling the current job can take some time, since the printer software may be performing a lengthy task that cannot be interrupted.

Remove Hold: Moves the job from the hold section of the list and places it at the bottom of the waiting queue.

Delete: Permanently removes the selected print job. The corresponding spool file is deleted from the Spool Folder. Use this command only when you are sure that you do not wish to process the job. Note that the job currently processing cannot be deleted (this happens automatically when it is printed successfully).

Move Job Up and **Move Job Down:** Adjusts the position of the selected job in the queue, allowing you to prioritize jobs. The queue is processed in top-to-bottom order.

E. PROBLEMS DURING A BACKGROUND PRINT

Errors that are detected during a background print must be reported. The Backgrounder, however, cannot simply present a dialog box as soon as the error occurs, since the dialog could obscure work that is being done in the foreground. Error dialogs appear immediately, however, if the Backgrounder is in the foreground when the error is detected.

If operating in the background, Backgrounder stops processing until it is brought to the front. When Backgrounder detects an error, it beeps and visually indicates an error condition. This error condition is signaled by alternately flashing between the Application menu and the Backgrounder icon. A small diamond symbol is also displayed next to the Backgrounder icon within the Application menu.

Complete and save any work in the foreground application before bringing the Backgrounder to the front. Once Backgrounder is in the foreground, the error dialog displays and processing continues or is canceled. Some errors force Backgrounder to stop processing all jobs.

Section 6: Interpreting the Printer's Indicator Lights

The **Power** and **Busy** LED indicator lights located on the top of the printer can tell you a lot about what is happening inside the printer. To accurately interpret what it means when these lights are on, off, or flashing, please refer to the following:

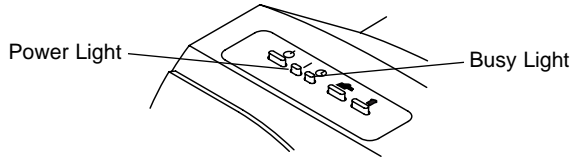

Power Light	Busy Light	Printer
on solid	off	Is ready to receive a print job.
on solid	on solid	Is processing and printing an image.
on solid	blinking slowly	Has received a print job and is waiting for you to load CD media or has a print media jam. If media loading is required, simply load media into the CD Tray according to Section 2-C and press the  CD Tray button to resume printing. If print media is jammed, clear the media from the printer and turn the printer OFF and ON to reset for the next print job.
blinking	on solid	Is not receiving print data properly. Turn the printer OFF and ON to reset and cancel print job from your computer. Before sending next print job, make sure you are using a shielded interface cable and that it is properly connected.
both lights are flashing alternately with each other		Has either the wrong ink cartridge or no ink cartridge installed. See Section 2-B or 2-E for more information on changing or replacing ink cartridges.

Section 7: Maintaining the Printer

The CD Color Printer is designed to require very little maintenance. Nevertheless, there are a few procedures you can perform on a regular basis or as needed to ensure your printer's best performance.

A. CLEANING THE INK CARTRIDGE NOZZLES

It may be necessary to clean the ink cartridge nozzles if the printer does not seem to be laying down ink evenly or if you suspect an ink cartridge nozzle has become slightly dried out or clogged. Refer to the cleaning procedure explained within the **Cartridge** button description of Section 3-D or 4-D to clean the cartridge nozzles.

B. CLEANING THE CD TRAY AND PRINTER CASING

If ink gets on the printer's CD Tray, it may stain if left on the tray too long. To avoid this, simply wipe off any ink from the CD Tray as soon as you notice it. Use a lint-free cloth *slightly* moistened with isopropyl alcohol to wipe off the CD Tray. If necessary, use these same items to wipe off the outside casing of the printer. **Always disconnect your printer's power cord before cleaning.** Do not allow alcohol to drip inside the printer. Resume printer operation only after the printer is completely dry.

C. CLEARING A CD MEDIA JAM

If CD Media becomes jammed inside the printer, first press the  CD Tray button to try and eject the media. If this does not work, turn the printer power OFF and gently try to clear or remove the CD media manually.

D. TECHNICAL SUPPORT

If you have difficulty operating your CD Color Printer, the procedures in this manual should, in most cases, solve the problem. If you still have difficulty, contact the technical support number listed on the insert in this manual. Technical support representatives are available Monday through Friday, 7:30 AM to 5:30 PM Central Standard Time.

Section 8: Technical Specifications

Print Method:	Thermal Ink-Jet
Print Resolution:	Normal: 300 x 300 dpi Highest Quality: 600 x 300 dpi
Print Speed:	Depends upon coverage and print quality mode; from one to four minutes per full-color CD with 100% coverage, less than 30 seconds for monochrome black (15% coverage)
Colors:	16.7 million colors or black monochrome
Printer Driver:	Windows 3.1x/Windows NT/Windows 95/98 or Macintosh Color QuickDraw
Interface:	Standard 8-Bit Centronics-type Parallel (IBM- PC) and High-Speed Serial (Macintosh), Auxiliary Port (Transporter)
Ink Cartridges:	3-Color (C, M, Y) Black Monochrome (K)
Media:	Printable-surface CD-R's, cardboard CD templates, jewel case booklets and inserts
System Requirements:	
Recommended:	486/66 MHz or Pentium™, 8MB RAM, 100MB free hard drive space or Macintosh 68040 processor or PowerPC, 8MB RAM, 100MB free hard drive space
Dimensions:	10.5"W x 7.5"H x 10.5"D (266mmW x 190mmH x 266mmD)
Weight:	8.5lbs (3.9 kg)
Temperature:	
Operating:	10°C to 43°C
Storage:	-20°C to 60°C
Humidity:	
Operating:	20% to 80% (RH non-condensation)
Storage:	5% to 80% (RH non-condensation)
Supply Voltage:	100-120 VAC 0.45A 50Hz/60Hz 220-240 VAC 0.25A 50Hz/60Hz
Safety:	USA — UL1950 Canada — C22.2 No. 950-93 Europe — EN60950
Safety Approvals:	UL, UL-C, CE
EMC:	USA — FCC Class B Canada — CRC c1374, Class B Europe — IEC 801-2,-3,-4, CISPR 22-B, CE
EMC Approvals:	CE
Warranty:	One year parts and labor

Appendix A: Interfacing Information

A. INTRODUCTION

The CD Color Printer is equipped with both a standard 8-bit centronics-type parallel interface port and a high-speed serial interface port. These communication ports are the means through which the printer receives data from your computer. This section describes the pin assignments and signal specifications for each of these ports as well as for the printer's auxiliary interface port.

B. CENTRONICS-TYPE PARALLEL INTERFACE

The Centronics-type parallel interface is the most widely used printer interface due to its simplicity, speed, and standardization throughout the computer industry. The printer's parallel interface connector is a standard 36-pin Amp type with two metal-wire retaining clips. It mates with a standard computer to printer parallel cable. For best results, always use a shielded, bi-directional parallel cable which is less than 6 feet in length.

Pin assignments are as follows:

		WIRE DIAGRAM	
		DB36P	DB25P
	1	1	
	2	2	
	3	3	
	4	4	
	5	5	
	6	6	
	7	7	
	8	8	
	9	9	
	10	10	
	11	11	
	12	12	
	13	13	
	14	14	
	32	15	
	31	16	
	36	17	
THROUGH 3019 SHELL		THROUGH 25 SHELL	

TABLE A-1: Parallel Interface Pin Assignments

C. MINI 8-PIN SERIAL INTERFACE

The mini 8-pin serial interface connector is the standard interface used by Macintosh. The printer's serial port mates with a standard computer to printer serial cable. For best results, always use a high-quality serial cable which is less than 6 feet in length.

Pin assignments are as follows:

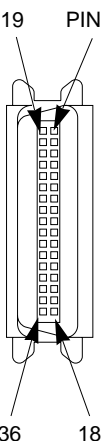
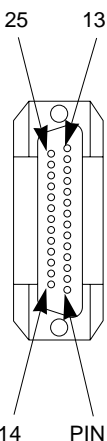
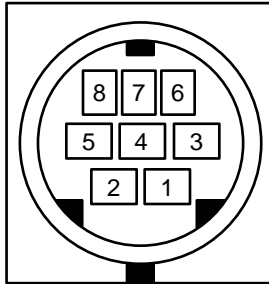

Pin Number	Signal Name	Signal Description
1	HSKo	External Clock Output $\pm 2V < V_{out} < \pm 3.6V$; $R_{out} < 450\Omega$
2	HSKi	Not Connected
3	TxD-	Not Connected
4	GND	Signal ground. Connected to logic and chassis ground.
5	RxD-	Receive data (inverted); $V_{ih} = 0.2V$; $V_{il} = -0.2V$; $R_{in} > 12K\Omega$
6	TxD+	Not Connected
7	GPi	Not Connected
8	RxD+	Receive data. Received uninverted at SCC's RxD. $V_{ih} = 0.2V$; $V_{il} = -0.2V$; $R_{in} > 12K\Omega$

TABLE A-2: Serial Interface Pin Assignments

D. 6-PIN MINICIRCULAR AUXILIARY INTERFACE

The 6-pin minicircular auxiliary interface is used for connecting the printer with auxiliary equipment such as a CD transporter / auto-loader.

Pin assignments are as follows:

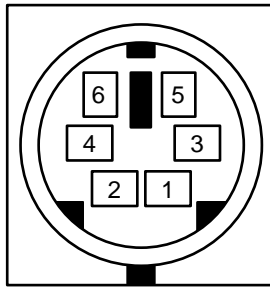

Uses 5v logic @ 5mA

Pin Number	Signal Description
1	Busy - Output is high when the printer is busy or moving the CD Tray.
2	Tray Out - Output is high when the CD Tray is fully ejected.
3	Tray In - Output is high when the CD Tray is fully inserted.
4	CD In - Output is high when the CD Tray is in and a CD is present.
5	Ground.
6	Tray In/Out - A low input moves the CD Tray in if it is out, and out if it is in.

TABLE A-3: Auxiliary Interface Pin Assignments

Index

Algebraic	19, 31
Auxiliary Port.....	3, 48
Backgrounder	37
Booklet.....	7
Busy Light.....	2, 42
Calibrate	22, 33
Cartridge.....	21, 33
CD's.....	4, 6
CD Tray.....	2
CD Tray Button	2
Chooser.....	29
Color Matching.....	19, 31
Dither Mode	19, 31
Ink Cartridges	4, 18, 30
Ink Cartridge Button.....	2
Ink Saturation	19, 32
Insert	7
Interface Port.....	3, 46, 47
Jewel Case Booklet.....	7
Jewel Case Insert	7
Manual Load	20, 32
Media	18, 30
Orientation.....	21, 32
Parallel Port	3, 12, 46
Print Quality.....	18, 31
Printable CD's.....	4
Printer Driver	13, 28
Power Button.....	2
Power Light	2, 42
Rotate 180.....	19
Self Test	8
Serial Port	3, 27, 47
Technical Support.....	44
32-Bit Print Spooler.....	15, 20
Write Direct to Port	20

Printed in the United States of America
P/N 510198

Free Manuals Download Website

<http://myh66.com>

<http://usermanuals.us>

<http://www.somanuals.com>

<http://www.4manuals.cc>

<http://www.manual-lib.com>

<http://www.404manual.com>

<http://www.luxmanual.com>

<http://aubethermostatmanual.com>

Golf course search by state

<http://golfingnear.com>

Email search by domain

<http://emailbydomain.com>

Auto manuals search

<http://auto.somanuals.com>

TV manuals search

<http://tv.somanuals.com>