

# PRO-COM

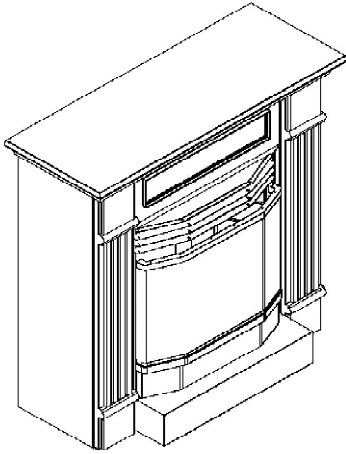

SFE23RE SHOWN

SFE23RE-W

SFE23RE-C

SFE23RE-O

SFE23RE-DO

SFE33RE-W

SFE33RE-C

SFE33RE-O

SFE33RE-DO

Freestanding  
Electric Fireplace

## Installation Instructions and Owner's Manual

**WARNING! IF THE INFORMATION IN THIS MANUAL IS NOT FOLLOWED EXACTLY, A FIRE MAY RESULT CAUSING PROPERTY, PERSONAL INJURY OR LOSS OF LIFE.**



### FOR YOUR SAFETY

**DO NOT STORE  
OR USE GASOLINE OR OTHER  
FLAMMABLE VAPORS OR LIQUIDS  
IN THE VICINITY OF THIS OR ANY  
OTHER APPLIANCE**

**ANSI/UL1278. MOVABLE AND WALL-OR CEILING HUNG ELECTRIC ROOM HEATERS**

**INSTALLER: DO NOT DISCARD THIS MANUAL-LEAVE FOR HOME OWNER**

PC-FE23A610-0506

# TABLE OF CONTENTS

**PLEASE READ THE INSTALLATION & OPERATION INSTRUCTIONS  
BEFORE USING THIS APPLIANCE**

WE ARE PLEASED THAT YOU HAVE CHOSEN TO PURCHASE AN ELECTRIC FIREPLACE MANUFACTURED BY NANJING PRO-COM ELECTRIC APPLIANCE CO., LTD

IMPORTANT: Read all instructions and warnings carefully before starting installation. Failure to follow these instructions may result in a possible electric shock, fire hazard and will void the warranty.

<b>Important Instructions .....</b>	<b>2</b>
Locating Your Electric Fireplace.....	3
Clearance To Combustibles.....	3
Electrical Connections.....	3
Electrical Specifications.....	3
<b>Service Instructions.....</b>	<b>3</b>
Replacing Light Bulbs.....	3
Maintenance of Motors.....	4
Glass Information.....	4
Electrical Wiring Diagram.....	4
<b>Operating Instructions.....</b>	<b>5</b>
<b>Specification.....</b>	<b>7</b>
<b>Replacement Parts.....</b>	<b>7</b>
Replacement Parts List.....	8
<b>Installing decorating logs.....</b>	<b>9</b>

# IMPORTANT INSTRUCTIONS

When using electrical appliances, basic precautions should always be followed to reduce the risk of fire, electric shock, and injury to persons, including the following:

1. Read all instructions before using this heater.
2. This appliance is hot when in use. To avoid burns, do not come in contact with heater. Keep combustible materials, such as furniture, pillows, bedding, papers, clothes, and curtains at least 3 feet(1m.) from the front of the heater.
3. Extreme caution is necessary when any heater is used by or near children or invalids and whenever the heater is left operating and unattended.
4. Always unplug heater when not in use.
5. Do not operate any heater with a damaged cord or plug or after the heater malfunctions, has been dropped or damaged in any manner.
6. Any repairs to this appliance should be carried out by a qualified service person.
7. Under no circumstances should this electric fireplace be modified. Parts having to be removed for servicing must be replaced prior to operating this electric fireplace again.
8. Do not use outdoors.
9. This heater is not intended for use in bathrooms, laundry areas or similar indoor locations. Never use this appliance near a bathtub or other water container.
10. Do not run cord under carpeting. Do not cover cord with throw rugs, runners or similar coverings. Arrange cord away from traffic areas and where it will not be tripped over.
11. To disconnect heater, turn controls to OFF, then remove plug from outlet.
12. Connect to properly grounded outlets only.
13. When this appliance is installed, it must be electrically grounded in accordance with local codes with the current CSA C22.1 Canadian local codes for USA installations. Follow local codes and National Electrical Code, ANSI/NFPA NO.70 and Canadian Cord: CZ 22.2 NO.0.
14. Do not insert or allow foreign objects to enter any ventilation or exhaust opening as this may cause electric shock, fire or damage to the heater.
15. To prevent a possible fire, do not block air intakes or exhaust in any manner. Do not use on soft surfaces, such as a bed, where openings may become blocked.
16. This heater gets hot and it contains internal parts that sparks and arcs. Do not use it in areas where gasoline, paint, or flammable liquids are used or stored.
17. Use this heater only as described in this manual. Other uses not recommended by the manufacturer may cause fire, electric shock, or injury.
18. Avoid the use of an extension cord because it may overheat and cause a risk of fire. However if you must use an extension cord, the cord shall be No. 14AWG minimum size and rated not less than 1900 watt. The extension cord must be a three wire cord with grounding type plug and cord connector.
19. This electric fireplace heater should not be used as a drying rack for clothing. Also, do not hang Christmas stockings or decorations on or near it.

## **20. SAVE THESE INSTRUCTIONS.**

## LOCATING YOUR ELECTRIC FIREPLACE

Your new freestanding electric fireplace may be installed virtually anywhere in your home. However when choosing a location for your new electric fireplace, ensure that the general instructions are followed. For best effect results, install the electric fireplace out of direct sunlight.

## CLEARANCE TO COMBUSTIBLES

Sides.....	0 mm	0 inches
Floor.....	0 mm	0 inches
Top.....	0 mm	0 inches

## ELECTRICAL CONNECTION

A 15 AMP, 120 Volt, 60Hz circuit with a properly grounded outlet is required. Preferably, the fireplace will be on a dedicated circuit. Other appliances on the same circuit may cause the circuit breaker to trip or the fuse to blow when the heater is on operation. The unit comes standard with a 6' (1828mm) long three wire cord exiting from the rear of the fireplace. Plan the installation to avoid the use of an extension cord. If an extension cord must be used, it must be a minimum 14 AWG three wire with grounding type plug connector and rated no less than 1900 Watts. The cord shall not be more than 20 feet in length.



**WARNING:** Electrical outlet wiring must comply with local building codes and all other applicable regulations to reduce the risk of fire, electrical shock and injury.



**WARNING:** Do not use this fireplace if any part of it has been under water. Immediately call a qualified service technician to inspect the fireplace and replace any part of the electrical system if necessary.

## ELECTRICAL SPECIFICATIONS

Voltage:	120 VAC, 60 Hz
Total Amps:	11.5 Amps
Total Watts:	1380 Watts
Heater Rating:	1200 Watts

## SERVICE INSTRUCTIONS



**WARNING:** Disconnect power before attempting any maintenance or cleaning to reduce the risk of fire, electrical shock or personal injury.

### REPLACING LIGHT BULBS

This fireplace uses four clear 120 Volt, 60 Watt, E-12 socket base light bulbs (small base, chandelier candle type). The 60 Watt bulbs are located under the log set/ember bed. For convenience, if one of the bulbs burns out, it may be a good idea to replace all of the light bulbs.

1. Turn off power to the unit by unplugging the power cord.
2. Let fireplace cool if it has been operating.
3. Remove the two screws on the top corner of screen. Pull the screen upward slightly, and then pull out.

4. Remove the four screws that secure the log set/ember bed in position.
5. Remove log set / ember bed and grate assembly.
6. Examine the bulb(s) to determine which bulbs need to be replaced.
7. While holding the socket, unscrew defective bulb(s) counterclockwise.
8. Install the new light bulb(s) by holding the socket and screwing clockwise.
9. Reinstall the log set/ember bed, grate assembly and screen. Follow the above procedure in reverse order.



**WARNING:** Do not exceed 60 Watts per bulb. The use of higher rated bulbs may result in a fire causing property damage and personal injury.

## MAINTENANCE OF MOTORS

The motors used on the fan and flame generator assembly are prelubricated for extended bearing life and require no further lubrication. However, periodic cleaning/vacuuming of the fan/heater unit is recommended.



**WARNING:** Make sure that the power is turned off before proceeding.

## GLASS INFORMATION

1. Under no circumstances should this product be operated with missing or broken glass.
2. Do not strike or slam the glass.
3. Do not use abrasive cleaners to clean the glass.
4. Replacement glass is available from the manufacturer and replacement should be carried out by a qualified service person.

## ELECTRICAL WIRING DIAGRAM

Any electrical repairs or rewiring of this unit should be carried out by a licensed electrician in accordance with national and local codes.



If repairing or replacing any electrical component or wiring, the original wire routing, color coding and securing location must be followed.

### Electrical Wiring Diagram

#### Wire Gauge:

**Power Cord**      **14AWG**  
**Heater Element**   **16AWG**  
**Other Wire**        **18AWG**

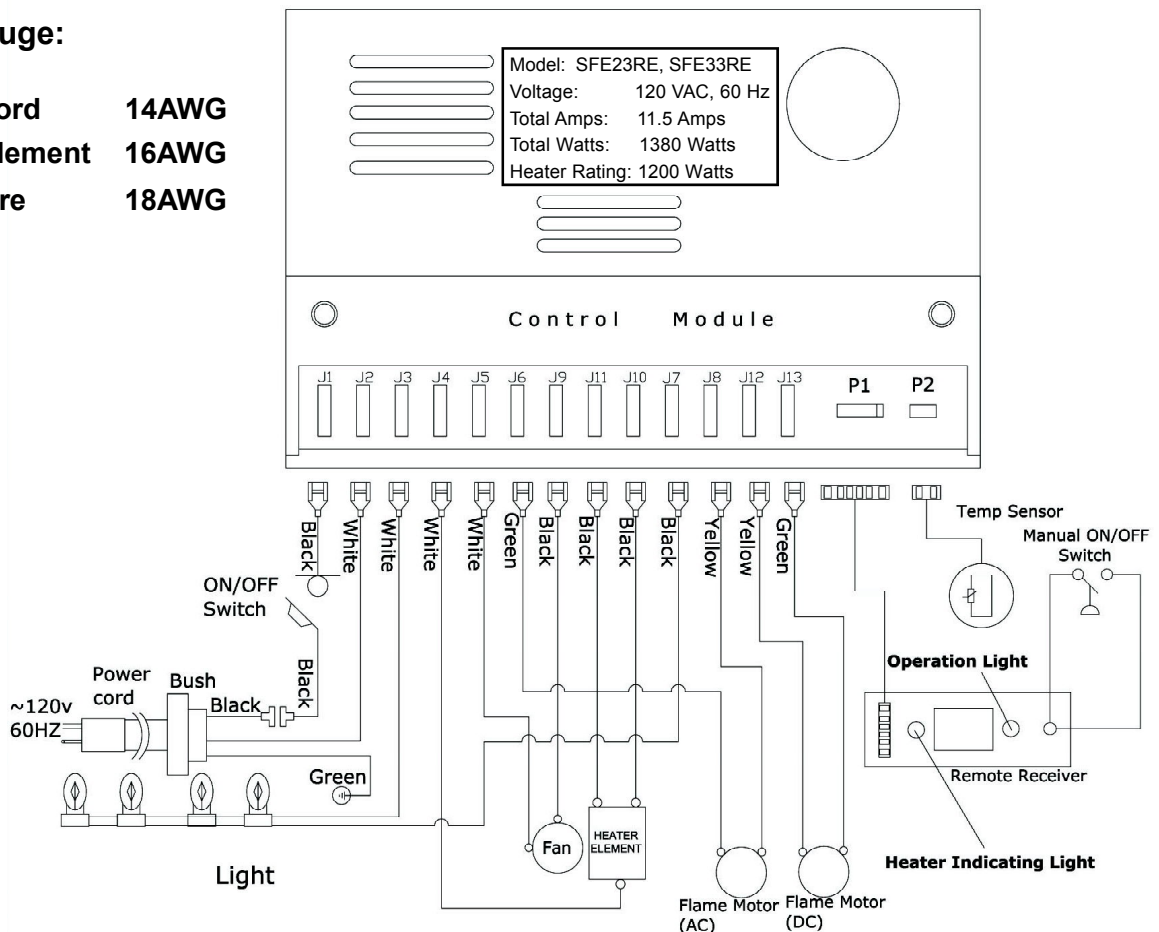

If any of the original wire as supplied with the appliance must be replaced, it must be replaced with a wire of at least a 105 centigrade temperature rating.

# Operating Instructions

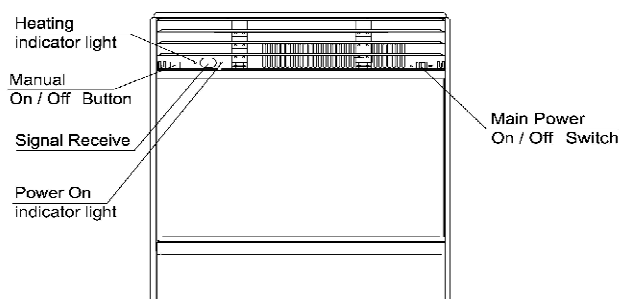

Heater Front View

Before programming your transmitter you must first insert three triple "AAA" batteries.

Make sure the main power on/off switch is in "ON" position.

## 1. The Mode setting:

Press the "SET" button, then the "AUTO" light will flash. Press the "SET" button again, and then the "MANUAL" light will also flash. The "AUTO" light and the "MANUAL" light will flash alternately and continuously. Next press "ENTER" button to select the auto mode or manual mode.

### a. When selecting "AUTO" mode:

Select "AUTO" and press the "ENTER" button to activate, then press the "SET" button, next the 'Temperature', 'Flame', 'Light', 'lamp' symbols will flash alternately. Next press the ▲ button or the ▼ button to select the desired temperature setting. When the temperature setting has been selected, press the "SET" button to lock in the temperature setting, next set the following functions that appear on the transmitter. When the last function setting has been completed, press the "ENTER" button, and the symbols will stop flashing.

### b. When selecting "MANUAL" mode:

Select "MANUAL" and press the "ENTER" button to confirm, then press the "SET" button, the 'Flame', 'Light', 'lamp', 'Heating level' symbols will flash alternately. The next symbol will flash automatically set the functions as they appear. When the last function setting has been completed, press the "ENTER" button, and the symbols will stop flashing.

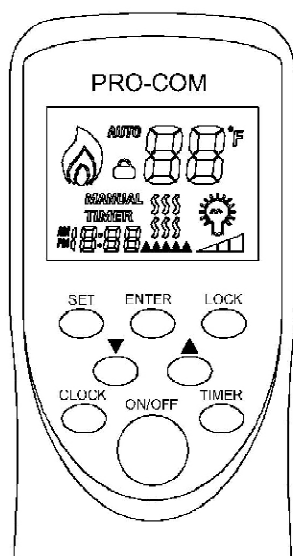

Remote Control Front

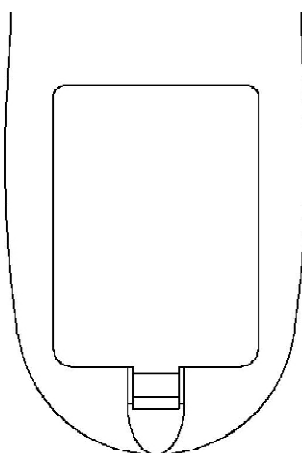

Remote Control Back

## 2. The Clock setting :

Press the "CLOCK" button, the figure shown on clock will flash. Press ▲ or ▼ to set the hour. After the hour has been set, press the "CLOCK" button again to set the minutes. After the minutes has been set, press the "CLOCK" button, the clock will indicate the set time.

## 3. The Timer setting :

Press the "TIMER" button, the word "TIMER" will appear on the transmitter, next press ▲ or ▼ to adjust the time, to add 30 minutes increments press the button again. After the timer has been set, press "TIMER" button again, the word "TIMER" will flash and the timer will return to time.

## 4. Key-Press Lock setting (child proof):

To lock, press the "LOCK" button, there will be a  symbol, which means that the transmitter is in a lock position. To unlock, press ▼ once immediately followed by pressing the "LOCK" button .

## 5. Heating Level setting

Select the MANUAL model and press SET to choose the heating level setting, the "▲▲▲▲" symbol will flash. Then press ▲ or ▼ to select full, half or no heating.

## 6. Flame Effect setting:

### (1) Flame speed

After selecting MANUAL mode or AUTO mode, the flame symbol will flash, for slow flame effect, press ▼ button, for faster flame effect, press ▲ button.

### (2) Flame brightness

Press "SET" button, when the lamp symbol flashes, press ▼ button to decrease the flame brightness and ▲ button to increase the flame brightness.

## 7. For Flame Effect only:

Select MANUAL mode, then set the Heating level to no heating level or select AUTO mode and then set temperature to lowest setting.

## 8. Manual ON/OFF button

If you can't find your Remote Control or the Remote Control is damaged, you can use manual ON/OFF button to manual turn on/turn off your heater.

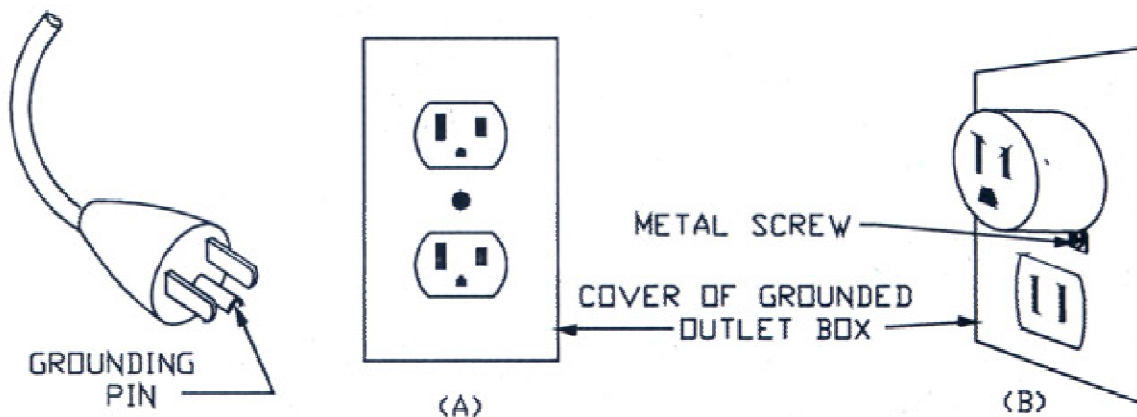

(Adaptor NOT permitted in Canada)  
Under C22.2 NO. 0 standard

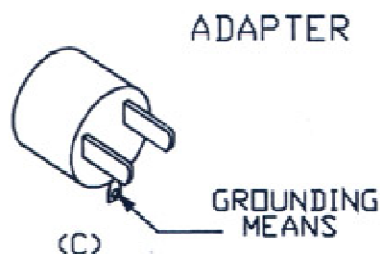





# Replacement Parts List

**SFE23RE-X\*    SFE33RE-X\***

**\* -X represents -W(White), -C(Cherry), -O(Oak), -DO(Dark Oak)**

Item	Part Description	Part Number	
		SFE23RE-X*	SFE33RE-X*
1	Log Set	FE23A400	FE33A400
2	Control Box	NAEY11-A	NAEY11-A
3	Receiver	NAEY11-CS	NAEY11-CS
4	Fan Heater Assembly	NFHTX186 / VB17-000G	NFHTX186/V- B17-000G
5	DC Motor	FE23A304	FE23A304
6	Power Cord w/Terminal	NFHL008-A	NFHL008-A
7	Light Bulb Socket w/Wiring Assembly	FE23A306	FE23A306
8	Over Current Protector	FE23A305	FE23A305
9	AC Motor w/Terminal	VL051-01	VL051-01
10	Flame generator Assy	FE23A205	FE33A205
11	Ember bed generator Assy	FE23A207	FE33A207
12	Light Bulb	VL055-01	VL055-01
13	Remote Control	NAEY11-BPR	NAEY11-BPR
14	Mantel Assy	FE23A500-X*	FE33A500-X*
15	Louver ASSY	FE23A109-A	FE33109-A
16	Viewing Door	FE23A130-W	FE33A130-W
17	Log 1	FE23A403	FE33A403
18	Log 2	FE23A404	FE33A404
19	Log 3	FE23A405	FE33A405
20	Log 4		FE33A406
21	Log 5		FE33A407
22	Log 6		FE33A408

**\* -X specify -W(White), -C(Cherry), -O(Oak), -DO(Dark Oak)  
when ordering**

## Installing decorating logs

### Installing logs for SFE23RE:



FIG 1 - Logs for SFE23RE

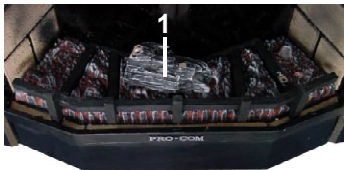

FIG 2

1. Insert the two pins on log 1 to the two recessed holes at the middle of grate. (See FIG 2).

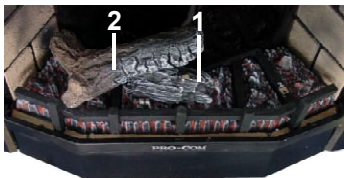

FIG 3

2. Insert the pin on one end of log 2 to the recessed hole on log 1, with the other end of log 2 placed on the ember bed (where marked). (See FIG 3).

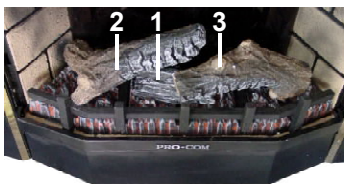

FIG 4

3. Place one end of log 3 onto the hole on grate, with the other end placed on log 1 (where marked). (See FIG 4).

### Installing logs for SFE33RE:



FIG 5 - Logs for SFE33RE



FIG 6

1. Place log 1, log 2 and log 3 into the corresponding holes on grate. (See FIG 6).



FIG 7

2. Insert the pin on one end of log 4 to the recessed hole on log 1, with the other end of log 4 placed where marked. (See FIG 7).



FIG 8

3. Insert the pin on one end of log 5 to the recessed hole on log 2, with the other end of log 5 placed where marked. (See FIG 8).



FIG 9

4. Insert the pin on log 6 to the recessed hole on log 4, and place log 6 as figure shows. (See FIG 9).



## Free Manuals Download Website

<http://myh66.com>

<http://usermanuals.us>

<http://www.somanuals.com>

<http://www.4manuals.cc>

<http://www.manual-lib.com>

<http://www.404manual.com>

<http://www.luxmanual.com>

<http://aubethermostatmanual.com>

Golf course search by state

<http://golfingnear.com>

Email search by domain

<http://emailbydomain.com>

Auto manuals search

<http://auto.somanuals.com>

TV manuals search

<http://tv.somanuals.com>