

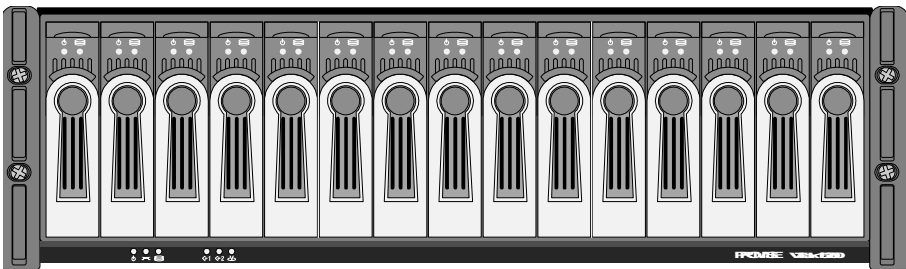

VTRAK 15110

USER MANUAL

Version 1.1 / SR5



Copyright

© 2005 Promise Technology, Inc. All Rights Reserved.

Copyright by Promise Technology, Inc. (Promise Technology). No part of this manual may be reproduced or transmitted in any form without the expressed, written permission of Promise Technology.

Trademarks

Promise, and the Promise logo are registered in U.S. Patent and Trademark Office. All other product names mentioned herein may be trademarks or registered trademarks of their respective companies.

Important data protection information

You should back up all data before installing any drive controller or storage peripheral. Promise Technology is not responsible for any loss of data resulting from the use, disuse or misuse of this or any other Promise Technology product.

Notice

Although Promise Technology has attempted to ensure the accuracy of the content of this manual, it is possible that this document may contain technical inaccuracies, typographical, or other errors. Promise Technology assumes no liability for any error in this publication, and for damages, whether direct, indirect, incidental, consequential or otherwise, that may result from such error, including, but not limited to loss of data or profits.

Promise Technology provides this publication “as is” without warranty of any kind, either express or implied, including, but not limited to implied warranties of merchantability or fitness for a particular purpose.

The published information in the manual is subject to change without notice. Promise Technology reserves the right to make changes in the product design, layout, and driver revisions without notification to its users.

This version of the User Manual supersedes all previous versions.

Recommendations

In the manual, the appearance of products made by other companies, including, but not limited to software, servers and disk drives, is for the purpose of illustration and explanation only. Promise Technology does not recommend, endorse, prefer or support any product made by another manufacturer.

Contents

Chapter 1: Introduction	1
About This Manual	1
Overview	2
Architectural Description	3
Specifications	5
Chapter 2: Installation	7
Unpack the VTrak	7
Mount VTrak 15110 in a Rack	8
Install Disk Drives	9
Serial ATA Disk Drives	12
Parallel ATA Disk Drives	13
Drive Numbering	14
Verify the SCSI HBA Card	15
Connect the SCSI Cables	16
SCSI Terminator	17
Connect the Management Cables	22
Management Port Connection	22
RS-232 Serial Connection	22
Macintosh Users	23
Connect the Power	23
Set-up Management Connections	25
Terminal Emulation	25
Set IP Addresses and Subnet Mask	26
Set Up Telnet Connection	29
Enable Telnet on VTrak	29
Make a Telnet Connection	30
Install WebPAM PRO Software	33
Utility Server Installation Locations	33
CIMOM Agent	34
Internet Browser	35
Before you start...	35
Install WebPAM PRO	35
Chapter 3: Setup	43
VTrak Setup with WebPAM PRO	43
Log-in to WebPAM PRO	43
Add a Subsystem (VTrak)	46
Access a Subsystem (VTrak)	46
Create a Disk Array	48

Create a Logical Drive	54
Assign a SCSI Target ID	55
Log-out of WebPAM PRO	56
Internet Connection using WebPAM PRO	56
VTrak Setup with the CLU	57
CLU Connection	57
Create a Disk Array	58
Create a Logical Drive	62
Assign a SCSI Target ID	63
Exit the CLU	64
Chapter 4: Management with WebPAM PRO	65
VTrak Status Indicators	65
Drive Status Indicators	66
Audible Alarm	67
Log-in/Log-out	68
Log-in to WebPAM PRO	68
Log-out of WebPAM PRO	70
Subsystem Management	71
Add a Subsystem (VTrak)	71
Subsystem User Rights	71
Access a Subsystem (VTrak)	73
Subsystem Management Window	74
View Event Log	74
Delete a Subsystem	76
User Management	77
Add a User	77
Delete a User	83
Manage User Rights	83
Change Password	85
Setup Email Alert Notification	86
Software Management	87
Web Server	87
Email	88
Firmware Update	89
TFTP Server	90
Refresh Time	91
Restart Tomcat Service (Windows)	91
Security	91
Subsystem Management	92
Events	92

Connection Status	94
User Rights	94
VTrak Management	95
Lock Operations	95
Subsystem Health	95
MP/PDM Settings	96
SCSI Management	97
LUN Settings	97
TID Settings	98
Statistics	99
Network Management	99
Ethernet	99
Settings	100
Service Management	100
Service	100
SNMP	101
Telnet	102
Controllers	102
Controller List	102
Controller	102
Settings	103
Enclosures	104
Enclosure List	104
Enclosure	105
FRU VPD	105
Battery	106
Buzzer	106
Physical Drive List	107
Physical Drive	108
Disk Arrays	110
Disk Array List	110
Create a Disk Array	111
Delete Disk Array	116
Disk Array Information	117
Disk Array Settings	119
Create Logical Drive	120
Delete Logical Drive	121
Background Activity	121
Scheduler	122
Logical Drive List	123
Logical Drive	124

Logical Drive LUN Settings	126
Logical Drive Alias	127
Physical Drives	127
Spare Drives	127
Spare Drive List	128
Create a Spare Drive	128
Delete a Spare Drive	129
Logical Drive Summary	130
Logical Drive List	130
Logical Drive	131

Chapter 5: Management with the CLU 133

VTrak Status Indicators	133
Drive Status Indicators	134
Audible Alarm	136
Alarm Settings	136
CLU Connection	137
Serial Connection	137
Telnet Connection	137
Exit the CLU	139
How to use the CLU	140
CLU Function Map	142
Controller Management	148
View Controller Information	148
Modify Controller Parameters	148
Firmware Update	149
VPD	149
Reboot	149
Enclosure Management	151
Fan Speed	151
Buzzer	151
Temperature	152
Voltage	152
Battery	152
Physical Drive Management	154
View Parameters	155
Enable/Disable Write Cache	155
Wipe Out Boot Sector	156
Wipe Out Reserve Sector	156
Blink LED	157
Diagnostics	157

I/O Statistics	158
Disk Array Management	160
Disk Array Auto Creation	161
Create New Disk Array	162
Delete Disk Array	164
Disk Array Properties	164
PDM Auto Start	169
Logical Drive Management	172
Network Management	173
Management Port	173
Telnet	174
TFTP Server	176
SNMP	176
Ping	178
SCSI Management	180
Channel TID	180
RAID Console LUN	181
Maintenance Menu (Disk Array Operations)	182
Maintenance Activity Monitor	183
Migrate Disk Array	183
Manual Rebuild	184
Event Viewer	188
Chapter 6: Maintenance	189
Firmware Update – WebPAM	190
Preparation	190
Firmware Update	191
Firmware Update – CLU	192
Preparation	192
Firmware Update	192
Firmware Update – Serial Port	194
Firmware Image File	194
Firmware Update	194
Replace Power Supply	196
Replace Cooling Unit Fan	197
Replace Cache Battery	202
Replace SEP	204
Replace RAID Controller	205

Chapter 7: Technology Background	207
Introduction to RAID	207
Choosing a RAID Level	214
Choosing Stripe Block Size	217
Gigabyte Boundary	217
Initialization	217
Hot Spare Drive(s)	218
Partition and Format the Logical Drive	218
Cache Settings	219
RAID Level Migration	219
Chapter 8: Troubleshooting	223
VTrak is Beeping	223
CLU Reports a Problem	223
WebPAM PRO Reports a Problem	224
LEDs Display Amber or Red	226
Front Panel	226
Drive Status Indicators	228
Back of Enclosure	229
Event Notification Response	230
Critical & Offline Disk Arrays	234
Enclosure Problems	235
Connection Problems	239
Chapter 9: Support	241
Frequently Asked Questions	241
Contacting Technical Support	245
Limited Warranty	248
Returning Product For Repair	249
Appendix A: Serial Connector Pinout	251
Index	253

Chapter 1: Introduction

- About This Manual, page 1
- Overview, page 2
- Architectural Description, page 3
- Features and Benefits, page 3

Thank you for purchasing Promise Technology's VTrak external disk array subsystem.

About This Manual

This *User Manual* describes how to setup, use and maintain the VTrak 15110 external disk array subsystem. It also describes how to use the built-in command-line utility (CLU) and Web-based Promise Array Management—Professional (WebPAM PRO) software.

This manual includes a full table of contents, index, chapter task lists and numerous cross-references to help you find the specific information you are looking for.

Also included are four levels of notices:



Note

A *Note* provides helpful information such as hints or alternative ways of doing a task.



Important

An *Important* calls attention to an essential step or point required to complete a task. Important items include things often missed.



Caution

A *Caution* informs you of possible equipment damage or loss of data and how to avoid them.



Warning

A *Warning* notifies you of probable equipment damage or loss of data, or the possibility of physical injury, and how to avoid them.

Overview

VTrak provides data storage solutions for applications where high performance and data protection are required. The failure of any single drive will not affect data integrity or accessibility of the data in a RAID protected logical drive.

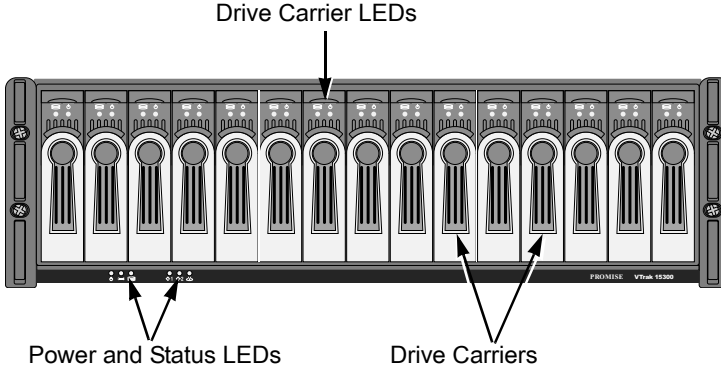

Figure 1. VTrak 15110 front view

A defective drive may be replaced without interruption of data availability to the host computer. If so configured, a hot spare drive will automatically replace a failed drive, securing the fault-tolerant integrity of the logical drive. The self-contained hardware-based RAID logical drive provides maximum performance in a compact external chassis.

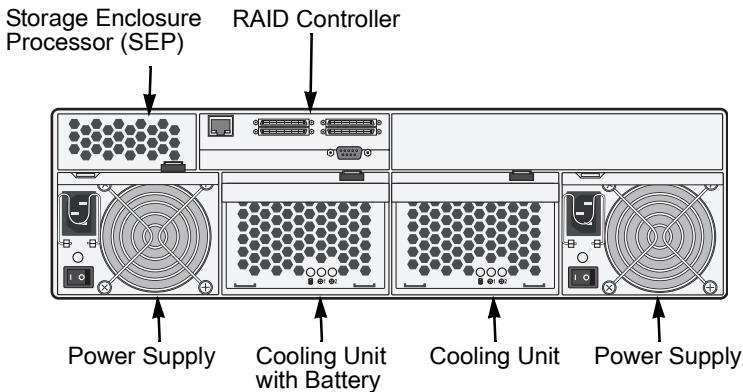

Figure 2. VTrak 15110 rear view

The VTrak 15110 is an external disk array subsystem with a capacity of fifteen individual Serial ATA or (parallel) ATA disk drives.

The two standard LVD SCSI interface provides compatibility with any system that uses a SCSI interface. No vendor unique commands are required for the operation of the VTrak subsystem.

Architectural Description

The VTrak 15110 is a Direct Attached Storage (DAS) subsystem that can also function in a Storage Area Network (SAN). It consists of 15 disk drive bays, a 3U enclosure with mid-plane, RAID controller, power and cooling units, and enclosure processor all in one cable-less chassis design. Multiple fans and power supplies provide redundancy to ensure continued usage during component failure. The RAID controller is hardware based and controls all logical drive functions transparently to the host system. VTrak appears to the computer's operating system as a standard SCSI drive or drives.

Features and Benefits

Feature	Benefit
3U 19-inch wide enclosure	Installs easily in any standard rackmount.
Supports RAID levels 0, 1, 3, 5, 10 and 50	Allows system to be tuned for maximum performance.
Supports online logical drive (array) expansion	Lets you add disk drives to an existing logical drive without interrupting data accessibility
Supports online RAID migration	Allows you to convert a logical drive from one RAID level to another without interrupting data accessibility
Supports Parallel ATA drives (with a Promise adapter card)	Allows you to use existing ATA disk drives.
Supports logical drive migration from other Promise RAID products	Allow you to seamlessly move your existing logical drives to VTrak without recreating them.
S.M.A.R.T. monitoring	Warns of disk drive degradation and potential failure.
Dual-channel standard SCSI-3 (Ultra 160) drive to host	Compatible with all SCSI-3 or SCSI-2/LVD host adapters. No special OS drivers used.
Up to 20K IOPS (over two iSCSI ports)	High processing rate.

Feature	Benefit
Up to 200 MB/sec sustained bandwidth (over two iSCSI ports)	High data throughput.
Hardware-assisted XOR engine	High-speed parity calculation for parity type logical drives.
Supports out-of-band management through RS232 and 10/100 BaseT Ethernet connections	Allows you to manage the RAID subsystem while maximizing bandwidth on the iSCSI network.
Supports SNMP (v1) CIM and WBEM standards	API-ready for enterprise management integration.
Tagged command queuing up to 256 commands	Maximum performance in Multi-Threaded Operating Systems.
Supports SATA II Native Command Queuing	High performance and efficiency through efficient command re-ordering.
Hot-swap feature for drive carriers, power supplies, fans and battery	Allows a defective component to be replaced without interrupting data accessibility to the host system.
Tool-less field-replaceable units (FRUs)	All FRUs can be replaced without tools, saving time and effort for support personnel.
Hot-spare drives	Maintains full fault tolerant integrity by automatically rebuilding the data from a failed drive to an installed hot spare drive. Supports multiple, designated and global spares.
Automatic background data reconstruction when a drive is replaced	Logical drive is quickly back on-line with minimal user intervention.
Redundant, hot-swappable cooling units	Load sharing and full operation even with multiple failed fans.
N+1 Redundant, hot-swappable power supplies	Load sharing and full operation even with a failed power supply.
Redundant SCSI ports	Load sharing and full operation even with a failed SCSI port.

Feature	Benefit
Cluster support	Supports two-node server clusters for performance and availability.
Complete cable-less design	All components easily plug directly into boards. No cables to complicate setup or maintenance.
Cache battery backup	72-hour backup for controller cache to retain data in case of power failure.
Command-line and Graphic-user interfaces	Choice of control and monitoring methods for greater flexibility.

Specifications

Drive Capacity: 15 SATA and PATA disk drives (3.5" x 1" form factor only)

External I/O Ports: Dual Ultra 160 SCSI with 68-pin VHDCI connections

Sustained Throughput: Up to 200 MBps (over two iSCSI ports)

Sustained I/Os: Up to 20,000 I/Os per second

Data Cache: Up to 512MB predictive data cache with automatic write cache destaging and 72-hour battery backup protection (256 MB, standard)

Supported RAID Levels:

- RAID 0
- RAID 1
- RAID 3
- RAID 5
- RAID 10
- RAID 50

Any combination of these RAID levels can exist at once on separate logical drives. See page 207 for more information on RAID.

RAID Flexibility: Configurable RAID stripe size – 4,8,16,32 or 64 sectors per disk.

Rebuild priority tuning: Adjustment of minimum I/O reserved for server use during rebuild.

Hot-spares: Multiple global and designated hot spares.

Maximum Disks & LUNs: 15 in any combination of RAID levels and drive types.

Supported Disk Interfaces: Serial ATA (SATA), Parallel ATA (with optional Promise adapter).

Supported Operating Systems:

- Windows 2000
- Windows XP Professional
- Windows 2003
- Mac OS X
- RedHat Linux
- SuSE Linux

Current: 8 A @ 100 VAC; 4 A @ 200 VAC (max. rating with two power cords)

Power Consumption: 440 watts

Power Supply: Dual 500W, 100–240 VAC auto-ranging, 50–60 Hz, dual hot swap and redundant with PFC, N+1 design

Thermal Output: 1590 BTU/hour (max current)

Operating Temperature: 41° to 104°F (5° to 40°C)

Non-operational Temperature: -40° to 140°F (-40° to 60°C)

Relative Humidity: Maximum 90%

Vibration: Random, 0.21 grms, 5 to 500Hz, 30Mins, X, Y, Z axis

Management Tools: WebPAM Professional, Command Line Utility

Management Interfaces: Ethernet, RS232 (Serial)

Management Protocols: SNMP, SSL, WBEM, Telnet

Notification: Email, audible, and visible alarms

Dimensions: Height, 5.0 in (12.7 cm); Width, 17.6 in (44.8 cm); Depth, 26.0 in (66.0 cm)

Weight: 66 lbs (30 Kg) without drives; Approximately 84 lbs (38 Kg) with 15 drives installed

Safety Certifications: CE, FCC Class A, BSMI, VCCI, cUL, TUV, MIC

Limited Warranty: 3 Years (See page 248 for details)

FCC Statement

This device complies with Part 15 of the FCC Rules. Operation is subject to the following two conditions: (1) this device may not cause harmful interference, and (2) this device must accept any interference received, including interference that may cause undesired operation.

Chapter 2: Installation

- Unpack the VTrak storage subsystem (below)
 - Mount VTrak 15110 in a Rack (page 8)
 - Install Disk Drives (page 9)
 - Verify the SCSI HBA Card (page 15)
 - Connect the SCSI Cables (page 16)
 - Connect the Management Cables (page 22)
 - Connect the Power (page 23)
 - Set-up Management Connections (page 25)
 - Set Up Telnet Connection (page 29)
 - Install WebPAM PRO Software (page 33)
-

Unpack the VTrak

The VTrak box contains the following items:

- VTrak Unit
- Quick Start Guide
- Null Modem Cable
- SCSI Terminators (2)
- Left and right mounting rails
- 1.0m External VHDCI SCSI cables (2)
- Screws for disk drives (64 plus 4 spares)
- 1.5m (4.9 ft) Power cords (2)
- CD with WebPAM PRO Software, *User Manual* and *Quick Start Guide*



Warning

The electronic components within the VTrak disk array are sensitive to damage from Electro-Static Discharge (ESD). Observe appropriate precautions at all times when handling the VTrak or its subassemblies.



Important

In order to work with VTrak, the SCSI Host Bus Adapter (HBA) card you select for the Host PC must meet requirements. See page 15.

Mount VTrak 15110 in a Rack

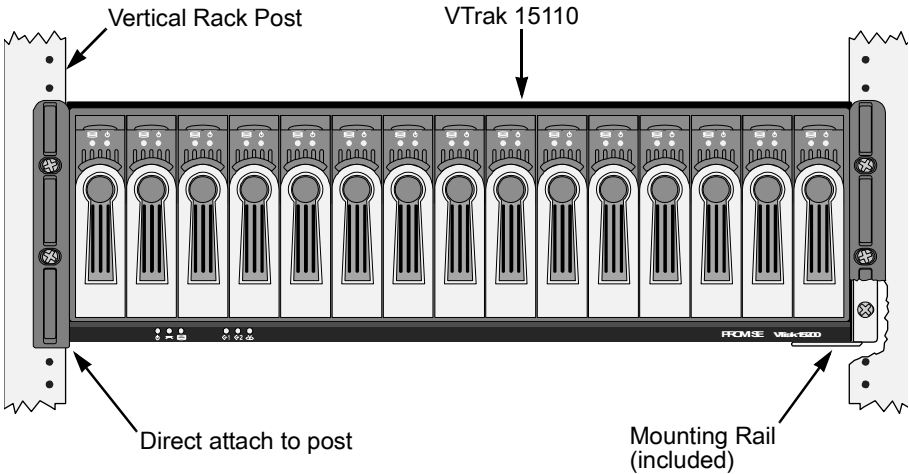

Figure 1. Rackmounted VTrak 15110

The VTrak 15110 installs directly to the rack with or without using the supplied mounting rails.

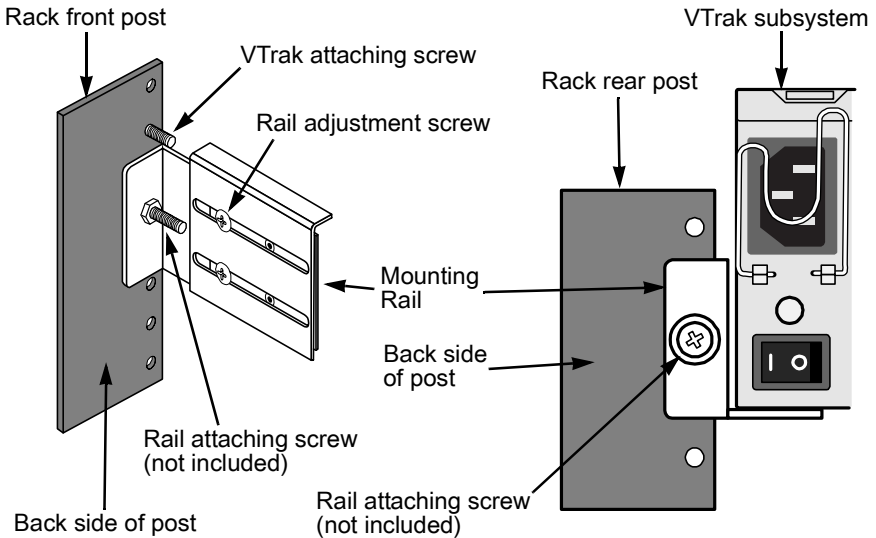

Figure 2. Mounting rail installation

If you plan to use the mounting rails, follow this procedure to install them:

1. Attach one end of the rail to the back side of the rack's front post.
2. Reposition the adjusting screws as needed to fit the rail to the rack properly.
3. Attach the other end of the rail to the back side of the rack's rear post.
4. Repeat steps 1 through 3 to attach the other rail.
5. Square the rails in the rack and tighten the attaching screws.
6. Set the VTrak onto the rails.
7. Attach the VTrak to the rack's front posts with the screws provided.



Caution

Do not pull or push the handles on the Power Supplies or the Controller units in order to move the VTrak. Hold the VTrak by the housing only.

Install Disk Drives

Before using the VTrak you must first populate it with Serial ATA (SATA) disk drives. You can also use Parallel ATA (PATA) disk drives with the optional SATA-to-PATA adapters available from Promise Technology. The VTrak 15110 can support up to fifteen disk drives and provide the RAID configurations listed below. See Chapter 7, page 207 for a complete explanation of RAID on VTrak.

RAID Configuration	Number of disk drives	
	Minimum	Maximum
RAID 0	1	15
RAID 1	2	2*
RAID 3	3	15
RAID 5	3	15
RAID 10	4	14
RAID 50	6	14
* RAID 1 logical drives work in matched pairs. VTrak supports up to seven (7) RAID 1 logical drives.		



Important

Before installing a Parallel ATA disk drive, be sure the jumpers on the disk drive are set for *master* operation. *Never* set a drive for slave operation.



Note

You can use disk drives of different manufacturers and sizes. In logical drives with different drive sizes, the drives are forced to equal the capacity of the smallest physical drive.

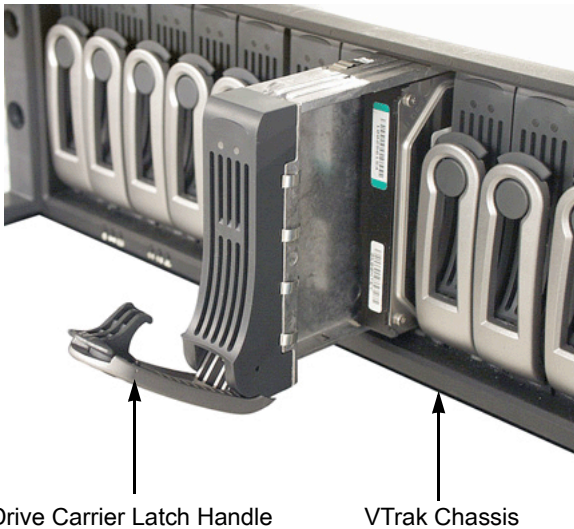

Figure 3. VTrak 15110 Disk Drive access

To remove a Drive Carrier from the VTrak, pull the Drive Carrier Latch Handle and remove an unused Drive Carrier (see Figure 3).

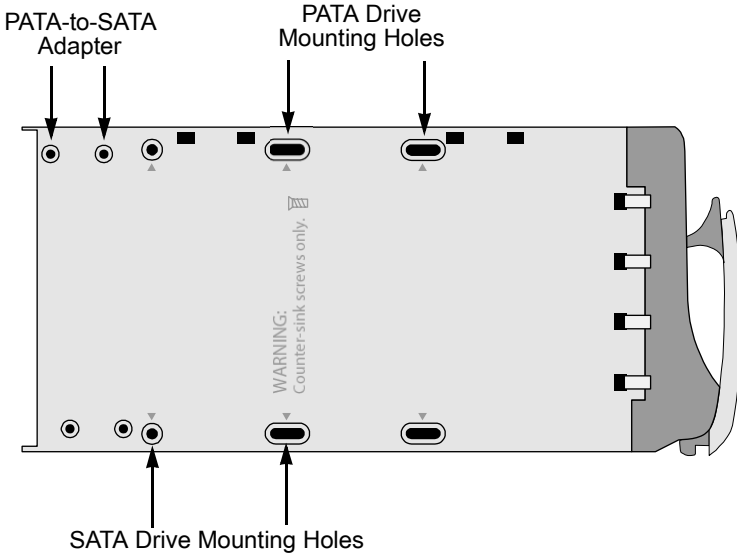

Figure 4. Drive Carrier mounting holes

Note that the Drive Carrier has several mounting holes (above). Those marked with a triangle are for disk drives.



Caution

Be sure to install the counter-sink screws supplied with the VTrak. Use of other types of screws can damage the adjacent drives.

Serial ATA Disk Drives



Figure 5. SATA Disk Drives mount at the front of the carrier

1. Carefully lay the drive into the drive carrier at the front, so that the screw holes on the bottom line up.
2. Insert the screws through the holes in the Drive Carrier and into the bottom of the disk drive (see Figure 4).
 - Install only the screws supplied with the VTrak.
 - Install four screws per drive.
 - Snug each screw. Be careful not to over tighten.
3. Reinstall the drive carrier into the VTrak chassis.
4. Repeat these steps until all of your disk drives are installed.

Parallel ATA Disk Drives

In order to use Parallel ATA disk drives in VTrak, you must first install a PATA-to-SATA adapter available from Promise Technology.

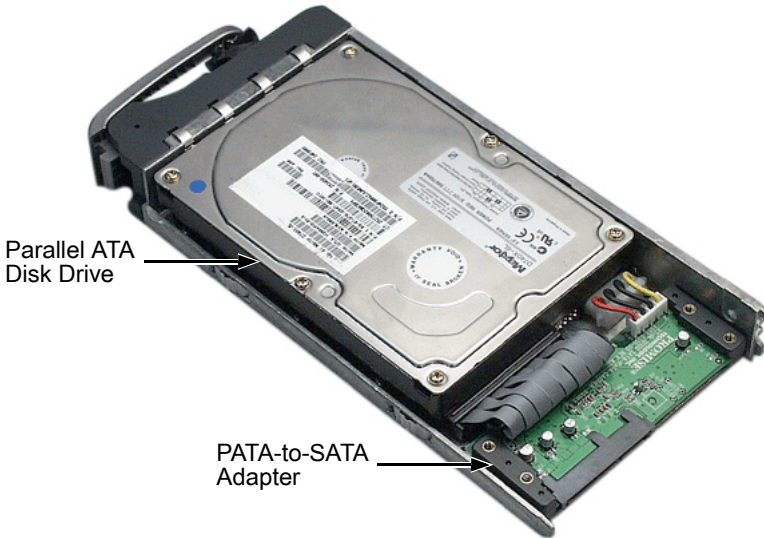

Figure 6. PATA Disk Drives require a PATA-to-SATA adapter

1. Obtain the needed quantity of PATA-to-SATA adapters from your Promise distributor.
2. Carefully lay the converter into the drive carrier, with the SATA connection facing forward (see Figure 5), so that the screw holes on the bottom line up (see Figure 3).
3. Install the four screws that came with the adapter.
4. Lay the carrier on a flat surface. Hold a disk drive in one hand and connect the power and data cables with the other.
5. Carefully lay the drive into the carrier so that the screw holes on the bottom line up (see Figure 4).
6. Insert Promise-supplied screws through the holes in the drive carrier and into the bottom of the disk drive.
7. Slide the assembled drive carrier back into the chassis and press the handle forward to secure the Drive Carrier.
8. Repeat these steps until all of your disk drives are installed.



Caution

If you plan to operate your VTrak with fewer than 15 disk drives, install all 15 Drive Carriers into the enclosure, to ensure proper airflow for cooling.



Important

Be sure each drive is securely fastened to its carrier. Proper installation ensures adequate grounding and minimizes vibration. Do not install drives with fewer than four screws.



Note

Previous array enclosures from Promise required you to latch the drive carrier handle in order to power the drive. VTrak uses the handle only to lock the carrier in place.

Drive Numbering

Each disk drive in VTrak is identified by a number used for creating and managing logical drives. VTrak numbers disk drives from left to right. Numbers are stamped above each drive bay for easy identification.



Figure 7. VTrak disk drives are numbered left to right

Verify the SCSI HBA Card

Data travels between the Host PC and the VTrak storage system through a SCSI connection. Therefore, the SCSI HBA card is an essential part of the Host PC and VTrak system.

The table below lists the minimum and preferred specifications for a SCSI HBA card.

	Minimum	Preferred
Data Transfer Rate	80 MB/s	160 MB/s
PCI Bus	32-bit	64-bit
PCI-X Bus	no	yes
External Connector	68-pin HD*	68-pin VHDCI
Cable Interface	LVD	LVD
Supports LUNs	yes	yes
* Requires use of a 68-pin HD to 68-pin VHDCI SCSI cable (available from Promise Technology).		

Refer to your system and/or SCSI HBA manual for these specifications.

VTrak has a peak sustained throughput of more than 100 MB/s per channel. Using an 80 MB/s SCSI card will result in a performance bottleneck under certain conditions.



Notes

For applications where two SCSI HBA cards are required, you can use a dual-channel SCSI HBA card.

Many single-channel SCSI HBA cards have multiple connectors. Be sure your card really is dual-channel.

If you connect two SCSI channels to a single-channel SCSI HBA card, only one channel will function.

Connect the SCSI Cables

Installation of the VTrak is very similar to a standard SCSI drive. The SCSI connector accepts the Very High Density Connector Interface (VHDCI), 68-pin, Low Voltage Differential (LVD) SCSI cable used on many SCSI devices.

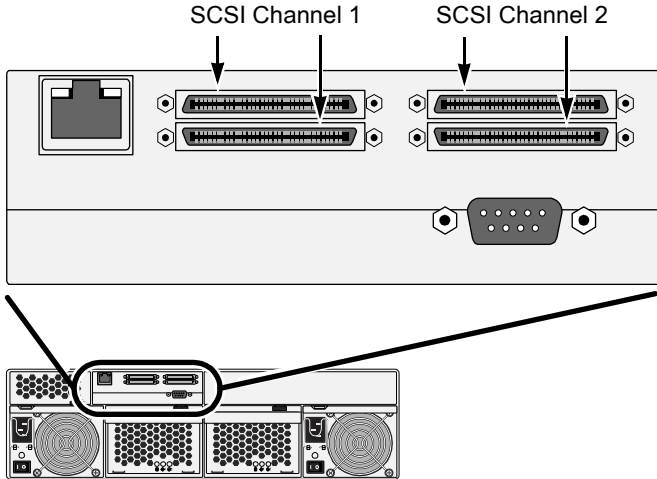

Figure 8. VTrak 15110 SCSI connections

When you attach the SCSI cables, you can use either the upper or lower connector for each channel. The connectors are non-directional, there is no SCSI in / SCSI out.



Caution

To prevent possible damage to the VTrak or your Host PC, ensure that the power to both units is OFF before connecting the SCSI cables.



Important

VTrak has two SCSI channels. When you attach a SCSI cable to the connector of one channel, be sure to attach a terminator to the other connector of the *same* channel. See Figure 8, above.

The VTrak has four 68-pin, VHDCI SCSI connectors and two separate SCSI channels. These connectors are used in one of five ways:

- Configuration 1: One VTrak, one Host PC, one SCSI HBA card
- Configuration 2: One VTrak, one Host PC, two SCSI HBA cards
- Configuration 3: One VTrak, two Host PCs, one SCSI HBA card in each
- Configuration 4: Two (or more) VTraks, one Host PC, one SCSI HBA card (daisy chain)
- Configuration 5: Two VTraks, one Host PC, two SCSI HBA cards

VTrak makes use of SCSI Target IDs (TIDs) and Logical Unit Numbers (LUNs) to enable multiple VTrak arrays managed by a single Host PC. How to set TIDs and LUNs is explained on page 97. At this point, proceed with the connection of SCSI cables following industry standard guidelines and the illustrations on the following pages.



Caution

Proper termination and SCSI-3 compliant cables are required for the system to operate correctly. Two external SCSI terminators and a SCSI-3 compliant cables are included with the VTrak 15110.

SCSI Terminator

When the VTrak is the last SCSI device in the chain you must install the Promise-supplied (or equivalent) external SCSI terminator on both SCSI Connectors (see below). The SCSI cable or terminator can attach to either SCSI connector. If you use a SCSI channel, you must attach a SCSI Terminator to it.

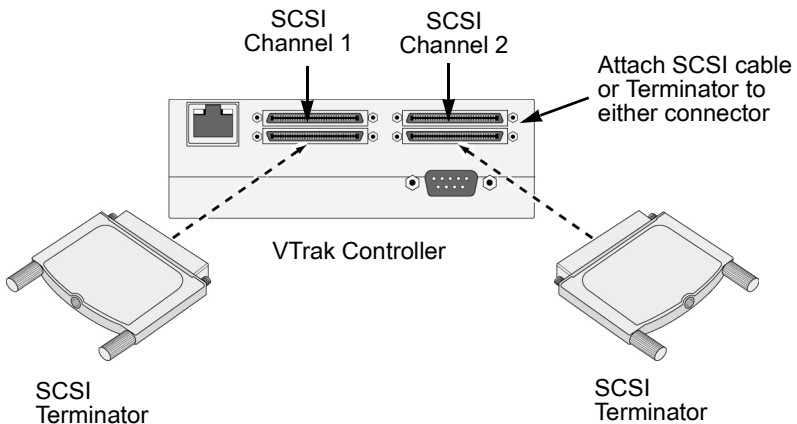
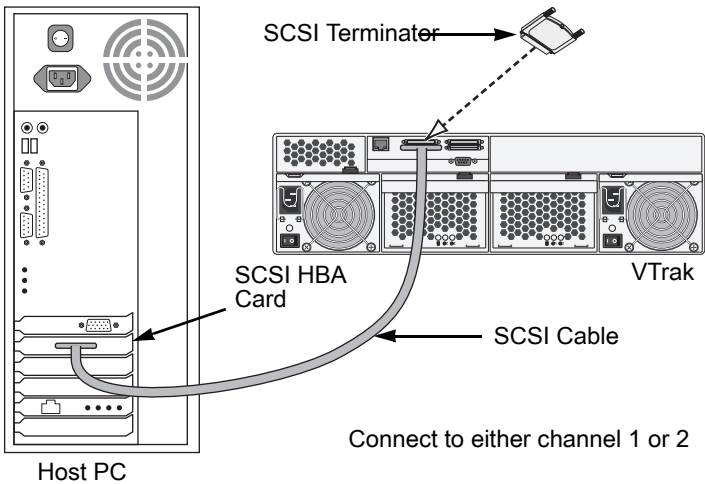

Figure 9. If you use a SCSI channel, attach a terminator to it

Configuration 1: One VTrak, one Host PC, one SCSI HBA card



Attach the SCSI cable to either of VTrak's SCSI channels.

Configuration 2: One VTrak, one Host PC, two SCSI HBA cards

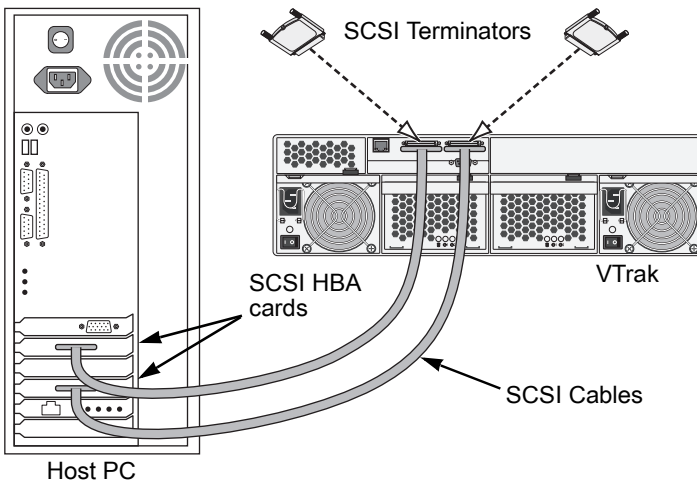

You can use a dual-channel SCSI HBA card for this application.

Configuration 3: One VTrak, two Host PCs, one SCSI HBA card in each

This arrangement allows you to manage the same VTrak from two different Host PCs.

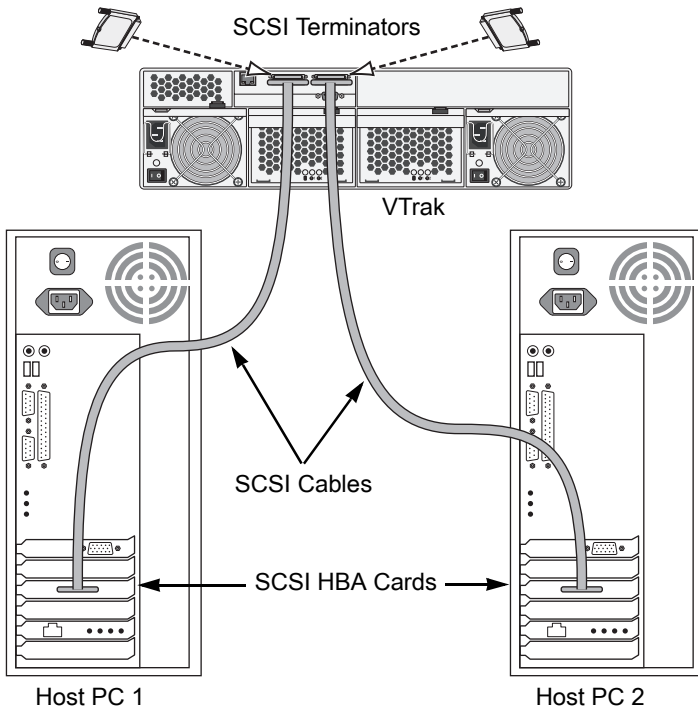

Configuration 4: Two VTraks, one Host PC, one SCSI HBA card (daisy chain)

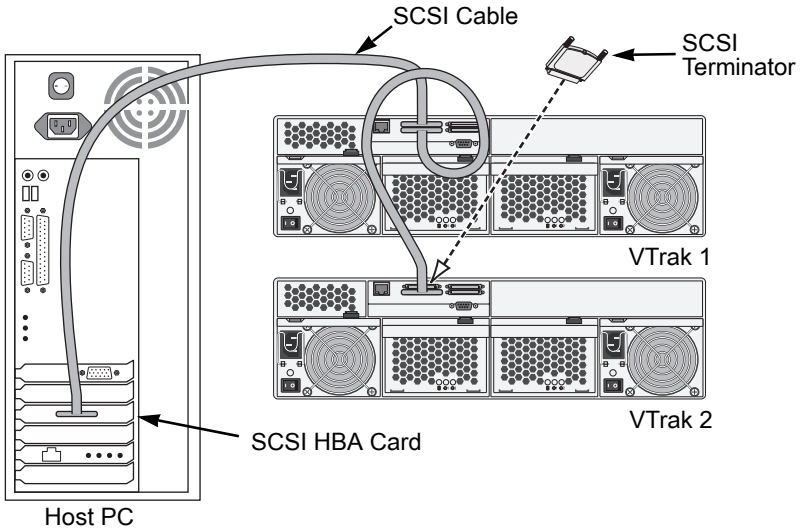

Do the following when daisy-chaining VTraks:

1. Use a 68-pin VHDCI cable to attach each VTrak array to the SCSI chain. You can connect up to eight (8) VTraks on the same SCSI chain.
2. Set a different SCSI Target ID for each VTrak.

For example, a daisy chain of six VTraks could have these assignments:

VTrak 1 Target ID 1
VTrak 2 Target ID 2
VTrak 3 Target ID 3
VTrak 4 Target ID 4
VTrak 5 Target ID 5
VTrak 6 Target ID 6

See page 98 (WebPAM PRO) or page 180 (CLU) for instructions how to set SCSI Target IDs.

3. Install a SCSI terminator on the last VTrak in the chain.

Configuration 5: Two VTraks, one Host PC, two SCSI HBA cards

A Host PC manages two VTraks through separate SCSI connections. An alternative to daisy chaining, it can provide increased I/O performance.

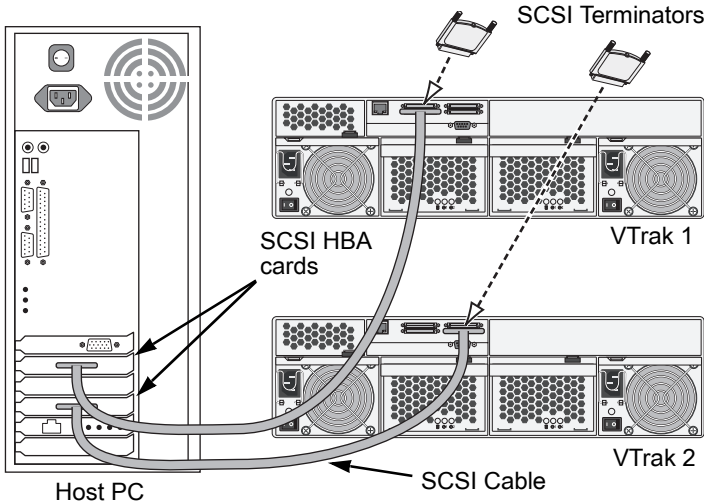

You can use a dual-channel SCSI HBA card for this application.

With one to eight VTraks connected to each SCSI HBA card, you can use as many SCSI HBA cards as your PC will support.

Connect the Management Cables

VTrak 15110 has two types of Management connections:

- Management Port connection – Enables you to monitor the VTrak over your network using the WebPAM PRO Software. VTrak supports Ethernet and Telnet protocols.
- RS-232 Serial connection – Enables the Command Line Utility (CLU) on your PC to monitor and control VTrak.

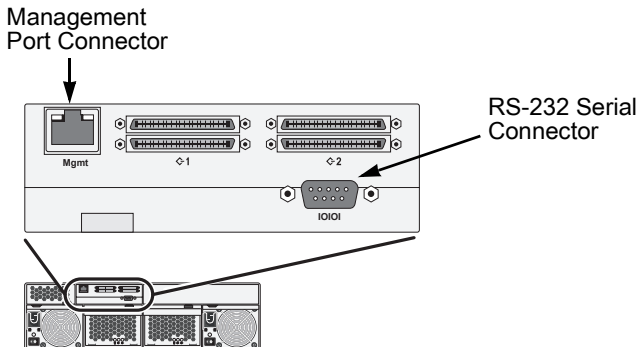

Figure 4. VTrak 15110 serial and network connections

Management Port Connection

The Network connection is for using WebPAM PRO over the network and also for using the CLU through a Telnet connection.

1. Arrange with your Network Administrator to provide a network connection for the VTrak.
2. Attach the network cable to the network connector on the VTrak..



Caution

Do not attempt to connect an Ethernet cable, regular or cross-over, directly between the VTrak and your PC. This is a network connection and requires a hub or switch.

RS-232 Serial Connection

The serial connection uses the null modem cable provided with the VTrak.

1. Attach the null modem cable to the RS-232 serial port on your PC.
2. Attach the other end of the null modem cable to the serial port on the VTrak.

Macintosh Users

If your Host PC is an Apple Macintosh, you do not have the RS-232 serial port needed to set-up a Management connection.

Promise has developed a Telnet utility for the Macintosh that establishes a Telnet connection between the Macintosh PC and the VTrak without an initial setup though an RS-232 serial connection. See Mac OS X on page 29 for more information.

As an alternative, obtain the following items to make a serial connection:

- A USB to DB-9 serial converter
- Terminal emulation software

Several manufacturers offer USB to DB-9 serial converters and cables. For terminal emulation software, go to:

<http://homepage.mac.com/dalverson/zterm/>

Download and install the ZTerm software onto your system.

Connect the Power



Warning

Power supplies can contain over 240 volts. This high voltage, if mishandled, can cause serious injury or death.

Do not touch or handle a power cable or power supply unless you have been trained and prepared to perform this task.

VTrak systems will operate on either 115 volts AC or 230 volts AC. The VTrak 15110 includes two replaceable power supply modules with autosense voltage selection and Power Factor Correction (PFC).

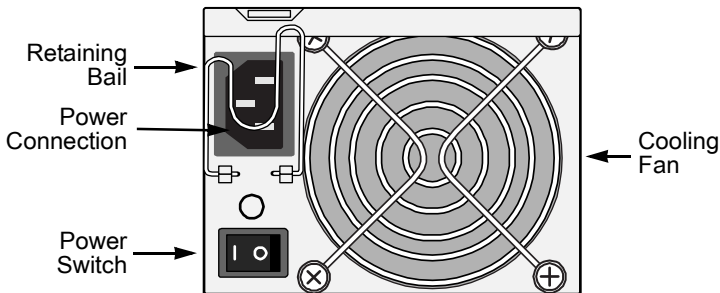

Figure 11. Power Connections and Switch

Plug the power cords into the power connections on both power supplies. Use the retaining bails to hold the power cords in place and prevent an accidental disconnection.

Turn both power supplies on.

When the power is switched on, the LEDs on the front of the VTrak will light up.

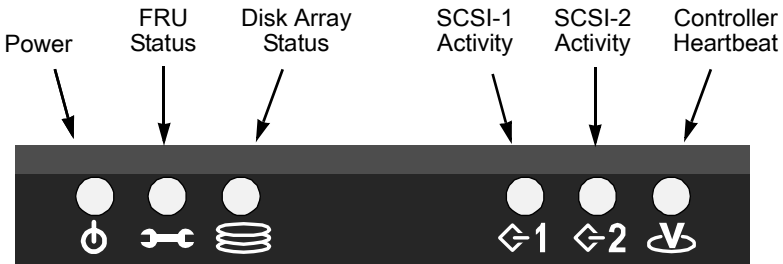

Figure 12. VTrak 15110 Displays

When boot-up is finished and the VTrak is functioning normally:

- Controller LED blinks green once per second for five seconds, goes dark for five seconds, then blinks green once per second for five seconds again.
- Power, FRU and Logical Drive LEDs display green continuously.
- SCSI LEDs flash green if there is activity on that channel.

There are two LEDs on each Drive Carrier. They report the presence of power and a disk drive, and the current condition of the drive.

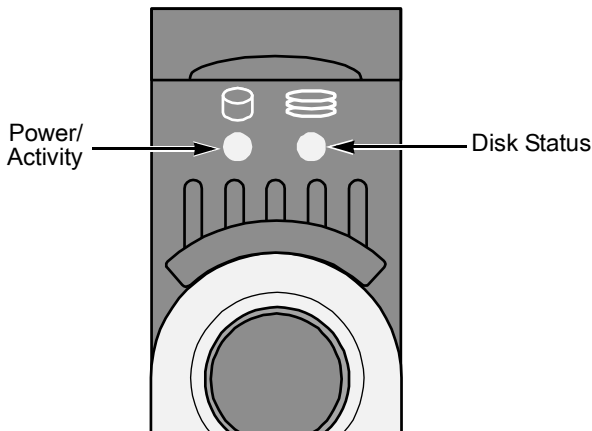

Figure 13. VTrak 15110 Disk Carrier LEDs

After a few moments the Power/Activity and Disk Status LEDs should display green.

If there is no disk drive in the carrier, the Disk Status LED will display green while the Power/Activity LED will remain dark.

Set-up Management Connections

As explained earlier, VTrak 15110 has two types of Management connections:

- Network – Supports the CLU and WebPAM PRO
- RS-232 Serial – Supports the CLU

The physical (cable) connections for these are described in an earlier section. If you have not made these connections, do so before continuing.

Use the following procedures to enable Management connections for VTrak. Terminal Emulation is required in all cases. The others are required depending on the Management connections you choose.

Terminal Emulation

Terminal emulation is the means of communication over an RS-232 serial connection. In the following procedure, you will establish a Terminal Emulation link between the Host PC and the VTrak.

Regardless of your choice of management connection, you must first establish a Terminal Emulation connection.

If you are using a Macintosh PC and have no provision for a RS-232 connection, see the instructions under Mac OS X on page 29.

1. Change your PC's COM Port settings to agree with the following:
 - Bits per second: 115200
 - Data bits: 8
 - Parity: None
 - Stop bits: 1
 - Flow control: none
2. Start your PC's terminal emulation program.
3. Press Enter once to launch the CLU.

The CLU Main Menu appears (below) and is ready to use.

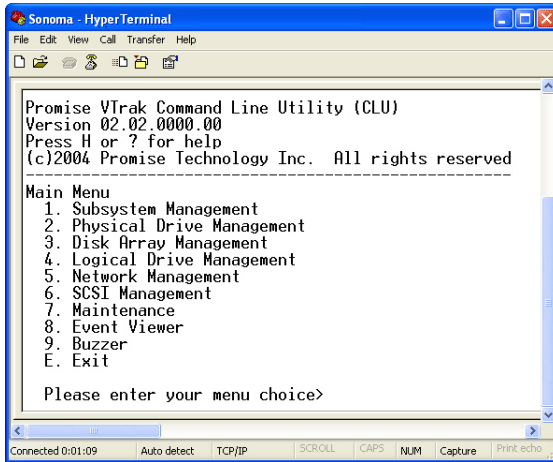

For a full list of CLU capabilities and functions, see Chapter 5 on page 133.

Set IP Addresses and Subnet Mask

This procedure is required for a network connection to the VTrak. In order for the network connection to work, you must set the IP addresses of the Management Port and Gateway, and set the Subnet Mask.

If you do not plan to use a network connection, you can skip to the next procedure.



Caution

Use of the DHCP feature on VTrak can result in losing network connection to the VTrak after a shutdown or power failure. For this reason, Promise recommends a static IP address.

To enable DHCP:

1. From the Network Management menu, press 1 and Enter to access the Management Port menu.
2. Press 1 and Enter to access DHCP.
3. Press Y and Enter to enable DHCP on VTrak.
4. Press Enter again to return to the Management Port menu.

To make settings manually:

1. From the Network Management menu, press 1 and Enter to access the Management Port menu.

The Management Port settings display.

```
-----
Management Port IP Address: 10.0.0.2
Subnet Mask: 255.0.0.0
Gateway IP Address: 0.0.0.0
Telnet: disabled
TFTP Server IP Address: 0.0.0.0
SNMP Name: Sonoma
SNMP Location: Promise
-----
```

```
Network Management
 1. Management Port
 2. Telnet
 3. TFTP Server
 4. SNMP
 5. Ping
 R. Return to previous menu
```

Please enter your menu choice>**1**

2. Press 1 and Enter to select Management Port.

```
-----
Management Port IP Address: 10.0.0.2
Subnet Mask: 255.0.0.0
Gateway IP Address: 0.0.0.0
-----
```

```
Management Port
 1. DHCP
 2. Management Port IP
 3. Subnet Mask
 4. Gateway
 R. Return to Previous Menu
```

Please enter your menu choice>**1**

3. Press 1 and Enter to change the management port IP address.

```
-----Configure Management Port IP address-----
```

```
Current management port IP Address: 10.0.0.2
Modify management port IP address(y/n)?>y
New management port IP address>192.168.1.56 (an example only)

New management port IP address: 192.168.1.56
```

Press Enter key to return

4. Press Y and Enter to modify the management port IP address.

5. Type the new IP address and press Enter.
The CLU confirms the new management port IP address.
6. Press Enter to return to the Management Port menu.
7. Repeat steps 3 though 6 to set the Subnet mask and Gateway IP address
8. Restart the VTrak.



Important

All three settings must be correct in order for WebPAM PRO to connect to the VTrak.

Set Up Telnet Connection

A Telnet connection allows you to access VTrak's CLU over the network. This allows RAID management over a greater distance from the VTrak itself.

This procedure is required for a Host PC that does not have an available RS-232 serial port.

The CLU screen looks and works exactly the same over a Telnet connection as it does over a serial connection.

Enable Telnet on VTrak

Telnet is the means of using the CLU over a network connection. VTrak's Telnet service is disabled by default. Follow these instructions to enable Telnet.

Windows and Linux

1. Connect the RS-232 cable between the Host PC and VTrak.
Refer to Step 7 on page 25 for the RS-232 settings and setup.
2. Launch HyperTerminal or Minicom.
3. In the CLU Main Menu, select Network Management > Telnet and choose Enable/disable Telnet.

This action enables the Telnet support.

Mac OS X

Since the Macintosh has no RS-232 port, you will enable the Telnet service through the network using a Telnet utility.

1. Download the Promise Telnet utility for Mac, file name *telnetenable.bin* and copy it to a convenient folder.
2. Open a Terminal window.
3. Change the file mode of *telnetenable.bin* to executable (example: **chmod 777 telnetenable**).
4. Ping the VTrak box over the network to be sure it is connected (example: **ping 10.0.0.2**).

VTrak's default Management port IP address is 10.0.0.2.

If the VTrak does not respond, take the necessary action to establish a network connection.

5. Launch the Telnet utility, and run **telnetenable** [IP address of the VTrak].
6. When you see "Telnet port enabled", run **telnet IP-address 2300**.

Use **./telnetenable IP-address** to enable the telnet port and **./telnetenable IP-address 0** to disable it.

Make a Telnet Connection

The Telnet feature on VTrak must be enabled. See “Enable Telnet on VTrak” on page 29.

HyperTerminal (Windows) or Minicom (Linux)

1. Launch the HyperTerminal or Minicom application.

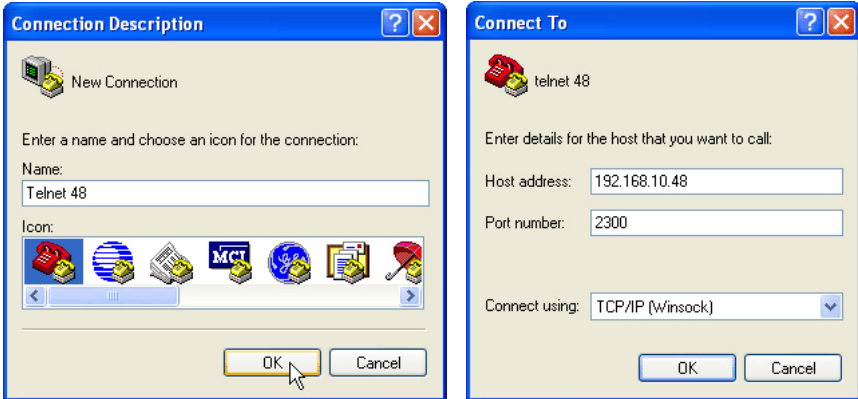

2. Open a terminal window, type a name and click **OK** (above, left).
3. In the Connect using dropdown menu, select *TCP/IP (Winsock)* (above, right).
4. In the Host address field, type the VTrak’s IP address.
5. In the Port number field, type **2300**.
6. Click **OK**.

The Telnet login window opens.

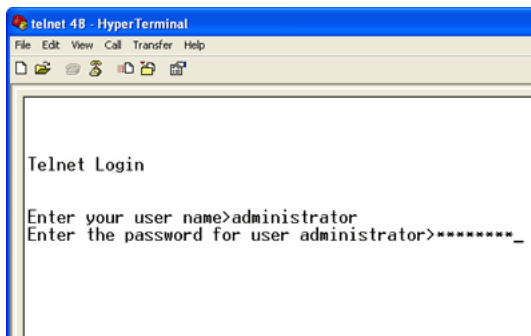

7. In the Telnet Login, type a user name (*administrator* is the default) and press **Enter**.

8. Type a password (*password* is the default) and press **Enter**.

```

telnet 4B - HyperTerminal
File Edit View Call Transfer Help

Promise VTrak Command Line Utility (CLU)
Version 02.02.0000.80
Press H or ? for help
(c)2004 Promise Technology Inc. All rights reserved
-----
Main Menu
 1. Subsystem Management
 2. Physical Drive Management
 3. Disk Array Management
 4. Logical Drive Management
 5. Network Management
 6. SCSI Management
 7. Maintenance
 8. Event Viewer
 9. Buzzer
 E. Exit

Please enter your menu choice>_

Connected 0:00:29 Auto detect TCP/IP SCROLL CAPS NUM Capture Print echo

```

The CLU screen opens. See Chapter 5 (page 133) for information about how to use the CLU.

Command Line (Windows) or Terminal Icon (Linux)

1. Go to the Windows command line or click the Linux terminal icon.

```

Command Prompt
Microsoft Windows XP [Version 5.1.2600]
(C) Copyright 1985-2001 Microsoft Corp.

C:\Documents and Settings\danield>telnet_

```

2. Type **telnet** and press **Enter**.

```

Command Prompt - telnet
Welcome to Microsoft Telnet Client
Escape Character is 'CTRL+J'

Microsoft Telnet> o 192.168.10.48 2300_

```

3. Type a lower-case letter O, space, the VTrak's IP address, space, 2300.
Example: o 192.168.10.48 2300
4. Press **Enter**.
The telnet login screen appears.

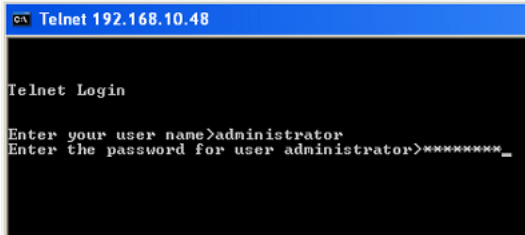

```
CA Telnet 192.168.10.48

Telnet Login

Enter your user name>administrator
Enter the password for user administrator>*****_
```

5. In the Telnet Login, type a user name (*administrator* is the default) and press **Enter**.
6. Type a password (*password* is the default) and press **Enter**.

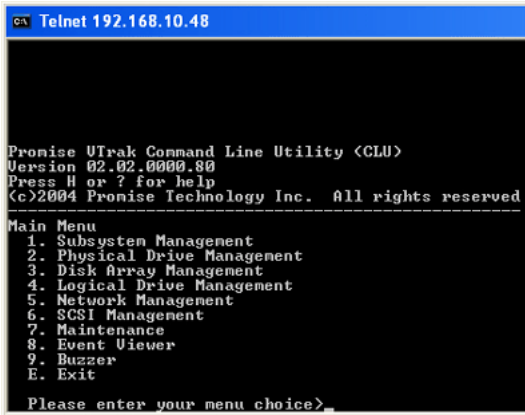

```
CA Telnet 192.168.10.48

Pronise UTrak Command Line Utility <CLU>
Version 02.02.0000.80
Press H or ? for help
(c)2004 Pronise Technology Inc. All rights reserved
-----
Main Menu
1. Subsystem Management
2. Physical Drive Management
3. Disk Array Management
4. Logical Drive Management
5. Network Management
6. SCSI Management
7. Maintenance
8. Event Viewer
9. Buzzer
E. Exit
Please enter your menu choice>_
```

The CLU screen opens. See Chapter 5 (page 133) for information about how to use the CLU.

Install WebPAM PRO Software

Web-Based Promise Array Management—Professional (WebPAM PRO) software provides a browser-based graphic user interface used to monitor and manage VTrak and its logical drives. Because it works over your network, it can monitor and control multiple VTraks. WebPAM PRO consists of two components:

- Utility Server – WebPAM PRO software you install
- CIMOM Agent – WebPAM PRO component preinstalled on the VTrak

Utility Server Installation Locations

When you install WebPAM PRO, you are installing the *Utility Server*. Where you install WebPAM PRO depends on your management connection. If you plan to use the VTrak Management (network) port, there are three possible locations.

- A networked PC
- A network file server
- The Host PC

Installation Guidelines

When you install WebPAM PRO on a network, follow these rules.

- Install the Utility Server only on a PC or Server that is permanently connected to your network.
- Install only one instance of the Utility Server on your network.

Operating System Support

On the PC or server where you install WebPAM PRO, Promise Technology recommends:

- Windows 2000
- Windows XP Professional
- Windows 2003
- RedHat Linux
- SuSE Linux
- Mac OS X
- Solaris 9

The Utility Server supports these operating systems. Choose one of them to take full advantage of all the features of WebPAM PRO.

CIMOM Agent

VTrak ships from the factory with a CIMOM agent installed..

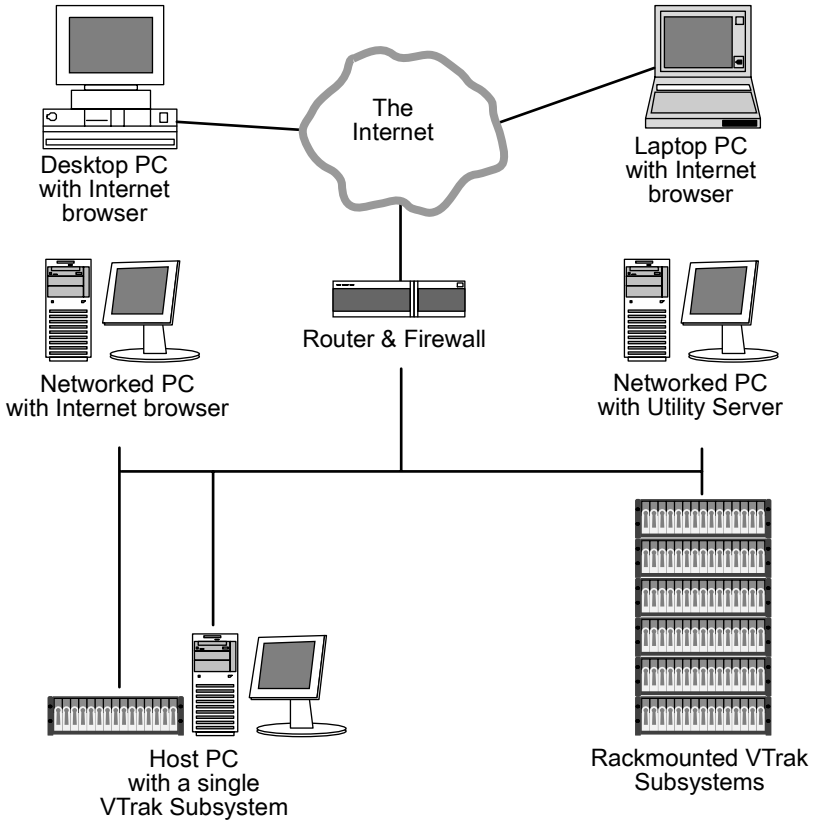

Figure 7. WebPAM PRO on a network

Internet Browser

Typically an Internet browser comes with your operating system. WebPAM PRO does not include a browser. For computers that will remotely monitor and manage the RAID, the Internet Browser is the only software required.

Your Internet Browser provides the means for you to monitor and configure your Promise RAID products using WebPAM PRO. You can use the most recent versions of either Internet Explorer or Netscape Navigator.

Before you start...

1. Obtain the IP addresses of these devices:
 - The PC or server where you plan to install WebPAM PRO
 - The VTrak(s) you plan to monitor
2. If you are planning to use other applications that rely on JRE or JDK, always install them first before you install WebPAM PRO. WebPAM PRO will use the existing JRE rather than installing a second one.

WebPAM PRO will install JRE 1.4 on your system unless you already have JRE or JDK versions 1.3.0 or 1.4.

Install WebPAM PRO

Windows

Follow these steps to install WebPAM PRO on your Windows-based PC or Server.

1. Boot up the PC/server and launch Windows.
If the computer is already running, exit all programs.
2. Insert the software CD into your CD-ROM drive.
3. Double-click on the Install CD's icon to open it.
4. Double-click on the Installer icon to launch it (right).

The first WebPAM PRO installation dialog box appears, as shown on page 37.



Linux

Follow these steps to install WebPAM PRO on your Linux-based PC or Server.

1. Boot up the PC/server and launch the Linux GUI.
If the computer is already running, exit all programs.

2. Insert the software CD into your CD-ROM drive.
3. In the CD window, double-click on the **webpam...bin** icon to begin installation (right).
4. When the Run or Display? dialog box appears, click *Run in Terminal*.



webpamxxxx.bin

After several moments, the Terminal window closes and the first WebPAM PRO installation dialog box appears, as shown on the next page.

Mac OS X

Follow these steps to install WebPAM PRO on your Mac OS X-based PC or Server.

1. Boot up the PC/server and launch Mac OS X.
If the computer is already running, exit all programs.
2. Insert the software CD into your CD-ROM drive.
3. Double-click on the Install CD's icon to open it.
4. Double-click on the Installer icon to launch it (right).



The first WebPAM PRO installation dialog box appears, as shown on the next page.

Solaris

Follow these steps to install WebPAM PRO on your Solaris-based PC or Server.

1. Boot up the PC/server and launch Solaris.
If the computer is already running, exit all programs.
2. Insert the software CD into your CD-ROM drive.
3. Open a Terminal Console (window).
4. Navigate to the Solaris folder on the CD.
5. Type **ls** and press **Enter** to verify the name of WebPAM installer file.
6. Type **sh webpam...bin** (use the actual file name) and press Enter to begin installation.

The first WebPAM PRO installation dialog box appears, as shown on the next page.

Installation Under All Supported Operating Systems, continued

In the following examples, the Windows install screens are shown. Linux and Mac OS X install screens have a slightly different appearance but the information, choices and actions required are exactly the same.

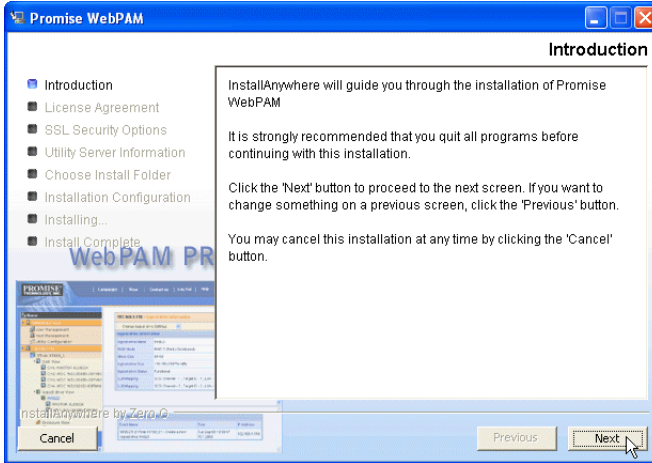

1. When the Introduction screen appears (above), click the Next button.

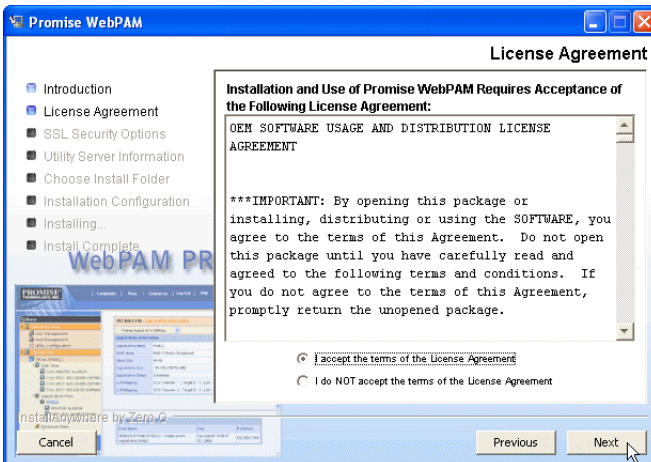

2. When the License Agreement appears (above), click the "I accept the terms..." radio button, then click the Next button.
If you do not accept the terms of the Agreement, the installation will stop.

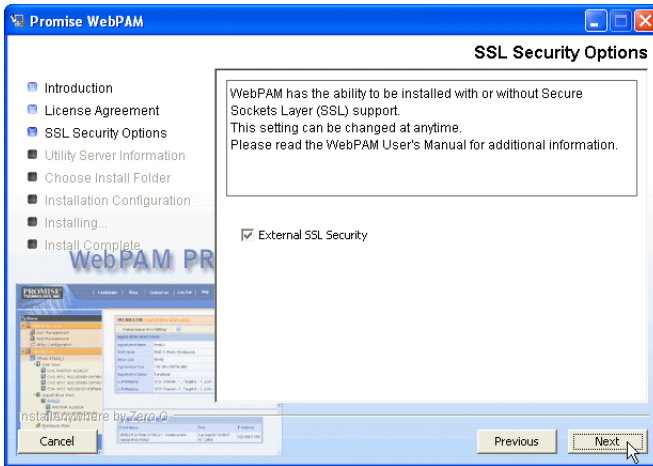

3. When the SSL Security Options screen appears (above), you can check External Security. An explanation follows.

External SSL Security – Applies security to all connections involving the Internet or outside your company firewall.

Security options are invisible to authorized users.

Promise Technology provides a default certificate for the server as well as for internal data communication. However, in some cases it is always better to install and verify your own certificate for the webserver. And if possible, verify certificate by certificate authority like Verisign or Thwate. See your MIS Administrator for guidance.

Click the **Next** button when you have made your choice.

4. When the Utility Server Information screen appears (below), type the requested network addresses.

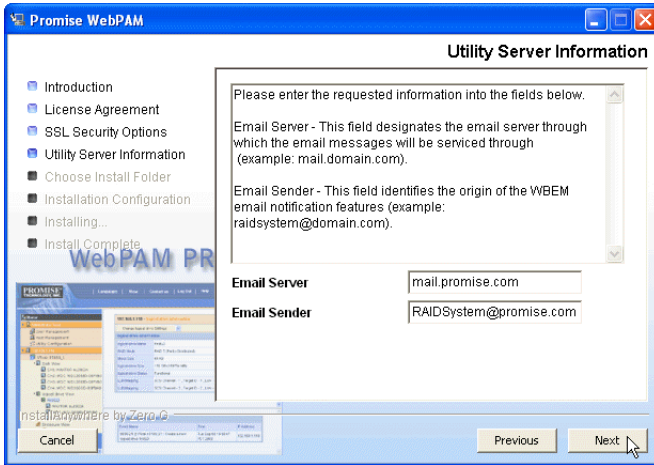

You must type the correct information for Email Server and Email Sender or the installation will not proceed.

Email Server – Type in the name of your company's email server.

Email Sender – Type in the email address of the person responsible for maintaining the RAID. This address will be the return address on all email notifications sent from the Utility Server to all recipients.

Click the **Next** button when you are finished.

- When the Choose Install Folder screen appears (below), make your selection of a folder for the WebPAM PRO applications you are installing.

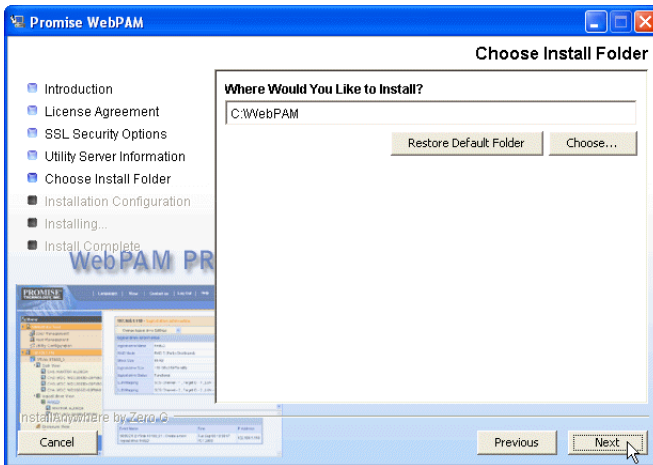

The default folder is **C:\WebPAM**. If you want a different folder, type its location and click the **Choose...** button.

If you change your mind and want the default location, click on the Restore Default Folder button.

Click the **Next** button when you are finished.

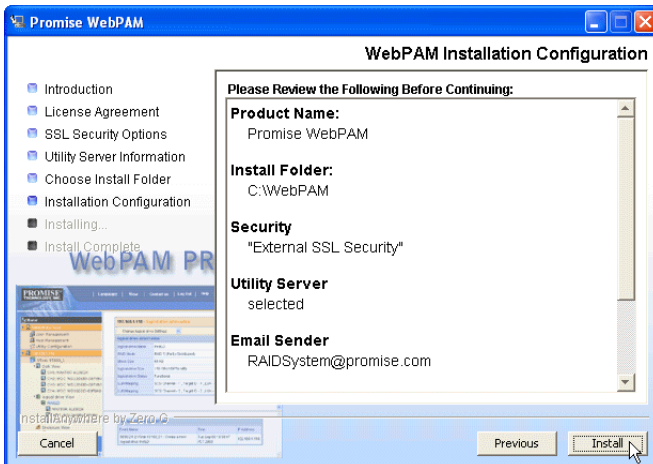

- When the WebPAM PRO Installation Configuration screen appears (above), take a moment to review your choice of install folder and the available disk space on the target hard drive.

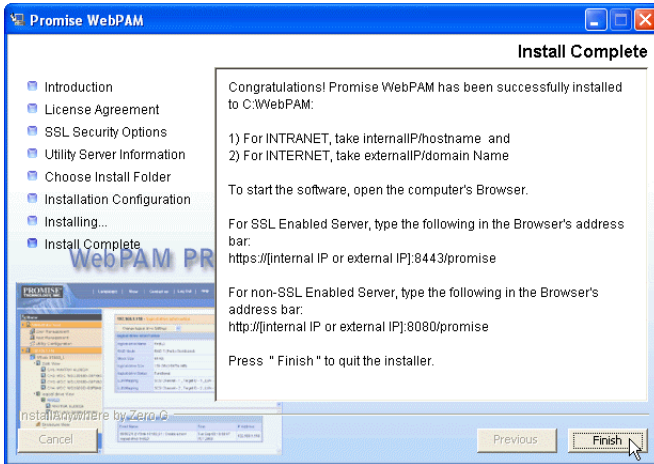

- If you need to make changes, click the Previous button to return to the Install Folder screen.
 - If you are satisfied with the proposed installation, click the Install button.
7. When the Install Complete screen appears (above), the installation process is finished. Click the Finish button to go to the Promise Registration website.



Important

Registration of your VTrak and WebPAM PRO provides useful information that helps Promise Technologies to offer better products and support. Please take a few minutes to register. Thanks!

This completes the WebPAM PRO installation.

Chapter 3: Setup

- VTrak Setup with WebPAM PRO (below)
 - VTrak Setup with the CLU (page 57)
-

After installation, the next step is to configure VTrak. You can do this with WebPAM PRO or the Command Line Utility (CLU), whichever you prefer.

This Chapter only deals with basic functions needed to setup a new VTrak. For a full discussion of VTrak functions, refer to WebPAM PRO on page 65 and the CLU on page 133.

VTrak Setup with WebPAM PRO

Set up with WebPAM PRO consists of the following steps:

1. Log-in to WebPAM PRO (below)
2. Add a Subsystem (VTrak) (page 46)
3. Access a Subsystem (VTrak) (page 46)
4. Create a Disk Array (page 48)
5. Create a Logical Drive (page 54)
6. Assign a SCSI Target ID (page 55)
7. Log-out of WebPAM PRO (page 56)

Log-in to WebPAM PRO

1. Launch your Browser.
2. In the Browser address field, type in the IP address of the PC/Server where you installed WebPAM PRO, as explained below. Do not type the VTrak's IP address.

If you did *not* choose the External Security option during WebPAM PRO installation, use the *Regular* connection.

If you chose the External Security option during WebPAM PRO installation, use the *Secure* connection.

Regular Connection

- WebPAM PRO uses an HTTP connection http://
- Enter the PC/Server's IP address 192.168.10.46
- Enter the Port number :8080
- Add to launch WebPAM PRO /promise

Together, your entry looks like this:

http://192.168.10.46:8080/promise

Secure Connection

- WebPAM PRO uses a secure HTTP connection :https://
- Enter the PC/Server's IP address 192.168.10.46
- Enter the Port number :8443
- Add to launch WebPAM PRO /promise

Together, your entry looks like this:

https://192.168.10.46:8443/promise

Note that the IP address shown above is only an example. The IP address you type into your browser will be different.



3. When the opening screen appears, log in as **administrator** and type in the default password, which is **password**. The login and password are case sensitive.
4. Click the Sign in button.



Important

Immediately after installation, change the Administrator's password. Make the change under User Management. Each user you create will have his/her own login ID and password.



Note

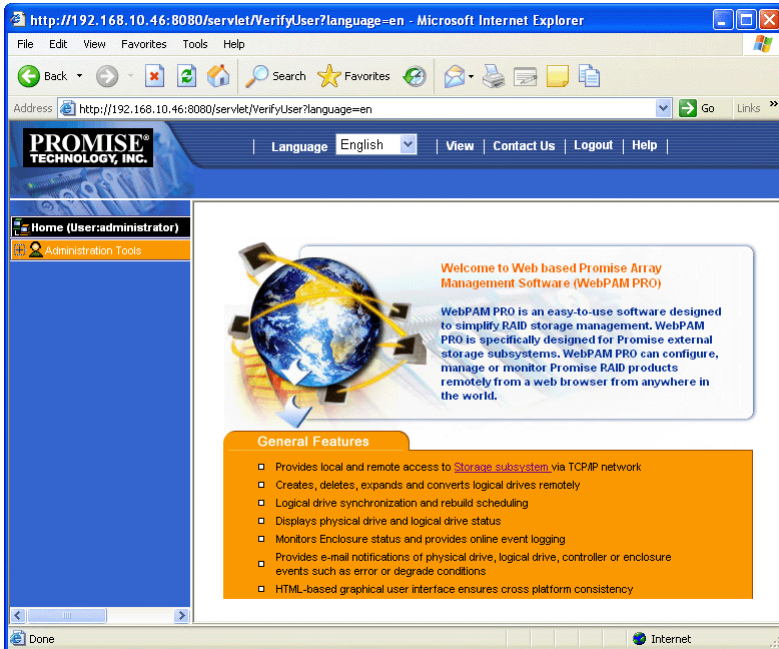

Make a Bookmark (Netscape Navigator) or set a Favorite (Internet Explorer) of the Login Screen so you can access it easily next time.

After sign-in, the WebPAM PRO opening screen appears.



The first time you log in to WebPAM PRO, there will be no Subsystems (VTraks) or Users in the system. Promise recommends that you create the Subsystem(s) first, then add the User(s).

Add a Subsystem (VTrak)

1. Click on Administrator Tools  icon to display the menu.
2. Click on the Subsystem Management  icon.

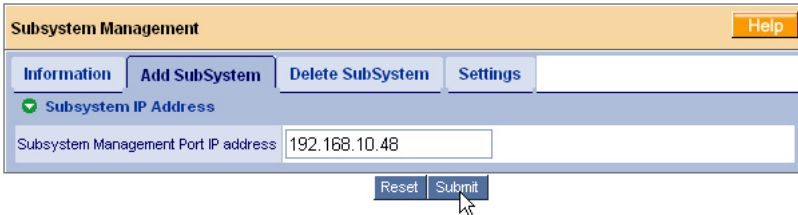



3. Click the Add Subsystem tab (above).
4. In the IP Address field, type in the VTrak's Management Port IP address. Do not type the PC/Server's IP address.
5. When you are done, click the **Submit** button.

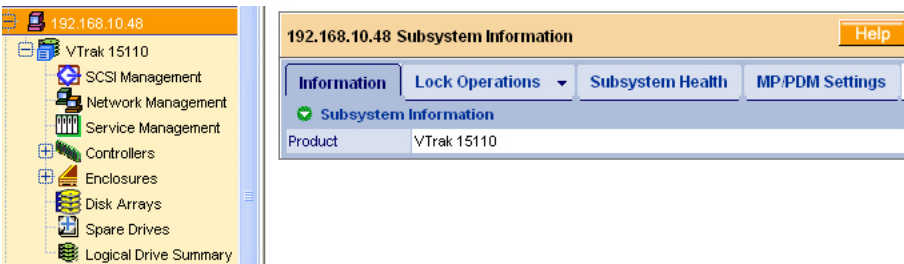

The new Subsystem is added to Subsystem Management and also appears in the Information tab.

Access a Subsystem (VTrak)

The WebPAM PRO CIMOM Agent resides on the VTrak and sends the monitoring data to the Utility Server and on to the Browser. In Tree View, a newly created Subsystem looks like this:



Each Subsystem (VTrak) is identified by an  icon and its IP Address. Below it, the VTrak Subsystem  icon appears. A Subsystem is made up of:

-  SCSI Management – SCSI TIDs
-  Network Management – Management port connection



Service Management – SNMP, Telnet and CIM services



Controllers – RAID Management on VTrak



Enclosures – Power supplies, cooling, cache battery, circuit cards



Disk Arrays – Creation and management of disk arrays and logical drives



Spare Drives – Physical drives assigned as global or dedicated hot spares





Logical Drive Summary – A list of all logical drives in this enclosure, regardless of the disk array to which they belong

If you do not see these details in the Tree View, it means your network connection to VTrak is not working. Restore your connection before proceeding.

If you do not see anything, lower your browser's security settings.

Create a Disk Array

A disk array is a collection of physical drives in a RAID. Logical drives are made from disk arrays. To access the Disk Array tab:

1. Click on the Subsystem  icon in Tree View.
2. Click on the VTrak  icon.
3. Click on the Disk Arrays  icon.
4. Click on the Create tab.

There are three ways to create a new disk array:

- **Automatic** – Creates a new disk array following a default set of parameters. Makes one logical drive automatically
- **Express** – You choose the parameters for a new disk array by specifying the characteristics you want. You can create multiple logical drives at the same time, however they will all be identical
- **Advanced** – You directly specify all parameters for a new disk array. Makes one logical drive automatically. You can create additional logical drives at a later time

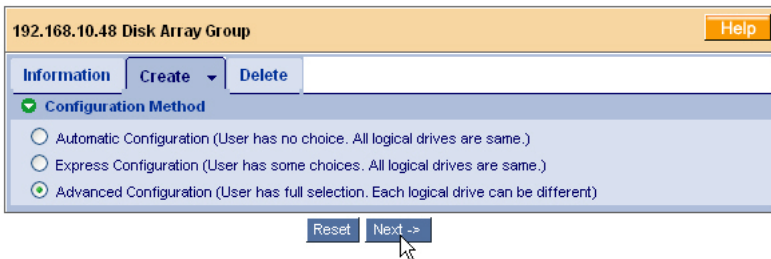

Click the radio button of the method you want then click the **Next** button.

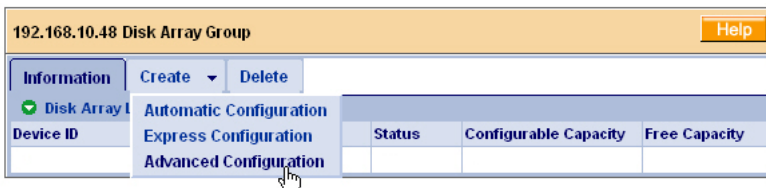

Or select one of these methods from the dropdown menu in the Create tab.

Automatic Option

The Disk Array Automatic Creation option enables you to create a new disk array following a default set of parameters. One logical drive will be made automatically when you create the disk array.

The screenshot shows a web-based configuration interface for a '192.168.10.48 Disk Array Group'. It features a 'Help' button in the top right corner and three main tabs: 'Information', 'Create', and 'Delete'. The 'Create' tab is active, displaying configuration options for 'Disk Arrays' and 'Logical Drives'. Under 'Disk Arrays', the parameters are: Number of Physical Drives (6), Physical Drive Slot Nos (2 6 7 8 10 14), Configurable Capacity (641 GB), and Number of Logical Drives (1). Under 'Logical Drives', a table shows one drive with RAID Level 5, Capacity 641 GB, and Stripe Block Size 64 KB. Under 'Spare Drives', the Physical Drive Slot Nos are set to 11. A 'Submit' button is located at the bottom center of the form.

192.168.10.48 Disk Array Group			
Information Create Delete			
✓ Disk Arrays			
Number of Physical Drives	6		
Physical Drive Slot Nos	2 6 7 8 10 14		
Configurable Capacity	641 GB		
Number of Logical Drives	1		
✓ Logical Drives			
#	RAID Level	Capacity	Stripe Block Size
1	RAID 5	641 GB	64 KB
✓ Spare Drives			
Physical Drive Slot Nos	11		

Submit

When you choose the Automatic option, the following parameters display:

- **Disk Arrays** – The number of physical drives in the disk array, their ID numbers, configurable capacity and the number of logical drives to be created
 - **Logical Drives** – The ID number of the logical drive(s), their RAID level, capacity and stripe size
 - **Spare Drives** – The physical drive ID number of the dedicated hot spare assigned to this disk array
1. Review the parameters. If you accept them, proceed to the next step.
If you do NOT accept these parameters, use the Express or Advanced option to create your disk array.
 2. When you are done, click the **Submit** button.

The new disk array appears in the Disk Array List on the Information tab.

Proceed to logical drive creation (page 48).

Express Option

The Disk Array Express Creation option enables you to choose the parameters for a new disk array by specifying the characteristics you want. With this method, you can create multiple logical drives at the same time you create your disk array. However, all of the logical drives will be the same.

192.168.10.48 Disk Array Group
Help

Information
Create ▾
Delete

✔ Disk Arrays

Redundancy	<input checked="" type="checkbox"/>
Capacity	<input type="checkbox"/>
Performance	<input checked="" type="checkbox"/>
Spare Drive	<input checked="" type="checkbox"/>
Number of Logical Drives	<input type="text" value="1"/>
Application Type	File Server ▾
Automatic Update	<input checked="" type="checkbox"/> Update

✔ Disk Arrays

Number of Physical Drives	9
Physical Drive Slot Nos	2 5 6 7 8 9 10 11 14
Configurable Capacity	804 GB
Number of Logical Drives	1

✔ Logical Drives

#	RAID Level	Capacity	Stripe Block Size
1	RAID 50	804 GB	64 kB

✔ Spare Drives

Physical Drive Slot Nos	3
-------------------------	---

Reset
Submit

To create a new disk array:

1. Check the boxes to select any one or combination of the following:
 - Redundancy – The array will remain available if a physical drive fails
 - Capacity – The greatest possible amount of data capacity
 - Performance – The highest possible read/write speed
 - Spare Drive – A hot spare drive

2. In the Number of Logical Drives field, enter the number of logical drives you want to make from this disk array.
 The maximum possible number of logical drives appears to the right of this field.

3. From the Application Type menu, select an application that best describes your intended use for this disk array: File Server
 - Video Stream
 - Transaction Data
 - Transaction Log

- Other
4. Click the Update button.
Or check the Automatic Update box and updates will occur automatically.
The following parameters display:
 - Disk Arrays – The number of physical drives in the disk array, their ID numbers, configurable capacity and the number of logical drives to be created
 - Logical Drives – The ID number of the logical drive(s), their RAID level, capacity and stripe size
 - Spare Drives – The physical drive ID number of the dedicated hot spare assigned to this disk array
 5. If you accept these parameters, proceed to the next step.
If you do NOT accept these parameters, review and modify your selections in the previous steps.
 6. When you are done, click the **Submit** button.

The new disk array appears in the Disk Array List on the Information tab.

Proceed to logical drive creation (page 48).

Advanced Option

The Disk Array Advanced Creation option enables you to directly specify all parameters for a new disk array. One logical drive will be made automatically when you create the disk array. If you select less than the total available capacity, you can use the remaining space to create additional logical drives at a later time.

To create a new disk array:

1. Enter a name for the disk array in the field provided.
2. Check the box to enable initialization, if desired.
 If you checked the initialization box, select the type of initialization from the dropdown menu.
 - **Quick** – Erases the reserve sectors of the physical drives being added to the disk array.
 - **Full** – Erases all sectors of the physical drives being added to the disk array.
3. Highlight physical drives you want in the disk array from the Available list and press the >> button to move them to the Selected list.
 You can also double-click them to move them.
4. When you are done, click the **Next** button.

5. Choose a RAID level from the dropdown menu.
 The choice of RAID levels depends on the number of physical drives you selected.
6. Specify a Capacity and the unit of measure (MB, GB, TB).
 This value will be the data capacity of the first logical drive in your new disk array. If you specify less than disk array's maximum capacity, the remainder will be available for additional logical drives which you can create later.
7. Specify a Stripe size from the dropdown menu.
 4, 8, 16, 32 and 64 KB are available, 64 KB is the default.
8. Click the **Next** button.
 The Creation Summary lists the disk array information you specified.

192.168.10.48 Disk Array Group
Help

Information
Create ▾
Delete

✔ **Disk Array Creation Summary**

Disk Array Alias	FirstDA
Number of Physical Drives	4
Physical Drive Slot Nos	3 4 8 12
Configurable Capacity	100 GB
Free Capacity	257 GB

✔ **New Logical Drives**

Alias	RAID Level	Capacity	Stripe	Sector
FirstDA	5	100 GB	64 KB	





← Back
Submit

9. If you accept these parameters, proceed to the next step.
If you do NOT accept these parameters, review and modify your selections in the previous steps.
 10. When you are done, click the **Submit** button.
- The new disk array appears in the Disk Array List on the Information tab.
Proceed to logical drive creation (next page).

Create a Logical Drive

When you create a disk array (see page 48), you automatically create one logical drive also. If the initial logical drive used less than the full capacity of the disk array, you can create additional logical drives from the same disk array.

To access the Disk Array – Create LD tab:

1. Click on the Subsystem  icon in Tree View.
2. Click on the VTrak  icon.
3. Click on the Disk Arrays  icon.
4. Click on the Disk Array  icon.
5. Click on the Create LD tab.

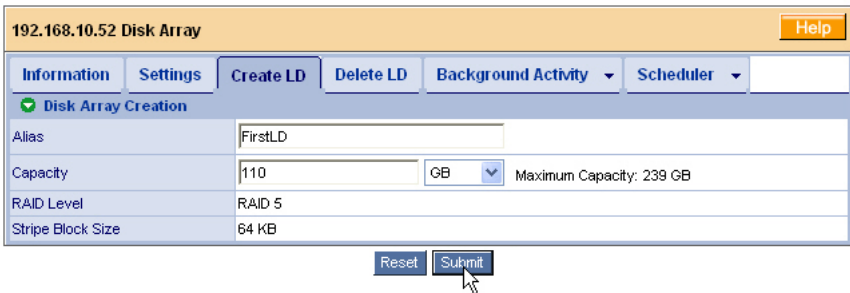

The screenshot shows a web interface for configuring a logical drive. The title bar reads '192.168.10.52 Disk Array' with a 'Help' button. Below the title bar are tabs: 'Information', 'Settings', 'Create LD' (selected), 'Delete LD', 'Background Activity', and 'Scheduler'. A green checkmark and the text 'Disk Array Creation' are visible. The form contains the following fields:

Alias	<input type="text" value="FirstLD"/>		
Capacity	<input type="text" value="110"/>	<input type="text" value="GB"/>	Maximum Capacity: 239 GB
RAID Level	RAID 5		
Stripe Block Size	64 KB		

At the bottom of the form are two buttons: 'Reset' and 'Submit'. A mouse cursor is pointing at the 'Submit' button.

To create a logical drive:

1. Enter an alias (name) in the field.
2. Select a RAID level from the dropdown menu.
3. Enter a capacity and select unit of measure (MB, GB, TB).
The default value is the available capacity of the disk array. You can use this value or any lesser amount.
4. Select stripe block size from the dropdown menu.
5. Select (cache) Read Policy from the dropdown menu.
6. Select (cache) Write Policy from the dropdown menu.
7. Click the **Update** button when you are done.
The new logical drive appears in the list.
8. Click the **Next** button.
9. Verify your settings then click the **Submit** button.

The new logical drive appears in the Logical Drive List on the Information tab.

In order to use this logical drive to read and write data, you must partition and format it using the Host PC's operating system.



Assign a SCSI Target ID

The term *Target ID* refers to the SCSI address of the two channels on the RAID subsystem. A SCSI bus has an Initiator, such as the SCSI card inside the Host PC, and at least one Target, such as the Controller and Logical Drives inside the RAID subsystem. Each target must have its own address or Target ID number.

Target IDs can be divided into Logical Unit Numbers (LUNs) to extend the number of available addresses. The default TID settings for both SCSI channels is 0. This setting is adequate for most WebPAM and RAID subsystem configurations. If an address conflict occurs, you might have to change the TID setting.

You must have Creation Rights to access this function.

To access SCSI Target ID settings:

1. Click on the Subsystem  icon in Tree View.
2. Click on the VTrak  icon.
3. Click on the SCSI Management  icon.
4. Click on the TID Settings tab.

192.168.10.48 SCSI Management

Information	LUN Settings	TID Settings	Statistics
<div style="display: flex; align-items: center;"> ✔ TID Settings </div>			
SCSI Channel	Select New Target IDs		
1	<input type="checkbox"/> 0 <input type="checkbox"/> 1 <input type="checkbox"/> 2 <input type="checkbox"/> 3 <input type="checkbox"/> 4 <input type="checkbox"/> 5 <input type="checkbox"/> 6 <input type="checkbox"/> 7 <input type="checkbox"/> 8 <input type="checkbox"/> 9 <input type="checkbox"/> 10 <input type="checkbox"/> 11 <input type="checkbox"/> 12 <input type="checkbox"/> 13		
2	<input type="checkbox"/> 0 <input type="checkbox"/> 1 <input type="checkbox"/> 2 <input type="checkbox"/> 3 <input type="checkbox"/> 4 <input type="checkbox"/> 5 <input type="checkbox"/> 6 <input type="checkbox"/> 7 <input type="checkbox"/> 8 <input type="checkbox"/> 9 <input type="checkbox"/> 10 <input type="checkbox"/> 11 <input type="checkbox"/> 12 <input type="checkbox"/> 13		
<div style="display: flex; justify-content: center; gap: 10px;"> <input type="button" value="Reset"/> <input type="button" value="Submit"/> </div>			

To make settings:

1. Select the SCSI Target IDs you want to use on SCSI Channel 1.
2. Select the SCSI Target IDs you want to use on SCSI Channel 2.
3. Click the **Submit** button when you are done.



Caution

Conflicting ID numbers can prevent WebPAM from connecting to the RAID subsystem and/or cause the SCSI HBA BIOS not to recognize the Logical Drives. Promise offers a sufficient quantity of TIDs and LUNs to avoid any conflict problems.



Note

The quantity and ID number of Target IDs you select depends in part upon how many logical drives you plan to create, how your Host PC and RAID subsystem are connected, and how many addresses are on the SCSI bus.

Log-out of WebPAM PRO

There are two ways to log out of WebPAM PRO:

- Close your browser window
- Click Logout on the WebPAM PRO banner (below)



After logging out, you must enter your username and password to log in again. Clicking Logout brings you back to the Login Screen.

Internet Connection using WebPAM PRO

The above instructions cover connections between VTrak and WebPAM PRO over your company network. It is also possible to connect to a VTrak from the Internet.

Your MIS Administrator can tell you how to access your network from outside the firewall. Once you are logged onto the network, you can access the VTrak using its IP address.

Please note that only the PC with the SCSI connection can read and write data to the logical drives on the VTrak. However, other PCs can monitor the VTrak from virtually any location.

VTrak Setup with the CLU



Notes

- If you worked through the Setup procedure above using WebPAM PRO, your VTrak setup is complete. There is no need to repeat the Setup with the CLU.
- See Chapter 5 for a full explanation of the CLU functions.

Set up with the CLU consists of the following steps:

1. CLU Connection (below).
2. Create a Logical Drive
 - Automatically (page 58)
 - Manually (page 59)
3. Assign a SCSI Target ID (page 63).
4. Exit the CLU (page 64).

CLU Connection

Before you begin, be sure the null modem cable is connected between the Host PC and VTrak, and that both machines are booted and running.

1. Start your PC's terminal emulation program.

```

Fontana - HyperTerminal
File Edit View Call Transfer Help
[Icons]
-----
Promise VTrak Command Line Utility (CLU)
Version 02.02.0000.79
Press H or ? for help
(c)2004 Promise Technology Inc. All rights reserved
-----
Main Menu
1. Subsystem Management
2. Physical Drive Management
3. Disk Array Management
4. Logical Drive Management
5. LUN Mapping and Masking
6. Network Management
7. Fiber Channel Management
8. Maintenance
9. Event Viewer
a. Buzzer
E. Exit

Please enter your menu choice>
-----
Connected 0:01:09 Auto detect TCP/IP SCROLL CAPS NUM Capture Print echo ...
  
```

2. Press Enter once to launch the CLU.

Create a Disk Array

The following procedures provide the basic steps needed to create a disk array and a logical drive to get your VTrak running quickly.

You can create your disk array automatically or manually. You might prefer to let VTrak to create the disk array automatically if you are new to RAID technology or you are satisfied with VTrak's default settings.



Note

When VTrak creates a disk array automatically, it will use all available physical drives. If you want to create multiple disk arrays, use the manual creation function.

Create a Disk Array Automatically

Use this feature to quickly build a disk array using all available disk drives. You specify the RAID level. The other options are chosen automatically. See Chapter 7, page 214 for a discussion of RAID Levels and the number of drives each supports.

1. From the Main menu, press 3 and Enter to access Disk Array Management.
2. Press 1 and Enter to access the Disk Array Auto Creation.

```
*****Logical Drive Auto Creation*****
```

```
Total --6-- free Physical Drives
```

```
RAID Mode Options:
```

- 0 - RAID 0 (Striping)
- 1 - RAID 1 (Mirroring)
- 3 - RAID 3 (Parity)
- 5 - RAID 5 (Parity Distributed)
- 10 - RAID 10 (Striping/Mirroring)
- 50 - RAID 50

```
Please enter RAID mode(0,1,3,5,10,50)>50
```

The Auto Creation tells you how many disk (physical) drives are free and which RAID modes (levels) are possible.

3. Type the RAID mode you want and press Enter.

The proposed specifications for the new logical drive appear

```
Logical Drive Auto Creation Information:
```

```
Name: LogicalDrive
```

```
Number of Physical Drives: 6
```

```
RAID mode: RAID 50
```

```
Stripe block size: 64KB
```

SMART check: enabled

Initialization: full

Create Logical Drive now(y/n)?>y

- If you agree with the specifications, press Y and Enter.
If you disagree, press N and Enter. Then select *Create New Disk Array* (below) and input your own settings.

This completes disk array creation. Go on to logical drive creation.

Create a Disk Array Manually

Use this feature to manually build a logical drive to meet your own requirements or to use less than the full number of available disk drives. See page 214 for a discussion of RAID Levels, the number of drives each supports and an explanation of the available options.

- From the Main menu, press 3 and Enter to access Disk Array Management.
- Press 2 and Enter to access the Create New Disk Array.

*****Define New Logical Drive*****

Total 8 Physical Drives

*****Physical Drives Selection*****

ID	Name	Capacity
1	Maxtor 5A250J0	251 GB
3	WDC WD2000JB-00FUA0	200 GB
4	WDC WD2000JB-00FUA0	200 GB
7	ST380013AS	80 GB
9	WDC WD1200JD-00FYB0	120 GB
11	ST380013AS	80 GB
12	WDC WD1200JD-00FYB0	120 GB
15	Maxtor 6Y080M0	82 GB

Enter Physical Drive IDs and/or ID ranges separated by commas. For example: 1,5,8-15.
Press R to continue after you have finished selecting Physical Drives.

Your input?>1,3,4,5,9

- Choose the physical drives for your logical drive and press Enter.

*****Physical Drives Selection*****

ID	Name	Capacity
----	------	----------

*1	Maxtor 5A250J0	251 GB
*3	WDC WD2000JB-00FUA0	200 GB
*4	WDC WD2000JB-00FUA0	200 GB
*7	ST380013AS	80 GB
*9	WDC WD1200JD-00FYB0	120 GB
11	ST380013AS	80 GB
12	WDC WD1200JD-00FYB0	120 GB
15	Maxtor 6Y080M0	82 GB

4 Physical Drives have been selected.
 Enter Physical Drive ids and/or id ranges separated by commas. For example: 1,5,8-15.
 Press R to continue after you have finished selecting Physical Drives.
 Your input?>r

4. When you have selected all the physical drives, press R and Enter.

RAID Mode Options:
 0 - RAID 0 (Striping)
 1 - RAID 1 (Mirroring)
 3 - RAID 3 (Parity)
 5 - RAID 5 (Parity Distributed)
 10 - RAID 10 (Striping/Mirroring)
 50 - RAID 50

Please enter RAID mode(0,1,3,5,10)>5

The prompt displays available RAID modes.

5. Type the RAID mode (level) for your logical drive and press Enter.

Stripe Block Size (4, 8, 16, 32, 64, 128) in KB?>64
 Enter the Disk Array name>**Daves Array**
 Enable initialization(y/n)?>y
 Full or quick initialization(f/q)?>q
 Quick initialization enabled

6. Type the stripe block size, logical drive name, whether you want initialization and if so, quick or full. Press Enter after each input.

If you chose RAID 1, you will not see a stripe block size. After the last item, a list of your logical drive specifications displays.

Logical Drive creation information:
 Name: Daves Array
 Number of Physical Drives: 4
 RAID mode: RAID 5
 Stripe block size: 64KB
 SMART check: enabled

Create Disk Array now(y/n)?>y

7. Review the list. If you agree with the list, press Y and Enter. If you disagree with the list, press N and Enter, then select *Create New Disk Array* again.

If you clicked Y, the new disk array appears.

ID	Name	RAID	SBS	CAP	Member PDs	Status
1	Daves Array	5	64K	357GB	1,3-4,9	Functional

This completes disk array creation. Go on to logical drive creation.

Create a Logical Drive

A logical drive is an entity made from a disk array that your PC's operating system recognizes as a single disk drive.

1. From the Disk Array Management menu, press 4 and Enter to access the Disk Array Properties.
2. Press 1 and Enter to access Create Logical Drive

Mapping for Disk Array 1:

```
-----  
| #1   |  
| 357 GB |  
-----
```

Maximum allowable capacity is 357 GB.

Press Enter key to use the maximum capacity

Or specify capacity in GB for the LD to be created.

Example 1: 12, this will create a 12 GB Logical Drive.

Example 2: 5Gx6, this will create 6 LDs, each LD's capacity is 5 GB.

Note in the Mapping for Disk Array 1 that one logical drive has already been created and that 453 GB is available for additional logical drives.

Your input?>**100**

Enter the Logical Drive name>**FirstLD**

Enable quick initialization(y/n)?>**y**

3. Type the size of your first logical drive in Gigabytes and press Enter.
Or, to create multiple logical drives of the same size, type the size and number of drives as described and press Enter.
4. To enable quick initialization, click Y and press Enter.
If not, click N and press Enter.
5. The logical drive mapping information appears(below), followed by the Disk Array Properties menu.

Disk Array #1 Mapping:

```
-----  
| LD #1 | Free   |  
| 100 GB | 257 GB |  
-----
```

6. Press R and Enter twice to return to the Main menu.

In order to use this logical drive to read and write data, you must partition and format it using the Host PC's operating system.

Assign a SCSI Target ID

The term *Target ID* refers to the SCSI address of the two channels on the RAID subsystem. A SCSI bus has an Initiator, such as the SCSI card inside the Host PC, and at least one Target, such as the Controller and Logical Drives inside the RAID subsystem. Each target must have its own address or Target ID number.

Target IDs can be divided into Logical Unit Numbers (LUNs) to extend the number of available addresses. The default TID settings for both SCSI channels is 0. This setting is adequate for most WebPAM and RAID subsystem configurations. If an address conflict occurs, you might have to change the TID setting.

1. From the Main menu, press 6 and Enter to access SCSI Management.
2. Press 1 and Enter to access the Channel TID.

```
****Modify SCSI Channel TID****
```

SCSI Channel #	TIDs
1	0
2	0

```
Select the SCSI channel(1-2)
Press R to return after finished>1
```

3. Type the number of the SCSI channel you want to select and press Enter.

```
Modify TIDs for SCSI channel 1(y/n)?>y
Enter the new TIDs>1,2,3
```

4. Press Y and Enter to confirm the change.
5. Type the new TID numbers for this channel and press Enter.

Separate non-consecutive numbers with a comma. For consecutive numbers, type the first and last separated by a dash.

Note that your new selection overrides the previous setting. If you want to keep an existing TID, be sure to type it as well.

```
TIDs for SCSI channel 1 changed
Press Enter key to return
```

6. Press Enter to see the new settings.

```
****Modify SCSI Channel TID****
```

SCSI Channel #	TIDs
1	0 1 2 3

2

0

Select the SCSI channel(1-2)
Press R to return after finished>

Exit the CLU

Close the terminal emulation window to exit the CLU.

Chapter 4: Management with WebPAM PRO

- VTrak Status Indicators (below)
- Drive Status Indicators (page 66)
- Audible Alarm (page 67)
- Log-in/Log-out (page 68)
- Subsystem Management (page 71)
- User Management (page 77)
- Software Management (page 87)
- Subsystem Management (page 92)
- VTrak Management (page 95)
- SCSI Management (page 97)
- Network Management (page 99)
- Service Management (page 100)
- Controllers (page 102)
- Enclosures (page 104)
- Disk Arrays (page 110)
- Spare Drives (page 127)
- Logical Drive Summary (page 130)

This chapter describes using WebPAM to monitor and manage your RAID system. This chapter is divided into sections for major WebPAM components as shown above.

VTrak Status Indicators

Even though WebPAM PRO offers comprehensive monitoring of VTrak, the LED indicators on the VTrak unit provide important status information.

When the power is switched on, the LEDs on the front of the VTrak will light up.

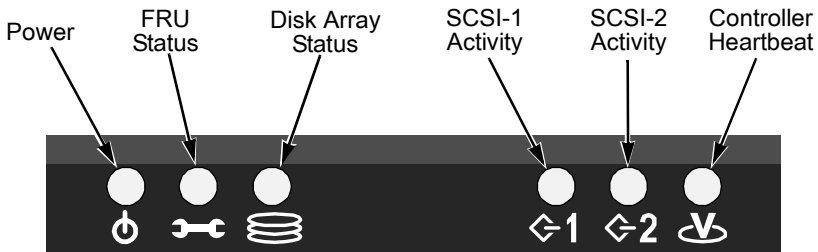

Figure 1. VTrak 15110 Front Panel LEDs

When boot-up is finished and the VTrak is functioning normally:

- Controller LED blinks green once per second for five seconds, goes dark for five seconds, then blinks green once per second for five seconds again.
- Power, FRU and Disk Array LEDs display green continuously.
- SCSI LEDs flash green if there is activity on that channel.

See the table below.

LEDs	State				
	Dark	Steady Green	Flashing Green	Amber	Red
Power	System Off	Normal	n/a	n/a	n/a
FRU*	System Off	Normal	n/a	Fan or Battery Problem	Fan or Battery Failed
Logical Drive	System Off	Normal	n/a	Logical Drive Critical	Logical Drive Offline
SCSI-1 SCSI-2	No Activity	n/a	Activity	n/a	n/a
Controller	System Off	n/a	Normal**	n/a	n/a

* Field Replacement Unit. "n/a" means this state does not apply to this LED.
 ** Blinks five times in five seconds, five seconds dark, blinks five times again.

See page 189 for more information about field-replaceable components.
 See page 234 for a discussion of critical and offline logical drives.

Drive Status Indicators

There are two LEDs on each Drive Carrier. They report the presence of power and a disk drive, and the current condition of the drive.

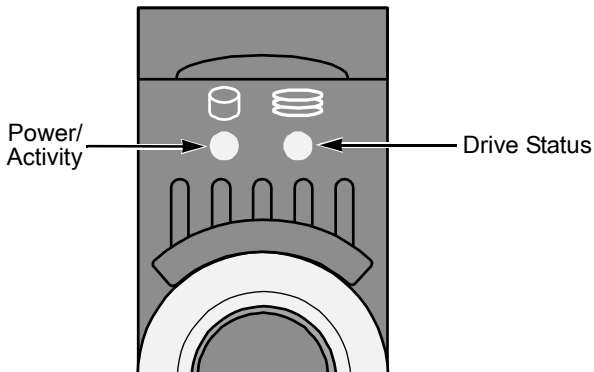

Figure 2. VTrak Drive Carrier LEDs

The VTrak spins up the disk drives sequentially in order to equalize power draw during start-up. After a few moments the Power/Activity and Disk Status LEDs should display green.

LEDs	State				
	Dark	Steady Green	Flashing Green	Amber	Red
Power/Activity	No Drive	Drive Present	Activity	n/a	n/a
Status	No Power/No Drive	Drive OK	n/a	Drive Rebuilding	Drive Error
"n/a" means this state does not apply to this LED.					

See for a discussion of rebuilding and failed disk drives.

Audible Alarm

VTrak's audible alarm has four sound patterns:

- Beep. Beep. Beep. – Indicates that a logical drive is rebuilding
- Beep-beep, beep-beep, beep-beep. – Indicates that a logical drive is critical
- Beep-beep-beep. Beep-beep-beep. – Indicates a problem with a field replaceable unit (FRU)
- 10 second continuous beep – Indicates that a logical drive is offline

See for more information about field-replaceable components.

See for a discussion of critical and offline logical drives.

Log-in/Log-out

Log-in to WebPAM PRO

1. Launch your Browser.
2. In the Browser address field, type in the IP address of the PC or Server where you installed WebPAM PRO, as explained below. Do not type the VTrak's IP address.

Note that the IP address shown below is only an example. The IP address you type into your browser will be different.

If you did *not* choose the External Security option during WebPAM PRO installation, use the *Regular* connection.

If you chose the External Security option during WebPAM PRO installation, use the *Secure* connection.

Regular Connection

- WebPAM PRO uses an HTTP connection. http://
- Enter the Utility Server's IP address 192.168.1.46
(Where you installed WebPAM)
- Enter the Port number :8080
- Add to launch WebPAM PRO /promise

Together, your entry looks like this:

http://192.168.1.46:8080/promise

Secure Connection

- WebPAM PRO uses a secure HTTP connection. https://
- Enter the Utility Server's IP address 192.168.1.46
(Where you installed WebPAM)
- Enter the Port number :8443
- Add to launch WebPAM PRO /promise

Together, your entry looks like this:

https://192.168.1.46:8443/promise

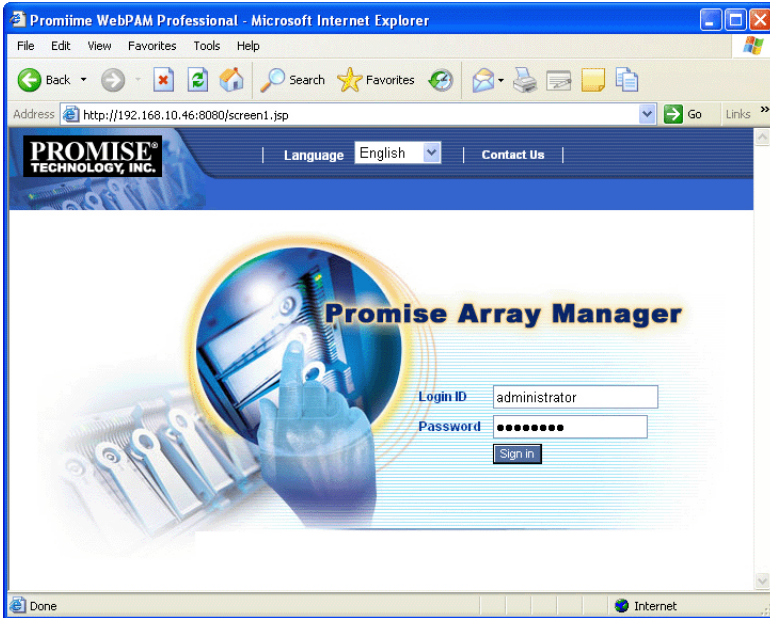

3. When the opening screen appears, type your username in the Login ID field and your password in the Password field. The login and password are case sensitive.

If this is the first time you are running WebPAM PRO, log in as **administrator** and type in the default password, which is **password**. The login and password are case sensitive.



Important

Immediately after installation, change the Administrator's password. Make the change under User Management. Each user you create will have his/her own login ID and password.

4. Click the **Sign in** button.

After sign-in, the WebPAM PRO opening screen appears.

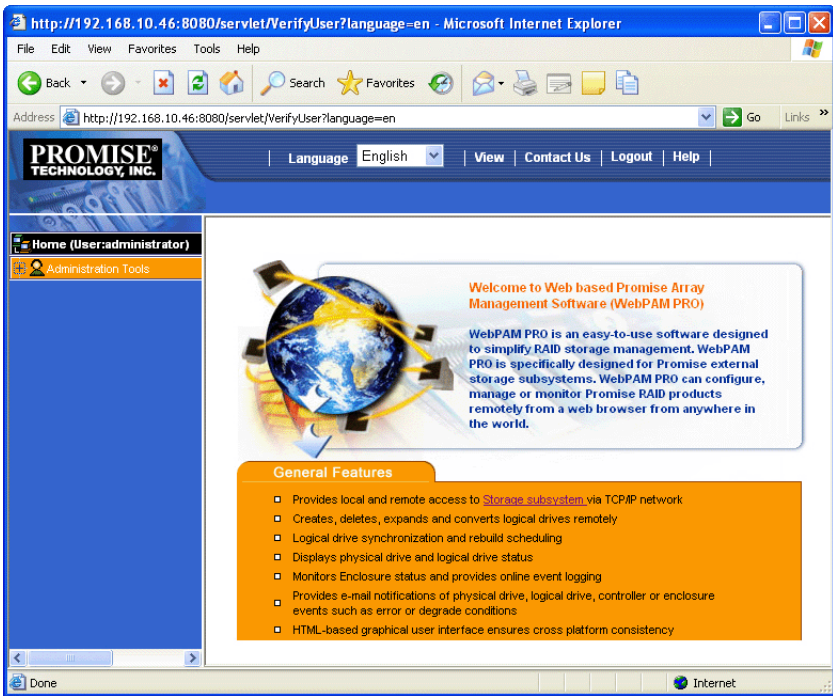

Figure 3. WebPAM PRO Opening Screen

If you setup your VTrak using WebPAM PRO (see Chapter 3) you will have one Subsystem, the Administrator as the only User and one logical drive.

If this is the first time you are logging in to WebPAM, there will be no Subsystems (VTraks) or Users in the system. Promise recommends that you add the Subsystem(s) first, then add the User(s).

Log-out of WebPAM PRO

There are two ways to log out of WebPAM:

- Close your browser window
- Click Logout on the WebPAM banner (below)





After logging out, you must type your username and password to log in again. Clicking Logout brings you back to the Login Screen.

Subsystem Management

- Add a Subsystem (below)
- Subsystem User Rights (page 71)
- Access a Subsystem (VTrak) (page 73)
- Subsystem Management Window (page 74)
- View Event Log (page 74)
- Delete a Subsystem (page 76)

Add a Subsystem (VTrak)

1. Click on Administrator Tools  icon to display the menu.
2. Click on the Subsystem Management  icon.

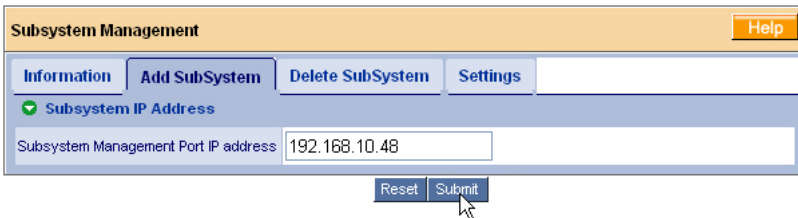

The screenshot shows the 'Subsystem Management' window with the 'Add SubSystem' tab selected. Below the tabs, there is a 'Subsystem IP Address' section with a green checkmark icon. A text input field contains the IP address '192.168.10.48'. Below the input field are 'Reset' and 'Submit' buttons. A mouse cursor is pointing at the 'Submit' button.

3. Click the Add Subsystem tab (above).
4. In the IP Address field, type in the VTrak's Management Port IP address. Do not type the PC/Server's IP address.
5. When you are done, click the **Submit** button.

The new Subsystem is added to Subsystem Management and also appears in the Information tab.

WebPAM PRO allows you to add a Subsystem to the list even though it cannot make a connection to the VTrak. If this happens, refer to Troubleshooting on page 223.

Subsystem User Rights

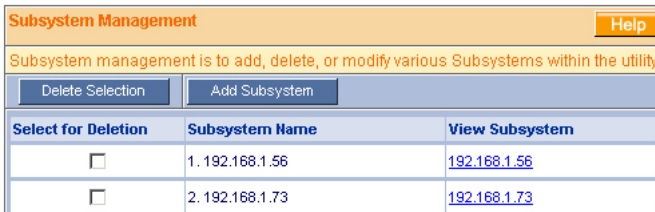

The screenshot shows the 'Subsystem Management' window with the 'Delete Selection' and 'Add SubSystem' buttons. Below the buttons is a table with the following data:

Select for Deletion	Subsystem Name	View Subsystem
<input type="checkbox"/>	1. 192.168.1.56	192.168.1.56
<input type="checkbox"/>	2. 192.168.1.73	192.168.1.73

1. Click the Subsystem Management  icon under Administration Tools. This window displays a list of Subsystems (VTraks) configured to this WebPAM installation.
2. Click on the hypertext link to see an individual Subsystem.

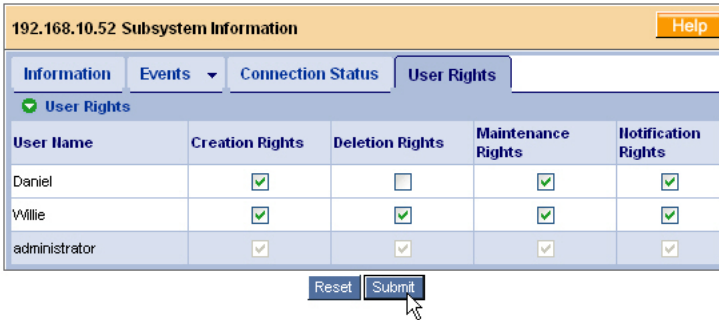

This window provides access information on an individual Subsystem and editing user permissions.

3. Check the permissions this User will have.



Right	Meaning
Creation	Permission to create, convert and expand a logical drive; and make Controller settings
Deletion	Permission to delete a logical drive
Maintenance	Permission to rebuild and synchronize a logical drive
Notification	Permission to receive notification of events affecting the logical drive

4. When you are done, click the **Submit** button.
The Subsystem Management window appears again. Your changes take effect immediately.

Access a Subsystem (VTrak)

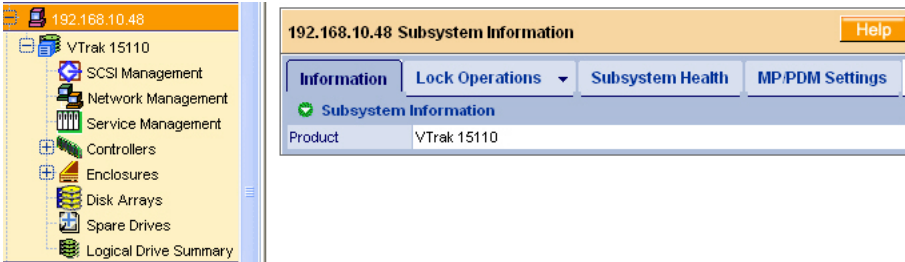
The WebPAM PRO CIMOM Agent resides on the VTrak and sends the monitoring data to the Utility Server and on to the Browser. In Tree View, a newly created Subsystem looks like this:



Each Subsystem (VTrak) is identified by an  icon and its IP Address. Below it, the VTrak Subsystem  icon appears. A Subsystem is made up of:



SCSI Management – SCSI TIDs



Service Management – SNMP, Telnet and CIM services



Controllers – RAID Management on VTrak



Enclosures – Power supplies, cooling, cache battery, circuit cards



Disk Arrays – Creation and management of disk arrays and logical drives



Spare Drives – Physical drives assigned as global or dedicated hot spares



Logical Drive Summary – A list of all logical drives in this enclosure, regardless of the disk array to which they belong

If you do not see these details in the Tree View, it means your network connection to VTrak is not working. Restore your connection before proceeding.

If you do not see anything, lower your browser's security settings.

Subsystem Management Window

To access the Management Window for an individual Subsystem (VTrak), click on the Subsystem  icon in Tree View. The result is a different window than clicking the Subsystem Management icon described above.

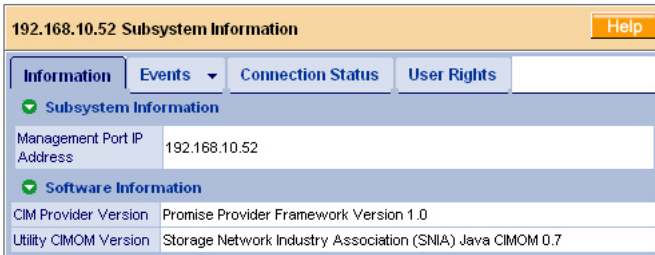

From this point, you can:

- View the Logfile
- Access Host User Rights (Administrator only)

View Event Log

1. In Tree View, click on the Subsystem  icon for the VTrak whose log you want to see.
2. In the Management Window, click on the Events tab.
3. The LogFile window appears (below).

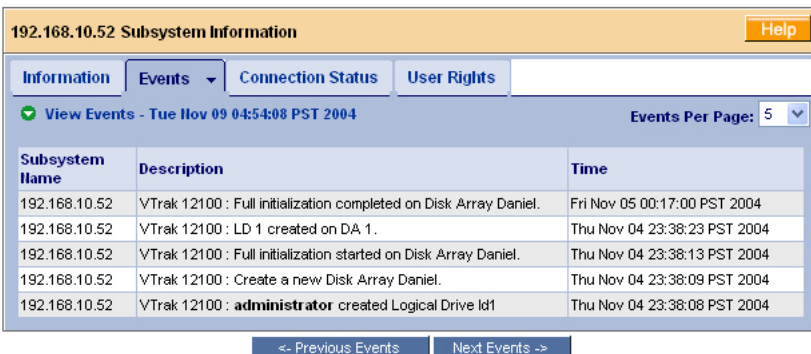

In the LogFile window, you can view all events pertaining to an individual Subsystem (VTrak). Click the **Previous Events** and **Next Events** buttons to see the entire contents. The LogFile is saved automatically.

You must log in as the Administrator in order to save or delete the Logfile.

To save the Log File:

1. From on the Events tab dropdown menu, select *Save Logfile*.
2. In the Save Event box, type a file name for the Logfile.
The name can contain up to 40 characters, letter and numbers only, no spaces.
3. Click the **Submit** button.
4. In the confirmation box, click the **Close** button.
The Log file is saved as a text file and placed in the log directory of the PC/ Server running the Utility Server software.
 - For Windows, the log directory is: C:\WINDOWS\system32
 - For Linux, Mac OS X and Solaris, the log directory is: WebPAM\tomcat

To delete the Log File:

1. From on the Events tab dropdown menu, select *Delete Logfile*.
2. In the Save Log Before Delete box:
 - Click **Yes** to save the file
 - Click **No** to delete without saving
 - Click **Cancel** exit without deleting

If you chose to save the Logfile:

3. In the Save Event box, type a file name for the Logfile.
The name can contain up to 40 characters, letter and numbers only, no spaces.
4. Click the **Submit** button.
5. In the confirmation box, click the **Close** button.
The Log file is saved as a text file and placed in the log directory of the PC/ Server running the Utility Server software.
 - For Windows, the log directory is: C:\WINDOWS\system32
 - For Linux, Mac OS X and Solaris, the log directory is: WebPAM\tomcat

Delete a Subsystem

1. Click the Subsystem Management  icon under Administrative Tools. The Host List appears.

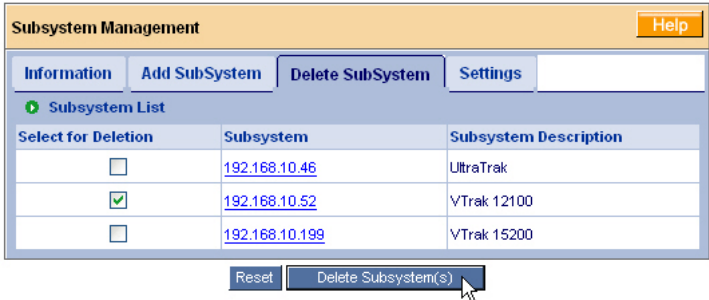

2. Click on the Delete Subsystem tab.
 3. Click the Select for Deletion box of the Subsystem you want to delete.
 4. Click the **Delete Selection** button.
- A confirmation message appears..

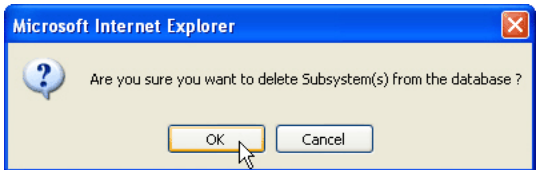

5. Click **OK** to confirm Subsystem deletion.
- The deleted Subsystem no longer appears in Tree View.



Notes

- WebPAM PRO will remove the link from the VTrak to your local browser. This action does not change or delete the RAID itself.
- If you delete a Subsystem with users assigned to it, the user rights are also deleted.

User Management

- Add a User (below)
- Change Password (page 85)
- Delete a User (page 83)
- Setup User Alert Notification (page 86)
- Manage User Rights (page 83)

Add a User

1. Log into WebPAM as the Administrator.
2. In Tree View, click on User Management.
In the right frame, you will see a list of the current Users.
3. Click the Create tab.

User Management
Help

Information
Create
Delete

+ **User Settings**

User Name (4-20 numbers and/or letters, no space)

Password (6-8 numbers and/or letters, no space)

Verify Password

Assign Email Notification

Subsystem Name	Creation Rights	Deletion Rights	Maintenance Rights	Notification Rights	
Subsystem Management Rights	192.168.10.46	<input checked="" type="checkbox"/>	<input checked="" type="checkbox"/>	<input checked="" type="checkbox"/>	<input checked="" type="checkbox"/>
	192.168.10.52	<input checked="" type="checkbox"/>	<input checked="" type="checkbox"/>	<input checked="" type="checkbox"/>	<input checked="" type="checkbox"/>
	192.168.10.199	<input checked="" type="checkbox"/>	<input checked="" type="checkbox"/>	<input checked="" type="checkbox"/>	<input checked="" type="checkbox"/>

Reset
Submit

4. Enter the new User Name, Password, Verify Password (same password).
5. If you want to assign Email notification types for this User, check the Assign Email Notification box.
6. Check the boxes to select Management Rights for this User on each Subsystem.

Right	Meaning
Creation	Permission to create, convert and expand a logical drive; and make Controller settings
Deletion	Permission to delete a logical drive
Maintenance	Permission to rebuild and synchronize a logical drive
Notification	Permission to receive notification of events affecting the logical drive

7. When you are finished making your selections, click the **Submit** button.
- If you checked the Assign Email Notification box, you will be transferred to the Select Events page (see Event Notification, below).
 - If you did NOT check the Assign Email Notification box, you will be transferred to User Management page, where you can see the newly added User.



Notes

- If no Subsystems (VTraks) have been created yet, no machines will appear in the permissions list. You can add a Subsystem now and specify the permissions later.
 - The User can change his/her User Name, Password, email address at any time.
 - A User cannot change his/her own Rights.
 - The Administrator can change a User's Rights, as well as create and delete Users.
-

Event Notification

If you check the Assign Email Notification box while adding a user, you will be transferred to the Select Events page (below). Here you will type an email address and assign the Email Notifications for this user.

Select Events Help

Event Subscription

Email Address:

Email Notification:

Critical Events **All Events**

Controller Event Notification

<input type="checkbox"/> Controller Unknown Error	<input type="checkbox"/> Data Parity Error	<input type="checkbox"/> Command Parity Error
<input type="checkbox"/> Bus Reset	<input type="checkbox"/> Unrecoverable Error	<input type="checkbox"/> Abort task
<input type="checkbox"/> Clear ACA	<input type="checkbox"/> LUN Reset	<input type="checkbox"/> Initiator Error
<input type="checkbox"/> Battery Temperature Rise	<input type="checkbox"/> Battery Temperature Dropped	<input type="checkbox"/> Battery Capacity Below Threshold
<input type="checkbox"/> Battery Capacity Normal	<input type="checkbox"/> Battery Discharging	<input type="checkbox"/> Battery Charging
<input type="checkbox"/> Battery Maintenance Mode	<input type="checkbox"/> Battery Life Ended	

The image above was shortened to fit into the available space.

To save time and effort, check *Critical Events*, *All Events*, or the component-specific boxes. The table below lists all events and their meanings. Critical events are marked with an asterisk (*)

Item	Meaning
Critical Events*	Events of major importance.
All Events	All monitored events are reported.
Controller Event Notification	All events related to the Controller are reported.
Controller Unknown Error	Unspecified problem with the Controller.
Data Parity Error	Detected possible iSCSI data parity error.
Command Parity Error	Detected possible iSCSI command parity error.
Bus Reset	The Initiator sent a command to reset the iSCSI bus.
Unrecoverable Error	VTrak must restart to recover from an error.
Abort Task	A task was aborted.
Clear ACA	Clear an auto contingent alliance condition.
LUN Reset	A LUN was reset.
Initiator Error	Detected possible error on the SCSI/FC initiator.

Item	Meaning
Illegal Secondary Identify	A target received a second Identify message with a different LUN.
Message Parity Error	Detected possible parity error in message between initiator and target.
Bus Reboot	The VTrak system has rebooted.
Connection Event Notification	All events related to the Host PC-to-UltraTrak connection.
UltraTrak Connection Connected	Connection between Host PC and UltraTrak was successful
UltraTrak Connection Lost	Connection between Host PC and UltraTrak has failed
Disk Event Notification	All events related to the disk drives.
Disk Down*	A disk drive has been set down due to some kind of error.
Disk Plugged In	A disk drive has been plugged into the logical drive.
Disk Access Retry	The Controller repeats an attempt to access a disk drive.
Disk CRC Error	A CRC error has occurred on a disk drive.
Disk SMART Failed*	A SMART error has been reported on a disk drive.
Disk ECC Error	A ECC error has occurred on a disk drive.
Disk Bad Sector*	A bad sector has been identified on a disk drive.
Disk Reserve Sector Error	A error has occurred on the reserve sector of a disk drive.
Disk Time Out	A disk drive has timed out.
Logical Drive Event Notification	All events related to logical drives.
Create Logical Drive	A logical drive has been created.
Delete Logical Drive	A logical drive has been deleted.
Logical Drive Critical*	Malfunctioning disk drive, fault tolerance lost.
Logical Drive Offline*	Two malfunctioning disk drives, data access lost.
Logical Drive Migration Started	A logical drive began expansion and/or change of RAID level.

Item	Meaning
Logical Drive Migration Completed	A logical drive finished expansion and/or change of RAID level
Logical Drive Migration Stopped	A logical drive expansion and/or change of RAID level halted before completion.
Logical Drive Rebuild Start	A logical drive began a rebuild.
Logical Drive Rebuild Completed	A logical drive finished a rebuild.
Logical Drive Rebuild Stopped	A logical drive rebuild halted before completion.
Logical Drive Synchronization Start	A logical drive began synchronizing.
Logical Drive Synchronization Completed	A logical drive finished synchronizing.
Logical Drive Synchronization Stopped	A logical drive stopped synchronizing before completion.
Logical Drive Synchronization Comparison Error*	A comparison error was detected during synchronization.
Logical Drive Synchronization Internal Error*	An internal error was detected during synchronization.
Logical Drive Full Initialization Start	Full initialization has begun on a logical drive.
Logical Drive Full Initialization Completed	Full initialization finished on a logical drive.
Logical Drive Full Initialization Stopped	Full initialization on a logical drive halted before completion.
Logical Drive Quick Initialization Start	Quick initialization has begun on a logical drive.
Logical Drive Quick Initialization Completed	Quick initialization finished on a logical drive.
Logical Drive Quick Initialization Stopped	Quick initialization on a logical drive halted before completion.

Item	Meaning
Logical Drive Percent Completed	A progress report on logical drive operations taking place.
Enclosure Event Notification	All events related to the enclosure.
Enclosure Power Down*	Power to the enclosure is OFF.
Enclosure Power Up	Power to the enclosure is ON.
Enclosure Unknown Error*	Unspecified problem with the Enclosure.
Enclosure Over Temperature*	Enclosure is running too hot.
Enclosure Fan Stop*	One of the fans has stopped working.
Enclosure 3 Volt out of Range	3 Volt (actually 3.3 volt) power is out of specification.
Enclosure 5 Volt Out of Range*	5 Volt power is out of specification.
Enclosure 12 Volt Out of Range*	12 Volt power is out of specification.
Battery Temperature Rise	Battery is heating up. Battery ceases to charge above 45°C or discharge above 60°C.
Battery Temperature Dropped	Battery is cooling down.
Battery Capacity below threshold	Battery is too weak to function.
Battery Capacity Normal	Battery is ready for use.
Battery Discharging	Battery is leaking power.
Battery Charging	Battery is recharging.
Battery Maintenance Mode	Discharge and recharge to test battery condition. Happens automatically once every two months.
Battery life ended	Battery is dead. Replace it.

See Chapter 7: Troubleshooting for instructions on what to do when any of these messages appears.

Delete a User

1. Log into WebPAM as the Administrator.
2. Click the User Management  icon under Administrator Tools.
3. Click the Delete tab.

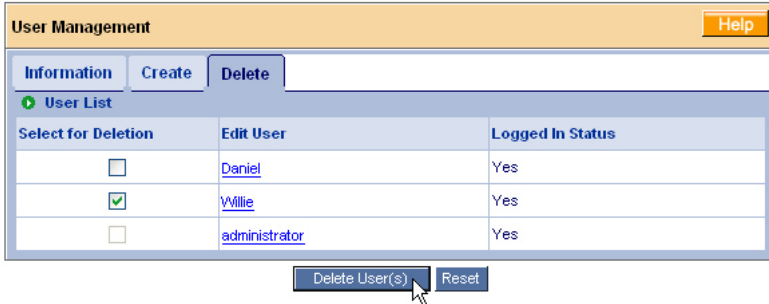

Select for Deletion	Edit User	Logged In Status
<input type="checkbox"/>	Daniel	Yes
<input checked="" type="checkbox"/>	Willie	Yes
<input type="checkbox"/>	administrator	Yes

Buttons: **Delete User(s)** (highlighted), **Reset**

4. Click the box of the User you want to delete.
5. Click the **Delete User(s)** button.



Note

You cannot delete the Administrator.

Manage User Rights

The Administrator uses this page to modify individual user information, such as access rights, email address and email notification. To modify User information:

1. Click the User Management  icon under Administrator Tools.
A list of Users appears.

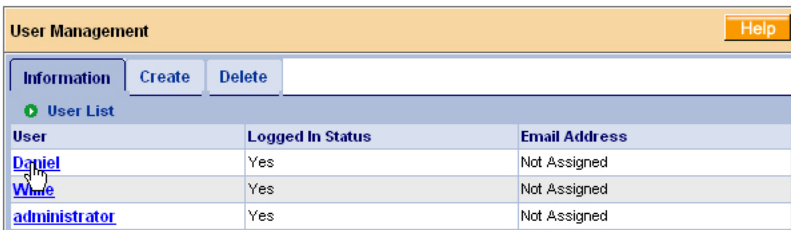

User	Logged In Status	Email Address
Daniel	Yes	Not Assigned
Willie	Yes	Not Assigned
administrator	Yes	Not Assigned

2. Select the name link for the User whose setting you want to change and click on it.

The Modify/View User screen appears (below).

Subsystem Name	Creation Rights	Deletion Rights	Maintenance Rights	Notification Rights
192.168.10.46	<input checked="" type="checkbox"/>	<input checked="" type="checkbox"/>	<input checked="" type="checkbox"/>	<input checked="" type="checkbox"/>
192.168.10.52	<input checked="" type="checkbox"/>	<input checked="" type="checkbox"/>	<input checked="" type="checkbox"/>	<input checked="" type="checkbox"/>
192.168.10.199	<input type="checkbox"/>	<input type="checkbox"/>	<input checked="" type="checkbox"/>	<input checked="" type="checkbox"/>

- In the Modify/View User screen, specify your Subsystem Management Rights, Email address and Event Notification. See the Permissions table below.

Right	Meaning
Creation	Permission to create, convert and expand a logical drive; and make Controller settings
Deletion	Permission to delete a logical drive
Maintenance	Permission to rebuild and synchronize a logical drive
Notification	Permission to receive notification of events affecting the logical drive

You can also set these permissions from the Subsystem User Rights screen.

- When you are done, click the **Submit** button. The Settings tab for this User appears again. Your changes take effect immediately.



Notes

- Under Personal Information, a user can change his/her own password. If he has Notification rights, he can change his own Event Notifications.
- For an Administrator to change a username or password, you must delete the User and add a new one.

Change Password

Each User can change his/her password. If the User has email alert notification, he/she can also change the email address and selection of events.

1. Log into WebPAM under your User Name.
2. Click the Personal Information  icon under Administration Tools.

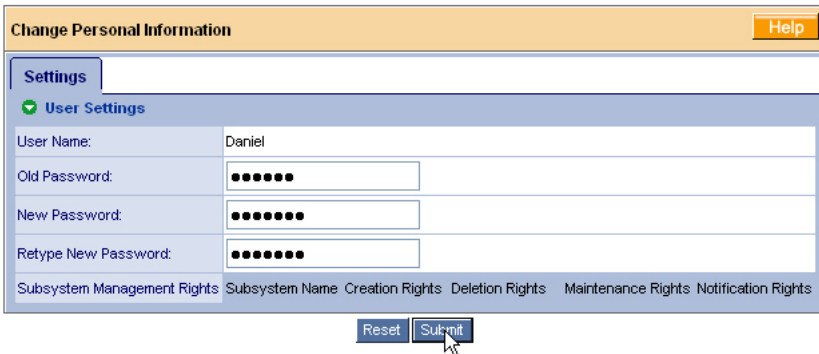

3. Enter a new password.
4. Re-Enter the new password to confirm.
5. When you are done, click the **Submit** button.



Note

If a User forgets his/her password, the Administrator must delete the user account and create a new one.

Setup Email Alert Notification

WebPAM can alert you to the problems and processes happening to your RAID through email messages. You setup Email Notification for each Subsystem (VTrak) and each User individually. A Subsystem must exist before you can set-up Email Notification for it.

These steps describe how to setup the email function.

1. Click the User Management  icon under Administrator Tools.
A list of Users appears.

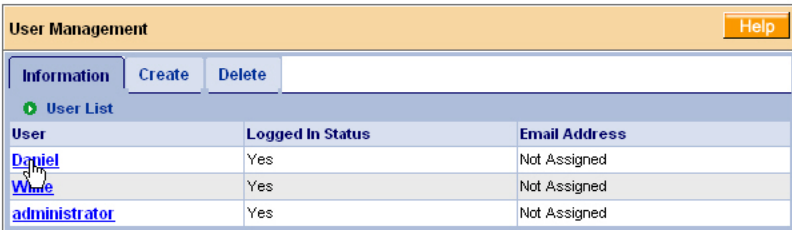

The screenshot shows the 'User Management' interface. It has a title bar with 'User Management' and a 'Help' button. Below the title bar are three tabs: 'Information', 'Create', and 'Delete'. Underneath is a 'User List' section with a table containing three columns: 'User', 'Logged In Status', and 'Email Address'. The table lists three users: 'Daniel', 'White', and 'administrator', all with 'Yes' in the 'Logged In Status' column and 'Not Assigned' in the 'Email Address' column. A mouse cursor is pointing at the 'Daniel' link in the 'User' column.

User	Logged In Status	Email Address
Daniel	Yes	Not Assigned
White	Yes	Not Assigned
administrator	Yes	Not Assigned

2. Click on the hypertext link in the Edit User column for the User you want to manage.
The Modify/View User screen appears with the Settings tab displayed.
If you have not yet typed an email address for this user, type it into the Email Address field.
3. Click on the Event Selection tab.

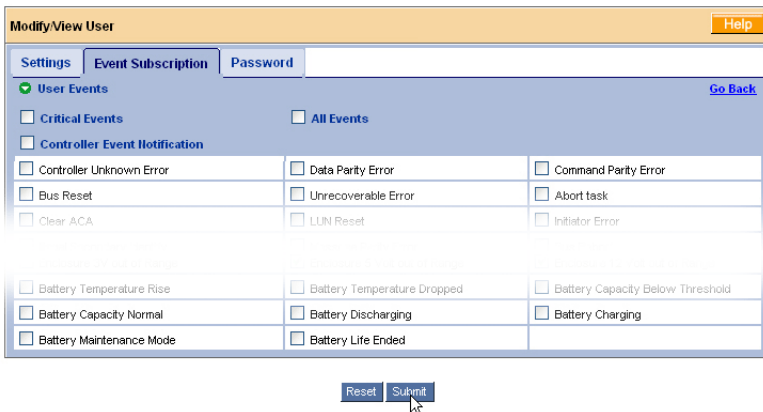

The screenshot shows the 'Modify/View User' interface. It has a title bar with 'Modify/View User' and a 'Help' button. Below the title bar are three tabs: 'Settings', 'Event Subscription', and 'Password'. Underneath is a 'User Events' section with a 'Go Back' link. There are two checkboxes: 'Critical Events' and 'All Events'. Below these are three columns of checkboxes for event selection. At the bottom, there are 'Reset' and 'Submit' buttons. A mouse cursor is pointing at the 'Submit' button.

User Events		
<input type="checkbox"/> Critical Events	<input type="checkbox"/> All Events	
<input type="checkbox"/> Controller Event Notification		
<input type="checkbox"/> Controller Unknown Error	<input type="checkbox"/> Data Parity Error	<input type="checkbox"/> Command Parity Error
<input type="checkbox"/> Bus Reset	<input type="checkbox"/> Unrecoverable Error	<input type="checkbox"/> Abort task
<input type="checkbox"/> Clear ACA	<input type="checkbox"/> LUN Reset	<input type="checkbox"/> Initiator Error
<input type="checkbox"/> Battery Temperature Rise	<input type="checkbox"/> Battery Temperature Dropped	<input type="checkbox"/> Battery Capacity Below Threshold
<input type="checkbox"/> Battery Capacity Normal	<input type="checkbox"/> Battery Discharging	<input type="checkbox"/> Battery Charging
<input type="checkbox"/> Battery Maintenance Mode	<input type="checkbox"/> Battery Life Ended	

The image above was shortened to fit into the available space.

4. Select the alert events you want reported via email. To save time and effort, check *Critical Events*, *All Events*, or the component-specific boxes. See page 79 for a list of events and their meanings.
5. When you are done, click the **Submit** button.
The User list appears again. Your changes take effect immediately.

Software Management

- Web Server (below)
- Email (page 88)
- Firmware Update (page 89)
- TFTP Server (page 90)
- Refresh Time (page 91)
- Restart Tomcat Service (Windows) (page 91)
- Security (page 91)

Click the Software Management  icon under Administration Tools. The Software Management screen appears with the Services tab displayed.

Software Management Help					
Services	Web server	Email	Firmware Update	TFTP Server	Refresh Time
<input checked="" type="checkbox"/> Service List					
Service Name	Startup Type	Current Status			
Web server	Automatic	Started			
Email	Automatic	Started			
TFTP Server	Automatic	Stopped			

Web Server

1. Click the Software Management  icon under Administration Tools.
2. Click the Web server link or tab.

The screenshot shows the 'Software Management' interface with a 'Help' button in the top right. Below the title bar are tabs for 'Services', 'Web server', 'Email', 'Firmware Update', 'TFTP Server', and 'Refresh Time'. The 'Web server' tab is selected, showing 'Web server Settings' and 'SSL Settings' sections. Under 'Web server Settings', there are fields for 'HTTP Port' (8080) and 'Session Timeout' (24 Minutes). Under 'SSL Settings', there is a checked 'Enable SSL' checkbox and an 'HTTPS Port' field (8443). At the bottom are 'Reset' and 'Submit' buttons.

3. Set the Web server parameters:

HTTP Port	The port number for unsecure connections. 8080 is the default.
Session Timeout	Timeout interval for HTTP session.
Enable SSL	Enables the Secure Sockets Layer function required for a secure connection.
HTTPS Port	The port number for secure connections. 8443 is the default.

4. Click the **Submit** button when you are done.

If you change the WebPAM PRO security settings, restart the Tomcat service for the new parameters to take effect. See Restart Tomcat Service (Windows) (page 91).

Email

1. Click the Software Management  icon under Administration Tools.
2. Click the Email link or tab.

Software Management Help

Services | Web server | **Email** | Firmware Update | TFTP Server | Refresh Time

ESMTP Settings

Enable ESMTP

ESMTP User Name

ESMTP Password

Email Settings

Email Sender (From)

Email Server

Email Subject

Test Email | Reset | **Submit**

3. Set the Email parameters:

ESMTP Enable	Check the box to enable eSMTP.
ESMTP User Name	Enter a user name for yourself.
ESMTP Password	Enter a password for yourself.
Email Server	Specifies the name of the email server on your network.
Email Subject	Specifies the “subject line” on email event notification messages.
Event Frame Refresh Time	Specifies the time interval between refreshes of the Event Frame.

4. Click the **Submit** button when you are done.

Firmware Update

This tab is used to update the firmware on VTrak subsystems. See Firmware Update on page 190 for instructions on how to update VTrak’s firmware.

1. Click the Software Management  icon under Administration Tools.
2. Click the Firmware Update tab.

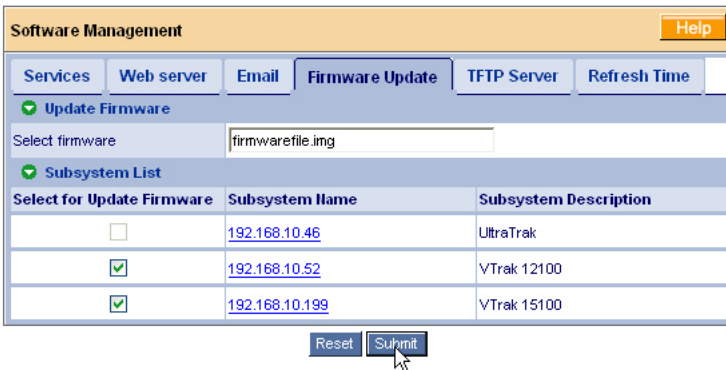

3. Enter the name of the firmware upgrade *.img file in the Select Firmware field.
4. Check the boxes beside the subsystems whose firmware you want to update.
5. Click the **Submit** button.

TFTP Server

The TFTP Server tab enables you to designate a TFTP directory and port number on the server where the WebPAM PRO Utility Server is running.

The WebPAM PRO firmware update function goes to the TFTP directory to retrieve the firmware update file.

1. Click the Software Management  icon under Administration Tools.
2. Click the TFTP Server link or tab.

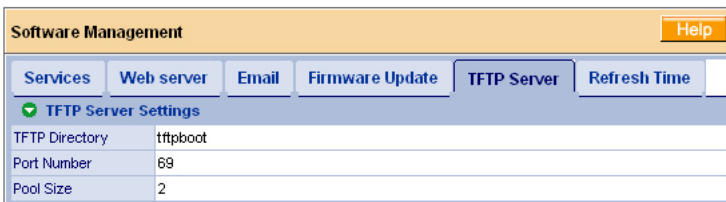

3. Enter a TFTP directory name.
4. Enter at TFTP Port number.
5. Click the **Submit** button when you are done.

Refresh Time

This tab sets the refresh interval for the Event Frame.

1. Click the Software Management  icon under Administration Tools.
2. Click the Refresh Time tab.

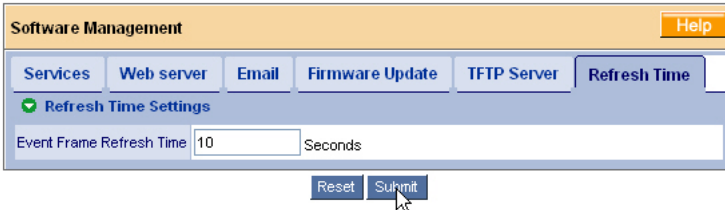

The screenshot shows the 'Software Management' window with a 'Help' button in the top right. Below the title bar are several tabs: 'Services', 'Web server', 'Email', 'Firmware Update', 'TFTP Server', and 'Refresh Time'. The 'Refresh Time' tab is selected, showing a 'Refresh Time Settings' section with a green checkmark. A text input field labeled 'Event Frame Refresh Time' contains the number '10', followed by the unit 'Seconds'. Below the input field are two buttons: 'Reset' and 'Submit'. A mouse cursor is pointing at the 'Submit' button.

3. Enter the refresh interval in seconds.
4. Click the **Submit** button when you are done.

Restart Tomcat Service (Windows)

When you make changes to the WebPAM PRO Security settings, you must restart the Tomcat service—on the the PC or fileserver where the Utility Server is installed—for your changes to take effect.

1. Right-click on the My Computer icon and select *Manage* from the popup menu. The Computer Management window opens.
2. Click on the + beside Services and Applications to expand the tree.
3. Click on Services. The Services window displays to the right.
4. In the Services window, right-click on Tomcat and select *Restart* from the popup menu.
5. Close the Computer Management window.

Security

Security features use the Secure Sockets Layer (SSL) method of encryption. SSL is a well-proven method of securing transactions used extensively for e-commerce and confidential transactions on the Internet. With security installed, you log in using Hypertext Transfer Protocol Secure (HTTPS).

External SSL Security – Applies security to all connections involving the Internet or outside your company firewall.

Security options are invisible to authorized users. At the same time, they ensure that information about your RAID remains confidential, and commands and data traveling over the network are not altered in any way.

Promise Technology provides a default certificate for the server as well as for internal data communication. However, it is always better to install your own certificate for the web server. And, if possible, verify certificate by certificate authority like Verisign or Thwate.

Security options were originally set during installation. They can be changed by modifying certain configuration files, discussed below.

```
<!-- Define a non-SSL HTTP/1.1 Connector on port 8080 -->
<Connector
  className="org.apache.catalina.connector.http.HttpConnector"
  port="8080" minProcessors="5" maxProcessors="75" enableLookups="true"
  redirectPort="8443" acceptCount="10" debug="0"
  connectionTimeout="60000" />
- <!--
  Note : To disable connection timeouts, set connectionTimeout
  value
  to -1
-->
-->
<!-- Define an SSL HTTP/1.1 Connector on port 8443 -->
- <Connector
  className="org.apache.catalina.connector.http.HttpConnector"
  port="8443" minProcessors="5" maxProcessors="75" enableLookups="true"
  acceptCount="10" debug="0" scheme="https" secure="true">
  <Factory
    className="org.apache.catalina.net.SSLServerSocketFactory"
    keystoreFile="/conf/.keystore" clientAuth="false" protocol="TLS" />
  </Connector>
```

1. Go to directory C:\WebPAM\tomcat\conf\ (this is the default directory) on the webserver host and open file server.xml.
2. Modify the file so that it agrees with the example above. This configuration activates the 8080 (non-secure) and 8443 (secure) ports.
3. Save the file.
4. Restart the Tomcat service for the new parameters to take effect. See page 91.

Subsystem Management

- Events (below)
- User Rights (page 94)
- Connection Status (page 94)

Events

The Subsystem–Events tab lists the content of the Log File. The Log file records all actions on this subsystem for use in management and troubleshooting.

You can set the number of events to display per page from the dropdown menu. A smaller number of events will take up less room on the screen.

Click on the **Previous Events** and **Next Events** buttons at the bottom of the page to navigate through the events.

To save the Log File:

1. Log in as the Administrator.
2. Click on the Subsystem  icon.
3. Click on the Events tab.
4. From on the Events tab dropdown menu, select *Save Logfile*.
5. In the Save Event box, type a file name for the Logfile.
The name can contain up to 40 characters, letter and numbers only, no spaces.
6. Click the **Submit** button.
7. In the confirmation box, click the Close button.
The Log file is saved as a text file and placed in the log directory of the PC/ Server running the Utility Server software.
For Windows, the log directory is: C:\WINDOWS\system32.
For Linux, Mac OS X and Solaris, the log directory is: WebPAM\tomcat.

To delete the Log File:

1. Log in as the Administrator.
2. Subsystem  icon.
3. Click on the Events tab.
4. From on the Events tab dropdown menu, select *Delete Logfile*.
5. In the Save Log Before Delete box:
 - Click **Yes** to save the file.
 - Click **No** to delete without saving.
 - Click **Cancel** exit without deleting.

If you chose to save the Logfile:

6. In the Save Event box, type a file name for the Logfile.
The name can contain up to 40 characters, letter and numbers only, no spaces.
7. Click the **Submit** button.
8. In the confirmation box, click the **Close** button.
The Log file is saved as a text file and placed in the log directory of the PC/ Server running the Utility Server software.
For Windows, the log directory is: C:\WINDOWS\system32.
For Linux, Mac OS X and Solaris, the log directory is: WebPAM\tomcat.

Connection Status

The Subsystem–Connection Status tab verifies the network connection between the server running the WebPAM PRO Utility Server and the VTrak subsystem.

There are two conditions cited under Connection Info:

- Connection is present and functional – WebPAM PRO is connected and ready.
- No Connection or Connection Failed – Establish or reestablish the connection before proceeding.

If the tab shows No Connection, check the network connections to the VTrak's management port and be sure the VTrak is running. It is possible that somebody changed the VTrak's Management Port IP address. Use the CLU to verify the current IP address. If it has changed, add a Subsystem in WebPAM PRO using the new IP address.

User Rights

The Subsystem–User Rights tab enables you to check and modify the rights of the users on this subsystem. The following table explains User Rights.

Right	Meaning
Creation	Permission to create, convert and expand a logical drive; and make Controller settings
Deletion	Permission to delete a logical drive
Maintenance	Permission to rebuild and synchronize a logical drive
Notification	Permission to receive notification of events affecting the logical drive

To modify User Rights:

1. Log in as the Administrator.
2. Subsystem  icon.
3. Click on the User Rights tab.
4. Check the boxes to add rights.
5. Uncheck the boxes to delete rights.
6. Click the **Submit** button when you are done.

The settings shown here for each user also appear under Modify/View User (see page 83).



To add users to, or delete users from the User Rights list, go to the User Management function under Administration Tools.

VTrak Management

- Lock Operations (below)
- Subsystem Health (page 95)
- MP/PDM Settings (page 96)

Lock Operations

The VTrak–Lock Operations tab displays lock status and enables you to lock or unlock a subsystem controller. The locking mechanism isolates the controller during maintenance operations and other periods when you want to avoid interruption from other users trying to access the disk arrays or logical drives under this controller.

1. Click the Subsystem  icon.
2. Click on the VTrak  icon.
3. Click on the Lock Operations tab.

There are three items in the Lock Operations tab dropdown menu:



- Set Lock – Sets the lock on the controller.
- Release Lock – Releases the lock on the controller.
- Release All Locks – Administrator only. Releases the locks on all controllers.

When the lock is set, the Lock Status reports, for example, "Willie:lock exists". Other users see the message, "Willie has lock on this controller". If you move your cursor over Set Lock from the Lock Operations tab dropdown menu, a popup message reports the same. In these examples, it means that the user "Willie" has locked the controller and other users cannot access the controller while the lock is set.

Be sure to unlock the controller when you finish your maintenance procedure, so other users are not locked out.

Subsystem Health



The VTrak–Subsystem Health tab displays a functional overview of logical drives, physical drives and the enclosure. This tab applies to VTrak only.

1. Click the Subsystem  icon.
2. Click on the VTrak  icon.
3. Click on the Subsystem Health tab.

There are three items in the Subsystem Health tab:

- Logical Drive Health – Logical drives under this controller.
- Physical Drive Health – Physical drives under this controller.
- Enclosure Health – Temperature, voltage, battery condition.

Functional indicates normal operation. Problems are described in red type.

Click on the Logical Drive Summary  icon, Physical Drive  icon or Enclosure  icon for more specific information about any problems.

MP/PDM Settings



Media Patrol is a routine maintenance procedure that checks the magnetic media on each disk drive. Media Patrol checks physical drives assigned to non-redundant (RAID 0) disk arrays, spare and unassigned drives.

Unlike Synchronization and Redundancy Check, Media Patrol is concerned with the condition of the media itself, not the data recorded on the media. If Media Patrol encounters a critical error, it triggers PDM if PDM is enabled.

Predictive Data Migration (PDM) is the migration of data from the suspect disk drive to a spare disk drive, similar to Rebuilding a Logical Drive. But unlike Rebuilding, PDM constantly monitors your disk drives and automatically copies your data to a spare disk drive BEFORE the disk drive fails and your Logical Drive goes Critical.

The VTrak–MP/PDM Settings tab enables you to make settings on Media Patrol and PDM. These features apply to VTrak only.

To enable Media Patrol or PDM:

1. Click the Subsystem  icon.
2. Click on the VTrak  icon.
3. Click on the MP/PDM Settings tab.
4. Check the Enable Media Patrol checkbox to enable Media Patrol.
Uncheck the box to disable.
5. Check the Enable PDM checkbox to enable PDM.
Uncheck the box to disable.
6. Click the **Submit** button when you are done.

You can also perform a PDM manually under Disk Array Background Activity.



Note

You must enable Media Patrol and PDM on each disk array.

SCSI Management

- LUN Settings (below)
- Statistics (page 99)
- TID Settings (page 98)

The SCSI Management–Information tab lists the SCSI Channels for this subsystem. SCSI Management applies to VTrak 8100, 12100 and 15110.

LUN Settings



The SCSI Management–Console LUN Settings tab enables you make RAID Console and TID LUN settings. This feature applies to VTrak 8100, 12100 and 15110.

The SCSI RAID Console enables in-band SCSI management of the VTrak subsystem. Neither WebPAM PRO nor the Command Line Utility (CLU) provided with VTrak use in-band SCSI technology. **This feature is for future use. For now, leave it DISABLED.**

The RAID Console LUN is the Controller's SCSI address. LUN stands for Logical Unit Number. Essentially it is a subdivision of a SCSI Target ID. The default setting for the RAID Console is TID 0, LUN 7. This setting is adequate for most WebPAM and RAID subsystem most configurations. If an address conflict occurs, you might have to change the Console LUN setting.

You must have Creation Rights to access this function.

To make settings:

1. Click the Subsystem  icon.
2. Click on the VTrak  icon.
3. Click on the SCSI Management  icon.
4. Click on the Console LUN Settings tab.
5. Check the Enable LUN Settings box to enable the SCSI RAID Console.
6. For SCSI Channel 1, in the center column, select the SCSI Target ID number under which you want to set the Console LUN.

You can specify additional SCSI TIDs as needed.

7. In the right column, select the LUN for the Console.
8. Repeat steps 1 and 2 for SCSI Channel 2.
9. Click the **Submit** button when you are done.



TID Settings

The SCSI Management–TID Settings tab enables you add SCSI Target IDs. This feature applies to VTrak 8100, 12100 and 15110. The term "Target ID" refers to the SCSI address of the two channels on the RAID subsystem. A SCSI bus has an Initiator, such as the SCSI card inside the Host PC, and at least one Target, such as the Controller and Logical Drives inside the RAID subsystem. Each target must have its own address or Target ID number.

Target IDs can be divided into Logical Unit Numbers (LUNs) to extend the number of available addresses. The default TID settings for both SCSI channels is 0. This setting is adequate for most WebPAM and RAID subsystem configurations. If an address conflict occurs, you might have to change the TID setting.

You must have Creation Rights to access this function.

To make settings:

1. Click the Subsystem  icon.
2. Click on the VTrak  icon.
3. Click on the SCSI Management  icon.
4. Click on the TID Settings tab.
5. Select the SCSI Target IDs you want to use on SCSI Channel 1.
6. Select the SCSI Target IDs you want to use on SCSI Channel 2.
7. Click the **Submit** button when you are done.



Caution

Conflicting ID numbers can prevent WebPAM from connecting to the RAID subsystem and/or cause the SCSI HBA BIOS not to recognize the Logical Drives. Promise offers a sufficient quantity of TIDs and LUNs to avoid any conflict problems.





Note

The quantity and ID number of Target IDs you select depends in part upon how many logical drives you plan to create, how your Host PC and RAID subsystem are connected, and how many addresses are on the SCSI bus.

Statistics

The SCSI Management–Statistics tab displays a tally of Input/Output operations and amount of data transactions. These figures are for informational purposes only.

1. Click the Subsystem  icon.
2. Click on the VTrak  icon.
3. Click on the SCSI Management  icon.
4. Click on the Statistics tab.

The statistics are displayed in this order:

- Count (number) of Read input/output operations
- Count (number) of Write input/output operations
- Data volume of Read transactions in Megabytes
- Data volume of Write transactions in Megabytes

Network Management



- Ethernet (below)
- Settings (page 100)

Ethernet

The Network Management–Ethernet tab displays the current Network settings. These settings pertain to VTrak's Management Port.

To make settings, click on the Port1 link or the Settings tab.

To access the Network Management–Ethernet tab:



1. Click the Subsystem  icon.
2. Click on the VTrak  icon.
3. Click on the Network Management  icon.

4. Click on the Port1 link or the Settings tab.

Settings

The Network Management–Settings tab enables you to make network settings for VTrak's Management Port.

To make settings:

1. Click the Subsystem  icon.
2. Click on the VTrak  icon.
3. Click on the Network Management  icon.
4. Click on the Port1 link or the Settings tab.
5. Enter the Management Port IP address.
6. Enter the TFTP Server IP address.
7. Enter the Subnet Mask.
8. Enter the Gateway IP address.
9. Click the **Submit** button when you are done.



Notes

- For WebPAM PRO to work, you must have the correct Management Port IP address and Subnet Mask.
 - The TFTP Server is used to update VTrak's firmware under Software Management.
 - The Gateway IP address is required if your WebPAM PRO network connection includes a gateway.
-



Service Management

- Service (below)
- Telnet (page 102)
- SNMP (page 101)

Service

The Service Management–Service tab displays the services running with WebPAM PRO and their startup types and current status.

1. Click the Subsystem  icon.



2. Click on the VTrak  icon.
3. Click on the Service Management  icon.
4. To access SNMP settings, click the SNMP tab or SNMP link.
5. To access Telnet settings, click the Telnet tab or Telnet link.

There are no user settings for CIM.

SNMP

The Service Management–SNMP tab enables you to specify SNMP settings. Simple Network Management Protocol (SNMP) is a set of protocols for managing complex networks. SNMP works by sending messages to different parts of a network. SNMP-compliant devices called "agents" store data about themselves in Management Information Bases (MIB) and return this data to the SNMP requesters. Event notifications called "traps" are sent to a destination or "trap sink" specified by an IP address.

To enable SNMP:

1. Click the Subsystem  icon.
2. Click on the VTrak  icon.
3. Click on the Service Management  icon.
4. Click on the SNMP tab.
5. Enter a System Name.
6. Enter a System Location.
7. Enter a System Contact.
8. Enter a name for the Read Community.
9. Enter a name for the Trap Community.
10. Enter a Trap Sink IP address.
11. Click the **Update** button.
The new trap sink will appear in the list.
12. Click the **Submit** button when you are done.



To delete a trap sink:

1. In the Trap Sinks list, check the Delete box for the trap sink you want to delete.
2. Click the **Delete** button.
3. Click the **Submit** button when you are done.

Telnet

The Service Management–Telnet tab lets you enable and disable Telnet service. You can use Telnet to run the VTrak Command Line Utility over a network connection.

To enable Telnet:

1. Click the Subsystem  icon.
2. Click on the VTrak  icon.
3. Click on the Service Management  icon.
4. Click on the Telnet tab.
5. Check the Enable Telnet box.
6. Click the **Submit** button when you are done.

To disable Telnet, follow the above procedure but uncheck the Enable Telnet box.

Controllers



- Controller List (below)
- Settings (page 103)
- Controller (page 102)

Controller List

The Controllers–Information tab lists the controllers for this subsystem. A Controller is the device that makes your Promise RAID system work. This information is primarily for reference by Technical Support.

There are no user settings for this tab.

To access the Controllers–Information tab:

1. Click the Subsystem  icon.
2. Click on the VTrak  icon.
3. Click on the Controllers  icon.





Controller

The Controller–Information tab lists the information for a specific controller in this subsystem. A Controller is the device that makes your Promise RAID system work. The information listed here is primarily for reference by Technical Support.

There are no user settings on this tab.

To set an alias for this controller or to set VTrak's date and time, click the Settings tab.

To access the Controller–Information tab:

1. Click the Subsystem  icon.
2. Click on the VTrak  icon.
3. Click on the Controllers  icon.
4. Click on the Controller  icon.





Controller Parameters

- **Controller ID** – (typically 1).
- **Alias** – A user-specified name given to this controller.
- **Vendor** – Promise Technology, Inc.
- **Model** – Model number of this VTrak.
- **Serial Number** – Serial number of this VTrak
- **Memory Size** – Size of VTrak's cache memory in MB.
- **Flash Size** – Size of VTrak's flash memory in MB.
- **NVRAM Size** – Size of VTrak's non-volatile RAM memory in MB.
- **SEP Hardware Version** – Hardware version number of the Storage Enclosure Processor (SEP) card.
- **Hardware Version** – Hardware version number of the Controller card.
- **Firmware Version** – Revision number of the currently installed VTrak firmware.
- **Firmware Build Date** – Date and time setting of the VTrak subsystem.
- Maximum supported numbers:
 - **Disk Arrays** – Organized collections of physical drives.
 - **Logical Drives** – Entity based on a disk array that the PC's operating system recognizes as a single disk drive.
 - **Physical Drives** – Hard disk drives.
 - **Dedicated Spares** – A hot spare drive available only to a specified disk array.

Settings

The Controller–Settings tab enables you to specify an alias (name) for this controller and set the VTrak subsystem's date and time.

To set an alias for this controller:

1. Click the Subsystem  icon.
2. Click on the VTrak  icon.
3. Click on the Controllers  icon.
4. Click on the Controller  icon.
5. Click on the Settings tab.
6. Enter an alias in the field.
7. Click the **Submit** button when you are done.

To set date and time on the VTrak subsystem:

1. Follow steps 1 through 5 above to access the Controller's Settings tab.
2. Select the month from the dropdown menu.
3. Select the day from the dropdown menu.
4. Select the year from the dropdown menu.
5. Enter the hour of the day (24-hour clock) in the left field.
6. Enter the minutes in the right field.
7. Click the **Submit** button when you are done.

Enclosures



- Enclosure List (below)
- Buzzer (page 106)
- Enclosure (page 105)
- Physical Drive List (page 107)
- FRU VPD (page 105)
- Physical Drive (page 108)
- Battery (page 106)

Enclosure List

The Enclosures–Information tab lists the information about the enclosures under this subsystem. The Status field reports Functional when operation is normal or it cites a problem in red.

If the Status field reports a problem, click on the Enclosure  icon (under the Enclosures icon in Tree View) for more information.

To access the Enclosures–Information tab:





1. Click the Subsystem  icon.
2. Click on the VTrak  icon.

3. Click on the Enclosures  icon.

Enclosure



The Enclosure–Information tab lists detailed information on the status of the enclosure for this subsystem. In the diagram, the icons of functional components are shown in green. The icons of out-of-specification components are also shown in yellow or red. In the tables below the diagram, out-of-specification values are shown in red.

To access the Enclosure–Information tab:

1. Click the Subsystem  icon.
2. Click on the VTrak  icon.
3. Click on the Enclosures  icon.
4. Click on the Enclosure  icon.
 - For more information about Field Replaceable Units, click the FRU VPD tab.
 - To check Battery condition, click the Battery tab.
 - To check the Buzzer setting, click the Buzzer tab.
 - To change the Buzzer setting, click the dropdown menu on the Buzzer tab and select Settings.



Notes

- See Chapter 6 for instructions how to replace a battery or FRU.
- To see information on the physical drives in this enclosure, click the Physical Drives  icon under the Enclosure  icon.



FRU VPD

The Enclosure–FRU VPD tab lists Vital Product Data (VPD) or each Field Replaceable Unit (FRU) in this enclosure. This information is primarily for reference by Technical Support.

There are no user settings for this tab. See Chapter 6 for instructions how to replace a FRU.

To access the Enclosure–Information tab:

1. Click the Subsystem  icon.





2. Click on the VTrak  icon.
3. Click on the Enclosures  icon.
4. Click on the Enclosure  icon.
5. Click on the FRU VPD tab.

Battery

The Enclosure–Battery tab reports on the condition of VTrak's cache backup battery. Battery Information displays battery temperature, capacity and voltage. The Advanced Battery Information lists Vital Product Data (VPD), which is primarily for reference by Technical Support.

There are no user settings for this tab. See Chapter 6 for instructions how to replace a battery.

To access the Enclosure–Information tab:

1. Click the Subsystem  icon.
2. Click on the VTrak  icon.
3. Click on the Enclosures  icon.
4. Click on the Enclosure  icon.
5. Click on the Battery tab.

Buzzer



The Enclosure–Buzzer tab reports on the audible alarm setting. VTrak's audible alarm has four signals:

- Beep-beep, beep-beep, beep-beep: Indicates that one or more Logical Drives is Critical.
- Beep. Beep. Beep: Indicates that one or more Logical Drives is Rebuilding.
- Beep-beep-beep, beep-beep-beep: Indicates a problem with an FRU.
- 10 second continuous beep: Indicates that one or more Logical Drives is Offline.

The audible alarm has a Silence function which stops it from sounding for the current event only. If another event happens, the buzzer will sound again.





To change audible alarm setting:

1. Click the Subsystem  icon.

2. Click on the VTrak  icon.
3. Click on the Enclosures  icon.
4. Click on the Enclosure  icon.
5. Click on the Buzzer tab.
6. Click the dropdown menu on the Buzzer tab and select Settings.
The buzzer settings tab appears.
 - Check the Enable box to enable the buzzer. Uncheck the box to disable.
 - Check the Silence box in to stop the Buzzer for the current event only.
7. Click the **Submit** button when you are done.

Physical Drive List

The Physical Drives—Information tab gives a description and reports the status of the hard disk drives in this enclosure. To access the physical drives list:

1. Click the Subsystem  icon.
2. Click on the VTrak  icon.
3. Click on the Enclosures  icon.
4. Click on the Enclosure  icon.
5. Click on the Physical Drives  icon.

Enclosure Front View

The Enclosure Front View shows the enclosure locations of the physical drives. Move your cursor over the physical drive in the list and the location is highlighted in the diagram.

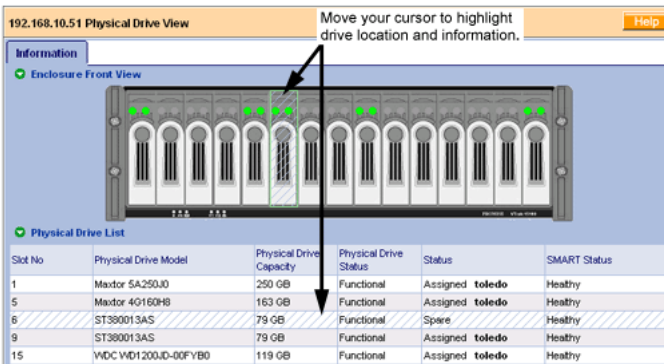

Slot No	Physical Drive Model	Physical Drive Capacity	Physical Drive Status	Status	SMART Status
1	Maxtor 5A250J0	250 GB	Functional	Assigned toledo	Healthy
5	Maxtor 40160H8	163 GB	Functional	Assigned toledo	Healthy
6	ST380013AS	79 GB	Functional	Spare	Healthy
9	ST380013AS	79 GB	Functional	Assigned toledo	Healthy
15	WDC WD1200JD-00FYB0	119 GB	Functional	Assigned toledo	Healthy





Physical Drive Information



- **Slot No** – This is the Controller channel ID number to which this physical drive is attached. If you have a drive on a channel but it does not appear in WebPAM, there is a bad connection.
- **Physical Drive Model** – The drive manufacturer's identification.
- **Physical Drive Capacity** – The effective data storage capacity in gigabytes. This is total capacity, not available capacity.
- **Physical Drive Status** – The functional status of an individual disk drive.
 - Functional means normal.
 - Disk is being rebuilt means this drive is the Target Drive of the rebuild operation that is in progress.
 - Disk Offline means this drive is not available for use due to an error. See Rebuild Logical Drive.
- **Status** – Refers to assignable status of an individual disk drive.
 - Free means available for use in a Disk Array.
 - Assigned means that it currently belongs to the Disk Array shown.
 - Spare means it has been designated as a Hot Spare.
 - Error means not available due to a problem with this physical drive.
- **S.M.A.R.T. Status** – This refers to Self-Monitoring Analysis and Reporting Technology, a form of predictive failure analysis that examines disk drive behavior for indications of a coming failure.
 - Healthy means there are no indications of trouble.
 - Alert means there have been indications that the disk drive could fail soon. If you see an alert, back up your data, then remove and test the disk drive.
 - Disabled means the SMART has been disabled or is not a feature of this disk drive. You must enable SMART function for each Logical Drive.

To see more information about a specific disk drive, click on its  icon.

Physical Drive

The Physical Drive–Information tab gives a description and reports the status of the hard disk drives (physical drives) in the enclosure. To access a physical drive:

1. Click the Subsystem  icon.
2. Click on the VTrak  icon.
3. Click on the Enclosures  icon.
4. Click on the Enclosure  icon.

5. Click on the Physical Drives  icon.
6. Click on the Physical Drive  icon.

Enclosure Front View

The Enclosure Front View shows the enclosure location of the physical drive.

Physical Drive Information

- **Physical Drive Model** – The drive manufacturer's identification.
- **Physical Drive Status** – The functional status of this drive.
 - Functional means normal.
 - Disk is being rebuilt means this drive is the Target Drive of the rebuild operation that is in progress.
 - Disk Offline means this drive is not available for use due to an error. See Rebuild Disk Array.
- **Physical Drive Size** – The effective data storage capacity in gigabytes. This is total capacity, not available capacity.
- **Mode Setting** – The performance level (data transfer speed) at which the physical drive is running. This statistic applies to Parallel ATA disk drives only. If a mode setting is reported for a Serial ATA drive, disregard it.
- **Assignment** – Refers to assignable status of an individual disk drive.
 - Free means available for use in a Disk Array.
 - Assigned means this drive currently belongs to a Disk Array.
 - Spare means this drive is designated as a Hot Spare.
 - Error means this drive is not available due to a problem.
- **ID** – The Controller channel ID number to which this physical drive is attached. If you have a drive on a channel but it does not appear in WebPAM, there is a bad connection.
- **S.M.A.R.T. Status** – Refers to Self-Monitoring Analysis and Reporting Technology, a form of predictive failure analysis that examines disk drive behavior for indications of a coming failure.
 - Healthy means there are no indications of trouble.
 - Alert means there have been indications that the disk drive could fail soon. If you see an alert, back up your data, then remove and test the disk drive.
 - Disabled means the SMART has been disabled or is not a feature of this disk drive. You must enable SMART function for each Logical Drive.
- **Firmware Version** – This refers to the version of the firmware on the disk drive.

- **Serial Number** – This is the manufacturer's serial number for this disk drive. This feature allows you to obtain the number for warranty or support purposes without removing it from the enclosure.
- **Read / Write Counts** – A record of the number of input/output transactions.
- **Read / Write Transactions** – A record of the volume of data in Megabytes.



Disk Arrays

- Disk Array List (below)
- Create a Disk Array (page 111)
- Delete Disk Array (page 116)
- Disk Array Information (page 117)
- Disk Array Settings (page 119)
- Create Logical Drive (page 120)
- Delete Logical Drive (page 121)
- Background Activity (page 121)
- Scheduler (page 122)
- Logical Drive List (page 123)
- Logical Drive (page 124)
- Logical Drive LUN Settings (page 126)
- Logical Drive Alias (page 127)
- Physical Drives (page 127)

Disk Array List

The Disk Array Group–Information tab displays a list of disk arrays along with their status and capacity. A disk array is a collection of physical drives in a RAID. Logical drives are made from disk arrays.

To access the Disk Array list:

1. Click on the Subsystem  icon in Tree View.
2. Click on the VTrak  icon.



Click on the Disk Arrays  icon.

Disk Array Parameters

- **Device ID** – This is the ID number assigned by WebPAM PRO for an individual disk array.
- **Alias** – A user-specified name for the disk array.
- **Status** – This refers to functional status of this disk array.
- **Configurable Capacity** – This is the data storage capacity available for new and existing logical drives.
- **Free Capacity** – This is the data storage capacity available for new logical drives.

Create a Disk Array

A disk array is a collection of physical drives in a RAID. Logical drives are made from disk arrays. To access the Disk Array tab:

1. Click on the Subsystem  icon in Tree View.
2. Click on the VTrak  icon.
3. Click on the Disk Arrays  icon.
4. Click on the Create tab.

There are three ways to create a new disk array:

- **Automatic** – Creates a new disk array following a default set of parameters. Makes one logical drive automatically
- **Express** – You choose the parameters for a new disk array by specifying the characteristics you want. You can create multiple logical drives at the same time, however they will all be identical
- **Advanced** – You directly specify all parameters for a new disk array. Makes one logical drive automatically. You can create additional logical drives at a later time

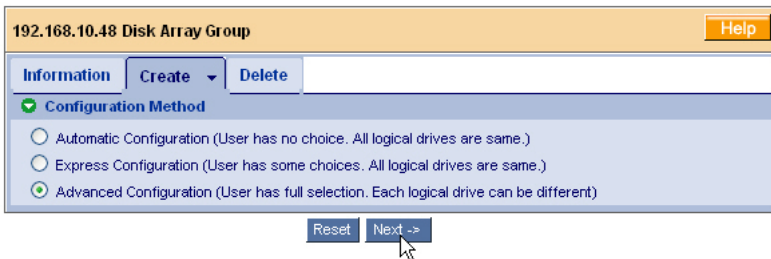

192.168.10.48 Disk Array Group Help

Information **Create** ▾ Delete

Configuration Method

Automatic Configuration (User has no choice. All logical drives are same.)

Express Configuration (User has some choices. All logical drives are same.)

Advanced Configuration (User has full selection. Each logical drive can be different)

Reset **Next ->**

Click the radio button of the method you want then click the **Next** button.

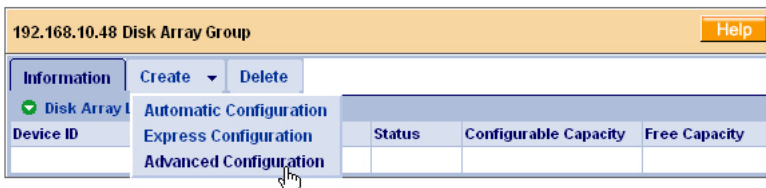

192.168.10.48 Disk Array Group Help

Information **Create** ▾ Delete

Disk Array

Automatic Configuration			
Express Configuration			
Advanced Configuration			

Device ID	Status	Configurable Capacity	Free Capacity

Or select one of these methods from the dropdown menu in the Create tab.

Automatic Option

The Disk Array Automatic Creation option enables you to create a new disk array following a default set of parameters. One logical drive will be made automatically when you create the disk array.

The screenshot shows a web-based configuration interface for a '192.168.10.48 Disk Array Group'. It features a 'Help' button in the top right corner and three main tabs: 'Information', 'Create', and 'Delete'. The 'Create' tab is active, displaying configuration options for three categories: Disk Arrays, Logical Drives, and Spare Drives.

Disk Arrays

Number of Physical Drives	6
Physical Drive Slot Nos	2 6 7 8 10 14
Configurable Capacity	641 GB
Number of Logical Drives	1

Logical Drives

#	RAID Level	Capacity	Stripe Block Size
1	RAID 5	641 GB	64 KB

Spare Drives

Physical Drive Slot Nos	11
-------------------------	----

A 'Submit' button is located at the bottom center of the form, with a mouse cursor pointing to it.

When you choose the Automatic option, the following parameters display:

- **Disk Arrays** – The number of physical drives in the disk array, their ID numbers, configurable capacity and the number of logical drives to be created
 - **Logical Drives** – The ID number of the logical drive(s), their RAID level, capacity and stripe size
 - **Spare Drives** – The physical drive ID number of the dedicated hot spare assigned to this disk array
1. Review the parameters. If you accept them, proceed to the next step.
If you do NOT accept these parameters, use the Express or Advanced option to create your disk array.
 2. When you are done, click the **Submit** button.

The new disk array appears in the Disk Array List on the Information tab.

Proceed to Create Logical Drive (page 120).

Express Option

The Disk Array Express Creation option enables you to choose the parameters for a new disk array by specifying the characteristics you want. With this method, you can create multiple logical drives at the same time you create your disk array. However, all of the logical drives will be the same.

192.168.10.48 Disk Array Group
Help

Information
Create ▾
Delete

✔ Disk Arrays

Redundancy	<input checked="" type="checkbox"/>
Capacity	<input type="checkbox"/>
Performance	<input checked="" type="checkbox"/>
Spare Drive	<input checked="" type="checkbox"/>
Number of Logical Drives	<input type="text" value="1"/>
Application Type	File Server ▾
Automatic Update	<input checked="" type="checkbox"/> Update

✔ Disk Arrays

Number of Physical Drives	9
Physical Drive Slot Nos	2 5 6 7 8 9 10 11 14
Configurable Capacity	804 GB
Number of Logical Drives	1

✔ Logical Drives

#	RAID Level	Capacity	Stripe Block Size
1	RAID 50	804 GB	64 KB

✔ Spare Drives

Physical Drive Slot Nos	3
-------------------------	---

Reset
Submit

To create a new disk array:

1. Check the boxes to select any one or combination of the following:
 - **Redundancy** – The array will remain available if a physical drive fails
 - **Capacity** – The greatest possible amount of data capacity
 - **Performance** – The highest possible read/write speed
 - **Spare Drive** – A hot spare drive
2. In the Number of Logical Drives field, type the number of logical drives you want to make from this disk array.
The maximum possible number of logical drives appears to the right of this field.
3. From the Application Type menu, select an application that best describes your intended use for this disk array: File Server
 - Video Stream
 - Transaction Data
 - Transaction Log

- Other
4. Click the **Update** button.
 Or check the Automatic Update box and updates will occur automatically.
 The following parameters display:
 - **Disk Arrays** – The number of physical drives in the disk array, their ID numbers, configurable capacity and the number of logical drives to be created
 - **Logical Drives** – The ID number of the logical drive(s), their RAID level, capacity and stripe size
 - **Spare Drives** – The physical drive ID number of the dedicated hot spare assigned to this disk array
 5. If you accept these parameters, proceed to the next step.
 If you do NOT accept these parameters, review and modify your selections in the previous steps.
 6. When you are done, click the **Submit** button.

The new disk array appears in the Disk Array List on the Information tab.

Proceed to Create Logical Drive (page 120).

Advanced Option

The Disk Array Advanced Creation option enables you to directly specify all parameters for a new disk array. One logical drive will be made automatically when you create the disk array. If you select less than the total available capacity, you can use the remaining space to create additional logical drives at a later time.

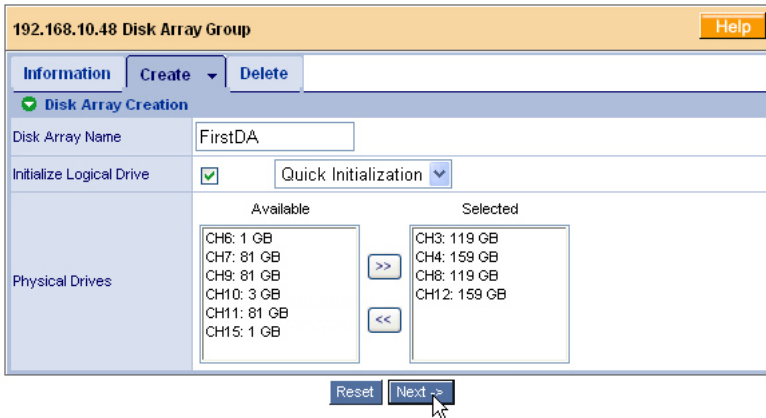

To create a new disk array:

1. Enter a name for the disk array in the field provided.
2. Check the box to enable initialization, if desired.

If you checked the initialization box, select the type of initialization from the dropdown menu.

- **Quick** – Erases the reserve sectors of the physical drives being added to the disk array.
 - **Full** – Erases all sectors of the physical drives being added to the disk array.
3. Highlight physical drives you want in the disk array from the Available list and press the >> button to move them to the Selected list.
You can also double-click them to move them.
 4. When you are done, click the **Next** button.

5. Choose a RAID level from the dropdown menu.
The choice of RAID levels depends on the number of physical drives you selected.
6. Specify a Capacity and the unit of measure (MB, GB, TB).
This value will be the data capacity of the first logical drive in your new disk array. If you specify less than disk array's maximum capacity, the remainder will be available for additional logical drives which you can create later.
7. Specify a Stripe size from the dropdown menu.
4, 8, 16, 32 and 64 KB are available, 64 KB is the default.
8. Click the **Next** button.
The Creation Summary lists the disk array information you specified.

192.168.10.48 Disk Array Group
Help

Information
Create ▾
Delete

✔ Disk Array Creation Summary

Disk Array Alias	FirstDA
Number of Physical Drives	4
Physical Drive Slot Nos	3 4 8 12
Configurable Capacity	100 GB
Free Capacity	257 GB

✔ New Logical Drives

Alias	RAID Level	Capacity	Stripe	Sector
FirstDA	5	100 GB	64 KB	

← Back
Submit

9. If you accept these parameters, proceed to the next step.
If you do NOT accept these parameters, review and modify your selections in the previous steps.
10. When you are done, click the **Submit** button.

The new disk array appears in the Disk Array List on the Information tab.

Proceed to Create Logical Drive (page 120).

Delete Disk Array



Caution

When you delete a disk array, you delete all the logical drives and the data they contain. Back up all important data before deleting a disk array.

To delete a disk array, do the following:





1. Click on the Subsystem icon in Tree View.
2. Click on the VTrak icon.
3. Click on the Disk Arrays icon.
4. Click on the Delete tab.
5. Check the box to the left of the disk array you want to delete.
6. Click the **Submit** button.
7. Click the **OK** in the confirmation box.

The selected disk array disappears from the Disk Array List on the Information tab.

Disk Array Information

The Disk Array–Information tab gives a description and reports the status of the physical drives and logical drives that belong to this disk array. A disk array is a collection of physical drives in a RAID. Logical drives are made from disk arrays.

To access a disk array:

1. Click on the Subsystem  icon in Tree View.
2. Click on the VTrak  icon.
3. Click on the Disk Arrays  icon.
4. Click on the Disk Array  icon.

If you have used previous versions of WebPAM PRO, you may be unfamiliar with the term "disk array". In earlier versions of WebPAM PRO, disk arrays and logical drives were created and managed as a single entity called "logical drive".

In the latest version of WebPAM PRO, disk arrays and logical drives are created separately. This change offers much greater flexibility in logical drive management. As a result of the change, many of the features previously associated with logical drives, such as RAID level, migration, synchronization and rebuilding are now managed under disk arrays. They are the same functions as before.

Enclosure Front View

The Enclosure Front View shows the enclosure location of the physical drives that belong to this disk array.

Disk Array Information

- **Disk Array ID** – This is the ID number assigned by WebPAM PRO for this disk array.
- **Alias** – A user-specified name for the disk array.
- **Operational Status** – Functional, Synchronizing, Rebuilding, Critical, or Offline (see definitions below).
- **Configurable Capacity** – This is the data storage capacity available for new and existing logical drives.
- **Free Capacity** – This is the data storage capacity available for new logical drives.
- **Number of Physical Drives** – The number of physical drives that belong to this disk array.

- **Number of Logical Drives** – The number of logical drives that belong to this disk array.
- **Supported RAID Level** – The RAID level of this disk array.
- Physical Drives in the Disk Array
 - **Slot No.** – This is the slot number of a physical drive that belongs to this disk array.
 - **Model** – The physical drive's model name from the manufacturer.
 - **Type** – Serial ATA (SATA) or Parallel ATA (PATA).
 - **Configurable Capacity** – This is the available data storage capacity of this physical drive.
 - **Status** – This refers to functional status of this physical drive.
 - Functional means normal.
 - Disk is being rebuilt means this drive is the Target Drive of the rebuild operation that is in progress.
 - Disk Offline means this drive is not available for use due to an error. See Rebuild Disk Array.
- Logical Drives in the Disk Array
 - **Device ID** – This is the ID number of a logical drive that belongs to this disk array.
 - **Alias** – A user-specified name for this logical drive.
 - **RAID Level** – This is the RAID level of this logical drive.
 - **Capacity** – This is the available data storage capacity of this physical drive.
 - **Status** – Functional, Synchronizing, Rebuilding, Critical, or Offline (see definitions below).

Disk Array and Logical Drive Status Definitions





- **Functional** – This is the normal state of a logical drive. When a logical drive is Functional, it is ready for immediate use. For RAID Levels other than RAID 0 (Striping), the logical drive has full redundancy.
- **Synchronizing** – This condition is temporary. Synchronizing is a maintenance function that verifies the integrity of data and redundancy in the logical drive. When an logical drive is Synchronizing, it will function and your data is available. However, access will be slower due to the synchronizing operation.
- **Rebuilding** – This condition is temporary. When a physical drive has been replaced, the logical drive automatically begins rebuilding in order to restore redundancy (fault tolerance). When a logical drive is rebuilding, it will function and your data is available. However, access will be slower due to the rebuilding operation.

- **Critical** – This condition arises as the result of a physical drive failure. A Critical logical drive will still function and your data is still available. However, the logical drive has lost redundancy (fault tolerance). You must determine the cause of the problem and correct it.
- **Offline** – This condition arises as the result of a second physical drive failure. An Offline logical drive is not accessible but some or all of your data may remain intact. You must determine the cause of the problem and correct it.

Disk Array Settings

The Disk Array–Settings tab enables you to make settings for an individual disk array. This tab applies to VTrak models only.

To access a disk array settings:

1. Click on the Subsystem  icon in Tree View.
2. Click on the VTrak  icon.
3. Click on the Disk Arrays  icon.
4. Click on the Disk Array  icon.
5. Click the Settings tab.
6. Enter an alias in the field.
7. Check the box to enable Auto Rebuild.
8. Check the box to enable SMART check on the hard disk drives.
9. Check the box to enable the hard disk drives' write caches.
10. Check the box to set the VTrak's cache to Write Back operation.
11. Uncheck to set the cache to Write Through operation.
12. From the popup menu, select High or Low for Rebuild priority.
13. From the popup menu, select High or Low for Synchronize priority.
14. From the popup menu, select High or Low for Migration priority.
 - A High priority allocates more subsystem resources to this function and less for regular read/write operation.
 - A Low setting allocates more resources to read/write operations but can cause the function to take longer to complete.
15. Check the box to enable PDM Auto Start.
16. Click the **Submit** button when you are done.







Important

You must enable Media Patrol and PDM on the VTrak in order for them to work on your disk array.

Create Logical Drive

When you create a disk array, you automatically create one logical drive also. If the initial logical drive used less than the full capacity of the disk array, you can create additional logical drives from the same disk array.

To create a logical drive:

1. Click on the Subsystem  icon in Tree View.
2. Click on the VTrak  icon.
3. Click on the Disk Arrays  icon.
4. Click on the Disk Array  icon.
5. Click on the Create LD tab.

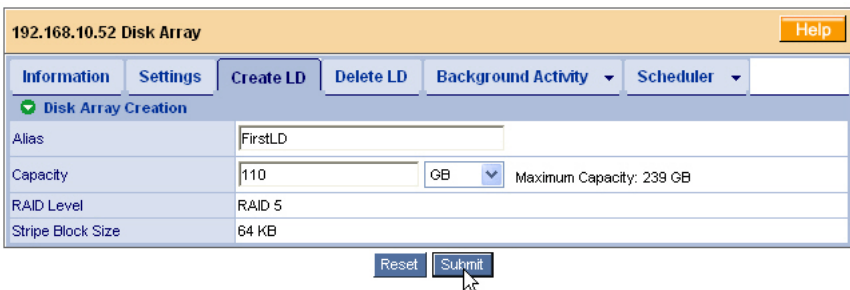

192.168.10.52 Disk Array		Help	
Information	Settings	Create LD	Delete LD
Background Activity ▾ Scheduler ▾			
Disk Array Creation			
Alias	FirstLD		
Capacity	110	GB	Maximum Capacity: 239 GB
RAID Level	RAID 5		
Stripe Block Size	64 KB		
		Reset	Submit

6. Enter an alias (name) in the field.
7. Enter a capacity and select unit of measure (MB, GB, TB).
The default value is the available capacity of the disk array. You can use this value or any lesser amount.
8. Click the **Submit** button when you are finished.

The new logical drive appears in the Logical Drive List on the Information tab.

In order to use this logical drive to read and write data, you must partition and format it using the Host PC's operating system.

Delete Logical Drive







Caution

When you delete a logical drive, all the data it contains is also deleted. Back up all important data before deleting a logical drive.

The Disk Array–Delete LD tab enables you to delete a logical drive under this disk array.





To delete a logical drive:

1. Click on the Subsystem  icon in Tree View.
2. Click on the VTrak  icon.
3. Click on the Disk Arrays  icon.
4. Click on the Disk Array  icon.
5. Click on the Delete LD tab.
6. Check the box to the left of the logical drive you want to delete.
7. Click the **Submit** button.
8. Click **OK** in the confirmation box.

The selected logical disappears from the Logical Drive List on the Information tab.

Background Activity

The Disk Array–Background Activity tab reports the background activities currently running. Normally, you will not be aware that these processes are running because the subsystem continues to function. To access background activity:

1. Click on the Subsystem  icon in Tree View.
2. Click on the VTrak  icon.
3. Click on the Disk Arrays  icon.
4. Click on the Disk Array  icon.
5. Click on the Background Activity tab.

The Background activities include:

- **Migration** – To migrate a disk array is to change its RAID level. In some cases, it is necessary to increase the number of physical drives in the array in order to achieve the target RAID level. The action of adding disk drives to

an array is called "expansion". Because migration and expansion are closely related, the Migration feature handles both. Note that the available target RAID levels depend on the number physical drives in the current array and the number of free physical drives.





- **Manual Rebuild** – When you rebuild a fault-tolerant disk array, you are actually rebuilding the data on one disk drive. Normally, a disk array would rebuild itself after going Critical. However, if the Auto Rebuild function is disabled, you must initiate the procedure.
- **Synchronization** – Synchronization is a routine maintenance procedure for fault-tolerant disk arrays (those with redundancy) that ensures all the data matches exactly. You can initiate this procedure automatically through the Synchronization Schedule. See Scheduler, below.
- **Redundancy Check** – Redundancy Check is a routine maintenance procedure for fault-tolerant disk arrays(those with redundancy) that ensures all the data matches exactly. Unlike Synchronization, Redundancy Check only checks and reports, it does not correct inconsistencies.
- **PDM** – Predictive Data Migration (PDM) is the migration of data from the suspect disk drive to a spare disk drive, similar to Rebuilding a fault-tolerant disk array. Unlike Rebuilding a Logical Drive, PDM copies your data to a spare disk drive before the original disk drive fails and your Logical Drive goes Critical. You can configure PDM to run automatically.

Fault-tolerant disk arrays include RAID 1, 3, 5, 10 and 50. RAID 0 and JBOD are not fault-tolerant. For more information, see Chapter 7.

Scheduler

The Disk Array–Scheduler tab enables you to schedule synchronization for an individual disk array. Synchronization is a routine maintenance procedure for fault-tolerant disk arrays (those with redundancy) that ensures all the data matches exactly. You can also initiate synchronization manually. See Background Activity, above.

To set the scheduler:

1. Click on the Subsystem  icon in Tree View.
2. Click on the VTrak  icon.
3. Click on the Disk Arrays  icon.
4. Click on the Disk Array  icon.
5. Click on the Scheduler tab.
6. From the dropdown menu on the Scheduler tab, select *Array Synchronization*.

The Scheduler Information window appears.

7. Click the radio button to select the time interval (minute, hour, day, week, month).
 8. Make your settings.
 - For minute and hour intervals, specify the time period (30 to 59 minutes, 1 to 23 hours).
 - For day, week and month intervals, specify the start time (using a 24-hour clock).
 - For week intervals, specify a day of the week from the dropdown menu.
 - For month intervals, specify a day of the month from the dropdown menu.
 9. Click the **Submit** button when you are done.
- The new scheduler settings will appear in the Scheduler tab.





To turn off the scheduler and disable scheduled synchronization:

1. Repeat steps 1 through 5 above.
2. Click on the Disable Logical Drive Synchronization Schedule radio button.
3. Click the **Submit** button.

Logical Drive List

The Logical Drives–Information tab gives a description and reports the status of the logical drives that belong to this disk array. A disk array is a collection of physical drives in a RAID. Logical drives are made from disk arrays. The PC's operating system recognizes the logical drive as if it were a single physical drive. You can write data to and read data from a logical drive in the VTrak enclosure as if it were a physical drive inside the PC.

To see the logical drives under a disk array:

1. Click on the Subsystem  icon in Tree View.
2. Click on the VTrak  icon.
3. Click on the Disk Arrays  icon.
4. Click on the Disk Array  icon.

Click on the Logical Drives  icon.

Logical Drive Parameters

- **Device ID** – The unique ID number for each logical drive.

- **Alias** – A user-specified name for the logical drive. If the logical drive was created at the same time as its disk array, it will have the same alias.
- **RAID Level** – The RAID of the logical drive. If the logical drive was created at the same time as its disk array, it will have the same RAID level
- **Disk Array ID** – The disk array ID number to which this logical drive belongs.
- **Stripe** – The stripe block size of this logical drive specified at its creation.
- **Status** – The operating condition of a logical drive.
 - **OK / Functional** – This is the normal state of a logical drive. When a logical drive is OK / Functional, it is ready for immediate use. For RAID Levels other than RAID 0 (Striping), the logical drive has full redundancy.
 - **Synchronizing** – This condition is temporary. Synchronizing is a maintenance function that verifies the integrity of data and redundancy in the logical drive. When an logical drive is Synchronizing, it will function and your data is available. However, access will be slower due to the synchronizing operation.
 - **Rebuilding** – This condition is temporary. When a physical drive has been replaced, the logical drive automatically begins rebuilding in order to restore redundancy (fault tolerance). When a logical drive is rebuilding, it will function and your data is available. However, access will be slower due to the rebuilding operation.
 - **Critical** – This condition arises as the result of a physical drive failure. A Critical logical drive will still function and your data is still available. However, the logical drive has lost redundancy (fault tolerance). You must determine the cause of the problem and correct it.
 - **Offline** – This condition arises as the result of a second physical drive failure. An Offline logical drive is not accessible but some or all of your data may remain intact. You must determine the cause of the problem and correct it.





To see more information about a specific logical drive, click on its number in the Device ID list.

Logical Drive

The Logical Drive–Information tab gives a description and reports the status of the selected logical drive. A logical drive is a portion of a disk array. The PC's operating system recognizes the logical drive as if it were a single physical drive. You can write data to and read data from a logical drive in the VTrak enclosure as if it were a physical drive inside the PC.

To see the logical drives under a disk array:

1. Click on the Subsystem  icon in Tree View.

2. Click on the VTrak  icon.
3. Click on the Disk Arrays  icon.
4. Click on the Disk Array  icon.
5. Click on the Logical Drives  icon.
6. Click on a Logical Drive  icon.

From this tab, you can access the Settings tab to set an alias or the LUN Settings tab to specify a SCSI TID and LUN for this logical drive.

Enclosure Front View

The Enclosure Front View shows the enclosure location of the logical drives that belong to this disk array.

Logical Drive Information







- **Logical Drive ID** – The ID number assigned by WebPAM PRO for this logical drive.
- **Alias** – A user-specified name for the logical drive.
- **RAID Level** – The RAID of the logical drive. If the logical drive was created at the same time as its disk array, it will have the same RAID level
- **Operational Status** – The operating condition of a logical drive.
 - **OK / Functional** – This is the normal state of a logical drive. When a logical drive is OK / Functional, it is ready for immediate use. For RAID Levels other than RAID 0 (Striping), the logical drive has full redundancy.
 - **Synchronizing** – This condition is temporary. Synchronizing is a maintenance function that verifies the integrity of data and redundancy in the logical drive. When an logical drive is Synchronizing, it will function and your data is available. However, access will be slower due to the synchronizing operation.
 - **Rebuilding** – This condition is temporary. When a physical drive has been replaced, the logical drive automatically begins rebuilding in order to restore redundancy (fault tolerance). When a logical drive is rebuilding, it will function and your data is available. However, access will be slower due to the rebuilding operation.
 - **Critical** – This condition arises as the result of a physical drive failure. A Critical logical drive will still function and your data is still available. However, the logical drive has lost redundancy (fault tolerance). You must determine the cause of the problem and correct it.

- **Offline** – This condition arises as the result of a second physical drive failure. An Offline logical drive is not accessible but some or all of your data may remain intact. You must determine the cause of the problem and correct it.
- **Capacity** – The data storage capacity of this logical drive.
- **Number of Used Physical Drives** – The number of physical drives used by this logical drive.
- **Stripe Size** – The stripe block size of this logical drive specified at its creation.
- **Disk Array ID** – The disk array ID number to which this logical drive belongs.
- **SCSI Channel 1 TIDs** – The Target IDs assigned to SCSI channel 1.
- **SCSI Channel 2 TIDs** – The Target IDs assigned to SCSI channel 2.

Logical Drive LUN Settings

The Logical Drive–LUN Settings tab enables you to make SCSI Target ID (TID) and Logical Unit Number (LUN) settings for an individual logical drive. VTrak has two data channels which use the SCSI protocol. You can select multiple TIDs each channel and select multiple LUNs for each TID.

To make Logical Drive LUN settings:

1. Click on the Subsystem  icon in Tree View.
2. Click on the VTrak  icon.
3. Click on the Disk Arrays  icon.
4. Click on the Disk Array  icon.
5. Click on the Logical Drives  icon.
6. Click on a Logical Drive  icon.
7. Select a TID for channel 1.
8. Select a LUN for the channel 1 TID.
9. Select a TID for channel 2.
10. Select a LUN for the channel 2 TID.
11. Click the **Submit** button when you are done.







Click the Information tab to see the TIDs and LUNs applied to this logical drive.

There are separate TID and LUN settings for the RAID Console. See “LUN Settings” on page 97 and “TID Settings” on page 98.

Logical Drive Alias

The Logical Drive–Settings tab enables you to specify an alias for an individual logical drive.

To specify an alias:

1. Click on the Subsystem  icon in Tree View.
2. Click on the VTrak  icon.
3. Click on the Disk Arrays  icon.
4. Click on the Disk Array  icon.
5. Click on the Logical Drives  icon.
6. Click on a Logical Drive  icon.
7. Click on the Settings tab.
8. Enter an alias in the Alias field.
9. Click the **Submit** button when you are done.

Physical Drives

Physical drives under a disk array are the same as those listed under the Enclosure except that this list is limited to those physical drives that are used in the disk array. See Physical Drive List (page 107) and Physical Drive (page 108).

Spare Drives

- Spare Drive List (page 128)
- Delete a Spare Drive (page 129)
- Create a Spare Drive (page 128)

In WebPAM PRO, there are two types of hot spare drives:



- **Global** – Any unassigned physical drive of adequate size can be used as a hot spare drive for any disk array
- **Dedicated** – A specific unassigned physical drive of adequate size can only be used as the hot spare drive for a specific disk array

The **Global** hot spare drive option becomes active when you enable Auto Rebuild. See Disk Array Settings (page 119) for this setting. There must also be an unassigned disk drive of adequate capacity to replace the failed drive in the disk array. This means that the hot spare drive must be equal to or larger than the failed drive it replaces.

The **Dedicated** hot spare drive option requires you to designate an unassigned disk drive as the hot spare for a specific disk array. This action is described under Create, below.

Spare Drive List

To see a list of the current dedicated hot spare drives:



1. Click on the Subsystem  icon in Tree View.
2. Click on the VTrak  icon.
3. Click on the Spare Drives  icon.

A list of spare drives displays the following information.



- **#** – This is the individual number of a spare drive.
- **Physical Drive ID** – This is the slot number of a physical drive that has been designated as a spare drive.
- **Capacity** – This is the available data storage capacity of this physical drive.
- **Spare Type** – All spare drives under this function are Dedicated spares.
- **Dedicated Disk Arrays** – The specific disk array to which this spare drive is dedicated.

Create a Spare Drive

Make these two checks before proceeding:

- Click on the Settings tab under the Disk Array  icon and verify that Auto Rebuild is enabled (checked).
- Click on the Physical Drives  icon under the Disk Array  icon and verify the size of the physical drives in the disk array. You will need this information to select a physical drive of adequate capacity.

To create a new dedicated hot spare drive:

1. Click on the Subsystem  icon in Tree View.
2. Click on the VTrak  icon.
3. Click on the Spare Drives  icon.
4. Click on the Create tab.

The Create Spare Drives page displays.



5. From the first dropdown menu, select the disk array to which the spare drive will be assigned.
6. From the second dropdown menu, select an unassigned physical drive as the spare drive.
Be sure the spare drive is of equal or greater capacity than the largest physical drive in the disk array.
7. Click the **Submit** button when you are done.

The new dedicated hot spare drive appears in the list and in the Tree.

If you did not successfully create a spare drive, verify that the selected physical drive was of equal or greater capacity than the largest physical drive in the disk array.

Delete a Spare Drive

To delete an existing spare drive is to remove the physical drive from service as a dedicated hot spare. This action is required if you want to use this physical drive in a disk array, for example.

1. Click on the Subsystem  icon in Tree View.
2. Click on the VTrak  icon.
3. Click on the Spare Drives  icon.
4. Click on the Delete tab.
The spare drive list displays.
5. Check the delete box beside the physical drive you want to remove from service as a hot spare.
6. Click the **Submit** button when you are done.



Logical Drive Summary

- Logical Drive List (below)
- Logical Drive (page 131)

Logical Drive List

The Logical Drive Summary is a list of all logical drives in the VTrak enclosure. This function lists all of the logical drives together, without the need to navigate through multiple disk arrays. The information here is exactly the same as shown under the disk arrays.

To see the logical drives under a Logical Drive Summary:

1. Click on the Subsystem  icon in Tree View.
2. Click on the VTrak  icon.
3. Click on the Logical Drive Summary  icon.

Logical Drive Parameters

- **Device ID** – The unique ID number for each logical drive.
- **Alias** – A user-specified name for the logical drive. If the logical drive was created at the same time as its disk array, it will have the same alias.
- **RAID Level** – The RAID of the logical drive. If the logical drive was created at the same time as its disk array, it will have the same RAID level
- **Disk Array ID** – The disk array ID number to which this logical drive belongs.
- **Stripe** – The stripe block size of this logical drive specified at its creation.
- **Status** – The operating condition of a logical drive.
 - **OK / Functional** – This is the normal state of a logical drive. When a logical drive is OK / Functional, it is ready for immediate use. For RAID Levels other than RAID 0 (Striping), the logical drive has full redundancy.
 - **Synchronizing** – This condition is temporary. Synchronizing is a maintenance function that verifies the integrity of data and redundancy in the logical drive. When an logical drive is Synchronizing, it will function and your data is available. However, access will be slower due to the synchronizing operation.
 - **Rebuilding** – This condition is temporary. When a physical drive has been replaced, the logical drive automatically begins rebuilding in order to restore redundancy (fault tolerance). When a logical drive is rebuilding, it will function and your data is available. However, access will be slower due to the rebuilding operation.







- **Critical** – This condition arises as the result of a physical drive failure. A Critical logical drive will still function and your data is still available. However, the logical drive has lost redundancy (fault tolerance). You must determine the cause of the problem and correct it.
- **Offline** – This condition arises as the result of a second physical drive failure. An Offline logical drive is not accessible but some or all of your data may remain intact. You must determine the cause of the problem and correct it.

To see more information about a specific logical drive, click on its number in the Device ID list.

Logical Drive

The Logical Drive–Information tab gives a description and reports the status of the selected logical drive. A logical drive is a portion of a disk array. The PC's operating system recognizes the logical drive as if it were a single physical drive. You can write data to and read data from a logical drive in the VTrak enclosure as if it were a physical drive inside the PC.

To see the logical drives under a disk array:

1. Click on the Subsystem  icon in Tree View.
2. Click on the VTrak  icon.
3. Click on the Disk Arrays  icon.
4. Click on the Disk Array  icon.
5. Click on the Logical Drives  icon.
6. Click on a Logical Drive  icon.

From this tab, you can access the Settings tab to set an alias or the LUN Settings tab to specify a SCSI TID and LUN for this logical drive.

Enclosure Front View

The Enclosure Front View shows the enclosure location of the logical drives that belong to this disk array.

Logical Drive Information

- **Logical Drive ID** – The ID number assigned by WebPAM PRO for this logical drive.
- **Alias** – A user-specified name for the logical drive.
- **RAID Level** – The RAID of the logical drive. If the logical drive was created at the same time as its disk array, it will have the same RAID level

- **Operational Status** – The operating condition of a logical drive.
 - **OK / Functional** – This is the normal state of a logical drive. When a logical drive is OK / Functional, it is ready for immediate use. For RAID Levels other than RAID 0 (Striping), the logical drive has full redundancy.
 - **Synchronizing** – This condition is temporary. Synchronizing is a maintenance function that verifies the integrity of data and redundancy in the logical drive. When an logical drive is Synchronizing, it will function and your data is available. However, access will be slower due to the synchronizing operation.
 - **Rebuilding** – This condition is temporary. When a physical drive has been replaced, the logical drive automatically begins rebuilding in order to restore redundancy (fault tolerance). When a logical drive is rebuilding, it will function and your data is available. However, access will be slower due to the rebuilding operation.
 - **Critical** – This condition arises as the result of a physical drive failure. A Critical logical drive will still function and your data is still available. However, the logical drive has lost redundancy (fault tolerance). You must determine the cause of the problem and correct it.
 - **Offline** – This condition arises as the result of a second physical drive failure. An Offline logical drive is not accessible but some or all of your data may remain intact. You must determine the cause of the problem and correct it.
- **Capacity** – The data storage capacity of this logical drive.
- **Number of Used Physical Drives** – The number of physical drives used by this logical drive.
- **Stripe Size** – The stripe block size of this logical drive specified at its creation.
- **Disk Array ID** – The disk array ID number to which this logical drive belongs.
- **SCSI Channel 1 TIDs** – The Target IDs assigned to SCSI channel 1.
- **SCSI Channel 2 TIDs** – The Target IDs assigned to SCSI channel 2.

Chapter 5: Management with the CLU

- VTrak Status Indicators (below)
- Drive Status Indicators (page 134)
- Audible Alarm (page 136)
- CLU Connection (page 137)
- How to use the CLU (page 140)
- CLU Function Map (page 142)
- Controller Management (page 148)
- Enclosure Management (page 151)
- Physical Drive Management (page 154)
- Disk Array Management (page 160)
- Logical Drive Management (page 172)
- Network Management (page 173)
- SCSI Management (page 180)
- Maintenance Menu (Disk Array Operations) (page 182)
- Event Viewer (page 188)

VTrak Status Indicators

Even though the Command Line Utility offers comprehensive monitoring of VTrak, the LED indicators on the VTrak unit provide important status information.

When the power is switched on, the LEDs on the front of the VTrak will light up.

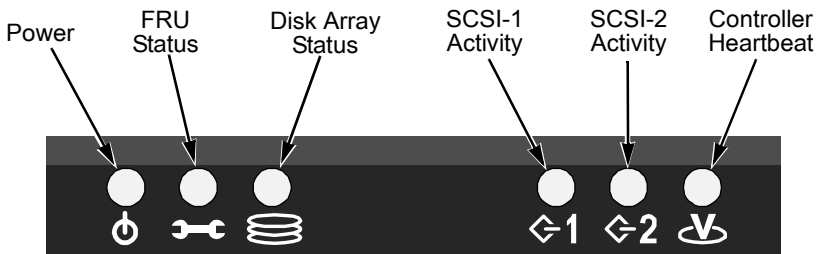

Figure 1. VTrak 15110 Front Panel LEDs

When boot-up is finished and the VTrak is functioning normally:

- Controller LED blinks green once per second for five seconds, goes dark for five seconds, then blinks green once per second for five seconds again.
- Power, FRU and Disk Array LEDs display green continuously.
- SCSI LEDs flash green if there is activity on that channel.

See the table below.

LEDs	State				
	Dark	Steady Green	Flashing Green	Amber	Red
Power	System Off	Normal	n/a	n/a	n/a
FRU*	System Off	Normal	n/a	Fan or Battery Problem	Fan or Battery Failed
Logical Drive	System Off	Normal	n/a	Logical Drive Critical	Logical Drive Offline
SCSI-1 SCSI-2	No Activity	n/a	Activity	n/a	n/a
Controller	System Off	n/a	Normal**	n/a	n/a

* Field Replacement Unit. "n/a" means this state does not apply to this LED.
 ** Blinks five times in five seconds, five seconds dark, blinks five times again.

See page 189 for more information about field-replaceable components.
 See page 234 for a discussion of critical and offline logical drives.

Drive Status Indicators

There are two LEDs on each Drive Carrier. They report the presence of power and a disk drive, and the current condition of the drive.

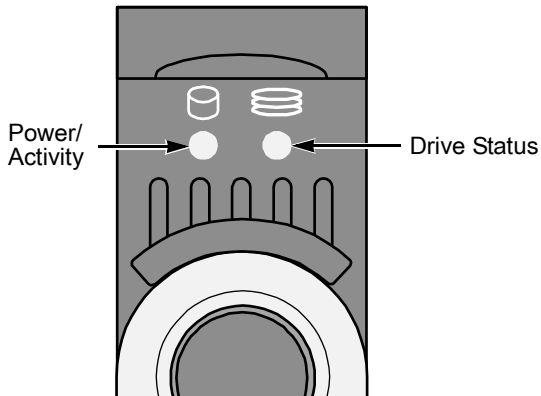

Figure 2. VTrak Drive Carrier LEDs

The VTrak spins up the disk drives sequentially in order to equalize power draw during start-up. After a few moments the LEDs will display as described in the table below.

LEDs	State				
	Dark	Steady Green	Flashing Green	Amber	Red
Power/Activity	No Drive	Drive Present	Activity	n/a	n/a
Status	No Power	Drive OK	n/a	Drive Rebuilding	Drive Error
"n/a" means this state does not apply to this LED.					

See page 234 for a discussion of rebuilding and failed disk drives.

Audible Alarm

VTrak's audible alarm (buzzer) has three sound patterns:

- Beep. Beep. Beep. – Indicates that a logical drive is rebuilding
- Beep-beep, beep-beep, beep-beep. – Indicates that a logical drive is critical
- Beep-beep-beep. Beep-beep-beep. – Indicates a problem with a field replaceable unit (FRU)
- 10 second continuous beep – Indicates that a logical drive is offline

See page 189 for more information about field-replaceable components.

See page 234 for a discussion of critical and offline logical drives.

Alarm Settings

- Enable – Sounds for all conditons listed above.
- Disable – Does not sound for any condition.
- Silence – Stops the alarm from sounding for the current event. If another event happens, the alarm will sound again.

To change Audible alarm settings:

1. From the CLU Main menu, press **9**.

The buzzer options appear.

Buzzer

1. Silence Buzzer
2. Disable Buzzer
- R. Return to Previous Menu

Please enter your menu choice>

2. Do one of the following:
 - To silence the buzzer (for the current event only), press **1** and **Enter**.
 - To disable the buzzer (off until enabled again), press **2** and **Enter**.
Silence/Disable/Enable buzzer(y/n)?>
3. Press **Y** and **Enter** to confirm your choice.

If you disabled the buzzer, repeat the same procedure enable it again.

CLU Connection

There are two connections methods for the CLU:

- Serial – Requires a null modem cable (included with VTrak) to connect the serial ports on the Host PC and VTrak
- Telnet – Requires a network connection between the Host PC and VTrak's Management Port.

Serial Connection

Before you begin, be sure the null modem cable is connected between the Host PC and VTrak, and that both machines are booted and running.

1. Start your PC's terminal emulation program.
2. Press **Enter** once to launch the CLU.

Telnet Connection

If your Telnet connection has not been setup, refer to Chapter 2.

To start the telnet program,

1. Go to the command line prompt (Windows) or click the terminal icon (Linux), then run:

```
telnet 192.168.1.56 2300
```

The IP address above is only an example. Use your VTrak's Management port IP address. *2300* is the Telnet port for the VTrak.

The telnet login screen appears:

```
Telnet Login  
Please enter your user name>administrator  
Please enter the password for user administrator>*****
```

2. Type the user name and password.

The default user name is *administrator*. The default password is *password*.

The CLU Main Menu appears.

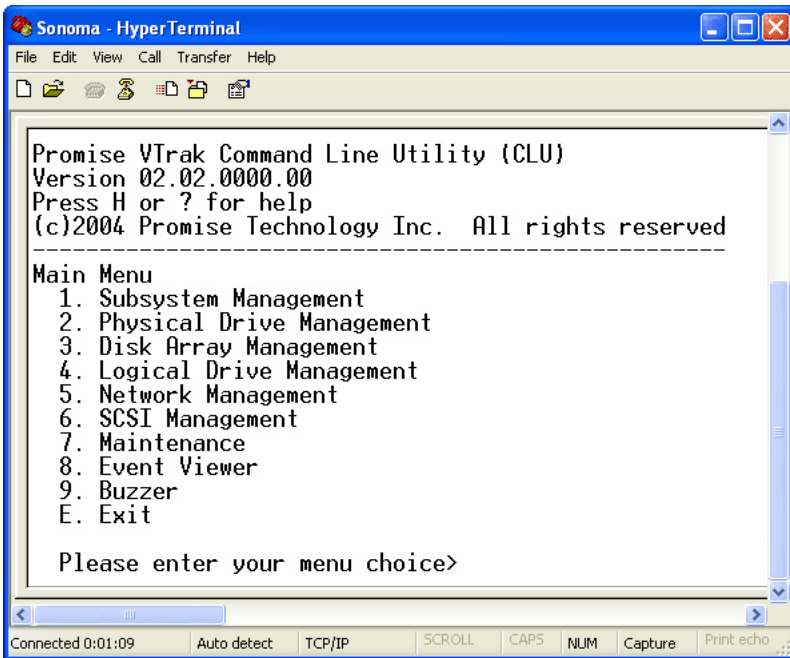

There are nine functional groups in the CLU:

Subsystem Management – Allows you view controller information, change parameters, monitor the enclosure, update the firmware and reboot the VTrak.

Physical Drive Management – Enables you to view disk drive assignments and parameters, wipe boot and reserve sectors, change disk drive settings and perform diagnostics.

Disk Array Management – Allows you to view disk array information, create and delete disk arrays and logical drives, cache policy, hot spare policy, retry count, SMART settings; rebuilding, synchronization and migration priorities.

Logical Drive Management – Allows you to view logical drive information, name logical drives and change LUN settings.

Network Management – Make Management Port, Telnet, and SNMP settings, set IP address for management port, TFTP server and gateway; and set subnet mask.

SCSI Management – Set channel TIDs and Console LUN.

Maintenance – Enable or disable the Maintenance Activity Monitor and Media Patrol; migrate Logical Drives; manually rebuild, synchronize, run PDM and Redundancy Check on Logical Drives.

Event Viewer – View the event log.

Buzzer – Enable, disable or silence the buzzer (audible alarm).

Exit the CLU

1. From the Main Menu, press **E** and **Enter** to exit.
2. Press **Y** and **Enter** to confirm.
3. Close the terminal emulation, Telnet or terminal window.

How to use the CLU

All directions begin at the CLU Main Menu. From that point, the keystrokes are listed to take you to the appropriate submenu. Depending on your VTrak model, some functions require you to specify a Port, Disk Array or Logical Drive by its ID number.

For example:

Hot Spare Policy - Main Menu, 3 Enter, 4 Enter

1. Start at the Main Menu.
2. Press **3** and **Enter**. The Disk Array Management submenu appears.

```
PDM Auto Start option: Enabled
ID Name          RAID  SBS   CAP   Member PDs  Status
-----
1 Daniels Array  5     64K  240GB  1,3-4,7    Functional
2 Kirts Array   5     64K  270GB  2,5-6,8    Functional
-----
```

Disk Array Management

1. Disk Array Auto Creation
2. Create New Disk Array
3. Delete Disk Array
4. Disk Array Properties
5. PDM Auto Start Option
- R. Return to Previous Menu

Please enter your menu choice>**4**

3. Press **4** and **Enter**. Because there is more than one Disk Array, the CLU asks to specify the one you want by ID number.

Enter the Disk Array ID>**1**

4. Press **1** and **Enter** to select Disk Array ID 1.

The Disk Array Properties submenu displays.

```
Stripe Block Size: 64K
Disk Array #1 Mapping: GB
```

```
-----
| 100 GB | 100 GB | 39 GB |
-----
```

```
-----
Name: Daniels Array
RAID Level:          5           Member LDs:         1-2
Stripe Block Size:  64K         Capacity:           240 GB
Member PDs:         1,3-4,7     SMART Check:       On
Cache Policy:       Write Through  Retry Count:       2
-----
```

Auto Rebuilding: On Hot Spare Policy: Global
 Priority: High(RBLD), High(SYNC), High(Migration), High(RC), High(PDM)

Disk Array 1 Properties
 1. Create Logical Drive
 2. Delete Logical Drive
 3. Cache Policy
 4. Retry Count
 5. Enable/Disable SMART
 6. Name
 7. Priority
 8. Hot Spare
 9. Auto Rebuilding
 R. Return to Previous Menu

Please enter your menu choice>**8**

5. From this submenu, press **8** and **Enter** to access the Hot Spare Policy function.

Current hot spare policy:
 Global

Change to Dedicated hot spare policy for LD 1(y/n)?>**y**

6. Press **Y** and **Enter** to change the Hot Spare Policy to Dedicated.
 The physical drives selection appears.

```
*****Physical Drives Selection*****
ID          Name                Capacity
-----
  9         WDC WD1200JD-00FYB0   120 GB
 11         ST380013AS                80 GB
 12         WDC WD1200JD-00FYB0   120 GB
```

Enter Physical Drive ID to select.
 Press R to continue after you have finished
 selecting Physical Drive.

Your input?>**9**

7. From this submenu, press **9** and **Enter** to select the disk drive ID 9.
 The previous screen reappears with disk drive ID 9 selected.

```
*****Physical Drives Selection*****
ID          Name                Capacity
-----
* 9         WDC WD1200JD-00FYB0   120 GB
```

```

11      ST380013AS          80 GB
12      WDC WD1200JD-00FYB0 120 GB
    
```

Enter Physical Drive ID to select.
 Press R to continue after you have finished selecting Physical Drive.

Your input?>r

8. Press **R** to finish your selection and press **Enter**.

The Disk Array Properties submenu displays. Note that Hot Spare Policy has changed to Dedicated with the physical drive 9 (PD9) as the hot spare.

```

Stripe Block Size: 64K
Disk Array #1 Mapping: GB
    
```

```

-----
| 100 GB | 100 GB | 39 GB |
-----
    
```

```

-----
Name: Daniels Array
RAID Level:      5           Member LDs:    1-2
Stripe Block Size: 64K      Capacity:      240 GB
Member PDs:     1,3-4,7     SMART Check:   On
Cache Policy:   Write Through  Retry Count:   2
Auto Rebuilding: On        Hot Spare Policy: Dedicated(PD9)
Priority: High(RBLD), High(SYNC), High(Migration), High(RC), High(PDM)
    
```

Disk Array 1 Properties

1. Create Logical Drive
2. Delete Logical Drive
3. Cache Policy
4. Retry Count
5. Enable/Disable SMART
6. Name
7. Priority
8. Hot Spare
9. Auto Rebuilding
- R. Return to Previous Menu

Please enter your menu choice>

This concludes the example.

CLU Function Map

The map below is designed to help you navigate to the submenu where each function is located. The paths in this map do not activate the functions.

A

Auto Rebuilding, Disk Array – Main Menu, 3 Enter, 4 Enter
Auto Start, PDM – Main Menu, 3 Enter

B

Back Plane Box – Main Menu, 1 Enter, 1 Enter, 4 Enter
Battery – Main Menu, 1 Enter, 2 Enter
Battery Board – Main Menu, 1 Enter, 1 Enter, 4 Enter
Boot Sector, Wipe – Main Menu, 2 Enter
Buzzer/Beeper – Main Menu

C

Cache Policy, Disk Array – Main Menu, 3 Enter, 4 Enter
Channel TID, SCSI – Main Menu, 4 Enter
Circuit Boards, VTrak – Main Menu, 1 Enter, 1 Enter, 4 Enter
Contact Person, SNMP – Main Menu, 6 Enter, 4 Enter
Console LUN – Main Menu, 6 Enter

Controller

Information, View – Main Menu, 1 Enter, 1 Enter
Label – Main Menu, 1 Enter, 1 Enter, 2 Enter
Management – Main Menu, 1 Enter
Parameters, Modify – Main Menu, 1 Enter, 1 Enter

Create

Disk Array – Main Menu, 3 Enter
Logical Drive – Main Menu, 3 Enter, 4 Enter

D

Date and Time – Main Menu, 1 Enter, 1 Enter, 2 Enter
Daughter Board – Main Menu, 1 Enter, 1 Enter, 4 Enter
Default Settings

Telnet - Main Menu, 5 Enter, 2 Enter

Delete

Disk Array – Main Menu, 3 Enter
Logical Drive – Main Menu, 3 Enter, 4 Enter

DHCP, Management Port – Main Menu, 5 Enter, 1 Enter

Diagnostics, Physical Drive – Main Menu, 2 Enter

Disk Array

Auto Rebuilding – Main Menu, 3 Enter, 4 Enter
Cache Policy – Main Menu, 3 Enter, 4 Enter
Create – Main Menu, 3 Enter
Delete – Main Menu, 3 Enter
Hot Spare – Main Menu, 3 Enter, 4 Enter
Media Patrol – Main Menu, 7 Enter
Migrate – Main Menu, 7 Enter

Name – Main Menu, 3 Enter, 4 Enter
Properties, Modify – Main Menu, 3 Enter, 4 Enter
PDM Auto Start – Main Menu, 3 Enter
PDM, manual – Main Menu, 7 Enter
Priority – Main Menu, 3 Enter, 4 Enter
Rebuild, manual – Main Menu, 7 Enter
Redundancy Check – Main Menu, 7 Enter
Retry Count – Main Menu, 3 Enter, 4 Enter
SMART – Main Menu, 3 Enter, 4 Enter
Synchronize – Main Menu, 7 Enter

Display (List)

Logical Drives – Main Menu, 4 Enter
Physical Drives – Main Menu, 2 Enter

E

Enclosure Management – Main Menu, 1 Enter
Event Viewer – Main Menu
Exit – Main Menu

F

Fan Box – Main Menu, 1 Enter, 1 Enter, 4 Enter
Fan Speed – Main Menu, 1 Enter, 2 Enter
Firmware Update – Main Menu, 1 Enter, 1 Enter

G

Gateway, Management Port – Main Menu, 5 Enter, 1 Enter

H

Hot Spare Drive – Main Menu, 3 Enter, 4 Enter

I

Information, Controller – Main Menu, 1 Enter, 1 Enter
I/O Statistics, Physical Drive – Main Menu, 2 Enter
IP Address
 Management Port – Main Menu, 5 Enter, 1 Enter
 TFTP Server – Main Menu, 5 Enter
 Trap Sinks, SNMP – Main Menu, 5 Enter, 4 Enter, 6 Enter

L

Label, Controller – Main Menu, 1 Enter, 1 Enter, 2 Enter
LED, Physical Drive, Blink – Main Menu, 2 Enter, 5 Enter
Location, SNMP – Main Menu, 5 Enter, 4 Enter
Logical Drive
 Create – Main Menu, 3 Enter, 4 Enter
 Delete – Main Menu, 3 Enter, 4 Enter

Name – Main Menu, 4 Enter
SCSI LUN – Main Menu, 4 Enter
Logical Drives, Display – Main Menu, 4 Enter
LUN
RAID Console – Main Menu, 6 Enter
Logical Drive – Main Menu, 4 Enter

M

Management, Controller – Main Menu, 1 Enter
Management Port – Main Menu, 5 Enter
DHCP – Main Menu, 5 Enter, 1 Enter
Gateway – Main Menu, 5 Enter, 1 Enter
IP Address – Main Menu, 5 Enter, 1 Enter
Ping – Main Menu, 5 Enter
Subnet Mask – Main Menu, 5 Enter, 1 Enter
Main Board – Main Menu, 1 Enter, 1 Enter, 4 Enter
Maintenance Activity Monitor – Main Menu, 7 Enter
Maintenance Management – Main Menu
Media Patrol, Disk Array – Main Menu, 7 Enter
Migrate Disk Array – Main Menu, 7 Enter
Modify Controller Parameters – Main Menu, 1 Enter, 1 Enter

N

Name
Disk Array– Main Menu, 3 Enter, 4 Enter
Logical Drive– Main Menu, 4 Enter
SNMP – Main Menu, 5 Enter, 4 Enter
Network Management – Main Menu

P

Parameters
Controller – Main Menu, 1 Enter, 1 Enter
Physical Drive – Main Menu, 2 Enter
Password, Telnet – Main Menu, 5 Enter, 2 Enter
PDM Auto Start – Main Menu, 3 Enter
PDM, manual – Main Menu, 7 Enter
Physical Drive
Boot Sector, Wipe – Main Menu, 2 Enter
Diagnostics – Main Menu, 2 Enter
I/O Statistics – Main Menu, 2 Enter
LED Blink – Main Menu, 2 Enter
Management – Main Menu
Parameters, View – Main Menu, 2 Enter
Remapping Table – Main Menu, 2 Enter, 6 Enter
Reserve Sector, Wipe – Main Menu, 2 Enter

Write Cache – Main Menu, 2 Enter
Physical Drives, Display – Main Menu, 2 Enter
Ping, Management Port – Main Menu, 5 Enter
Power Supply – Main Menu, 1 Enter, 1 Enter, 4 Enter
Priority, Disk Array – Main Menu, 3 Enter, 4 Enter
Properties, Disk Array – Main Menu, 3 Enter

R

RAID Console LUN – Main Menu, 6 Enter
Read Only Community, SNMP – Main Menu, 5 Enter, 4 Enter
Reboot VTrak – Main Menu, 1 Enter, 1 Enter
Rebuild Disk Array
 automatic – Main Menu, 3 Enter, 4 Enter
 manual – Main Menu, 7 Enter
Redundancy Check, Disk Array – Main Menu, 7 Enter
Remapping Table – Main Menu, 2 Enter, 6 Enter
Report of Self Test – Main Menu, 2 Enter, 6 Enter
Reserve Sector, Wipe – Main Menu, 2 Enter
Restore Defaults
 Telnet - Main Menu, 5 Enter, 2 Enter
Retry Count, Disk Array – Main Menu, 3 Enter, 4 Enter

S

SCSI

Channel TID – Main Menu, 4 Enter
LUN, Logical Drive – Main Menu, 4 Enter
Management – Main Menu
SEP Board – Main Menu, 1 Enter, 1 Enter, 4 Enter
Self Test, Report – Main Menu, 2 Enter, 6 Enter
 Long – Main Menu, 2 Enter, 6 Enter
 Short – Main Menu, 2 Enter, 6 Enter
 Stop – Main Menu, 2 Enter, 6 Enter
SFP, Fibre Channel – Main Menu, 7 Enter
SMART Enable/Disable – Main Menu, 3 Enter, 4 Enter
SNMP – Main Menu, 5 Enter
 Contact Person – Main Menu, 5 Enter, 4 Enter
 Location – Main Menu, 5 Enter, 4 Enter
 Name – Main Menu, 5 Enter, 4 Enter
 Read Only Community – Main Menu, 5 Enter, 4 Enter
 Trap Only Community – Main Menu, 5 Enter, 4 Enter
 Trap Sinks – Main Menu, 5 Enter, 4 Enter
 Trap Sinks, IP Address – Main Menu, 5 Enter, 4 Enter, 6 Enter
Spare Drives – Main Menu, 3 Enter, 4 Enter
Subnet Mask, Management Port – Main Menu, 5 Enter, 1 Enter

Subsystem Management – Main Menu
Synchronize Disk Array – Main Menu, 7 Enter

T

Telnet – Main Menu, 5 Enter
 Password – Main Menu, 5 Enter, 2 Enter
 Enable/Disable – Main Menu, 5 Enter, 2 Enter
 Timeout – Main Menu, 5 Enter, 2 Enter
 User Name – Main Menu, 5 Enter, 2 Enter
Temperature – Main Menu, 1 Enter, 2 Enter
TFTP Server – Main Menu, 5 Enter
 IP Address – Main Menu, 5 Enter, 3 Enter
Time and Date – Main Menu, 1 Enter, 1 Enter, 2 Enter
Timeout, Telnet – Main Menu, 5 Enter, 2 Enter
Trap Only Community, SNMP – Main Menu, 5 Enter, 4 Enter
Trap Sinks, SNMP – Main Menu, 5 Enter, 4 Enter

U

User Name, Telnet – Main Menu, 5 Enter, 2 Enter

V

Voltage – Main Menu, 1 Enter, 2 Enter
VPD Display – Main Menu, 1 Enter, 1 Enter
VTrak
 Circuit Boards – Main Menu, 1 Enter, 1 Enter, 4 Enter
 Reboot – Main Menu, 1 Enter, 1Enter

W

Wipe Boot/Reserve Sector – Main Menu, 2 Enter
Write Cache, Enable/Disable – Main Menu, 2 Enter

This is the end of the CLU Index.

Controller Management

1. From the Main menu, press **1** and **Enter**, then **1** and **Enter** again to access Controller Management.
2. Press the number of the option you want plus Enter to move to the next submenu.
 - **View Controller Information** – Serial and revision numbers, IP addresses, cache size
 - **Modify Controller Parameters** – Modify the Controller Label (name) and change the date and time
 - **Firmware Update** – Update VTrak's firmware. See page 190 for more information
 - **VPD** – Displays information from these circuit boards: Storage Enclosure Processor, Main Controller, Controller Daughter Card, Battery, Fans, Power Supplies, Backplane, Backplane Daughter Card
 - **Reboot** – Reboot the VTrak subsystem

View Controller Information

From the Controller Management menu, press **1** and **Enter** to view controller information.

```
-----Controller Information-----  
Product: VTrak 15110  
Controller Serial Number: kehhoH  
Controller Label: alias  
Firmware Revision: 02.02.0000.93  
Hardware Revision: 0.1.0.2  
SEP Revision: 2.05  
Telnet: enabled  
DHCP: Enabled  
TFTP Server IP Address: 192.168.10.5  
Date: 1-17-2005  
Time: 1:12:56  
DDR (ECC) Size: 256MB  
SCSI Channel 1 TIDs: 3 4 5  
SCSI Channel 2 TIDs: 6 7 8  
  
Press Enter key to return
```

Modify Controller Parameters

From the Controller Management menu, press **2** and **Enter** to assign a controller label or change the date and time on the VTrak subsystem.

Controller Label: alias
Date: 1-17-2005
Time: 1:15:04

Modify Controller Parameters

1. Controller Label
2. Date and Time
- R. Return to Previous Menu

Please enter your menu choice>

Press **1** and **Enter** to assign a new alias to the VTrak.

Press **2** and **Enter** to change the date and time.

Firmware Update

See "Firmware Update – CLU" on page 192.

VPD

1. From the Controller Management menu, press **4** and **Enter** to access the Vital Product Data (VPD) function

VPD Information

1. SEP Board
2. Main Board
3. Daughter Board
4. Battery Board
5. Cooling Unit 1
6. Cooling Unit 2
7. Power Supply 1
8. Power Supply 2
9. Back Plane
- A. Display All
- R. Return to Previous Menu

Please enter your menu choice>

2. Press the number of the component whose information you want to see then press **Enter**.
3. Press **Enter** to return to the VPD Information menu.

Reboot

1. From the Controller Management menu, press **5** and **Enter** to reboot the VTrak.

WARNING

Reboot VTrak 15110 now(y/n)?>**y**

Please confirm again, reboot VTrak 15110 now(y/n)?>**y**

2. Press **Y** and **Enter** to confirm.
3. Press **Y** and **Enter** to confirm again.

The VTrak will reboot. You can watch the progress in the Terminal window.

Enclosure Management

From the Main menu, press **1** and **Enter** then **2** and **Enter** to access Enclosure Management. Select the component whose performance you want to check.

Fan Speed

From the Enclosure Management menu, press **1** and **Enter** to access Fan Speed.

```
*****Fan Speed*****
Fan #      RPM      Normal Operational Range
-----
1          4753     3750-5250
2          0        3750-5250
3          1917     1350-2850
4          1928     1350-2850
5          1804     1350-2850
6          1804     1350-2850
```

In this example, Fan 2 is not turning. This condition can cause overheating of the VTrak subsystem. A broken fan requires replacement, even if the VTrak temperature readings are currently normal.

Fans 1 and 2 are located on the Power Supplies. As a result, Power Supply 2 requires replacement even if the power output levels are OK.

For information on fan replacement, see .page 197.

Buzzer

From the Enclosure Management menu, press **2** and **Enter** to access the Buzzer (Beeper). You can also access the Buzzer from the Main menu.

The buzzer options appear.

```
-----
Buzzer
1. Silence Buzzer
2. Disable Buzzer
R. Return to Previous Menu

Please enter your menu choice>
```

4. Do one of the following:

- To silence the buzzer (for the current event only), press **1** and **Enter**.
- To disable the buzzer (off until enabled again), press **2** and **Enter**.

```
Silence/Disable/Enable buzzer(y/n)?>
```

5. Press **Y** and **Enter** to confirm your choice.

If you disabled the buzzer, repeat the same procedure enable it again.

Temperature

From the Enclosure Management menu, press **3** and **Enter** to access Temperature.

```
*****Temperature*****
Temperature #   Celsius   Fahrenheit   Normal Operational Range
-----
```

1	27	80	<= 45 Celsius
2	27	80	<= 45 Celsius
3	24	75	<= 45 Celsius
4	23	73	<= 45 Celsius
5	24	75	<= 45 Celsius
6	38	100	<= 55 Celsius

Press Enter key to return

Look for a temperature measurement above the Normal Operational Range. An elevated temperature can be the result of a failed fan or blocked cooling passages. Temperature #6 has a higher range because it is located directly above the main controller board.

Voltage

From the Enclosure Management menu, press **4** and **Enter** to access Voltage.

```
*****Voltage*****
#           Voltage(volts)   Normal Operational Range
-----
```

1	3.39	2.96-3.63
2	5.16	4.48-5.51
3	12.09	0.76-13.19

Press Enter key to return

VTrak has three power buses, 3.3V, 5V and 12V. If a voltage is out of normal operational range, there could be problem with the power supply(ies). Note that bus voltage is the combined output of both power supplies. Therefore do not condemn a power supply based on this voltage reading alone.

For information on power supply replacement, see page 196.

Battery

From the Enclosure Management menu, press **5** and **Enter** to access Battery.

*****Battery*****

Battery Information:

Voltage: 4.13 volts

Capacity: 3841 mAH

Temperature: 29 Celsius (84 Fahrenheit)

Press Enter key to return

A battery is supplied with VTrak to power the cache in the event of a power failure. When fully charged, the battery can supply power up to 72 hours.

For information on battery replacement, see page 201.

For more information on Troubleshooting, see page 221.

Physical Drive Management

The term *Physical Drive* refers to a Hard Disk Drive, as compared to a *Logical Drive* that is made up of one or more physical or disk drives. This manual uses the terms physical drive and disk drive interchangeably.

From the Main Menu, press **2** and **Enter** to access Physical Drive Management.

```
*****Physical Drive (PD) Assignment*****
ID Name                Capacity  Write Cache  Status
-----
1  ST3160023AS         159 GB   Enabled     Assigned(LD 1)
2  WDC WD1200JD        119 GB   Enabled     Error
3  WDC WD1200JD        119 GB   Enabled     Assigned(LD 1)
4  WDC WD1200JD        119 GB   Enabled     Assigned(LD 1)
5  Maxtor 6Y080M0      81 GB    Disabled    Free
7  ST3160023AS         159 GB   Enabled     Dedicated(LD 1)
-----
```

Physical Drive Management

1. View Parameters
2. Enable/Disable Write Cache
3. Wipe Out Boot Sector
4. Wipe Out Reserved Sector
5. Blink Led
6. Diagnostics
7. IO Statistics
- R. Return to Previous Menu

Please enter your menu choice>

The physical drive assignment lists all disk drives by their placement in the VTrak chassis, from left to right, 1 to 15, along with make, model, capacity, write cache status and assignment status.

Status is reported for each disk drive as follows:

- **Free** – Not assigned to any logical drive
- **Assigned(LD 1)** – Assigned to logical drive 1
- **Dedicated(LD 1)** – Assigned as a dedicated hot spare for logical drive 1
- **Error** – This drive is present but offline. You cannot use this drive
- **No ID number** – There is no drive in this channel or VTrak does not recognize the drive

To create a logical drive, see page 165.

To specify a hot spare drive, see page 168.

If you know a disk drive is good but VTrak shows an Error, wipe the drive's reserve sector. From the Physical Drive Management menu, press **7** and **Enter**.

If VTrak does not recognize a disk drive, check for proper installation into the drive carrier and verify that the carrier is properly inserted into the slot.

View Parameters

1. Press **1** and **Enter** to view the parameters of the selected disk drive.
2. Type the ID number of the disk drive you want to see and press **Enter**.

```
-----Physical Drive 1 Parameters-----
```

```
Name: ST3160023AS
Serial Number: 3JS0SZ8Y
Firmware Version: CQ14
Maximum LBA: 312319601
Capacity: 159 GB
Mode Setting: UDMA 5
Write Cache Status: disabled
SMART Status: OK
```

```
Press Enter key to return
```

3. Press **Enter** to return to the Physical Drive Management menu.

Enable/Disable Write Cache

All disk drive write caches are disabled by default. You must enable them individually using this function.

1. Press **2** and **Enter** to enable or disable the write cache in the selected disk drives.

```
Enter PD IDs and/or ID ranges>2
Changing write cache option for PD 2 ...
```

```
Press Enter key to return
```

2. Type the ID numbers of the physical drives for which you want to change the Write Cache option and press **Enter**.

This function simply reverses the current setting of the selected drives. For example, it will enable the write caches in all selected drives only if they are all currently disabled.

3. Press **Enter** to return to the Physical Drive Management menu.

Wipe Out Boot Sector

When a disk drive is bootable, it contains a boot sector. In some cases, a boot sector is undesirable when the disk drive is used in a logical drive. This feature erases the boot sector from the disk drive.

1. Press **3** and **Enter** to wipe the boot sector from the selected disk drives.
Enter PD IDs and/or ID ranges>**5**
Total 1 PD has been selected.
Wipe out boot sector for PD 5(y/n)?>**y**

Wiping out boot sector for PD 5 ...
Press Enter key to return
2. Type the ID numbers of the physical drives for which you want to erase the boot sector and press **Enter**.
3. Press **Enter** to return to the Physical Drive Management menu.

Wipe Out Reserve Sector

When a disk drive belongs to a logical drive, information about that arrangement is stored in the Reserve sector. In some cases, the RAID controller will not use a disk drive that has information in its Reserve sector.

For example, a disk drive that is part of a logical drive fails. If you replace the failed drive with a drive that was previously used in a logical drive, VTrak will not use it to rebuild the present logical drive. You must erase the Reserve sector on the replacement drive first.

1. Press **4** and **Enter** to wipe the Reserve sector from the selected disk drives.
Enter PD IDs and/or ID ranges>**6**
Total 1 PD has been selected.
Wipe out boot sector for PD 6(y/n)?>**y**

Wiping out boot sector for PD 6 ...
Press Enter key to return
2. Type the ID numbers of the physical drives for which you want to erase the Reserve sector and press **Enter**.
3. Press **Enter** to return to the Physical Drive Management menu.

Blink LED

This function causes the Disk Status LED for the specified disk drive to blink (right). This action helps you quickly identify the disk drive you are working on.

1. Press **5** and **Enter** to access Blink LED.
2. Type the ID number of the disk drive whose LED you want to blink and press **Enter**.
3. Press **Enter** to return to the Physical Drive Management menu.

Disk Status LED
blinks green

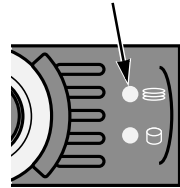

Diagnostics

This function runs the disk drive manufacturer's internal diagnostic program and reports on remapping due to bad sectors on a free disk drive (not assigned to a logical drive). A high level of bad sector remapping signals drive problems.

1. Press **6** and **Enter** to access Diagnostics.

Brief testing status for free Physical Drives:

ID	Self Test	Remapping
3	N/A	total 32, used 0
5	N/A	total 32, used 0
6	N/A	total 32, used 0

Diagnostics

1. Short Self Test
2. Long Self Test
3. Detail Report
4. Remapping Table
5. Stop Self Test
- R. Return to Previous Menu

Please enter your menu choice>1

Enter Physical Drive ID>3

2. Type the Diagnostic operation you want and press **Enter**.

The Short Self Test takes up to 60 seconds. The Long Self Test takes up to 60 minutes.

3. Type the ID number of the disk drive you want to test and press **Enter**.

Note: this test might take up to 60 seconds to complete

Check results later on using Report menu

Press Enter key to return

4. Press **Enter** to return to the Physical Drive Management menu.
5. Press **6** and **Enter** to again access Diagnostics.

The results of the test are displayed.

Brief testing status for free Physical Drives:

ID	Self Test	Remapping
3	self test completed	total 32, used 0
5	N/A	total 32, used 0
6	N/A	total 32, used 0

Diagnostics

1. Short Self Test
2. Long Self Test
3. Detail Report
4. Remapping Table
5. Stop Self Test
- R. Return to Previous Menu

Please enter your menu choice>3

Enter Physical Drive ID>3

6. Press **3** and **Enter** for a detailed report.
7. Type the ID number of the disk drive you want reported and press **Enter**.

Drive Name: Maxtor 6Y080M0

Drive Ser#: Y3K88AWE

Self Test Status:

The previous self-test completed without any error.

Press Enter key to return

8. Press **Enter** to return to the Physical Drive Management menu.

If there is a problem with a disk drive, please contact the Technical Support of the disk drive manufacturer. Promise is not authorized to support the disk drives themselves.

I/O Statistics

This function keeps count statistics on the total of read and write input/outputs and transactions the disk drives have performed. These figures are for information only.

1. Press **7** and **Enter** to access I/O Statistics.

Physical Drives IO Statistics:

ID	Name	Read Count	Read TRANS	Write Count	Write TRANS
1	ST3160023AS	524434	2516 KB	1048576	1066 KB
2	WDC WD1200JD	625306	3146 KB	3497525	2443 KB
3	Maxtor 6Y080M0	321986	1743 KB	2752876	1395 KB

Press Enter key to return

Read and Write Counts record the number of input/output transactions.

Read and Write Transactions record the volume of data in Kilobytes.

2. Press **Enter** to return to the Physical Drive Management menu.

Disk Array Management

From the Main Menu, press **3** and **Enter** to access Disk Array Management. This are deals with disk arrays and logical drives that you create, in contrast to physical drives which are covered under a separate menu.

PDM Auto Start option: Enabled

ID	Name	RAID	SBS	CAP	Member PDs	Status
1	LogDrv1	5	64K	239GB	1-2,4	Functional
2	LogDrv2	5	64K	265GB	3,5,7	SYNC 50%

Logical Drive Management

1. Logical Drive Auto Creation
2. Create New Logical Drive
3. Delete Logical Drive
4. Modify Logical Drive Parameters
5. PDM Auto Start Option
- R. Return to Previous Menu

Please enter your menu choice>

The Logical Drive Magement submenu lists all logical drives in the order of their creation, along with name, RAID level, Stripe Block Size, Capacity, physical drives used and its status.

Status is reported for each logical drive as follows:

- **Functional** – Normal operation
- **Critical** – A physical drive has failed, the logical drive is available but fault tolerance has been lost
- **Offline** – The logical drive is offline and unavailable
- **INIT x%** – Initialization, done at logical drive creation. The logical drive is clearing old, unusuable data from the disk drives.
- **RBLD x%** – Rebuild, a repair operation. The logical drive is rebuilding data or parity to a replacement drive. The target disk drive is cited by ID number. The logical drive is available
- **SYNC x%** – Synchronization, a maintenance operation. The logical drive checks the data and parity and corrects inconsistencies. The logical drive is available
- **PDM x%** – Predictive Data Migration, a maintenance operation. The logical drive moves data from a suspect disk drive to a replacement. The target disk drive is cited by ID number. This action anticipates and prevents a disk drive failure and resulting Critical Status. A replacement disk drive is required. The logical drive is available

- **RC x%** – Redundancy Check. The logical drive is checking data to verify that redundancy or parity match. Unlike Synchronizing, no corrections are made. The logical drive is available
- **MP x%** – Media Patrol. The logical drive is checking disk drives to verify the condition of the magnetic media. Unlike Synchronizing, no corrections are made. The logical drive is available

To create a logical drive, see page 165.

To specify a hot spare drive, see page 168.

If you know a disk drive is good but VTrak shows an Error, wipe the drive's reserve sector. See page 156.

Disk Array Auto Creation

Use this feature to quickly build a disk array using all available disk drives. You specify the RAID level. The other options are chosen automatically. See page 205 for a discussion of RAID Levels and the number of drives each supports.

1. From the Main menu, press **3** and **Enter** to access Disk Array Management.
2. Press **1** and **Enter** to access the Disk Array Auto Creation.

```
*****Logical Drive Auto Creation*****
Total --6-- free Physical Drives
```

RAID Mode Options:

- 0 - RAID 0 (Striping)
- 1 - RAID 1 (Mirroring)
- 3 - RAID 3 (Parity)
- 5 - RAID 5 (Parity Distributed)
- 10 - RAID 10 (Striping/Mirroring)
- 50 - RAID 50

Please enter RAID mode(0,1,3,5,10,50)>**50**

The Auto Creation tells you how many disk (physical) drives are free and which RAID modes (levels) are possible.

3. Type the RAID mode you want and press **Enter**.

The proposed specifications for the new logical drive appear

```
Logical Drive Auto Creation Information:
Name: LogicalDrive
Number of Physical Drives: 6
RAID mode: RAID 50
Stripe block size: 64KB
```

SMART check: enabled
 Initialization: full

Create Logical Drive now(y/n)?>y

- If you agree with the specifications, press **Y** and **Enter**.
 If you disagree, press **N** and **Enter**. Then select *Create New Disk Array* (below) and input your own settings.

This completes disk array creation. Go to Disk Array Properties and select *Create Logical Drive*.

Create New Disk Array

Use this feature to manually build a logical drive to meet your own requirements or to use less than the full number of available disk drives. See page 212 for a discussion of RAID Levels, the number of drives each supports and an explanation of the available options.

- From the Main menu, press **3** and **Enter** to access Disk Array Management.
- Press **2** and **Enter** to access the Create New Disk Array.

*****Define New Logical Drive*****

Total 8 Physical Drives

*****Physical Drives Selection*****

ID	Name	Capacity
1	Maxtor 5A250J0	251 GB
3	WDC WD2000JB-00FUA0	200 GB
4	WDC WD2000JB-00FUA0	200 GB
7	ST380013AS	80 GB
9	WDC WD1200JD-00FYB0	120 GB
11	ST380013AS	80 GB
12	WDC WD1200JD-00FYB0	120 GB

Enter Physical Drive IDs and/or ID ranges separated by commas. For example: 1,5,8-15.
 Press R to continue after you have finished selecting Physical Drives.

Your input?>**1,3,4,5,9**

- Choose the physical drives for your logical drive and press **Enter**.

*****Physical Drives Selection*****

ID	Name	Capacity
*1	Maxtor 5A250J0	251 GB

```
*3      WDC WD2000JB-00FUA0    200 GB
*4      WDC WD2000JB-00FUA0    200 GB
*7      ST380013AS             80 GB
*9      WDC WD1200JD-00FYB0    120 GB
11      ST380013AS             80 GB
12      WDC WD1200JD-00FYB0    120 GB
```

4 Physical Drives have been selected.
 Enter Physical Drive ids and/or id ranges
 separated by commas. For example: 1,5,8-15.
 Press R to continue after you have finished
 selecting Physical Drives.
 Your input?>r

4. When you have selected all the physical drives, press **R** and **Enter**.

```
RAID Mode Options:
0 - RAID 0 (Striping)
1 - RAID 1 (Mirroring)
3 - RAID 3 (Parity)
5 - RAID 5 (Parity Distributed)
10 - RAID 10 (Striping/Mirroring)
50 - RAID 50
```

Please enter RAID mode(0,1,3,5,10)>5

The prompt displays available RAID modes.

5. Type the RAID mode (level) for your logical drive and press **Enter**.

```
Stripe Block Size (4, 8, 16, 32, 64, 128) in KB?>64
Enter the Disk Array name>Daves Array
Enable initialization(y/n)?>y
Full or quick initialization(f/q)?>q
Quick initialization enabled
```

6. Type the stripe block size, logical drive name, whether you want initialization and if so, quick or full. Press **Enter** after each input.

If you chose RAID 1, you will not see a stripe block size. After the last item, a list of your logical drive specifications displays.

```
Logical Drive creation information:
Name: Daves Array
Number of Physical Drives: 4
RAID mode: RAID 5
Stripe block size: 64KB
SMART check: enabled
```

Create Disk Array now(y/n)?>y

- Review the list. If you agree with the list, press **Y** and **Enter**. If you disagree with the list, press **N** and **Enter**, then select *Create New Disk Array* again.

If you clicked Y, the new disk array appears.

ID	Name	RAID	SBS	CAP	Member PDs	Status
1	Daves Array	5	64K	357GB	1,3-4,9	Functional

This completes disk array creation. Go to Disk Array Properties and select *Create Logical Drive* (page 165).

Delete Disk Array

Use this feature to delete an existing disk array. Be careful when deleting disk arrays. Be sure the disk array you delete is the one you intended to delete.

- Press **3** and **Enter** to select Delete Disk Array.
 Select the Disk Array ID to delete>**2**
 Delete Disk Array 2(y/n)?>**y**
- Type the ID number of the disk array you wish to delete and press **Enter**.
- To confirm deletion, press **Y** and **Enter**. To cancel, press **N** and **Enter**.

Disk Array Properties

Press **4** and **Enter** to access the Disk Array Properties menu. If you have more than one logical drive, specify the one you want by its ID number and press **Enter**. Above the menu is a table of the current settings for this logical drive.

Stripe Block Size: 64K
 Disk Array #1 Mapping: GB

 | 100 GB | 100 GB | 39 GB |

 Name: Daniels Array
 RAID Level: 5 Member LDs: 1-2
 Stripe Block Size: 64K Capacity: 240 GB
 Member PDs: 1,3-4,7 SMART Check: On
 Cache Policy: Write Through Retry Count: 2
 Auto Rebuilding: On Hot Spare Policy: Global
 Priority: High(RBLD), High(SYNC), High(Migration), High(RC), High(PDM)

- Disk Array 1 Properties
- Create Logical Drive

- 2. Delete Logical Drive
- 3. Cache Policy
- 4. Retry Count
- 5. Enable/Disable SMART
- 6. Name
- 7. Priority
- 8. Hot Spare
- 9. Auto Rebuilding
- R. Return to Previous Menu

Please enter your menu choice>**8**

Create Logical Drive

A logical drive is an entity made from a disk array that your PC's operating system recognizes as a single disk drive.

1. From the Disk Array Management menu, press **4** and **Enter** to access the Disk Array Properties.
2. Press **1** and **Enter** to access Create Logical Drive

Mapping for Disk Array 1:

```
-----
| #1   |
| 357 GB |
-----
```

Maximum allowable capacity is 357 GB.

Press Enter key to use the maximum capacity

Or specify capacity in GB for the LD to be created.

Example 1: 12, this will create a 12 GB Logical Drive.

Example 2: 5Gx6, this will create 6 LDs, each LD's capacity is 5 GB.

Note in the Mapping for Disk Array 1 that one logical drive has already been created and that 453 GB is available for additional logical drives.

Your input?>**100**

Enter the Logical Drive name>**FirstLD**

Enable quick initialization(y/n)?>**y**

3. Type the size of your first logical drive in Gigabytes and press **Enter**. Or, to create multiple logical drives of the same size, type the size and number of drives as described and press **Enter**.
4. To enable quick initialization, press **Y** and **Enter**. If not, press **N** and **Enter**.
5. The logical drive mapping information appears(below), followed by the Disk Array Properties menu.

Disk Array #1 Mapping:

```
-----  
| LD #1 | Free |  
| 100 GB | 257 GB |  
-----
```

6. Press **R** and **Enter** twice to return to the Main menu.

In order to use this logical drive to read and write data, you must partition and format it using the Host PC's operating system.

Delete Logical Drive

Use this feature to delete logical drives from a disk array. When you delete a logical drive, you also delete all the data it contains.

1. From the Disk Array Management menu, press **4** and **Enter** to access the Disk Array Properties.
2. Press **2** and **Enter** to access Delete Logical Drive.

The logical drives on this disk array are shown in the disk array map at the top of the screen.

Disk Array #1 Mapping:

```
-----  
| LD #1 | LD #2 | LD #3 | Free |  
| 100 GB | 100 GB | 100 GB | 57 GB |  
-----
```

If you have more than one logical drive, the CLU asks which one you want to delete.

```
LDs to delete(1, 2, 3)>3
```

Press the ID number of the logical drive you want to delete, then press **Enter**. The CLU asks for confirmation.

```
Delete LDs(3) now(y/n)?>y
```

3. Press **Y** and **Enter** to confirm deletion of the selected logical drive.

```
LD deletion finished
```

```
Press Enter key to return
```

4. Press **Enter** to return to the Disk Array Properties menu.

Cache Policy

Use this feature to switch the logical drive cache policy between *Write Through* and *Write Back*. Write Through is more secure but Write Back provides better performance. Write Back temporarily stores data in the cache where VTrak's battery protects the data in the event of a power failure.

1. From the Disk Array Management menu, press **4** and **Enter** to access the Disk Array Properties.
2. Press **3** and **Enter** to access Cache Policy.
3. Press **Y** and **Enter** to confirm. The new policy displays.
4. Press **Enter** to return to the Disk Array Properties menu.

Retry Count

Use this feature to adjust the number of retries the RAID controller allows a disk array before it takes the disk array offline.

1. From the Disk Array Management menu, press **4** and **Enter** to access the Disk Array Properties.
2. Press **4** and **Enter** to access Retry Count.
3. Press **Y** and **Enter** to confirm.
4. Type the new retry count and press **Enter**.
5. Press **Enter** to return to the Disk Array Properties menu.

Enable/Disable SMART

Use this feature to enable or disable the SMART check on this disk array.

1. From the Disk Array Management menu, press **4** and **Enter** to access the Disk Array Properties.
2. Press **5** and **Enter** to access Enable/Disable SMART.
3. Press **Y** and **Enter** to confirm. The new setting displays.
4. Press **Enter** to return to the Disk Array Properties menu.

Disk Array Name

Use this feature to assign a name to this disk array.

1. From the Disk Array Management menu, press **4** and **Enter** to access the Disk Array Properties.
2. Press **6** and **Enter** to accessName.
3. Press **Y** and **Enter** to confirm.
4. Type the disk array name, up to 22 characters, and press **Enter**.
5. Press **Enter** to return to the Disk Array Properties menu.

Priority

Use this feature to set the logical drive priorities for:

- Rebuilding
- Synchronization
- Migration

- Redundancy Check
- PDM

A high priority means more system resources are allocated to the Rebuild, Synchronize, Migrate, Redundancy Check and PDM function and less to routine read/write activity. As a result, the function in progress goes faster but the disk array takes longer for reads and writes. A low priority has the opposite result.

1. Type **7** and **Enter** to access Priority.

The CLU takes you through the list of functions one-by-one.

```

Current rebuilding priority:      High
Current synchronization priority: High
Current migration priority:      High
Current redundant check priority: High
Current PDM priority:            High
Change to low RBLD priority for LD 2(y/n)?>y
    
```

2. Press **Y** and **Enter** to change Rebuilding priority. Press **N** and **Enter** to leave it unchanged.
3. Repeat the same procedure for the other functions.

After the last function, the Screen returns to the Disk Array Properties menu.

Hot Spare Policy

A Hot Spare is a disk drive not assigned to a disk array but available to replace a failing disk drive that belongs to a disk array. This function enables you to designate physical drives as hot spares and to specify the hot spare policy.

Hot spare policy is either *Global* or *Dedicated*. A Global spare can be used by any disk array that needs it. A Dedicated spare can only be used by a specific disk array.

1. Press **8** and **Enter** to access the Hot Spare Policy.

```

Current hot spare policy:
Global
Change to Dedicated hot spare policy for LD 1(y/n)?>y
    
```

2. Press **Y** and **Enter** to change hot spare policy. Press **N** and **Enter** to leave it unchanged.

If you changed the policy to Dedicated, the Physical Drives Selection screen appears. You must select one drive as the hot spare for this disk array.

```

*****Physical Drives Selection*****
    
```

ID	Name	Capacity
9	WDC WD1200JD-00FYB0	120 GB

11	ST380013AS	80 GB
12	WDC WD1200JD-00FYB0	120 GB

Enter Physical Drive ID to select.
 Press R to continue after you have finished
 selecting Physical Drive.
 Your input?>**9**

- If you change to a Dedicated hot spare drive, type the ID number of one available physical drive and press **Enter**.

*****Physical Drives Selection*****

ID	Name	Capacity
*9	WDC WD1200JD-00FYB0	120 GB
11	ST380013AS	80 GB
12	WDC WD1200JD-00FYB0	120 GB

Enter Physical Drive ID to select.
 Press R to continue after you have finished
 selecting Physical Drive.
 Your input?>**r**

- Press **R** and **Enter** to confirm the hot spare drive policy change.
 The Screen returns to the Disk Array Properties menu.

Note: Be sure Auto Rebuilding is enabled (below).

Auto Rebuilding

Use this feature to enable the automatic rebuilding of a disk array that has gone critical. This function must be enabled in order for a hot spare drive to work. See Hot Spare Policy, above. To rebuild a disk array manually, see .

- Press **9** and **Enter** to access the Auto Rebuilding Option.
 Enable auto rebuilding for Disk Array 1(y/n)?>**y**
- Press **Y** and Enter to enable Auto Rebuilding. Press **N** and **Enter** to leave the setting unchanged.
 The Screen returns to the Disk Array Properties menu.

PDM Auto Start

PDM (Predictive Data Migration) is a maintenance operation. VTrak checks the bad block remapping table and keeps a count of disk drive errors. When these reach the user-specified limits, PDM will migrate the data from the suspect disk drive to a replacement.

This action anticipates and prevents a disk drive failure and resulting Critical Status. The logical drive is available at all times. To perform PDM manually, see page 185.

1. Press **5** and **Enter** to access the PDM Auto Start Option.
PDM Auto Start: Disabled
Enable PDM Auto start(y/n)?>y
2. Press **Y** and **Enter** to enable PDM.
Current PDM Threshold:
Remap percentage threshold: 0%
Error count threshold: 0

PDM Threshold
1. Remap Percentage
2. Error Count
R. Return to Previous Menu
Please enter your menu choice>1
3. Press **1** and **Enter** to specify remap percentage.
Current remap percentage threshold: 0%
Change the threshold(y/n)?>y
Enter the new threshold(0~100)>**50**
Current remap percentage threshold: 50%
Press Enter key to return
4. Press **Y** and **Enter** to confirm a Threshold change.
Remap percentage refers to the disk drive's bad sector remapping table. The table holds 32 bad sector remaps. The percentage indicates how full the table must be to trigger PDM.
5. Type a number between 0 and 100 for remap percentage and press **Enter**.
6. Press **Enter** to return to the PDM Threshold submenu.
7. Press **2** and **Enter** to specify Error Count.
Current error count threshold: 0
Change the threshold(y/n)?>y
Enter the new threshold>**5**
Current error count threshold: 5
Press Enter key to return
8. Press **Y** and **Enter** to confirm a Threshold change.
Error count indicates the number of disk drive errors needed to trigger PDM.

9. Type an error number and press **Enter**.
10. Press **Enter** to return to the PDM Threshold submenu.

Logical Drive Management

Logical drives are created under the Disk Array Management, Disk Array Properties function. This function enables you can specify names and make SCSI assignments to existing logical drives.

Name

1. From the Main menu, press **4** and **Enter**, then press **1** and **Enter** to access Logical Drive Name.

Please enter your menu choice>1

Enter Logical Drive ID(1, 2)>

If you have multiple logical drives, specify the one you want by its ID number.

Current LD 1 Name: LogDrv1

Enter the new name>Logical Drive A

Name changed to Logical Drive A for LD 1

Press Enter key to return

2. Type a name for the logical drive and press **Enter**.
3. Press **Enter** again to return to the Logical Drive Management menu.

SCSI Assignment

Use this feature to change the SCSI LUN assignments for a logical drive. You can change the Target ID of the logical drive and specify LUNs for each SCSI channel.

1. From the Main menu, press **4** and **Enter**, then press **2** and **Enter** to access SCSI Assignment for channel 1.

Modify TID and LUN for SCSI channel 1, LD 1(y/n)?>y

2. Type Y and Enter to confirm.

Enter the new TID (1,2,3)>3

3. Type the new TID for iSCSI channel 1 and press **Enter**.

Enter the new LUN (0,1,2,3,4,5,6,7,8,9,10,11,12,13,14,15)>5

4. Type the new LUN for iSCSI channel 1 and press **Enter**.

LUN is set to 5 for SCSI channel 1 LD 1

Press Enter key to return

5. Press **Enter** to move to access SCSI Assignment for channel 1

Modify LUN for SCSI channel 2, LD 1(y/n)?>

6. To make a change, press **Y** and **Enter**.

Make the LUN settings for Channel 2 as needed.

7. Press **Enter** to return to the Logical Drive Management menu.

Network Management

From the Main Menu, press **5** and **Enter** to access Network Management.

The Network Management menu displays with the factory default settings shown above it.

Network Parameters:

DHCP: Enabled

Telnet: Enabled

TFTP Server IP Address: 192.168.10.5

SNMP Name: priti

SNMP Location: usa

Network Management

1. Management Port
2. Telnet
3. TFTP Server
4. SNMP
5. Ping
- R. Return to Previous Menu

Please enter your menu choice>

Management Port

Use this feature to change the IP addresses for VTrak's Management port and Gateway plus the Subnet Mask. You can make these settings manually. If your network has a DHCP server, you can enable DHCP on VTrak and the Management Port settings will be handled automatically.

To enable DHCP:

1. From the Network Management menu, press **1** and **Enter** to access the Management Port menu.
2. Press **1** and **Enter** to access DHCP.
3. Press **Y** and **Enter** to enable DHCP on VTrak.
4. Press **Enter** again to return to the Management Port menu.

To make settings manually:

1. From the Network Management menu, press **1** and **Enter** to access the Management Port menu.

The Management Port settings display.

Management Port IP Address: 10.0.0.2

Subnet Mask: 255.0.0.0

Gateway IP Address: 10.0.0.3

Management Port

1. DHCP
2. Management Port IP
3. Subnet Mask
4. Gateway
- R. Return to Previous Menu

Please enter your menu choice>1

2. Press **2** and **Enter** to select Management Port IP.

-----Configure Management Port IP address-----

Current management port IP Address: 10.0.0.2

Modify management port IP address(y/n)?>y

New management port IP address>**192.168.1.56** (an example only)

New management port IP address: 192.168.1.56

Press Enter key to return

3. Press **Y** and **Enter** to modify the management port IP address.
4. Type the new IP address and press **Enter**.
VTrak confirms the new address.
5. Press **Enter** to return to the Network Management menu.
6. Repeat steps 2 through 5 to set the Subnet Mask and Gateway IP address
7. Reboot the VTrak for these changes to take effect.

Telnet

Telnet allows you to use the CLU to manage VTrak over a network. The Telnet screen looks the same as the CLU screen, except that you have to log in. You must enable Telnet on VTrak before you can establish a Telnet connection.

Enable/Disable Telnet

1. Press **2** and **Enter** to access the Telnet settings.

Current Telnet settings:

Telnet: enabled

Timeout: 600 seconds

Port: 2300

User Name: administrator

Telnet Settings

1. Enable/disable Telnet

- 2. Timeout
- 3. Change User Name
- 4. Change Password
- 5. Reset to Default Settings
- R. Return to Previous Menu

2. Press **1** and **Enter** to access enable/disable Telnet.
Enable Telnet(y/n)?>**y**
3. Type **Y** and Enter confirm.
You return to the Telnet Settings menu.

Timeout

1. Press **2** and **Enter** to access the Timeout setting.
The timeout range and current setting display.
Note: 31536000 seconds equal one year.
Telnet timeout range in seconds: 60 - 31536000
Current Telnet timeout: 600 seconds
Enter the new Telnet timeout in seconds>**500**
2. Type the new value and press **Enter**.
You return to the Telnet Settings menu.

Change User Name

1. Press **3** and **Enter** to access the user name setting.
The minimum and maximum name lengths display.
Minimum user name length is 2
Maximum user name length is 30
Enter the new user name>**RAIDmaster**
2. Type the new name and press **Enter**.
You return to the Telnet Settings menu.

Change Password

1. Press **4** and **Enter** to access the password setting.
The minimum and maximum password lengths display.
Minimum password length is 2
Maximum password length is 16
Enter the new password>*********
To confirm, reenter the new password>*********

2. Type the new password and press **Enter**.
3. Type the new password and press **Enter** again to confirm.
Password changed successfully
Press Enter key to return
4. Press **Enter** to return to the Telnet Settings menu.

Reset to Default Settings

This action will delete any Telnet settings changes you previously made.

1. Press **5** and **Enter** to reset the Telnet settings to the default.
Reset to default Telnet settings(y/n)?>**y**
2. Type the new name and press **Enter**.
You return to the Telnet Settings menu.

TFTP Server

VTrak uses a Trivial File Transfer Protocol (TFTP) server to download and install firmware upgrades. Use this feature to specify an IP address for your TFTP Server.

1. Press **3** and **Enter** to access the TFTP Server.
-----Configure TFTP Server IP address-----
Current TFTP server IP Address: 10.0.0.12
Modify TFTP server IP address(y/n)?>**y**
New TFTP server IP address>**192.168.1.122**
2. Type **Y** and **Enter** to modify the TFTP server IP address.
3. Type the new IP address and press **Enter**.
VTrak confirms the new address.
New management port IP address: 192.168.1.122
Press Enter key to return
4. Press **Enter** to return to the Network Management menu.

For more information on using a TFTP Server and updating Firmware, see page 190.

SNMP

VTrak supports Simple Network Management Protocol (SNMP). Use this feature to check your SNMP settings and view the SNMP Settings menu.

Press **4** and **Enter** to access SNMP.

Current SNMP System Information:

Name: Sonoma
Location: Promise
Contact person: sales
Read only community: public
IP addresses of trap sinks:
#1: 192.168.1.22

SNMP Settings

1. Name
2. Location
3. Contact Person
4. Read only Community
5. Trap only Community
6. Trap Sinks
- R. Return to Previous Menu

Name

1. Press **1** and **Enter** to access the SNMP name setting.
Enter the name>**Irvine**
2. Type the new name and press **Enter**.
You return to the SNMP Settings menu.

Location

1. Press **2** and **Enter** to access the SNMP location setting.
Enter the location>**My Firm**
2. Type the new location and press **Enter**.
You return to the SNMP Settings menu.

Contact Person

1. Press **3** and **Enter** to access the SNMP name setting.
Enter the contact person>**A. Smith**
2. Type the new contact person and press **Enter**.
You return to the SNMP Settings menu.

Read only Community

1. Press **4** and **Enter** to access the SNMP read only community setting.
Enter the read only community>**Sales**
2. Type the new read only community and press **Enter**.
You return to the SNMP Settings menu.

Trap Only Community

1. Press **5** and Enter to access the SNMP trap only community setting.
Enter the trap only community>**Engineering**
2. Type the new trap only community and press **Enter**.
You return to the SNMP Settings menu.

Trap Sinks

1. Press **6** and **Enter** to access the SNMP trap sink IP addresses.

IP addresses of trap sinks:

IP Addresses of Trap Sinks

1. Edit
2. Add
3. Delete
- R. Return to Previous Menu

Please enter your menu choice>**2**

2. To add a trap sink, press **2** and **Enter**.
Enter the new IP address>**192.168.1.88**
3. Type the new IP address and press **Enter**.
The new address displays in the list.

IP addresses of trap sinks:

#1: 192.168.1.88

IP Addresses of Trap Sinks

1. Edit
2. Add
3. Delete
- R. Return to Previous Menu

Please enter your menu choice>**r**

4. Press **R** and **Enter** to return to the SNMP Settings menu.

Ping

Use the Ping function to verify a network connection.

1. Press **5** and **Enter** to access Ping.
Ping Test
Enter the IP address to ping>**192.168.10.239**

2. Type the IP address of the network node you which to contact and press **Enter**.

Number of ping packets(1-30)?>**5**

3. Type the number of ping packets you with to send and press **Enter**.

--- 192.168.10.239 ping statistics ---

5 packets transmitted, 5 received, 0% loss, time 4008ms

rtt min/avg/max/mdev = 0.426/0.466/0.529/0.040 ms

Press Enter key to return

If all the packets return, your Ping Test was successful and you know the network connection is good.

4. Press **Enter** to return to the Network Management menu.

SCSI Management

- Channel TID (below)
- RAID Console LUN (page 181)

From the Main Menu, press **6** and **Enter** to access SCSI Management.

```
SCSI Channel 1, Initiator 7, TID 0 Transfer Speed: 160 Mb/s
Channel 1 IO Statistics: read count 524434, read transaction 240 Mb
Channel 1 IO Statistics: write count 524288, write transaction 0 Mb
Channel 2 IO Statistics: read count 524434, read transaction 240 Mb
Channel 2 IO Statistics: write count 524288, write transaction 0 Mb
SCSI Channel 1 TIDs: 0
SCSI Channel 2 TIDs: 0
RAID Console: disabled
```

```
-----
SCSI Management
1. Channel TID
2. RAID Console LUN
R. Return to Previous Menu
```

Please enter your menu choice>

Channel TID

Use this feature to change or add Target IDs. The TIDs you enter will overwrite your previous selection.

1. Press **1** and **Enter** to access the SCSI Channel TID settings.

```
*****Modify SCSI Channel TID*****
```

```
SCSI Channel #    TIDs
-----
1                0
-----
2                0
```

```
Please select the SCSI channel(1-2)
Press R to return after finished>1
```

```
Want to modify TIDs for SCSI channel 1(y/n)?>y
Please enter the new TIDs>1,3,5,7,9,11
```

2. Type the Channel number and press **Enter**.
Press **Y** and **Enter** to confirm.
3. Type the new TIDs and press **Enter**.
Remember to type any pre-existing TIDs you still want to use.

TIDs for SCSI channel 1 changed

Press Enter key to return

*****Modify SCSI Channel TID*****

SCSI Channel #	TIDs
1	1 3 5 7 9 11
2	0

Please select the SCSI channel(1-2)

Press R to return after finished>

4. Press **R** and **Enter** to return to the SCSI Management menu.

Rather than creating multiple Target IDs, use one Target ID and assign a LUN to each logical drive. See page 164.

RAID Console LUN

VTrak's RAID Console is required in order to use In-Band SCSI. The RAID Console is disabled by default. This feature is for future use. For now, leave it disabled.

Maintenance Menu (Disk Array Operations)

From the Main Menu, press **6** and **Enter** to access the Maintenance menu:

Maintenance activity Monitor: Running

ID	Name	RAID	SBS	CAP	Operation	Progress
1	LogDrv1	5	64K	239GB	RBLD	27% on 9
2	LogDrv2	3	64K	265GB	None	N/A

Maintenance

1. Maintenance Activity Monitor
2. Migrate Disk Array
3. Manual Rebuild
4. Manual PDM)
5. Synchronization
6. Redundancy Check
7. Media Patrol
- R. Return to Previous Menu

The current Operation is reported for each disk array as follows:

- **INIT** – Initialization, done at logical drive creation. The logical drive is clearing old, unusable data from the disk drives.
- **RBLD** – Rebuild, a repair operation. The disk array is rebuilding data or parity to a replacement drive. The target disk drive is cited by ID number. The disk array is available
- **SYNC** – Synchronization, a maintenance operation. The disk array checks the data and parity and corrects inconsistencies. The disk array is available
- **PDM** – Predictive Data Migration, a maintenance operation. The disk array moves data from a suspect disk drive to a replacement. The target disk drive is cited by ID number. This action anticipates and prevents a disk drive failure and resulting Critical Status. A replacement disk drive is required. The disk array is available
- **RC** – Redundancy Check. The disk array is checking data to verify that redundancy or parity match. Unlike Synchronizing, no corrections are made. The disk array is available
- **MP** – Media Patrol. The disk array is checking disk drives to verify the condition of the magnetic media. Unlike Synchronizing, no corrections are made. The disk array is available

Maintenance Activity Monitor

The Maintenance Activity Monitor displays the progress of various disk array operations on the CLU screen approximately every 15 seconds, as shown below.

```
Daniels Array(DA #1) PDM(4->11) 10%
Daniels Array(DA #1) PDM(4->11) 11%
Daniels Array(DA #1) PDM(4->11) 12%
```

1. Press **1** and **Enter** to access the Maintenance Activity Monitor.

```
Maintenance activity monitor is currently running.
When any maintenance activity occurs e.g. rebuilding,
the maintenance monitor will display notification
message on screen.
```

```
Stop maintenance activity monitor(y/n)?>y
```

```
Maintenance activity monitor stopped now
Press Enter key to return
```

2. Press **Y** and **Enter** to toggle the monitor between start and stop.
3. Press **Enter** to return to the Maintenance menu.

Migrate Disk Array

Use this feature to change the RAID mode (level) or a disk array or to add more physical drives.

1. Type **2** and **Enter** to access Migrate Logical Drive.
2. Type the ID number for the disk array and press **Enter**.

```
*****Physical Drives Selection*****
```

Id	Name	Capacity
7	ST3160023AS	159 GB
8	ST3160023AS	159 GB
9	ST3160023AS	159 GB

```
Enter Physical Drive ids and/or id ranges
separated by commas. For example: 1,5,8-15.
```

```
Press R to continue after you have finished
selecting Physical Drives.
```

```
Your input?>7,9
```

3. Type the ID number(s) for the disk drive(s) you want to add and press **Enter**.

```
*****Physical Drives Selection*****
```

Id	Name	Capacity
*7	ST3160023AS	159 GB

8 ST3160023AS159 GB
*9 ST3160023AS159 GB

2 Physical Drives have been selected.
Enter Physical Drive ids and/or id ranges separated by commas. For example: 1,5,8-15.
Press R to continue after you have finished selecting Physical Drives.
Your input?>r

4. Press **R** and **Enter** when you are finished adding disk drives.

Destination RAID mode selection for LD migration
RAID Mode Options:
0 - RAID 0 (Striping)
1 - RAID 1 (Mirroring)
3 - RAID 3 (Parity)
5 - RAID 5 (Parity Distributed)
10 - RAID 10 (Striping/Mirroring)
50 - RAID 50

Please enter RAID mode(0,1,3,5)>5

5. Type the new RAID level you want for the logical drive.
A list of possible levels appears in parentheses beside the prompt.

Migrate Disk Array 1 now(y/n)?>y

6. Press **Y** and **Enter** to confirm disk array migration.
Press **N** and **Enter** to cancel the operation.

The Screen returns to the Maintenance menu.

If the Maintenance Activity Monitor is enabled, you can watch the Migration progress on your monitor.

Manual Rebuild

Use this feature to rebuild a disk array manually. Your system must meet the following conditions:

- Auto Rebuilding Option is disabled. See page 169.
- The disk array is Critical
- A free disk drive of equal or larger size is available

With the above conditions met, proceed with the manual rebuild.

1. Press **3** and **Enter** to rebuild a disk array manually.
2. Choose the ID number of the disk array you want to rebuild and press Enter.
A list of available, qualified disk drive appears.

Available free Physical Drive(s):

1
2
7

Choose the free Physical Drive for rebuilding>**2**
Rebuild Disk Array 1 on Physical Drive 2 now(y/n)?>**y**

3. Choose the ID number of a free physical drive to rebuild your logical drive and press **Enter**.

Press **Y** and **Enter** to confirm.

The Screen returns to the Maintenance menu.

If the Maintenance Activity Monitor is enabled, you can watch the Rebuild progress on your monitor.

Manual PDM

Preventive Data Migration (PDM) refers to a feature that monitors disk drives and replaces an unhealthy disk drive before the logical drive goes critical. PDM can run automatically. See page 169.

PDM for Logical Drive allows you to replace a suspect disk drive manually, while keeping the disk array functional and available.

1. Press **4** and **Enter** to use PDM on a disk array.

*****PDM for Disk Array*****

Id	Disk Array Name	Mode	Size
1	Daniels	RAID5	237 GB
2	Kirts	RAID3	107 GB

Select the LD Logical Drive ID for PDM

Press R to return after finished>**2**

2. Choose the ID number of the logical drive for PDM and press **Enter**.

A list of disk array member disks appears beside the prompt.

Enter the unhealthy PD ID(1,5,6)>**6**

Enter the spare PD ID(2,3,7)>**7**

Start PDM for Logical Drive 1 (y/n)?>**y**

3. Choose the ID number of the unhealthy disk (physical) and press **Enter**.
A list of available spare disks appears beside the prompt.
4. Choose the ID number of the spare disk (physical drive) and press **Enter**.
5. Press **Y** and **Enter** to confirm.

```
*****PDM for Disk Array*****
Id   Disk Array Name      Mode   Size
-----
1    Daniels              RAID5  237 GB

PDM for Logical Drive started
Press Enter key to return
```

6. Press **Enter** to return to the Maintenance menu.
If the Maintenance Activity Monitor is enabled, you can watch the PDM progress on your monitor.

Synchronize Logical Drive

Use this function to verify the integrity of your data across the physical drives that make up your logical drive.

1. Press **5** and **Enter** to access Synchronization.
Enter the Logical Drive ID>**1**
Start SYNC for LD 1(y/n)?>**y**
2. Type the ID number for the logical drive you want to synchronize and press **Enter**.
Logical Drive SYNC Started
Press Enter key to return
3. Press **Enter** to return to the Maintenance menu.
If the logical drive was Functional when Synchronization began, you can pause and resume the Synchronization process with this same function.
If the Maintenance Activity Monitor is enabled, you can watch Synchronization progress on your monitor.

Redundancy Check

Use this function to verify the integrity of your data across the physical drives that make up your logical drive.

1. Press **6** and **Enter** to access Redundancy Check.
Enter the Logical Drive ID>**1**
Start RC for LD 1(y/n)?>**y**
2. Type the ID number for the logical drive on which you want to run a Redundancy Check and press **Enter**.
Logical Drive RC Started
Press Enter key to return
3. Press **Enter** to return to the Maintenance menu.

If the logical drive was Functional when the Redundancy Check began, you can pause and resume the Redundancy Check process with this same function.

If the Maintenance Activity Monitor is enabled, you can watch the Redundancy Check progress on your monitor.

Media Patrol

Use this function to verify the integrity of the magnetic media on the physical drives that make up your logical drive.

1. Press **7** and **Enter** to access Media Patrol.

Current MP Information:

MP: disabled

Percentage: 0%

Media Patrol(MP)

1. Enable/Disable MP

2. Pause

R. Return to Previous Menu

Please enter your menu choice>**1**

Enable MP(y/n)?>**y**

2. Do one of the following:
 - Press **1** and **Enter** to enable/disable Media Patrol. Then press **Y** and **Enter** to confirm.
 - Press **2** and **Enter** to pause/resume Media Patrol. Then press **Y** and **Enter** to confirm.
3. When you are done, press **R** and **Enter** to return to the Maintenance menu.
If the Maintenance Activity Monitor is enabled, you can watch the Media Patrol progress on your monitor.

Event Viewer

Use this function to review all events in the event queue. This information is especially helpful for troubleshooting. The most recent 1024 events will display. There is no delete event function.

1. From the Main menu, press **8** and **Enter** to access the Event Viewer.

VTrak 15110 Event Information:

Timestamp	Description	Severity	ID
10/29/2004 8:59:35	LD 3 deleted.	INFO	46
10/29/2004 8:59:36	LD 4 deleted.	INFO	47
10/29/2004 9:05:25	Created DA Array2.	INFO	48
10/29/2004 9:05:25	Quick INIT started on DA 2.	INFO	49
10/29/2004 9:05:25	Quick INIT done on DA 2.	INFO	50
10/29/2004 9:05:28	LD 17 created on DA 2.	INFO	51
10/29/2004 9:05:28	Quick Init started on LD 17.	INFO	52
10/29/2004 9:05:28	Quick Init completed on LD 17.	INFO	53
10/29/2004 9:07:29	Deleted DA Array2.	INFO	54
10/29/2004 15:58:48	PDM started on DA Array2: 4->11.	INFO	55

Enter the ID to view event details.

q: quit, +/k: forward, -/j: backward

s: start of event queue, e: end of event queue

c: clear all events

Your input?>

2. To move forward in the queue, press **+** or **K**.
 To move backward in the queue, press **-** or **J**.
 To move to the beginning of the queue, press **S**.
 To move to the end of the queue, press **E**.
 To repeat the most recent entry, press **Enter**.
 To clear all events, press **C**.
3. Press **Q** and **Enter** to return to the Main Menu.

Chapter 6: Maintenance

- Firmware Update (page 190)
- Replace Power Supply (page 196)
- Replace Cooling Unit Fan (page 197)
- Replace Cache Battery (page 202)
- Replace SEP (page 204)
- Replace RAID Controller (page 205)

This Chapter covers the maintenance procedures for VTrak.

The power supplies, cooling unit fans and the cache battery are hot-swappable field-replaceable components.

The Storage Enclosure Processor (SEP) and RAID Controller are field-replaceable but they require you to power down the VTrak.

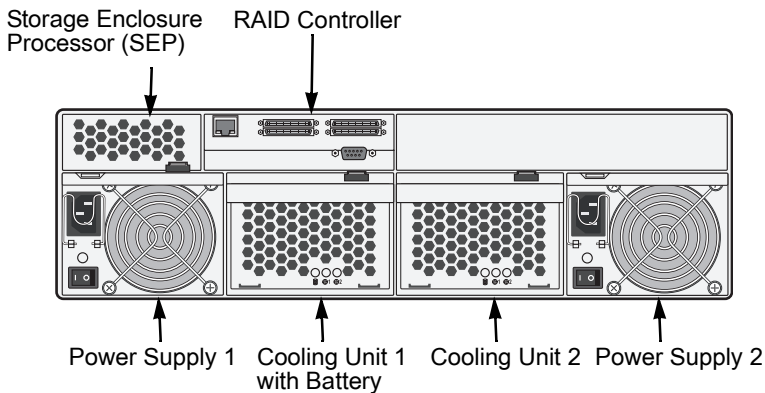

Figure 1. Field Replaceable Units (FRUs) on VTrak

The primary means to identify and diagnose problems on VTrak is to observe and interpret LED colors. A discussion of this process is found on the next two pages.

All hot-swappable components can be fully diagnosed with LEDs, although the Command Line Utility (CLU) and WebPAM each offer you additional help to make and confirm your diagnosis. See page 223 additional information.

Firmware Update – WebPAM

This is the preferred firmware update method for most applications. This procedure takes about ten minutes. There are alternative methods based on the CLU (page 192) and a serial port connection (page 194).

Preparation



In order for the firmware update to work, three things are required:

- TFTP server IP address
- TFTP server directory name
- A firmware image file

The WebPAM PRO Utility Server incorporates a TFTP server. No additional software is required.



TFTP Server IP Address

You must tell WebPAM PRO the IP address of the TFTP server so it can upload the firmware file from that location.

1. Click on the Subsystem  icon in Tree View.
2. Click on the VTrak  icon.
3. Click on the Network Management  icon.
4. Click on the Settings tab.
5. Enter the TFTP Server IP address.
6. Click the **Submit** button when you are done.

TFTP Server Directory Name

You must tell WebPAM PRO which directory on the TFTP server has the firmware file. Use this function to verify or set a directory name. The default directory is TFTP-Root.

1. Click on the Administration Tools  icon in Tree View.
2. Click on the Software Management  icon.
3. Click on the TFTP Server tab.
4. Enter a TFTP directory name.
5. Click **Submit** when you are done.



Firmware Image File

You must obtain the latest firmware update file from the Promise Technology website and save it to the directory on the TFTP server you specified above.

1. Point your browser to the Promise website (www.promise.com).
2. Click on the Support menu and select *Download*.
3. From the popup menus, select your VTrak model and Firmware.
4. Click the **Go** button.
5. Select the most recent firmware file and click on its link to download it.
6. In the File Download box, click **Save**.
7. Unzip the file and place it in the specified directory on the TFTP server.

Firmware Update

Use this function to update the firmware on your VTrak subsystems.

1. Click on the Administration Tools  icon in Tree View.
2. Click on the Software Management  icon.
3. Click on the Firmware Update tab.
4. Select the firmware file in the Select Firmware dropdown menu.
The files that appear in this menu are saved in the TFTP directory on the server running WebPAM PRO.
5. Check the boxes of the subsystems whose firmware you want to update with the selected firmware file.
6. Click **Submit** when you are done.

The firmware for all of the selected VTrak subsystems is automatically updated. The firmware update takes about 10 minutes. Each subsystem will reboot itself after the update is finished.

Firmware Update – CLU

Use this firmware update method over a Telnet connection. This procedure takes about 10 minutes.

See also the preferred method based on WebPAM PRO (page 190) and the alternative method that uses a serial port connection (page 194).

Preparation

In order for the firmware update to work, two things are required:

- A TFTP server
- A firmware image file

TFTP Server

The WebPAM PRO Utility Server incorporates a TFTP server. If you have installed WebPAM PRO on a network server, no additional software is required.

Firmware Image File

You must obtain the latest firmware update file from the Promise Technology website and save it to the TFTP-Root directory on the TFTP server.

1. Point your browser to the Promise website (www.promise.com).
2. Click on the Support menu and select *Download*.
3. From the popup menus, select your VTrak model and Firmware.
4. Click the **Go** button.
5. Select the most recent firmware file and click on its link to download it.
6. In the File Download box, click **Save**.
7. Unzip the file and place it in the TFTP-Root directory on the TFTP server.

Firmware Update

1. Press **3** and **Enter** to access the Firmware Update feature.
Current TFTP Server IP Address: 192.168.10.5
Modify TFTP Server IP address(y/n)?>n
Enter the firmware file name on TFTP server>**VTrak-01.01.000.54.img**
Current TFTP Server IP Address: 192.168.10.5
Update firmware for VTrak now(y/n)?>y
2. Check the current IP address of the TFTP server.
If it requires a change, press **Y** and **Enter**. Then type the new address and press **Enter**.

3. Type the file name of the firmware image file and press **Enter**.

The CLU displays the TFTP server IP address.

4. Press **Y** and **Enter** to proceed with the firmware update.

TFTP Server: 192.168.10.5, updating started, please wait...

ImgHeader read: Success

PTIF: Success

Please note that the new firmware will take effect only after VTrak is rebooted.

The firmware update takes about 10 minutes. After the firmware update, VTrak will automatically reboot.

Firmware Update – Serial Port

Use this firmware update method only when your Management Port has no network connection or the RS-232 connection is required. This procedure takes about 30 minutes and applies to all VTrak models.

See also the preferred method based on WebPAM PRO (page 190) and an alternative method based on the CLU (page 192)..



Warning

Do not allow the firmware update process to be interrupted for any reason. An interrupted update will incapacitate controller. Then you must return the controller to Promise for repair.

Firmware Image File

You must obtain the latest firmware update file from the Promise Technology website and save it to the Host PC.

1. Point your browser to the Promise website (www.promise.com).
2. Click on the Support menu and select *Download*.
3. From the popup menus, select your VTrak model and Firmware.
4. Click the **Go** button.
5. Select the most recent firmware file and click on its link to download it.
6. In the File Download box, click **Save**.
7. Unzip the file.

Firmware Update

1. Be sure the VTrak and Host PC are running, the null modem cable is properly connected and you have the correct COM Port settings. See Chapter 2 for these settings.
2. Start your PC's terminal emulation program.
3. Press **Enter** once to launch the CLU.
4. Reboot the VTrak. Use either method:
 - From the Main Menu, press **1** and **Enter** twice to access the Controller Management menu. Then press **5** and **Enter** to select Reboot. At each of two prompts, press **Y** and **Enter** to confirm the Reboot.
 - Turn the VTrak's power switches off and then on again.

5. Watch the terminal screen for the following:

Scrub DDR, waiting
Platform Init Done.
+

6. At the +, press the **Ctrl** and **F** keys at the same time.

The prompt changes to >BSP.

7. At BSP> type **load -r -v -b 0x01008000 -m y**.

Double-check your entry. Then press **Enter**.

This command readies VTrak to receive a file transfer via Y-modem protocol. You have approximately 90 seconds to initiate the file transfer before the load operation times out.

8. Start the file transfer. For example, if you are using HyperTerminal:

- Go to Transfer > Send File
- Click on the firmware image file to select it.
Example: **VTrak-01.03.000.54.img**
- Select Y-modem protocol
- Click Send

The file transfer takes about 20 minutes. When complete, the BSP> prompt will reappear.

9. At BSP> type **ptiflash -b 0x01008000**.

Double-check your entry. Then press **Enter**.

This command validates the firmware upgrade file then writes the binary image to VTrak's flash ROM. These actions take about 8 minutes. When complete, the BSP> prompt will reappear.

10. Type **reset** and press **Enter** to restart the VTrak.

This completes the firmware update operation.

Replace Power Supply

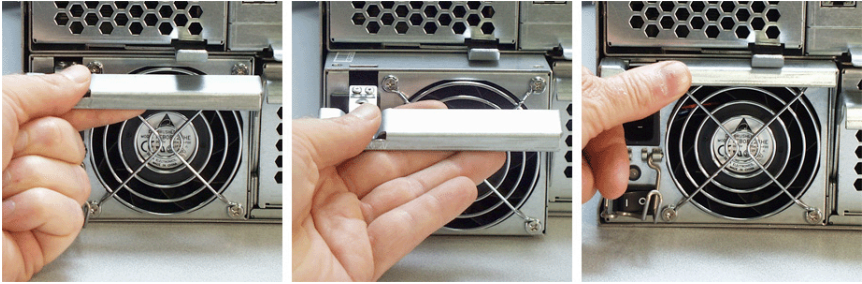

The power supply and its fan are replaced as one unit. There are no individually serviceable parts. No tools are required for this procedure.

To remove the power supply, do the following:

1. Verify that the power supply LED is amber or red.
2. Switch off the power.
3. Unplug the power cord.
4. Press the release button and pull the handle downward as shown (above, left).
5. Pull the power supply out of the VTrak enclosure (above, center).

To install the power supply, do the following:

1. Carefully slide the power supply into the enclosure.
2. Gently press the handle in and upward until it locks (above, right).
3. Plug in the power cord.
4. Switch on the power supply.
5. Verify that the new power supply LED is green.

This completes the power supply replacement procedure.

Replace Cooling Unit Fan

The blowers (scroll fans) in the cooling units are replaced as individual parts. There are two fans in each cooling unit. No tools are required for this procedure.

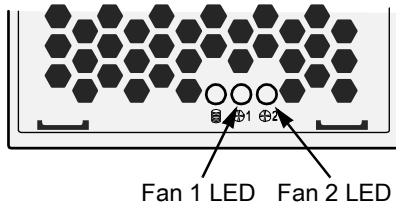

Caution

If the cooling unit you plan to remove contains the cache backup battery, your system will be vulnerable to a power failure. Temporarily set your cache policy to write-through before starting this procedure. See page 166.

To replace a fan, do the following:

1. Verify that the Fan LED is amber or red and note whether it is Fan 1 or 2 (above).

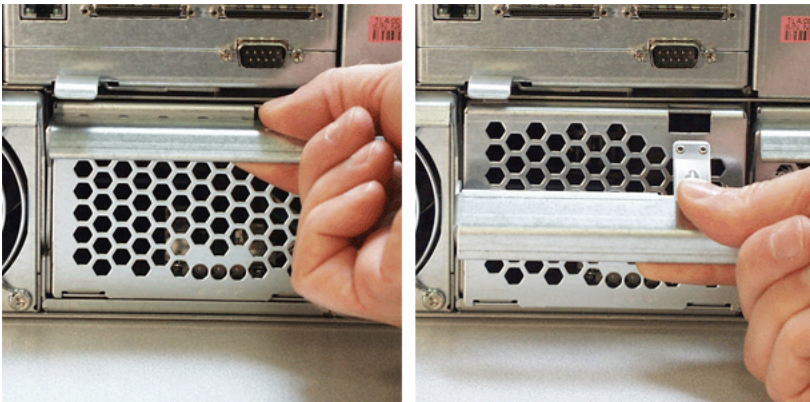

2. Press the release button and pull the handle downward as shown above.

3. Pull the cooling unit out of the VTrak enclosure. An example of a VTrak cooling unit appears below.



To open the cooling unit, do the following:

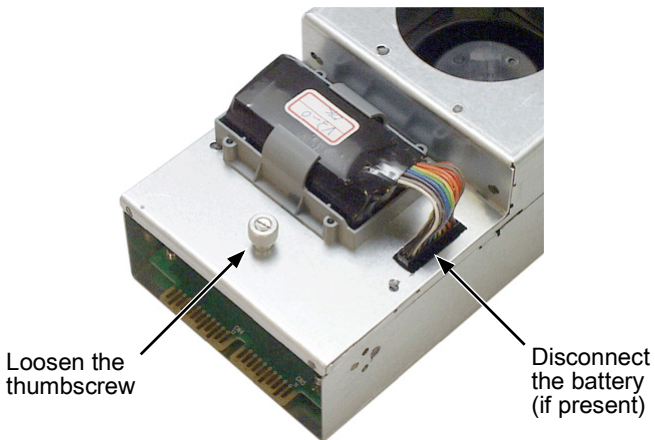

4. If there is a battery on the cooling unit, disconnect the battery connector (above).

5. Loosen the thumbscrew (above). A retainer keeps the thumbscrew in place.

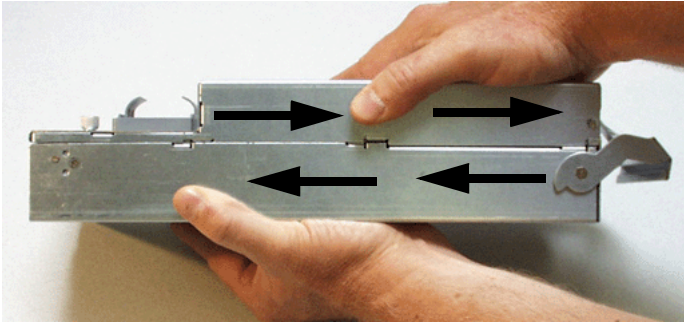

6. Grasp the top and bottom sections of the cooling unit with your hands as shown above.
7. Hold the lower section and pull the upper section to the right.

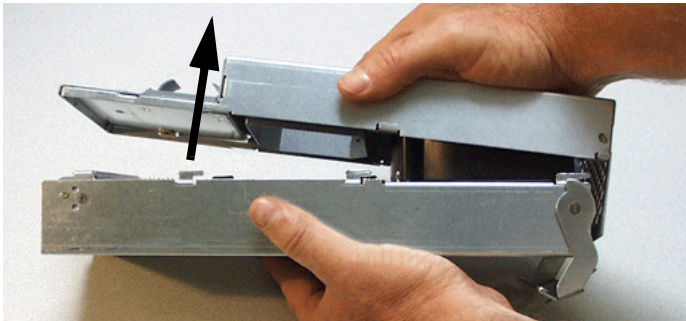

8. Separate the cooling unit section to access the blowers.

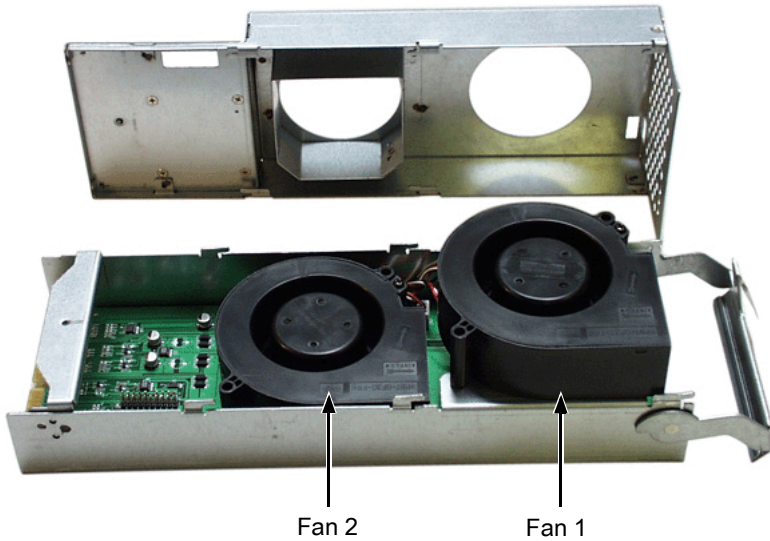

The upper fan is Fan 1, the lower fan is Fan 2. From the LEDs on the cooling unit (see the diagram on page 197), you know which fan to replace.

9. Lift the fan off the mounting pins and detach the electrical connector.
10. Attach the electrical connector of the new fan and set it in place.

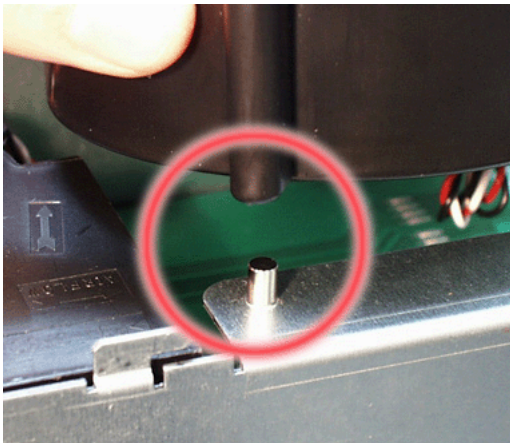

Be sure you set the fan on the mounting pins, as shown above.

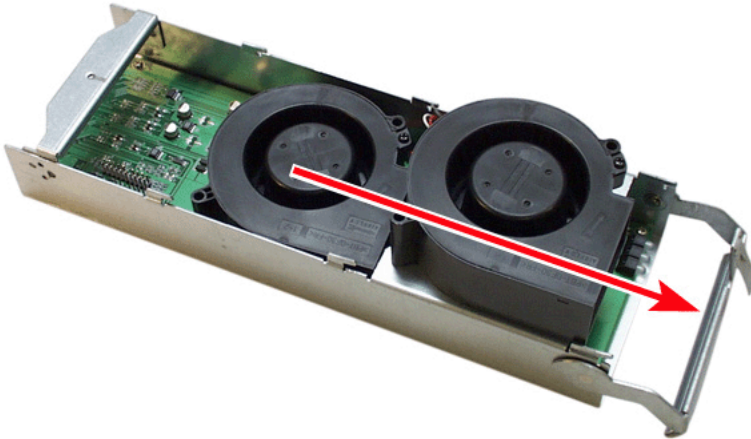

Be sure the fans point outward, towards the handle (above).

11. Place the top section of the cooling unit onto the bottom section and slide the top lock it in place.
12. Tighten the thumbscrew.
13. If there is a battery on the cooling unit, reattach the battery connector.
14. Carefully slide the cooling unit into the enclosure.

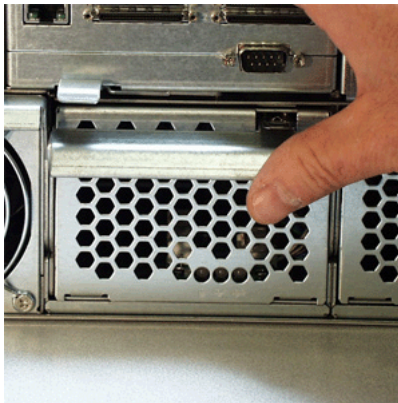

15. Gently press the handle in and upward until it locks.
16. Verify that the Fan LEDs are green.

This completes the fan replacement procedure.

Replace Cache Battery

The cache battery is located in the Cooling Unit 1 (the left one). The battery is replaced as an individual part. No tools are required for this procedure.



Cautions

- There is a risk of explosion if the battery is replaced by the incorrect type.
- Dispose of used batteries according to the instructions that accompany the battery.
- While the battery is removed, your system will be vulnerable to a power failure. Temporarily set your cache policy to write-through before starting this procedure. See page 119 (WebPAM PRO) or page 166 (CLU).

Note that the Battery LED on Cooling Unit 2 is always dark.

To replace a cache battery, do the following:.

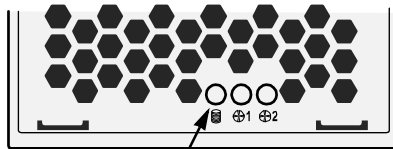

Battery LED

1. Verify that the battery LED is amber or red (above).

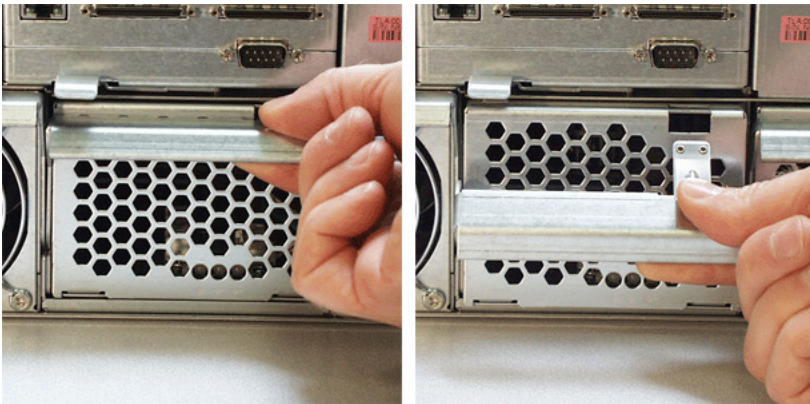

2. Press the release button and pull the handle downward as shown above.

3. Pull the cooling unit out of the VTrak enclosure.

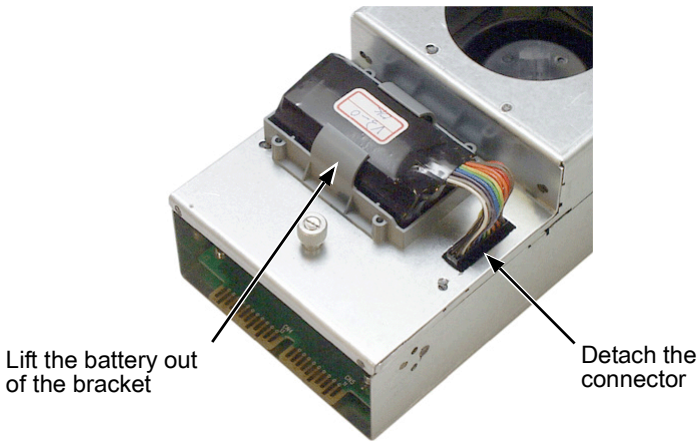

4. Detach the connector and lift the battery out of the bracket (above).
5. Place a new battery into the bracket and attach the connector.
6. Carefully slide the cooling unit into the enclosure.

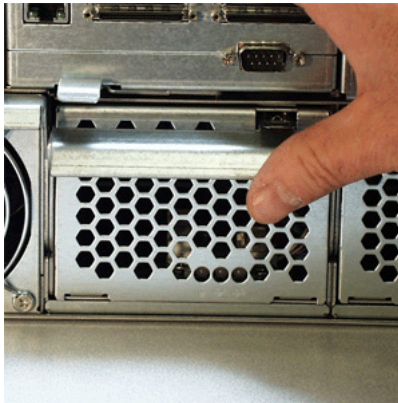

7. Gently press the handle in and upward until it locks (above).
8. Verify that the battery LED is green.

This completes the battery replacement procedure.

Replace SEP

The Storage Enclosure Processor (SEP) manages the fans, audible alarm and battery, and monitors system voltages and cooling functions. No tools are required for this procedure.



Caution

The SEP is NOT a hot-swappable device. Power-down the VTrak before removing it.



Important

Do not replace the SEP based on LED colors alone. Only replace the SEP when directed to do so by Promise Technical Support. See page 245.



To remove and replace the SEP, do the following:

1. Power down the VTrak.
2. Grasp the handle and pull it toward you (above, left).
3. Holding the handle, pull the SEP out of the enclosure (above, center).
4. Gently slide the new SEP into the enclosure.
5. Press on the screen to seat the SEP (above, right). The handle will swing in as the SEP is properly seated.
6. Power up the VTrak.

This completes the Storage Enclosure Processor replacement procedure.

Replace RAID Controller

The RAID Controller monitors and manages the logical drives. When this controller is replaced, all of your logical drive data and configurations remain intact because this logical drive information is stored on the disk drives.



Caution

The RAID Controller is NOT a hot-swappable device. Power-down the VTrak before removing it.



Important

Do not replace the RAID Controller based on LED colors alone. Only replace the RAID Controller when directed to do so by Promise Technical Support. See page 245.

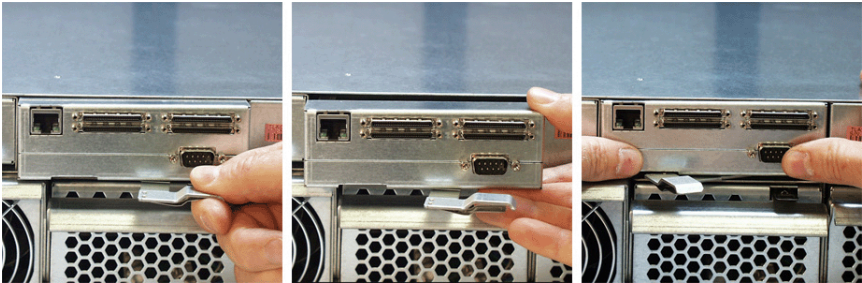

To remove and replace the RAID Controller, do the following:

1. Power down the VTrak.
2. Remove the network, SCSI and null modem cables.
3. Grasp the handle and pull it toward you (above, left).
4. Grasp the Controller and pull it out of the enclosure (above, center).
5. Gently slide the new Controller into the enclosure.
6. Press on the front to seat the Controller (above, right). The handle will swing in as the Controller is properly seated.
7. Attach the network, SCSI and null modem cables.
8. Power up the VTrak.

This completes the RAID Controller replacement procedure.

Chapter 7: Technology Background

- Introduction to RAID (below)
 - Choosing a RAID Level (page 214)
 - Choosing Stripe Block Size (page 217)
 - Gigabyte Boundary (page 217)
 - Initialization (page 217)
 - Hot Spare Drive(s) (page 218)
 - Partition and Format the Logical Drive (page 218)
 - Cache Settings (page 219)
 - RAID Level Migration (page 219)
-

Introduction to RAID

RAID (Redundant Array of Independent Disks) allows multiple hard drives to be combined together in a disk array. Then all or a portion of the disk array is formed into a logical drive. The operating system sees the logical drive as a single storage device, and treats it as such. The RAID software and/or controller handle all of the individual drives on its own. The benefits of a RAID can include:

- Higher data transfer rates for increased server performance
- Increased overall storage capacity for a single drive designation (such as, C, D, E, etc.)
- Data redundancy/fault tolerance for ensuring continuous system operation in the event of a hard drive failure

Different types of disk arrays use different organizational models and have varying benefits. Also see Choosing RAID Level on page 214. The following outline breaks down the properties for each type of RAID disk array:

RAID 0 – Striping

When a disk array is striped, the read and write blocks of data are interleaved between the sectors of multiple disk drives. Performance is increased, since the workload is balanced between drives or “members” that form the disk array. Identical drives are recommended for performance as well as data storage efficiency. The disk array's data capacity is equal to the number of drive members multiplied by the smallest disk array member's capacity.

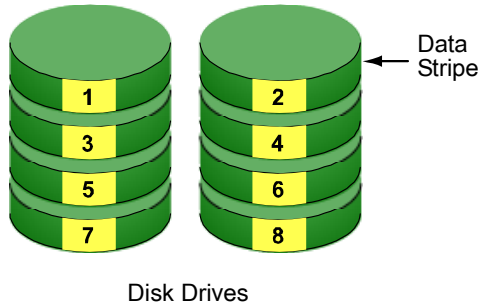

Figure 1. RAID 0 Striping interleaves data across multiple drives

For example, one 100GB and three 120GB drives will form a 400GB (4 x 100GB) disk array instead of 460 GB.

RAID 0 disk arrays on VTrak consist of one or more disk drives.

RAID 1 – Mirroring

When a disk array is mirrored, identical data is written to a pair of disk drives, while reads are performed in parallel. The reads are performed using elevator seek and load balancing techniques where the workload is distributed in the most efficient manner. Whichever drive is not busy and is positioned closer to the data will be accessed first.

With RAID 1, if one disk drive fails or has errors, the other mirrored disk drive continues to function. This is called Fault Tolerance. Moreover, if a spare disk drive is present, the spare drive will be used as the replacement drive and data will begin to be mirrored to it from the remaining good drive.

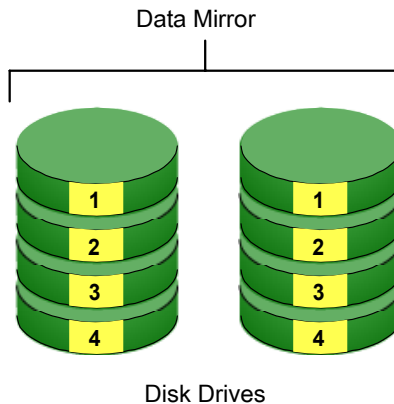

Figure 2. RAID 1 Mirrors identical data to two drives

Due to the data redundancy of mirroring, the capacity of the disk array is only the size of the smallest disk drive. For example, two 100GB disk drives which have a combined capacity of 200GB instead would have 100GB of usable storage when set up in a mirrored disk array. Similar to RAID 0 striping, if disk drives of different capacities are used, there will also be unused capacity on the larger drive.

RAID 1 disk arrays on VTrak consist of two disk drives.

RAID 3 – Block Striping with Dedicated Parity

RAID level 3 organizes data across the disk drives of the disk array, and stores parity information on to a disk drive dedicated to this purpose. This organization allows increased performance by accessing multiple disk drives simultaneously for each operation, as well as fault tolerance by providing parity data. In the event of a disk drive failure, data can be re-calculated by the RAID system based on the remaining data and the parity information.

The adjustable block size of the RAID 3 disk array allows for performance tuning based on the typical I/O request sizes for your system. The block size must be set at the time the disk array is created and cannot be adjusted dynamically. Generally, RAID Level 3 tends to exhibit lower random write performance due to the heavy workload going to the dedicated parity drive for parity recalculation for each I/O.

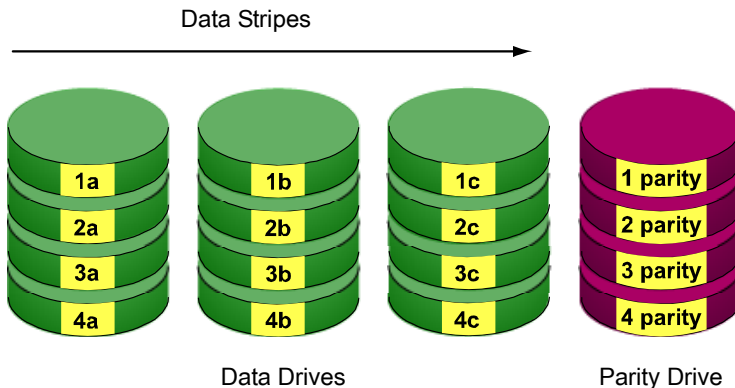

Figure 3. RAID 3 Stripes data and adds a dedicated Parity Drive

The capacity of a RAID 3 disk array is the smallest drive size multiplied by the number of disk drives less one. Hence, a RAID 3 disk array with (4) 100 GB disk drives will have a capacity of 300GB. A disk array with (2) 120GB disk drives and (1) 100GB disk drive will have a capacity of 200GB.

RAID 3 disk arrays on VTrak consist of 3 to 15 disk drives.

RAID 5 – Block Striping with Distributed Parity

RAID 5 is similar to RAID 3 as described above except that the parity data is distributed across the disk drives along with the data blocks. In each case, the parity data is stored on a different disk than its corresponding data block.

RAID 5 makes efficient use of hard drives and is the most versatile RAID Level. It works well for file, database, application and web servers.

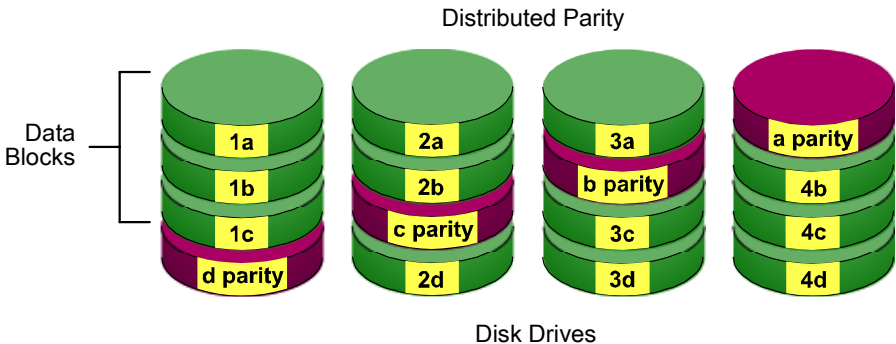

Figure 4. RAID 5 Stripes all drives with data and parity information

The capacity of a RAID 5 disk array is the smallest disk drive size multiplied by the number of disk drives, less one. Hence, a RAID 5 disk array with four 100 GB disk drives will have a capacity of 300 GB. A disk array with two 120 GB disk drives and one 100 GB disk drive will have a capacity of 200 GB.

RAID 5 disk arrays on VTrak consist of 3 to 15 disk drives.

RAID 10 – Mirroring / Striping

Mirroring/Striping combines both of the RAID 0 and RAID 1 disk array types. It can increase performance by reading and writing data in parallel while protecting data with duplication. At least four disk drives are needed for RAID 10 to be installed. With a four-disk-drive disk array, one drive pair is mirrored together then striped over a second drive pair.

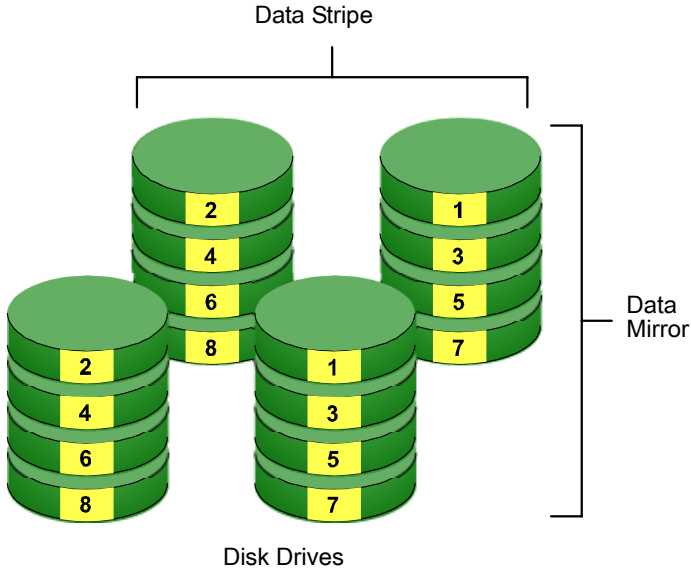

Figure 5. RAID 10 takes a data mirror on one drive pair and stripes it over two drive pairs

The data capacity is similar to a RAID 1 disk array, with half of the total storage capacity dedicated for redundancy. An added plus for using RAID 10 is that, in many situations, such a disk array offers double fault tolerance. Double fault tolerance may allow your disk array to continue to operate depending on which two disk drives fail.

RAID 10 disk arrays on VTrak consist of 4 to 14 disk drives.

RAID 50 – Striping of Distributed Parity

RAID 50 combines both RAID 5 and RAID 0 features. Data is striped across disks as in RAID 0, and it uses distributed parity as in RAID 5. RAID 50 provides data reliability, good overall performance and supports larger volume sizes. RAID 50 also provides high reliability because data is still available even if two disk drives fail (one in each data stripe).

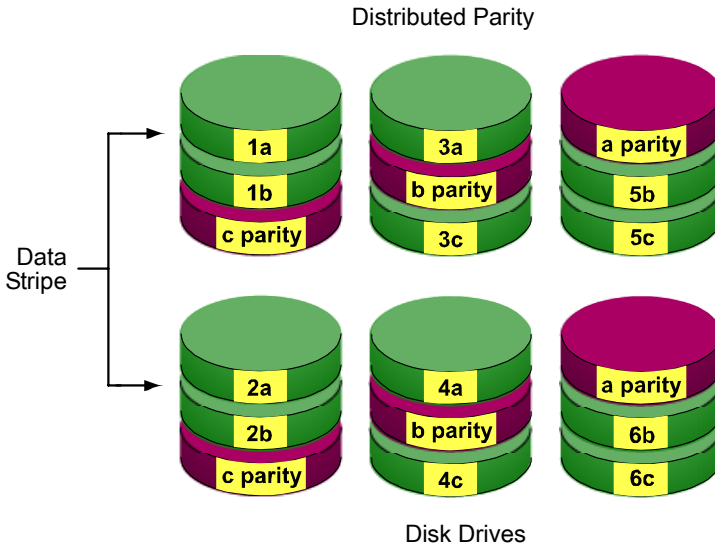

Figure 6. RAID 50 Striping of Distributed Parity disk arrays

RAID 50 disk arrays on VTrak consist of 6 to 15 disk drives.

Choosing a RAID Level

There are several issues to consider when choosing the RAID Level for your VTrak disk array. The following discussion summarizes some advantages, disadvantages and applications for each choice.

RAID 0

Advantages	Disadvantages
Implements a striped disk array, the data is broken down into blocks and each block is written to a separate disk drive I/O performance is greatly improved by spreading the I/O load across many channels and drives No parity calculation overhead is involved	Not a true RAID because it is not fault-tolerant The failure of just one drive will result in all data in an disk array being lost Should not be used in mission critical environments

Recommended Applications for RAID 0

- Image Editing
- Pre-Press Applications
- Any application requiring high bandwidth

RAID 1

Advantages	Disadvantages
Simplest RAID storage subsystem design Can increase read performance by processing data requests in parallel since the same data resides on two different drives	Very high disk overhead - uses only 50% of total capacity

Recommended Applications for RAID 1

- Accounting
- Payroll
- Financial
- Any application requiring very high availability

RAID 3

Advantages	Disadvantages
High Read data transfer rate Disk failure has an insignificant impact on throughput	Parity drive can become bottleneck if a lot of data is being written to the disk array

Recommended Applications for RAID 3

- Image Editing
- Prepress Applications
- Any application requiring high throughput

RAID 5

Advantages	Disadvantages
High Read data transaction rate Medium Write data transaction rate Good aggregate transfer rate	Disk failure has a medium impact on throughput

Recommended Applications for RAID 5

- | | |
|---|---|
| <ul style="list-style-type: none"> • File and Application servers • WWW, E-mail, and News servers | <ul style="list-style-type: none"> • Intranet servers • Most versatile RAID level |
|---|---|

RAID 10

Advantages	Disadvantages
Implemented as a mirrored disk array whose segments are RAID 0 disk arrays High I/O rates are achieved thanks to multiple stripe segments	Very high disk overhead - uses only 50% of total capacity

Recommended Applications for RAID 10

- Imaging applications
- Database servers
- General fileserver

RAID 50

Advantages	Disadvantages
High Read data transaction rate Medium Write data transaction rate Good aggregate transfer rate High reliability Supports large volume sizes	Higher disk overhead than RAID 5

Recommended Applications for RAID 50

- File and Application servers
- Transaction processing
- Office application with many users accessing small files

Choosing Stripe Block Size

The stripe block size value can be set to 4KB, 8KB, 16KB, 32KB, and 64KB.

64 KB is the default. This selection will directly affect performance. There are two issues to consider when selecting the stripe block size.

- Choose a stripe block size equal to or smaller than the smallest cache buffer found on any disk drive in your disk array. A larger value slows the disk array down because disk drives with smaller cache buffers need more time for multiple accesses to fill their buffers.
- If your data retrieval consists of fixed-size data blocks, such as some database and video applications, choose that data block size as your stripe block size.

Generally speaking, email, POS and web servers prefer smaller stripe block sizes. Video and database applications prefer larger stripe block sizes.

Gigabyte Boundary

The Gigabyte Boundary feature is designed for disk arrays in which a drive has failed and the user cannot replace the drive with the same capacity or larger. Instead, the Gigabyte Boundary feature permits the installation of a replacement drive that is slightly smaller (within 1 gigabyte) than the remaining working drive (for example, an 80.5GB drive would be rounded down to 80GB). This can be helpful in the event that a drive fails and an exact replacement model is no longer available. With VTrak, this feature is always enabled.

Initialization

Initialization is the process of setting all of the data bits on all of the disk drives to zero. This has the effect of erasing any existing data from the drives. This action is especially helpful in creating accurate parity in disk arrays with more than four drives.

Initialization applies to RAID 1, 3, 5, 10 and 50. If you create one of these disk arrays automatically, the disk array is always initialized. If you create the disk array manually, you can choose whether to initialize.

The initialization process begins immediately after the disk array is created and may take some time to finish, depending on the size of the disk drives in your disk array. Your disk array is available while initialization is in progress.

Hot Spare Drive(s)

A hot spare is a disk drive that is connected to the disk array system but is not assigned as a member of the disk array. In the event of the failure of a drive within a functioning fault tolerant disk array, the hot spare is activated as a member of the disk array to replace a drive that has failed.

VTrak will replace a failing disk drive in a disk array with an unassigned drive, if one is available. The unassigned drive is not part of any disk array. Such a drive is called a *hot spare* drive. There are two types:

- **Global** – An unassigned disk drive available to any disk array on the VTrak.
- **Dedicated** – An unassigned disk drive that can only be used by a specified disk array.

The hot spare policy function lets you select whether a disk array will access any unassigned disk drive or a designated drive in the event of disk drive failure. See page 127 (WebPAM PRO) or page 168 (CLU) for information on how to make this setting.

The spare drive effectively takes the place of the failed drive and the RAID system immediately begins to rebuild data onto the drive. When the rebuild is complete, the disk array is returned to fault tolerant status.

Once the failed drive is replaced, the new drive is automatically recognized as a hot spare and will be activated in the event of a subsequent drive fault.

Maintaining a hot spare drive is a good precaution to protect your disk array integrity in the event of drive failure.

Partition and Format the Logical Drive

Like any other type of fixed disk media in your system, a RAID logical drive must also be partitioned and formatted before use. Use the same method of partitioning and formatting on an logical drive as you would any other fixed disk.

Depending on the operating system you use, there may or may not be various capacity limitations applicable for the different types of partitions.

Cache Settings

There is a data cache on the VTrak controller and another one on each Physical disk drive. A cache holds data in volatile memory during RAID management and data transfer activity. The right combination of cache settings for your needs can improve VTrak's efficiency and performance.

Physical Drive Write Cache – Activates the write cache on the disk drive.

Write Back Cache – Activates write-back feature of VTrak's controller cache. A write back cache holds data after an I/O operation and tells the controller the data has been written. The data is written as soon as the disk drive is no longer busy.

This action increases availability of the disk array. If the power fails before the data is written to the disk drive, the data will be lost.

VTrak's controller cache is equipped with a backup battery to power the cache and retain uncommitted cache data in it until regular power can be restored. Battery condition is reported by WebPAM PRO on page 106 and the CLU on page 152.

The alternative is a write-through cache policy, which reports that the data has been written to the disk only when it actually has.

Where to Make Settings

In WebPAM PRO, these functions are under:

- Click on the Disk Array  icon, then click on the Settings tab. See page 119

In the CLU, these functions are under:

- Drive Write Cache – From the Main Menu, press **2 Enter, 2 Enter**. See page 155
- VTrak's Cache Policy – From the Main Menu, press **3 Enter, 4 Enter, 3 Enter**. See page 166

RAID Level Migration

To *migrate* a disk array is to do one or both of the following:

- Change its RAID level
- Increase the number of disk drives (sometimes called Expansion)

Migration takes place on an existing Functional disk array without disturbing the existing data. While the disk array is migrating, you can access the data as before. When migration is complete, your disk array will have a different RAID level and/or a larger capacity.

Different types of disk arrays use different organizational models and have varying benefits. The following outline breaks down the properties for each type of RAID supported by Promise products.

From	To	Increase		Redundancy	
		Capacity	Performance	Add	Lose
RAID 50	RAID 10	•			
	RAID 3/5		•		
	RAID 0	•	•		•
RAID 10	RAID 50	•			
	RAID 3/5	•			
	RAID 0	•	•		•
RAID 3/5	RAID 50			•*	
	RAID 10		•		
	RAID 0	•	•		•
RAID 1	RAID 50	•	•		
	RAID 10	•	•		
	RAID 3/5	•	•		
	RAID 0	•	•		•
RAID 0	RAID 50	•	•	•	
	RAID 10	•	•	•	
	RAID 3/5	•	•	•	
	RAID 1			•	
* Increases the existing redundancy					



Important

- The Target disk array may require more disk drives than the Source disk array
 - If the Target disk array requires an EVEN number of disk drives but the Source disk array has an ODD number, ADD a disk drive as part of the migration process
 - You cannot reduce the number of disk drives in your disk array, even if the Target disk array requires fewer disk drives than the Source disk array
 - RAID 1 (mirroring) works with two drives only. Only a single-drive RAID 0 disk array or a single-drive JBOD can migrate to RAID 1. Other RAID Levels use too many drives to migrate
 - You cannot migrate a disk array when it is Critical or performing activities such as Synchronizing, Rebuilding and PDM
-

Ranges of Disk Array Expansion

There are limitations to how large you can expand a disk array, depending on the size of your current disk array.

The current SCSI and Fibre Channel HBA cards and PC Operating Systems support a 10-byte LBA format. This means that a disk array can have up to 4 billion address blocks or sectors.

Multiply the number of blocks by the sector size to find the capacity of a disk array:

4,000,000,000 blocks x 512 bytes per sector = 2,048,000,000,000 bytes of data for a 2TB drive.

Note that you cannot change the size of the sectors nor can you increase the number of address blocks above 4 billion.

As a result, there are range limits imposed upon disk array expansion as shown in the table above. For example:

- You can expand a 2.5 TB disk array up to 4 TB
- You can only expand a 1.9 TB disk array up to 2 TB

See the chart on the next page.

Current LD Size	Maximum LD Expansion Size	Sector Size
8 to 16 TB	16 TB	4096 bytes
4 to 8 TB	8 TB	2048 bytes
2 to 4 TB	4 TB	1024 bytes
0 to 2 TB	2 TB	512 bytes

You can direct WebPAM PRO or the CLU to expand a disk array beyond the maximum expansion size. However, when expansion is finished, your disk array will be the maximum size listed in the table.

If you require a disk array larger than the maximum expansion size:

1. Backup the data from the current disk array.
2. Delete the current disk array.
3. Create a new disk array with the desired capacity.
4. Restore the data to the new disk array.

Chapter 8: Troubleshooting

- VTrak is Beeping (below)
- CLU Reports a Problem (below)
- WebPAM PRO Reports a Problem (page 224)
- LEDs Display Amber or Red (page 226)
- Event Notification Response (page 230)
- Critical & Offline Disk Arrays (page 234)
- Enclosure Problems (page 235)
- Connection Problems (page 239)

This Chapter covers troubleshooting procedures for VTrak.

VTrak is Beeping

VTrak's audible alarm has four sound patterns:

- Beep. Beep. Beep. – Indicates that a disk array is rebuilding
- Beep-beep, beep-beep, beep-beep. – Indicates that a disk array is critical
- Beep-beep-beep. Beep-beep-beep. – Indicates a problem with a field replaceable unit (FRU)
- 10 second continuous beep – Indicates that a disk array is offline

See “Critical & Offline Disk Arrays” on page 234.

See “Back of Enclosure” on page 229 for more information on FRUs.

CLU Reports a Problem

The CLU can report a variety of problems with the VTrak. In order to see them, the CLU must be open. Some conditions are only indicated when you select the corresponding function.

In this example, let us check disk array status.

1. Open the CLU.
2. Press **3** and **Enter** to select *Disk Array Management*.
3. Observe the status of your disk arrays.

ID	Name	RAID	SBS	CAP	Member PDs	Status
1	Array1	5	64K	239GB	1-2,4	Functional
2	Array2	1	64K	35GB	3,5	Critical

In the example above, disk array “Array2” is critical. See “Critical & Offline Disk Arrays” on page 234.

WebPAM PRO Reports a Problem

WebPAM aids in troubleshooting your logical drives and enclosure by continuous monitoring and reporting to the User in the following ways:

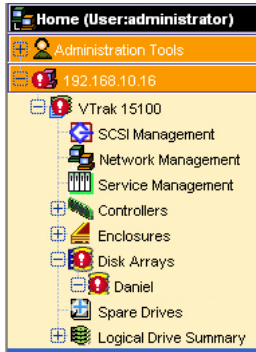

- Displays red circles  in Tree View (above)
- Sends email messages, per your configuration



- Displays popup messages, per your configuration (above)

192.168.10.52 Subsystem Information
Help

Information
Events ▾
Connection Status
User Rights

View Events - Tue Nov 09 04:54:08 PST 2004
Events Per Page: 5 ▾

Subsystem Name	Description	Time
192.168.10.52	VTTrak 12100 : Full initialization completed on Disk Array Daniel.	Fri Nov 05 00:17:00 PST 2004
192.168.10.52	VTTrak 12100 : LD 1 created on DA 1.	Thu Nov 04 23:38:23 PST 2004
192.168.10.52	VTTrak 12100 : Full initialization started on Disk Array Daniel.	Thu Nov 04 23:38:13 PST 2004
192.168.10.52	VTTrak 12100 : Create a new Disk Array Daniel.	Thu Nov 04 23:38:09 PST 2004
192.168.10.52	VTTrak 12100 : administrator created Logical Drive ld1	Thu Nov 04 23:38:08 PST 2004

<< Previous Events
Next Events ->

- Keeps a record in the Event Log (above)

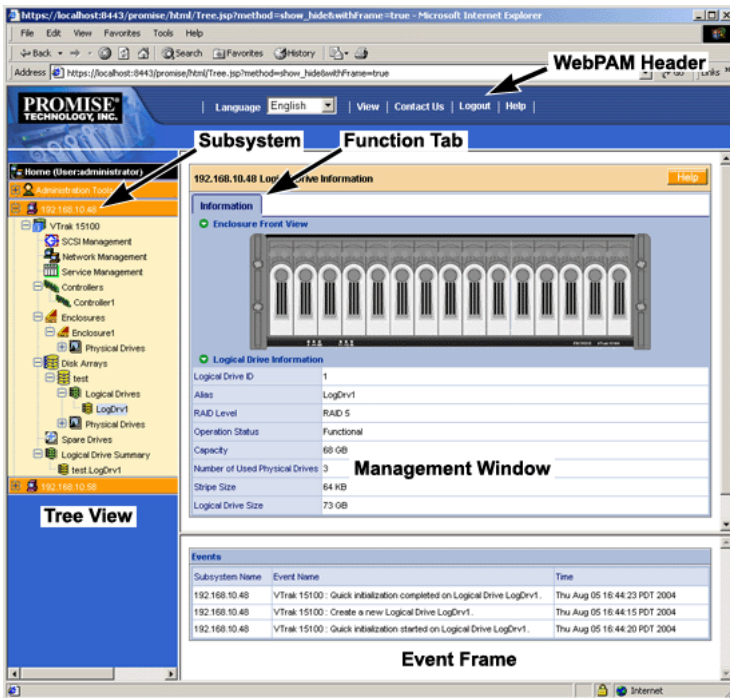

- Displays full information on the selected component the Management Window (above)

Click these links to see specific troubleshooting topics:

- “Event Notification Response” on page 230
- “Critical & Offline Disk Arrays” on page 234
- “Frequently Asked Questions” on page 241

LEDs Display Amber or Red

Front Panel

When the power is switched on, the LEDs on the front of the VTrak will light up.

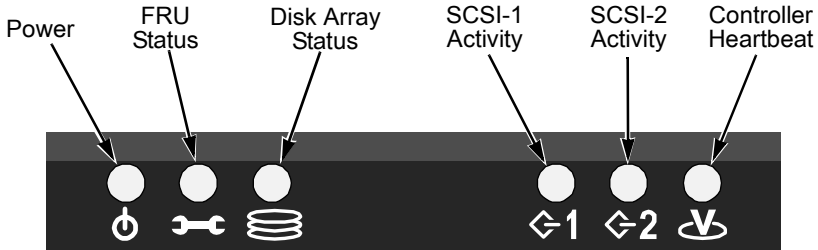

Figure 4. VTrak 15110 Front Panel LEDs

When boot-up is finished and the VTrak is functioning normally:

- Controller LED blinks green once per second for five seconds, goes dark for five seconds, then blinks green once per second for five seconds again.
- Power, FRU and Disk Array LEDs display green continuously.
- SCSI LEDs flash green if there is activity on that channel.

See the table on the next page.

LEDs	State				
	Dark	Steady Green	Flashing Green	Amber	Red
Power	System Off	Normal	n/a	n/a	n/a
FRU*	System Off	Normal	n/a	Fan or Battery Problem	Fan or Battery Failed
Logical Drive	System Off	Normal	n/a	Logical Drive Critical	Logical Drive Offline
SCSI-1 SCSI-2	No Connection	n/a	Activity	n/a	n/a
Controller	System Off	n/a	Normal**	n/a	n/a
<p>* Field Replacement Unit. "n/a" means this state does not apply to this LED.</p> <p>** Five green blinks, one per second; dark 10 seconds; five green blinks.</p>					

See page 189 for more information about field-replaceable components.
See page 234 for a discussion of critical and offline logical drives.

Drive Status Indicators

There are two LEDs on each Drive Carrier. They report the presence of power and a disk drive, and the current condition of the drive.

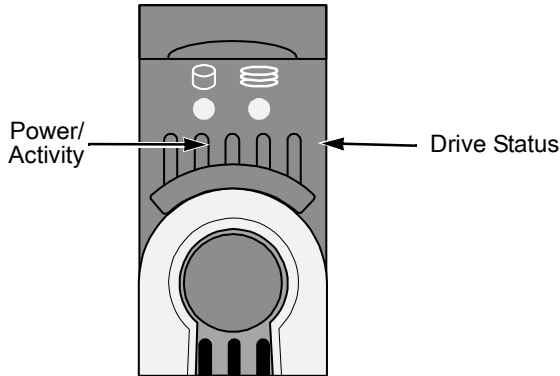

Figure 5. VTrak Drive Carrier LEDs.

Under normal conditions, the Power/Activity and Disk Status LEDs should display green.

LEDs	State				
	Dark	Steady Green	Flashing Green	Amber	Red
Power/Activity	No Drive	Drive Present	Activity	n/a	n/a
Status	No Power	Drive OK	n/a	Drive Rebuilding	Drive Error

"n/a" means this state does not apply to this LED.

See "Critical & Offline Disk Arrays" on page 234.

Back of Enclosure

When the FRU Status LED on VTrak's front panel shows Amber or Red, check the LEDs on the back of VTrak. These LEDs give the status of the field replaceable units.

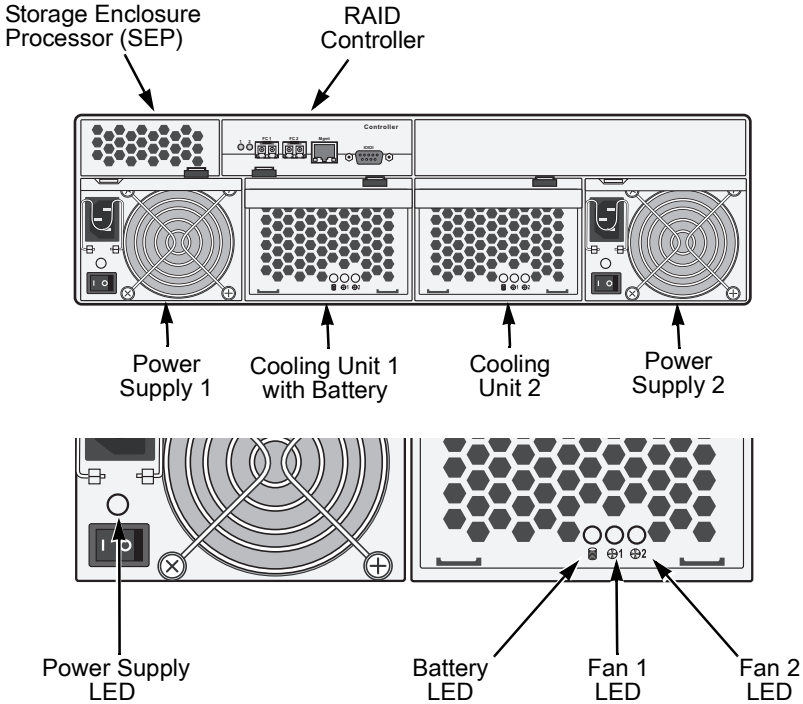

Figure 6. LEDs on the back of VTrak

Under normal conditions, the power supply, battery and fan LEDs should display green. Note that on the VTrak 15000 series, the left cooling unit houses a cache-backup battery but the right unit does not.

LEDs	State			
	Dark	Green	Amber	Red
Power supply	Not detected	OK	Fan failed	Failed
Battery	Not detected	OK	Too hot or Low capacity	Failed
Fan 1 or 2	Not detected	OK	Wrong speed	Failed

To check a component's installation, follow the same procedure as replacing the component, except that you reinstall the original component rather than a new one. In most cases, this action fixes a bad connection and allows VTrak to detect the component. If this action does not correct the problem, replace the unit. See page 189 for instructions.

Event Notification Response

When you select Event Notification, WebPAM PRO sends popup and/or email messages regarding its status. The messages you see depend on your notification selection (see page 78) and what is currently happening in the VTrak.

The chart below gives the suggested action when the corresponding message is displayed.

Event	Action
Controller Notification	
Controller Unknown Error	Unspecified problem with the Controller.*
Data Parity Error	SCSI data parity error.*
Command Parity Error	SCSI command parity error.*
Bus Reset	The Initiator sent a command to reset the SCSI bus, to correct a problem.*
Unrecoverable Error	Restart the Promise Product to clear the problem.*
Abort Task	A normal event. Result of user action.
Clear ACA	Cleared an auto contingent alliance condition.*
LUN Reset	A normal event. Result of user action.
Initiator Error	SCSI/FC initiator error.*
Illegal Secondary Identify	A target received a second Identify message with a different LUN.*
Message Parity Error	SCSI/FC message parity error.*
Bus Reboot	The VTrak rebooted itself.*
	* An occasional incident of one of these messages does not necessarily indicate a problem. However, if any of these messages appears repeatedly, contact Technical Support.
Connection Notification	
Connection Made	Normal result of logging in.
Connection Notification, cont.	

Event	Action
Connection Lost	Normal result of logging out. Also a result of poor SCSI/FC cable or network connection.
Disk Notification	
Disk Down	Identify the disk drive involved. Power down the system, remove and test the drive. Replace the drive as needed.
Disk Plugged In	A disk drive has been plugged into the enclosure. Normal.
Disk Access Retry	Watch this disk drive. If problems persist, power down the system, remove and test the drive. Replace the drive as needed.
Disk CRC Error	Identify the disk drive involved. Power down the system, remove and test the drive. Replace the drive as needed.
Disk SMART Failed	Identify the disk drive involved. Power down the system, remove and test the drive. Replace the drive as needed.
Disk ECC Error	
Disk Bad Sector	
Disk Reserve Sector Error	
Disk Time Out	
Logical Drive Notification	
Create Logical Drive	A new logical drive was created. Normal.
Delete Logical Drive	A logical drive was deleted. Normal.
Logical Drive Critical	If hot-spare is enabled, logical drive will rebuild automatically with a new disk drive. Identify and replace the failed drive. Without a hot spare, the logical drive will attempt to rebuild the failed drive. If this action repeats, remove the drive for test and repair or replacement.
Logical Drive Offline	Go to the Promise website and download a document called <i>Array Recovery Procedures</i> or contact Technical Support.
Logical Drive Migration Started	Expansion or RAID level change of logical drive begun. Normal.
Logical Drive Notification, cont.	

Event	Action
Logical Drive Migration Completed	Expansion or RAID level change of logical drive finished. Normal.
Logical Drive Migration Stopped	User aborted expansion or RAID level change. Normal.
Logical Drive Rebuild Start	Rebuild begun. This can happen automatically depending on Controller settings. Normal.
Logical Drive Rebuild Completed	Rebuild finished. Normal.
Logical Drive Rebuild Stopped	User aborted Rebuild. Normal.
Logical Drive Synchronization Start	Synchronization begun. This can happen automatically depending on Controller settings. Normal.
Logical Drive Synchronization Completed	Synchronization finished. Normal.
Logical Drive Synchronization Stopped	User aborted Synchronization. Normal.
Logical Drive Synchronization Comparison Error	Data discrepancy found and corrected. If this message appears frequently, contact Technical Support.
Logical Drive Synchronization Internal Error	Data discrepancy found but not corrected. Contact Technical Support.
Logical Drive Full Initialization Start	Full Initialization started. Normal.
Logical Drive Full Initialization Completed	Full Initialization finished. Normal.
Logical Drive Full Initialization Stopped	User aborted logical drive Full Initialization. Normal.
Logical Drive Quick Initialization Start	Quick Initialization started. Normal.
Logical Drive Quick Initialization Completed	Quick Initialization finished. Normal.
Logical Drive Notification, cont.	

Event	Action
Logical Drive Quick Initialization Stopped	User aborted Quick Initialization. Normal.
Logical Drive Percent Completed	Progress in percent of synchronizing or rebuilding a logical drive. Normal
Enclosure Notification	
Enclosure Power Down	Power switched OFF. Turn power ON.
Enclosure Power Up	Power is ON. Normal.
Enclosure Unknown Error	Unspecified problem with the Controller. If this message appears frequently, note any malfunctions and contact Technical Support.
Enclosure Over Temperature	Click on Enclosure1 in WebPAM to identify location of overheat condition. Verify that there is ample space around the enclosure. Check that all fans are running and airflow is not obstructed. Correct any problems.
Enclosure Fan Stop	Click on Enclosure1 in WebPAM to identify failed fan. Replace as needed.
Enclosure 3.3 Volt Range	Go to Controller management > Enclosure management > Voltage in CLU. Or click on Enclosure1 in WebPAM to check power supply status. Replace as needed.
Enclosure 5 Volt Range	
Enclosure 12 Volt Range	
Battery Temperature Rise	Click on Enclosure1 in WebPAM to check for overheat condition. Correct any problems.
Battery Temperature Dropped	Normal.
Battery Capacity below threshold	Replace Battery.
Battery Capacity Normal	Normal.
Battery Discharging	Could be a SEP problem. If this message appears repeatedly, contact Technical Support.
Battery Maintenance Mode	Normal.
Battery life ended	Replace Battery.

Critical & Offline Disk Arrays

A fault-tolerant disk array—RAID 1, 3, 5, 10 and 50—goes critical when a drive is removed or fails. Due to the fault tolerance of the disk array, the data is still available and online. However, once the disk array goes critical, the disk array has lost its fault tolerance, and performance may be adversely affected.

If the fault was caused by a failed drive that was removed, the drive must be replaced by another drive, either identical or larger, in order for the RAID system to rebuild and restore optimal configuration.

If your fault-tolerant disk array goes offline, go to the Promise website (www.promise.com) and download a document called *Array Recovery Procedure*.

A non-fault tolerant disk array—RAID 0—goes offline when a drive is removed or fails. Since the disk array is not fault tolerant, the data stored in the disk array is no longer accessible.

If one disk drive fails, all of the data on the disk array is lost. You must replace the failed drive. Then, if the disk array had more than one disk drive, delete the disk array and re-create it. Restore the data from a backup source.

When a Disk Drive Fails

VTrak provides both audible and visual indicators to alert you of a disk drive failure. The following will occur when a disk drive fails or goes offline:

- The Disk Array LED changes from green to amber
- The Disk Carrier Status LED changes from green to red
- The audible alarm repeatedly sounds two short beeps
- WebPAM PRO and the CLU report the condition

Rebuild

Normally, the disk array will begin rebuilding automatically. You can access your disk array during this time but read/write performance might be slower than normal.

- If a hot spare drive is provided and enabled, the controller will activate the hot spare and rebuild disk array information and data to it.
- If there is no hot spare drive available, the controller will wait until a replacement disk drive is installed. The disk array will remain Critical.

With a Hot Spare Drive

After the disk array rebuilds itself using the hot spare:

1. Replace the failed drive.
2. Check the automatic rebuild and hot spare policy to be sure your disk array(s) recognize(s) the new drive as a hot spare.

Without a Hot Spare Drive

If no hot spare drive is available, the VTrak will not rebuild the disk array and it will remain Critical.

When you install a replacement disk drive into the enclosure, the disk array will automatically rebuild the information and data on the newly installed disk drive if Automatic Rebuild option is enabled.

To enable Automatic Rebuild and set Hot Spare Policy, see page 119 (WebPAM) or page 168 (CLU).



Important

If your replacement disk drive was formerly part of a different disk array, use the CLU to wipe the reserve sector on the replacement disk drive. See page 156.

Enclosure Problems

WebPAM displays red circles  in Tree View to identify components that need attention.

Follow the trail of red circles...

...to identify which component needs attention.

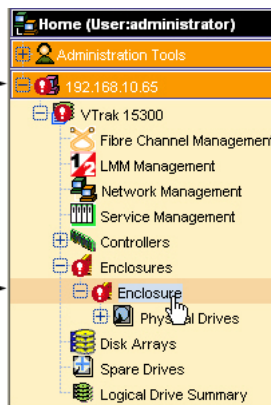

When a red circle appears over a Host in Tree View, click on the Enclosure icon. The Enclosure screen will display (below).

The screenshot shows the '192.168.10.48 Enclosure' management page. It features a 3D perspective view of the enclosure with a red circle and arrows highlighting a failed fan on the left side. Below the diagram is a table of sensor data.

Service Enclosure Processor Polling Point	Healthy Operating Threshold Range	Fan Status	Current Polled Value
Power Supply Fan 1	>3750 RPM	OFF	0 RPM
Power Supply Fan 2	>3750 RPM	ON	5720 RPM

Service Enclosure Processor Polling Point	Healthy Operating Threshold Range	Current Polled Value
Cooling Unit 1 / Blower 1	>1450 RPM	1962 RPM
Cooling Unit 1 / Blower 2	>1450 RPM	1906 RPM
Cooling Unit 2 / Blower 1	>1450 RPM	1834 RPM
Cooling Unit 2 / Blower 2	>1450 RPM	1824 RPM

Service Enclosure Processor Polling Point	Healthy Operating Threshold Range	Current Polled Value
Backplane Temperature Sensor 1	≤ 40°C / ≤ 111°F	32 °C / 89 °F
Backplane Temperature Sensor 2	≤ 40°C / ≤ 111°F	30 °C / 86 °F
Backplane Temperature Sensor 3	≤ 40°C / ≤ 111°F	28 °C / 82 °F
Backplane Temperature Sensor 4	≤ 40°C / ≤ 111°F	27 °C / 80 °F
Backplane Temperature Sensor 5	≤ 40°C / ≤ 111°F	28 °C / 82 °F
RAID Controller Temperature Sensor	≤ 54°C / ≤ 129°F	37 °C / 98 °F

Service Enclosure Processor Polling Point	Healthy Operating Threshold Range	Current Polled Value
3.3 Volt Power	± 5% (3.135 - 3.465)	3.39 V
5.0 Volt Power	± 5% (4.75 - 5.25)	5.1 V
12.0 Volt Power	± 10% (10.8 - 13.2)	12.09 V

In this example, a power supply fan has stopped turning, indicating a failure. The Enclosure Diagram displays color and motion changes to identify a failed fan. In this case, you must replace the power supply.

Overheating



Overheating is a potentially serious condition because the excessively high temperatures can lead to disk drive failure and controller malfunction.

Overheating usually results from:

- Fan failure
- Poor air circulation around the enclosure

WebPAM reports failed fans along with elevated temperature. On VTrak, there are two kinds of fans:

- Power supply, 1 fan each, 2 fans total
- Cooling units, 2 fans each, 4 fans total

If a power supply fan fails, you must replace the power supply. If a cooling unit fan fails, you can remove the cooling unit and replace only the fan itself.

Cooling Unit Fan Condition



Power Supply Fan Condition



No tools are required for either procedure. See page 197 for instructions on replacing the fans.

Air circulation around the VTrak enclosure may be a more complex problem. Use the thermometer icons to help you locate the specific hot spot. Check for these conditions:

- Accumulated dust or objects blocking the fans
- Less than a minimum of 5 inches (13 cm) space between the back of the VTrak and the wall or other object
- Ambient temperature above 95°F (35°C) where the VTrak is operating

To cool down a VTrak, do the following:

- Correct any problems identified above
- Power it down and let it sit for an hour or longer

Power Supplies



VTraks are equipped with redundant power supplies. The advantage of dual power supplies is that, should one fail, the other will continue powering the subsystem until the faulty one can be replaced. VTrak is capable of operating on a single power supply. As a result, if one power supply fails you must watch the front panel LEDs or WebPAM in order to become aware of the condition.



The power supplies are hot-swappable, meaning you can leave the VTrak running when you replace the bad one. Be careful, however, to remove the faulty power supply and not the good one, or VTrak will come to an immediate stop and your data will be unavailable until the system is powered and booted again.



As noted above, if a power supply fan fails, you must replace the power supply. Without the fan to cool it, the power supply will overheat and eventually fail anyway.

No tools are required for the procedure. See your page 196 for instructions on replacing a power supply.

Battery

Battery Condition



VTrak uses a battery as backup power for the cache. Should a power failure occur, the battery enables the cache to hold data up to 72 hours. The battery recharges during normal VTrak operation.



In most cases, installing a replacement battery will correct a marginal or failed condition. The battery is located on the left cooling unit. Remove the cooling unit for access. The battery is hot-swappable.



No tools are required for the procedure. See page 202 for instructions on replacing the battery.

Connection Problems

When you install your Promise product following the instructions in the *Quick Start Guide* and *User Manual*, you should have little trouble getting your equipment to work the first time. But connection problems can arise that are not the User's or Installer's fault. Every conceivable problem cannot be covered in the documentation but some guidelines could be helpful.

Connection problems cause a majority of failures in almost any electrical system. While the installation of the cables and components was correct, they don't function properly, or at all, because:

- A connector is dirty or corroded
- A connector is loose or damaged
- A cable looks OK outside but has an open circuit inside
- The wrong cable was used

VTraks ship with a full set of new cables and terminators, as required for each specific model. Be sure to use these components because: 1.) They are the proper ones for your RAID subsystem, 2.) They are in brand-new condition, and 3.) You paid for them with the purchase of your VTrak.

SCSI Connections

VTrak 15110 uses a network connection to pass command and management information. Data is transmitted via the SCSI bus.

SCSI connections are both physical (outside) and electrical (inside). You can see a physical connection, you can clean it or try a different cable on it. Electrical connections are made by firmware and software, such as when you set the SCSI IDs or addresses. SCSI chains are completely intolerant of ID conflicts. If you have a conflict, the devices on your SCSI chain will not work correctly until it is resolved. Check your VTrak Quick Start Guide (printed) or VTrak User Manual (on the software CD) plus the Console LUN Settings, Target ID Settings, Statistics and SCSI Information topics.

The VTrak RAID subsystem is sensitive to the presence of other devices on the SCSI chain. Do not connect other devices to the SCSI chain with a VTrak, except for an other VTrak.

Serial Connections

VTrak uses a serial connection for a command line utility (CLU). Normally, users prefer WebPAM because of its graphic user interface. But the CLU can do the same jobs. And it will work when your network connection is down.

For VTrak, you must use the CLU to set the Management Port IP address in order for WebPAM to connect with it. This issue is discussed further under Network Connections (below). See the VTrak Quick Start Guide or Chapter 2 of the User Manual for more information on setup and connections.

The CLU controls and manages but it does not move data. It communicates through a null-modem cable, supplied with the VTrak. A straight-through serial cable will not work for this purpose. You probably will not use the CLU often and want to disconnect and store the cable. Consider leaving it connected, to be sure it will be there when you need it.

Network Connections

VTrak has an RJ-45 Management Port connector on the back of its cabinet. This is a Gigabit Ethernet connector designed to connect to your network. The VTrak becomes a node on your network like any other PC, server or other component with an IP address. VTrak ships from the factory an IP address of 10.0.0.2. You must change this address to one that will work with your network. You make the initial IP address setting using the CLU, as mentioned above. You can make subsequent IP address changes using WebPAM.

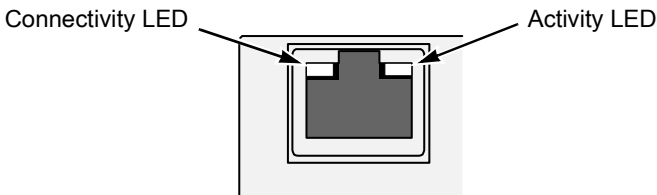

Note that VTrak Management Port can accept IP address assignments from a DHCP server. Use VTrak's Command Line Utility (CLU) to enable this feature. If you have not activated DHCP support but there is a DHCP server on your network, there is a chance that it will inadvertently assign the VTrak's Management Port IP address to another node. You might see a warning to this effect on your PC's monitor. If this happens, WebPAM may not be able to connect. See your network administrator to work out a suitable arrangement.

Chapter 9: Support

- Frequently Asked Questions (below)
 - How to contact Technical Support (page 245)
 - Limited Warranty (page 248)
 - Returning product for repair (page 249)
-

Frequently Asked Questions

What kind of disk drives can I use with VTrak?

VTrak was designed to use Serial ATA disk drives. You can also use Ultra ATA 133/100/66 disk drives with the optional PATA-to-SATA Adapter available from Promise Technology.

Can I take the disk drives from my UltraTrak, put them into the VTrak and keep my logical drive (array) intact?

Yes. VTrak uses the same logical drive format as UltraTrak. Contact Promise Technology to purchase PATA-to-SATA Adapter for your existing PATA drives.

Can I use my existing SCSI card with VTrak?

If the SCSI card has at least a 160 MB/s data transfer rate, supports LUNs and has a 68-pin VHDCI external connection, you can use it with VTrak.

If your SCSI card has a 68-pin HD external connector, you can purchase an optional 68-pin HDCI to 68-pin VHDCI SCSI cable from Promise Technology.

Will I get maximum performance using my current 80 MB/s SCSI card? Do I have to buy a 160 MB/s SCSI card?

The VTrak has a measured peak sustained throughput of more than 100 MB/s per channel. Using a 80 MB/s SCSI card will result in a performance bottleneck under certain conditions. You must estimate how frequently those conditions happen and how serious they are. Then you can decide whether to upgrade to the faster SCSI card.

How many VTrak subsystems can I connect to one SCSI chain?

You can connect up to eight (8) VTraks on a single SCSI chain.

Can I connect two SCSI cards to the same VTrak?

Yes. VTrak has two SCSI channels, which allows you to connect it to two SCSI cards, whether those cards are in the same PC or two different PCs. For more information, see page 16.

Can I connect my VTrak on the same SCSI chain with other devices?

No. Do not connect other devices to the SCSI chain with a VTrak. If you want to monitor your VTrak and run other SCSI devices from the same PC, add another SCSI card to the PC.

Can I connect my VTrak on the same SCSI chain as my Promise UltraTrak?

No. Do not connect other Promise products to the SCSI chain with a VTrak. If you want to monitor your VTrak and UltraTrak from the same PC, add another SCSI card to the PC.

How can I tell when the VTrak has fully booted?

When the VTrak is fully booted up, the Power, FRU and Disk Array LEDs will light up green. The Controller LED blinks five times, once per second; goes dark for five seconds; then blinks five times again.

How do I learn more about configuring and using my VTrak?

Read this *VTrak 15110 User Manual*. It contains detailed information regarding configuration, troubleshooting and maintenance of your VTrak.

Why does VTrak come with a Command Line Utility?

First, to assign your VTrak a Management Port IP address in order for the WebPAM PRO management software to connect to it. Second, in the event of a network failure, you can still access the VTrak.

The serial cable is connected, VTrak is running and I used the specified settings but the serial connection does not work. What should I do now?

Access your PC BIOS settings and enable the serial port.

I tried to log into WebPAM PRO but my browser showed the message "cannot be displayed." What is the problem?

The browser decided prematurely that WebPAM was not responding. Click the Refresh button. This action usually brings up the login screen.

I created a Subsystem on WebPAM PRO but when I click on it, nothing happens. What is the problem?

There is a broken network connection between your PC and the VTrak, or the VTrak is powered off. Locate and fix the connection or power on the VTrak, as required.

Can WebPAM PRO connect through VTrak's Serial (RS-232) port?

No. The VTrak Serial port is only for a HyperTerminal connection.

I can access the VTrak over my company's intranet. But I can't access it from an outside Internet connection. How do I make the Internet connection work?

This condition is not related to VTrak, but is due to your firewall and network connection protocol. Contact your MIS Administrator.

With other Promise products, such as UltraTrak, I used the Host PC's IP address in WebPAM PRO to connect with the RAID subsystem. Why is VTrak different?

UltraTrak uses In-Band SCSI technology to connect with the Host PC. VTrak connects to the Host PC through a network connection. Therefore, it requires its own IP address. VTrak's iSCSI connection is used only to move data.

Why can a RAID 1 disk array on VTrak consist of only two disk drives?

On VTrak, RAID 1 disk arrays work in matched pairs. But you are not limited to just one RAID 1 disk array. VTrak supports up to 7 RAID 1 disk arrays, using up to 14 disk drives. Or you can create a single RAID 10 disk array with data mirroring and up to 14 physical drives.

See page 207 for more information on the number of disk drives you can use for each RAID level.

Are disk arrays on VTrak limited to 2.199 terabytes?

No. The 2.199 TB disk array size limit does not apply to VTrak. Check whether your operating system supports disk arrays over 2.199 TB.

If disk arrays can exceed 2.199 TB on VTrak, why can't I expand my disk array beyond 2.199 TB?

The problem is a limitation of the Operating System and the number and size of LBA sectors it can manage. See page 221 for more information and your options for disk array expansion.

The CLU, WebPAM PRO and VTrak documentation use the term "logical drive" or "disk array" where earlier Promise products use the term "array." Why did this change happen?

A disk array is an organized collection of physical disk drives. Logical drives are made from disk arrays. A logical drive is the entity that your operating system recognizes as a single volume (as if it were a single disk drive). Promise separated the disk array and logical drive functions in order to provide more RAID management options.

I have two UltraTraks and use WebPAM to monitor them. Can I use my existing WebPAM setup to monitor the VTraks also?

No. Install WebPAM PRO from the VTrak Software CD.

The VTrak has no LCD panel. How can I set it up and create disk arrays?

There are two ways to set up VTrak and create disk arrays, using WebPAM PRO, on page 111 or the Command Line Utility, on page 161.

Why do the Rebuild, Synchronize, Expand and Migrate operations take so long compared to moving data?

When data is moved, the operation consists of reading, writing and checking one or more files. Rebuild, Synchronize, Expand and Migrate involve reading, writing and checking all the logical block addresses or individual data blocks on each disk drive. Plus, your disk array remains available while these operations take place. These added requirements increase complexity and take more time.

How can I be sure everything is working OK on the VTrak?

VTrak has several LEDs on the front to monitor the status of power, field replaceable units (FRUs) and disk arrays. When these are green, VTrak is functioning normally.

What happens if a disk array goes critical?

On the front of VTrak, the disk array LED turns amber and an audible alarm sounds. This condition is described in Chapter 4 of the *VTrak User Manual* on the Software CD.

Can VTrak run using just one power supply?

Yes, it is possible to run VTrak on a single power supply. There are two power supplies so that VTrak will continue running if one of the power supply fails. But deliberately leaving one power supply off negates this advantage. Always switch on both power supplies.

Contacting Technical Support

Promise Technical Support provides several support options for Promise users to access information and updates. We encourage you to use one of our electronic services, which provide product information updates for the most efficient service and support.

If you decide to contact us, please have the following information available:

- Product model and serial number
- BIOS and driver version numbers
- A description of the problem / situation
- System configuration information, including: motherboard and CPU type, hard drive model(s), SATA/ATA/ATAPI drives & devices, and other controllers.

Technical Support Services

Promise Online™ Web Site	http://www.promise.com (technical documents, drivers, utilities, etc.)
--------------------------	--

North & South America

E-mail Support	support@promise.com
Fax Technical Support	(408) 228-1097 Attention: Technical Support
Phone Technical Support	(408) 228-1400 option 4 7:30-5:30pm M-F Pacific Standard Time
If you wish to write us for support:	Promise Technology, Inc. Attn: Technical Support 580 Cottonwood Drive Milpitas, CA 95035, USA

Europe, Africa, Middle East

E-mail Support	support@promise.nl
Fax Technical Support	+31 (0) 40 256 9463 Attention: Technical Support
Phone Technical Support	+31 (0) 40 235 2600 8:30-5:00pm The Netherlands Time
If you wish to write us for support:	Promise Technology Europe B.V. Attn: Technical Support Luchthavenweg 81-125 5657 EA Eindhoven, The Netherlands
E-mail Support	support-de@promise-emea.com
Fax Technical Support	+49 (0) 2 31 56 76 48 - 29 Attention: Technical Support
Phone Technical Support	+49 (0) 2 31 56 76 48 - 0 8:30-5:00pm Germany Time
If you wish to write us for support:	Promise Technology Germany Attn: Technical Support Europaplatz 9 Dortmund, Germany

Pacific Rim

E-mail Support	support@promise.com.tw
Fax Technical Support	+886 3 564 53 13 Attention: Technical Support
Phone Technical Support	+886 3 578 23 95 (ext. 8873) 9:00-5:30pm Taiwan Time
If you wish to write us for support:	Promise Technology, Inc. Attn: Technical Support 2F, No. 30, Industry E. Rd. IX Science-based Industrial Park Hsinchu, Taiwan, R.O.C.

China

E-mail Support	support-china@promise.com
Fax Technical Support	+86-10-8857-8015 Attention: Technical Support
Phone Technical Support	+86-10-8857-8085/8095 9:00-6:00pm China Time
If you wish to write us for support:	Promise Technology China Attn: Technical Support Room 1205, Tower 3 Webok Time Center, No.17 South Zhong Guan Cun Street Hai Dian District, Beijing 100081, P.R. China

Limited Warranty

Promise Technology, Inc. (“Promise”) warrants that for three (3) years from the time of the delivery of the product to the original end user:

- a) the product will conform to Promise’s specifications;
- b) the product will be free from defects in material and workmanship under normal use and service.

This warranty:

- a) applies only to products which are new and in cartons on the date of purchase;
- b) is not transferable;
- c) is valid only when accompanied by a copy of the original purchase invoice.
- d) Is not valid on spare parts, fans, and power supplies

This warranty shall not apply to defects resulting from:

- a) improper or inadequate maintenance, or unauthorized modification(s), performed by the end user;
- b) operation outside the environmental specifications for the product;
- c) accident, misuse, negligence, misapplication, abuse, natural or personal disaster, or maintenance by anyone other than a Promise or a Promise-authorized service center.

Disclaimer of other warranties

This warranty covers only parts and labor, and excludes coverage on software items as expressly set above.

Except as expressly set forth above, Promise **DISCLAIMS** any warranties, expressed or implied, by statute or otherwise, regarding the product, including, without limitation, any warranties for fitness for any purpose, quality, merchantability, non-infringement, or otherwise. Promise makes no warranty or representation concerning the suitability of any product for use with any other item. You assume full responsibility for selecting products and for ensuring that the products selected are compatible and appropriate for use with other goods with which they will be used.

Promise **DOES NOT WARRANT** that any product is free from errors or that it will interface without problems with your computer system. It is your responsibility to back up or otherwise save important data before installing any product and continue to back up your important data regularly.

No other document, statement or representation may be relied on to vary the terms of this limited warranty.

Promise's sole responsibility with respect to any product is to do one of the following:

- a) replace the product with a conforming unit of the same or superior product;
- b) repair the product.

Promise shall not be liable for the cost of procuring substitute goods, services, lost profits, unrealized savings, equipment damage, costs of recovering, reprogramming, or reproducing of programs or data stored in or used with the products, or for any other general, special, consequential, indirect, incidental, or punitive damages, whether in contract, tort, or otherwise, notwithstanding the failure of the essential purpose of the foregoing remedy and regardless of whether Promise has been advised of the possibility of such damages. Promise is not an insurer. If you desire insurance against such damage, you must obtain insurance from another party.

Some states do not allow the exclusion or limitation of incidental or consequential damages for consumer products, so the above limitation may not apply to you.

This warranty gives specific legal rights, and you may also have other rights that vary from state to state. This limited warranty is governed by the State of California.

Your Responsibilities

You are responsible for determining whether the product is appropriate for your use and will interface with your equipment without malfunction or damage. You are also responsible for backing up your data before installing any product and for regularly backing up your data after installing the product. Promise is not liable for any damage to equipment or data loss resulting from the use of any product.

Returning Product For Repair

If you suspect a product is not working properly, or if you have any questions about your product, contact our Technical Support Staff through one of our Technical Services, making sure to provide the following information:

- Product model and serial number (required)
- Return shipping address
- Daytime phone number
- Description of the problem
- Copy of the original purchase invoice

The technician will assist you in determining whether the product requires repair. If the product needs repair, the Technical Support Department will issue an RMA (Return Merchandise Authorization) number.

Return ONLY the specific product covered by the warranty (do not ship cables, manuals, diskettes, etc.), with a copy of your proof of purchase to:

- | | |
|------------------|---|
| USA and Canada: | Promise Technology, Inc.
Customer Service Dept.
Attn.: RMA # _____
1745 McCandless Drive
Milpitas, CA 95035 |
| Other Countries: | Return the product to your dealer
or retailer.

Contact them for instructions
before shipping the product. |

You must follow the packaging guidelines for returning products:

- Use the original shipping carton and packaging
- Include a summary of the product's problem(s)
- Write an attention line on the box with the RMA number
- Include a copy of proof of purchase

You are responsible for the cost of insurance and shipment of the product to Promise. Note that damage incurred due to improper transport or packaging is not covered under the Limited Warranty.

When repairing returned product(s), Promise may replace defective parts with new or reconditioned parts, or replace the entire unit with a new or reconditioned unit. In the event of a replacement, the replacement unit will be under warranty for the remainder of the original warranty term from purchase date, or 30 days, whichever is longer.

Promise will pay for standard return shipping charges only. You will be required to pay for any additional shipping options (such as express shipping).

Appendix A: Serial Connector Pinout

Below is the pinout diagram for the DB-9 serial connector on all VTraks.

The diagrams represent the connector as you see it looking at the back of the VTrak.

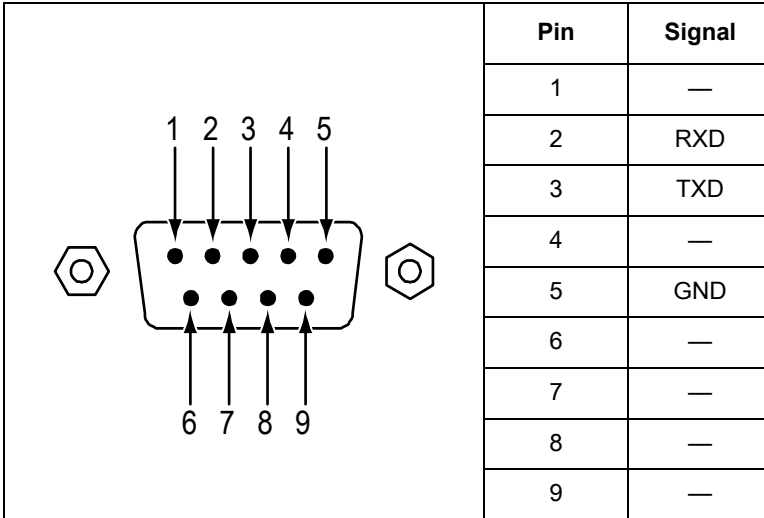

Index

A

About This Manual 1
Architectural Description of VTrak 3
Audible alarm 67, 136, 223

B

Beeper 67
Boot Sector, wipe 156
Buzzer 136

C

Cache settings 219
Certifications 6
Choose
 cache setting 219
CIMOM Agent 34
CLU
 Auto Rebuild Option 169
 Battery 152
 Blink LED 157
 Buzzer 151
 connection 57
 Controller Management 148
 Diagnostics, disk drive 157
 disk array auto creation 161
 Disk Array Management 160
 disk array, create automatically 58
 disk array, create manually 59
 Enclosure Management 151
 Event viewer 188
 exit 64, 139
 Fan Speed 151
 firmware update 190
 I/O Statistics, disk drives 158
 Network Management 173
 PDM auto start 169

Physical Drive Management 154
priority settings 167
Problem reporting 223
reports problem 223
SCSI management 180
SCSI target ID 180
Temperature 152
Voltage 152

Connection

Management port 22
Power 23
SCSI 18, 19, 20, 21
Telnet 29

Connection problems and solutions 239

Controller LED 24, 65, 133, 226

D

Dimensions 6
Disk array
 auto creation 161
 create manually 162
 Critical status 234
 delete 164
 Migrate 183
 Properties 164
 Status LED 65, 133, 226
Disk Array Management 160
Disk drive
 carrier 11
 failure and recovery 234
 install 9
 LEDs 24
 move from UltraTrak 241
 numbering 14
 PATA, set jumpers 10
 PATA-to-SATA Adapter 241
 rebuild 234

- Status LED 25
 - usable in VTrak 241
 - View parameters 155
 - Write cache 155
- Disk Status LED 25

E

- Email Alert Notification, set up 86
- Enclosure
 - Problem reporting 235
- Environmental 6
- Event Log 74
- Events and meanings 79

F

- Firmware Update 190
- Firmware update
 - Serial port 194
- Frequently Asked Questions 241
- FRU LED 24, 65, 133, 226

G

- Gigabyte Boundary 217

H

- Hot Spare drive 235
- Hot Spare policy 168

I

- Initialization, choices 217
- Internet Browser 35
- Internet connection 243
- IP Address
 - Management port 173

J

- JBOD 217
- JRE/JDK and WebPAM PRO 35

L

- LEDs
 - back of enclosure 229
 - disk status 67
 - Drive carrier 228
 - drive carrier 24, 66, 134
 - field replaceable units 189
 - front panel 24, 65, 226
 - power/activity 67
- Log into WebPAM PRO 68
- Log out of WebPAM PRO 56, 70
- Logical drive
 - Cache policy 166
 - cache settings 219
 - create 54
 - Hot Spare drive 218
 - initialization 217
 - LUN setting 172
 - Maintenance Activity monitor 183
 - Media Patrol 187
 - Operations under 182
 - partition and format 218
 - PDM 185
 - Rebuild manually 184
 - Redundancy Check 186
 - Retry count 167
 - SMART 167
 - Status LED 24
 - synchronize 186
- Logical drive vs. Array 243

M

- Macintosh
 - Serial connection 23
 - Telnet connection 29
- Management port connection 22
- Management port IP address 26
- Management port settings 173

N

Network connections, problems
240

O

Operating Systems, supported 6
OS support for WebPAM PRO 33
Overview 2
Overview of VTrak 2

P

Password, change 85
PATA disk drive
install 13
set jumpers 10
PATA-to-SATA Adapter 13
Ping test, Management port 178
popup messages, meaning 230
Power connection 23
Power LED 24, 65, 133, 226
Power requirements 6
Power supply, replace 196
Power/Activity LED 25

R

Rackmount 8
RAID
Console LUN 181
Level, choices 214
Migration 219
RAID 0 208, 214
RAID 1 209, 214
RAID 10 212, 215
RAID 1E 215
RAID 3 210, 215
RAID 5 211, 215
RAID 50 213, 216
RAID, introduction to 207
Redundant Array of Independent
Disks 207

Replace

cache battery 202
fans 197
RAID controller 205
SEP 204

Reserve Sector, wipe 156
RS-232 connector, pinout 251
RS-232 Serial Connection 22

S

SATA disk drive, install 12
screws, counter-sink 11
SCSI
Activity LEDs 24, 65, 133, 226
cables 16
Channel TID 180
Connection problems 239
daisy chain 20
existing HBA card 241
HBA card, dual channel 15
HBA card, specifications 15
HBA cards, two 18, 21, 241
in-band 181
management 180
multiple VTraks on chain 241
other devices on chain 242
Target ID 20
terminator 17
VTrak, PC, HBA card 18, 19,
20, 21
Serial connection problems 239
SNMP settings 176
Specifications 5
Status Indicators 65, 133
Stripe Block Size, choices 217
Subsystem Management 148

T

Target ID, assign 180
Technical Support 245

Telnet

- Enable 29

- Make connection 30

Telnet settings 174

Terminal Emulation 25

Terminator, SCSI 17

TFTP Server settings 176

Troubleshooting 223

U

Unpack VTrak 7

User

- Add 77

- delete 83

- Rights 83

Utility Server 33

V

VTrak

- beeping 223

- Maintenance procedures 189

- returning for repair 249

- subsystems on SCSI chain

 - 241

- unpack 7

VTrak Setup

- CLU 57

- WebPAM PRO 43

W

Warning

- Electro-Static Discharge 7

- Power supplies 23

Warranty 248

WebPAM PRO

- change password 85

- create logical drive 54

- delete user 83

- event log 74

- install 33

- Internet connection 56

- login 43, 68

- logout 56, 70

- Problem reporting 224

- Regular Connection 43, 68

- Secure Connection 44, 68

- Security Option 38

- setup email alert notification 86

- user rights 83

- username and password 44

WebPAM PRO and JRE/JDK 35

WebPAM vs. WebPAM PRO 243

Free Manuals Download Website

<http://myh66.com>

<http://usermanuals.us>

<http://www.somanuals.com>

<http://www.4manuals.cc>

<http://www.manual-lib.com>

<http://www.404manual.com>

<http://www.luxmanual.com>

<http://aubethermostatmanual.com>

Golf course search by state

<http://golfingnear.com>

Email search by domain

<http://emailbydomain.com>

Auto manuals search

<http://auto.somanuals.com>

TV manuals search

<http://tv.somanuals.com>