

**CI-15**

**Box contents**

- 1 Speaker
- 1 Grille
- 1 Paint mask
- 1 Cutout hole template
- 1 Euroblock connector

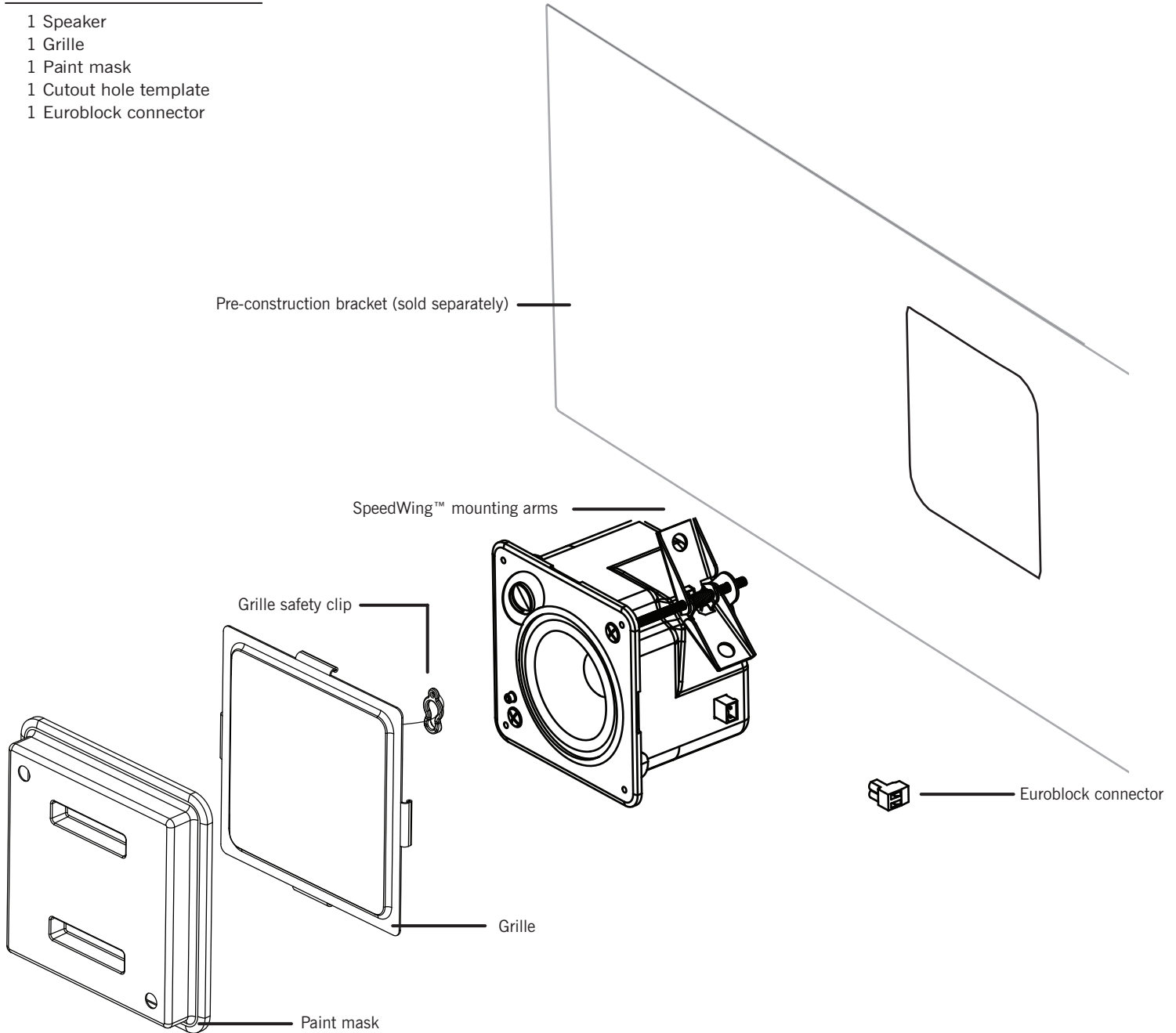

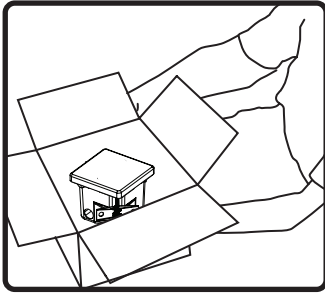

1. Unpack speaker. Leave paint mask in place until after speaker is installed or painting is complete.

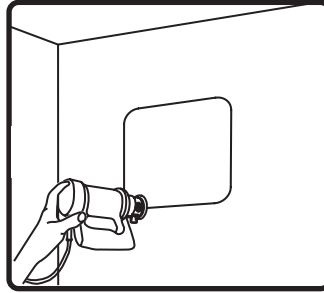

2. Use provided cutout template to mark hole. Use RotoZip or other tool to cut hole in wall. Hole size: 4 in. (102 mm) tall x 4 in. (102 mm) wide.

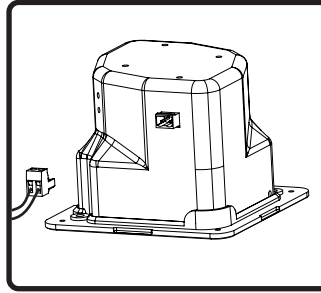

3. Connect Euroblock to speaker wires, and connect to speakers.

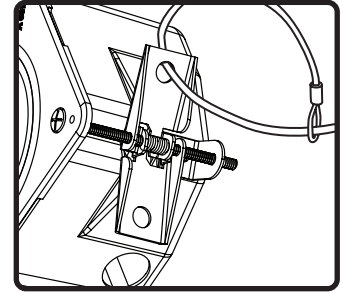

4. If required, attach seismic restraint system to the hole in the metal clamping arm, then to reinforced structure (safety cable not included).

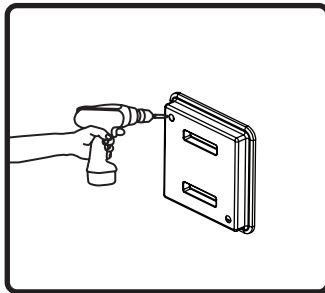

5. Insert speaker in hole. Tighten the two clamping screws. **DO NOT OVERTIGHTEN.**

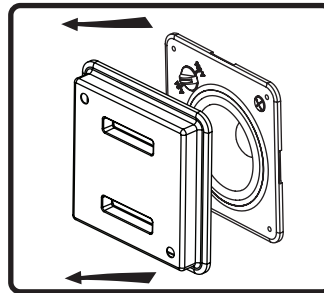

6. Remove paint mask unless painting is required. In that case, follow steps 7-10 when painting is complete.

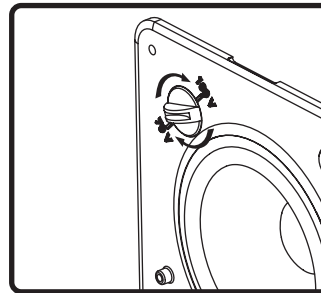

7. Adjust tap switch to proper setting. Switch is preset to the 8-ohm mode.

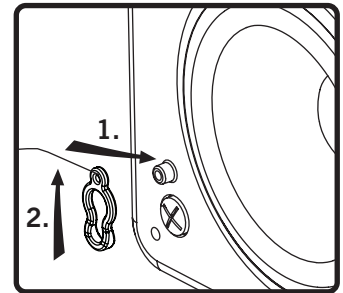

8. Attach grille safety clip by placing the large end of the clip over snap-fit post (1), then sliding clip until small end snaps into place around post (2).

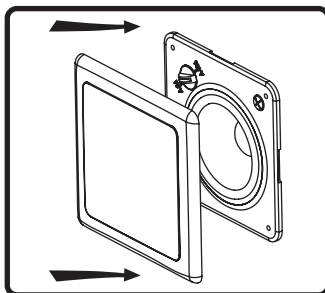

9. Align tabs on snap-fit grille with slots in baffle, gently press grille into place.

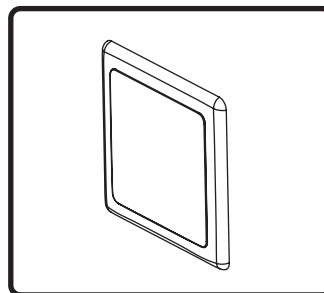

10. Done!

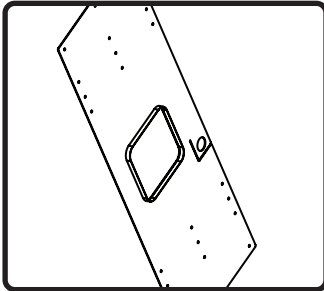

1. Nail or screw bracket to studs.

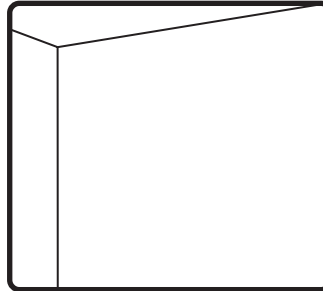

2. Finish installing wall.

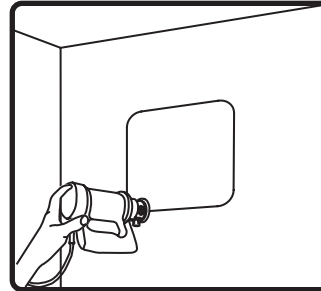

3. Use RotoZip or other tool to cut hole.

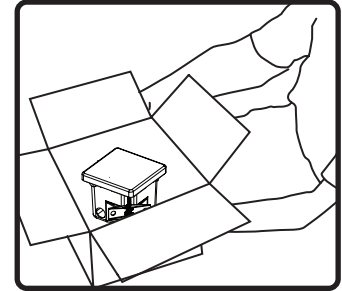

4. Unpack speaker. Leave paint mask in place until after speaker is installed or painting is complete.

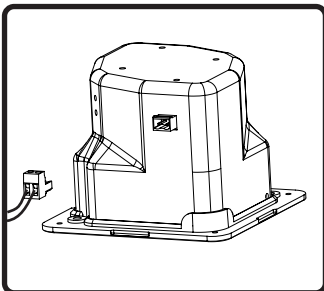

5. Connect Euroblock to speaker wires, and connect to speakers.

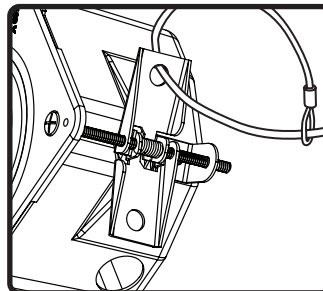

6. If required, attach seismic restraint system to the hole in the metal clamping arm, then to reinforced structure (safety cable not included).

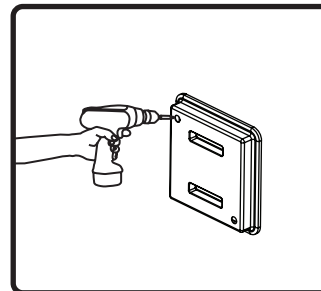

7. Insert speaker in hole. Tighten the two clamping screws. **DO NOT OVERTIGHTEN.**

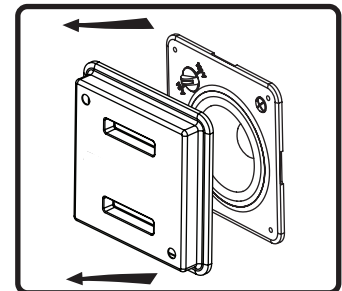

8. Remove paint mask unless painting is required. In that case, follow steps 9-12 when painting is complete.

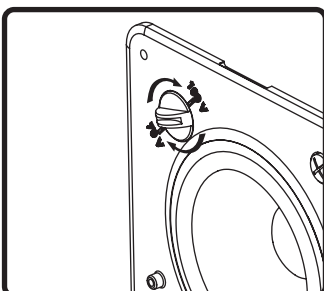

9. Adjust tap switch to proper setting. Switch is preset to the 8-ohm mode.

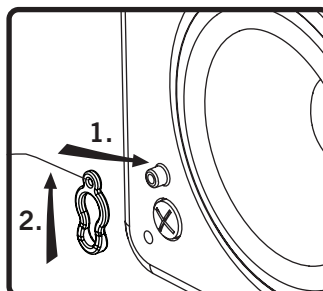

10. Attach grille safety clip by placing the large end of the clip over snap-fit post (1), then sliding clip until small end snaps into place around post (2).

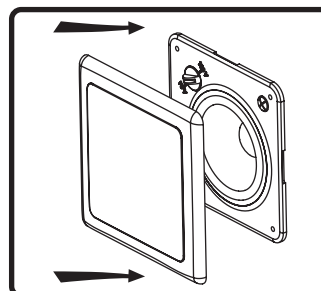

11. Align tabs on snap-fit grille with slots in baffle, gently press grille into place.

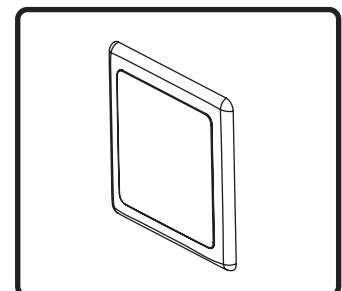

12. Done!

## Free Manuals Download Website

<http://myh66.com>

<http://usermanuals.us>

<http://www.somanuals.com>

<http://www.4manuals.cc>

<http://www.manual-lib.com>

<http://www.404manual.com>

<http://www.luxmanual.com>

<http://aubethermostatmanual.com>

Golf course search by state

<http://golfingnear.com>

Email search by domain

<http://emailbydomain.com>

Auto manuals search

<http://auto.somanuals.com>

TV manuals search

<http://tv.somanuals.com>