



Outdoor Speed Dome IP Camera

ICA-650

User's Manual

Copyright

Copyright (C) 2006 PLANET Technology Corp. All rights reserved.

The products and programs described in this User's Manual are licensed products of PLANET Technology, This User's Manual contains proprietary information protected by copyright, and this User's Manual and all accompanying hardware, software, and documentation are copyrighted.

No part of this User's Manual may be copied, photocopied, reproduced, translated, or reduced to any electronic medium or machine-readable form by any means by electronic or mechanical. Including photocopying, recording, or information storage and retrieval systems, for any purpose other than the purchaser's personal use, and without the prior express written permission of PLANET Technology.

Disclaimer

PLANET Technology does not warrant that the hardware will work properly in all environments and applications, and makes no warranty and representation, either implied or expressed, with respect to the quality, performance, merchantability, or fitness for a particular purpose.

PLANET has made every effort to ensure that this User's Manual is accurate; PLANET disclaims liability for any inaccuracies or omissions that may have occurred.

Information in this User's Manual is subject to change without notice and does not represent a commitment on the part of PLANET. PLANET assumes no responsibility for any inaccuracies that may be contained in this User's Manual. PLANET makes no commitment to update or keep current the information in this User's Manual, and reserves the right to make improvements to this User's Manual and/or to the products described in this User's Manual, at any time without notice.

If you find information in this manual that is incorrect, misleading, or incomplete, we would appreciate your comments and suggestions.

CE mark Warning

The is a class B device, In a domestic environment, this product may cause radio interference, in which case the user may be required to take adequate measures.

WEEE Warning



To avoid the potential effects on the environment and human health as a result of the presence of hazardous substances in electrical and electronic equipment, end users of electrical and electronic equipment should understand the meaning of the crossed-out wheeled bin symbol. Do not dispose of WEEE as unsorted municipal waste and have to collect such WEEE separately.

Trademarks

The PLANET logo is a trademark of PLANET Technology. This documentation may refer to numerous hardware and software products by their trade names. In most, if not all cases, their respective companies claim these designations as trademarks or registered trademarks.

Revision

User's Manual for PLANET Outdoor Speed Dome IP Camera

Model: ICA-650

Rev: 1.0 (Oct. 2006)

Part No. EM-ICA650

Table of Contents

CHAPTER 1 INTRODUCTION	1
Overview	1
Physical Details	3
Package Contents	5
CHAPTER 2 BASIC SETUP	6
System Requirements	6
Installation	7
Setup	8
CHAPTER 3 ADVANCED VIEWING SETUP	10
Introduction	10
Adjusting the Video Image	10
Controlling User Access to the Video Stream	13
Making Video available from the Internet	14
CHAPTER 4 WEB-BASED MANAGEMENT	18
Introduction	18
Connecting to ICA-650	18
Welcome Screen	19
Viewing Area	20
Control Panel Screen	21
Advanced Configuration Area	22
Camera Advanced setting Menu	22
System Screen	23
Camera Screen	25
Network Screen	27
User Screen	30
IP Filter Screen	30
FTP Client Screen	33
SMTP Screen	34
Alarm 1 & Alarm 2 Screen	35
Schedule Screen	35
Motion Detection Screen	36
Time Setting Screen	37
Popup Screen	38
Firmware upgrade Screen	39
Factory Default Screen	40
Reboot	41
ActiveX Control	42
CHAPTER 5 CLIENT UTILITY	47
INSTALLATION	47
HOW TO USE	51
APPENDIX A ALARM I/O CONNECTOR	66
Appendix A Alarm I/O Connector	66
APPENDIX B TROUBLESHOOTING	68
Appendix B Troubleshooting	68
APPENDIX C BANDWIDTH CALCULATION	72
Appendix C: Bandwidth Calculation	72

APPENDIX D SPECIFICATIONS..... 73
Appendix D: Specifications 73

Chapter 1

1

Introduction

This Chapter provides details of the ICA-650's features, components and capabilities.

Overview

The PLANET ICA-650, outdoor speed dome Internet camera offers pan/tilt/zoom control over TCP/IP networks. With the IP-66 protecting cover, ICA-650 can be setup into most of the wicked outdoor environment and keep working properly. The ICA-650 features a 216X zooming (18X optical, 12 digital), auto focus, auto iris, fast, accurate, and continuous 360 panning operations. Plus the 16 presets, 5 camera tour configurations, combining the motion detection, 2 alarm inputs and 2 alarm outputs, these Unparalleled surveillance functions of the ICA-650 are able to satisfy the most demanding surveillance and remote monitoring applications.

The ICA-650 also offers complete secure features; such as IP address filtering and camera movement control, the ICA-650 is perfect for every surveillance environment with these benefits, whenever working at traffic center, shopping malls, railway stations, warehouses, airports, and production facilities. With the Day/Night vision feature, it can provide better video quality and highly security to the monitoring environment.

The ICA-650 is supported by the powerful camera management software CamView for recording, managing and searching video, and integrating alarm control systems. Up to cameras can be organized in the surveillance networks, and save TOC for enterprise users.

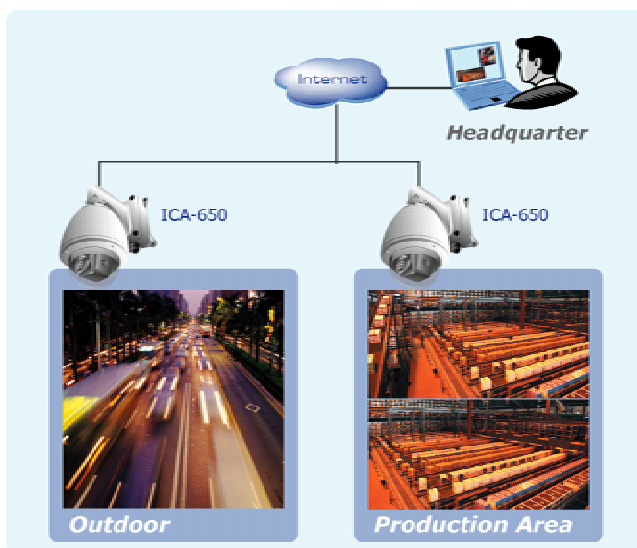

ICA-650 applications

Features

- **Pan, Tilt, and Zooming capability**

ICA-650 is able to perform 360 degree continuous PAN, Tilt (0°~90°) and 216X Zooming (18X optical, 12X digital) adjustment, which brings more vivid images, functionalities and flexibility in surveillance application.

- **Simple to use**

Plug-N-Watch capability to simplify system integration in an existing network environment

- **Meeting most demanded surveillance needs**

With the 16 camera position presets, 5 camera tour configurations, email alerting, FTP upload, motion detection, 2 alarm inputs and 2 alarm outputs, these various features, the ICA-650 can be deployed in many different situations, such as library, train station or factory production line to provide efficient, human-resource reducing, and offers flexibility, affordability, and reliability for the proper surveillance of manufacturing facilities.

- **Outdoor Environment Protection**

The venterproof cover provide a prefect protection to this device. With it's built-in heater, makes this device keep working in a very low temperate environment that down to -30 degree C (-22 degree F).

- **Day/Night Vision**

With the Sony low-lux camera module. ICA-650 can provide the clear Day/Night vision for user to obtain better video quality.

- **Easy configuration**

The network administrator can configure and manage ICA-650 via Windows-based utility CamView or Web Browser interface.

- **Audio Recording**

With the RCA video, and audio output interfaces, the system administrator can record the video/audio locally onto DVR or other video recording equipment.

- **Motion Detection**

Monitors any suspicious movement in specific area, and warn the system administrator via email or pup-up messages.

Internet Features

- ***User-definable administration port number.***

This allows Internet Gateways to use "port mapping" so the ICA-650 and a Web Server can share the same Internet IP address.

- ***DDNS Support***

In order to view video over Internet, user must know the Internet IP address of the gateway used by ICA-650. An easy-to-remember DDNS (Dynamic DNS) name will help you memorize your site more easily.

- ***NTP (Network-Time-Protocol) Support***

NTP allows the ICA-650 to calibrate its internal clock from an Internet Time-Server. This ensures that the time stamp on the recorded video from the ICA-650 will be correct.

- ***PPPoE supported***

Security Features

- **User Authentication**

If desired, the camera access can be restricted to known users. Users will have to enter their username and password before being able to view the video stream. Up to 10 users can be entered.

- **IP filter**

The camera access not only can be restricted by username/password, but also can be limited by the IP range to bring users more security.

Physical Details



1. Alarm cable

The Network Camera provides 8 pins cable to connect with external alarms.

Color definition for installing alarms:

Pin	Color	Function
1	Black	Alarm Output #2 (NO)
2	Brown	Alarm Output #2 (COM). Max 24VDC, 1A
3	Red	Alarm Output #1 (NO)
4	Orange	Alarm Output #1 (COM)
5	Yellow	Alarm Output #1 (NC). Max 24VDC, 1A
6	Green	Alarm Input #2 (A). Max 24VDC, 12mA
7	Blue	Alarm Input #1/2 (K).
8	Purple	Alarm Input #1 (A). Max 24VDC, 12mA.

2. LAN Cable

LAN cable is a 10Base-T Ethernet or 100Base-TX Fast Ethernet cabling. The Ethernet port built NWay protocol can detect or negotiate the transmission speed of the network automatically. Provided Category 5 “straight through” cable to connect the Network Camera to a 100Mbps Fast Ethernet network switch or hub.

3. Video Output Cable

User can connect the ICA-650 video output to their TV monitor or a video recorder to output the monitor screen.

4. Audio Input Cable

The Network Camera provides 1-channel audio input to connect with external microphone. User can monitor not only images but sounds.

5. AC Power connector

AC power connector, it is a mail located on the Network Camera’s back panel. Note that power supply need user to purchase additionally according to local electrical specification. In order to prevent the improper power adapter may damage the unit and result in danger.

The Network Camera also provides video output to connect the Network Camera with a TV monitor or VCR.

Package Contents

The following items should be included: If any of these items are damaged or missing, please contact your dealer immediately.

- Planet ICA-650 Outdoor Speed Dome IP Camera x 1 (with Ethernet, Video, Audio, Alarm cable and power cord integrated)
- User manual CD x 1
- Quick Installation Guide x 1
- Wall mount kit x 1

Chapter 2

2

Basic Setup

This Chapter provides details of installing and configuring the ICA-650.

System Requirements

- To use the LAN interface, a standard 10/100Base-TX hub or switch and network cable is required.
- Minimum System Requirement :

System Hardware	Microsoft Internet Explorer 5.0 or later Windows ME, 2000, XP, or 2003 1-4 cameras surveillance application <ul style="list-style-type: none">• CPU: Pentium 4, 1.3G MHz or above• Memory Size: 256 MB or above• VGA card resolution: 1024 x 768 or above 4 or more cameras surveillance application <ul style="list-style-type: none">• CPU: Pentium 4, 1.7G MHz or above• Memory Size: 512 MB or above• VGA card resolution: 1024 x 768 or above
------------------------	--

Hint

Note: The listed information is minimum system requirements only. Actual requirement will vary depending on the nature of your environment.

Installation

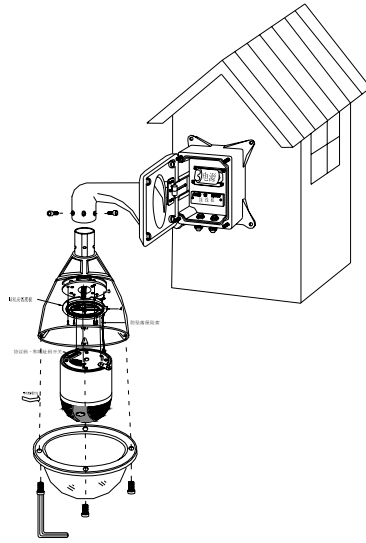

Use the rubber ring, nut, and screw to mount the power box and outdoor speed dome IP cam to the wall.

Note: You need to choose correct screws to fix the outdoor speed dome IP cam to the wall. Other types of screws need to buy locally.

Setup

Initial setup can be performed either from the web browser or using the supplied Windows-based camera utilities. This program can locate the ICA-650 even if its IP address is invalid for your network. You can then configure the ICA-650 with appropriate TCP/IP settings for your LAN.

Subsequent administration can be performed with your Web browser, as explained in *Chapter 3 - Web-based Administration*.

Setup Procedure

Before setup operations

The ICA-650 provides GUI (Web based, Graphical User Interface) for machine management and maintenance.

To start ICA-650 web configuration, the requirement of the web browser should be:
Microsoft Internet Explorer 5.0 or higher with Java support

Note

Current firmware supports Microsoft Internet Explorer, the Netscape Navigator support is planned in the future firmware release

Default LAN interface IP address of ICA-650 is **192.168.0.20**. You may now open your web browser, and insert `http://192.168.0.20` in the address bar of your web browser to logon ICA-650 web configuration page.

ICA-650 will prompt for User Name and Password, please enter: **admin** as username to continue machine Web Management.



Or you may execute **IPedit** to discover/edit IP address of ICA-650.

Procedures of IPedit utility.

- Please find the **IPeditV3.1.exe** in the **Utility** folder on user's manual CD.
- Double-click the **IPeditV3.1.exe** and the following screen should be prompt on your computer.

- Choose the destination camera for IP address and device name modifications.

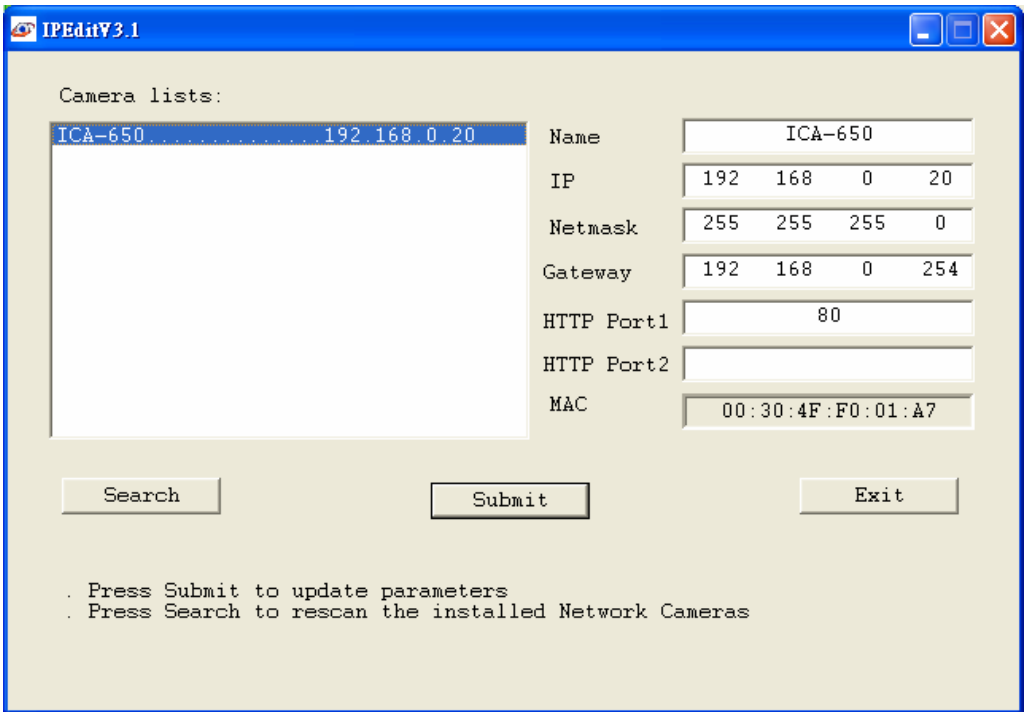

- After modifications, you may now connect the camera via web browser.

Chapter 3

3

Advanced Viewing Setup

This Chapter provides information about the optional settings and features for viewing video via the ICA-650. This Chapter is for Administrators only.

Introduction

After finishing the network setup, the ICA-650 can immediately be used by all users on your LAN.

This chapter describes some additional settings and options for viewing live Video:

- Adjusting the video image
- Controlling user access to the live video stream
- Making video available from the Internet

Adjusting the Video Image

If necessary, the ICA-650 Administrator can adjust the Video image. Settings are provided for:

- **Image size** - Select the desired size. The larger sizes require greater bandwidth.
- **Image quality** - This determines the degree of compression applied to the Video stream. Higher quality requires greater bandwidth.
- **Saturation, Sharpness, Contrast, Hue adjustment** -

To Adjust the Video Image:

1. Connect to the Web-based interface of the ICA-650.
2. On the *Administration* menu, select *Image*. You will see a screen like the example below.

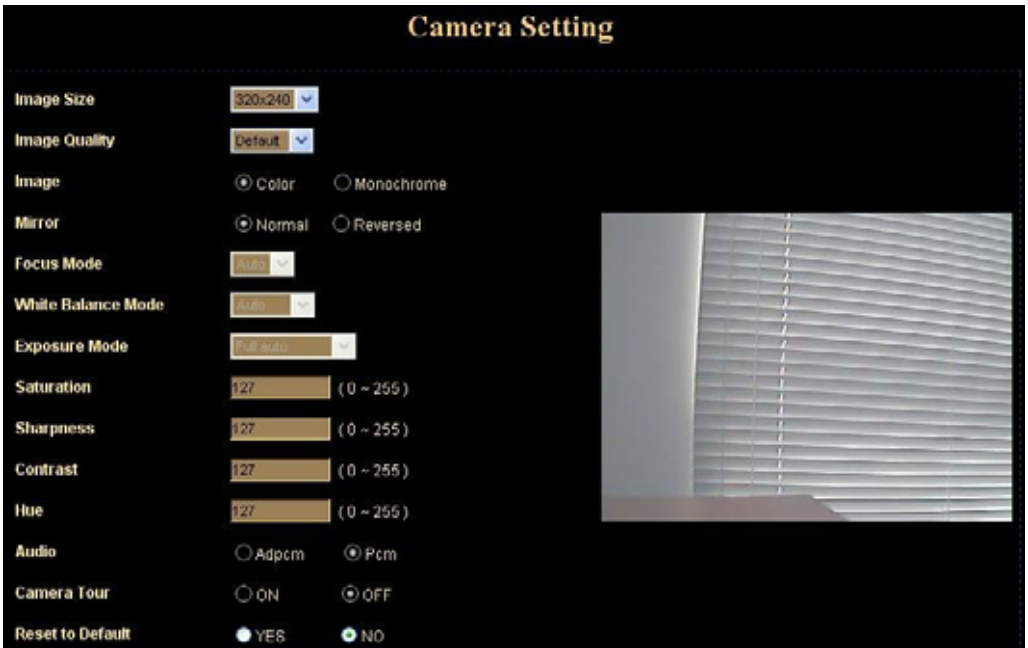

Camera setting

3. Make the required adjustments, as explained below, and save your changes.

Camera Settings	
Image Size	Select the desired video resolution. The default resolution is set to 320*240. Available resolution: • 176x144 • 320x240 • 352x288 • 640x480
Image Quality	Select the desired image quality. The default Image Quality is set to Standard. Available selection: <ul style="list-style-type: none"> • Clarity: Video is better but frame rate may be slower • Fluency: Video is not as good as Clarity but frame rate may be higher • Standard: System default value. Note: Higher image quality requires more bandwidth.
Saturation, Sharpness, Contrast, Hue	Image quality adjustment, the parameter ranges from 0 to 255
Options	
Camera tour	Enable the check box if you want the time to be displayed on the Video image.
Reset to default	If this option is enabled, all the settings in this page will be reset to factory default values.

 Note

Please check the appendix B for more information on the image adjustment.

Controlling User Access to the Video Stream

By default, only system administrators can connect to the ICA-650 and view live Video. If desired, you may apply the access privileges to known users, by requiring each user to login to the ICA-650 with their individual username and password.

To enable this feature:

1. Connect to the Web-based interface of the ICA-650. (Please check related chapters for details.)
2. In machine *Administration* menu, select *User*.
3. You may add up to 10 users in machine database, choose the user number, and enter the name, password and access right for each user.

User ID	Username	Password	Access right
Administrator	admin		Administrator
User 1			Administrator
User 2			Administrator
User 3			Administrator
User 4			Administrator
User 5			Administrator
User 6			Administrator
User 7			Administrator
User 8			Administrator
User 9			Administrator
User 10			Administrator

SAVE CANCEL

User Setting Screen

Operation

- When each user connects, they will be prompted for their username and password. They must enter the name and password defined on the User screen above.
- The camera system administrator can have full access/system modification privileges; the user only has viewing privilege.

Making Video available from the Internet

If your LAN is connected to the Internet, typically by a Broadband Gateway/Router and Broadband modem, you can make the ICA-650 available via the Internet.

ICA-650 Setup

The ICA-650 configuration does NOT have to be changed, unless:

- You wish to change the port number from the default value (1024).
- You wish to use the DDNS (Dynamic DNS) feature of the ICA-650.

Second HTTP Port Configuration

Normally, HTTP (Web) connections use port 80. Since the ICA-650 uses HTTP, but port 80 is likely to be used by a Web Server, you can use a different port for the ICA-650. This port is called the "HTTP Port2". (The first port is port 80.)

The HTTP port2 is disabled in default settings. If you prefer to use a different port number than port 80, you can specify the port number on the ICA-650's **Network** screen, as shown below.

The screenshot shows the 'Network Setting' interface. At the top, there are radio buttons for 'DHCP' set to 'OFF'. Below this are several text input fields: 'IP address' (192.168.0.20), 'Subnet mask' (255.255.255.0), 'Default gateway' (192.168.0.254), 'MAC address' (00:30:4F:36:CF:C5), 'Primary DNS' (168.95.1.1), and 'Secondary DNS' (0.0.0.0). There are also two more text input fields for 'HTTP Port 1' (80) and 'HTTP Port 2' (30000). At the bottom, there are buttons for 'DDNS Setting', 'PPPoE Setting', 'SAVE', and 'CANCEL'.

Network Screen

The *Network* screen is part of the Web-based Administration interface. See **Web-based Management** for further details on using this interface.

Hint

Viewers need to know this port number in order to connect and view live Video, so the current communication port number has to be informed to the remote users to connect to.

DDNS (Dynamic DNS)

Many Internet connections use a "Dynamic IP address", where the Internet IP address is allocated whenever the Internet connection is established.

This means that other Internet users don't know the IP address, so can't establish a connection.

DDNS is designed to solve this problem, by allowing users to connect to your LAN using a domain name, rather than an IP address.

To use DDNS:

1. Register for the DDNS service with a supported DDNS service provider. You can then apply for, and be allocated, a Domain Name.
2. Enter and save the correct DDNS settings on the **DDNS Setting** screen in the **Network** setting menu.
3. Operation is then automatic:
 - The ICA-650 will then automatically contact the DDNS server whenever it detects that the Internet IP address has changed, and inform the DDNS server of the new IP address.
 - Internet users can then connect to your LAN using the Domain Name allocated by the DDNS service provider.
 - Limitation: if the ICA-650 is installed with private IP address behind the NAT router, please find and enable the DDNS feature on the router. This can prevent the remote users not able to connect to the camera.
 - Current supported DDNS service provider: www.dyndns.org , www.no-ip.com

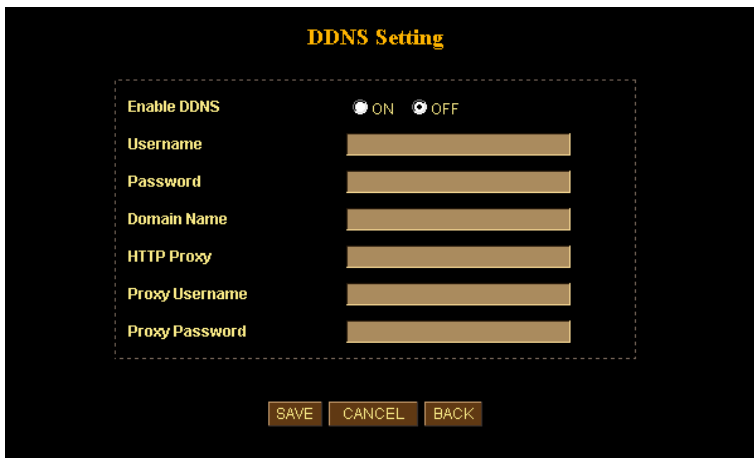

DDNS Setting Screen

Router/Gateway Setup for remote viewing

Your Router or Gateway must be configured to pass incoming TCP (HTTP) connections (from remote viewers) to the ICA-650. The Router/Gateway uses the *Port Number* to determine which incoming connections are intended for the ICA-650.

This feature is normally called *Port Forwarding* or *Virtual Servers* in the router. The Port Forwarding/Virtual Server entry tells the Router/Gateway that incoming TCP connections should be passed to the ICA-650. If necessary, check the user manual for your Router/Gateway for further details.

Hint

The "Port" for the *Port Forwarding / Virtual Server* entry above is the "Second Port" number specified on the *Network* screen of the ICA-650.

Viewing via the Internet

Clients (viewers) will need a broadband connection; dial-up connections are NOT recommended.

Using your Web Browser

If using your Web browser, you need to know the address of the camera (either the Internet IP address or the Domain name) and the correct communication port number.

Enter the address of the ICA-650, and its port number, in the *Address (or Location)* field of your Browser.

Example - IP address:

HTTP://203.70.249.52:1024

Where the Router/Gateway's Internet IP address is 203.70.212.52 and the "**HTTP Port2**" number on the ICA-650 is 1024.

Example - Domain Name:

HTTP://ipcam.dyndns.org:1024

Where the Router/Gateway's Domain name is ipcam.dyndns.org and the "**HTTP Port2**" number on the ICA-650 is 1024.

Using the Windows Viewing/Recording Utility

If using the CamView Utility, the details of the ICA-650 must be entered on the *Internet* tab of the *Add Camera* screen.

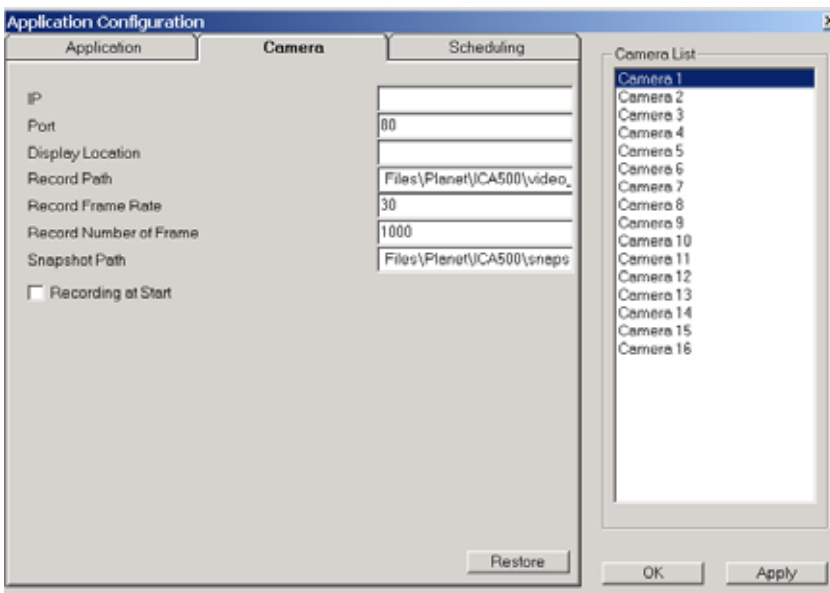

CamView - Add Camera Screen

You can then select the camera in the *Cameras* list on the main screen, and click **OK** to establish a connection and view live video.

Please check *respective chapter* for further details of viewing Video using either the Windows Viewing/Recording utility or Web Browser.

Chapter 4

4

Web-based Management

This Chapter provides Setup details of the ICA-650's Web-based Interface. This Chapter is for Administrators only.

Introduction

The ICA-650 can be configured using your Web Browser. The ICA-650 must have an IP address, which is compatible with your PC.

Connecting to ICA-650

- If you have run the CamView utility, the screen provided a button . Clicking this button will immediately connect to the ICA-650 to do web settings.
- If using only Web Browser, use the following procedure to establish a connection from your PC to the ICA-650:
- Once connected, you can add the ICA-650 to your Browser's *Favorites* or *Bookmarks*.

Connecting using your Web Browser

1. Start your web browser.
2. In the *Address* box, enter "HTTP://" and the IP Address of the ICA-650, as in this example, which uses the ICA-650's default IP Address:
HTTP://192.168.0.20
3. Default **username/password** for machine login: **admin/** <no password>
4. If the *Administrator ID* and *Password* have been assigned, enter the name and password you assigned.



Welcome Screen

When you connect, the camera *Home* screen will be displayed.



Camera Home Screen

The Home screen can be divided into three areas:

- **Viewing Area** - Images from the ICA-650
- **Control Panel Area** – ICA-650 Camera Manipulation and image quality control
- **Advanced Configuration area** - only available for administrator. Camera administrator can have full configuration in this menu.

These options are explained in the following sections.

Viewing Area

This screen is displayed when you log in machine



Viewing Area Screen

- The ICA-650 web page requires ActiveX control to display the video content. The ActiveX control must be downloaded from the camera and installed on your PC.
- The security settings on the Internet Explorer must allow the ActiveX plug in to be functional.
- To use the ICA-650, please execute your Internet Explorer and browse to "Tools" → "Internet Options..." → "Security" → "Custom Level..." and change the settings as follows:
 - *Download the signed ActiveX controls*
 - *Download the unsigned ActiveX controls*
 - Initialize and script the ActiveX controls not masked as safe to **Prompt**
- After the ActiveX installation completed, video content will start playing automatically. Due to various network conditions, the video display may be a delay of a few seconds while the video stream is buffered.

Control Panel Screen

When you connect, the camera **control panel** screen will be displayed.

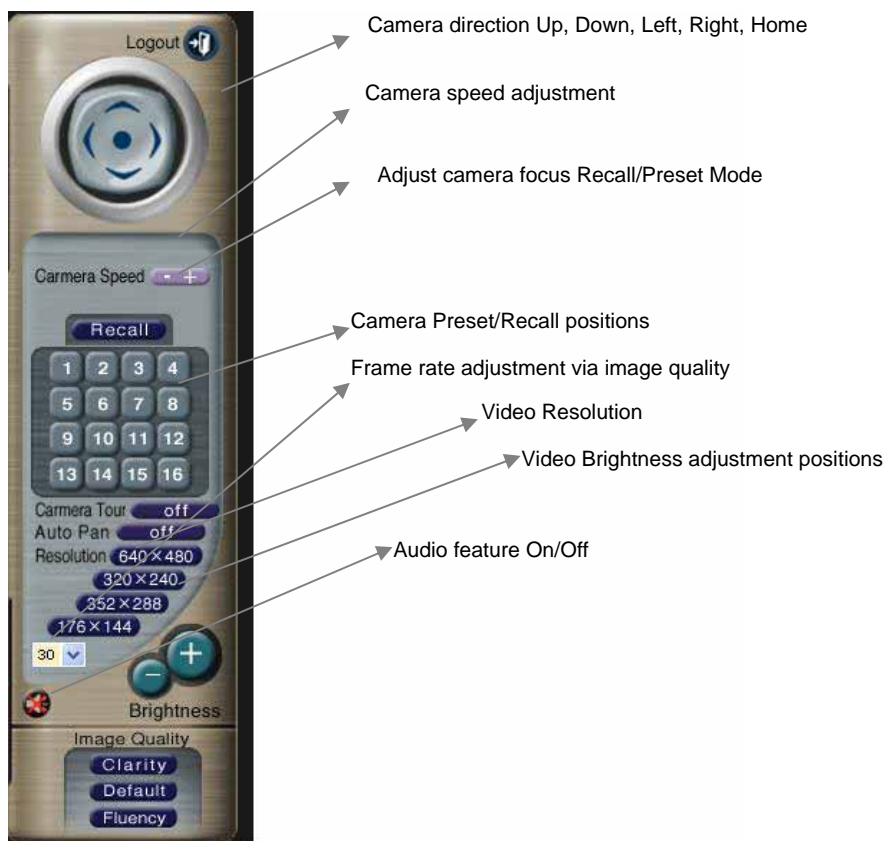

Camera Control Panel Screen

The function on the control panel can be shown below:

Button	Definition
Camera Direction	Control camera up/down/left/right and home position
Camera Speed	Increase/decrease the camera Pan/Tilt speed
Recall/Preset mode	Preset: set up camera fixed locations before operation Recall: Set camera position to preset location
Video Resolution	Adjust Video resolution The ICA-650 provides 4 resolutions: 640x480, 352x288, 320x240, 176x144 For NTSC camera: 320x240 is suitable For PAL camera: 352x288 and 176x144 are suitable However, all resolution are available for NTSC and PAL camera
Preset or Recall positions	Preset or Recall camera 1~16 location(s) Ex. If you press 5, then the camera will move to preset location 5.
Video Brightness	Adjust Camera video brightness

Adjustment	
Image quality	Adjust image quality. Clarity: Video is better but frame rate may be slower Fluency: Video is not as good as Clarity but frame rate may be higher Standard: System default value
Frame rate adjustment directly	Adjust video frame rate via giving a number directly. 1, 5, 10, 15, 20, 25, 30
Audio On/Off	Turn on/off audio output function. Note: The Microphone is located on the rear panel. You need to position the MIC hole face to the audio source to have better audio quality.

Advanced Configuration Area

The **Advanced Configuration** menu offers more features and camera control privileges to meet various application demands.



Advanced Configuration Screen

The ICA-650 Advanced Configuration page divided into three sub-menus:

- **Camera Advanced Setting**
- **Camera Trigger Setting**
- **Screen capture Setting**

Respective menu descriptions are illustrated in the following sections.

Camera Advanced setting Menu

Clicking on **Setting** on the menu provides privileges to all the settings for the ICA-650.





The **Advanced Setting** menu is divided into 2 categories: **Basic** and **Application settings**:

The Basic menu provides essential configurations of the ICA-650, and the Application menu is provided for various applications.

Basic Setting

Parameters in the Basic configuration menu provide machine adjustment; the available configurations are listed below:

Icon	Menu Link	Definition
	System	Define Frame Rate, Turn on/off "Remote camera control", and view system log file.

	Camera	Adjust camera parameters and set camera tour
	Network	Configure Network setting such as DHCP On/Off, DDNS and PPPoE
	User	Setup user name, password and login privilege
	IP Filter	Setup legal IP address of user login (This function should be used with function "User" respectively)

System Screen

After entering machine Home screen, click on the **System** menu, you will see a screen like the example below.

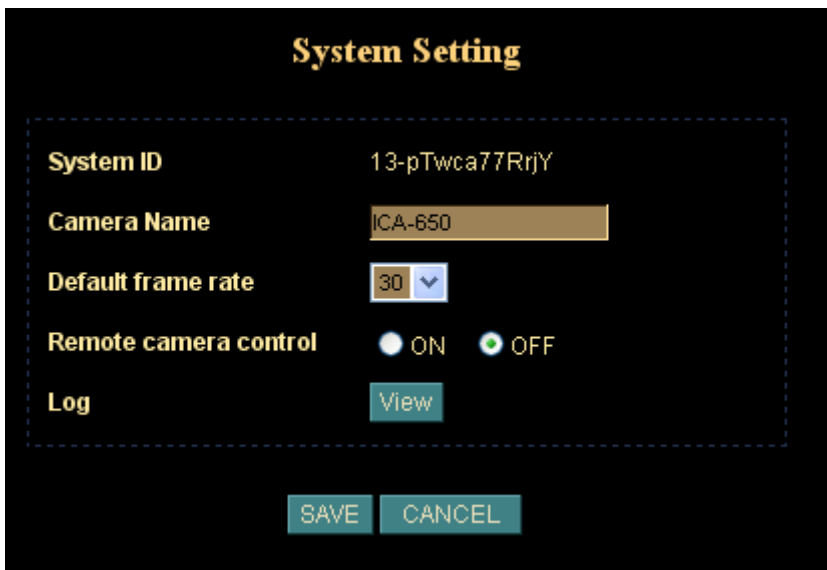

System Screen

Data - System Screen

System Settings	
Serial Number	Product serial number
Camera Name	This displays the name for the ICA-650; camera name is useful while multiple unit installation.
Default frame rate	The default frame rate in ICA-650 is 30fps, the video frame rate can be adjusted in this menu or on the Control panel menu
Remote camera control:	Enable or disable remote control feature in ICA-650

Log

Administrator can check the log information in machine, including the Main Info, Appended Info, Operator IP, Operator MAC, and Time.

Select the **“View”** button to check the log file.

Camera Screen

This screen is displayed when the *Camera* menu option is clicked.

Note: please adjust carefully to have proper machine configurations.

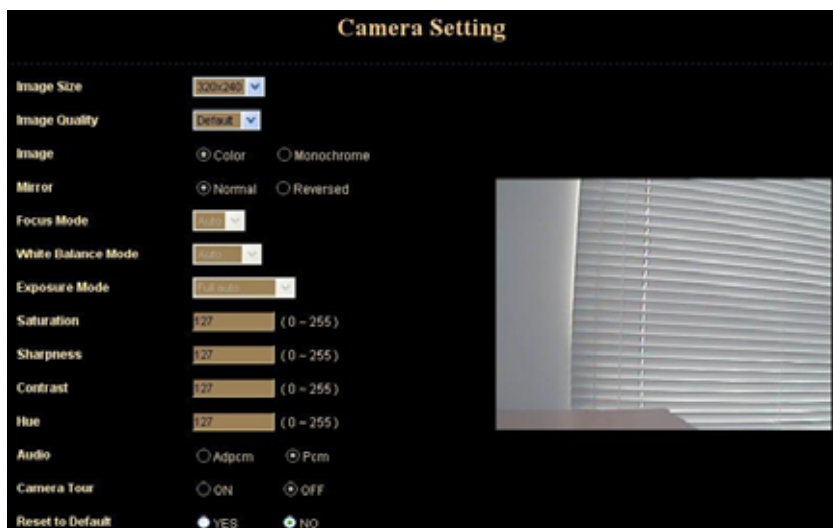

Camera Screen

Data - Camera Screen

Camera Settings	
Image Size	<p>Display resolution selection, supported resolution in ICA-650:</p> <ul style="list-style-type: none"> • 176x144 • 352x288 • 320x240 • 640x480 <p>Please check the available network upload bandwidth and carefully select the proper video resolution.</p>
Image Quality	<p>Video display quality selection in ICA-650:</p> <ul style="list-style-type: none"> • Clarity: Video is better but frame rate may be slower • Fluency: Video is not as good as Clarity but higher frame rate • Standard: System default value <p>Note: The value on the list box displays the current setting all the modifications will not take effects until it is saved in this menu.</p>
Saturation, Sharpness, Contrast, Hue	<p>Key in respective value for image adjustment. It is not required to adjust this value when the image is vivid.</p>

Camera Tour	To use the camera tour function, user must preset some camera positions first. Select the “ SET Tour ” button to enter the Camera Tour setting page.
Reset to Default	Restore the values of these pages to factory default value.

Camera Tour

In the Camera Tour page, choose the one tour name. Fill the dwelling time and tour sequence by preset points, can repeat above procedure to set more camera tours.

Camera Tour Screen

Data – Camera Tour Screen

Camera Tour Settings	
Tour Name	Choose the one tour name from A to E
Dwelling Time	The time period between every tour point.
Sequence	16 points can be assigned.
Enable	Enable camera tour group should be activated

Hint

To use the camera tour function, user must preset some camera positions first. The maximum number of preset points is 16.

In the Camera Tour page, choose the one tour name from A to E. Fill the dwelling time and tour sequence by preset points, and then save these setting. You can repeat above procedure to set more camera tours.

Network Screen

This screen is displayed configure Network setting such as IP address, DHCP, DDNS and PPPoE.

Network Setting

DHCP ON OFF

IP address

Subnet mask

Default gateway

MAC address

Primary DNS

Secondary DNS

HTTP Port 1

HTTP Port 2

IP Finder Enable Disable

DDNS

PPPoE

Network screen

Data - Network Screen

Network Settings	
DHCP	Enable or disable DHCP client in ICA-650
IP address, Subnet mask, Default gateway, Primary DNS, Secondary DNS	<p>This parameter allows users to setup the IP address assigned by ISP. Your ISP should provide all the information required for Internet access.</p> <p>Note: User need to reboot the Network Camera to make this setting to take effect.</p>
HTTP Port 1, HTTP Port 2	Users could assign the port number of http protocol, and the WAN users should follow the port number to login.

IP Edit

User can use IP Edit software program to find Internet Cameras or edit related parameters on the LAN. Disable this option to restrict the modification of related parameters by IP Edit software

DDNS Setting

The DDNS is designed to solve this problem, by allowing users to connect to your LAN using a domain name, rather than an IP address.

DDNS Setting

Enable DDNS ON OFF

Username

Password

Domain Name

HTTP Proxy

Proxy Username

Proxy Password

SAVE CANCEL BACK

DDNS screen

DDNS Settings

Enable DDNS	Enable or disable DDNS function.
Username, Password	Enter the Username/Password for your DDNS account.
Domain Name	Enter the host name, which DDNS service provider assigned.
HTTP Proxy, Proxy Username, Proxy Password	Enter the parameter, which DDNS service provider assigned.

PPPoE Setting

If the ISP demands PPPoE connection for Internet access, please select PPPoE as connection type, and insert the username/password by your ISP to connect you to the Internet.

PPPoE Setting

Dial On Power Up	<input type="checkbox"/>
User	<input type="text"/>
Password	<input type="text"/>
Send mail after dialed.	<input type="checkbox"/>
Mail server	<input type="text"/>
Username	<input type="text"/>
Password	<input type="checkbox"/> Check Password <input type="text"/>
Sender email	<input type="text"/>
Receiver email	<input type="text"/>
Subject	IP Camera PPP Dialed

PPPoE screen

① Hint

Please consult your ISP personnel to obtain proper PPPoE/IP address related information, and input carefully. If Internet connection cannot be established, please check the physical connection or contact the ISP service staff for support information.

User Screen

This User setting can set up to 10 different usernames and passwords. Every one set of username and password can be acted as an Administrator or just a general user.

User ID	Username	Password	Access right
Administrator	admin		Administrator
User 1			Administrator
User 2			Administrator
User 3			Administrator
User 4			Administrator
User 5			Administrator
User 6			Administrator
User 7			Administrator
User 8			Administrator
User 9			Administrator
User 10			Administrator

SAVE CANCEL

User Screen

IP Filter Screen

The IP filter can set 10 different user's IP address, which are allowing enter or disregarding by the Network Camera. Please configure "User" before "IP Filter". Each "User" username and password matches with one "IP Filter" user.

User ID	IP From	To	Policy
User 1			Allow
User 2			Allow
User 3			Allow
User 4			Allow
User 5			Allow
User 6			Allow
User 7			Allow
User 8			Allow
User 9			Allow
User 10			Allow

SAVE CANCEL

IP Filter Screen

Function Notification

The page of user setting is very closely related to the IP filter settings. While the administrators are setting these two pages, they should notice that login authorities are not only based on the login names but also the range of IP addresses. Administrators could reject login users according to both login names and IP addresses. The administrator accounts have the supreme power; system will always accept no matter how IP filter setting was set.

Several examples to explain the logical relations between login names and the IP policy:

-1-

User page: Login name 1= 12345, Password=12345, Access Authority=any

IP filter page: Default Policy=Allow, login name1 comes from 192.168.0.A to B=Allow

Result: when the remote users login in the name of 12345 and come from the IP addresses 192.168.0.A to 192.168.0.B, login will be successful. If these users did not come from the IP addresses A to B, login access will be rejected.

-2-

User page: Login name 1= 12345, Password=12345, Access Authority=any

IP filter page: Default Policy=Allow, login name1 comes from 192.168.0.A to B=Deny

Result: when the remote users login in the name of 12345 and come from the IP addresses 192.168.0.A to 192.168.0.B, login will be denied. If these users did not come from the IP addresses A to B, login access will be successful.

-3-



(User page: Login name 1= 12345, Password=12345, Access Authority=any









IP filter page: Default Policy=Deny, login name1 comes from 192.168.0.A to B=Deny/Allow

Result: login of all the login names will be rejected except the login name "admin".

Application Setting

Parameters in the Basic configuration menu provide machine adjustment; the available configurations are listed below:

Icon	Menu Link	Definition
	FTP Client	Setup IVS-100 as a FTP client and configure Server site in order to upload images to server
	SMTP	Setup Mail transferring service configuration
	Alarm 1	Setup Alarm Output 1 action via manual or event

	Alarm 2	Setup Alarm Output 2 action via manual or event
	Schedule	Schedule Motion Detection to send email or upload images.
	Motion Detection	Setup motion detection area and sensor sensitivity
	Time Setting	Setup the Network Camera time configuration
	Popup	Setup event message while motion or sensors has been activated
	Firmware Upgrade	Product firmware upgrade
	Factory Default	Pre-default the Network Camera factory default setting
	Reboot	Reboot this device

FTP Client Screen

FTP Client Screen

FTP Client Settings

FTP server name	IP address or domain name of the destination FTP server
Username, Password	Please input the Username/Password for the FTP server
Remote path	Please input the path to the destination.
Image file name	Please input the basic file name you want to assign to the images when sending to the FTP server.
Suffix	Select the suffix to add to the file name. <ul style="list-style-type: none"> - None: No suffix is added. The basic file name is assigned to the image to be sent to the FTP server. - Date/Time: The date/time suffix is added to the file name. The - Sequence number: A consecutive number is added to the basic file name.
Sequence No. clear	Enable or disable clear sequence number
Mode	Motion Detection / Sensor1 / Sensor2 / Periodical sending / Off Please select send a captured image mode.

SMTP Screen

This screen is displayed when the *SMTP* menu option is clicked.

SMTP (Simple Mail Transfer Protocol) is a protocol for sending e-mail messages between servers. The mail server address must be filled in this field.

SMTP Setting

SMTP server name: planet.com.tw

Username: alan

Password: Check Password *****

Sender's Mail Box: alan@planet.com.tw

Receiver's Mail Box: alan@planet.com.tw

Subject: ICA500 motion email

Motion Detection

Mode: Sensor1 Periodical sending OFF

Sensor2

SAVE CANCEL

SMTP Screen

Network Settings

SMTP server name	Enter the address of SMTP server used to send the mail. Please ensure the server is using SMTP protocol and able to relay mails for you. Some SMTP server may require authentication. Please enable the "Check Password", and enter the Account Password fields below for authentication.
Username, Password	Enter the Username/Password for your SMTP account.
Sender's Mail Box	Enter the sender e-mail address in the field. This field must be entered with a valid e-mail format.
Receiver's Mail Box	Enter the receiver e-mail address in the field.
Subject	Enter the subject of outgoing mail.
Mode	Motion Detection / Sensor1 / Sensor2 / Periodical sending / Off Please select send a captured image mode.

Alarm 1 & Alarm 2 Screen

This screen is displayed when the *Alarm 1/Alarm 2* menu option is clicked. You can select *Manual* or *Event* for the Alarm mode.

Duration:

Set up the alarm duration. "0" means the alarm working always.

Alarm1 Screen

The screenshot shows the 'Alarm out 1' configuration screen. It features a 'Duration' field set to '0' seconds, with a note that '0' means static. The 'Mode' section has three options: 'Manual' (selected with a radio button), 'Motion Detection' (unchecked checkbox), 'Sensor 1' (unchecked checkbox), and 'Sensor 2' (unchecked checkbox). At the bottom, there are 'SAVE' and 'CANCEL' buttons.

Schedule Screen

The Schedule can enable motion detection in an arranged period in order to avoid unnecessary images transmitting and catch the desired images.

The screenshot shows the 'Schedule Setting' screen with a table of schedule configurations. The table has columns for 'Schedule No.', 'Schedule Date.', 'Start Time.', 'End Time.', and 'Event.'. Schedule No. 0 is selected, showing motion detection enabled for all days of the week from 00:00 to 11:00. Schedules 1 through 5 are currently disabled.

Schedule No.	Schedule Date.	Start Time.	End Time.	Event.
No. 0	<input checked="" type="checkbox"/> Mon <input checked="" type="checkbox"/> Tue <input checked="" type="checkbox"/> Wed <input checked="" type="checkbox"/> Thu <input checked="" type="checkbox"/> Fri <input checked="" type="checkbox"/> Sat <input checked="" type="checkbox"/> Sun	00:00	11:00	Start Motion Detection
No. 1	<input type="checkbox"/> Mon <input type="checkbox"/> Tue <input type="checkbox"/> Wed <input type="checkbox"/> Thu <input type="checkbox"/> Fri <input type="checkbox"/> Sat <input type="checkbox"/> Sun	00:00	00:00	
No. 2	<input type="checkbox"/> Mon <input type="checkbox"/> Tue <input type="checkbox"/> Wed <input type="checkbox"/> Thu <input type="checkbox"/> Fri <input type="checkbox"/> Sat <input type="checkbox"/> Sun	00:00	00:00	
No. 3	<input type="checkbox"/> Mon <input type="checkbox"/> Tue <input type="checkbox"/> Wed <input type="checkbox"/> Thu <input type="checkbox"/> Fri <input type="checkbox"/> Sat <input type="checkbox"/> Sun	00:00	00:00	
No. 4	<input type="checkbox"/> Mon <input type="checkbox"/> Tue <input type="checkbox"/> Wed <input type="checkbox"/> Thu <input type="checkbox"/> Fri <input type="checkbox"/> Sat <input type="checkbox"/> Sun	00:00	00:00	
No. 5	<input type="checkbox"/> Mon <input type="checkbox"/> Tue <input type="checkbox"/> Wed <input type="checkbox"/> Thu <input type="checkbox"/> Fri <input type="checkbox"/> Sat <input type="checkbox"/> Sun	00:00	00:00	

Schedule Setting Screen

Motion Detection Screen

This screen is displayed when the Motion Detection menu option is clicked. You can Enable/Disable function and adjust the sensitivity level

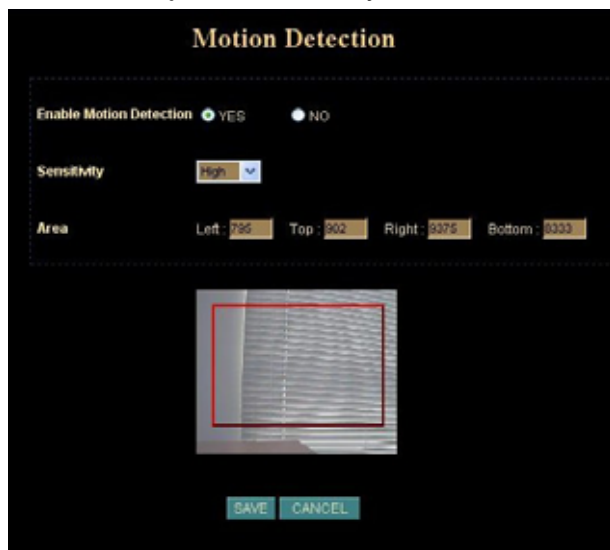

Motion Detection Screen

Motion Detection Settings

Enable Motion Detection

Enable or disable Motion Detection function in ICA-650

Sensitivity

Select the desired option to suit your environment. If covering a large area, you usually need higher sensitivity, since a moving object will take only a small portion of the image.

Area

Use the adjust the determine which areas of the image are examined for motion

Time Setting Screen

This screen is displayed when the Time Setting menu option is clicked.

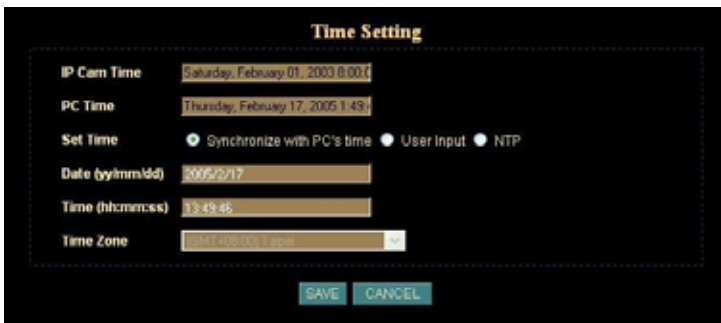

Time Screen

Time Settings

IP Cam Time	Provides settings of adjusting the camera's time
PC Time	This is default time value for PC.
Set Time	Three options of Synchronize with PC's time / User Input / NTP are available for your selection to link with the Time Server. The default setting is Synchronize the time with PC's time
Date (yy/mm/dd)	To set the Date Time manually select "User Input" and system administrator must enter the Date and Time in the respective field manually.
Time (hh:mm:ss)	
Time Zone	System administrator must select the time zone for the region. Please refer to the appendix for the time zone selection table.

Hint

Please find below NTP server web address for your reference to set the timeserver.

<http://www.eecis.udel.edu/~mills/ntp/clock1.htm>

<http://www.eecis.udel.edu/~mills/ntp/clock2.htm>

Popup Screen

This screen is displayed setting event message while motion or sensors has been activated

When any one of alarms enabled, and one of them detected, then a message window will be displayed on the screen.

Pop-up Setting

Pop-up text
Emergency

Alarm pop-up text

Display mode Administrator All users

Motion detection ON OFF

SAVE CANCEL

Pop up Screen

Pop up Settings

Pop-up text	Input the warning text.
Display mode	Select display mode for your
Sensor 1, Sensor 2, Motion detection	Enable or disable the display of a text string in the video image. Type the text string that you want to display in the adjacent field.

Firmware upgrade Screen

This screen is displayed when you click the *Firmware Upgrade* menu on the Status screen.



Firmware Upgrade Screen

This screen allows you upgrade the Firmware (software) in your ICA-650. Before using this screen, you must download the upgrade file to your PC.

Please be noted the following notes before proceeding firmware upgrade.

1. Please close the camera tour function.
2. Please close the motion detection function.
3. Please reduce the frame rate.
4. Please modify the resolution to smallest one.

NOTE Do not interrupt the upgrading procedure during proceeding; or the inner component might be permanently damaged.

Then follow this procedure to upgrading firmware:

1. Click the Browse button, and locate the upgrade file.
2. Select this file, and click OK. The filename will then appear in the Upgrade File field.
3. Click the Start Upgrade button to transfer the file to the ICA-650 and start the upgrade procedure.



4. Click the "here" button to begin to upgrade firmware.

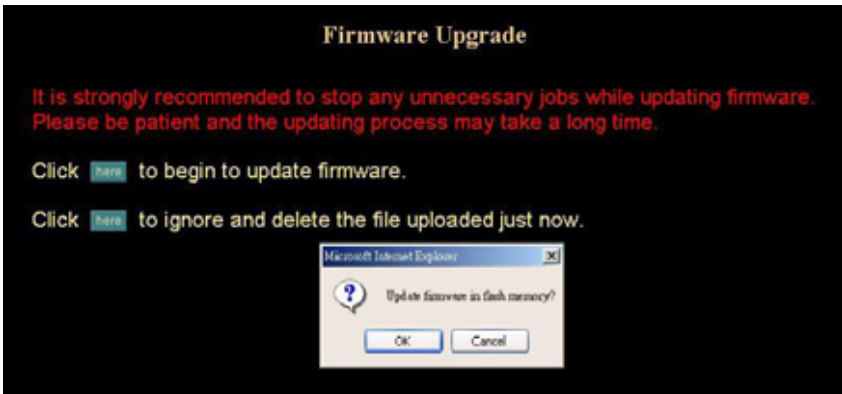

5. Click the "OK" button to continue.



6. The upgrade progress status information will be displayed on the screen. Once the upgrading process completed, the Network Camera will reboot the system automatically.

Factory Default Screen

This screen is displayed when you click the Factory Default menu on the Status screen.

Please Click "OK" button to load default settings to camera.

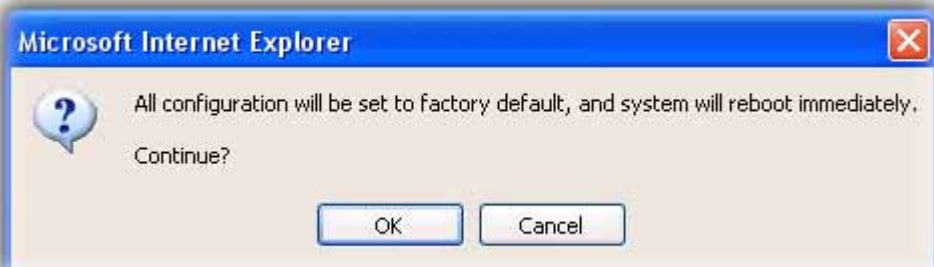

Reboot

Reboot the Network Camera by hardware reset



Trigger & Capture

Trigger:

This is sending an image or output a trigger to control the alarm output, using Trigger section on the main page.

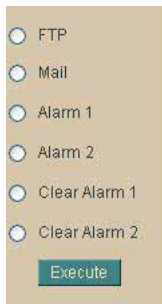

Trigger Settings

FTP	Upload a captured image to server
Mail	Mail captured image to specific mail address
Alarm 1	Enable Alarm output 1
Alarm 2	Enable Alarm output 2
Clear Alarm 1	Clear alarm1 output status
Clear Alarm 2	Clear alarm2 output status

Capture:

This screen is displayed when you click the Capture menu and the function can capture current image and save it to storage media. The image is saved in the JPEG format.

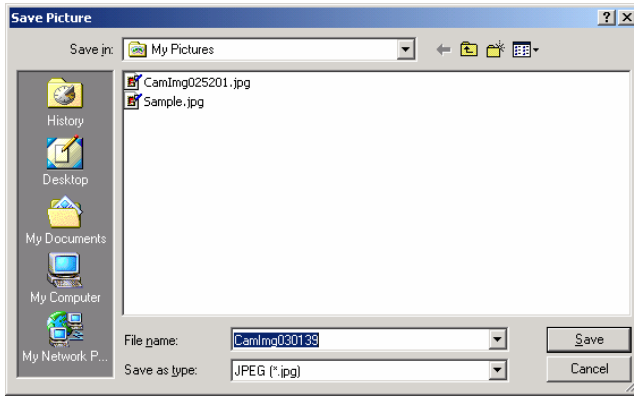

ActiveX Control

This feature only supports on the ActiveX control within Microsoft® Internet Explorer.



View

This screen is displayed when you click the "View" menu on the ActiveX control.



View Settings

Resizable	Make the image is resizable, but “Actual size disable”, the “Splits” is supported on this mode.
Actual size	Make the image show as the actual size, the “Splits” function does not work on this mode.
Status Bar	A status bar display on the button of the image.

Split

This screen is displayed when you click the “Split” menu on the ActiveX control. The Network Camera provides four setting for Window split, it can display different time frame images of the selected Network Camera. The time string with green characters is the current displayed image.

Available Split: • 1 x 1 (Default) • 2 x 2 • 3 x 3 • 4 x 4



Rotate & Quality & Resolution

Rotate:

An image can be rotated in predefined 180-degree increments.

Quality:

Available quality : • High (Default) • Low.

Resolution:

Available resolution: • 176x144 • 320x240 • 352x288 • 640x480

Image Recording

This screen is displayed when you click the "Image Recording" menu on the ActiveX control.

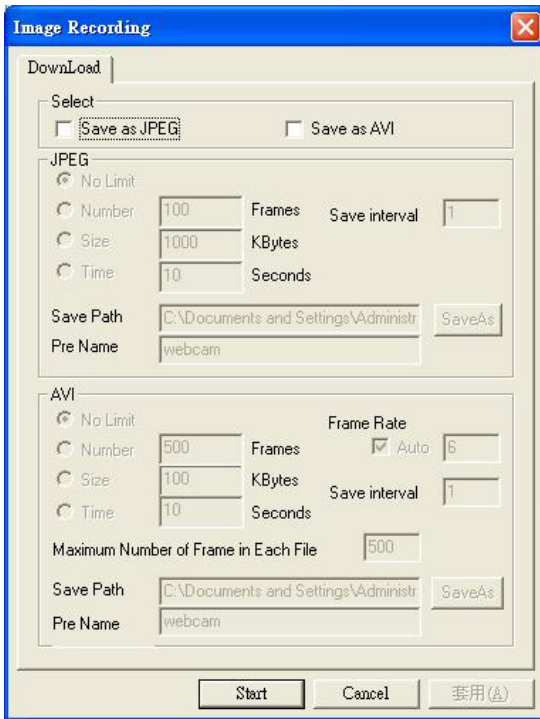

Recording Screen

Save as JPEG:

Select this option and click “Save as JPEG” for detailed configurations. The pre-defined schedule can be set by JPEG.



During the JPEGG file recording, a red icon displays on lower right position of the image to indicate the AVI saving process. If want stop the recording, please press the “Stop Image Recording” to stop the save as JPEG process.

Save as AVI:

Select this option and click “Save as AVI” for detailed configurations. The pre-defined schedule can be set by AVI.



During the AVI file recording, a red icon displays on lower right position of the image to indicate the AVI saving process. If want stop the recording, please press the “Stop Image Recording” to stop the save as AVI process.

Recording File Path:

Save Current Picture As

This screen is displayed when you click the “Save Current Picture As” menu on the ActiveX control.

How to configure Motion Detection

- Please select the “Save Current Picture As “ to save the current display image into the local PC.
- Please input the saved ”file name”, and click “Save” button.
- Please select the file to display the saved image by using any one of graph editing tools.

Chapter 5

Client UTILITY

INSTALLATION

The CamView utility is a powerful utility for video recording, viewing, and camera administrations.

Please insert the user's manual CD and start the CamView installation from the default page or manually browse the **Utility** folder in the CD to install the software:

5.1. CamView Installation

- Run the “**setup.exe**” to start installation. A welcome message is shown as the following figure, and then hit the **Next** button to continue.



- Read the license agreement first, please. If you accept the agreement, select **I accept the agreement**, and then hit the **Next** button to continue.



- Decide which directory to install the software. By default, just hit the **Next** button to continue

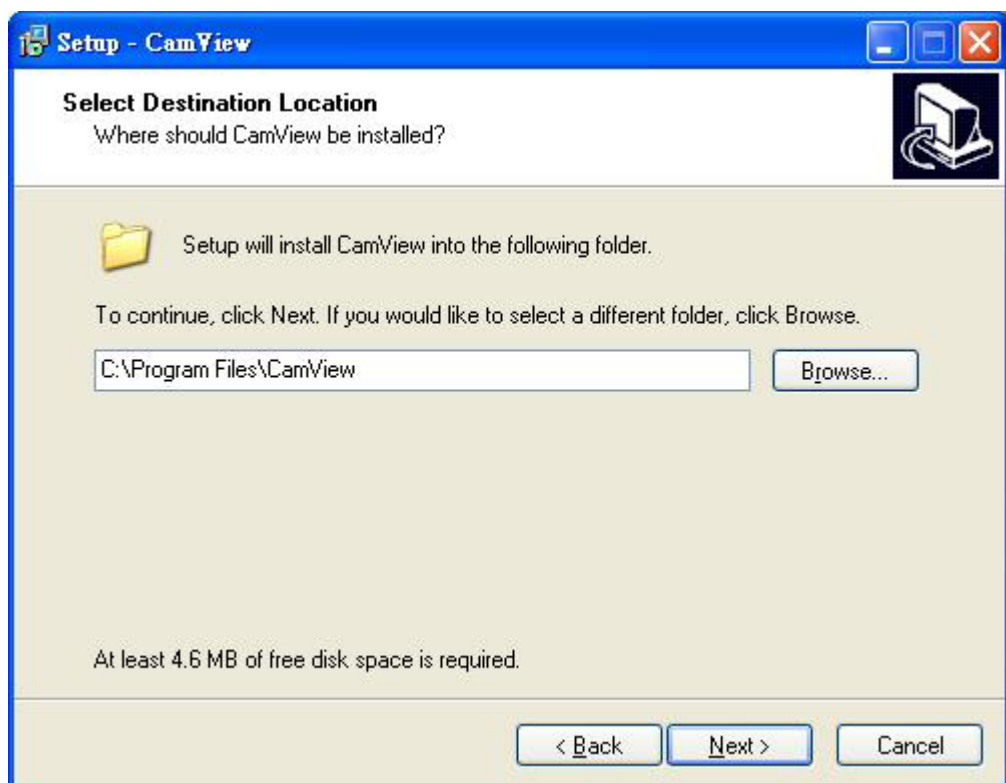

- Decide the program group name. By default, just hit the **Next** button to continue.

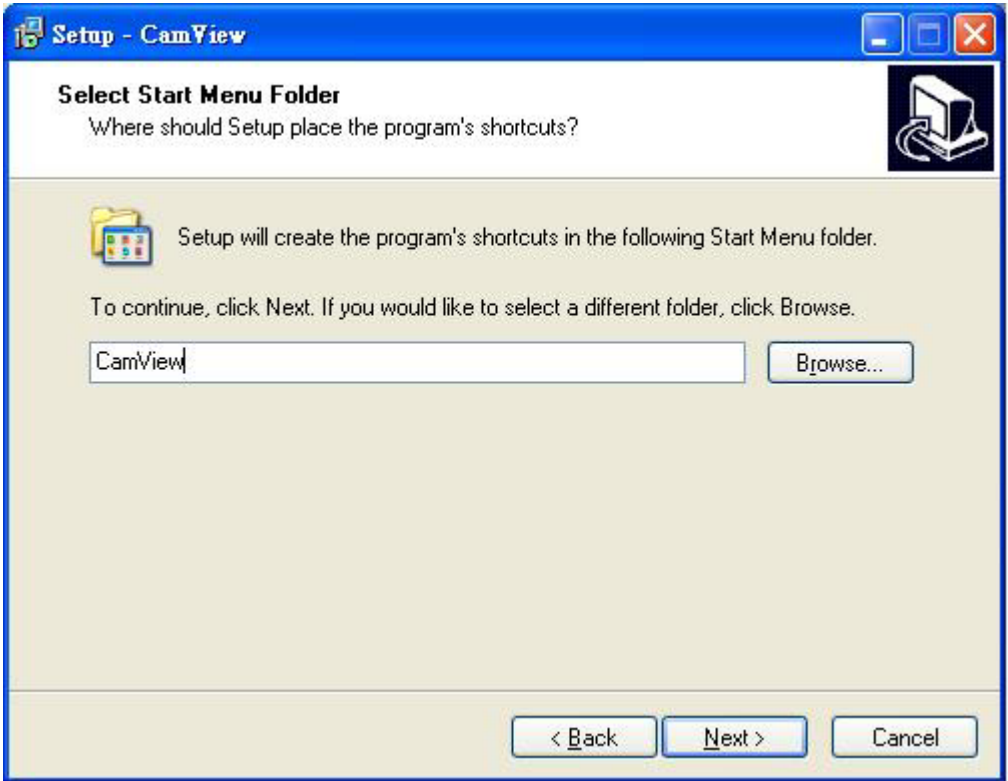

- Decide whether to create a desktop icon of the program. Then press **Next**.

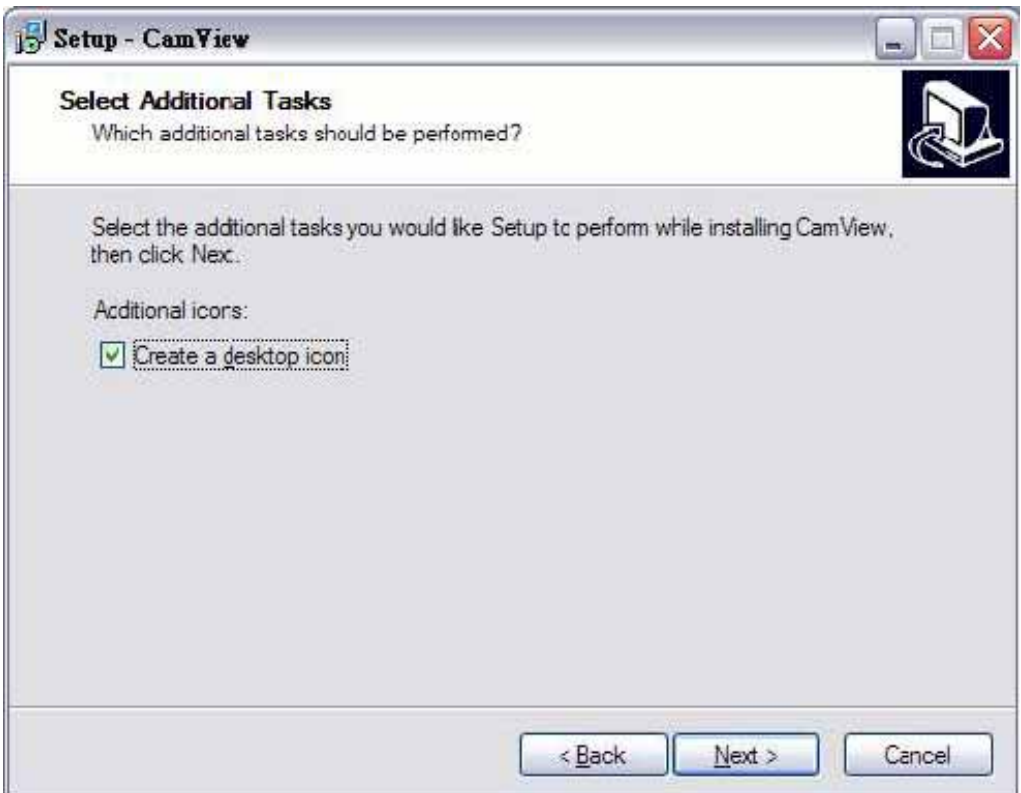

- Ready to install. By default, just hit the **Install** button to start installation.

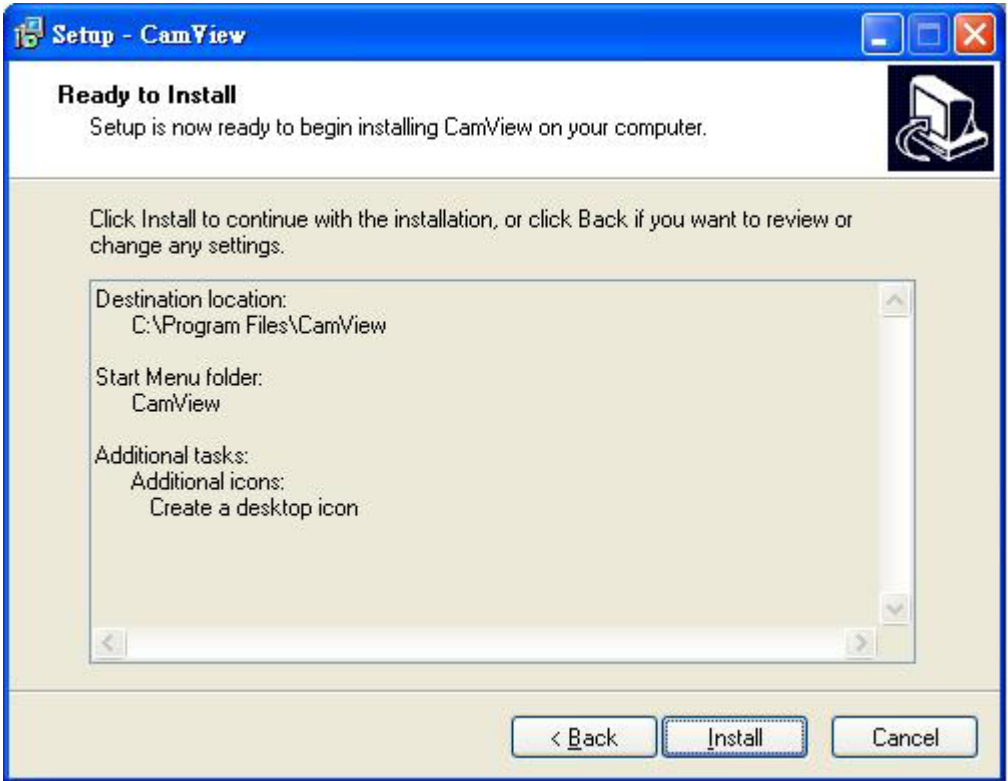

- Installing, wait for a moment.

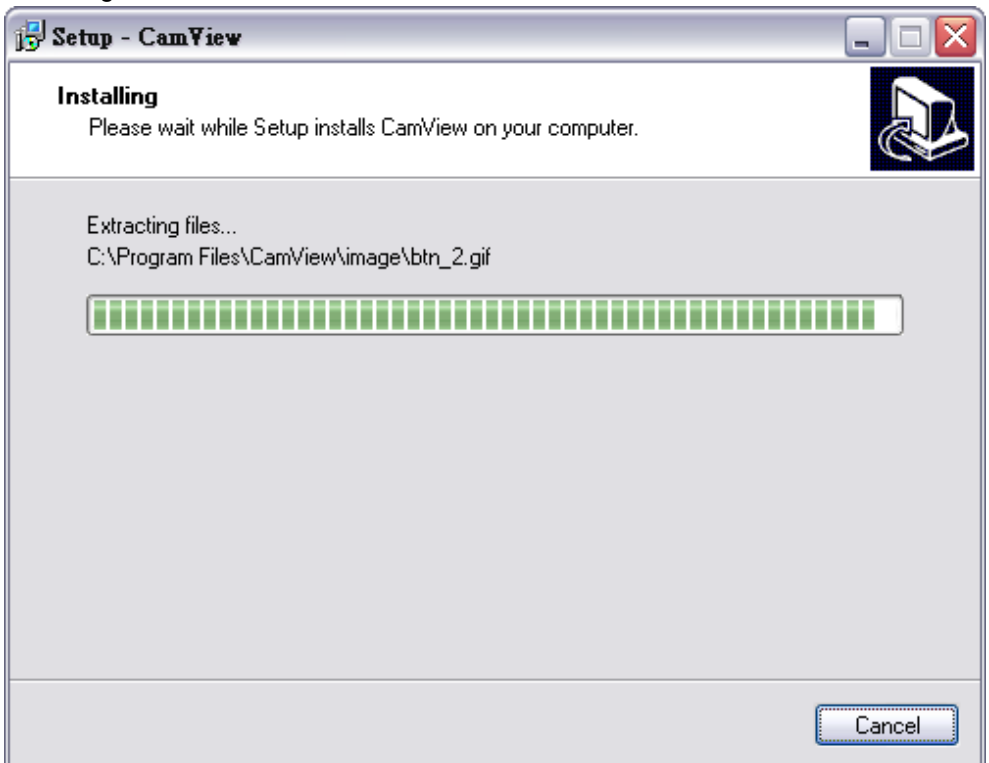

- Installation complete. CamView software can be launched after pressing **Finish**.



HOW TO USE

After successfully installing the utility, this icon.



will be added to the desktop. Double click it to launch the program.

User need login authentication while starting to use CamView.

Two pairs of default login ID and password: **admin/admin** and **guest/guest**.

Admin ID has supreme authority to adjust any settings.

Guest ID has view related function privilege only, and does not have authority to adjust machine settings. Such as switch viewer screen layout, switch camera channel or minimize / close the CamView.

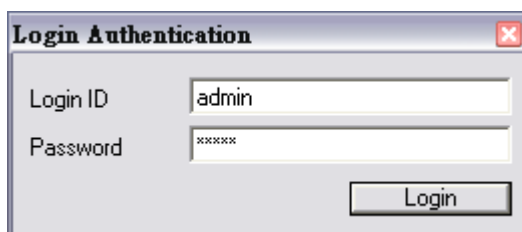

Note: It is strongly suggested to change the Login ID and Password for security concerns.

5.2. CamView User Interface

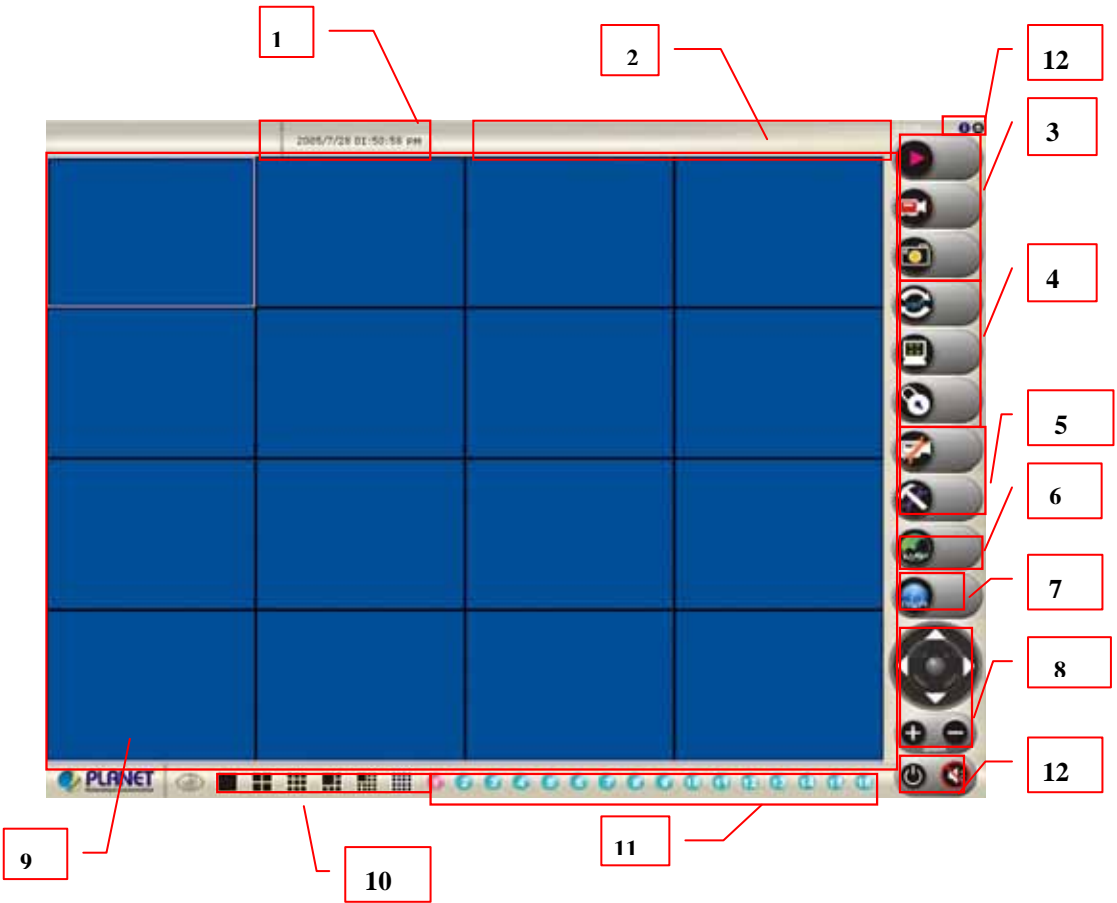

CamView main screen

5.2.1. Date and Time

The current date and time of the computer are displayed here.

5.2.2. Alert Message

A message box will appear while alert event occurs. Ex: free space is almost exhausted.

5.2.3. Recording and Playback

Here are the buttons for playback, record / stop record and snapshot.

5.2.4. Rotate, Full screen and Lock

Press the **Rotate** button to rotate the up-side-down images.

Press the **Full Screen** button to enlarge the viewer screen to full computer screen. Press **Esc** button on the keyboard to return to main CamView screen.

Press the **Lock** button to forbid intruders to operate the CamView unless they input the correct password.

5.2.5. Camera and Application Settings

Press Camera Configuration button to adjust the camera settings in Web.

Press Application Configuration button to adjust and maintain the CamView tasks.

5.2.6. EMap

Press this button to do central location management for 16 cameras.

5.2.7. DVR

Press this button to recall the DVR application and view the DVR images as well.

5.2.8. Camera Pan / Tilt / Zoom Control

Here are the PTZ controllers integrated in the CamView to move the camera direction to the up / down / left / right / home and zoom in or zoom out on the image respectively.

Note: camera zoom feature is reserved for future product development.

5.2.9. Viewer Screen

Users may choose different layout to monitor different cameras. The available camera display modes are shown below:

Each viewer section displays video from the associated camera. Right click on a viewer section, and then the viewer will change to Single viewer. At this movement, Right click on the single viewer again, it will change to previous layout mode. The layout of the screen has the following modes:

- **Single:** Only one viewer displays video.
- **2x2:** The screen is divided into 4 viewer sections.
- **6:** The screen is divided into 6 viewer sections.
- **3x3:** The screen is divided into 9 viewer sections.
- **13:** The screen is divided into 13 viewer sections.
- **4x4:** The screen is divided into 16 viewer sections.

5.2.10. Layout Selection

There are six kinds of layout (*Please refer to 5.2.9 Viewer Screen*) can be chosen.

5.2.11. Camera Selector

Here are the camera number buttons to select cameras.



Blue color: the normal camera icon.



Pink color: the current selected camera.

5.2.12. Minimize, Audio and Close application button

The right top button is for minimizing the CanView software; all the proceeding tasks will not be terminated.

Press Audio button to enable the audio from the associated Internet Camera. To enable audio function from CamView, please also enable audio in Web configuration. *(Please refer to the Chapter 4 Web-Based Management → Control Panel Screen)*

Press power symbol button to close the CamView software; all the proceeding tasks will be terminated.

5.3. Application Configuration

Press the button below to configure the CamView application program. After the button is pressed, a dialog form will show up. Users then configure the program by the form as the following sections.



5.3.1. Application Settings

Figure 5.3.1 shows settings for the global scope of the application including initialization and basic environment settings. After all settings are complete, press the OK button to save the configuration, and exit the form.

Note: The Apply button is unused for this tab; always confirm the settings by pressing the OK button to let configurations take effect.

The following lists descriptions of each setting:

- **Initial Viewer Layout:** Set the initial layout of viewers at the start of the program.
- **Free Space Alert Percent (%):** When the free space reaches the specific percentage, an alert message will appear automatically.
- **Free Space Alert Size [MB]:** When the free space reaches the specified hard drive size, an alert message will appear automatically.

Note: Free Space Alert Percent (%) and Free Space Alert Size [MB] is OR condition combination, any one above is TRUE, then an alert message will appear automatically.

- **Max Number of Events:** Set the number of lines which you want to show in the alert message window.
- **Continuous Recording:** IF free space is not enough, CamView will delete the oldest recording file and keep recording.
- **Export:** Select the item to save the configuration(Application Configuration)
- **Import:** Select the item to load the configuration(Application Configuration)

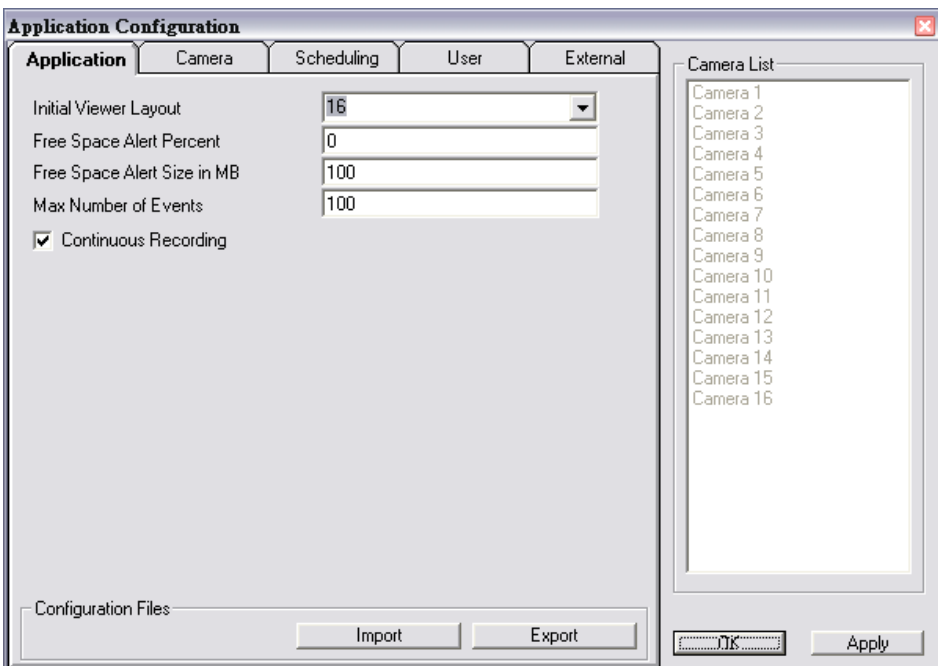

Figure 5.3.1. The Application Tab

5.3.2. Camera Settings

As shown in Figure 5.3.2, users can set parameters of each camera.

If the **Restore** button is pressed, the current setting modifications of the specified camera will be cleared and restore to the original.

If the **Apply** button is pressed, the current setting modifications will be applied to the specified camera. Note that these modifications are not saved to the persistent storage like HD on the computer.

If the **OK** button is pressed, all settings on all tabs will be saved, and exit the form.

Note: The Apply button is unused for this tab; always confirm the settings by pressing the OK button to let configurations take effect.

The following lists describe for each setting:

- **IP:** IP address of the camera.
- **Port:** Connection port of the camera. The default is 80.
- **Login ID:** Please input the login ID if you enable authentication function of the specific camera.
- **Password:** Please input the password if you enable authentication function of the specific camera.
- **Video Path:** A directory to store recorded video files. Double-click the input field or click the square button to select the directory.
- **Video Frame Rate:** frame rate of video.
- **Video Number of Frame:** The maximum number of images are saved in a video file. If the value is larger, then few files will get. If the value is smaller, then more files will get.
- **Snapshot Path:** A directory to store snapshots. Double-click the input field or click the square button to select the directory.
- **Motion Rec Interval[Sec]:** If Motion Detection is enabled, then when Motion Detection starts, CamView will do recording for the specified duration. Minimum unit is second.

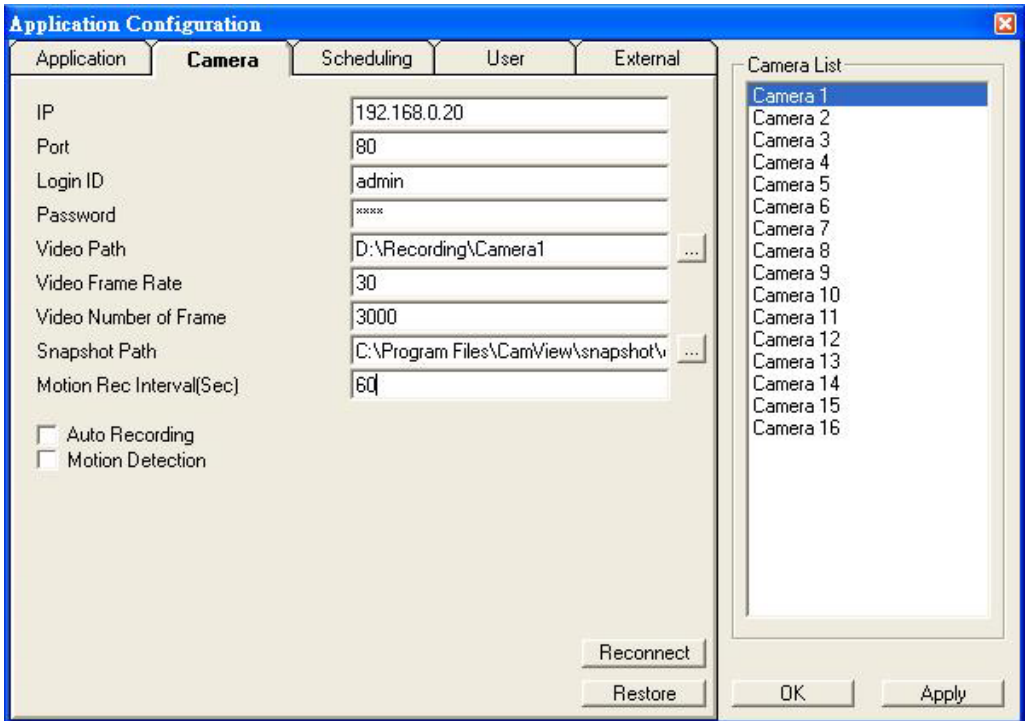

Figure 5.3.2 The Camera Tab

- **Auto Recording:** If the box is checked, the program will do recording for the specified camera automatically at the beginning of CamView starts.
- **Motion Detection:** Check this option will enable Motion Detection in CamView.

5.3.3. Scheduling

As shown in Figure 5.3.3, users can schedule recording.

When you press the **Add** button, the editing task will be added to the **Schedule Items** column.

When the **Modify** button is pressed, the new schedule recording will be updated to the specified item.

If the **Remove** button is pressed, the specified task will be removed from the list.

Note: The Apply button is unused for this tab; always confirm the settings by pressing the OK button to let configurations take effect.

The following lists describe for each setting:

- **Hour:** Set the hour of time in 24- hour clock format. * stands for all hours.
- **Minute:** Set the minute of time. * stands for all minutes.
- **Month:** Set the month for recording tasks. * stands for all months.
- **Day:** Set the day for recording tasks. * stands for all days.
- **Weekday:** Set the specific weekday of a week. If no day is specified, **All** weekdays will fit.
- **Duration (Sec):** The duration in seconds for the schedule recording. 0 (zero) means no limit.

For example, set a recording task which begins at 10:00 every Monday with duration 3600 seconds. The configuration is like below:

Hour = 10, Minute = 0, Month = *, Day = *, Weekday = Mon, Duration = 3600

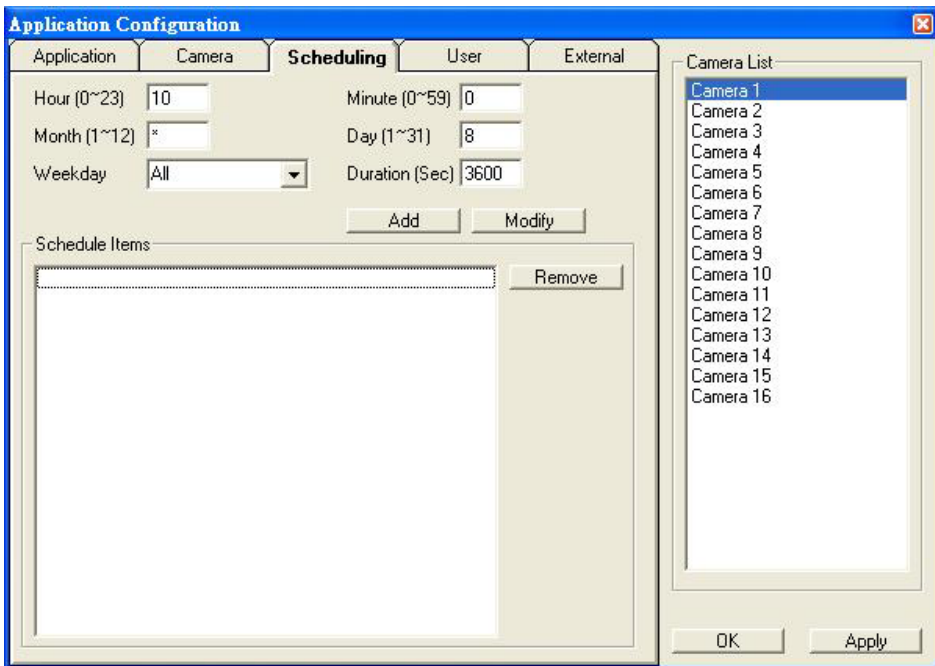

Figure 5.3.3 The Scheduling Tab

5.3.4. User Settings

Two accounts to access CamView.

Admin / Admin: Administrator has the supreme authority to change all the settings.

Guest / Guest: Guest only can view the images only or perform the view related function. Such as switch viewer screen layout, switch camera channel or minimize / close the CamView.

Note: The Apply button is unused for this tab; always confirm the settings by pressing the OK button to let configurations take effect.

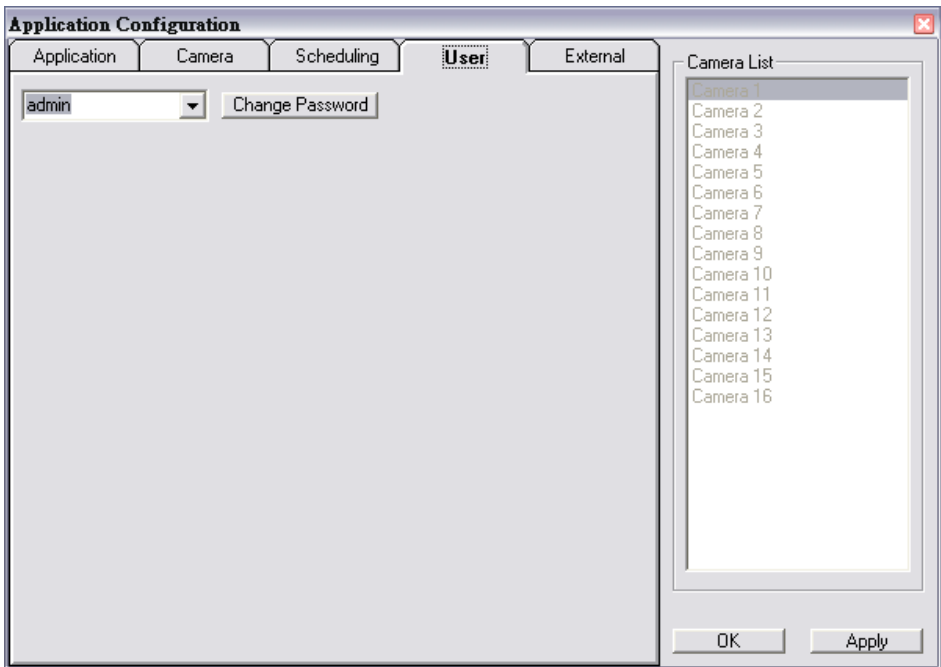

Figure 5.3.4 The User Tab

5.3.5. External Settings

Designate the DVR application path in External tab. Figure 5.3.5 show the setting. When user presses DVR button, the CamView will switch to DVR application.

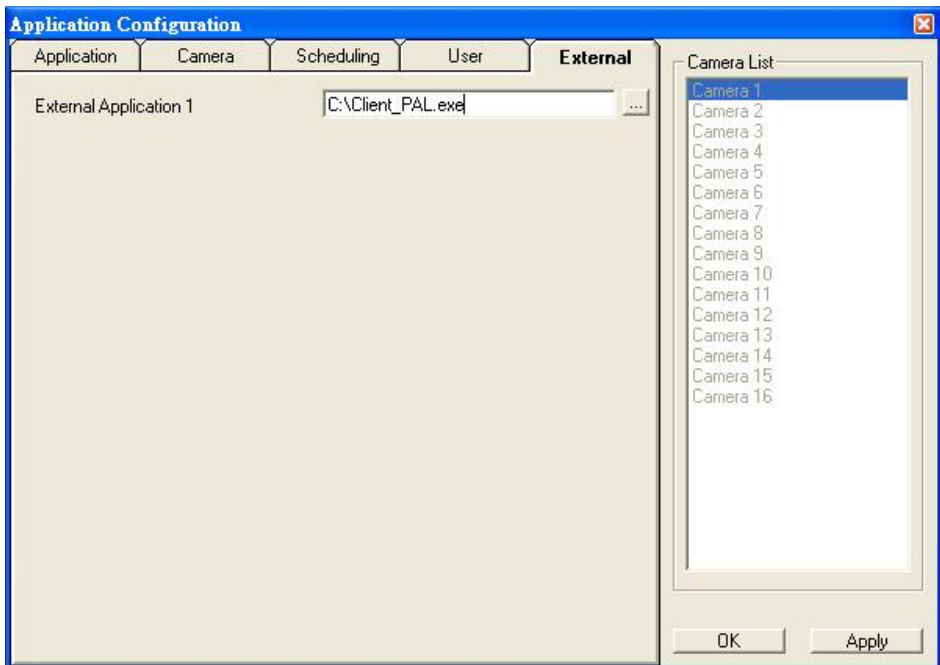

Figure 5.3.5. The External Tab

5.4. Camera Configuration

Users can hit the button shown in Figure 5.4 to configure the associated camera. Please refer to *Chapter 4 Web-Based Management*.



Figure 5.4

5.5. Recording



Figure 5.5-1.



Figure 5.5-2.



Figure 5.5-3.

Select a camera by pressing the button with camera number as shown in Figure 5.5-2, selected camera icon will be like Figure 5.5-3 and then press the toggle button as shown in Figure 5.5-1. To stop recording is similar to the previous method, just press the toggle button as shown in Figure 5.5-1.

The second way to record automatically, the method has described in section 5.3.2 Camera Setting→ Auto Recording.

The last method to record is done by scheduling. Schedule recording tasks are described in section 5.3.3 Scheduling. The CamView will start to record on time.

5.6. Playback

When you press the **Playback** button on the panel as shown in Figure 5.6, a form will appear to show the list of video records and snapshots.



Figure 5.6

5.6.1. Video List

The Video List tab lists video records, and displays the information about the specified record, for example: Camera number, recording start time and recording file length. When you hit the Play button, the Windows Media Player will start to play the video. The Video list is shown in the following figure.

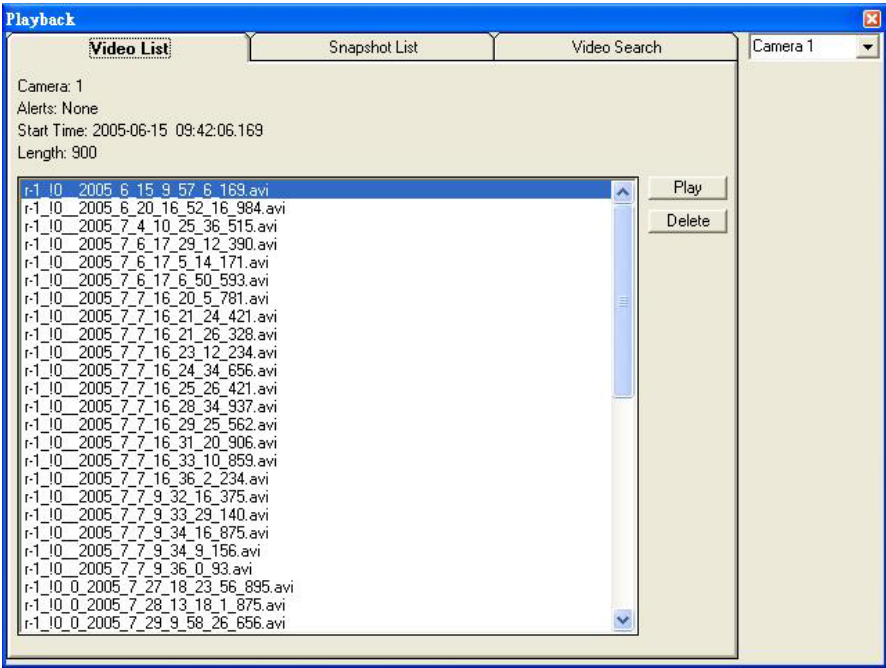

Figure 5.6.1 The Video List Tab

5.6.2. Snapshot List

The Snapshot List tab lists snapshots, and displays the information about the specified snapshot file. When you hit the **Show** button, Internet Explorer will be invoked to display the snapshot.

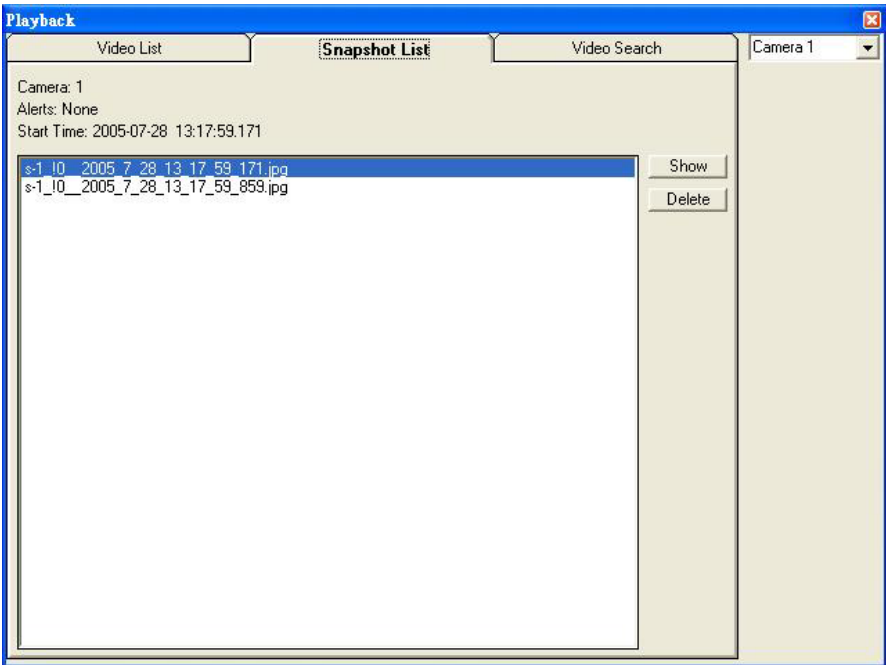

Figure 5.6.2 The Snapshot List Tab

5.6.3. Video Search

The video search tab lists video file information about the specified search.

Press the start time and end time toggle tab, then a calendar form will appear as Figure 5.6.3-1, then select a proper date and time. After press OK in the calendar form then hit the **Search** button, you will get the matched video files in the following column. Press the **Play** button to play the selected video file via the Windows Media Player.

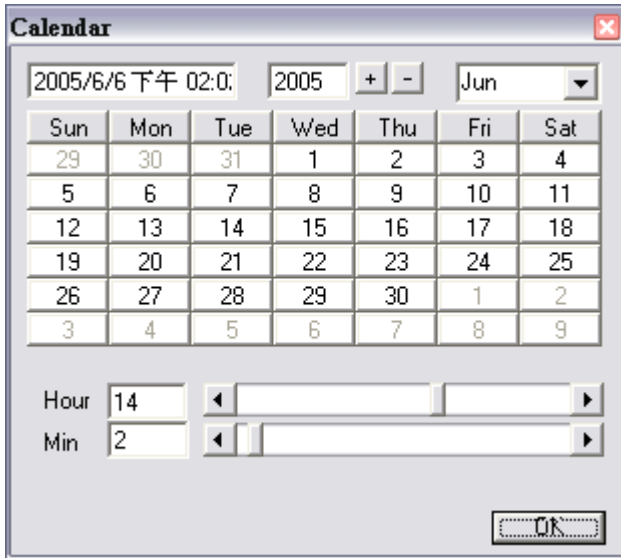

Figure 5.6.3-1 The Calendar Form

Note: The pink color indicates the motion recording event.

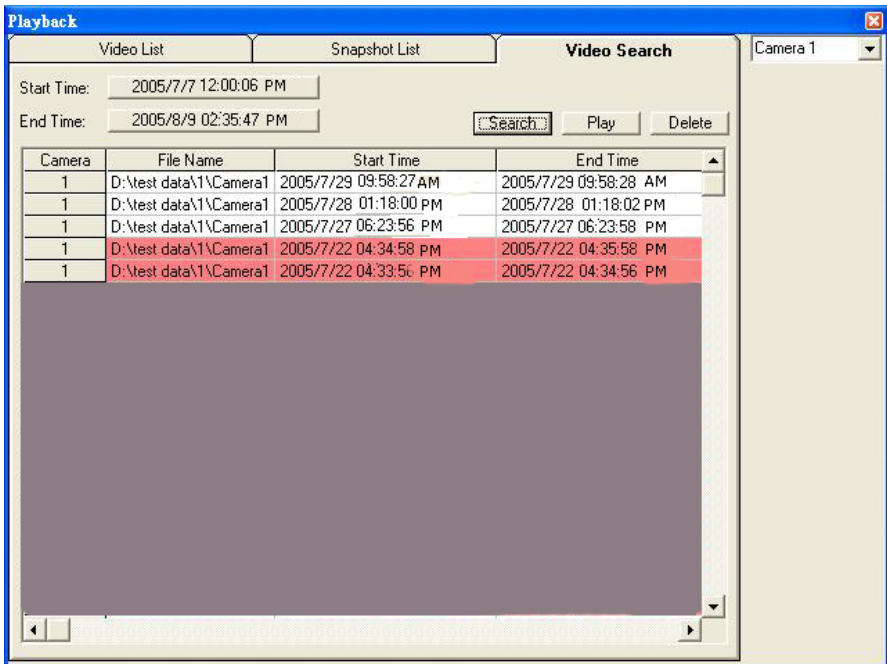

Figure 5.6.3-2 The Video Search Tab

5.7. Image Rotation

After the button is pressed, the displayed image rotates 180 degree. It is used for the camera being installed upside-down direction.

Note: Recorded video / image files will not be rotated.



Figure 5.7

5.8. Full Screen

After this button is pressed, it will show full screen mode and press the keyboard "Esc" key or the center of screen to return normal mode.



Figure 5.8

5.9. Lock Application

Press this button will avoid strangers to access CamView unless they have correct password.



Figure 5.9

5.10. EMap

When you press the **EMap** button on the panel as shown in Figure 5.10, a form will appear to show the eMap function.



Figure 5.10

5.8.1. EMap Setting

Select the File from the File menu bar and the following are descriptions:

1. New EMap: First, create a new layout.
2. Insert Map Image: Choose a proper image file or map layout to load.
3. Delete EMap: Delete current editing EMap layout.
3. Save: Save all settings.

4. Exit: Exit EMap function. Before you select it, we recommend you to save the current settings.

The following describes Edit menu bar:

1. Reset: Remove all camera icons in current layout.

In the menu bar, select Window to change EMap.

As shown in Figure 5.10-1 and Figure 5.10-2, with the map image in layout, you can drag the camera icons into proper positions to deploy your cameras.

The following describes layout entries:

- **Name:** Define a name for this layout.
- **Position:** Describe the layout position.

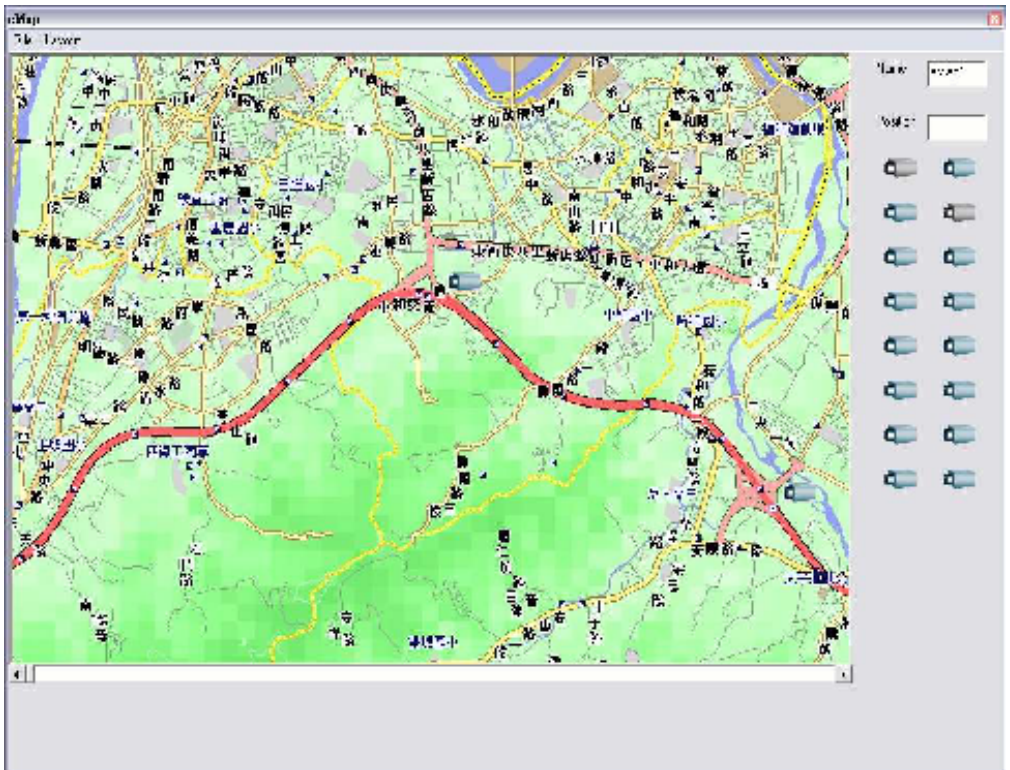

Figure 5.10-1 Layout example 1

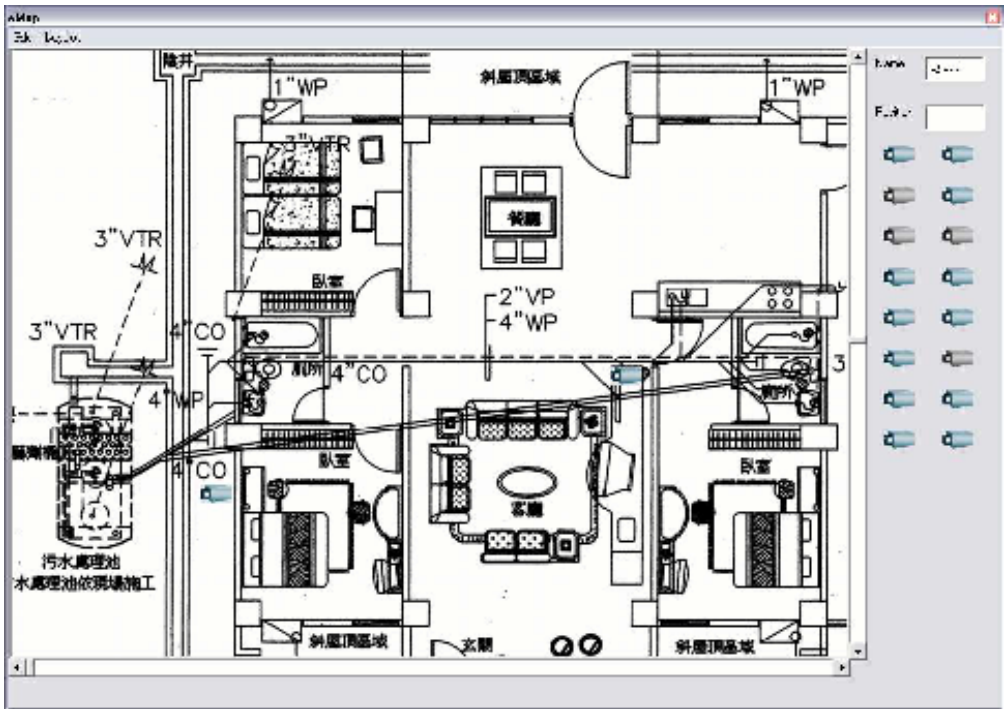

Figure 5.10-2 Layout example 2

- When your mouse moves over the camera icon, you can click the right button to display a menu which has options to set the configuration, show the record list, record, show video and remove the camera icon.



Figure 5.10-3.

Appendix A

Alarm I/O Connector

Appendix A Alarm I/O Connector

Some features of the Network Camera can be activated by an external sensor that senses physical changes in the area Network Camera is monitoring. These changes can include intrusion detection or certain physical change in the monitored area. For examples, the external sensor can be a door switch or an infrared motion detector. These devices are customer provided, and are available from dealers who carry surveillance and security products. Electrically, they must be able to provide a momentary contact closure.

This Network Camera provides a general I/O terminal block with two digital inputs and two outputs for device control. Pin 1 and 2 can be connected to an external sensor 1. Pin 2 and 3 can be connected to an external sensor 2. Both of the inputs, the voltage will be monitored from the initial state 'LOW'. The relay switch of pin 4, 5 and 6 can be used to turn on or off the external device. The relay switch of pin 7 and pin 8 can be used to turn on or off the external device. External Inputs/Outputs are working independently.

Pin	Color	Function
1	Black	Alarm Output #2 (NO)
2	Brown	Alarm Output #2 (COM). Max 24VDC, 1A
3	Red	Alarm Output #1 (NO)
4	Orange	Alarm Output #1 (COM)
5	Yellow	Alarm Output #1 (NC). Max 24VDC, 1A
6	Green	Alarm Input #2 (A). Max 24VDC, 12mA
7	Blue	Alarm Input #1/2 (K).
8	Purple	Alarm Input #1 (A). Max 24VDC, 12mA.

Explanation of External I/O Circuit Diagram Example

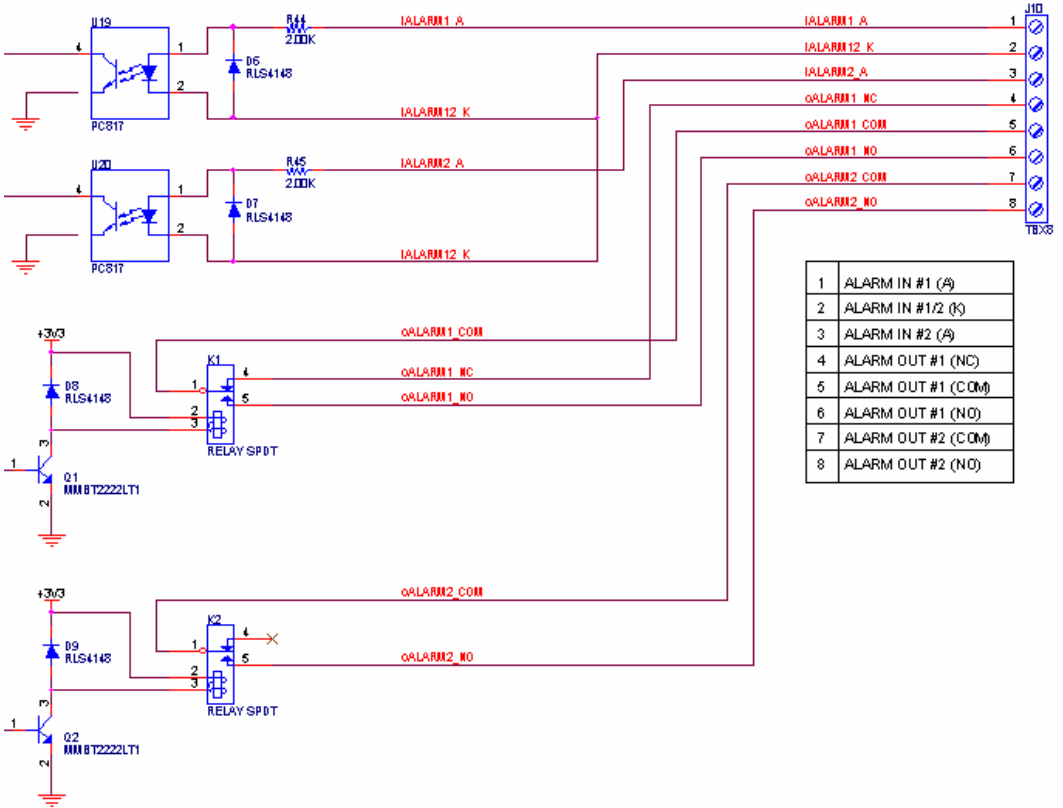

1	ALARM IN #1 (A)
2	ALARM IN #1/2 (B)
3	ALARM IN #2 (A)
4	ALARM OUT #1 (NC)
5	ALARM OUT #1 (COM)
6	ALARM OUT #1 (NO)
7	ALARM OUT #2 (COM)
8	ALARM OUT #2 (NO)

Appendix B

Troubleshooting

Appendix B Troubleshooting

Q: The video and audio codec is adopted in the Network Camera?
A: The Network Camera utilizes JPEG compression to providing high quality images. JPEG is a standard for image compression and can be applied to various web browsers without the need to install extra software. The audio codec is ADPCM compression.
Q: The maximum number of users access Network Camera simultaneously.
A: The maximum number of users is depending on the total bandwidth accessed to Network Camera from clients. The data throughout of Network Camera is around 5~6Mbps. Therefore, the maximum number of connected clients is varying by settings of resolution and frame rate. Obviously, the performance of the each connected client will slow down when many users are logged on.
Q: The Network Camera can be used outdoors or not.
A: The Network Camera is not weatherproof. It needs to be equipped with a weatherproof case for outdoors using. However, equipped with a weatherproof case will disable the audio function of Network Camera.
Q: The Network Camera will be installed and work if a firewall exists on the network.
A: If a firewall exists on the network, port 80 is open for ordinary data communication. The Network Camera uses port 80(default) only. This port (or the port you specify from the Configuration screen if you change the default port) needs to be opened on the firewall.
Q: The username and password for the first time or after factory default reset
A: Username = admin and leave password blank. Note that it's all case sensitivity.
Q: Forgot the username and password
A: Follow the steps below. <ul style="list-style-type: none">•Restore the factory default setting by press pressing and holding down more than 8 seconds when power on Network Camera.•Reconfigure the Network Camera.
Q: Forgot the IP address of the Network Camera.
A: Check IP address of Network Camera by using the IP Finder (ipedit) program.
Q: IP Finder program (ipeditv3) cannot find ICA-650
A: <ul style="list-style-type: none">• Re power the ICA-650 if cannot find the unit within 1 minute.• Do not connect ICA-650 over a router. IP Finder program cannot detect ICA-650.• If IP address is not assigned to the PC which running IP Finder program, and then IP Finder program cannot find ICA-650. Make sure that IP address is assigned to the PC properly.• Antivirus software on the PC might interfere with the setup program. Disable the firewall of the antivirus software during setting up ICA-650.
Q: Internet Explorer does not seem to work well with the ICA-650
A: Make sure that your Internet Explorer is version 6.0 or later. If you are

<p>experiencing problems, try upgrading to the latest version of Microsoft's Internet Explorer from the Microsoft webpage at: http://www.microsoft.com/windows/ie.</p>
<p>Q: IP Finder program fails to save the IP address parameters</p>
<p>A: • Don't leave any space in the name field. Use underline, “_”, or dash, “-” to replace the space, “ ”. • Network may have trouble. Confirm the parameters and connections of the ICA-650.</p>
<p>Q: Internet Explorer does not seem to work well with the ICA-650 Cannot access the login page and other web pages of ICA-650 from Internet Explorer</p>
<p>A: • Another device or computer is already using Maybe the IP Address of the ICA-650. To confirm this possible problem, disconnect the ICA-650 from the network first, and then run the PING utility to check it out.</p> <ul style="list-style-type: none"> • Maybe due to the network cable. Try correcting your network cable and configuration. Test the network interface by connecting a local computer to the ICA-650 via a crossover cable. • Make sure the Internet connection and setting is ok. • Make sure enter the IP address of Internet Explorer is correct. If ICA-650 has a dynamic address, it may have changed since you last checked it. • Network congestion may prevent the web page appearing quickly. Wait for a while. <p>The IP address and Subnet Mask of the PC and ICA-650 must be in the same class of the private IP address on the LAN.</p> <ul style="list-style-type: none"> • Make sure the http port used by the ICA-650, default=80, is forward to the ICA-650's private IP address. • The port number assigned in your ICA-650 might not be available via Internet. Check your ISP for available port. • The proxy server may prevent you from connecting directly to ICA-650, set up not to use the proxy server. • Confirm that Default Gateway address is correct. • The router needs Port Forwarding feature. Refer to your router's manual for details. • Packet Filtering of the router may prohibit access from an external network. Refer to your router's manual for details. • Access ICA-650 from the Internet with the global IP address of the router and port number of ICA-650. • Some routers reject the global IP address to access ICA-650 on the same LAN. Access with the private IP address and correct port number of ICA-650. • When you use DDNS, you need to set Default Gateway and DNS server address. • If it's not working after above procedure, reset ICA-650 to default setting and installed it again. • If the problem is not solved, the ICA-650 might be faulty. Contact your dealer for further help.
<p>Q: Image or video does not appear in the main page</p>
<p>A: • The first time the PC connects to ICA-650, a pop-up Security Warning window will appear to download ActiveX Controls. When using Windows NT, Windows 2000 or Windows XP, log on with an appropriate account that is authorized to install applications. • Network congestion may prevent the Image screen from appearing quickly. You may choose lower resolution to reduce the required bandwidth.</p>
<p>Q: Check the ICA-650's ActiveX is installed on your computer</p>
<p>A: Go to C:\Windows\Downloaded Program Files and check to see if there is an entry for the file “WebWatch Class”. The status column should show “Installed”. If the file is not listed, make sure your Security Settings in Internet Explorer are configured properly and then try reloading the ICA-650's home page. Most likely, the ICA-650 ActiveX control did not download and install</p>

correctly. Check your Internet Explorer security settings and then close and restart Internet Explorer. Try to browse and log in again.
Q: Check the ICA-650's ActiveX is installed on your computer
A: Internet Explorer displays the following message: "Your current security settings prohibit downloading ActiveX controls". Setup the IE security settings or configure the individual settings to allow downloading and scripting of unsigned ActiveX controls.
Q: The ICA-650 works in local network, but not accessible from remote network
A: This might be caused from the firewall protection. Check the Internet firewall with your system or network administrator. The firewall may need to have some settings changed in order for the ICA-650 to be accessible outside your LAN. • Make sure that the ICA-650 isn't conflicting with any other web server running on your LAN. • Check the configuration of the router settings allow the ICA-650 to be accessed outside your local LAN.
Q: There are unreadable characters displayed in machine configuration pages
A: Use the operating system of the selected language. Set the Encoding or the Character Set of the selected language on the Internet Explorer.
Q: Frame rate is slower than the setting
A: • The traffic of the network and the object of the image affect the frame rate. The network congestion causes frame rate slower than the setting. • When more than one client were viewing, the frame rate becomes slower. • Ethernet switching hub can smooth the frame rate especially in viewing on the Multi-Camera screen.
Q: Blank screen or very slow video when audio is enabled
A: Your connection to the ICA-650 does not have enough bandwidth to support a higher frame rate for the streamed image size. Try reducing the video streaming size to 176x144 or 320x240 and/or disabling audio. • Audio will consume 32 to 64 kbps. Disable audio to improve video. Your Internet connection may not have enough bandwidth to support streaming audio from the ICA-650.
Q: Image Transfer on e-mail or FTP does not work
A: • Default Gateway and DNS server address should be set up correctly. • If FTP does not work properly, ask your ISP or network administrator about the transferring mode of FTP server.
Q: The focus on the camera is fuzzy.
A: • The lens is dirty or dust is attached. Fingerprints, dust, stain, etc. on the lens can degrade the performance camera. Clean the lens with lens cleaner. • Manual focusing may be setup on the external camera to prevent this. • Blurred images may have been registered when registering or modifying the preset button or home position button. Adjust the focus in manual focusing again • The image may be out of focus, if the object is too near, or depending on the zoom position. Move the object off ICA-650, or adjust the zoom position. • Some objects are difficult to focus on by the camera. When the objects are still out of focus, adjust the focus using manual focusing, or change the objects using Pan/Tilt operation.
Q: The color of the image is poor or strange
A: • To insure the images you are viewing are the best they can be, set the Display property setting (color quality) to 16bit at least and 24 bit or higher if possible within your computer. • The configuration on the ICA-650 image display is incorrect. You need to adjust the image related parameters such as brightness, contrast, hue and saturation properly.

Q: Image flickers
A: • Wrong power line frequency makes images flicker. Make sure the NTSC or PAL format of your ICA-650 • If the object is dark, the image will flicker. Make the condition around the ICA-650 brighter.
Q: Noisy images occurs
A: The video images might be noisy if the ICA-650 is located in a very low light environment. Make the condition around the ICA-650 brighter.
Q: How to Reboot the ICA-650
A: If you just want to reboot system without change anything. Go to Network page and click SAVE button directly, then system will reboot again.
Q: Can not play the recorded AVI file
A: Have installed Microsoft's® DirectX 9.0 or later and use the Windows Media Player 9 or later to play the AVI filed recorded by the ActiveX.

Appendix C

Bandwidth Calculation

Appendix C: Bandwidth Calculation

The frame rate of video transmitted from the ICA-650 depends on connection bandwidth between client and server and quality setting of server. Here is a guideline to help you roughly estimate the bandwidth requirements form your ICA-650.

Image bandwidth is approximately equal to the average frame rate in frames per second multiplied by the average frame data size in kilobits. Frame data size, or the number of bits comprising a single video frame varies a great deal from depending on scene complexity, lighting conditions, camera noise, etc. The table shown below is reference figures. Actual results generated by the ICA-650 may be varying.

Image Resolution	Average range of Data Sizes
176 x 144 (QCIF)	20 – 40k bit
320 x 240 (QVGA)	56– 92k bit
352 x 288 (CIF)	64 – 112k bit
640 x 480 (VGA)	160 – 320k bit

For example, streaming 2 fps of 320 x 240 video requires 112 to 184 kbps (kilobits per second). Therefore, with a 128K upload connection; you will typically see 3 to 6 frames per second with 176 x 144 resolution and 1 to 2 frames per second with 320 x 240 resolution without audio stream.

Note

Audio streaming also takes bandwidth around 32 kbps to 64kbps. Most ADSL/Cable modem upload speeds may not even reach up to 128 kbps. Thus, you may not be able to receive any video while streaming audio on a 128 kbps or lower connection. Even though the upload speed is more than 128kbps, for optimal video performance, disabling audio streaming will get better video performance.

Appendix D

Specifications

Appendix D: Specifications

Model	ICA-650
Zoom Module	
Image Pick-up Device	1/4" Sony CCD
Optical Zoom	18x
Digital Zoom	12x
Zoom module	SONY Day/ Night module (EX480)
Illumination	0.05 Lux
Horizontal Resolution	480 TVL
Lens Size	f = 4.1~73.8mm,F 1.4-3.0
BLC	On/Off
Iris Control	Auto/ Manual
Speed Dome	
Variable Pan Speed	0 ~ 300 deg/second
Pan Coverage	360 degree continuous
Variable Tilt Speed	0 - 200 deg/second
Presets	16 presets
Tours (with indents)	5 groups
I/O	
Video Out	1 channel video pass through
Audio Streaming	1ch, Line-in
Alarm In/Out	2 alarm input/ 2 alarm output
Power	US Model:110V AC EU Model: 240V AC
Full Set	Outdoor speed dome+ Wall mount+ Power box (Heater & Fan auto enable/disable)
Construction Level	IP-66 weather proof
Operating temperature	-30~+50 degree C (-22~122 degree F)
IP	
Codec	JPEG, 3 levels
Resolution	640*480,352*288, 320*240,176*144
Frame Rate	30fps for all resolutions
Compatibility	Windows 2000, XP, Server 2003
LAN Interface	10/100M
Notification	Email, FTP, Popup message

Type Of IP Address	Static or Dynamic
IP Filter	Yes
Motion Detection	Yes. Adjustable area
Viewer	Microsoft Internet Explorer 5.0 or later
Network Protocol	TCP/IP, HTTP, SMTP, FTP, NTP, DNS, DDNS,
Communication protocol	PPPoE

Free Manuals Download Website

<http://myh66.com>

<http://usermanuals.us>

<http://www.somanuals.com>

<http://www.4manuals.cc>

<http://www.manual-lib.com>

<http://www.404manual.com>

<http://www.luxmanual.com>

<http://aubethermostatmanual.com>

Golf course search by state

<http://golfingnear.com>

Email search by domain

<http://emailbydomain.com>

Auto manuals search

<http://auto.somanuals.com>

TV manuals search

<http://tv.somanuals.com>