



Multi-Port Fast Ethernet Print Server

FPS-3120

User's Manual

Copyright (C) 2004 PLANET Technology Corp. All rights reserved.

The products and programs described in this User's Manual are licensed products of PLANET Technology, This User's Manual contains proprietary information protected by copyright, and this User's Manual and all accompanying hardware, software, and documentation are copyrighted.

No part of this User's Manual may be copied, photocopied, reproduced, translated, or reduced to any electronic medium or machine-readable form by any means by electronic or mechanical. Including photocopying, recording, or information storage and retrieval systems, for any purpose other than the purchaser's personal use, and without the prior express written permission of PLANET Technology.

Disclaimer

PLANET Technology does not warrant that the hardware will work properly in all environments and applications, and makes no warranty and representation, either implied or expressed, with respect to the quality, performance, merchantability, or fitness for a particular purpose.

PLANET has made every effort to ensure that this User's Manual is accurate; PLANET disclaims liability for any inaccuracies or omissions that may have occurred.

Information in this User's Manual is subject to change without notice and does not represent a commitment on the part of PLANET. PLANET assumes no responsibility for any inaccuracies that may be contained in this User's Manual. PLANET makes no commitment to update or keep current the information in this User's Manual, and reserves the right to make improvements to this User's Manual and/or to the products described in this User's Manual, at any time without notice.

If you find information in this manual that is incorrect, misleading, or incomplete, we would appreciate your comments and suggestions.

CE mark Warning

There are class A and class B device, In a domestic environment, this product may cause radio interference, in which case the user may be required to take adequate measures.

Trademarks

The PLANET logo is a trademark of PLANET Technology. This documentation may refer to numerous hardware and software products by their trade names. In most, if not all cases, these designations are claimed as trademarks or registered trademarks by their respective companies.

Revision

User's Manual for PLANET Multi-Port Fast Ethernet Print Server

Model: FPS-3120

Rev: 1.0 (August. 2004)

Part No. EM-FPS3120

Table of Contents

CHAPTER1 INTRODUCTION.....	1
1.1 Product Introduction.....	1
1.2 Product Package	1
1.3 Network Printing Architecture	1
1.3.1 Print Server Network Functions.....	2
1.3.2 Network Printing Functions for Clients	2
1.3.3 Network Printing Functions for Network Server.....	4
1.4 Network Printing Environment	5
1.5 Contents of the User's Manual	6
1.6 Firmware & Printing Function	6
CHAPTER2 HARDWARE INSTALLATION.....	7
CHAPTER3 WINDOWS PEER-TO-PEER NETWORK	8
3.1 System Architecture.....	8
3.2 Administrator Installation and Setup	8
3.3 Administrator Utilities	15
3.4 Client Installation and Setup	16
CHAPTER4 WINDOWS NT/2000 NETWORK	18
4.1 System Architecture.....	18
4.2 Windows NT/2000 Server Installation and Setup	18
4.3 User Installation and Setup.....	19
CHAPTER5 NETWARE NETWORK.....	21
5.1 System Architecture.....	21
5.2 NetWare 3.x/4.x/5.x Installation & Setup	21
5.2.1 Installation with Pconsole.....	22
CHAPTER6 UNIX SYSTEM NETWORK.....	24
6.1 Introduction.....	24
6.2 Enable Print Server's TCP/IP Support.....	24
6.3 Setup Print Server's IP Address	24
6.3.1 DHCP.....	24
6.3.2 BOOTP	25
6.4 Verify Print Server's IP Address	25
6.5 Configure Remote LPD Printing on the Host	26
CHAPTER7 CONFIGURATION UTILITY.....	28
7.1 Introduction.....	28
7.2 Search – Search for All Available Print Server	29
7.3 Status - Status of Print Server	30
7.4 Setting up the Print Server.....	31
7.5 General Configuration.....	32
7.6 TCP/IP Configuration.....	33
7.7 Network Configuration.....	34
7.8 AppleTalk Configuration	35
7.9 System Configuration	36
7.10 Wizard	37
7.11 Report.....	42
CHAPTER8 WEB MANAGEMENT	43

8.1	Introduction.....	43
8.2	Web Management of Print Server.....	43
8.2.1	Login.....	43
8.3	Device Status.....	44
8.3.1	System.....	44
8.3.2	Printer.....	45
8.3.3	TCP/IP.....	46
8.3.4	SMB.....	46
8.3.5	SNMP.....	47
8.3.6	NetWare.....	47
8.3.7	AppleTalk.....	48
8.4	Setup Wizard.....	49
8.4.1	System.....	49
8.4.2	TCP/IP.....	50
8.4.3	SMB.....	51
8.4.4	SNMP.....	52
8.4.5	NetWare.....	53
8.4.4	AppleTalk.....	54
8.5	System Tools.....	55
8.5.1	Load Default.....	55
8.5.2	Upgrade Firmware.....	55

CHAPTER9 IPP PRINTING 56

9.1	Introduction.....	56
9.2	System Setup.....	56
9.2.1	Print Server Side.....	56
9.2.2	Client Side.....	56

Chapter 1 Introduction

1.1 Product Introduction

Thank you for purchasing and using our FPS-3120. This print server allows your printer to become a shared device on the network. It offers printing flexibility and manageability on your Local Area Network at an extremely low cost and with an absolute minimum setup and maintenance required.

This print server provides a LAN port (10/100Mbps Ethernet), two USB ports and one parallel port for printers.

This print server supports TCP/IP, IPX/SPX and AppleTalk protocols. It is the best network printing solutions for various common network operating systems such as Windows 95/98/Me Peer-to-Peer Printing, Windows NT/2000/XP/Server 2003, NetWare, Unix/Linux, MAC OS, etc.

With the help of Installation Wizard, you can easily and instantly complete the settings for your printing environment, and start enjoying the fantastic features provided by this print server.

In the following chapters, we will introduce in detail the printing features, installation methods, and system configuration for different network environments.

1.2 Product Package

This package contains the following components:

1 x FPS-3120

1 x Power Adapter

1 x Driver and User's Manual CD

1 x Quick Installation Guide

1.3 Network Printing Architecture

This section illustrates how FPS-3120 functions and operates on the network. Before you install and use FPS-3120, it is strongly suggested that you read this section completely, and select only the chapters you need according to your network operating system by "Contents of the User's Manual" in next section.

This section will first introduce the role every component plays in the network-printing environment.

Print Server

Client User

Network Server (optional)

Network Printing Environment

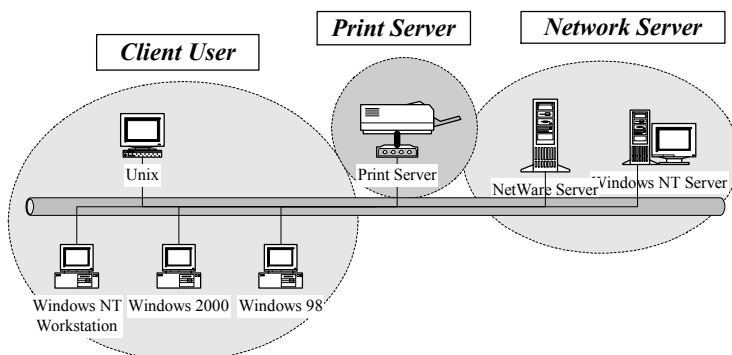

Detailed examples will then be illustrated through actual network environment.

1.3.1 Print Server Network Functions

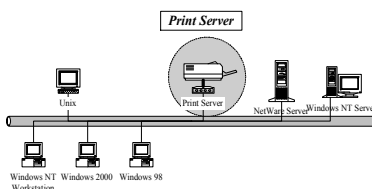

Because print server supports IPX, TCP/IP and AppleTalk network protocols, any networked computer can directly print to the print server from any of its installed protocol.

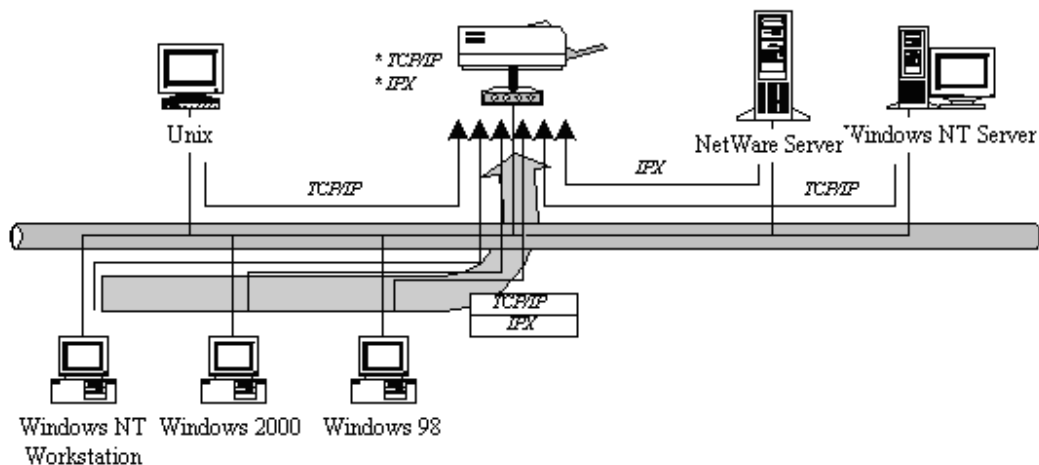

1.3.2 Network Printing Functions for Clients

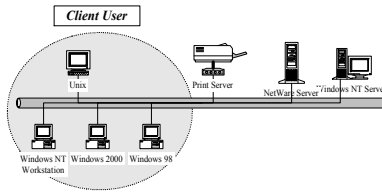

Common operating systems for clients are classified as following:

Windows 95/98/Me/NT/2000/XP

Our print server system provides PTPP (Peer-to-Peer Printing) driver and utilities for Windows 95/98/NT/2000/XP users. PTPP (Peer-to-Peer Printing) supports TCP/IP protocol.

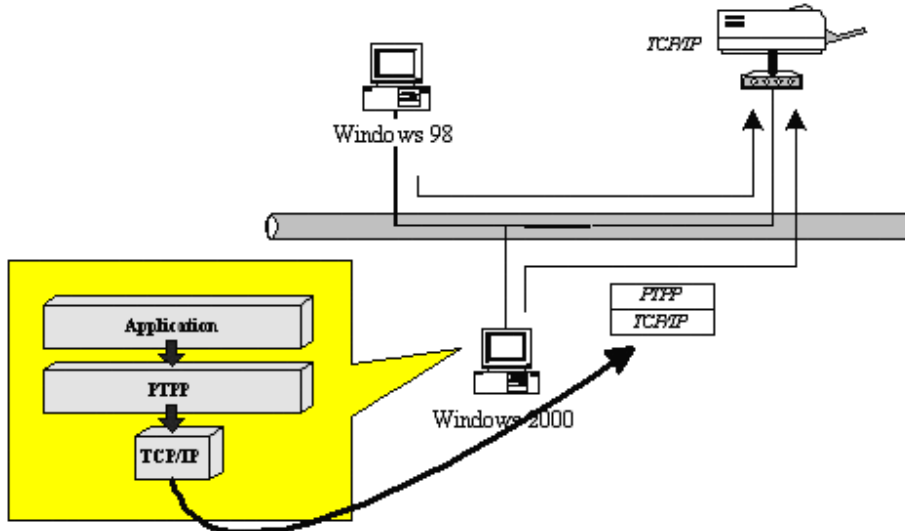

In the client installation procedure, after PTPP (Peer-to-Peer Printing Driver) is installed into Windows, the system will automatically (manual configuration is also allowed) search through all the print servers on the network, and then add their printing ports into Windows' printing port. (See below)

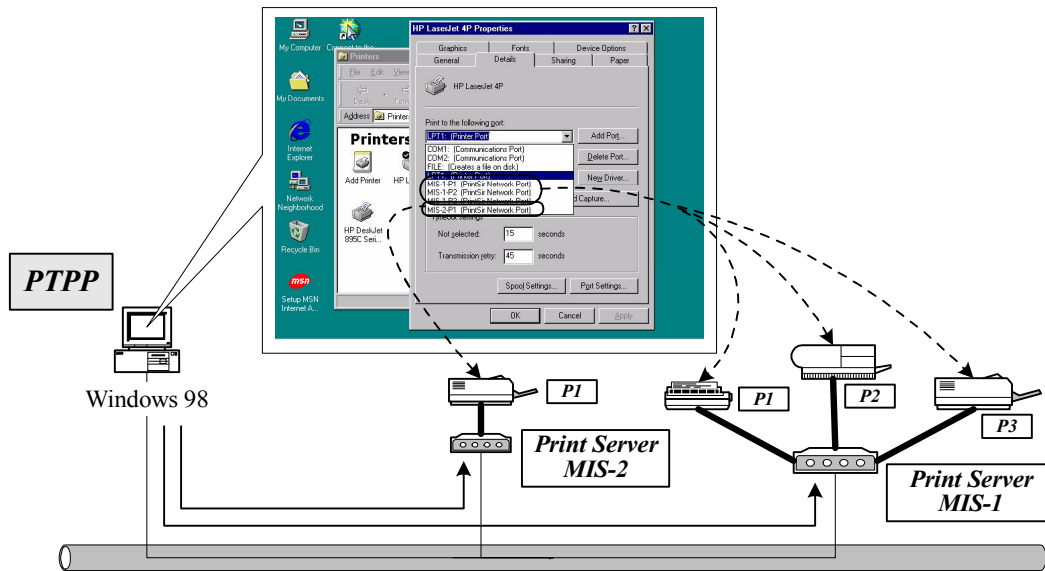

UNIX / Linux

UNIX (include HP/UX, SCO Unix, SunOS, Solaris, Unixware DECUnix, IBM AIX and others) and Linux use the system-standard LPR to print to print server.

MAC OS

MAC OS can use the system-standard AppleTalk network to print to print server.

1.3.3 Network Printing Functions for Network Server

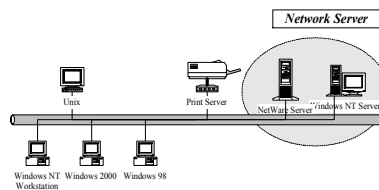

Common network servers are classified as following:

Windows NT/2000

Our print server system provides PTPP (Peer-to-Peer Printing) driver and utilities for Windows NT/2000. After PTPP is installed, the server can directly print to print server. Adding this printing function into Windows NT/2000 Server allows print queue, user authority management, and many other advanced features.

NetWare 3.x/4.x/5.x

In NetWare environment, print server offers various printing modes like print queue, remote printer, etc.

1.4 Network Printing Environment

Common network environment are classified as following:

Windows Peer-to-Peer Network

The client's PTPP driver will use TCP/IP protocol to print to print server.

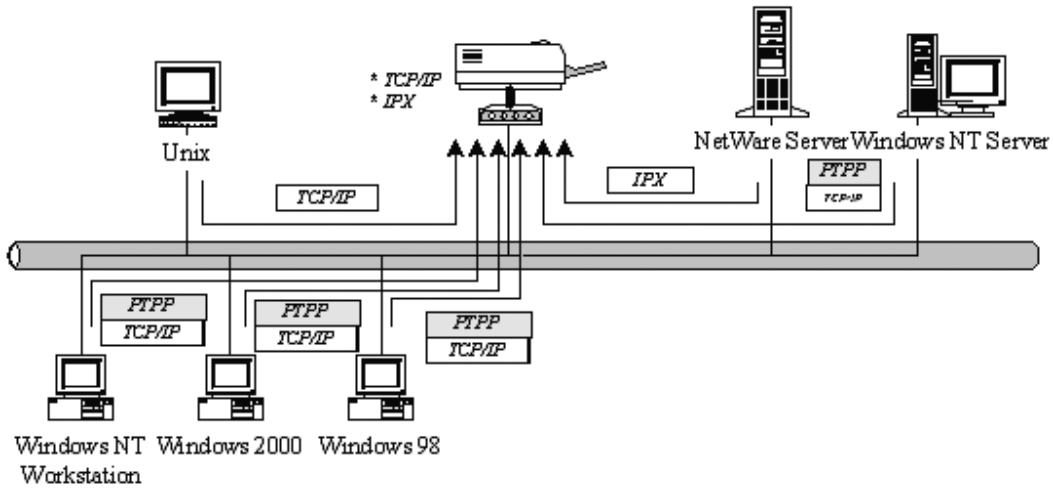

Windows NT/2000 Network

Network printing function will become available after PTPP driver is installed into Windows NT/2000. Adding this printing function into Windows NT/2000 Server allows print queue, user authority management, and many other advanced features.

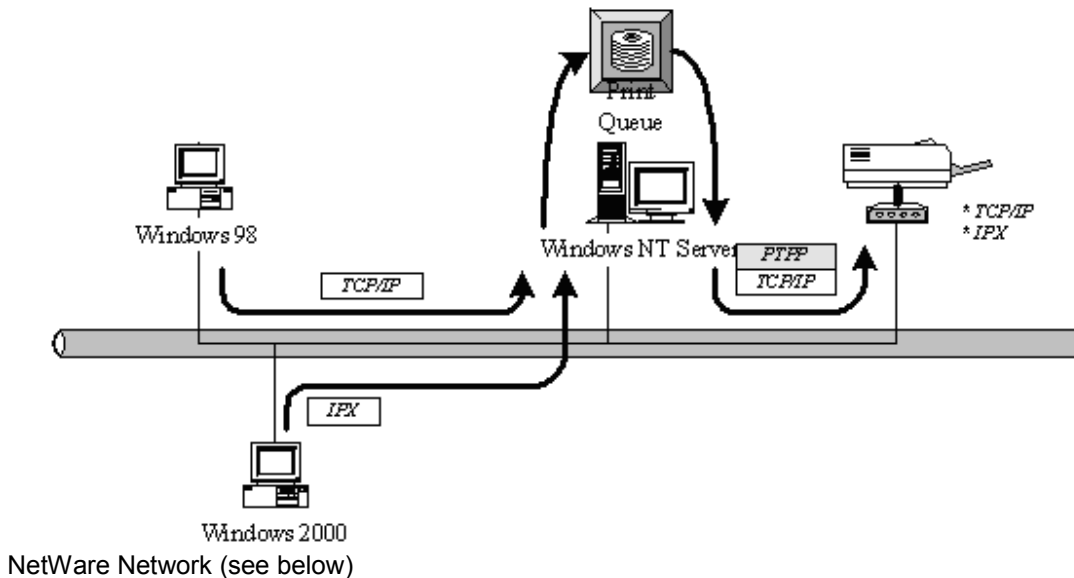

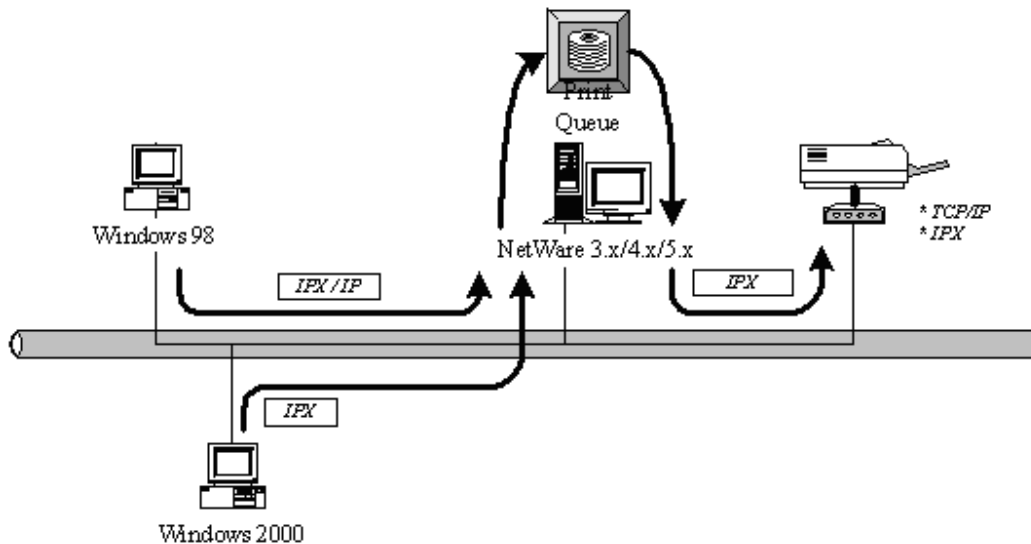

1.5 Contents of the User's Manual

Chapter 2 explains print server's hardware installation and configuration. It is strongly recommended for you to read.

The following chapters 3, 4, 5, and 6 introduces:

Chapter 3. Windows Peer-to-Peer Network

Chapter 4. Windows NT/2000 Server-Based Network

Chapter 5. NetWare Network

Chapter 6. UNIX System Network

You may select the appropriate chapters and sections to read depending on your network printing's requirement.

Chapter 7 and chapter 8 introduce print server's management and configuration utilities on Windows and Web Browser's environment respectively. You may select the appropriate management utility according to the administrator's computer platform.

Chapter 9 introduces Print Server's IPP Printing function and setup procedure. The IPP Printing provides a convenient way to print documents across the Internet by the IPP protocol.

1.6 Firmware & Printing Function

The print server provides a complete network printing solution. The feature set is listed below:

PTPP (Peer-to-Peer-Printing)

TCP/IP (LPR, SMB)

IPP Printing

NetWare Bindery Printing

AppleTalk

Chapter2 Hardware Installation

1. Unpack the print server package and check all the items listed in section 1.2.
2. Connect the print server to the printer you want to share on the network by standard USB or parallel cable.
3. Connect the power adapter to the print server.
4. The print server will perform the Power-On-Self-Test (POST) after it is powered on. The PWR LED will still "off", for few seconds it will turn "on" to indicate that the print server is ready.

NOTE1: MUST use the power adapter shipped with the print server, do NOT use any other power adapter from any sources.

NOTE2: To prevent the compatibility problem between print server and a few printer, it is recommended that you power on the print server before the printer.

Chapter 3 Windows Peer-to-Peer Network

3.1 System Architecture

Print server supports Windows Peer-to-Peer network printing mode, which is suitable for most medium and small network environments. Through quick and simple installation procedure, users can immediately enjoy the convenience of network printing.

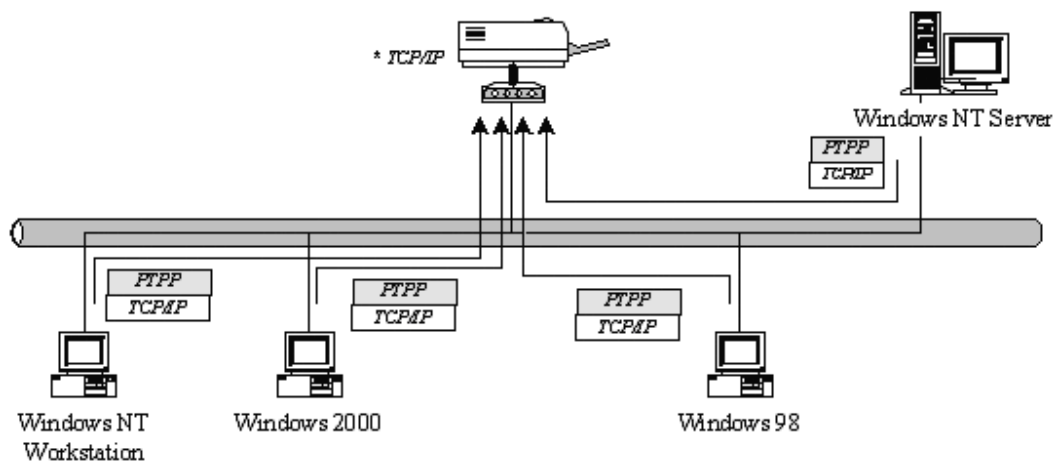

Installation procedure is separated into following two parts:

1. Administrator Installation and Setup (refer to section 2 for more detailed information).

System administrators must:

- Install administrator's utilities into his/her computer.
- Configure print server from administrator's configuration utility.

2. Client Installation and Configuration (refer to section 3 for more detailed information).

Client users must install Windows PTPP driver (Peer-to-Peer Printing) for network printing.

In addition, after PTPP is installed, the system will automatically search for all print servers on the network, and add the printing port of the print servers into Windows' printing port (refer to Network Printing Architecture in section 1.4 for more detailed information).

3.2 Administrator Installation and Setup

The Administrator Installation can be performed on Windows 95/98/Me/NT/2000/XP/Server2003 with the same user interface. Before the installation, please verify that your network protocol is installed on your PC (TCP/IP, IPX and/or NetBEUI). It will be helpful in your installation process.

1. Insert Drivers and User's Manual CD into the CD-ROM drive to initiate the autorun program. Once completed a menu screen will appear.
2. Click on "Administrator Installation" hyper link to initiate the installation. Or you can click the "Start" button and choose "Run". (Suppose "E" is your CD-ROM drive). When the dialog box appears, enter "E:\Utility\Setup.exe" and press enter key. You will see the dialog box as below. Please click "Next" to continue.



3. Specify the destination folder where the utility will be installed. Click "Next".



4. Select the components you want to install. It is highly recommended to install all provided components in administrator installation. Please click "Next".

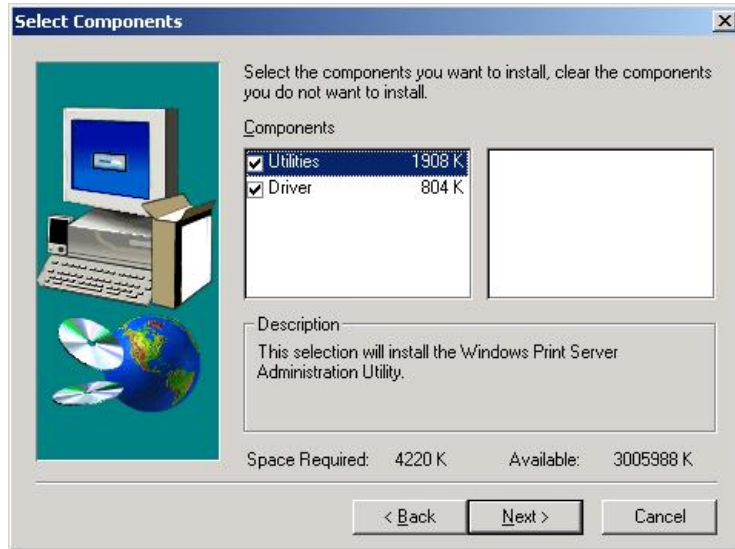

5. Specify the program folder name where the program icons will be add to. Please click "Next" to start installation.

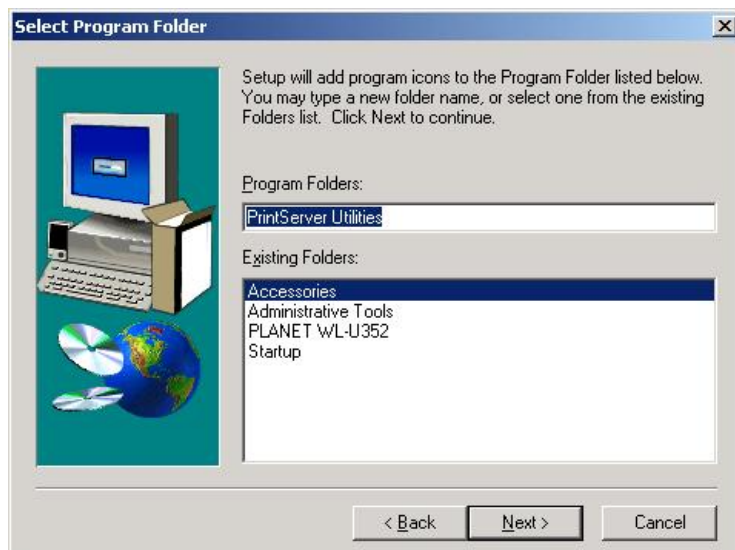

6. For a while, the program will finish installing utility and driver you selected. Thus far you have completed the installation phase and prepare to configure the Print Server. The "Choose Print Server" dialog box will be displayed as following. Please select the print server and click "Next".

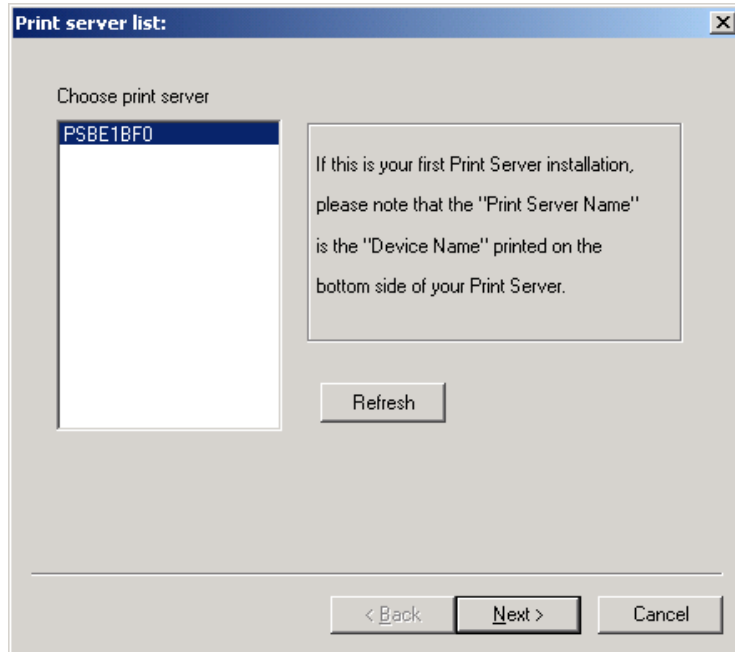

7. "Name the print Server", you can assign an easy to memorize name for management. But note that, this name will be the "Identifier" for the Peer-to-Peer Printing.

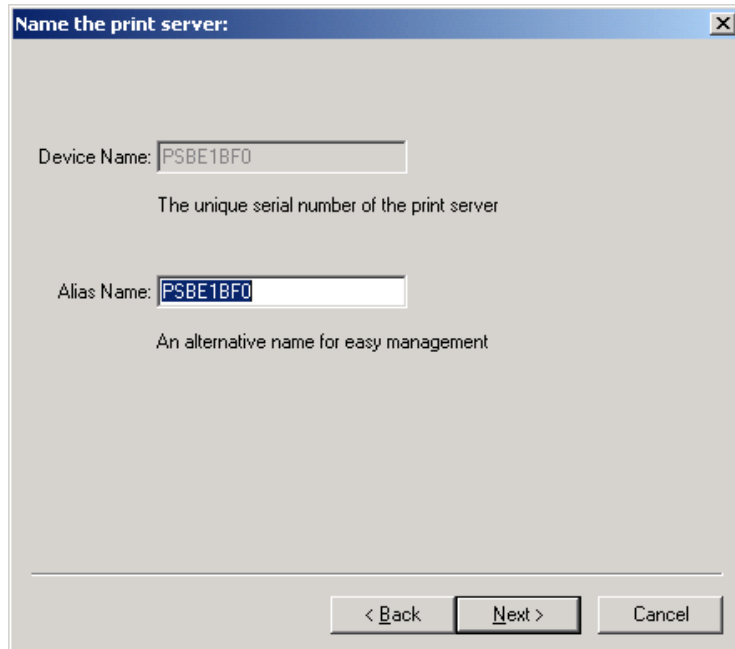

NOTE: If this is the first time you configure the print server, the "Print Server Name" will be the same as the "Device Name" printed at the bottom of the print server.

8. In the system default, IPX and NetBEUI are enabled. But the Peer-to-Peer printing is not support those protocols, so it will show those protocols are not supported. About the TCP/IP, you can either assign a fixed IP address for the print server or configure it later by the configuration utility. Please click "Next".

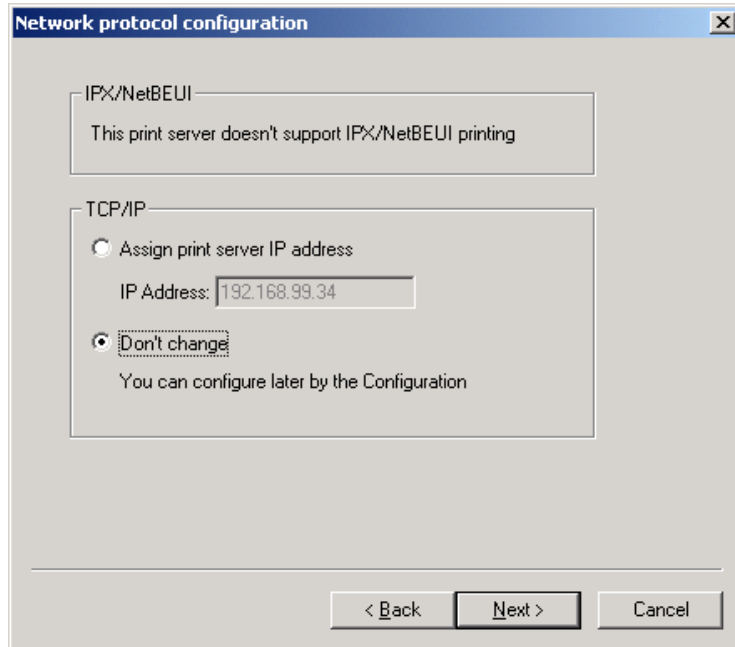

9. Configuration summary will display in this screen. Now, you have completed the “Print Server Setup”. By clicking “Finish”, your system will perform “Add network port” of the print server to your PC.

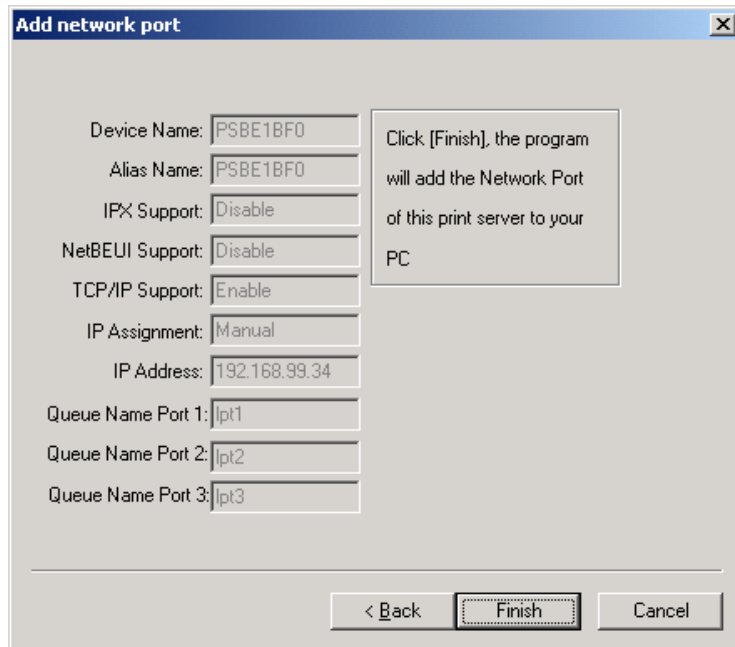

10. The “Setup complete” window is displayed to indicate that the Administrator Installation procedure is finished. Please click “Finish”.



After the installation, you have completed the following tasks,

- Install utility and driver to the administrator's PC
- Configure the print server (including the print server name and network protocol)
- Add the network port of the print server to the administrator's PC

Now, you have completed the administrator's setup for most of the network environment. You can then perform the "*Client Installation*" procedure (section 3.4) on all client's sides of the network.

If you want to print from this administrator's PC to the print server, all you need to do is to perform Windows' standard "Add Printer" procedure as described below.

Step1. Click "Start" button, choose *Setting => Printers*

Step2. Double click "Add New Printer"

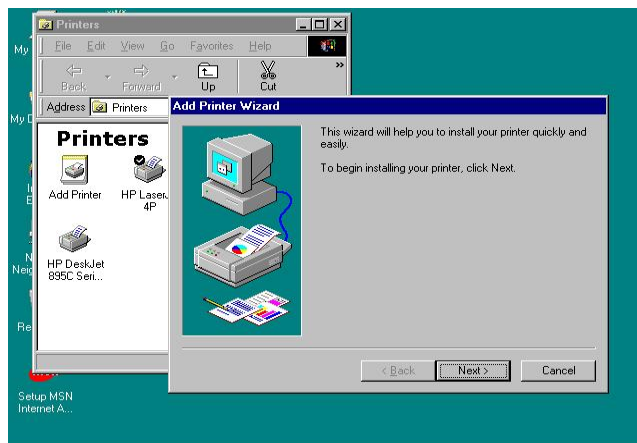

Step3. Select "*Local printer*" => click "Next".

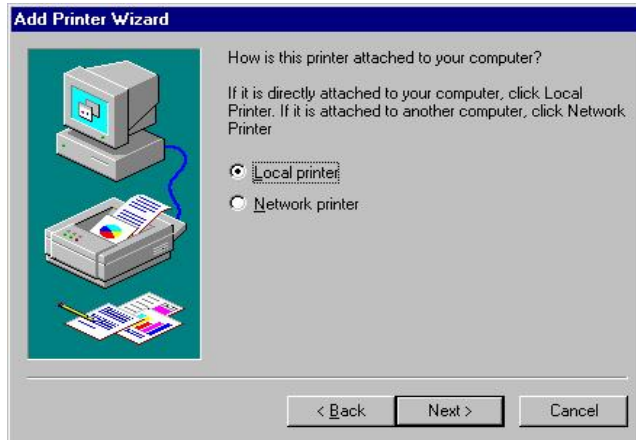

Step4. Select a suitable printer manufacturer and model, then click “Next”.

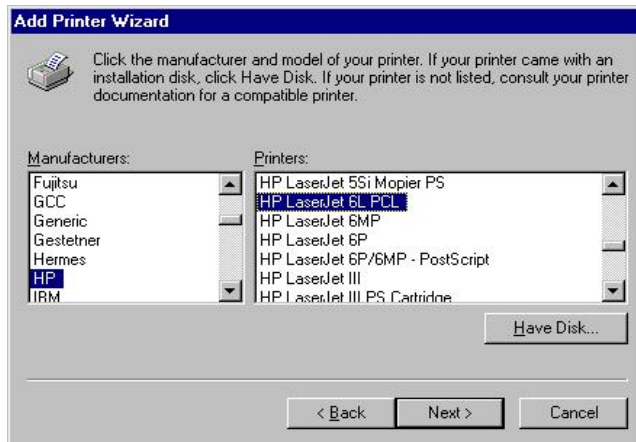

Step5. Choose the “Print Server’s Network Port” which was created by the administrator installation process and click “Next”.

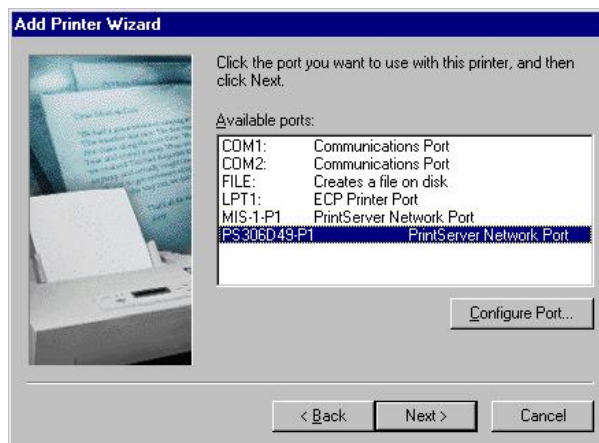

Step6. Complete the rest of the questions to finish the network printer setup.

3.3 Administrator Utilities

After Administrator Installation is completed, there will be six utilities in print server's Program folder.

1. Network Ports Quick Setup

Network Ports Quick Setup Utility offers a very simple method to add or remove print server's printer port from the client's computer.

If you have just installed another new print server on the network, you must run this program first. This program will search for new print servers and allow you to add the new network printer port into client's computer conveniently. Perform the standard Add Printer procedure, and you can print directly to the printer through the newly installed print server.

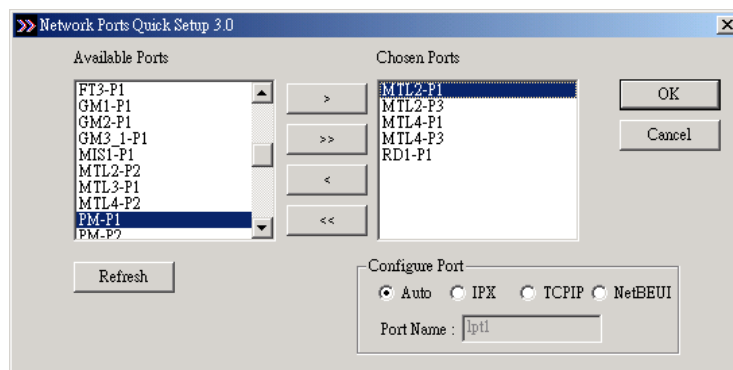

Please be aware that Network Ports Quick Setup Utility can only detect and configure all print servers on the same network, it cannot search and configure print servers on other subnets across network segments. You must use Remote Ports Utility described in the next section to manage remote (across network segments) print servers.

2. Remote Ports

Remote Ports Utility offers a convenient way for you to manage and add printer port of the remote print server. From the assistant of this utility, you can print to other print servers outside the subnet across network segment. However, please note that this function only supports TCP/IP network protocol.

Please follow the procedures described below:

Step1. Run Remote Ports Utility

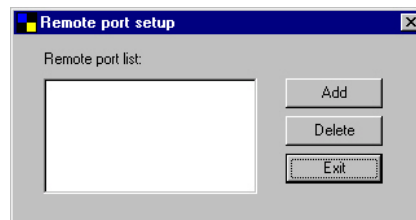

Step2. Press Add, then enter the print server's name, IP address, select used ports, and enter LPR queue name of each port.

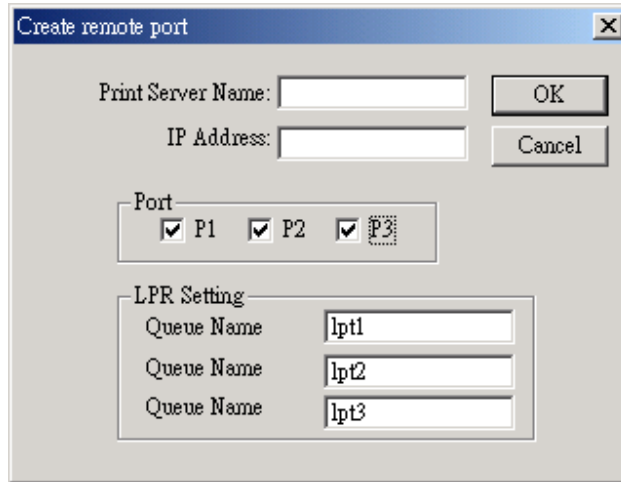

Step3. Press OK to add the remote printer port into your computer's printer ports.

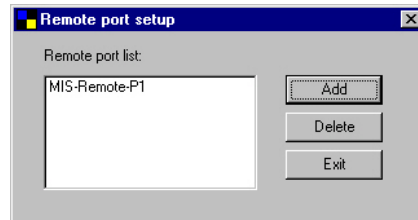

In order to use the remote printing function, you will have to proceed with normal Add Printer procedure and select your printer port as the newly added remote printer port.

3. NetWare Quick Setup

NetWare quick installation software (see chapter 5).

4. Print Server Configuration

Complete print server management tool (see chapter 7 –Print Server Configuration).

5. Uninstall

Assistant for removing all installed administrator software.

6. Web based management tool (see chapter 8 – Web Based Management).

3.4 Client Installation and Setup

The Client Installation can be performed on Windows 95/98/Me/NT/2000/XP and Serve2003 with the same user interface. Before the installation procedure, please confirm that your PC has connected to the network and installed at least one network protocol.

The installation is the same as Administrator Installation, besides the step 4. Please unselect "Utility" option and press "Next" to continue.

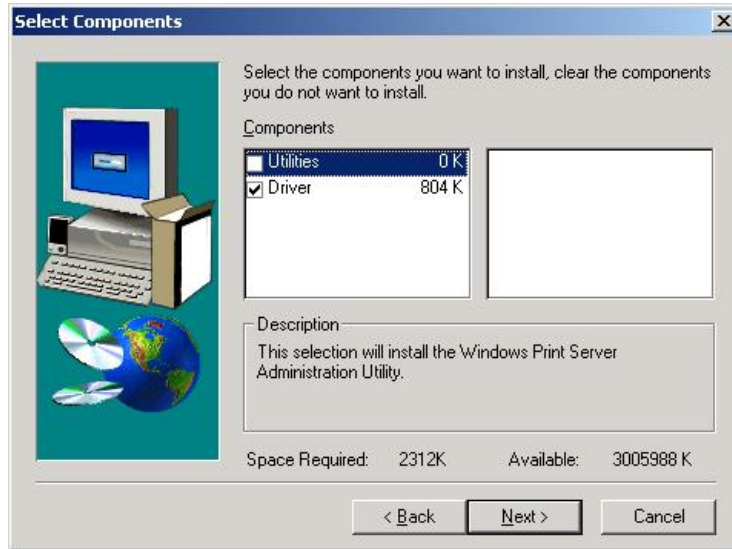

Clients just need to install Peer-To-Peer driver, so you don't need to install the Configuration Utility to the client PC.

Chapter4 Windows NT/2000 Network

4.1 System Architecture

In Windows network environment, other than the Peer-to-Peer network printing architecture described in the previous chapter, we also offer the Server-Based Printing architecture for Windows NT/2000 server. Only one Windows NT/2000 is required to have Windows PTPP (Peer-to-Peer Printing) driver installed and share the printing service on the network. Other network users can simply connect to the server and access the shared printer. (see below)

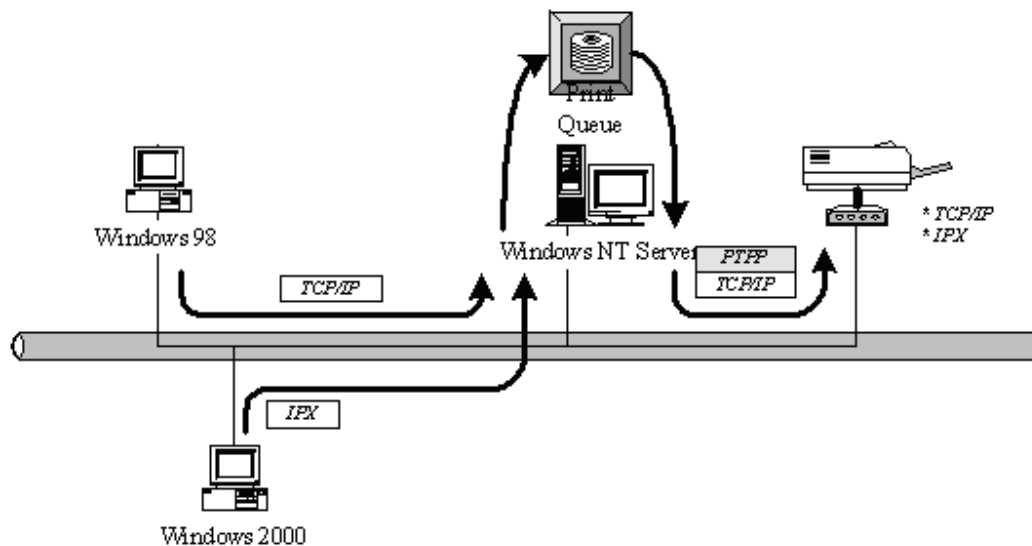

4.2 Windows NT/2000 Server Installation and Setup

Please follow the procedures described below for installation and construct a peer-to-peer connection (PTPP) between Windows NT/2000 Server and Print Server.

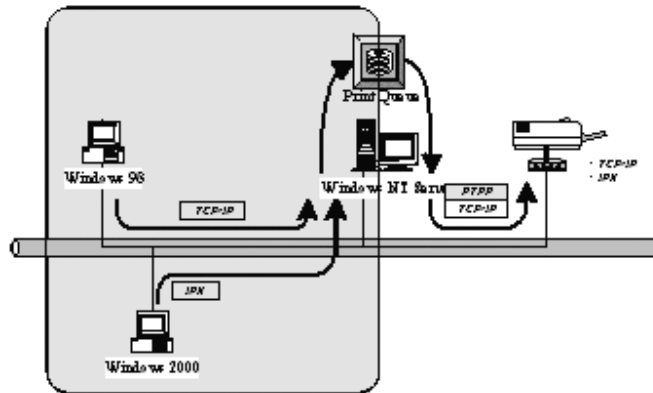

Step1.

If this is your first time installing print server, please install the administrator software on Windows NT/2000 server first. Refer to section 3.2 for installation instructions.

If your network has already installed a working print server and your Windows NT/2000 server has not yet installed the PTPP driver, please install the client software. Refer to section 3.4 for installation instructions.

Step2.

Please add/configure the Peer-to-Peer Printing of the Windows NT/2000 network printer and verify that you can print from Windows NT/2000 to the print server by the installed PTPP driver.

Step3.

Share the above server's printer to the network by performing the standard Windows printer sharing process.

4.3 User Installation and Setup

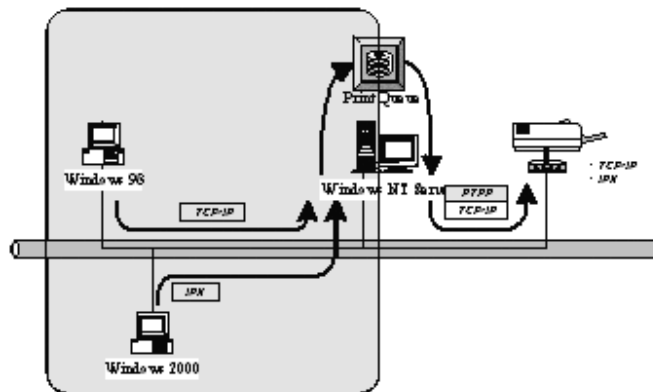

After server side's installation is completed, client side will be able to find the server's shared printer in Network Neighborhood. You only need to perform Window's standard **Add New Printer** procedure, select **"Network Printer"** shown in the screen below, and complete the configurations afterwards to access the shared printer.



Chapter 5 NetWare Network

5.1 System Architecture

We implement NetWare print sharing functionality into the print server itself, thus allowing one or more printers attached by a print server to be connected to the network.

Embedded print server, which emulates the “queue management functionality” of NetWare print server, PSERVER program running on the NetWare server. A user first prints a job at a workstation, the job is routed to a NetWare server, the NetWare server stores the job in a print queue, then the print server gets the print job from the queue to printers.

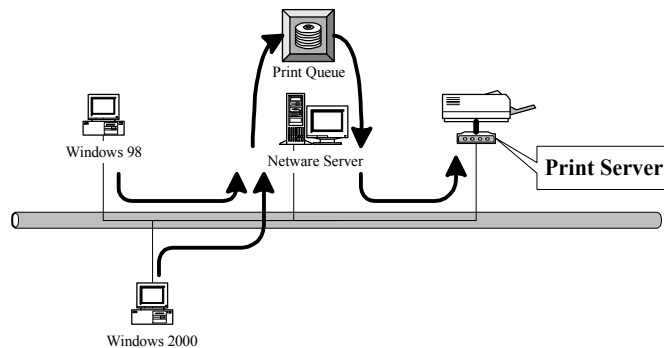

Compare with NetWare printing functionality, the advantages of embedding the NetWare network printing functionality in the print server include:

- Installation is easier and quicker
- Network management is easier
- Printing performance is enhanced
- Relieve NetWare file server's burden
- Relieve the need of a workstation running the remote printer utility
- Improve productivity by locating the printer near the workgroup

Each print server should log into a NetWare server before servicing the print jobs. Each print server will occupy a user account with which it can log into the NetWare server.

5.2 NetWare 3.x/4.x/5.x Installation & Setup

Once your print server is connected to your Ethernet network, you can set it up for use with our configuration utility.

Please note that, you need to install the IPX protocol before the following procedure,

1. Run NetWare's PCONSOLE program to create a NetWare print server and print queue with the appropriate names.

2. Refer to section 7.7 and use print server configuration utility, to configure print server attach to NetWare server print queue. Print server will get the print job from the print queue and print.

5.2.1 Installation with Pconsole

1. Run the NetWare PCONSOLE program.
2. Change the current file server, if necessary, using the Change Current File Server menu selection.
3. Choose the Print Queue Information menu selection.
4. Press the Insert key to add a new print queue.
5. Type in a print queue name, such as "PQ" or "Q1".

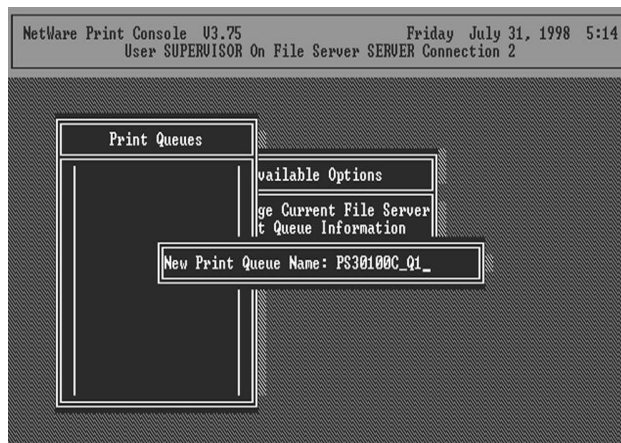

6. You have now successfully created the print queue that your print server will serve. Press the Escape key until the Available Options main menu is displayed.
7. Select Print Server Information.
8. Press the Insert key to add a new NetWare print server object. The print server name can be identical to the PSxxxxxx name printed on the label of the print server.

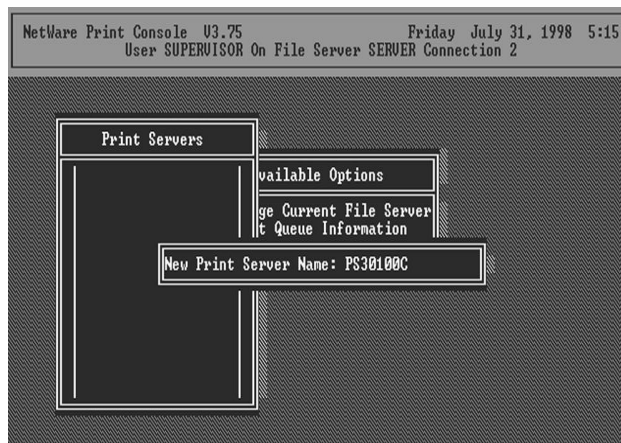

9. Press Enter to select the newly created print server.
10. Select Print Server Configuration.

11. Select Printer Configuration.
12. Select Printer 0 (or Printer 1, Printer 2), and press Enter, then select Parallel LPT1 (or LPT2, LPT3) in the Type field. If your print server is with only one port, you do not need to configure this Type field.

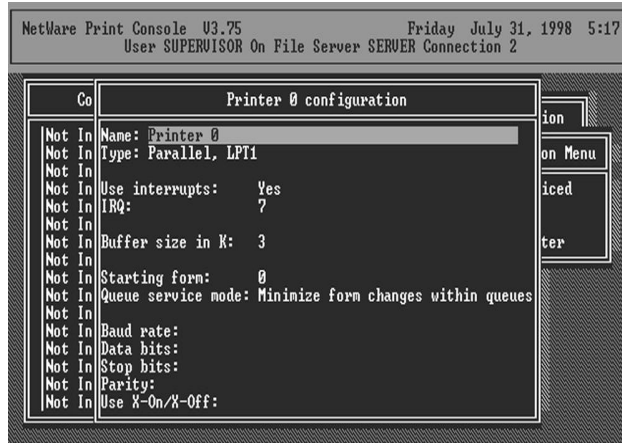

13. Press Escape, and answer Yes to the Save Changes question.
14. Select Queues Served by Printer, then select Printer 0 (or Printer 1, Printer 2) and press Enter.
15. Press *Insert* key and add your newly created print queue to the list of queues served by the printer. Enter a priority number for the queue service, or press Enter to accept the default.

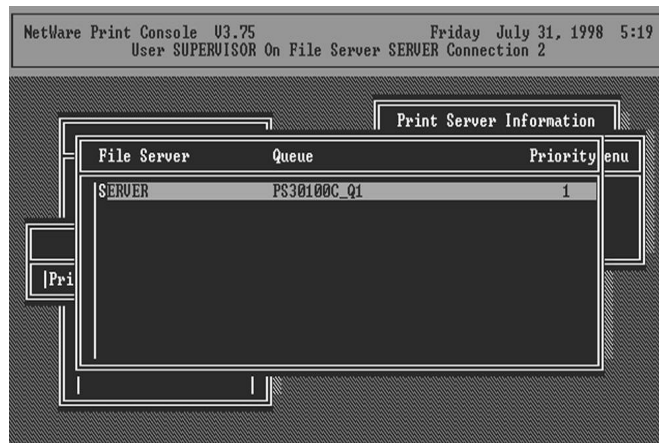

16. Repeatedly press Escape to exit the PCONSOLE program.
17. After setup the NetWare server. Please write down those settings and refer to section 7.7 to enter the settings of print server.

NOTE: If the print server you have is with multiple printer connectors, you may create multiple print queues and printer objects.

Your print server should now be ready to use. You should be able to redirect printing to your print server using a CAPTURE command such as the one shown in the previous section.

Chapter 6 UNIX System Network

6.1 Introduction

The print server is available for TCP/IP printing by Unix LPD (Line Printer Daemon) protocol. The LPD protocol originated with Unix release is based on the BSD version of Unix and supported under most versions of Unix.

This chapter explains how to configure the print server for TCP/IP operation, and how to modify configuration files on your Unix system to allow printing to the print server. The configuration examples in this manual follow the syntax for BSD based Unix systems. Please refer to the related system documentation for the correct syntax of your systems.

To configure the print server for LPD printing, perform the procedures below:

1. Enable Print Server's TCP/IP Support.
2. Set up Print Server's IP address.
3. Verify Print Server's IP Address.
4. Configure remote LPD printing on the host.
5. Print a test page.

In the next sections, we will describe these five procedures step by step.

6.2 Enable Print Server's TCP/IP Support

The default configuration of the print server is with TCP/IP support enabled. Anyway, you can configure the print server to enable TCP/IP support using the configuration program or PSETUP program in our CD-ROM included with the Print server.

6.3 Setup Print Server's IP Address

The print server must have a unique IP address in order to be recognized by the network. You can set up the IP address on the various Unix systems using any one of the following methods:

1. DHCP (Dynamic Host Configuration Protocol)
2. BOOTP (Bootstrap Protocol)

The print server will use the last three methods to obtain its IP address automatically if its IP address is configured as Auto (0.0.0.0).

6.3.1 DHCP

There are many Unix systems that support DHCP protocol, and the procedures to configure the DHCP server database are different. This manual does not describe the DHCP server configuration on the Unix systems. It is highly recommended that the DHCP server should be located on the same network as the print server.

6.3.2 BOOTP

If you have the BOOTP daemon, `bootpd`, running on your UNIX system that is accessible by the print server, you can use the BOOTP protocol to set up the IP address of the print server. We recommend that the BOOTP server should be located on the same subnet as the print server. If you use Network Information Services (NIS) in your system, you may need to rebuild the NIS map with the BOOTP services before doing the following BOOTP configuration. To rebuild the NIS map, please refer to your system documentation.

To configure the IP address data for the BOOTP server, you will need to log in the host of BOOTP server as the superuser (`root`). Perform the following steps to add address entries.

1. Optionally, assign a name corresponding to the print server's IP address. You can add this address to the `/etc/hosts` file, by adding a line such as:

```
203.66.191.12      pserver
```

2. Add an entry to the host's `/etc/bootptab` file, similar to the following:

```
hostname:\

:ht=1:\

:ha=print_server_ethernet_address:\

:ip=print_server_ip_address:
```

Lines should be indented with tabs.

Where `hostname` is the device name of a print server, the `ht=1` tag specifies the hardware type is Ethernet, the `ha=` tag specifies the Ethernet address of a print server, which is the Node ID located on the print server. The `ha` tag must be preceded by the `ht` tag. The `ip=` tag should correspond to the IP address you want to assign to the print server.

For example, a print server with the following configuration:

Node ID: 0000B4010101 (this implies Ethernet address is 0000B4010101),

IP address: 203.66.191.12

The entry for this print server in the `/etc/bootptab` file should be:

```
PS010101:\

:ht=1:\

:ha=0000B4010101:\

:ip=203.66.191.12:
```

6.4 Verify Print Server's IP Address

To verify that your print server is responding to the newly assigned IP address using a PING command:

```
ping ip-address
```

6.5 Configure Remote LPD Printing on the Host

The procedure you use to configure your Unix host(s) to allow printing to your network remote print server varies between different varieties of Unix. The procedure below can be used for Unix variants that are related to BSD Unix, such as SunOS or Linux. For other versions of Unix, consult your system documentation, keeping in mind that:

1. The print server should be treated as a BSD networked print server host.
2. The host name should be the name (or IP address) that you have assigned to the print server.
3. The printer name (or queue name) on the remote host should be lpt1, lpt2 or lpt3, the name of the printer port on the print server.

You will need to perform the tasks below, logged in as the superuser (root). To configure your Unix host for printing,

1. Optionally, assign a name corresponding to the print server's IP address. You can add this address to the /etc/hosts file, by adding a line such as:

```
203.66.191.186      pserver
```

2. Create a spool directory for the printer in the same directory where spool directories are normally kept on the machine, such as /var/spool or /var/spool/LPD:

```
mkdir /var/spool/LPD/pserverd
```

```
chown daemon /var/spool/LPD/pserverd
```

```
chgrp daemon /var/spool/LPD/pserverd
```

```
chmod 775 /var/spool/LPD/pserverd
```

3. Add an entry to the host's /etc/printcap file, similar to the following:

```
printer-name:\
:lp=\
:rm=203.66.191.186:\
:rp=lpt1:\
:lf=/var/spool/LPD/pserverd.log:\
:sd=/var/spool/LPD/pserverd:\
:mx#0:
```

Lines should be indented with tabs. More than one printer name can be used, with variants separated by vertical bars (name1|name2).

The `rm=` entry should correspond to the IP address you have assigned to the print server. You can also use a host name if you have assigned one in the `/etc/hosts` file.

The `sd=` entry should correspond to the spool directory you created in the previous step.

The `rp=` entry should correspond to the port name of the remote printer. The values should be one of `lpt1`, `lpt2` or `lpt3` depends on the printer port.

The print server should now be available for printing from your Unix host.

Chapter7 Configuration Utility

7.1 Introduction

This chapter introduces print server's system configuration utility in Windows environment. This utility is automatically installed during Windows Administrator Utility installation procedure - refer to section 3.2 and 3.3.

This utility provides the most complete management and configuration functions on the print server side. This utility only provides configuration functions for print server itself; it does not include configuration functions for client side or other file server or NetWare server in the network environment.

The Configuration Utility provides the following configuration and management functions:

Search Print Server: Search All Available Printer Servers on the Network

Print Server Status: Print Server Network Status

General Configuration: General Information of print server

TCP/IP Configuration: IP Address and DHCP Server Configuration

NetWare Configuration: NetWare Printing Configuration

AppleTalk Configuration: AppleTalk Protocol Setting

System Configuration: Print Server Network Ability Setting and Firmware Upgrade

SNMP Configuration: SNMP monitor configuration

Setup Wizard: Guide You Through All the Settings

Report: List the Status of All Available Print Servers on the Network

We will explain each function separately in the following section.

7.2 Search – Search for All Available Print Server

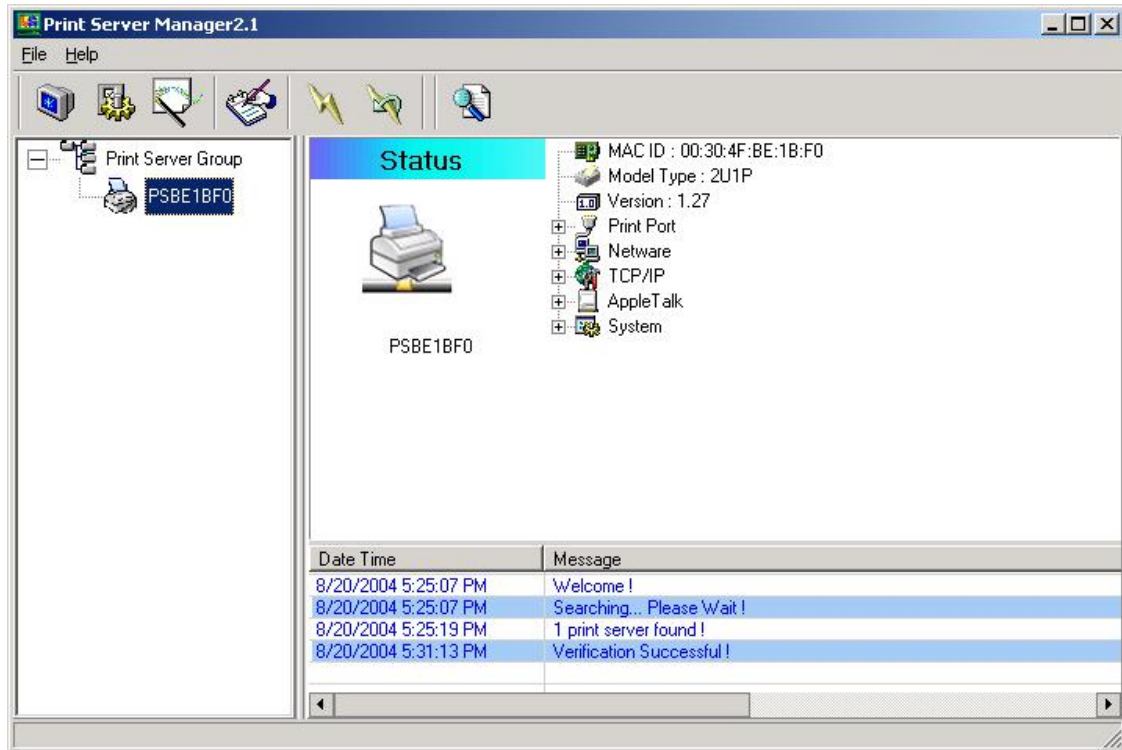

Every time when you run print server's configuration utility, click the "Search" icon  on the tool bar. The configuration utility will delay for several seconds because the utility is using system's available network protocols to search for all print servers on the network. All available print servers will be listed under "Print Server Group" on the left side of the window.

You must select the print server you would like to configure from the list. The system will, at the same time, display the selected print server's status on the right side of the window.

7.3 Status - Status of Print Server

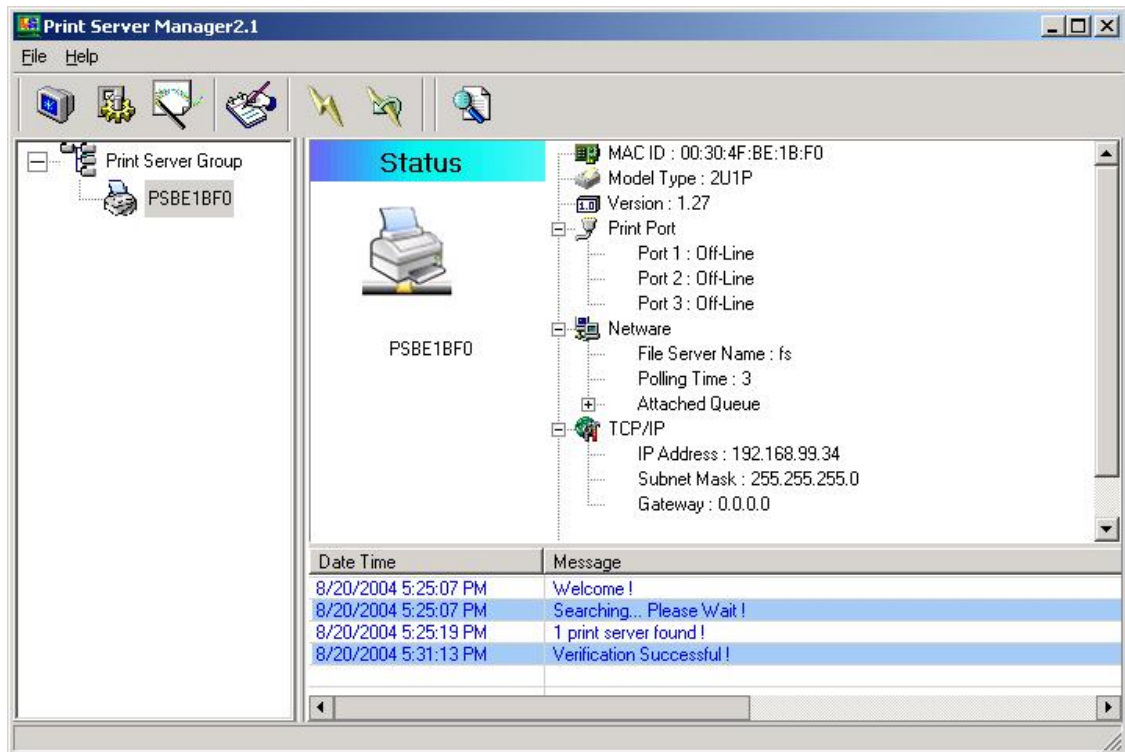

Click "Status" icon  on the tool bar, the status of the current selected print server will be shown on the right side of the window.

The information of the print server displayed are MAC ID, model type, firmware version, status of each printer port, NetWare file server name, NetWare file server polling interval, NetWare printer queue names, IP address, subnet mask, default gateway, AppleTalk printer type, AppleTalk zone and print server printing ability...etc.

You can refresh the print server's status by pressing the "Refresh" icon .

You can restart the print server by pressing the "Reboot" icon .

7.4 Setting up the Print Server

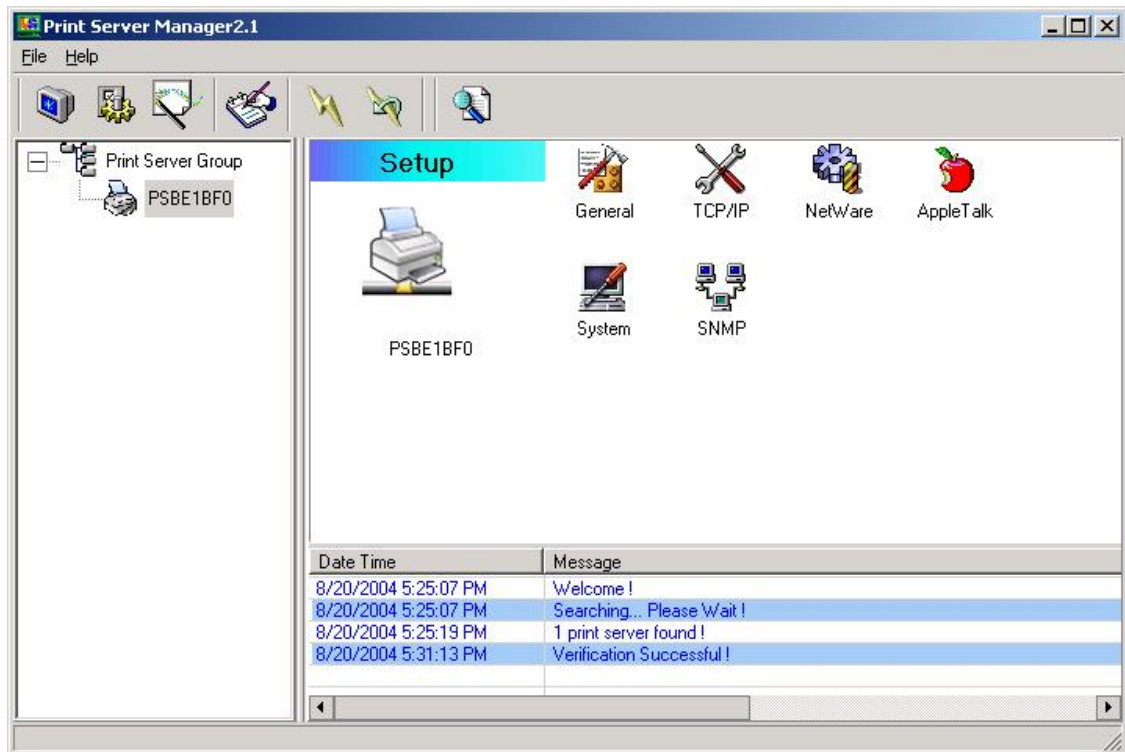

Click "Setup" icon  on the tool bar, the setup items of the current selected print server will be showed on the right side of the window.

You can modify all settings of the print server here.

When you first time into one the configure options, system will ask you enter User Name and Password. The default User Name and Password are "admin".

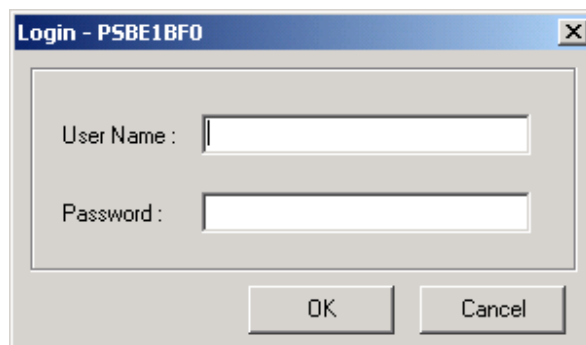

7.5 General Configuration

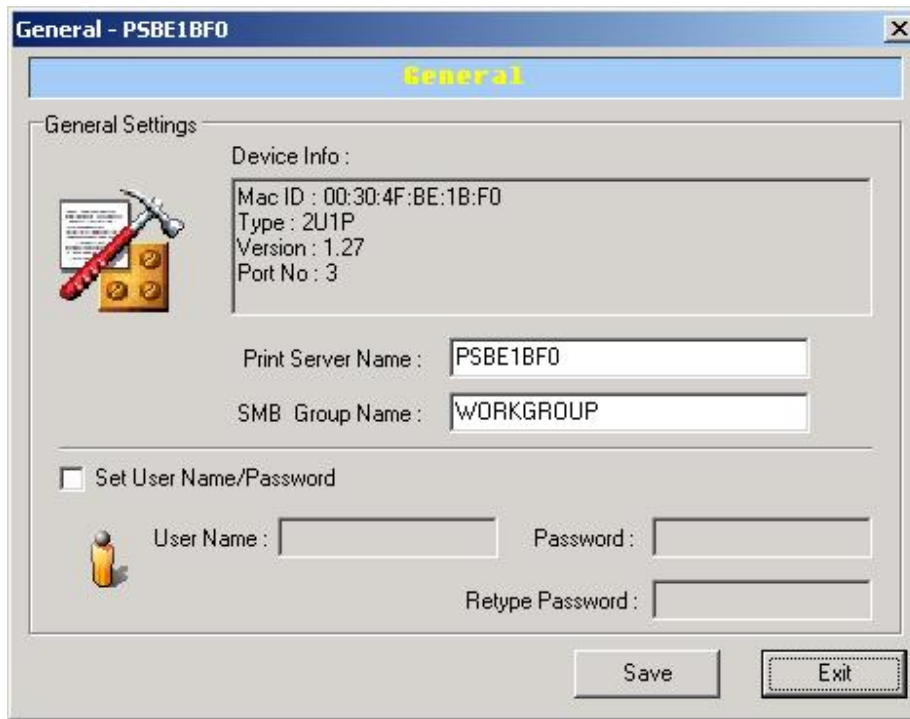

Double Click “General” icon and the General configuration window will pop-up.

You can see basic print server information in this page. You also can configure the “Print Server Name”, “User Name” and “Password” here.

Printer Server Name: Name of the print server. You can use this name to identify the print server when you are searching for the print server by the administration and client utilities.

SMB Group Name: Name of your network. PCs can find this printserver in Network Neighbor and attach to this printserver as a Network Printer when they are in the same Workgroup

User Name / Password: You can change the User Name and Password as your mind. Before changed, it will keep use default value.

7.6 TCP/IP Configuration

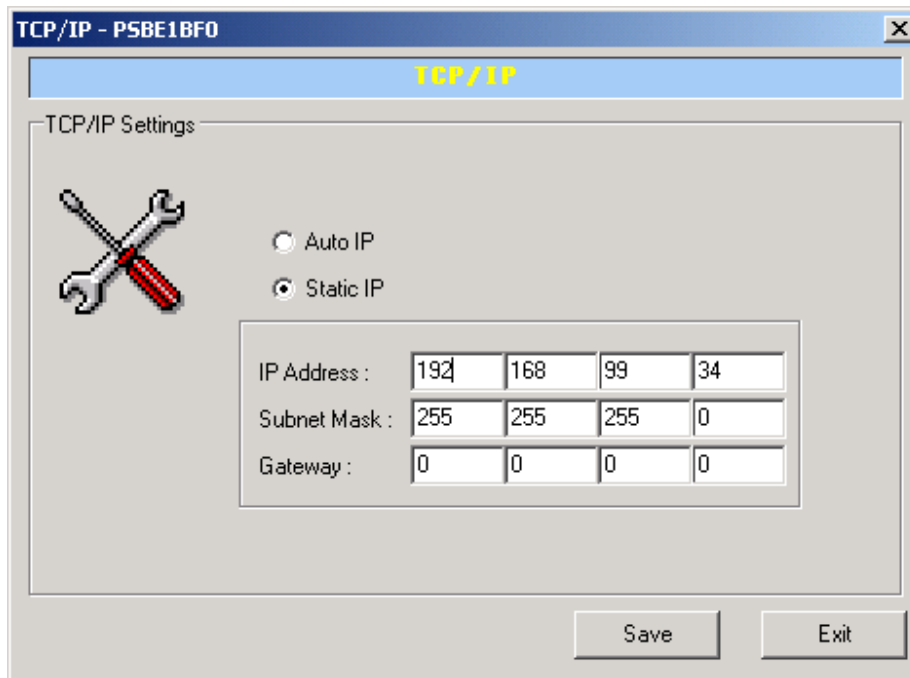

Double Click “TCP/IP” icon and the TCP/IP configuration window will pop-up.

If there is a DHCP Server in your LAN. You can configure the print server to automatically obtain an IP address from DHCP server. Or you can manually specify a static IP address to this print server .

If you need the print server to automatically obtain an IP address from LAN DHCP server, select “Auto IP”. Or you can select “Specify IP” to manually assign “IP Address”, “Subnet Mask” and “Gateway” for the print server.

7.7 Netware Configuration

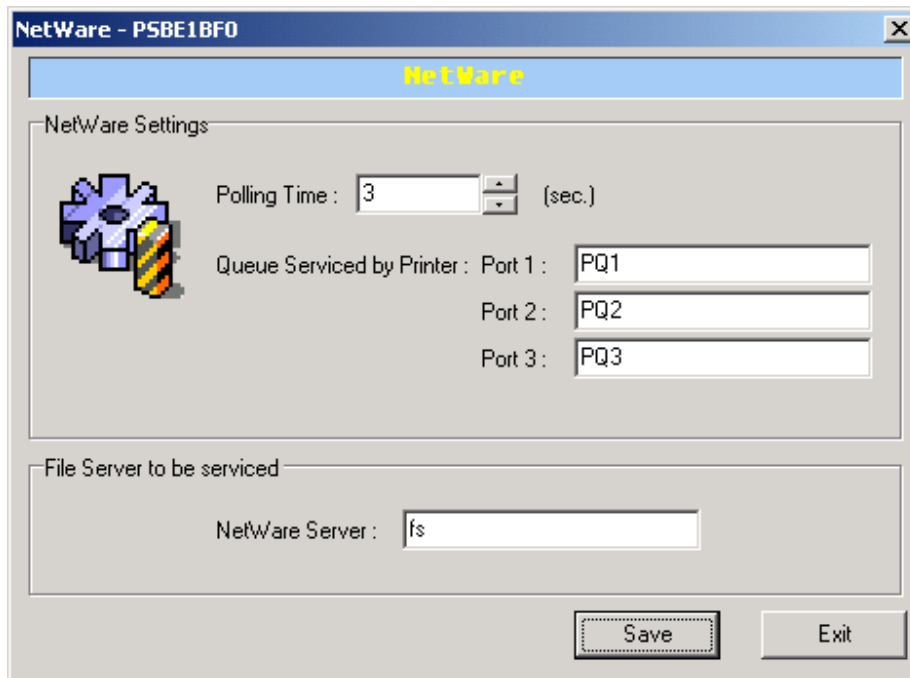

Double Click “NetWare” icon and the NetWare configuration window will pop-up.

This print server supports NetWare Bindery Printing method. The print server periodically polls the NetWare server printer queues for printing jobs. You have to assign the NetWare server name, print server polling interval and the name of queue on the NetWare server for each printer port.

Polling Time is the polling interval of the print server for waiting printing jobs on the NetWare server. Default is 3 seconds.

Attached Queue is the name of the printer queue on the NetWare server. The printer queue keeps all printing jobs waiting on the NetWare server. You have to assign a printer queue for each printer port of this print server.

NetWare Server is the name of the NetWare file server that provides printer queues.

7.8 AppleTalk Configuration

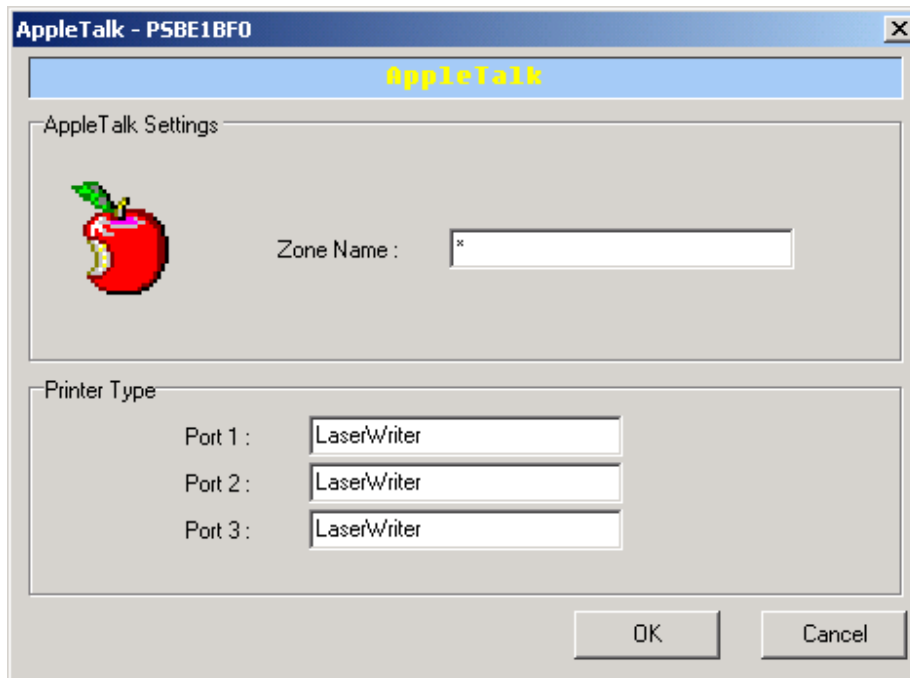

Double Click “AppleTalk” icon and the AppleTalk configuration window will pop-up.

AppleTalk is a data communication protocol often used by Macintoshes. The print server can use these parameters to join the AppleTalk network and share the printer to other AppleTalk workstations. You have to setup the “Zone Name” and “Printer Type” for each printer port of this print server.

Zone Name: Print server has to join zones of AppleTalk before it can be shared to other workstations. Only workstations in the same zone can share the printer. If you want to share the printer to all workstations in all Zones, you should enter only “*” in the “Zone Name” field.

Printer Type, the type of printer attached to each printer port. You can get the printer type from the manufacturer of the printer.

7.9 System Configuration

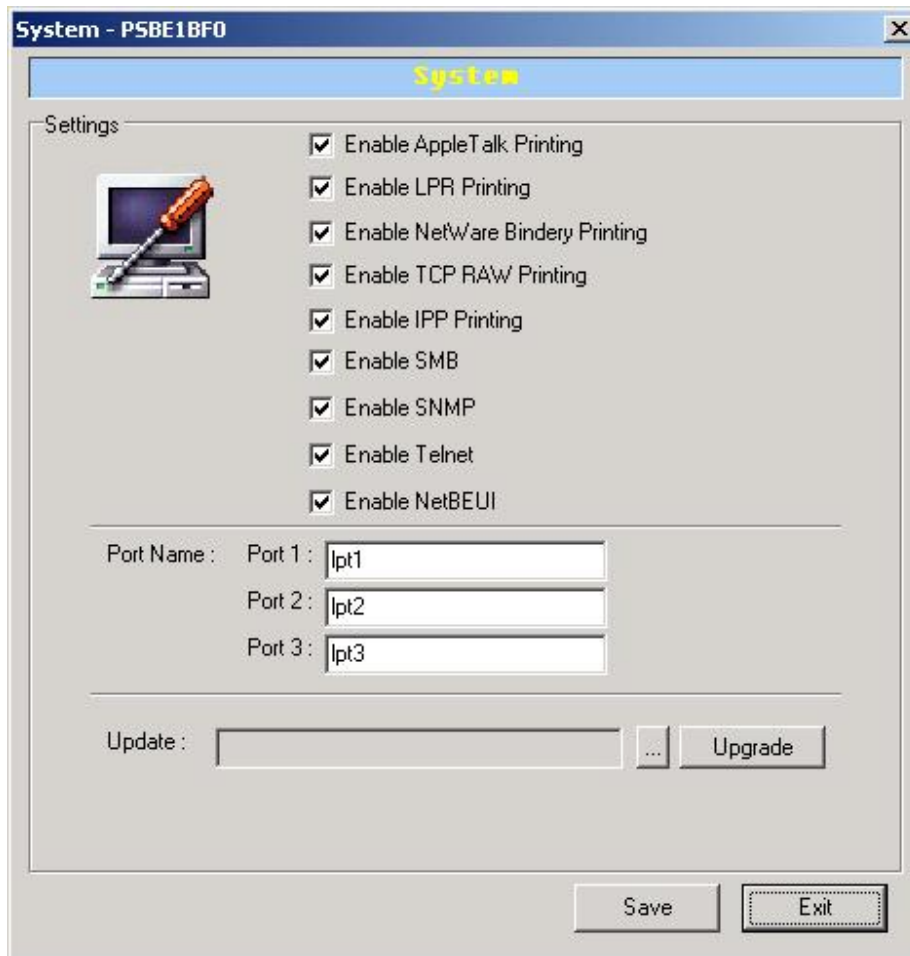

Double Click "System" icon and the System configuration window will pop-up.

In the System configuration page, you can select to enable/disable each printing protocol, assign name for each printer port of this print server and upgrade the new firmware for this print server.

Port Name is the name of the printer port. Each printer port has to be assigned a name. The client utility uses this name to access the printer port.

Upgrade Firmware: You can use this "Upgrade" tool to update the newest firmware of the print server. Click  button and select the correct firmware in you PC's storage. After selecting the firmware file, click the "Upgrade" button and wait for finish the firmware update process.

7.10 Wizard

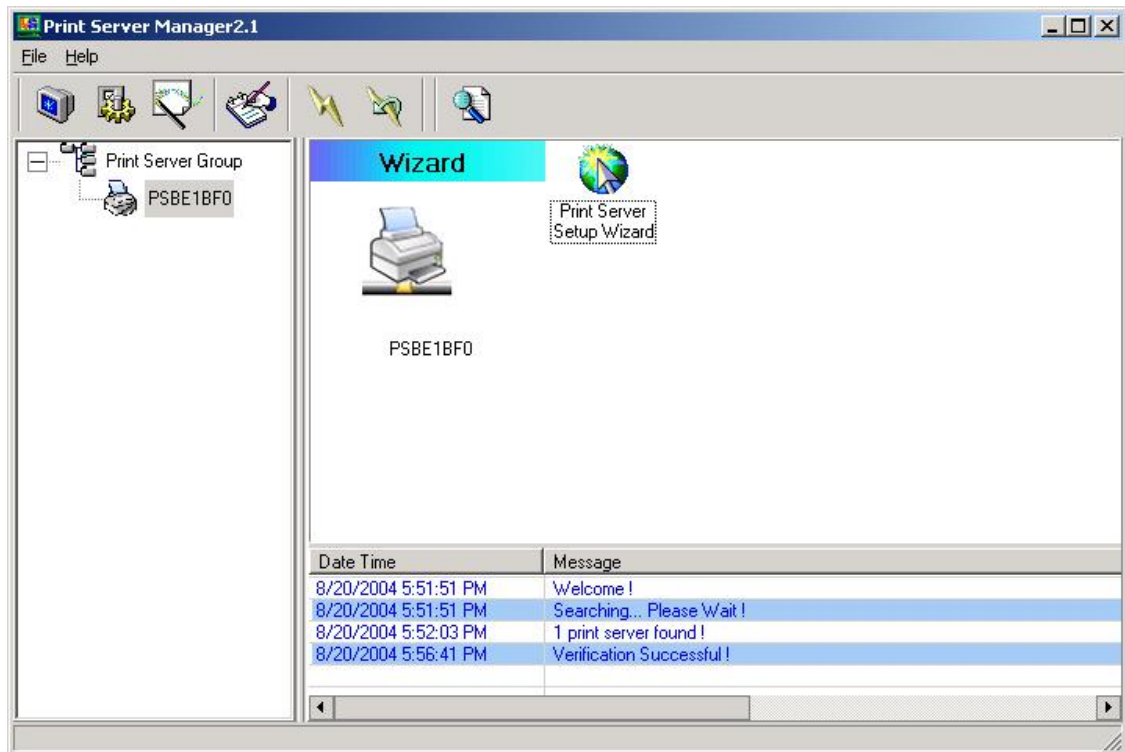

Click "Wizard" icon  on the tool bar, the setup wizard item of the current selected print server will be showed on the right side of the window. Double click the "Print Server Wizard", the setup wizard will guide you through all the setup process from next page.

Step 1: Setup the Print Server Name and SMB Group Name of this print server and the name of each printer port. Please refer to section 7.5 and 7.9 for detail information.

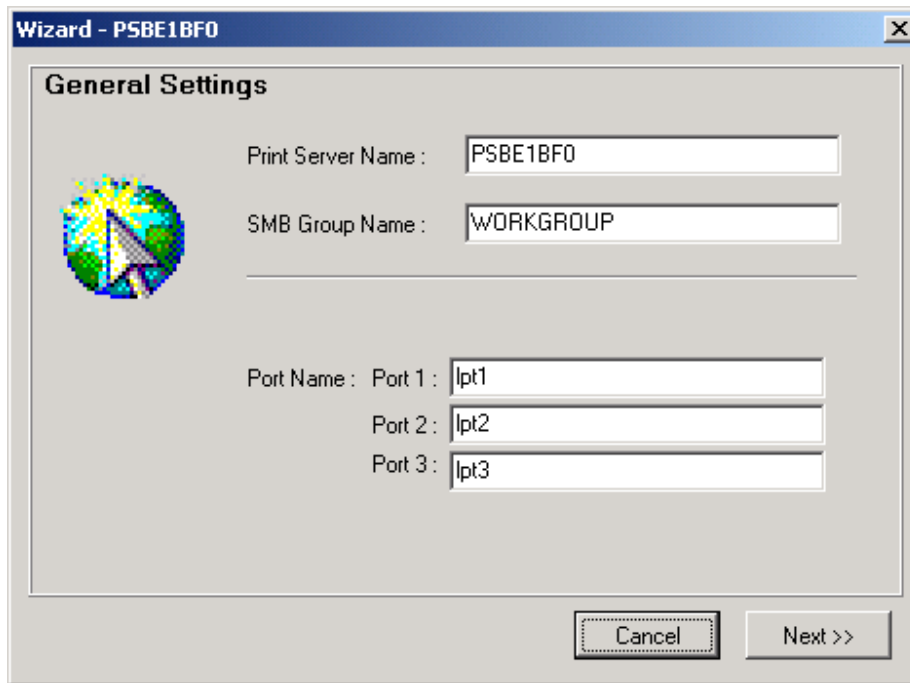

Step 2: Select to enable required printing protocol. Please refer to section 7.9 for detail information.

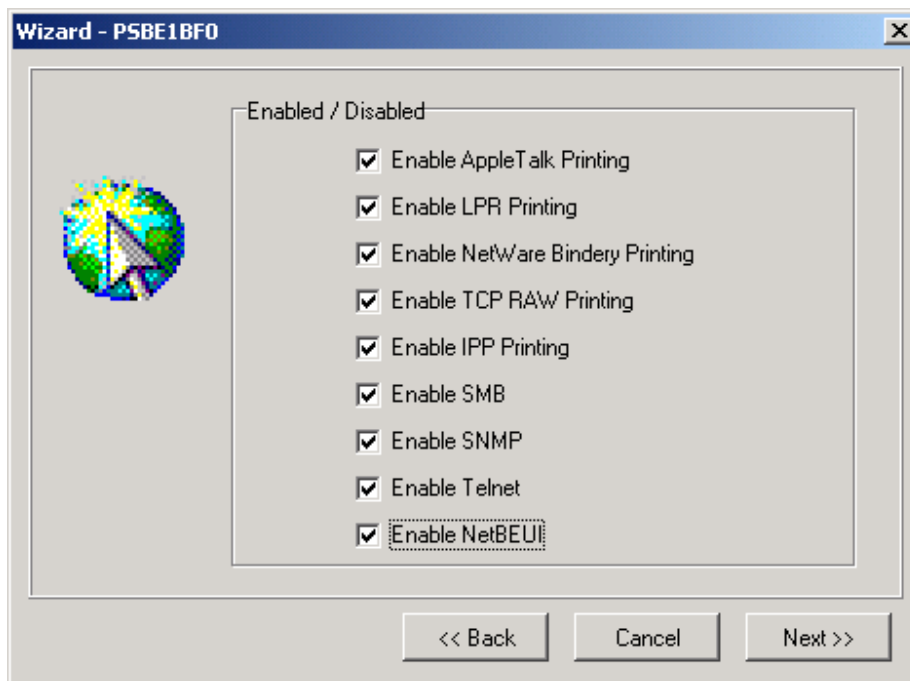

Step 3: Setup the IP of this print server. Please refer to section 7.6 for detail information.

TCP/IP - PSBE1BF0

TCP/IP

TCP/IP Settings



Auto IP

Static IP

IP Address : 192 168 99 34

Subnet Mask : 255 255 255 0

Gateway : 0 0 0 0

Save Exit

Step 4: Setup the NetWare printing. Please refer to section 7.7 for detail information.

Wizard - PSBE1BF0

Netware Settings



Polling Time : 3 (sec.)

Queue Served by Printer : Port 1 : PQ1

Port 2 : PQ2

Port 3 : PQ3

File Server to be serviced :

NetWare Server : fs

<< Back Cancel Next >>

Step 5: Setup the AppleTalk printing. Please refer to section 7.8 for detail information.

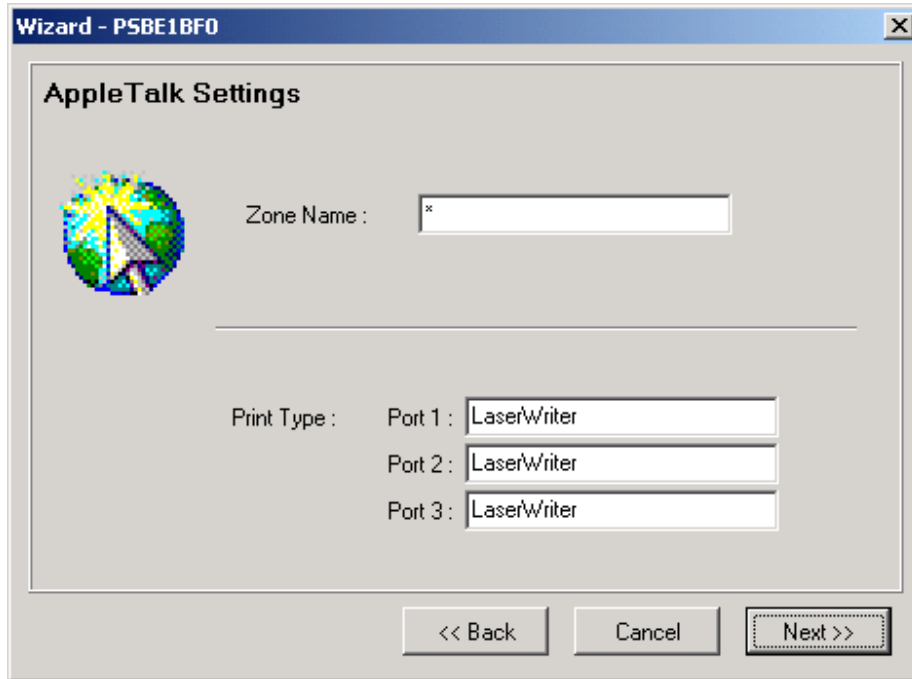

Step 6. Setup Status Summary. This screen will show you the total settings of this print server. If those settings are correct, please press "Set" for next step to save the settings or press "Cancel" or "<<Back" button to modify the settings as you need.

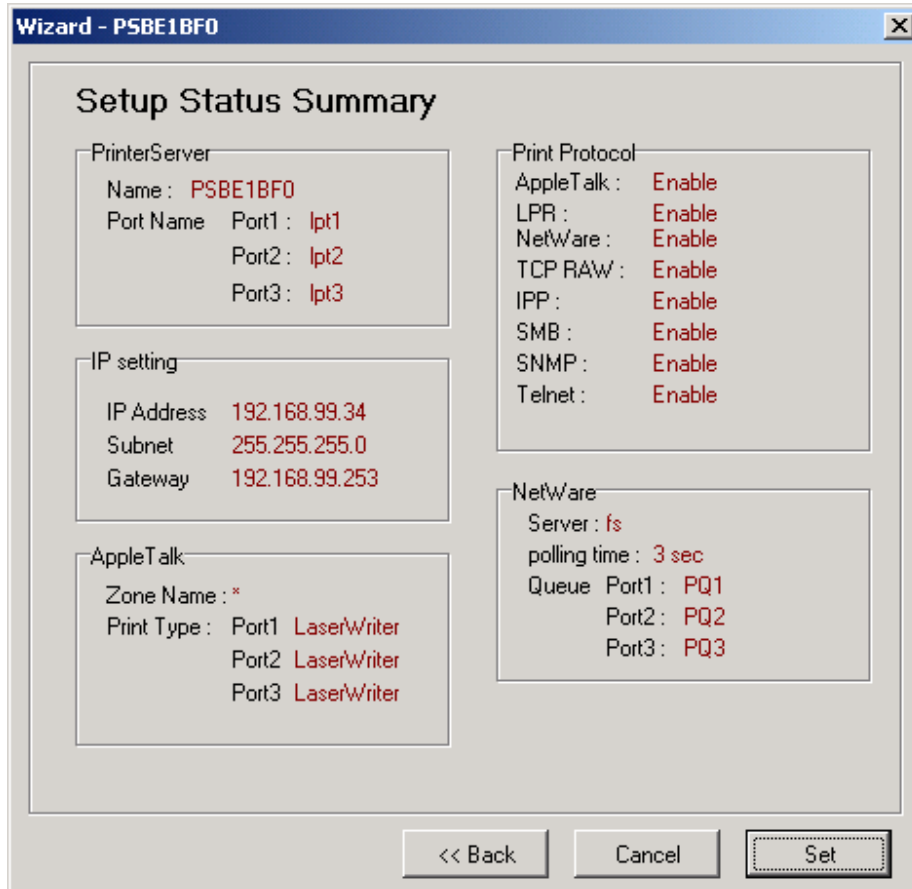

Step 10. Please press "Yes" to save the settings.

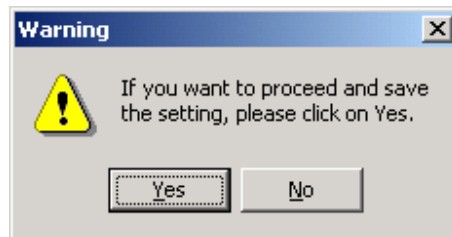

Chapter8 Web Management

8.1 Introduction

Print server can be configured and managed on the web browser. Through Local Area Network, or even Internet when this print server has an legal IP address. Administrator can easily configure and manage print server's various main functions in web browsers. Simply enter print server's IP address into your browser's address field to manage a print server by print server's built-in Web Server.

8.2 Web Management of Print Server

8.2.1 Login

You may use any Web Browser to review the status or configure the settings of the print server. After entering the IP address of the print server, a login dialog box display. You have to enter correct "User Name" and "Password" before going to the Web Management pages.

Notes: Default User Name is "admin", default password is "admin".

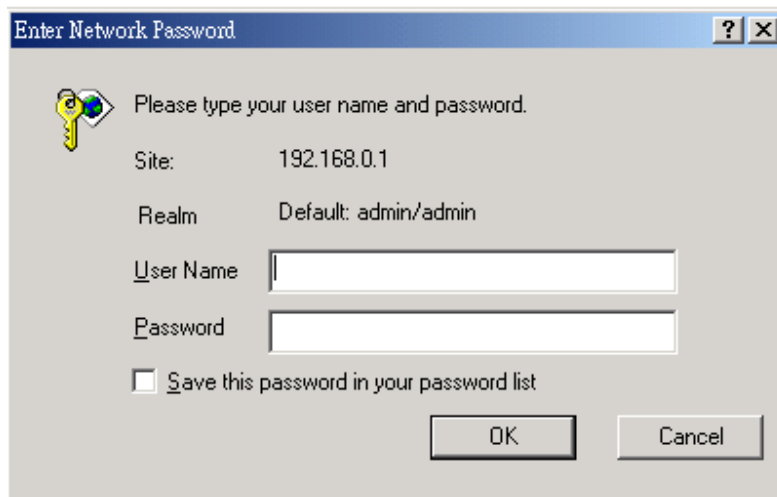

Enter Network Password

Please type your user name and password.

Site: 192.168.0.1

Realm: Default: admin/admin

User Name

Password

Save this password in your password list

OK Cancel

8.3 Device Status

8.3.1 System

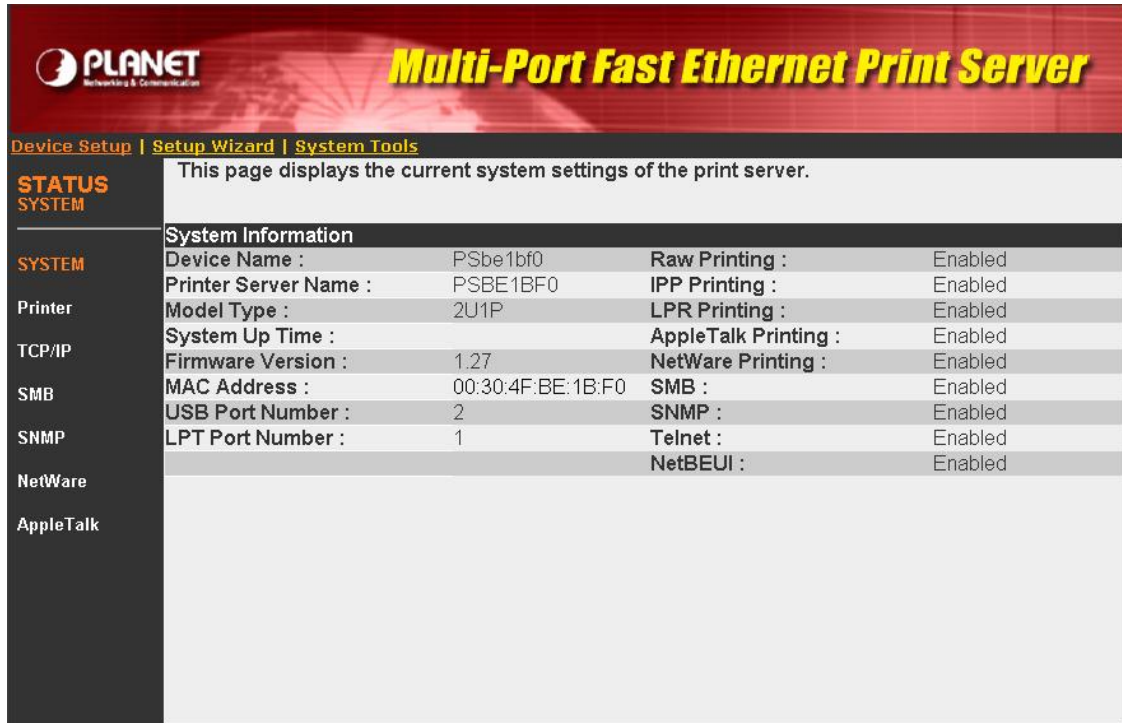

The screenshot shows the 'System Information' page of a Planet Multi-Port Fast Ethernet Print Server. The page has a red header with the Planet logo and the product name. Below the header, there are navigation links for 'Device Setup', 'Setup Wizard', and 'System Tools'. The main content area is titled 'STATUS SYSTEM' and contains a table of system settings. The table lists various parameters such as Device Name, Printer Server Name, Model Type, System Up Time, Firmware Version, MAC Address, USB Port Number, LPT Port Number, and various printing protocols (Raw, IPP, LPR, AppleTalk, NetWare, SMB, SNMP, Telnet, NetBEUI) and their status (Enabled).

System Information			
Device Name :	PSbe1bf0	Raw Printing :	Enabled
Printer Server Name :	PSBE1BF0	IPP Printing :	Enabled
Model Type :	2U1P	LPR Printing :	Enabled
System Up Time :		AppleTalk Printing :	Enabled
Firmware Version :	1.27	NetWare Printing :	Enabled
MAC Address :	00:30:4F:BE:1B:F0	SMB :	Enabled
USB Port Number :	2	SNMP :	Enabled
LPT Port Number :	1	Telnet :	Enabled
		NetBEUI :	Enabled

In this page, it will show you all the system information such as “Device Name”, “Print Server Name”, “Model Type”, “System Up Time”, “Firmware Version”, “MAC Address” and other information.

8.3.2 Printer

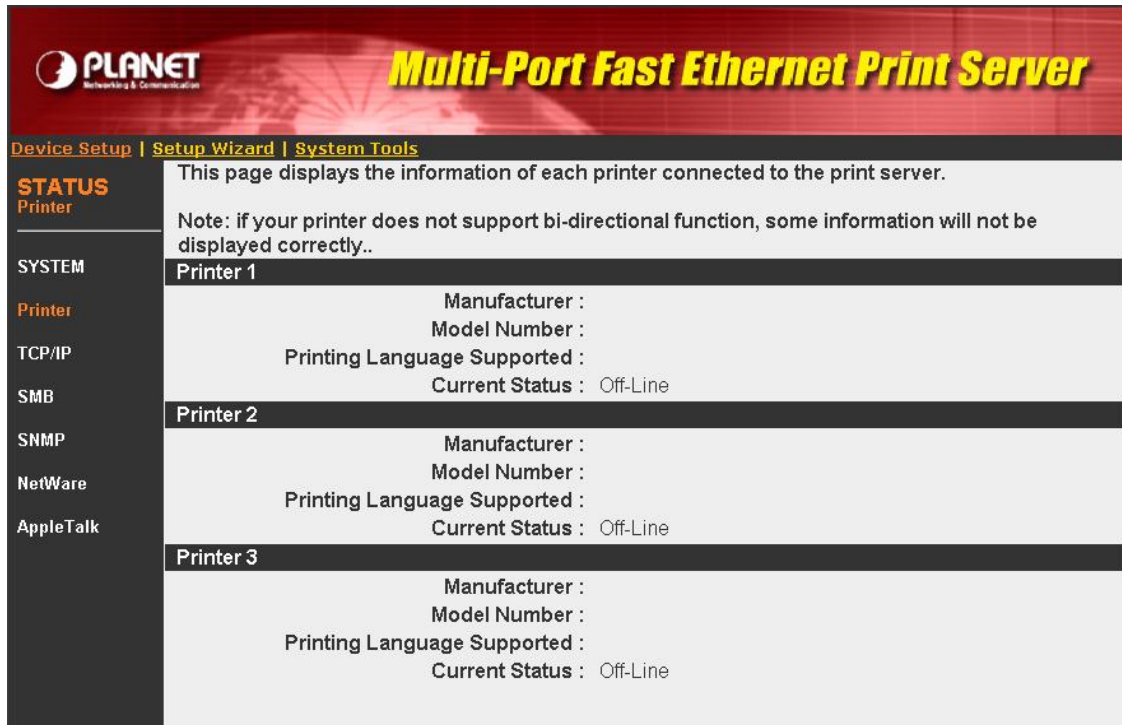

PLANET Networking & Communication **Multi-Port Fast Ethernet Print Server**

Device Setup | Setup Wizard | System Tools

STATUS
Printer

SYSTEM

Printer

TCP/IP

SMB

SNMP

NetWare

AppleTalk

This page displays the information of each printer connected to the print server.

Note: if your printer does not support bi-directional function, some information will not be displayed correctly..

Printer 1

Manufacturer :
Model Number :
Printing Language Supported :
Current Status : Off-Line

Printer 2

Manufacturer :
Model Number :
Printing Language Supported :
Current Status : Off-Line

Printer 3

Manufacturer :
Model Number :
Printing Language Supported :
Current Status : Off-Line

This page will display the information of printers connected to all printer ports.

8.3.3 TCP/IP

The screenshot shows the PLANET Multi-Port Fast Ethernet Print Server web interface. The top header includes the PLANET logo and the product name. Below the header, there are navigation links for "Device Setup", "Setup Wizard", and "System Tools". The main content area is titled "STATUS TCP/IP" and contains a sub-header "TCP/IP Settings". The settings displayed are:

- Use DHCP/BOOTP : OFF
- IP Address : 192.168.99.34
- Subnet Mask : 255.255.255.0
- Gateway : 0.0.0.0

A left sidebar contains a menu with the following items: SYSTEM, Printer, TCP/IP (highlighted), SMB, SNMP, NetWare, and AppleTalk.

This page lists all TCP/IP Settings, include "IP Address", "Subnet Mask" and "Gateway".

8.3.4 SMB

The screenshot shows the PLANET Multi-Port Fast Ethernet Print Server web interface. The top header includes the PLANET logo and the product name. Below the header, there are navigation links for "Device Setup", "Setup Wizard", and "System Tools". The main content area is titled "STATUS SMB" and contains a sub-header "SMB Settings". The settings displayed are:

- SMB Group Name : WORKGROUP

A left sidebar contains a menu with the following items: SYSTEM, Printer, TCP/IP, SMB (highlighted), SNMP, NetWare, and AppleTalk.

This page will show the SMB Group Name.

8.3.5 SNMP

The screenshot shows the Planet Multi-Port Fast Ethernet Print Server web interface. The top header features the Planet logo and the product name. Below the header is a navigation bar with links for Device Setup, Setup Wizard, and System Tools. The main content area is titled 'STATUS SNMP' and contains a description: 'This page displays the current SNMP settings of the print server.' Below this is a section for 'SNMP Settings' with two entries: 'SNMP System Contact : Disabled' and 'SNMP System Location : Disabled'. A left sidebar lists various system settings: SYSTEM, Printer, TCP/IP, SMB, SNMP (highlighted), NetWare, and AppleTalk.

This page will show the SNMP System Contact and SNMP System Location. If the settings are empty, this page will show you the settings “Disabled”.

8.3.6 NetWare

The screenshot shows the Planet Multi-Port Fast Ethernet Print Server web interface. The top header features the Planet logo and the product name. Below the header is a navigation bar with links for Device Setup, Setup Wizard, and System Tools. The main content area is titled 'STATUS NetWare' and contains a description: 'This page displays the current NetWare settings of the print server.' Below this are three sections: 'General Settings' with 'Polling Time : 3 seconds'; 'NetWare Bindery Settings' with 'Use Bindery Mode : Enable' and 'Name of the File Server : fs'; and 'NetWare Port Settings' with 'Port1 Attachd Queue : PQ1 (Off Line)', 'Port2 Attachd Queue : PQ2 (Off Line)', and 'Port3 Attachd Queue : PQ3 (Off Line)'. A left sidebar lists various system settings: SYSTEM, Printer, TCP/IP, SMB, SNMP, NetWare (highlighted), and AppleTalk.

This page lists NetWare settings, include “Polling Time”, “Use Bindery Mode”, “Name of the File Server” and “Queue Name of each Port”.

8.3.7 AppleTalk

The screenshot shows the configuration interface for a Planet Multi-Port Fast Ethernet Print Server. The top header includes the Planet logo and the product name. Below the header is a navigation menu with 'Device Setup', 'Setup Wizard', and 'System Tools'. The main content area is titled 'STATUS AppleTalk' and contains a description: 'This page displays the current AppleTalk settings of the print server.' Below this is a section for 'AppleTalk Settings' with the following details:

SYSTEM	AppleTalk Settings
Printer	AppleTalk Zone Name : *
TCP/IP	Printer 1
SMB	Printer Type : LaserWriter
SNMP	Printer 2
NetWare	Printer Type : LaserWriter
AppleTalk	Printer 3
	Printer Type : LaserWriter

This page lists AppleTalk settings, include “AppleTalk Zone Name” and “Printer Type of printers connected to all print ports”.

8.4 Setup Wizard

8.4.1 System

The screenshot shows the 'System Settings' page of the Planet Multi-Port Fast Ethernet Print Server Setup Wizard. The page has a red header with the Planet logo and the product name. Below the header, there are navigation links for 'Device Setup', 'Setup Wizard', and 'System Tools'. The main content area is titled 'System Settings' and contains a 'Print server Name' field with the value 'PSEBE1BF0', three 'PORT' name fields with values 'lp1', 'lp2', and 'lp3', and a 'Save & Next' button. A sidebar on the left lists various setup options: 'SYSTEM', 'TCP/IP', 'SMB', 'SNMP', 'NetWare', 'AppleTalk', and 'Save Settings'.

PLANET Networking & Communication **Multi-Port Fast Ethernet Print Server**

Device Setup | Setup Wizard | System Tools

SETUP SYSTEM

This Menu allows you to configure general system settings of the Print Server.

Click "Save and Next" to continue.

SYSTEM Settings

Print server Name :

PORT1 Name :

PORT2 Name :

PORT3 Name :

Save & Next

TCP/IP

SMB

SNMP

NetWare

AppleTalk

Save Settings

You also can configure the "Print Server Name", "User Name" and "Password" here.

Printer Server Name, the name of the print server. You can use this name to identify the print server when you are searching for the print server by the administration and client utilities.

Port Name: The name of the printer port. Each printer port has to be assigned a name. The printserver driver uses this name to access the printer port.

8.4.2 TCP/IP

The screenshot shows the configuration interface for a PLANET Multi-Port Fast Ethernet Print Server. The title bar includes the PLANET logo and the product name. The navigation menu on the left lists various setup options, with 'TCP/IP' selected. The main content area provides instructions for configuring TCP/IP settings and offers two options: enabling automatic settings (DHCP/BOOTP) or manually specifying IP Address, Subnet Mask, and Gateway. The IP Address field is pre-filled with 192.168.99.34, Subnet Mask with 255.255.255.0, and Gateway with 0.0.0.0. A 'Save & Next' button is located at the bottom of the configuration area.

PLANET Networking & Communication **Multi-Port Fast Ethernet Print Server**

Device Setup | Setup Wizard | System Tools

SETUP
TCP/IP

This Menu allows you to configure TCP/IP settings for the Print Server.

Click "Save and Next" to continue.

TCP/IP Settings

Enable Obtain TCP/IP settings automatically (use DHCP/BOOTP)

Disable Use the following TCP/IP settings

IP Address :

Subnet Mask :

Gateway :

Save & Next

SYSTEM
TCP/IP
SMB
SNMP
NetWare
AppleTalk
Save Settings

You can configure the print server to automatically obtain an IP address from your LAN DHCP server or manually specify a static IP address.

If you need the print server to automatically get an IP from DHCP server, select "Enable Obtain TCP/IP settings automatically". Or you can select "Disable Use the following TCP/IP settings" to manually assign IP Address, Subnet Mask and Gateway for the print server.

8.4.3 SMB

The screenshot shows the configuration interface for the Planet Multi-Port Fast Ethernet Print Server. The page title is "Multi-Port Fast Ethernet Print Server" and the Planet logo is visible. The navigation menu includes "Device Setup", "Setup Wizard", and "System Tools". The "SMB" section is active, showing instructions: "This page allows you to configure SMB settings for the Print Server. Click 'Save and Next' to continue." The "SMB Configure" section contains a dropdown menu for "SMB Enable" set to "Enabled" and a text input field for "SMB Group Name" containing "WORKGROUP". A "Save & Next" button is located below these fields. The left sidebar lists other configuration options: "SYSTEM", "TCP/IP", "SMB", "SNMP", "NetWare", "AppleTalk", and "Save Settings".

You may Enable/Disable the SMB Printing protocol of this print server. When this setting enable, you have to enter the SMB Group Name, you should set this name as your network PCs assigned. Then the PCs can find this printserver in Network Neighbor and attach to this print server as a Network Printer.

8.4.4 SNMP

The screenshot shows the configuration interface for the Planet Multi-Port Fast Ethernet Print Server. The page title is "Multi-Port Fast Ethernet Print Server" and the Planet logo is visible. The navigation menu includes "Device Setup", "Setup Wizard", and "System Tools". The "SNMP" section is active, showing instructions: "This page allows you to configure SNMP settings for the Print Server. Click 'Save and Next' to continue." The "SNMP Configure" section contains a dropdown menu for "SNMP Enable" set to "Enabled", and two text input fields for "SNMP System Contact" and "SNMP System Location". A "Save & Next" button is located at the bottom right of the configuration area. The left sidebar lists other configuration categories: SYSTEM, TCP/IP, SMB, NetWare, AppleTalk, and Save Settings.

This printserver has support SNMP protocol for users user SNMP management tool to monitor from a remote site. You can Enable this protocol and set the SNMP System Contact and SNMP System Location in this page.

SNMP System Contact: Text Field - Name of the contact person.

SNMP System Location: Text Field - Location of the contact person.

8.4.5 NetWare

The screenshot shows the configuration interface for the Planet Multi-Port Fast Ethernet Print Server. The interface is titled "Multi-Port Fast Ethernet Print Server" and includes a navigation menu on the left with options like "SETUP NetWare", "SYSTEM", "TCP/IP", "SMB", "SNMP", "NetWare", "AppleTalk", and "Save Settings". The main content area is titled "General Settings" and contains the following fields:

- NetWare Bindery Settings**
- Polling Time :** 3 seconds (min: 3, max: 29 seconds)
- Name of the File Server :** fs
- Attach Queue1 :** PQ1
- Attach Queue2 :** PQ2
- Attach Queue3 :** PQ3

A "Save & Next" button is located at the bottom of the configuration area.

This print server supports NetWare Bindery Printing method. The print server periodically polls the NetWare server printer queues for printing jobs. You have to assign the NetWare server name, print server polling interval and the name of queue on the NetWare server for each printer port.

Polling Time: The polling interval of the print server for waiting printing jobs on the NetWare server.

Name of the File Server: Name of the NetWare file server that provides printer queues.

Attached Queue: Name of the printer queue on the NetWare server. The printer queue keeps all printing jobs waiting on the NetWare server. You have to assign a printer queue for each printer port of this print server.

8.4.4 AppleTalk

The screenshot shows the configuration interface for the Planet Multi-Port Fast Ethernet Print Server. The page title is "Multi-Port Fast Ethernet Print Server" and the Planet logo is visible. The navigation menu includes "Device Setup", "Setup Wizard", and "System Tools". The "AppleTalk" section is active, showing instructions to configure AppleTalk settings. A "Save & Next" button is located at the bottom of the form.

Planet Networking & Communication
Multi-Port Fast Ethernet Print Server

Device Setup | Setup Wizard | System Tools

SETUP
AppleTalk

SYSTEM
TCP/IP
SMB
SNMP
NetWare
AppleTalk
Save Settings

This page allows you to configure AppleTalk settings for the Print Server.
Leave the settings boxes blank and Click "Save & Next" if you don't use the AppleTalk protocol.

Apple Talk Settings

AppleTalk Enable :

AppleTalk Zone Name :

Printer 1
Printer Type :

Printer 2
Printer Type :

Printer 3
Printer Type :

Save & Next

AppleTalk is a data communication protocol often used by Macintoshes. The print server can use these parameters to join the AppleTalk network and share the printer to other AppleTalk workstations. When you select "Enable", you have to setup the "Zone Name" and "Printer Type" for each printer port of this print server.

Zone Name: Print server has to join zones of AppleTalk before it can be shared to other workstations. Only workstations in the same zone can share the printer. If you want to share the printer to all workstations in all Zones, you should enter only "*" in the "Zone Name" field.

Printer Type, the type of printer attached to each printer port. You can get the printer type from the manufacturer of the printer.

8.5 System Tools

8.5.1 Load Default



You can restore print server to factory default settings in this screen. All of your previous configuration will be cleared.

8.5.2 Upgrade Firmware



You can upgrade new firmware for this print server in this screen. Click "Browse..." button to locate the new firmware and then click "OK", the firmware will be updated in several minutes.

Chapter9 IPP Printing

9.1 Introduction

IPP (Internet Printing Protocol) Printing provides a convenient way of remote printing service by TCP/IP. The print server can support IPP printing by default. It is needless to do any setting. Any PC that can support IPP printing, for example Windows 2000/XP, can directly uses the print server by IP. By using the IPP printing, you can share the printer to all the PC's that can access the print server by IP. You can even share your printer to Internet users.

9.2 System Setup

9.2.1 Print Server Side

It is needless to do any setting on the print server side. Make sure the print server has correct IP settings. If you want to share the printers to Internet users, you have to set a real IP to the print server. You also have to make sure that any gateway, router or firewall does not block IPP protocol if you have these gateway devices installed in your network.

9.2.2 Client Side

You only need to perform Window's standard **Add New Printer** procedure, select "**Network Printer**" shown in the screen below and click "Next >".

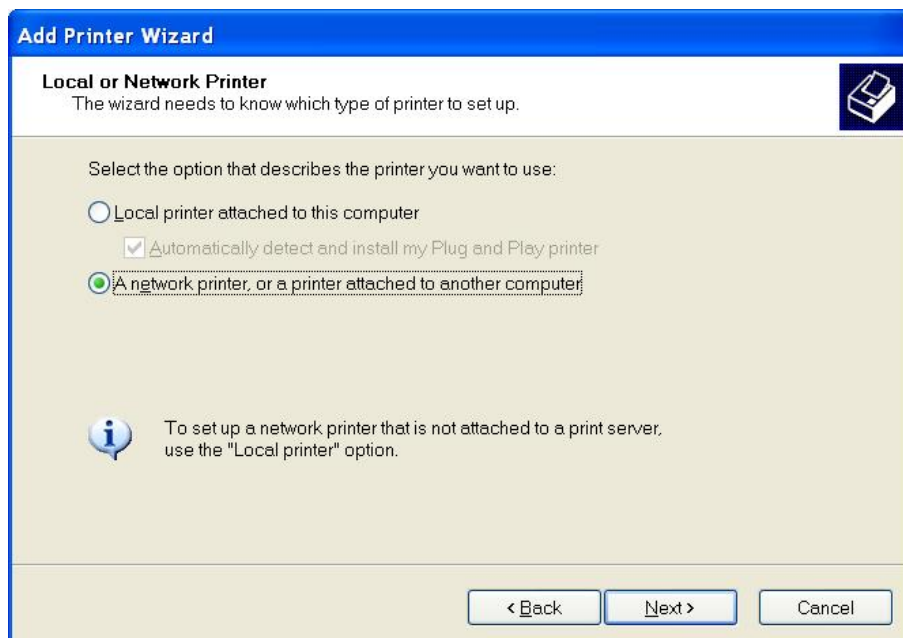

Select "Connect to a printer on the Internet or on a home or office network" and enter the URL of print server. The URL format is "http://IP/LPT_PORT:631". The IP should be the print server's IP. LPT_PORT is the port name of print server that your print is connected to. For the one port print

server, the port name is "lpt1". For the three port print server, the port name is one of the three – lpt1, lpt2 or lpt3. The last number 631 is IPP standard port number. One example of the URL is "http://192.168.12.13/lpt1:631". After entering the URL of print server, click "Next >" and complete the configurations afterwards to access the shared printer.

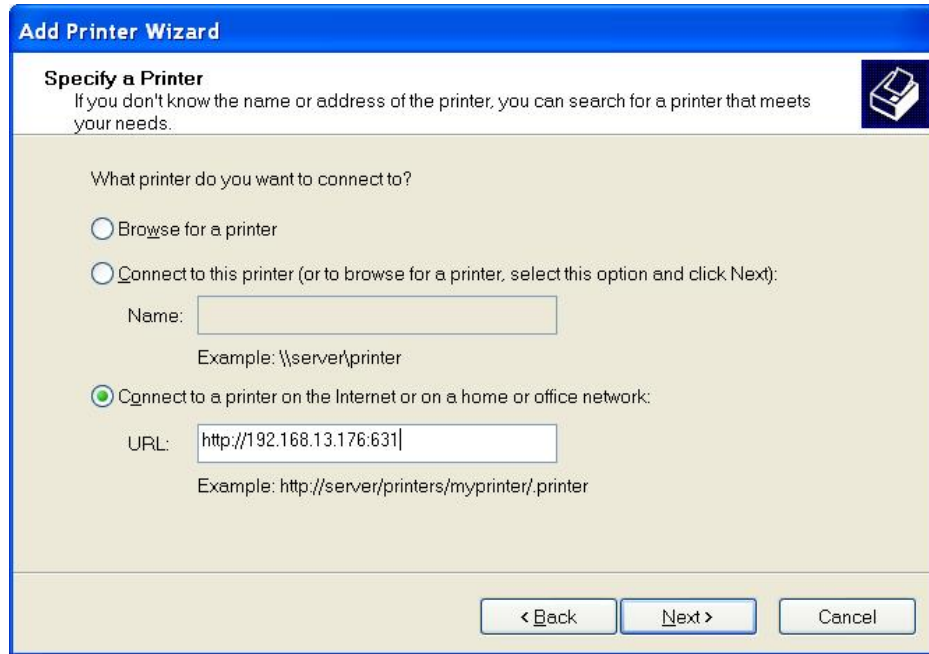

The image shows a Windows-style dialog box titled "Add Printer Wizard". The main heading is "Specify a Printer". Below this, there is a sub-heading "Specify a Printer" and a descriptive sentence: "If you don't know the name or address of the printer, you can search for a printer that meets your needs." To the right of this text is a small printer icon. The main area of the dialog asks "What printer do you want to connect to?". There are three radio button options: 1. "Browse for a printer" (unselected). 2. "Connect to this printer (or to browse for a printer, select this option and click Next):" (unselected). Below this option is a text input field labeled "Name:" with the example "\\server\printer" shown below it. 3. "Connect to a printer on the Internet or on a home or office network:" (selected). Below this option is a text input field labeled "URL:" with the example "http://192.168.13.176:631" shown below it. At the bottom of the dialog are three buttons: "< Back", "Next >", and "Cancel".

Free Manuals Download Website

<http://myh66.com>

<http://usermanuals.us>

<http://www.somanuals.com>

<http://www.4manuals.cc>

<http://www.manual-lib.com>

<http://www.404manual.com>

<http://www.luxmanual.com>

<http://aubethermostatmanual.com>

Golf course search by state

<http://golfingnear.com>

Email search by domain

<http://emailbydomain.com>

Auto manuals search

<http://auto.somanuals.com>

TV manuals search

<http://tv.somanuals.com>