

User's Manual

WGD-800

8-Port 10/100Mbps Managed Ethernet Switch



Trademarks

Copyright © PLANET Technology Corp. 2005.

Contents subject to which revision without prior notice.

PLANET is a registered trademark of PLANET Technology Corp. All other trademarks belong to their respective owners.

Disclaimer

PLANET Technology does not warrant that the hardware will work properly in all environments and applications, and makes no warranty and representation, either implied or expressed, with respect to the quality, performance, merchantability, or fitness for a particular purpose.

PLANET has made every effort to ensure that this User's Manual is accurate; PLANET disclaims liability for any inaccuracies or omissions that may have occurred.

Information in this User's Manual is subject to change without notice and does not represent a commitment on the part of PLANET. PLANET assumes no responsibility for any inaccuracies that may be contained in this User's Manual. PLANET makes no commitment to update or keep current the information in this User's Manual, and reserves the right to make improvements to this User's Manual and/or to the products described in this User's Manual, at any time without notice.

If you find information in this manual that is incorrect, misleading, or incomplete, we would appreciate your comments and suggestions.

FCC Warning

This equipment has been tested and found to comply with the limits for a Class A digital device, pursuant to Part 15 of the FCC Rules. These limits are designed to provide reasonable protection against harmful interference when the equipment is operated in a commercial environment. This equipment generates, uses, and can radiate radio frequency energy and, if not installed and used in accordance with the Instruction manual, may cause harmful interference to radio communications. Operation of this equipment in a residential area is likely to cause harmful interference in which case the user will be required to correct the interference at whose own expense.

CE Mark Warning

This is a Class A product. In a domestic environment, this product may cause radio interference, in which case the user may be required to take adequate measures.

WEEE Warning



To avoid the potential effects on the environment and human health as a result of the presence of hazardous substances in electrical and electronic equipment, end users of electrical and electronic equipment should understand the meaning of the crossed-out wheeled bin symbol. Do not dispose of WEEE as unsorted municipal waste and have to collect such WEEE separately.

Revision

PLANET Ethernet Switch User's Manual

FOR MODEL: WSD-800

Part No. 2081-A92310-001

Table of Contents

1. INTRODUCTION.....	6
1.1 PACKET CONTENTS	6
1.2 HOW TO USE THIS MANUAL	6
1.3 PRODUCT FEATURE	6
1.4 PRODUCT SPECIFICATION	7
2. INSTALLATION	9
2.1 PRODUCT DESCRIPTION	9
2.1.1 <i>Product Overview</i>	9
2.1.2 <i>Switch Front Panel</i>	9
2.1.3 <i>LED Indications</i>	9
2.1.4 <i>Switch Rear Panel</i>	10
2.2 INSTALL THE SWITCH	10
2.2.1 <i>Desktop Installation</i>	10
2.2.2 <i>Rack Mounting</i>	11
3. CONSOLE MANAGEMENT	12
3.1 CONNECTING TO THE SWITCH	12
3.2 LOGIN IN THE CONSOLE INTERFACE	12
3.3 CONSOLE MANAGEMENT	13
3.4 TELNET LOGIN	14
3.5 COMMANDS	14
3.5.1 <i>First level commands</i>	14
3.5.2 <i>Privileged Command</i>	15
4. WEB-BASED MANAGEMENT.....	22
4.1 ABOUT WEB-BASED MANAGEMENT	22
4.2 PREPARING FOR WEB MANAGEMENT	22
4.3 SYSTEM LOGIN.....	22
4.4 SYSTEM.....	23
4.4.1 <i>IP Configuration</i>	23
4.4.2 <i>SNMP</i>	24
4.4.2.1 <i>Theory</i>	24
4.4.3 <i>Password</i>	27
4.4.4 <i>CONSOLE</i>	28
4.4.5 <i>System Upgrade</i>	28
4.4.6 <i>Saving Parameters</i>	29
4.4.7 <i>Parameters Backup & Recovery</i>	29

4.4.8 Load Default	30
4.4.9 Reboot	30
4.5 PORT MANAGEMENT	30
4.5.1 Port Configuration	30
4.5.2 Port Statistics	31
4.5.3 Port Band Restrict	31
4.6 REDUNDANCY	32
4.6.1 Spanning Tree	32
4.6.2 Spanning Tree Configuration	38
4.6.3 Link Aggregation	40
4.7 SECURITY	41
4.7.1 VLAN	41
4.7.2 MAC Address Bind	50
4.7.3 MAC Address Filtering	51
4.7.4 MAC Address Learning	52
4.7.5 MAC Address Aging Time	53
4.7.6 802.1X Port-Based Network Access Control	54
4.8 QoS	67
4.8.1 Understand QOS	67
4.8.2 QOS Configuration	68
4.9 MULTICAST	73
4.9.1 IGMP Snooping	73
4.9.2 Static Routing Port	75
4.10 PORT ANALYSIS	75
4.10.1 Port Analysis	75
4.10.2 Port Mirror	76
4.11 STORM CONTROL	77
4.12 IP STACKING	78
5. TROUBLE SHOOTING	83
5.1 INCORRECT CONNECTIONS	83
5.1.1 Faulty or loose cables	83
5.1.2 Non-standard cables	83
5.1.3 Improper Network Topologies	83
5.2 DIAGNOSING LED INDICATORS	83
5.2.1 Cabling	83
6. APPENDIX	85
6.1 CONSOLE PORT PIN ASSIGNMENTS	85

6.2 100BASE-TX/10BASE-T PIN ASSIGNMENTS	86
7. APPENDIX-B	87
802.1Q VLAN MULTI-UNTAGGED VLAN SETTING SAMPLE 1	87

1. INTRODUCTION

1.1 Packet Contents

Check the contents of your package for following parts:

- Ethernet Switch x1
- CD-ROM user's manual x1
- Quick installation guide x1
- 19" rack mounting kit x1
- Power cord x1
- Rubber feet x 4

If any of these are missing or damaged, please contact your dealer immediately, if possible, retain the carton including the original packing material, and use them against to repack the product in case there is a need to return it to us for repair.

1.2 How to Use This Manual

This User Manual is structured as follows:

Chapter 2, **INSTALLATION**

The chapter explains the functions of the Switch and how to physically install the Switch.

Chapter 3, **CONSOLE MANAGEMENT**

The chapter explains how to manage the switch by Console interface.

Chapter 4, **WEB-BASED MANAGEMENT**

The chapter explains how to manage the switch by Web interface.

Chapter 5, **TROUBLE SHOOTING**

The chapter explains how to trouble shooting of the Switch.

Chapter 6, **APPENDIX**

The chapter contains cable information of the Switch.

In the following section, terms "**SWITCH**" with upper case denotes the WSD-800 Ethernet switch. Terms with lower case "switch" means any Ethernet switches.

1.3 Product Feature

- 8-Port 10/100Mbps TP interfaces
- Complies with IEEE802.3, 10Base-T, IEEE802.3u, 100Base-Tx
- High back-plane bandwidth 1.6Gbps

- Console/Web/SNMP management
- Configuration backup and recovery
- Per port Ingress/Egress bandwidth restriction
- 802.1d Spanning tree, 802.1w Rapid Spanning Tree
- Configurable spanning tree aging time, STP port configuration
- 4 trunk groups, up to 4 ports per trunk
- Port-based/802.1Q VLAN with 4K VLAN ID
- MAC Binding/Filtering/Learning, configurable MAC Aging time
- 8 mappings ID to 4 priority queues, Support MAC/VLAN/802.1p/Port to CoS mapping
- IGMP snooping and IGMP Query mode for Multi-media application
- Statistic Routing Port
- 1 to many Ingress/Egress Port mirror and Port analysis
- Broadcast/Multicast/Flooded storm control
- 802.1X Port-Based Authentication
- IP Stack Technology supports up to 8unit switch stack for centralize management

1.4 Product Specification

Hardware Specification	
Network Connector	8-Port RJ-45 for 10/100Base-TX
RS-232 connector	One RS-232 DB-9 male connector for switch management
Switch architecture	Store and forward switch architecture.
Switch Fabric	Back-plan up to 1.6Gbps
MAC address	8K MAC address table with Auto learning function
Shared Buffer	512K byte
Power requirement	90~240V AC, 50/60Hz,
Operating environment	0~50 degree C, 5%~90%RH
Storage environment	-20~70 degree C, 5%~90%RH
Dimension (W x D x H)	280×173×44 mm
Switch Specification	
Spanning Tree	802.1d, 802.1w
Link Aggregation	4 groups, up to 4 ports per group
Priority Queue	802.1p Class of Service (4 Queues)
Port Mirror	RX/TX/Both
Bandwidth Control	Yes, per port per 64kbps, up to 80Mbps
Strom Control	Per 64kbps, up to 80Mbps
IGMP Snooping	v1, v2
MAC Filtering	Yes
VLAN	Port-Based/ 802.1q, 4K VLAN ID, 256 groups
Port Analysis	Yes
Static Routing Port	Yes
Security	802.1X Port-Based Authentication
Management Function	

Management Interface	Console/Web/Telnet/SNMP
SNMP Version	v1, v2c
Support MIB	Support SNMP MIB II (RFC 1213), Bridge MIB (RFC 1493), RMON group 1,2,3,9 Enterprise private MIB
Standard Compliance	
Network Standard	IEEE802.3 10Base-T IEEE802.3u 100Base-TX IEEE802.3x Flow Control and Back pressure IEEE802.3ad Port trunk with LACP IEEE802.1d Spanning tree protocol IEEE802.1w Rapid Spanning Tree IEEE802.1p Class of service IEEE802.1Q VLAN Tagging IEEE802.1X Network Access Control
EMI	FCC Class A, CE

2. INSTALLATION

This section describes the functionalities of the Switch's components and guides how to install it on the desktop or shelf. Basic knowledge of networking is assumed. Please read this chapter completely before continuing.

2.1 Product Description

2.1.1 Product Overview

With 8-Port 10/100Mbps TP, the PLANET WSD-800 boasts a high performance switch architecture that is capable of providing non-blocking switch fabric and wire-speed throughput as high as 1.6Gbps.

The IEEE 802 standard-based firmware provides a rich set of features and ensures interoperability with equipment from other vendors. Additionally, the firmware includes advanced features such as IGMP snooping, broadcast storm control, and MAC address filtering, to enhance security and bandwidth utilization.

With its built-in web-based management, the PLANET WSD-800 offers an easy-to-use, platform-independent management and configuration facility. The PLANET WSD-800 supports standard Simple Network Management Protocol (SNMP) and can be managed via any standard-based management software. For text-based management, the WSD-800 can also be accessed via Telnet and the console port.

2.1.2 Switch Front Panel

Figure 2-1 shows the front panel of the switch.

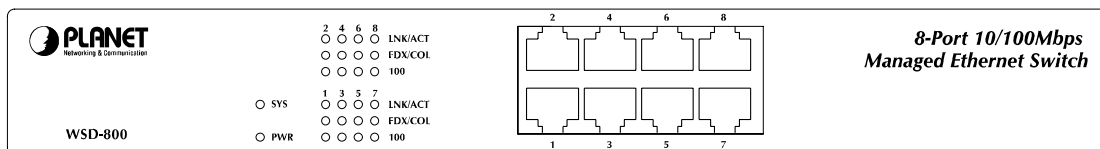

Figure 2-1 WSD-800 front panel.

2.1.3 LED Indications

Network:

LED	Color	Function
PWR	Green	Lights to indicate that the Switch is powered on.
SYS	Green	Lights to indicate the system is working.
LNK/ACT	Orange	Blink to indicate that the switch is actively sending or receiving data over that port.
FDX/COL	Green	Lights to indicate the link through that port is in duplex mode.
100	Green	Lights to indicate the port is acting in 100Mbps speed.

2.1.4 Switch Rear Panel

Figure 2-2 shows the rear panel of the switch

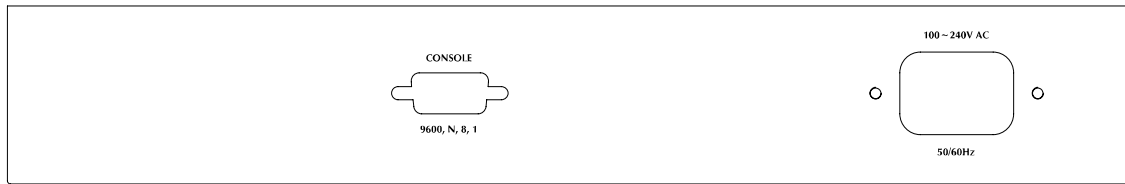

Figure 2-2 WSD-800 rear panel.

Power Notice:

1. The device is a power-required device, it means, it will not work till it is powered. If your networks should active all the time, please consider using UPS (Uninterrupted Power Supply) for your device. It will prevent you from network data loss or network downtime.
2. In some area, installing a surge suppression device may also help to protect your switch from being damaged by unregulated surge or current to the Switch or the power adapter.

2.2 Install the Switch

This section describes how to install the Ethernet Switch and make connections to it. Please read the following topics and perform the procedures in the order being presented.

2.2.1 Desktop Installation

To install the Switch on desktop or shelf, please follows these steps:

Step1: Attach the rubber feet to the recessed areas on the bottom of the switch.

Step2: Place the switch on the desktop or the shelf near an AC power source.

Step3: Keep enough ventilation space between the switch and the surrounding objects.

 **Note:** When choosing a location, please keep in mind the environmental restrictions discussed in Chapter 1, Section 4, in Specification.

Step4: Connect the Switch to network devices.

- A. Connect one end of a standard network cable to the 10/100/1000 RJ-45 ports on the front of the Switch
- B. Connect the other end of the cable to the network devices such as printer servers, workstations or routers...etc.

 **Note:** Connection to the Switch requires UTP Category 5 network cabling with RJ-45 tips. For more information, please see the Cabling Specification in Appendix A.

Step5: Supply power to the switch.

- A. Connect one end of the power cable to the switch.
- B. Connect the power plug of the power cable to a standard wall outlet.

When the switch receives power, the Power LED should remain solid Green.

2.2.2 Rack Mounting

To install the switch in a 19-inch standard rack, please follow the instructions described below.

Step1: Place the switch on a hard flat surface, with the front panel positioned towards the front side.

Step2: Attach the rack-mount bracket to each side of the switch with supplied screws attached to the package.

Figure 2-5 shows how to attach brackets to one side of the switch.

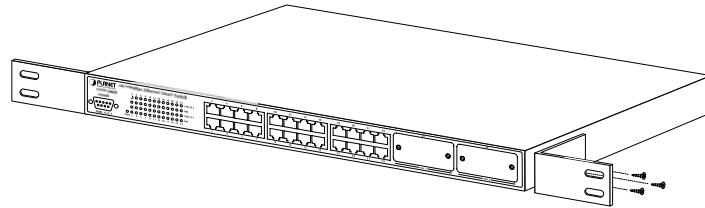

Figure 2-5 Attach brackets to the switch.

Caution:

You must use the screws supplied with the mounting brackets. Damage caused to the parts by using incorrect screws would invalidate the warranty.

Step3: Secure the brackets tightly.

Step4: Follow the same steps to attach the second bracket to the opposite side.

Step5: After the brackets are attached to the Switch, use suitable screws to securely attach the brackets to the rack, as shown in Figure 2-6

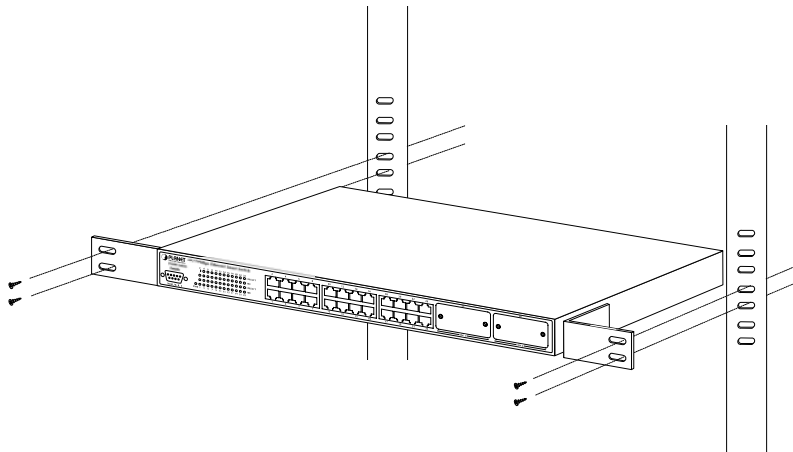

Figure 2-6 Mounting the Switch in a Rack

Step6: Proceeds with the steps 4 and steps 5 of session 2.2.1 Desktop Installation to connect the network cabling and supply power to the switch.

3. CONSOLE MANAGEMENT

3.1 Connecting to the Switch

The console port is a female DB-9 connector that enables a connection to a PC or terminal for monitoring and configuring the Switch. Use the supplied RS-232 cable with a male DB-9 connector to connect a terminal or PC to the Console port. The Console configuration (out of band) allows you to set Switch for remote terminal as if the console terminal were directly connected to it.

3.2 Login in the Console Interface

When the connection between Switch and PC is ready, turn on the PC and run a terminal emulation program or Hyper Terminal and configure its communication parameters to match the following default characteristics of the console port:

Baud Rate: 9600 bps

Data Bits: 8

Parity: none

Stop Bit: 1

Flow control: None

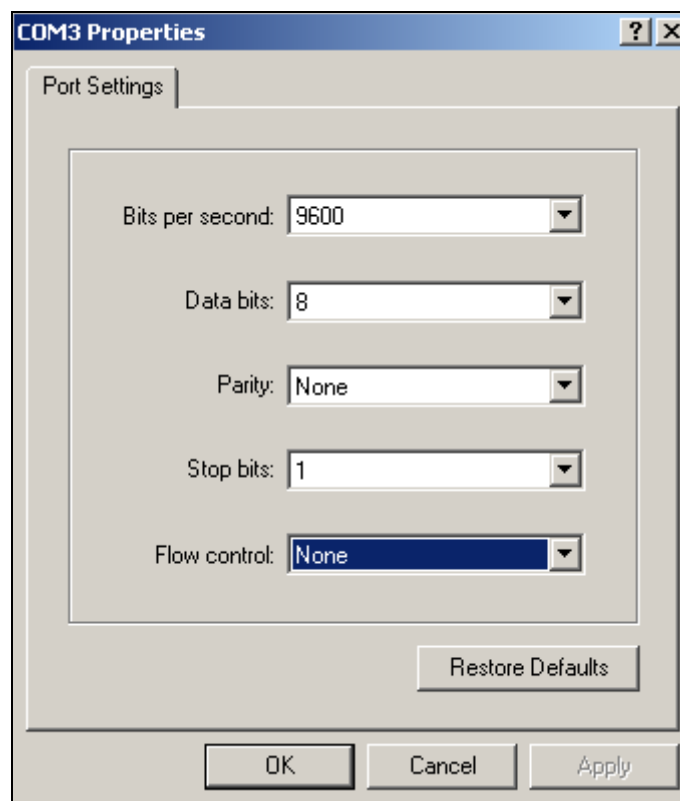

The settings of communication parameters

After finished the parameter settings, click "OK". When the prompt shows "**switch>**", type "?" for help or type

“enable” for further configuration. The system needs password for further configuration. After the “enable” command, the system asks for password, please enter “admin” for the default password. As shows in the following screen:

```

Register Protocol Module: Snmp Module          ... Ok!
Register Protocol Module: Snmp Rmon           ... Ok!
Register Protocol Module: STP                 ... Ok!
Register Hardware Module: STP                 ... Ok!
Register Protocol Module: QVlan               ... Ok!
Register Hardware Module: HwQVlan             ... Ok!
Register Protocol Module: PVlan               ... Ok!
Register Hardware Module: HwPVlan             ... Ok!
Register Protocol Module: Mirror              ... Ok!
Register Hardware Module: Mirror              ... Ok!
Register Protocol Module: mac table           ... Ok!
Register Hardware Module: new mac table driver. ... Ok!
Register Protocol Module: Counter             ... Ok!
Register Hardware Module: HwCounter           ... Ok!
Register Protocol Module: Ruby_QoS            ... Ok!
Register Hardware Module: Ruby_QoS            ... Ok!
Register Protocol Module: IGMP Snooping       ... Ok!
Register Hardware Module: IGMP Snooping Driver ... Ok!
Register Protocol Module: Rate Shaping        ... Ok!
Register Hardware Module: Rate Shaping Driver ... Ok!
Register Protocol Module: Command Line        ... Ok!
Switch>enable
Please input password:
Switch\enable>

```

Console login screen

3.3 Console Management

Entering a question mark "?" at the prompt displays the list of commands available for command mode.

As shows in the following screen:

```

clear manage ip          Clear manage ip address
clear mirror monitored-port egress Clear egress monitored port for mirror
clear mirror monitored-port ingress Clear ingress monitored port for mirror
clear multicast router  Clear router port
clear port counters      Clear port statistics counter
clear port rate-shaping  Clear rate-shaping of all ports
clear port spantree portcost Restore spanning tree port cost to
                        default value
clear port spantree portpri Restore spanning tree port priority to
                        default value
clear port strom-limit   Clear strom limit of all ports
clear qos map cos-queue-map Reset cos-queue map to default
clear qos map dot1p-cos-map Reset dot1p_cos map to default
clear qos map mac-cos-map Clear qos map mac-cos-map
clear qos map vlan-cos-map Clear qos map vlan-cos-map
clear security filter-MAC Clear MAC filter entry
clear security static-MAC Clear static MAC entry
clear snmp community     Clear snmp community entry
clear snmp trap           Clear snmp trap management host
clear spantree root       Restore spanning tree parameters

clear trunk              Clear trunk port from vlans
clear vlan               Clear member from vlan
-----MORE-----

```

The question mark “?” command

3.4 Telnet login

The switch also supports telnet for remote management. The switch asks for user name and password for remote login when using telnet, please use “**admin**” for username and “**admin**” for password.

3.5 Commands

There are two levels for console commands. The first level provides commands to show system informations and current configurations. The second level (**privileged mode**) provides commands to set, clear and show the configuration.

3.5.1 First level commands

The follow table lists the first commands and the equivalent usages.

Command	Description
enable	Enable privileged mode
show channel	Show channel information
show console-info	Show console-info
show dow1x local-userInfo	Show dot1x local user information
show dot1x state	Show dot1x information
show igmp-snooping group number	show igmp snooping group-limit
show igmp-snooping group policy	Show igmp snooping group policy
show igmp-snooping info	Show igmp snooping information
show igmp-snooping policy deny	Show igmp snooping policy deny
show ip http server	Show http server information
show ip telnet server	Show telnet server information
show ipstack info	Show ip stack information
show mirror	Show mirror information
show multicast router	Show multicast router port information
show port counter	Show port counter information
show port dot1x	Show port dot1x information
show port mac-learning	Show MACs on certain port
show port rate-shaping	Show port ingress and egress rate-shaping
show port rstp-extension	Show port RSTP port role and protocol mode
show port spantree	Show spantree information on ports

show port state	Show port information
show port storm-limit	Show port storm limit mode and rate
show qos map cos-queue-map	Show qos map cos-queue-map
show qos map dot1p-cos-map	Show qos map cos-queue-map
show qos map mac-cos-map	Show qos map mac-cos-map
show qos map port-cos-map	Show each port's cos
show qos map vlan-cos-map	Show qos map vlan-cos-map
show qos queue egress-policy	Show qos queue egress-policy
show radius	Show radius information
show security MAC-aging	Show MAC aging time
show security filter-MAC	Show MAC filter entry
show security mac-learning	Show port security status
show security static-MAC	Show static mac table information
show snmp	Show snmp information
show snmp rmon	Show snmp rmon state
show spantree	Show spanning tree information
show syntax	Show basic help information
show system	Show system information
show trunk	Show trunk information
show version	Get last software version
show vlan	Show vlan information
show vlan type	Show current vlan type

3.5.2 Privileged Command

To access to the second level, enter the “**enable**” command in the first level. The system then prompts for a password. Please enter “**password**” for the password.

The prompt then changes to “**Switch\enable>**”. Entering a question mark “?” at the prompt displays the list of commands available for command mode.

3.5.2.1 Clear command

Clear command is to clear the parameter. The following table lists the clear commands and the equivalent usages.

Command	Description
clear channel	Clear member from channel
clear dot1x local-userInfo	Clear igmp-snooping group policy
clear igmp-snooping policy deny	Clear igmp snooping policy deny
clear mirror monitored-port egress	Clear egress monitored port for mirror

clear mirror monitored-port ingress	Clear ingress monitored port for mirror
clear multicast router	Clear router port
clear port counters	Clear port statistics counter
clear port rate-shaping	Clear rate-shaping of all ports
clear port spantree portcost	Restore spanning tree port cost to default value
clear port spantree portpri	Restore spanning tree port priority to default value
clear port storm-limit	Clear strom limit of all ports
clear qos map cos-queue-map	Reset cos-queue map to default
clear qos map dot1p-cos-map	Reset dot1p_cos map to default
clear qos map mac-cos-map	Clear qos map mac-cos-map
clear qos map vlan-cos-map	Clear qos map vlan-cos-map
clear radius key	Clear radius share key
clear security filter-MAC	Clear MAC filter entry
clear security static-MAC	Clear static MAC entry
clear snmp community	Clear snmp community entry
clear snmp trap	Clear snmp trap management host
clear spantree root	Restore spanning tree parameters
clear trunk	Clear trunk port from vlans
clear vlan	Clear member from vlan
copy config flash	Copy system configuration parameters to default value
clear port storm-limit	Clear strom limit of all ports
clear qos map cos-queue-map	Reset cos-queue map to default
clear qos map dot1p-cos-map	Reset dot1p_cos map to default
clear qos map mac-cos-map	Clear qos map mac-cos-map
clear qos map vlan-cos-map	Clear qos map vlan-cos-map
clear security filter-MAC	Clear MAC filter entry
clear security static-MAC	Clear static MAC entry
clear snmp community	Clear snmp community entry
clear snmp trap	Clear snmp trap management host
clear spantree root	Restore spanning tree parameters
clear trunk	Clear trunk port from vlans
clear vlan	Clear member from vlan

3.5.2.2 Copy command

Once the configuration is changed, it remains the original after a reboot unless the configuration is saved. Copy command is to save the current configuration to the flash, this saves the configuration to next reboot.

Command	Description
---------	-------------

copy config flash	Copy system configuration parameters to flash
-------------------	---

3.5.2.3 Disable command

Disable command is to exit the privileged mode and back to the first level of command line interface.

Command	Description
Disable	Disable privileged mode

3.5.2.4 Reboot command

Reboot command is to reboot the switch, please beware to check if the configuration is saved..

Command	Description
Reboot	Reboot system

3.5.2.5 Set command

Set command is to change the parameter of the switch functions. The follow table lists the set commands and the equivalent usages.

Command	Description
set channel	Set ports to be channel
set default	Set system load default parameters
set dot1x auth mode	Set dot1x auth mode
set dot1x auth-ctrl disable	Disable dot1x
set dot1x auth-ctrl enable	Enable dot1x
set dot1x local-userInfo	Set dot1x local user information
set dot1x max-req	Max times of re-transmit EAP request to Supplicant
set dot1x quiet-period	Quiet-period in secondst
set dot1x reauth-max	Max times of re-transmit Request/ID before port become Unauthorized
set dot1x reauth-mode	Enable or Disable reauthentication
set dot1x reauth-period	Period for automatic re-authentication
set dot1x servertimeout	Authentication server timeout
set dot1x supptimeout	Timeout for supplicant
set dot1x tx-period	Set dot1x server timeout
set enable password	Set the password for the privileged level of the CLI
set igmp-snooping disable	Disable igmp snooping
set igmp-snooping enable	Enable igmp snooping
set igmp-snooping forward-all-leave	Disable/Enable forward all-leave when fastleave is disabled

set igmp-snooping group number	Set number of groups that a port can join in
set igmp-snooping group policy	Set igmp-snooping group policy
set igmp-snooping immediate-leave	Disable & Enable igmp snooping immediate-leave
set igmp-snooping policy deny	Set igmp snooping policy deny
set ip http server disable	Disable http server
set ip http server enable	Enable http server
set ip telnet server disable	Disable telnet server
set ip telnet server enable	Enable telnet server
set ipstack enable	Set ipstack enable
set ipstack disable	Set ipstack disable
set ipstack group	Set ipstack group STR
set ipstack mac-addr	Set ipstack mac-addr
set ipstack mode	Set ipstack mode master/client
set ipstack system-priority	Set ipstack system-priority
set mirror	Enable/Disable mirror function
set mirror capture-port	Set a port to capture traffic
set mirror monitored-port egress	Capture egress traffic
set mirror monitored-port ingress	Capture ingress traffic
set multicast router	Set multicast router port
set password	Set the password for telnet
set port disable	Disable a port
set port duplex	Set port transmission type
set port enable	Enable a port
set port flow-control	Set port traffic flowcontrol
set port mcheck-rstp	Set port mcheck
set port point-to-point	Set port point-to-point admin value
set port rate-shaping egress	Set port egress rate-shaping rate
set port rate-shaping ingress	Set port ingress rate-shaping rate
set port rate-shaping egress	Set port egress rate-shaping rate
set port rate-shaping ingress	Set port ingress rate-shaping rate
set port spantree <port_num> portco	Set spanning tree port cost
set port spantree <port_num> portfa	Set spanning tree PortFast feature
set port spantree <port_num> portpr	Set spanning tree port priority
set port speed	Set port transmission speed
set port storm-limit mode	Set port storm limit mode
set port storm-limit rate	Set port storm limit rate
set port vlan-type	Set port vlan-type

set qos map cos-queue-map	Set the queue number of each cos
set qos map dot1p-cos-map	Set the cos value of each dot1p priority
set qos map mac-cos-map	Set MAC based qos
set qos map port-cos-map	Set port's cos
set qos map vlan-cos-map	Set vlan based qos
set qos queue egress-policy	Set the egress policy
set radius key	Set share key for radius server
set radius server	Set radius server parameters
set rstp force-version	Set RSTP force version
set security MAC-aging	Set MAC aging time
set security filter-MAC	Create MAC filter entry
set security mac-learning	Set port learning MAC (enable disable)
set security static-MAC	Create static MAC entry
set snmp	Enable/Disable snmp agent
set snmp community	Set snmp community string
set snmp rmon	Enable/Disable rmon state
set snmp trap	Set snmp trap receive host
set spantree disable	Disable spanning tree
set spantree enable	Enable spanning tree
set spantree fwddelay	Set the forward delay for the spanning tree
set spantree hello	Set the hello interval for the spanning tree
set spantree maxage	Set the max age interval for the spanning
set spantree priority	Set the bridge priority for the spanning tree
set system contact	Set system contact
set system default-gateway	Set default gateway
set system ip	Set system ip mask
set system location	Set system location
set system mac	Set system mac address
set system management-vlan	Specify a vlan for system management
set system name	Set system name
set trunk	Set vlan trunk port
set vlan <vid> name	Set vlan name
set vlan <vlan id> <portlist>	Set vlan members
set vlan port-mode	Set vlan port-mode
set vlan type port-based	Set system be port-based vlan
set vlan type dot1q-based	Set system be dot1q-based vlan
set snmp rmon	Enable/Disable rmon state

set snmp trap	Set snmp trap receive host
set spantree disable	Disable spanning tree

3.5.2.6 Show command

Show command is to display the current parameter of the switch functions. The follow table lists the show commands and the equivalent usages.

Command	Description
show channel	Show channel information
show console-info	Show console-info
show dot1x local-userInfo	Show dot1x local user information
show dot1x state	Show dot1x information
show igmp-snooping group number	Show igmp-snooping group-limit
show igmp-snooping group policy	Show igmp-snooping group policy
show igmp-snooping info	Show igmp snooping information
show igmp-snooping policy deny	Show igmp snooping policy deny
show igmp-snooping	Show igmp snooping information
show ip http server	Show http server information
show ip telnet server	Show telnet server information
show ipstack info	Show ipstack info
show mirror	Show mirror information
show multicast router	Show multicast router port information
show port counter	Show port counter information
show port dot1x	Show dot1x information
show port mac-learning	Show MACs on certain port
show port rate-shaping	Show port ingress and egress rate-shaping
show port spantree	Show spantree information on ports
show port state	Show port infomation
show port storm-limit	Show port storm limit mode and rate
show qos map cos-queue-map	Show qos map cos-queue-map
show qos map dot1p-cos-map	Show qos map cos-queue-map
show qos map mac-cos-map	Show qos map mac-cos-map
show qos map port-cos-map	Show each port's cos
show qos map vlan-cos-map	Show qos map vlan-cos-map
show qos queue egress-policy	Show qos queue egress-policy
show radius	Show radius information
show security MAC-aging	Show MAC aging time
show security filter-MAC	Show MAC filter entry

show security mac-learning	Show port security status
show security static-MAC	Show static mac table information
show snmp	Show snmp information
show snmp rmon	Show snmp rmon state
show spantree	Show spanning tree information
show syntax	Show basic help information
show system	Show system information
show trunk	Show trunk information
show version	Get last software version
show vlan	Show vlan information
show vlan type	Show current vlan type

4. WEB-BASED MANAGEMENT

This section introduces the configuration and functions of the Web-Based management.

4.1 About Web-based Management

The switch offers management features that allow users to manage the switch from anywhere on the network through a standard browser such as Microsoft Internet Explorer.

The Web-Based Management supports Internet Explorer 5.0. It is based on Java Applets with an aim to reduce network bandwidth consumption, enhance access speed and present an easy viewing screen.

Note: By default, IE5.0 or later version does not allow Java Applets to open sockets. The user has to explicitly modify the browser setting to enable Java Applets to use network ports.

4.2 Preparing for Web Management

Before use web management, you can use console to login the Switch checking the default IP of the Switch. Please refer to Console Management Chapter for console login. If you need change IP address in first time, you can use console mode to modify it. The default value is as below:

IP Address: **192.168.0.100**

Subnet Mask: **255.255.255.0**

Default Gateway: **192.168.0.254**

User Name: **admin**

Password: **admin**

4.3 System Login

1. Launch the Internet Explorer.
2. Enter the IP address of the switch.
3. When the login screen appears, use **admin/admin** as the default username/password respectively to login.
4. The main web page of the Web-based management appears. As shows in the following screen.

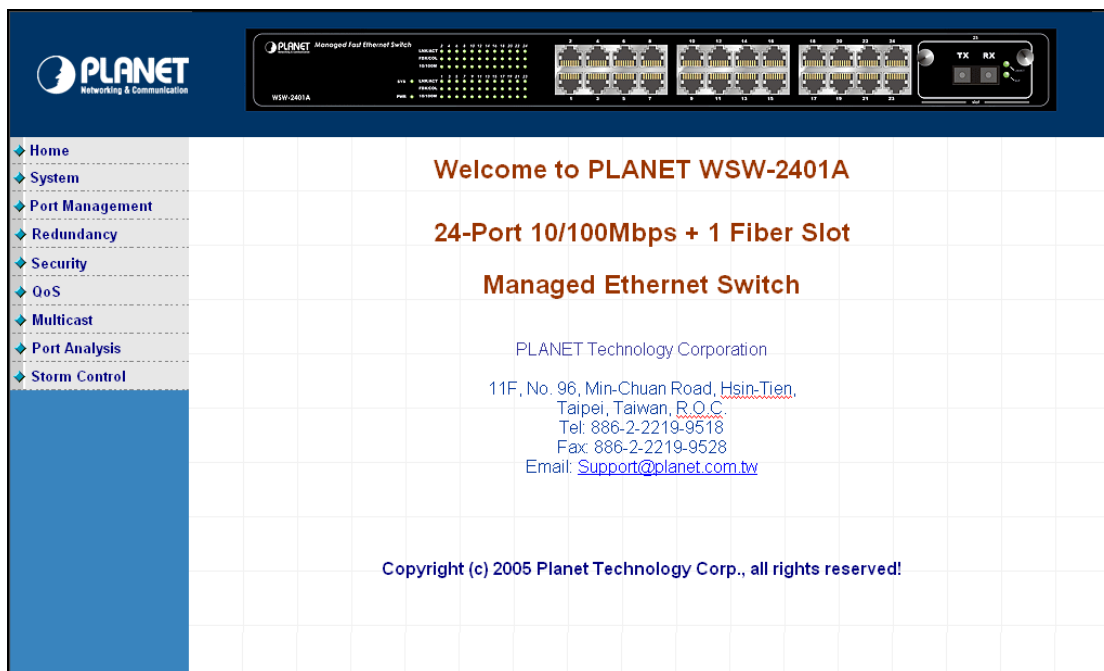

WSD-800 Web Management Interface

4.4 System

4.4.1 IP Configuration

The switch can be managed by the Web/Telnet/SNMP interfaces. Administrators can access the management interface via the IP address of the switch. The default IP address of the switch is 192.168.0.100. You can change the IP address to be in the same IP segment as your LAN network for convenience.

To change the IP address, click on the **System/IP Address** menu button. The IP address configuration screen then shows in the main page on the web. Enter the new IP address, Submask and Gateway then click on the **OK** button to change.

IP Address Configuration



1. The Switch's factory-default IP address is 192.168.0.100 with Submask 255.255.255.0 and a default gateway of 192.168.0.254
2. The changed IP address take effect immediately after click on the OK button, you need to use the new IP address to access the Web interface.
3. The changed IP address remains the original after reboot the switch unless the configuration is saved.
To save the changed IP address, please move to **System/Saving Parameters** menu.

4.4.2 SNMP

4.4.2.1 Theory

The Simple Network Management Protocol (SNMP) is an application layer protocol that facilitates the exchange of management information between network devices. It is part of the Transmission Control Protocol/Internet Protocol (TCP/IP) protocol suite. SNMP enables network administrators to manage network performance, find and solve network problems, and plan for network growth.

An SNMP-managed network consists of three key components: Network management stations (NMSs), SNMP agents, Management information base (MIB) and network-management protocol :

- **Network management stations (NMSs)** : Sometimes called consoles, these devices execute management applications that monitor and control network elements. Physically, NMSs are usually engineering workstation-caliber computers with fast CPUs, megapixel color displays, substantial memory, and abundant disk space. At least one NMS must be present in each managed environment.
- **Agents** : Agents are software modules that reside in network elements. They collect and store management information such as the number of error packets received by a network element.
- **Management information base (MIB)** : A MIB is a collection of managed objects residing in a virtual information store. Collections of related managed objects are defined in specific MIB modules.
- **network-management protocol** : A management protocol is used to convey management information between agents and NMSs. SNMP is the Internet community's de facto standard management protocol.

SNMP Operations

SNMP itself is a simple request/response protocol. NMSs can send multiple requests without receiving a response.

- **Get** -- Allows the NMS to retrieve an object instance from the agent.
- **Set** -- Allows the NMS to set values for object instances within an agent.
- **Trap** -- Used by the agent to asynchronously inform the NMS of some event. The SNMPv2 trap message is designed to replace the SNMPv1 trap message.

SNMP community

An SNMP community is the group that devices and management stations running SNMP belong to. It helps define where information is sent. The community name is used to identify the group. A SNMP device or agent may belong to more than one SNMP community. It will not respond to requests from management stations that do not belong

to one of its communities. SNMP default communities are:

- **Write** = private
- **Read** = public

4.2.2.2 SNMP Configuration

To configure SNMP management, click on **System/SNMP** menu button, and the web main page changes to the SNMP Management function, as shows in the following:

The screenshot displays the 'SNMP Management' web interface. It is divided into four main sections:

- SNMP Agent Status Configuration:** Features a dropdown menu for 'SNMP Agent Status' set to 'Enable' and an 'OK' button.
- System Options:** Includes text input fields for 'System Name' (containing 'Switch'), 'System Location', and 'Contact', with an 'OK' button below.
- Community Configuration:** Contains an 'Add Community' section with a text input field, radio buttons for 'Read Only' (selected) and 'Read/Write', and an 'Add' button. To the right is a 'Current Communities' list box containing 'public-----Read Only' and a 'Delete' button.
- Management Station Configuration:** Features an 'Add Management Station' section with an 'IP Address' input field, and a 'Current Management Stations' list box.

The followings are the description of the sub-table.

1. SNMP Agent Status Configuration

This block enables to turn on SNMP Agent.

Enabled / Disabled: To turn on or turn off the SNMP function on the Switch.

This close-up shows the 'SNMP Agent Status Configuration' section. It consists of a label 'SNMP Agent Status:' followed by a dropdown menu currently showing 'Enable', and an 'OK' button positioned below the dropdown.

2. System Options

This table is to define the system name, system location and the contact person of the switch. These informations show in the SNMP software of the management workstation which helps to identify the switch that is looking into.

There are three fields in the “**system options**” configuration block:

- **System Name:** The system name of the switch which would show in the SNMP software.
- **System Location:** The system location of the switch which would show in the SNMP software.

- **Contact:** The contact person of the switch which would show in the SNMP software.

Fill the fields and click on the “OK” button to save.

3. Community Configuration

Use this table to configure the SNMP community strings and define the policy of the relative string. The community string acts like a password to permit access to the agent on the Switch. One or more of the following characteristics can be associated with the community string:

- **Add Community:** enter private or public
- Chooses community strings for the Switch management access: read only or read/write
- **Read only:** Enables requests accompanied by this string to display MIB-object information.
- **Read/Write:** Enables requests accompanied by this string to display MIB-object information and to set MIB objects.

Complete the above steps and click on the “Add” button.

The added string then shows in the Current Communities field.

- **Current Communities:** show the list in input field

4. Management Station Configuration

A trap manager is a management station (SNMP application) that receives traps (the system alerts generated by the switch). If no trap manager is defined, no traps are issued. Create a trap manager by entering the IP address of the station and a community string.

- Enter Network management stations IP address: 192.168.0.53 (for example)
- **Trap Community:** must be the same string as “Add community”

Then click on “Add” button.

Management Station Configuration	
Add Management Station	Current Management Stations
IP Address <input type="text" value="192.168.0.53"/>	<input style="width: 100px; height: 60px;" type="text"/>
Trap Community <input type="text" value="private"/>	
<input type="button" value="Add"/>	

The “Current Management Stations” field shows the trap list.

Management Station Configuration	
Add Management Station	Current Management Stations
IP Address <input type="text"/>	<input style="width: 100px; height: 60px;" type="text" value="192.168.0.53-----private"/>
Trap Community <input type="text"/>	
<input type="button" value="Add"/>	

4.4.3 Password

The **Password** management menu is to set or change the password of the Web Management Interface.

Click on **System/Password** menu button, and the **Modify Password** table shows in the main web page.

Enter “old password “, “new password”, “confirm password” Click “OK” to change the password.

Modify Password	
Old Password	<input type="text"/>
New Password	<input type="text"/>
Confirm Password	<input type="text"/>
<input type="button" value="OK"/>	

4.4.4 CONSOLE

This function shows the connection parameters for the Console Management Interface. Click on the **System/CONSOLE** menu button, and the following table shows in the main page of the web.

Console Information	
Data bits:	<input type="text" value="8"/>
Stop bits:	<input type="text" value="1"/>
Parity check:	<input type="text" value="none"/>
Flow control:	<input type="text" value="none"/>
Baud rate(bps):	<input type="text" value="9600"/>

4.4.5 System Upgrade

This function allows performing firmware update from the web interface.

Click on the **System/System Upgrade** menu button, and the following table shows in the main page of the web.

Click on the **"Browse"** button of the main page, the system would pop up the file selection menu to choose firmware. Select on the firmware, and the **Update Status** would show the file upload status.

System Upgrade	
The File's Name	<input type="text"/> <input type="button" value="Browse..."/>
Update Status:	<input type="text"/>
<input type="button" value="Update"/>	



CAUTION: Do not power off the switch until the update progress is complete.

4.4.6 Saving Parameters

It takes effect immediately when you change the parameters of the management function when the switch is running. But the parameters would not be saved after reboot the switch. To keep the changed parameters, Click on the **System/Saving Parameters** menu button, and click on the “**Save**” button on the web main page as show in the following.

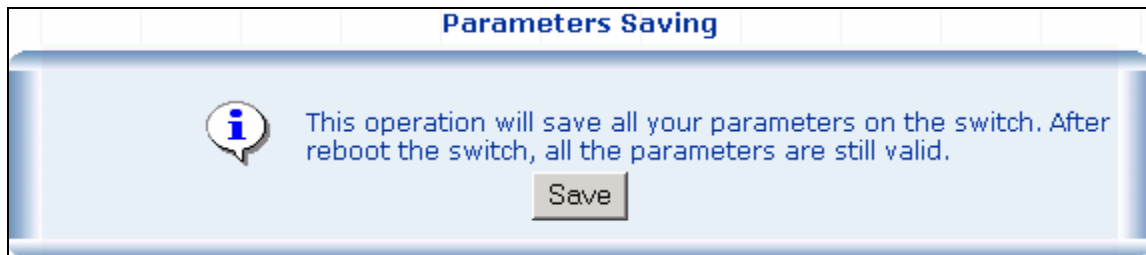

4.4.7 Parameters Backup & Recovery

This function is to backup the running configuration to the workstation and to restore the configuration you had saved in the workstation.

Click on the **System/Backup & Recovering** menu button, and the following table shows in the web main page.

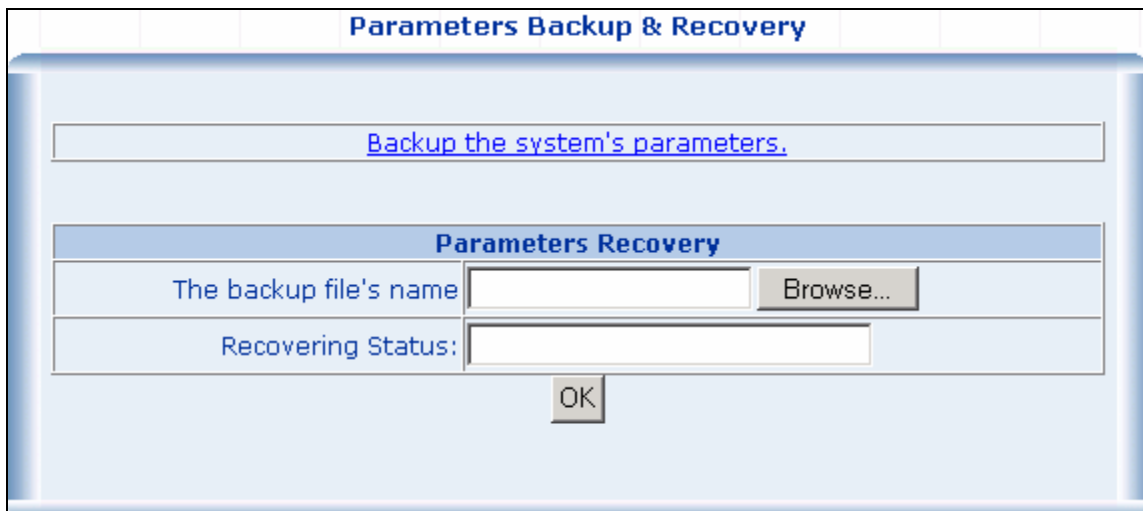

To backup the running configuration, click on the “**Backup the system’s parameters**” link, and a pop up window shows to save the configuration of the switch to your workstation.

To recover a saved configuration, click on the “**Browse**” button in the Parameters Recovery table. A pop up window would direct you to upload the configuration file.

4.4.8 Load Default

This function is to reset the configuration of switch to the factory default. Click on the **System/Load Default** menu button, and the following table shows in the web main page.

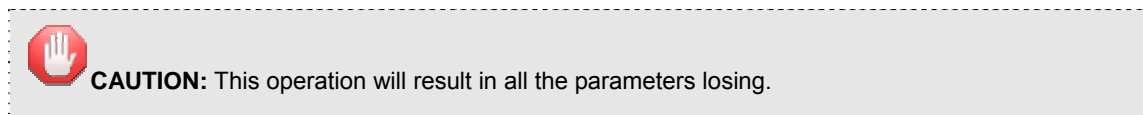
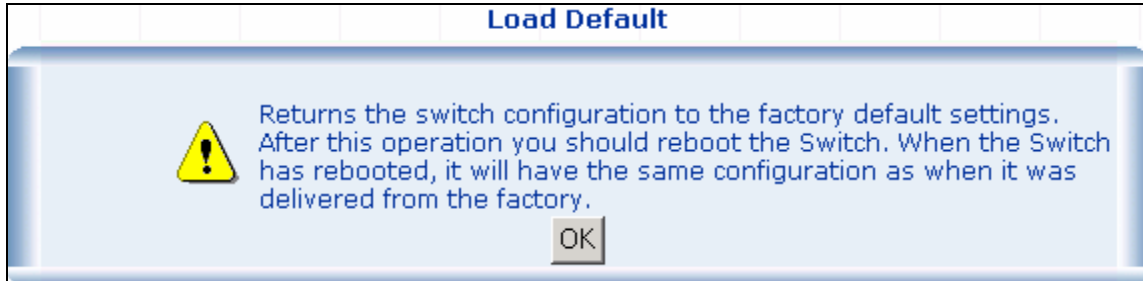

4.4.9 Reboot

This function is to reboot the system.

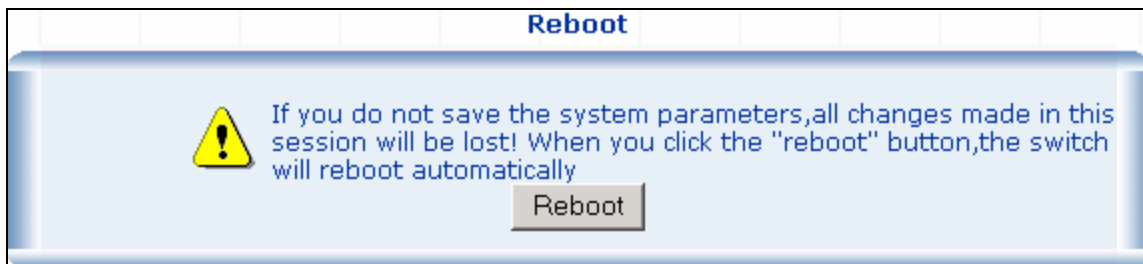

4.5 Port Management

4.5.1 Port Configuration

This function is to configure and to view the configured port management status, port negotiation mode and the port flow control function.

- **Management Status:** Display port status: Enable or Disable. Disable is to turn off the port.
- **Link Status:** "Up" to indicate the port is linked while "Down" to indicate the port is not connectd.
- **Speed:** Shows the negotiation mode and the running speed on the port.
- **Duplex:** Displays full-duplex or half-duplex mode.
- **Flow Control:** Display Flow status of port: Enable or Disable, Disable indicates Flow control is off.
- **Auto:** Display which mode the port is auto-negotiated
- **Config:** (configured) Displays the state defined by the user.
- **Atual:** Displays the negotiation result.

Port Configuration

Port Configuration								
Port List (e.g. 1-3,7)	Management Status	Speed/Duplex	Flow Control					
<input type="text"/>	Enable ▾	Auto ▾	Disable ▾					
OK								
Port status								
Port	Management Status	Link Status	Speed		Duplex		Flow Control	
			Config	Actual	Config	Actual	Config	Actual
Port 1	Enable	Down	Auto	NA	Auto	NA	Disable	NA
Port 2	Enable	Down	Auto	NA	Auto	NA	Disable	NA
Port 3	Enable	Down	Auto	NA	Auto	NA	Disable	NA
Port 4	Enable	Down	Auto	NA	Auto	NA	Disable	NA
Port 5	Enable	Down	Auto	NA	Auto	NA	Disable	NA
Port 6	Enable	Up	Auto	100M	Auto	Full	Disable	Disable
Port 7	Enable	Down	Auto	NA	Auto	NA	Disable	NA

4.5.2 Port Statistics

The Port Statistics page provides a view of the current status of every port on the Switch.

Pressing the “Reset” button will reset all port counters to zero.

Port Statistics

Port	Management Status	Link Status	Rx Bytes	Rx Pkts	Tx Bytes	Tx Pkts	Collision Pkts	Discard Pkts
Port1	Enable	Down	0	0	0	0	0	0
Port2	Enable	Down	0	0	0	0	0	0
Port3	Enable	Down	0	0	0	0	0	0
Port4	Enable	Down	0	0	0	0	0	0
Port5	Enable	Down	0	0	0	0	0	0
Port6	Enable	Up	1355316	11613	6544539	22163	0	0
Port7	Enable	Down	0	0	0	0	0	0

4.5.3 Port Band Restrict

The function provides the In-Band and Out-Band connection speed restriction on the ports. The Band of the connection speed ranges from 64Kbps to 80000Kbps.

Ingress Port List/Egress Port List field can be filled in distinct number or a port range. For example, you can fill with “1, 3” for port 1 and port 3 and “3-5” for port 3 to port 5.

Band(64~80000Kbps) field can be filled with any number between 64 and 80000.

Port Band Restrict

In-Band Restrict	
Ingress Port List	Band(500~80000Kbps)
<input type="text"/>	<input type="text"/> Kbps

Out-Band Restrict	
Egress Port List	Band(64~80000Kbps)
<input type="text"/>	<input type="text"/> Kbps

OK

Port Status			
Port	In-Band Restrict(Kbps)	Out-Band Restrict(Kbps)	Delete
1	500	64	<input type="button" value="Delete"/>
2	500	64	<input type="button" value="Delete"/>
3	500	64	<input type="button" value="Delete"/>
4	N/A	N/A	<input type="button" value="Delete"/>
5	N/A	N/A	<input type="button" value="Delete"/>



NOTICE:

Due to the Chipset limitation, set the band rate large then **500Kbps** at **In-Band Restrict** field.

If this value is less than 500Kbps and the packet will drop on that time.

And please also be remind, enable **flow control** at specific port is required.

4.6 Redundancy

4.6.1 Spanning Tree

1. Spanning Tree Protocol

The IEEE 802.1D Spanning Tree Protocol and IEEE 802.1W Rapid Spanning Tree Protocol allow for the blocking of links between switches that form loops within the network. When multiple links between switches are detected, a primary link is established. Duplicated links are blocked from use and become standby links. The protocol allows for the duplicate links to be used in the event of a failure of the primary link. Once the Spanning Tree Protocol is configured and enabled, primary links are established and duplicated links are blocked automatically. The reactivation of the blocked links (at the time of a primary link failure) is also accomplished automatically without operator intervention.

This automatic network reconfiguration provides maximum uptime to network users. However, the concepts of the Spanning Tree Algorithm and protocol are a complicated and complex subject and must be fully researched and understood. It is possible to cause serious degradation of the performance of the network if the Spanning Tree is incorrectly configured. Please read the following before making any changes from the default values.

The Switch STP performs the following functions:

- Creates a single spanning tree from any combination of switching or bridging elements.
- Creates multiple spanning trees – from any combination of ports contained within a single switch, in user specified groups.
- Automatically reconfigures the spanning tree to compensate for the failure, addition, or removal of any element in the tree.
- Reconfigures the spanning tree without operator intervention.

Bridge Protocol Data Units

For STP to arrive at a stable network topology, the following information is used:

- The unique switch identifier
- The path cost to the root associated with each switch port
- The port identifier

STP communicates between switches on the network using Bridge Protocol Data Units (BPDUs). Each BPDU contains the following information:

- The unique identifier of the switch that the transmitting switch currently believes is the root switch
- The path cost to the root from the transmitting port
- The port identifier of the transmitting port

The switch sends BPDUs to communicate and construct the spanning-tree topology. All switches connected to the LAN on which the packet is transmitted will receive the BPDU. BPDUs are not directly forwarded by the switch, but the receiving switch uses the information in the frame to calculate a BPDU, and, if the topology changes, initiates a BPDU transmission.

The communication between switches via BPDUs results in the following:

- One switch is elected as the root switch
- The shortest distance to the root switch is calculated for each switch
- A designated switch is selected. This is the switch closest to the root switch through which packets will be forwarded to the root.
- A port for each switch is selected. This is the port providing the best path from the switch to the root switch.
- Ports included in the STP are selected.

Creating a Stable STP Topology

It is to make the root port a fastest link. If all switches have STP enabled with default settings, the switch with the lowest MAC address in the network will become the root switch. By increasing the priority (lowering the priority number) of the best switch, STP can be forced to select the best switch as the root switch.

When STP is enabled using the default parameters, the path between source and destination stations in a switched network might not be ideal. For instance, connecting higher-speed links to a port that has a higher number than the current root port can cause a root-port change.

STP Port States

The BPDUs take some time to pass through a network. This propagation delay can result in topology changes where a port that transitioned directly from a Blocking state to a Forwarding state could create temporary data

loops. Ports must wait for new network topology information to propagate throughout the network before starting to forward packets. They must also wait for the packet lifetime to expire for BPDU packets that were forwarded based on the old topology. The forward delay timer is used to allow the network topology to stabilize after a topology change. In addition, STP specifies a series of states a port must transition through to further ensure that a stable network topology is created after a topology change.

Each port on a switch using STP exists in one of the following five states:

- **Blocking** – the port is blocked from forwarding or receiving packets
- **Listening** – the port is waiting to receive BPDU packets that may tell the port to go back to the blocking state
- **Learning** – the port is adding addresses to its forwarding database, but not yet forwarding packets
- **Forwarding** – the port is forwarding packets
- **Disabled** – the port only responds to network management messages and must return to the blocking state first

A port transitions from one state to another as follows:

- From initialization (switch boot) to blocking
- From blocking to listening or to disabled
- From listening to learning or to disabled
- From learning to forwarding or to disabled
- From forwarding to disabled
- From disabled to blocking

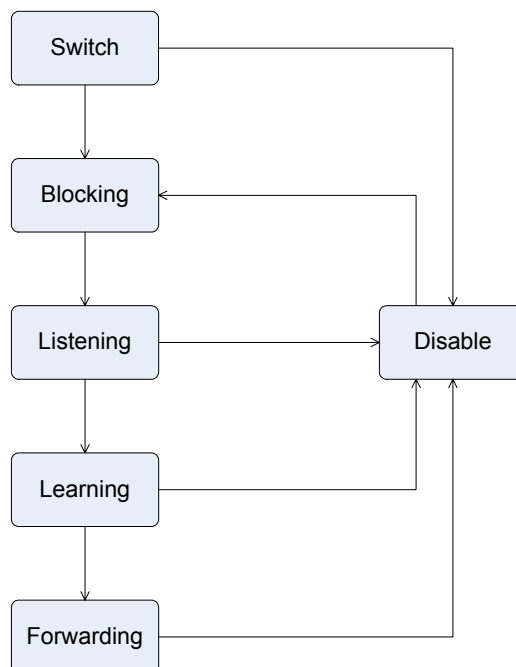

STP Port State Transitions

You can modify each port state by using management software. When you enable STP, every port on every switch in the network goes through the blocking state and then transitions through the states of listening and learning at

power up. If properly configured, each port stabilizes to the forwarding or blocking state. No packets (except BPDUs) are forwarded from, or received by, STP enabled ports until the forwarding state is enabled for that port.

2. STP Parameters

STP Operation Levels

The Switch allows for two levels of operation: the switch level and the port level. The switch level forms a spanning tree consisting of links between one or more switches. The port level constructs a spanning tree consisting of groups of one or more ports. The STP operates in much the same way for both levels.



NOTICE: On the switch level, STP calculates the Bridge Identifier for each switch and then sets the Root Bridge and the Designated Bridges.

On the port level, STP sets the Root Port and the Designated Ports.

The following are the user-configurable STP parameters for the switch level:

Parameter	Description	Default Value
Bridge Identifier(Not user configurable except by setting priority below)	A combination of the User-set priority and the switch's MAC address. The Bridge Identifier consists of two parts: a 16-bit priority and a 48-bit Ethernet MAC address 32768 + MAC	32768 + MAC
Priority	A relative priority for each switch – lower numbers give a higher priority and a greater chance of a given switch being elected as the root bridge	32768
Hello Time	The length of time between broadcasts of the hello message by the switch	2 seconds
Maximum Age Timer	Measures the age of a received BPDU for a port and ensures that the BPDU is discarded when its age exceeds the value of the maximum age timer.	20 seconds
Forward Delay Timer	The amount time spent by a port in the learning and listening states waiting for a BPDU that may return the port to the blocking state.	15 seconds

The following are the user-configurable STP parameters for the port or port group level:

Variable	Description	Default Value
----------	-------------	---------------

Port Priority	A relative priority for each port –lower numbers give a higher priority and a greater chance of a given port being elected as the root port	32768
Port Cost	A value used by STP to evaluate paths – STP calculates path costs and selects the path with the minimum cost as the active path	19-100Mbps Fast Ethernet ports 4-1000Mbps Gigabit Ethernet ports

Default Spanning-Tree Configuration

Feature	Default Value
Enable state	STP enabled for all ports
Port priority	128
Port cost	19
Bridge Priority	32,768

User-Changeable STA Parameters

The Switch's factory default setting should cover the majority of installations. However, it is advisable to keep the default settings as set at the factory; unless, it is absolutely necessary. The user changeable parameters in the Switch are as follows:

Priority – A Priority for the switch can be set from 0 to 65535. 0 is equal to the highest Priority.

Hello Time – The Hello Time can be from 1 to 10 seconds. This is the interval between two transmissions of BPDU packets sent by the Root Bridge to tell all other Switches that it is indeed the Root Bridge. If you set a Hello Time for your Switch, and it is not the Root Bridge, the set Hello Time will be used if and when your Switch becomes the Root Bridge.



NOTICE: The Hello Time cannot be longer than the Max. Age. Otherwise, a configuration error will occur.

Max. Age – The Max Age can be from 6 to 40 seconds. At the end of the Max Age, if a BPDU has still not been received from the Root Bridge, your Switch will start sending its own BPDU to all other Switches for permission to become the Root Bridge. If it turns out that your Switch has the lowest Bridge Identifier, it will become the Root Bridge.

Forward Delay Timer – The Forward Delay can be from 4 to 30 seconds. This is the time any port on the Switch spends in the listening state while moving from the blocking state to the forwarding state.



NOTICE: Observe the following formulas when setting the above parameters:

Max. Age $\geq 2 \times$ (Forward Delay - 1 second)

Max. Age = 2 x (Hello Time + 1 second)

Port Priority – A Port Priority can be from 0 to 255. The lower the number, the greater the probability the port will be chosen as the Root Port.

Port Cost – A Port Cost can be set from 0 to 65535. The lower the number, the greater the probability the port will be chosen to forward packets.

3. Illustration of STP

A simple illustration of three switches connected in a loop is depicted in Figure 5-7. In this example, you can anticipate some major network problems if the STP assistance is not applied. If switch A broadcasts a packet to switch B, switch B will broadcast it to switch C, and switch C will broadcast it to back to switch A ... and so on. The broadcast packet will be passed indefinitely in a loop, potentially causing a network failure. In this example, STP breaks the loop by blocking the connection between switch B and C. The decision to block a particular connection is based on the STP calculation of the most current Bridge and Port settings. Now, if switch A broadcasts a packet to switch C, then switch C will drop the packet at port 2 and the broadcast will end there. Setting-up STP using values other than the defaults, can be complex. Therefore, you are advised to keep the default factory settings and STP will automatically assign root bridges/ports and block loop connections. Influencing STP to choose a particular switch as the root bridge using the Priority setting, or influencing STP to choose a particular port to block using the Port Priority and Port Cost settings is, however, relatively straight forward.

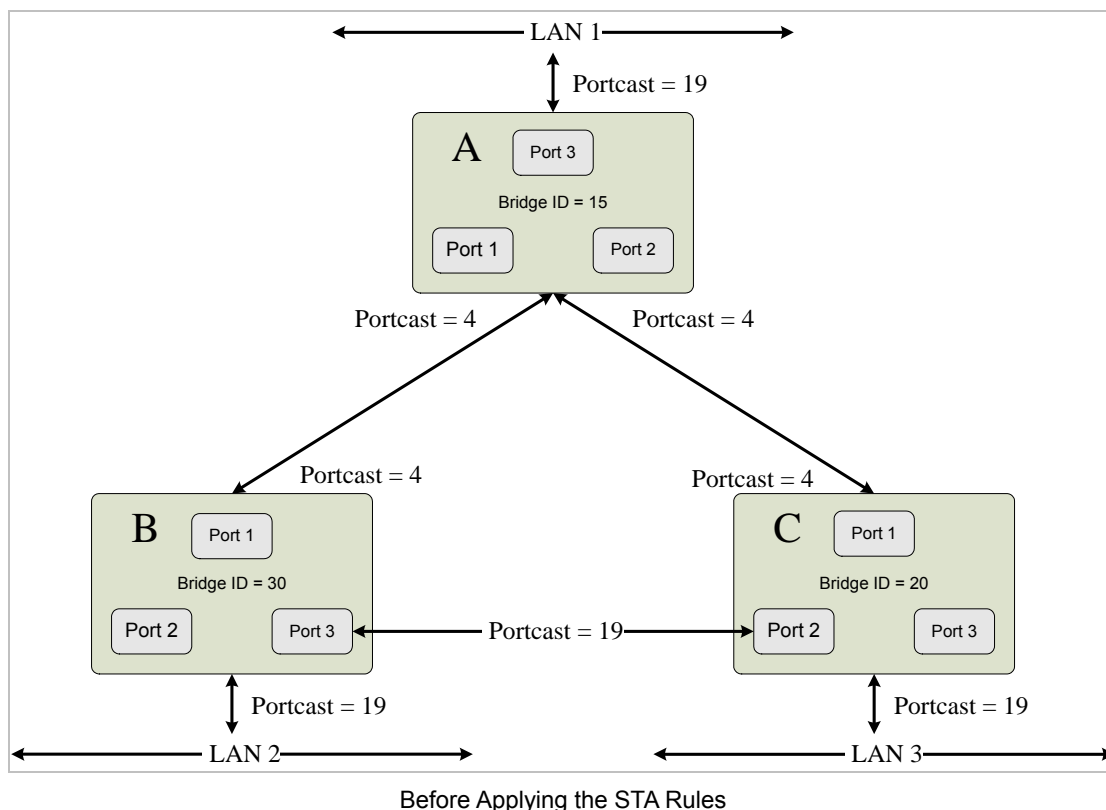

In this example, only the default STP values are used.

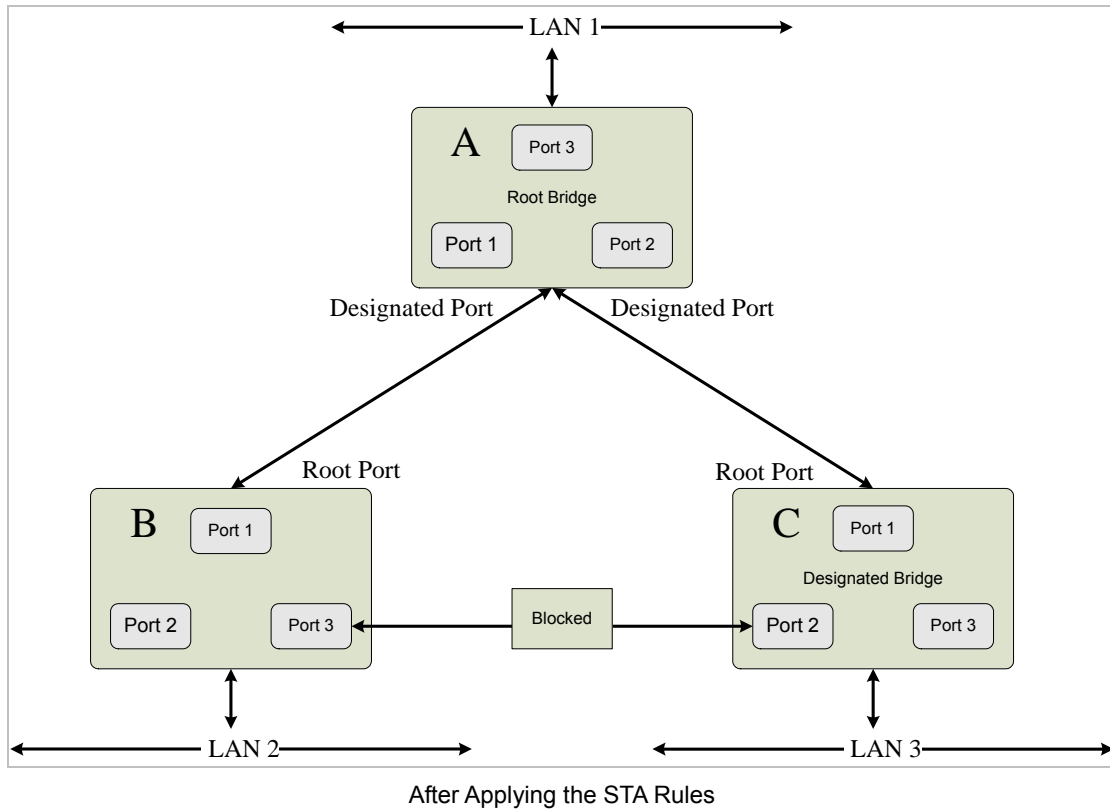

The switch with the lowest Bridge ID (switch C) was elected the root bridge, and the ports were selected to give a high port cost between switches B and C. The two (optional) Gigabit ports (default port cost = 4) on switch A are connected to one (optional) Gigabit port on both switch B and C. The redundant link between switch B and C is deliberately chosen as a 100 Mbps Fast Ethernet link (default port cost = 19). Gigabit ports could be used, but the port cost should be increased from the default to ensure that the link between switch B and switch C is the blocked link.

4.6.2 Spanning Tree Configuration

The Spanning Tree Protocol (STP) operates on two levels: On the switch level, the settings are globally implemented. On the port level, the settings are implemented on a per user-defined Group of ports.

1. Spanning Tree Configuration

The “**Rapid Spanning Tree Bridge Configure**” table allows configuring the spanning tree parameters.

Rapid Spanning Tree Status: The spanning tree function of the switch is default disabled. This field enables to turn on the spanning tree on the switch.

Force Protocol Version: 0 for IEEE 802.1D Spanning Tree, 2 for IEEE 802.1W Rapid Spanning Tree

Max Age: (6 - 40 sec) the default setting is 20

Hello Time: (1 - 10sec) the default setting is 2

Forward Delay: (4 -30 sec) the default setting is 15

Bridge Priority: (0 - 61440) the default setting is 32768

Rapid Spanning Tree Bridge Configuration	
Rapid Spanning Tree Status:	Enable ▾
Force Protocol Version :	2 ▾
Max Age(6-40s):	20
Hello Time(1-10s):	2
Forward Delay(4-30s):	15
Bridge Priority(0-61440):	32768
OK	

2. Bridge Information

The informations of the STP Root show in the Bridge Information table.

Bridge Information	
Root Bridge Priority:	32768
Root Bridge MAC:	00-00-01-01-02-02
Root Path Cost:	0
Root Port:	N/A
Root Bridge MAX age:	20
Root Bridge Hello Time:	2
Root Bridge Forward Delay:	15

3. STP Port Configuration

On the STP port configuration, the settings are implemented on a per user-defined Group of ports.

RSTP Port Configuration				
Port List(e.g. 1-3,7)	Edge Port	P2P Status	Path Cost(0-200000000,0 means Auto)	Port Priority(0-240)
	True ▾	Auto ▾		
OK				

The following fields can be set for STP port configuration:

Edge Port: Defines if this port connected directly to a single workstation, or this port that is directly connected to a LAN segment where a loop cannot be created. For example, this port is connected to a **PC, Print-Server, IP camera** or any other network end-node device. Since end nodes **cannot** cause forwarding loops, they can pass directly through to the spanning tree forwarding state.

There are two selections for this function:

- **True** - This port connected directly to a end-node device or LAN segment where a loop cannot be created
- **False** – This port connected to one or more LAN segments – maybe a ethernet switch or HUB, that a loop might be occurred

P2P Status: Enables or disables the device to establish a point-to-point link, or specifies for the device to automatically establish a point-to-point link. A P2P port is also capable of rapid transition. P2P ports may be used

to connect to other bridges. Under RSTP, all ports operating in full-duplex mode are considered to be P2P ports, unless manually overridden through configuration.

The link type attached to this port could be selected as following:

- **Auto** - The switch automatically determines if the interface is attached to a point-to-point link or to shared media
- **True** – A connection to exactly one other bridge.
- **False** - A connection to two or more bridges.

Port Priority: Defines if this port is more or less likely to become the root port. The range is from 0 to 255, the default setting is 128. The lower number has the highest priority.

Path Cost: Specifies the path cost of the port. The switch uses this parameter to help determine which port will become a forwarding port. Lower numbers will be used as forwarding ports first. The range is from 0 to 65535. The default values based on IEEE802.1D are: 10Mb/s = 50-600, 100Mb/s = 10-60, 1000Mb/s = 3-10

4.6.3 Link Aggregation

The Link Aggregation Control Protocol (LACP) provides a standardized means for exchanging information between Partner Systems that require high speed redundant links. Link aggregation lets you group up to eight consecutive ports into a single dedicated connection. This feature can expand bandwidth to a device on the network. LACP operation requires full-duplex mode, more detail information refer to the IEEE 802.3ad standard.

Link aggregation can be used to increase the bandwidth of a network connection or to ensure fault recovery. Link aggregation lets you group up consecutive ports into a single dedicated connection between any two of the Switches or other Layer 2 switches. However, before making any physical connections between devices, use the Link Aggregation menu to specify the link aggregation on the devices at both ends. When using a port link aggregation, note that:

- The ports used in a link aggregation must all be of the same media type (RJ-45, 100 Mbps fiber).
- The ports that can be assigned to the same link aggregation have certain other restrictions (see below).
- Ports can only be assigned to one link aggregation.
- The ports at both ends of a connection must be configured as link aggregation ports.
- None of the ports in a link aggregation can be configured as a mirror source port or a mirror target port.
- All of the ports in a link aggregation have to be treated as a whole when moved from/to, added or deleted from a VLAN.
- The Spanning Tree Protocol will treat all the ports in a link aggregation as a whole.
- Enable the link aggregation prior to connecting any cable between the switches to avoid creating a data loop.
- Disconnect all link aggregation port cables or disable the link aggregation ports before removing a port link aggregation to avoid creating a data loop.

It allows a maximum of four ports to be aggregated at the same time and up to 4 groups. If the group is defined as a LACP static link aggregating group, then any extra ports selected are placed in a standby mode for redundancy if one of the other ports fails. If the group is defined as a local static link aggregating group, then the number of ports must be the same as the group member ports.

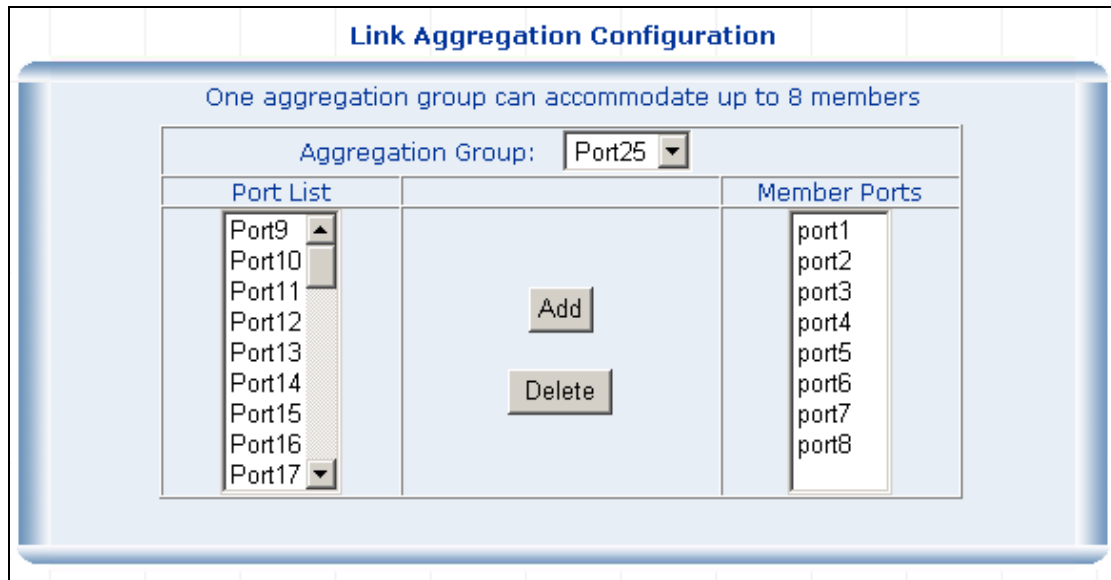

4.7 Security

4.7.1 VLAN

4.7.1.1 Theory

Understanding IEEE 802.1p Priority

Priority tagging is a function defined by the IEEE 802.1p standard designed to provide a means of managing traffic on a network where many different types of data may be transmitted simultaneously. It is intended to alleviate problems associated with the delivery of time critical data over congested networks. The quality of applications that are dependent on such time critical data, such as video conferencing, can be severely and adversely affected by even very small delays in transmission.

Network devices that are in compliance with the IEEE 802.1p standard have the ability to recognize the priority level of data packets. These devices can also assign a priority label or tag to packets. Compliant devices can also strip priority tags from packets. This priority tag determines the packet's degree of expeditiousness and determines the queue to which it will be assigned.

Priority tags are given values from 0 to 7 with 0 being assigned to the lowest priority data and 7 assigned to the highest. The highest priority tag 7 is generally only used for data associated with video or audio applications, which are sensitive to even slight delays, or for data from specified end users whose data transmissions warrant

special consideration.

The Switch allows you to further tailor how priority tagged data packets are handled on your network. Using queues to manage priority tagged data allows you to specify its relative priority to suit the needs of your network. There may be circumstances where it would be advantageous to group two or more differently tagged packets into the same queue. Generally, however, it is recommended that the highest priority queue, Queue 1, be reserved for data packets with a priority value of 7. Packets that have not been given any priority value are placed in Queue 0 and thus given the lowest priority for delivery.

A weighted round robin system is employed on the Switch to determine the rate at which the queues are emptied of packets. The ratio used for clearing the queues is 4:1. This means that the highest priority queue, Queue 1, will clear 4 packets for every 1 packet cleared from Queue 0.

Remember, the priority queue settings on the Switch are for all ports, and all devices connected to the Switch will be affected. This priority queuing system will be especially beneficial if your network employs switches with the capability of assigning priority tags.

VLAN Description

A Virtual Local Area Network (VLAN) is a network topology configured according to a logical scheme rather than the physical layout. VLAN can be used to combine any collection of LAN segments into an autonomous user group that appears as a single LAN. VLAN also logically segment the network into different broadcast domains so that packets are forwarded only between ports within the VLAN. Typically, a VLAN corresponds to a particular subnet, although not necessarily.

VLAN can enhance performance by conserving bandwidth, and improve security by limiting traffic to specific domains.

A VLAN is a collection of end nodes grouped by logic instead of physical location. End nodes that frequently communicate with each other are assigned to the same VLAN, regardless of where they are physically on the network. Logically, a VLAN can be equated to a broadcast domain, because broadcast packets are forwarded to only members of the VLAN on which the broadcast was initiated.



NOTICE:

1. No matter what basis is used to uniquely identify end nodes and assign these nodes VLAN membership, packets cannot cross VLAN without a network device performing a routing function between the VLAN.
2. The Switch supports Port-based VLAN and IEEE 802.1Q VLAN. The port untagging function can be used to remove the 802.1 tag from packet headers to maintain compatibility with devices that are tag-unaware.
3. The Switch's default is to assign all ports to a single 802.1Q VLAN named DEFAULT_VLAN. As new VLAN is created, the member ports assigned to the new VLAN will be removed from the

DEFAULT_VLAN port member list. The DEFAULT_VLAN has a VID = 1.

Port-based VLAN

Port-based VLAN limit traffic that flows into and out of switch ports. Thus, all devices connected to a port are members of the VLAN(s) the port belongs to, whether there is a single computer directly connected to a switch, or an entire department.

On port-based VLAN, NIC do not need to be able to identify 802.1Q tags in packet headers. NIC send and receive normal Ethernet packets. If the packet's destination lies on the same segment, communications take place using normal Ethernet protocols. Even though this is always the case, when the destination for a packet lies on another switch port, VLAN considerations come into play to decide if the packet is dropped by the Switch or delivered.

IEEE 802.1Q VLANs

IEEE 802.1Q (tagged) VLAN are implemented on the Switch. 802.1Q VLAN require tagging, which enables them to span the entire network (assuming all switches on the network are IEEE 802.1Q-compliant).

VLAN allow a network to be segmented in order to reduce the size of broadcast domains. All packets entering a VLAN will only be forwarded to the stations (over IEEE 802.1Q enabled switches) that are members of that VLAN, and this includes broadcast, multicast and unicast packets from unknown sources.

VLAN can also provide a level of security to your network. IEEE 802.1Q VLAN will only deliver packets between stations that are members of the VLAN. Any port can be configured as either tagging or untagging. The untagging feature of IEEE 802.1Q VLAN allows VLAN to work with legacy switches that don't recognize VLAN tags in packet headers. The tagging feature allows VLAN to span multiple 802.1Q-compliant switches through a single physical connection and allows Spanning Tree to be enabled on all ports and work normally.

Any port can be configured as either tagging or untagging. The untagging feature of IEEE 802.1Q VLAN allow VLAN to work with legacy switches that don't recognize VLAN tags in packet headers. The tagging feature allows VLAN to span multiple 802.1Q-compliant switches through a single physical connection and allows Spanning Tree to be enabled on all ports and work normally.

Some relevant terms:

Tagging - The act of putting 802.1Q VLAN information into the header of a packet.

Untagging - The act of stripping 802.1Q VLAN information out of the packet header.

802.1Q VLAN Tags

The figure below shows the 802.1Q VLAN tag. There are four additional octets inserted after the source MAC address. Their presence is indicated by a value of 0x8100 in the Ether Type field. When a packet's Ether Type field is equal to 0x8100, the packet carries the IEEE 802.1Q/802.1p tag. The tag is contained in the following two octets and consists of 3 bits of user priority, 1 bit of Canonical Format Identifier (CFI - used for encapsulating Token Ring packets so they can be carried across Ethernet backbones), and 12 bits of VLAN ID (VID). The 3 bits of user

priority are used by 802.1p. The VID is the VLAN identifier and is used by the 802.1Q standard. Because the VID is 12 bits long, 4094 unique VLAN can be identified.

The tag is inserted into the packet header making the entire packet longer by 4 octets. All of the information originally contained in the packet is retained.

802.1Q Tag

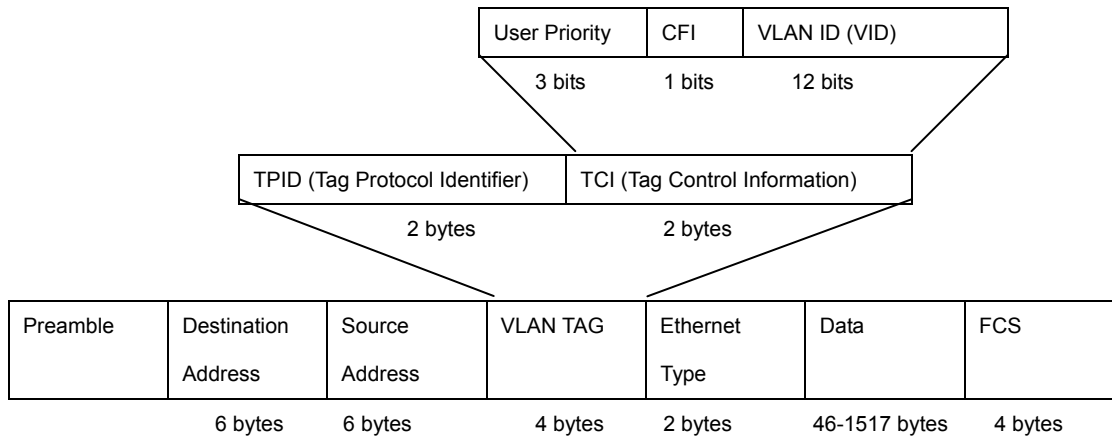

The Ether Type and VLAN ID are inserted after the MAC source address, but before the original Ether Type/Length or Logical Link Control. Because the packet is now a bit longer than it was originally, the Cyclic Redundancy Check (CRC) must be recalculated.

Adding an IEEE802.1Q Tag

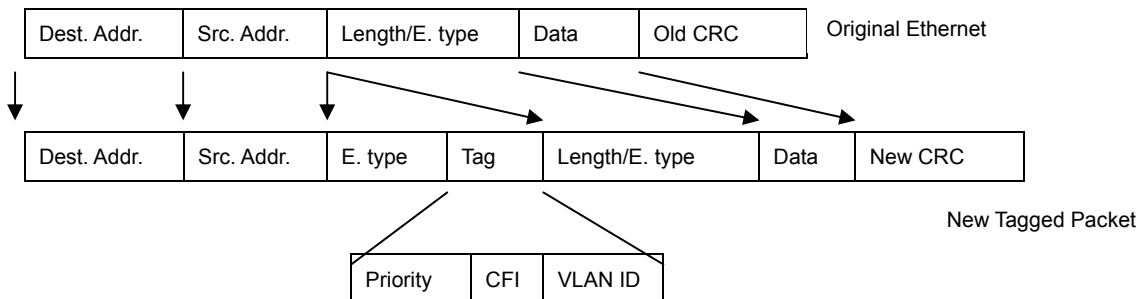

Port VLAN ID

Packets that are tagged (are carrying the 802.1Q VID information) can be transmitted from one 802.1Q compliant network device to another with the VLAN information intact. This allows 802.1Q VLAN to span network devices (and indeed, the entire network – if all network devices are 802.1Q compliant).

Every physical port on a switch has a PVID. 802.1Q ports are also assigned a PVID, for use within the switch. If no VLAN are defined on the switch, all ports are then assigned to a default VLAN with a PVID equal to 1. Untagged packets are assigned the PVID of the port on which they were received. Forwarding decisions are based upon this PVID, in so far as VLAN are concerned. Tagged packets are forwarded according to the VID contained within the tag. Tagged packets are also assigned a PVID, but the PVID is not used to make packet forwarding decisions, the VID is.

Tag-aware switches must keep a table to relate PVID within the switch to VID on the network. The switch will compare the VID of a packet to be transmitted to the VID of the port that is to transmit the packet. If the two VID are different the switch will drop the packet. Because of the existence of the PVID for untagged packets and the VID for tagged packets, tag-aware and tag-unaware network devices can coexist on the same network.

A switch port can have only one PVID, but can have as many VID as the switch has memory in its VLAN table to store them.

Because some devices on a network may be tag-unaware, a decision must be made at each port on a tag-aware device before packets are transmitted – should the packet to be transmitted have a tag or not? If the transmitting port is connected to a tag-unaware device, the packet should be untagged. If the transmitting port is connected to a tag-aware device, the packet should be tagged.

Default VLANs

The Switch initially configures one VLAN, VID = 1, called "**default**." The factory default setting assigns all ports on the Switch to the "**default**". As new VLAN are configured in Port-based mode, their respective member ports are removed from the "default."

VLAN and Trunk Groups

In order to use VLAN segmentation in conjunction with port trunk groups, you can first set the port trunk group(s), and then you may configure VLAN settings. If you wish to change the port trunk grouping with VLAN already in place, you will not need to reconfigure the VLAN settings after changing the port trunk group settings. VLAN settings will automatically change in conjunction with the change of the port trunk group settings

4.7.1.2 VLAN Configuration

Port-based VLAN Configuration

Packets can only be broadcast among other members of the same VLAN group. Note all unselected ports are treated as belonging to the default system VLAN. If port-based VLAN are enabled, then VLAN-tagging is ignored.

1. On **VLAN Configuration** table, choose **Port-based VLAN**. Click on the "**OK**" button.

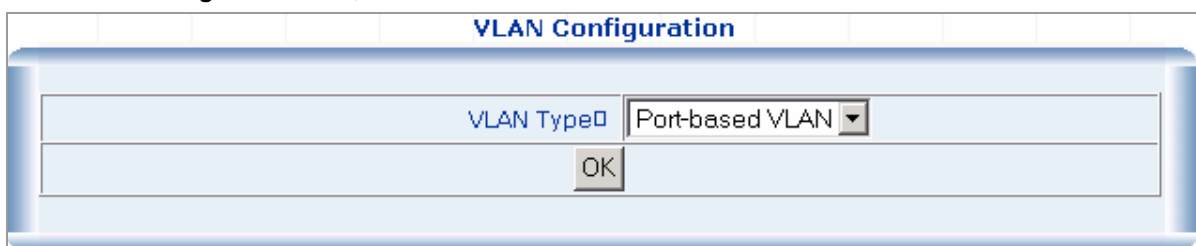

2. The main page then change to **Port-base VLAN** table, click on the "**Add/Modify**" button to create a new VLAN group.

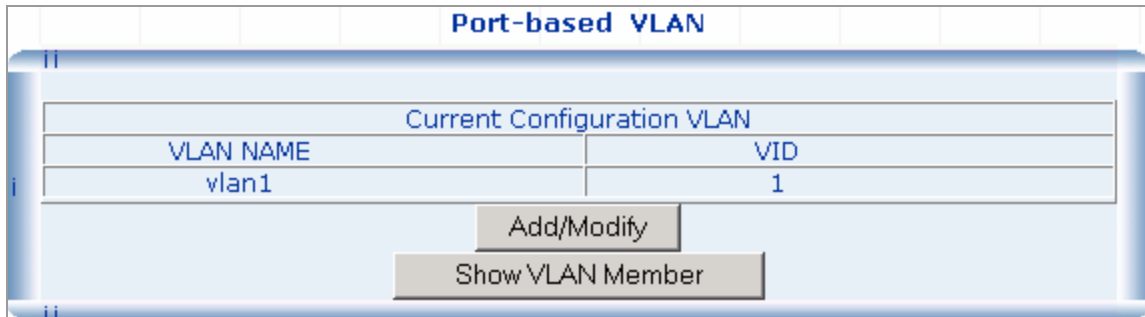

3. The **Port-base VLAN Confirutation** table then pops up, enter the VLAN group ID, VLAN name and select the member ports for the VLAN.

4. Click the “OK” button to add the VLAN.

5. Select the ports in the **Port List** field and click on the Add button to add the member ports to the VLAN. The selected VLAN member then shows in the **VLAN Member** field.

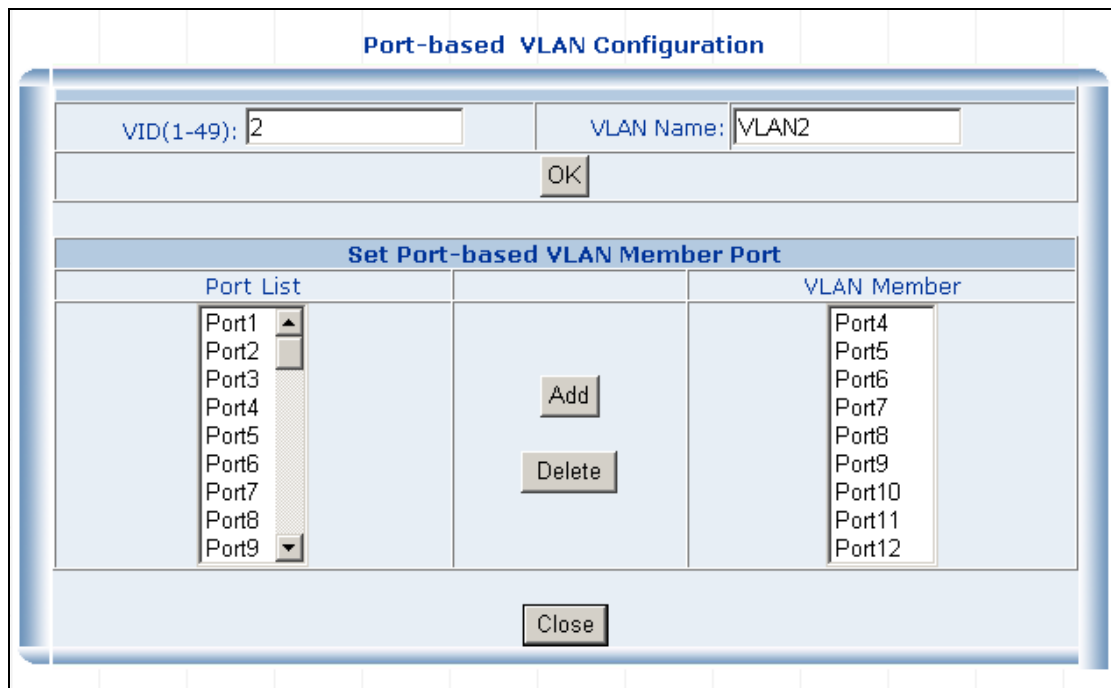

6. Click on the “Close” button and back to the **Port-based VLAN** main page.

The “**Show VLAN Member**” button is to list the valid VLANs. You can also remove the added VALN by click on this button.

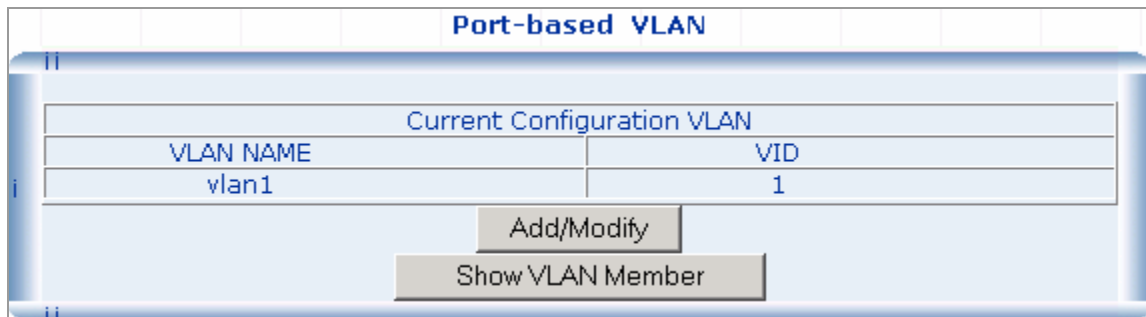

802.1Q VLAN Configuration

There are up to 256 configurable VLAN groups. By default when 802.1Q is enabled, all ports on the switch belong to default VLAN (VID 1). The default VLAN cannot be deleted.

Understand nomenclature of the Switch

Tagging and Untagging

Every port on an 802.1Q compliant switch can be configured as tagging or untagging.

- **Tagging:** Ports with tagging enabled will put the VID number, priority and other VLAN information into the header of all packets that flow into those ports. If a packet has previously been tagged, the port will not alter the packet, thus keeping the VLAN information intact. The VLAN information in the tag can then be used by other 802.1Q compliant devices on the network to make packet-forwarding decisions.
- **Untagging:** Ports with untagging enabled will strip the 802.1Q tag from all packets that flow into those ports. If the packet doesn't have an 802.1Q VLAN tag, the port will not alter the packet. Thus, all packets received by and forwarded by an untagging port will have no 802.1Q VLAN information. (Remember that the PVID is only used internally within the Switch). Untagging is used to send packets from an 802.1Q-compliant network device to a non-compliant network device.

Frame Income / Frame Leave	Income Frame is tagged	Income Frame is untagged
Leave port is tagged	Frame remains tagged	Tag is inserted
Leave port is untagged	Tag is removed	Frame remain untagged

Here pay attention to the explanation of “Access”, “Always Untag” and “Trunk”.

- **Access:** Ports will strip the 802.1Q tag from all packets that out of those ports. If the packet doesn't have an 802.1Q VLAN tag, the port will not alter the packet. Thus, all packets received by and forwarded by an untagging port will have no 802.1Q VLAN information. Untagging is used to send packets from an 802.1Q-compliant network device to a non-compliant network device.
Ports with “Access” mode belong to a single untagged VLAN.
- **Trunk:** Ports with tagging enabled will put the VID number, priority and other VLAN information into the header of all packets that out of those ports. If a packet has previously been tagged, the port will not alter the packet, thus keeping the VLAN information intact. The VLAN information in the tag can then be used by other 802.1Q compliant devices on the network to make packet forwarding decisions.
- **Always Untag:** The port belongs to VLANs, and each VLAN is user-defined as tagged or untagged (full 802.1Q mode). Ports will strip the 802.1Q tag from all packets that out of those ports.

Port Mode	VLAN Membership	Frame Leave
Access	Belongs to a single untagged VLAN	Untagged (Tag=PVID be removed)
Always Untag	Allowed to belongs to multiple untagged VLANs at the same time	Untagged (Tag=PVID be removed)
Trunk	Allowed to belongs to multiple Tagged VLANs at the same time	Tagged (Tag=PVID or Original VID be remained)

Port VID (PVID)

Set the port VLAN ID that will be assigned to untagged traffic on a given port. This feature is useful for accommodating devices that you want to participate in the VLAN but that don't support tagging. The Switch allows each port to set one PVID, the range is 1~255, default PVID is 1. The PVID must be the same as the VLAN ID that the port was defined as belonging to in the VLAN group, or the untagged traffic will be dropped.

1. Select **802.1Q VLAN** in the **VLAN Type** field and click on the "OK" button.

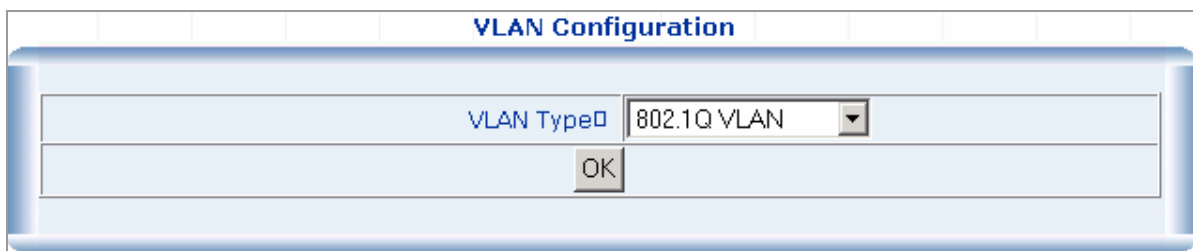

The main page then changes to the **802.1Q VLAN** table which displays the VLAN configuration of each port.

802.1Q VLAN			
Port	Link Type	PVID	Egress Policy
Port1	Access	1	Untagged=1
Port2	Access	1	Untagged=1
Port3	Access	1	Untagged=1
Port4	Access	1	Untagged=1
Port5	Access	1	Untagged=1
Port6	Access	1	Untagged=1
Port7	Access	1	Untagged=1
Port8	Access	1	Untagged=1

2. If you want to configure port #2 to be in a VLAN other than default VLAN. Double click on "port2" to enter into VLAN port configuration window.

802.1Q VLAN Port Configuration---Port 2

Link Type: PVID:

Set Trunk Port for VLAN

VLAN Table		VLAN with The Trunk Port								
<table border="1" style="width: 100%; border-collapse: collapse;"> <thead> <tr> <th style="width: 15%;">VID</th> <th style="width: 85%;">VLAN NAME</th> </tr> </thead> <tbody> <tr> <td style="text-align: center;">1</td> <td>default vlan</td> </tr> </tbody> </table>	VID	VLAN NAME	1	default vlan	<input type="button" value="Add"/> <input type="button" value="Delete"/>	<table border="1" style="width: 100%; border-collapse: collapse;"> <thead> <tr> <th style="width: 15%;">VID</th> <th style="width: 85%;">VLAN NAME</th> </tr> </thead> <tbody> <tr> <td> </td> <td> </td> </tr> </tbody> </table>	VID	VLAN NAME		
VID	VLAN NAME									
1	default vlan									
VID	VLAN NAME									

Set VLAN's VID & Name

VID VLAN Name

3. Choose the **Link Type** in the drop down menu: **Access** , **Always Untag** or **Trunk**.

Note that if the **Access** type is chosen, it will strip the 802.1Q tag from all packets that out of this port. On the other hand, if the **Trunk** type is chosen, it will put the VID number, priority and other VLAN information into the header of all packets that out of this port. And if the **Always Untag** type is chosen, it will strip the 802.1Q tag from all packets that out of the port. But the port can be assigned to more than one VLAN group.

4. Define the PVID for the port

Set the port VLAN ID that will be assigned to untagged traffic on a given port. This feature is useful for accommodating devices that you want to participate in the VLAN but that don't support tagging.

Link Type: PVID:

5. Trunk configuration: If the **Trunk** type is chosen, please follow the steps to set the Trunk of the port.

5.1 Add and define the names and VIDs for new VLANs. The VID number ranges from 2 to 4094. Fill the **VID** field and the **VLAN Name** field in the **Set VLAN's VID & Name** table and click on the "**Add/Modify**" button to save.

Set VLAN's VID & Name

VID VLAN Name

5.2 The added new VLAN then shows the the **VLAN Table** field in the **Set Trunk Port for VLAN** table.

Set Trunk Port for VLAN										
VLAN Table		VLAN with The Trunk Port								
<table border="1"> <thead> <tr> <th>VID</th> <th>VLAN NAME</th> </tr> </thead> <tbody> <tr> <td>1</td> <td>default vlan</td> </tr> <tr> <td>2</td> <td>VLAN2</td> </tr> </tbody> </table>	VID	VLAN NAME	1	default vlan	2	VLAN2	<input type="button" value="Add"/> <input type="button" value="Delete"/>	<table border="1"> <thead> <tr> <th>VID</th> <th>VLAN NAME</th> </tr> </thead> <tbody> </tbody> </table>	VID	VLAN NAME
VID	VLAN NAME									
1	default vlan									
2	VLAN2									
VID	VLAN NAME									

5.3 Select on the VLAN which you want to tag with in the **VLAN Table** field and click on the “**Add**” button to add.

This will add the VLAN in to the **VLAN with The Trunk Port** field.

Set Trunk Port for VLAN										
VLAN Table		VLAN with The Trunk Port								
<table border="1"> <thead> <tr> <th>VID</th> <th>VLAN NAME</th> </tr> </thead> <tbody> <tr> <td>1</td> <td>default vlan</td> </tr> <tr style="background-color: #000080; color: white;"> <td>2</td> <td>VLAN2</td> </tr> </tbody> </table>	VID	VLAN NAME	1	default vlan	2	VLAN2	<input type="button" value="Add"/> <input type="button" value="Delete"/>	<table border="1"> <thead> <tr> <th>VID</th> <th>VLAN NAME</th> </tr> </thead> <tbody> </tbody> </table>	VID	VLAN NAME
VID	VLAN NAME									
1	default vlan									
2	VLAN2									
VID	VLAN NAME									

5.4 Click on the “**close**” button to close the VLAN port configuration table of port #2, and back to the 802.1Q main page.

5.5 Click on the “**Show VLAN Members**” button to show the VLAN members.

<input type="button" value="Show VLAN Members"/>
--

5.6 As shows in the following screen:

Show VLAN Member			
VID	VLAN Name	VLAN Member	Delete
1	vlan1	Port3.Port5.Port7.Port8.	<input type="button" value="Delete"/>
2	vlan2	Port1.Port2.Port4.Port6.	<input type="button" value="Delete"/>

4.7.2 MAC Address Bind

This function is based upon for the switch security. When you add one MAC Address is bind with one port. It remains in the switch's address table, regardless of whether the device is physically connected to the switch. This saves the switch from having to re-learn a device's MAC address after it has been disconnected or powered-off

from the network, and then reconnected at some time later. If the Network station is connected with one port want to control the switch, the station's MAC Address must be the same as one MAC Address

To bind the MAC Address, click on the **Security/MAC Address Binding** menu button, the main web page then shows the **MAC Address Bind** function table.

1. Fill the **MAC Address** field with MAC address in the format “**xx-xx-xx-xx-xx-xx** “ and choose the port to bind the MAC Address in the **Port** field.
2. Click on the “**Add**” button.
3. To remove the MAC Address bounded by the port. Simply click on the “**Delete**” button of the MAC Address in the **Show MAC Address Table**.

The screenshot shows the 'MAC Address Bind' web interface. At the top, there is a title 'MAC Address Bind'. Below it is a section titled 'Bind New MAC Address'. This section contains two input fields: 'MAC Address' with the value '00-E0-4F-48-3A-7E' and 'Port' with a dropdown menu set to 'Port1'. Below these fields is an 'Add' button. Underneath is a section titled 'Show Mac Address Table'. This section contains a table with three columns: 'MAC Address', 'Port', and 'Delete'.

MAC Address Bind		
Bind New MAC Address		
MAC Address	Port	
00-E0-4F-48-3A-7E	Port1	
Add		
Show Mac Address Table		
MAC Address	Port	Delete

The screenshot shows the 'MAC Address Bind' web interface after the MAC address has been added. The 'Bind New MAC Address' section now has empty input fields for 'MAC Address' and 'Port'. The 'Show Mac Address Table' section now contains one row with the MAC address '00-E0-4F-48-3A-7E' and 'Port1', and a 'Delete' button next to it.

MAC Address Bind		
Bind New MAC Address		
MAC Address	Port	
	Port1	
Add		
Show Mac Address Table		
MAC Address	Port	Delete
00-E0-4F-48-3A-7E	Port1	Delete

4.7.3 MAC Address Filtering

MAC address filtering allows the switch to drop unwanted traffic. Traffic is filtered based on the destination addresses.

To filter the MAC Address, click on the **Security/MAC Address Filtering** menu button, the main web page then shows the **MAC Address Filtering** function table.

1. Fill the **MAC Address** field with MAC address in the format “**xx-xx-xx-xx-xx-xx** “.
2. Click on the “**Add**” button to add.
3. To remove the MAC Address filtered by the port. Simply click on the “**Delete**” button of the MAC Address in the

Current Filtering MAC Table.

MAC Address Filtering	
Add New Mac Address	
MAC Address	
<input type="text" value="00-E0-4F-48-3A-7E"/>	
<input type="button" value="Add"/>	
Current Filtering MAC	
MAC Address	Delete

MAC Address Filtering	
Add New Mac Address	
MAC Address	
<input type="text"/>	
<input type="button" value="Add"/>	
Current Filtering MAC	
MAC Address	Delete
00-E0-4F-48-3A-7E	<input type="button" value="Delete"/>

4.7.4 MAC Address Learning

The switch is able to disable MAC Address learning function on ports.

1. Fill the **Port List** field in the **MAC Address Learning** table and select Enable/Disable in the **MAC Address Learning** field.
2. Click on the "OK" button to save.

MAC Address Learning

MAC Address Learning	
Port List(e.g. 1-3,7)	MAC Address Learning
<input type="text"/>	Disable ▾
OK	
Show Port Table	
Port	MAC Address Learning
Port1	Enable
Port2	Enable
Port4	Enable
Port6	Enable
Port7	Enable
Port9	Enable

4.7.5 MAC Address Aging Time

The Aging Time affects the learning process of the Switch. Dynamic forwarding table entries, which are made up of the source and destination MAC addresses and their associated port numbers, are deleted from the table if they are not accessed within the aging time.

The aging time can be from 30 to 1,000,000 seconds with a default value of 300 seconds. A very long aging time can result in dynamic forwarding table entries that are out-of-date or no longer exist. This may cause incorrect packet forward indecisions by the Switch.

If the Aging Time is too short however, many entries may be aged out too soon. This will result in a high percentage of received packets whose source addresses cannot be found in the forwarding table, in which case the switch will broadcast the packet to all ports, negating many of the benefits of having a switch.

Static forwarding entries are not affected by the aging time.

To set the Aging Time, enter the number in the **MAC Address Aging Time** field, and click on the “OK” button to save. The valid range is 30~1000 seconds. Default is 300 seconds.

MAC Address Aging Time Configuration

MAC Address Aging Time(30-1000s):	<input type="text" value="300"/>
OK	

4.7.6 802.1X Port-Based Network Access Control

4.7.6.1 Theory

Understanding IEEE 802.1X Port-Based Authentication

The IEEE 802.1X standard defines a client-server-based access control and authentication protocol that restricts unauthorized clients from connecting to a LAN through publicly accessible ports. The authentication server authenticates each client connected to a switch port before making available any services offered by the switch or the LAN.

Until the client is authenticated, 802.1X access control allows only Extensible Authentication Protocol over LAN (EAPOL) traffic through the port to which the client is connected. After authentication is successful, normal traffic can pass through the port.

This section includes this conceptual information:

- [Device Roles](#)
- [Authentication Initiation and Message Exchange](#)
- [Ports in Authorized and Unauthorized States](#)

■ Device Roles

With 802.1X port-based authentication, the devices in the network have specific roles as shown below.

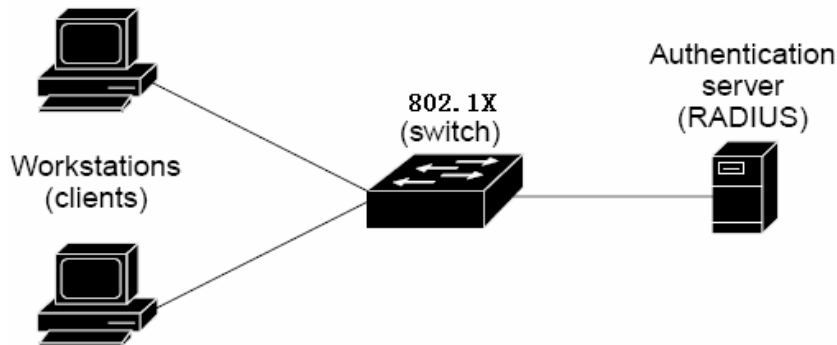

- **Client**—the device (workstation) that requests access to the LAN and switch services and responds to requests from the switch. The workstation must be running 802.1X-compliant client software such as that offered in the Microsoft Windows XP operating system. (The client is the *supplicant* in the IEEE 802.1X specification.)

- **Authentication server**—performs the actual authentication of the client. The authentication server validates the identity of the client and notifies the switch whether or not the client is authorized to access the LAN and switch services. Because the switch acts as the proxy, the authentication service is transparent to the client. In this release, the Remote Authentication Dial-In User Service (RADIUS) security system with Extensible Authentication Protocol (EAP) extensions is the only supported authentication server; it is available in Cisco Secure Access Control Server version 3.0. RADIUS operates in a client/server model in which secure authentication information is exchanged between the RADIUS server and one or more RADIUS clients.

- **Switch (802.1X device)**—controls the physical access to the network based on the authentication status of the client. The switch acts as an intermediary (proxy) between the client and the authentication server, requesting identity information from the client, verifying that information with the authentication server, and relaying a response to the client. The switch includes the RADIUS client, which is responsible for encapsulating and decapsulating the Extensible Authentication Protocol (EAP) frames and interacting with the authentication server. When the switch receives EAPOL frames and relays them to the authentication server, the Ethernet header is stripped and the remaining EAP frame is re-encapsulated in the RADIUS format. The EAP frames are not modified or examined during encapsulation, and the authentication server must support EAP within the native frame format. When the switch receives frames from the authentication server, the server's frame header is removed, leaving the EAP frame, which is then encapsulated for Ethernet and sent to the client.

■ Authentication Initiation and Message Exchange

The switch or the client can initiate authentication. If you enable authentication on a port by using the **dot1x port-control auto** interface configuration command, the switch must initiate authentication when it determines that the port link state transitions from down to up. It then sends an EAP-request/identity frame to the client to request its identity (typically, the switch sends an initial identity/request frame followed by one or more requests for authentication information). Upon receipt of the frame, the client responds with an EAP-response/identity frame.

However, if during bootup, the client does not receive an EAP-request/identity frame from the switch, the client can initiate authentication by sending an EAPOL-start frame, which prompts the switch to request the client's identity



NOTICE:

If 802.1X is not enabled or supported on the network access device, any EAPOL frames from the client are

dropped. If the client does not receive an EAP-request/identity frame after three attempts to start authentication, the client transmits frames as if the port is in the authorized state. A port in the authorized state effectively means that the client has been successfully authenticated.

When the client supplies its identity, the switch begins its role as the intermediary, passing EAP frames between the client and the authentication server until authentication succeeds or fails. If the authentication succeeds, the switch port becomes authorized. For more information, see the ["Ports in Authorized and Unauthorized States"](#) section

The specific exchange of EAP frames depends on the authentication method being used. "Figure 2-43" shows a message exchange initiated by the client using the One-Time-Password (OTP) authentication method with a RADIUS server.

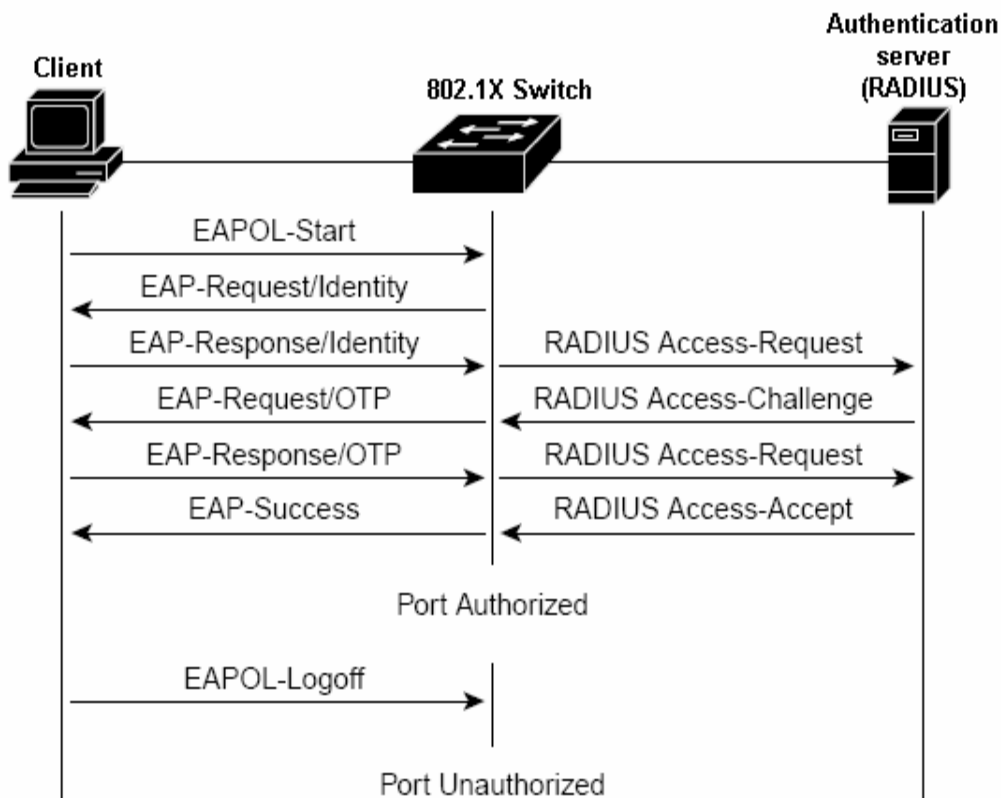

■ Ports in Authorized and Unauthorized States

The switch port state determines whether or not the client is granted access to the network. The port starts in the *unauthorized* state. While in this state, the port disallows all ingress and egress traffic except for 802.1X protocol packets. When a client is successfully authenticated, the port transitions to the *authorized* state, allowing all traffic for the client to flow normally.

If a client that does not support 802.1X is connected to an unauthorized 802.1X port, the switch requests the client's identity. In this situation, the client does not respond to the request, the port remains in the unauthorized state, and the client is not granted access to the network.

In contrast, when an 802.1X-enabled client connects to a port that is not running the 802.1X protocol, the client initiates the authentication process by sending the EAPOL-start frame. When no response is received, the client sends the request for a fixed number of times. Because no response is received, the client begins sending frames as if the port is in the authorized state

If the client is successfully authenticated (receives an Accept frame from the authentication server), the port state changes to authorized, and all frames from the authenticated client are allowed through the port. If the authentication fails, the port remains in the unauthorized state, but authentication can be retried. If the authentication server cannot be reached, the switch can retransmit the request. If no response is received from the server after the specified number of attempts, authentication fails, and network access is not granted. When a client logs off, it sends an EAPOL-logoff message, causing the switch port to transition to the unauthorized state.

If the link state of a port transitions from up to down, or if an EAPOL-logoff frame is received, the port returns to the unauthorized state.

4.7.6.2 802.1X Configuration

This switch has two 802.1X Mode: **Radius Server & Local Authenticate**, choose one you need

- **Local Authenticate** — In this situation, do not need Radius server in the network, all authentication completed by 802.1x Switch, the normal topologies as below

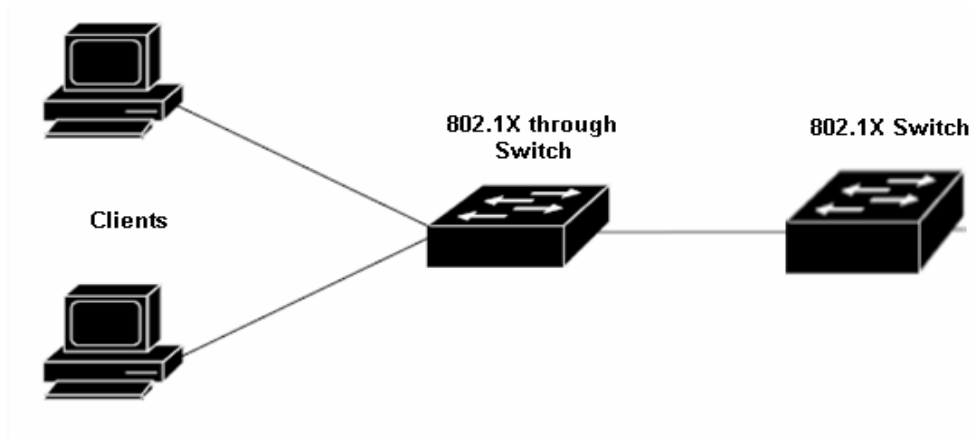

1. Enter "802.1X Port Status Configuration", there are 3 "Authenticate authorization" states

802.1X Port status

Port status Configuration			
Port List (e.g. 1-3,7)	Authenticate Status	maximum account number(1-32)	
<input type="text"/>	Auto	<input type="text"/>	
	<div style="border: 1px solid #ccc; padding: 2px;"> Auto Force Authorized Force Unauthorized </div>		
Port status			
port	Authenticate Status	maximum account number	current account number
port 1	Auto	1	0
port 2	Auto	1	0
port 3	Auto	1	0
port 4	Auto	1	0
port 5	Auto	1	0
port 6	Auto	1	0
port 7	Auto	1	0
port 8	Auto	1	0
port 9	Auto	1	0

- **Auto:** enables 802.1X authentication and causes the port to begin in the unauthorized state, allowing only

EAPOL frames to be sent and received through the port. It's a default status

- **Force authorized:** disables 802.1X authentication and causes the port to transition to the authorized state without any authentication exchange required. The port transmits and receives normal traffic without 802.1X-based authentication of the client. This is the default setting.
- **Force unauthorized:** causes the port to remain in the unauthorized state, ignoring all attempts by the client to authenticate. The switch cannot provide authentication services to the client through the interface.
- **Maximum account number:** the biggest user's quantity of passing authentication under this port, set 1 · Only one user can pass this authentication · The second user is unable to carry on authentication on this port · The max value is 32
- **Current account number:** show the current user who passed authentication under one port.

2. Enter "802.1X Local Authenticate" to set legitimate user information: In the local server model, the need for each port through the establishment of the legitimate user authentication information available. As Figure2-45

”

802.1X Local Authenticate

Local Authenticate Configuration	
username:	<input type="text"/>
port(express all port as 0):	<input type="text"/>
password:	<input type="password"/>
confirm password:	<input type="password"/>
<input type="button" value="Add/Modify"/>	
delete user	
username:	<input style="width: 150px;" type="text"/> <input type="button" value="delete"/>
Local Authenticate Information	
port	username

3. "Other configuration": only choose "Local Authenticate" mode is available. If you not have good experiences please keep the default value.

other Configuration	
Re-Authentication:	Enable ▾
Dot1x MaxReq(1-10):	2
Dot1x reAuthMax(1-10):	2
Supplicant Timeout(1-255):	60
Re-Authentication Period(10-65535):	300
Quiet Period(0-65535):	60
Server Timeout(1-255):	60
Tx Period(0-65535):	30
OK	

- **Radius Server** — In this situation, need a Radius server in the network, the normal topologies as below

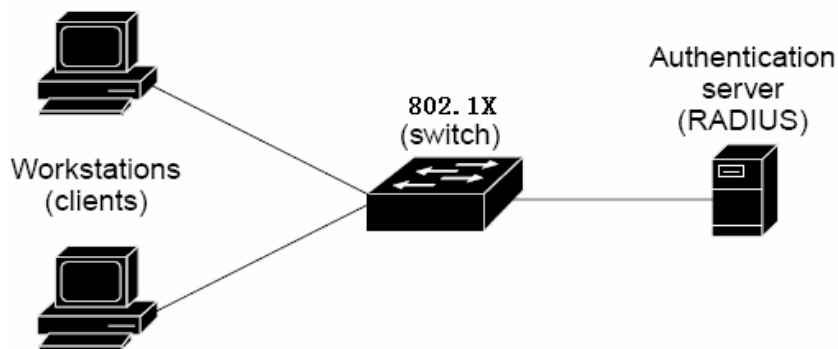

1. Select the "Radius Server" mode.
2. The RADIUS Server configuration table includes the following fields:

802.1X

802.1x Configuration	
802.1x Mode	Enable <input type="button" value="v"/>
	<input checked="" type="radio"/> Radius Server <input type="radio"/> Local Authenticate
<input type="button" value="OK"/>	

Radius Server Configuration	
Radius Server IP Address:	<input type="text" value="192.168.0.51"/>
Authentication Port(1-65535):	<input type="text" value="1812"/>
Account Port(1-65535):	<input type="text" value="1813"/>
Share Key:	<input type="text" value="12345678"/>
<input type="button" value="OK"/>	

-
- **RADIUS Server IP Address** The IP address of the RADIUS server being added.
 - **Authentication Port(1-65535)** The UDP port used by this server. The valid range is 0 - 65535.
The default UDP Port No. is **1812**
 - **Account Port(1-65535)** The UDP port used by accounting server. The valid range is 0 - 65535.
The default UDP Port No. is **1813**
 - **Share Key** Indicates if the shared secret for this server has been configured.
-

3. Setup the RADIUS server and assign the client IP address to the Web-Smart switch. In this case, field in the default IP Address of the Web-Smart switch with 192.168.0.100. And also make sure the shared secret key is as same as the one you had set at the switch RADIUS server – 12345678 at this case.

Add RADIUS Client

Client Information
Specify information regarding the client.

Client address (IP or DNS):
192.168.0.100

Client-Vendor:
RADIUS Standard

Client must always send the signature attribute in the request.

Shared secret: ****

Confirm shared secret: ****

4. Configure ports attribute of 802.1X, the same as "802.1X Port Status Configuration".

802.1X Port status

Port status Configuration

Port List (e.g. 1-3,7)	Authenticate Status	maximum account number(1-32)
<input type="text"/>	Auto	<input type="text"/>
	<ul style="list-style-type: none"> Auto Force Authorized Force Unauthorized 	

Port status

port	Authenticate Status	maximum account number	current account number
port 1	Auto	1	0
port 2	Auto	1	0
port 3	Auto	1	0
port 4	Auto	1	0
port 5	Auto	1	0
port 6	Auto	1	0
port 7	Auto	1	0
port 8	Auto	1	0
port 9	Auto	1	0



NOTE: Set the Ports Authenticate Status to "Force Authorized" if the port is connected to the RADIUS server or the port is a uplink port that is connected to another switch. Or once the 802.1X stat to work, the switch might not be able to access the RADIUS server.

5. Create user data. That step are different of "Local Authenticate", the establishment of the user data needs

to be created on the Radius Server PC. For example, the Radius Server founded on Win2000 Server, and then:

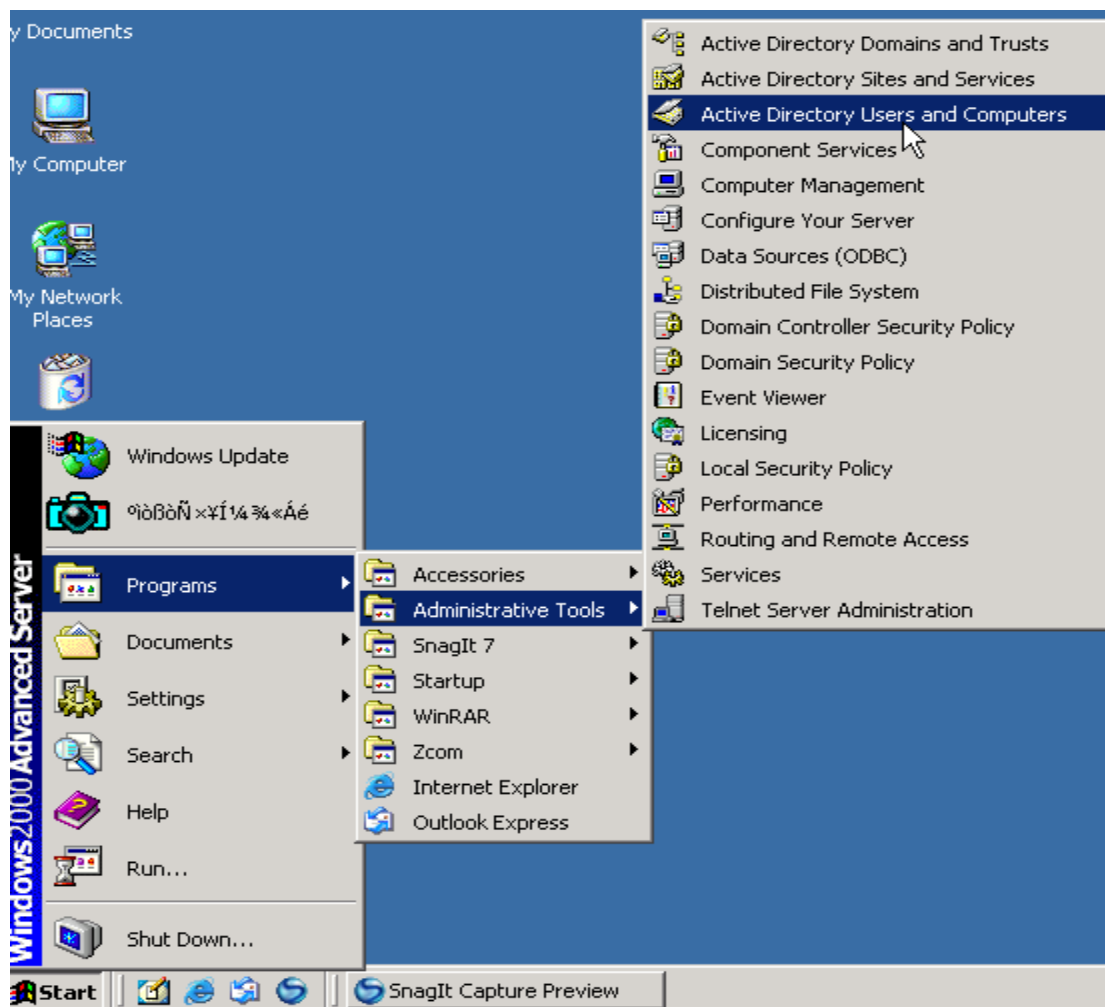

Enter " **Active Directory Users and Computers**", create legal user data, the next, right-click a user what you created to enter properties, and what to be noticed:

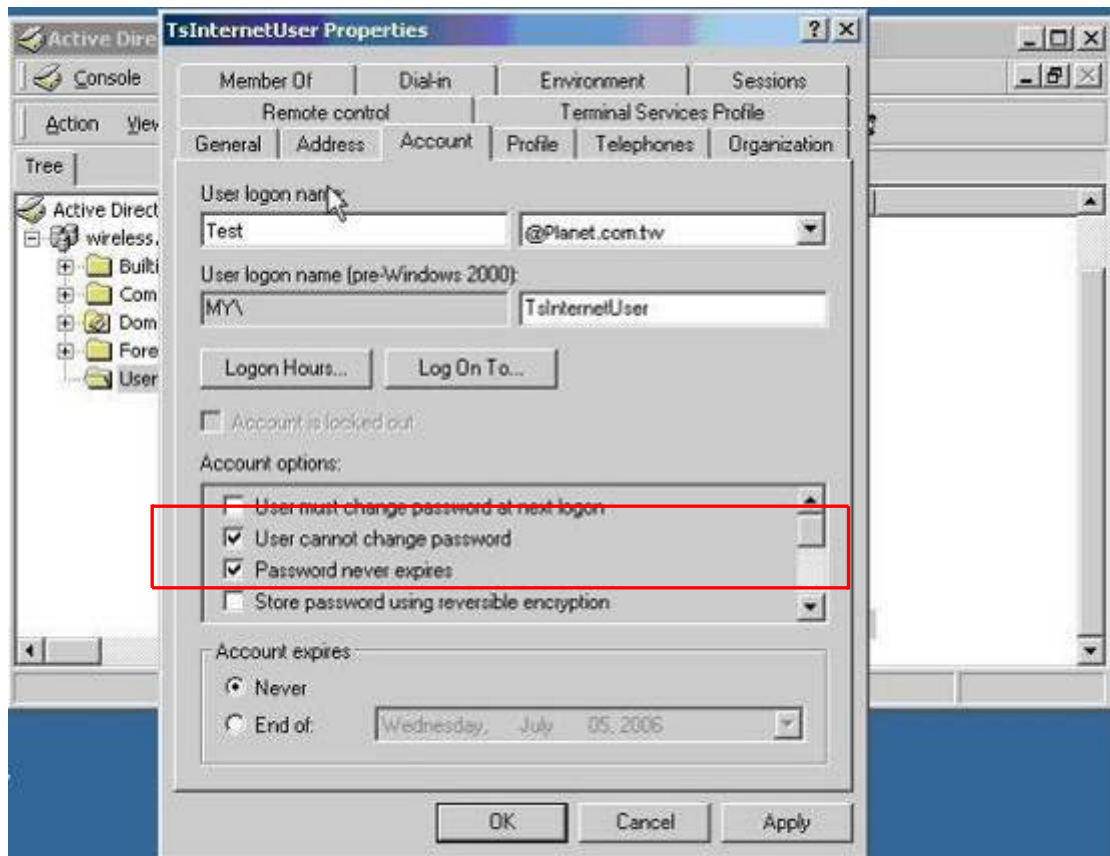

6. The last, run your 802.1X Client

4.7.6.3 802.1X Client Configuration

Windows XP is originally 802.1X support. As to other operating systems (windows 98SE, ME, 2000), an 802.1X client utility is needed. The following procedures show how to configure 802.1X Authentication in Windows XP. Please note that if you want to change the 802.1x authentication type of a wireless client, i.e. switch to EAP-TLS from EAP-MD5, you must remove the current existing wireless network from your preferred connection first, and add it in again.

• Configure Sample: EAP-MD5 Authentication

1. Go to **Start > Control Panel**, double-click on "**Network Connections**".
2. Right-click on the Local Network Connection.
3. Click "**Properties**" to open up the Properties setting window.

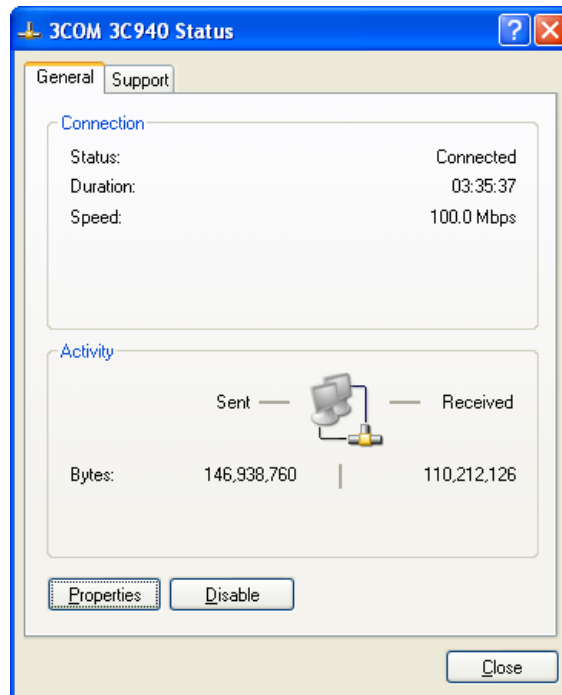

4. Select **"Authentication"** tab.
5. Select **"Enable network access control using IEEE 802.1X"** to enable 802.1x authentication.

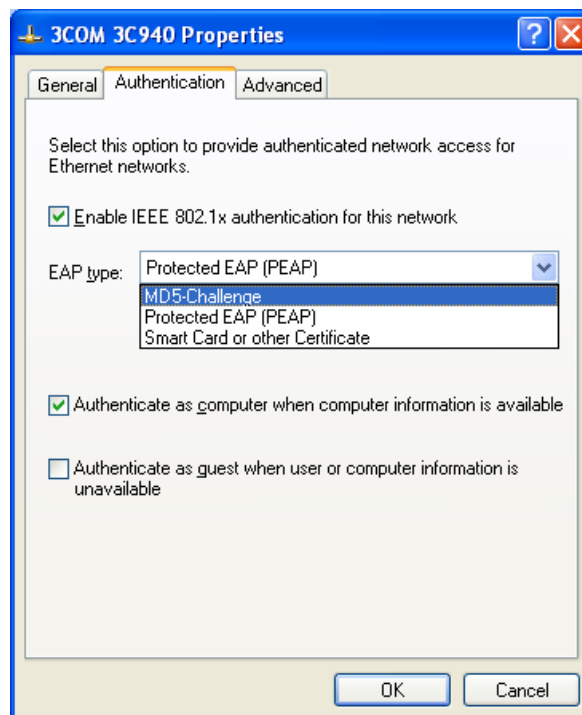

6. Select **"MD-5 Challenge"** from the drop-down list box for EAP type.
7. Click **"OK"**.
8. When wireless client has associated with WGSW-2840/5240, a user authentication notice appears in system tray. Click on the notice to continue.

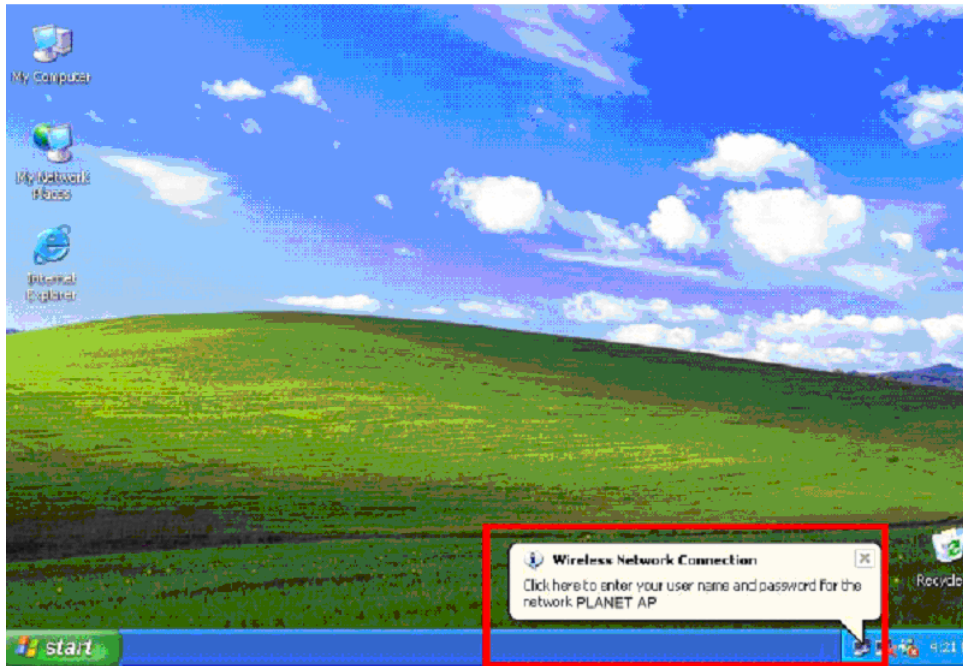

9. Enter the user name, password and the logon domain that your account belongs.
10. Click "OK" to complete the validation process.

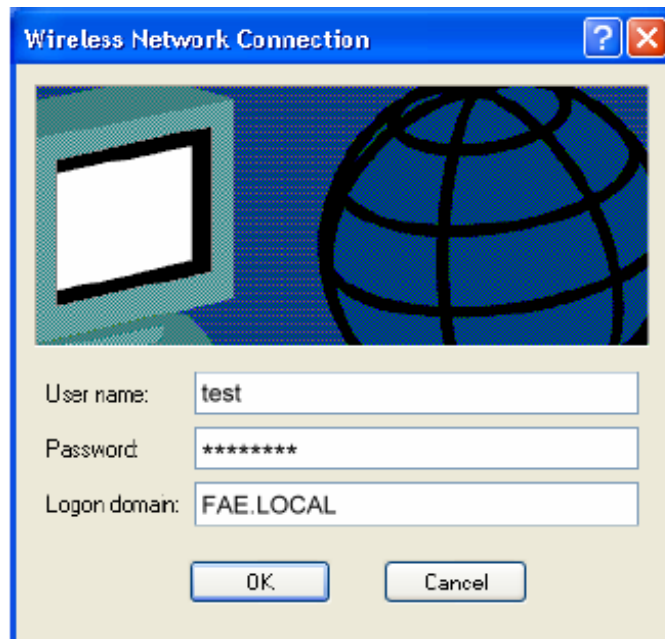

4.8 QoS

4.8.1 Understand QoS

Quality of Service (QoS) is an advanced traffic prioritization feature that allows you to establish control over network traffic. QoS enables you to assign various grades of network service to different types of traffic, such as multi-media, video, protocol-specific, time critical, and file-backup traffic.

QoS reduces bandwidth limitations, delay, loss, and jitter. It also provides increased reliability for delivery of your data and allows you to prioritize certain applications across your network. You can define exactly how you want the switch to treat selected applications and types of traffic.

You can use QoS on your system to:

- Control a wide variety of network traffic by:
- Classifying traffic based on packet attributes.
- Assigning priorities to traffic (for example, to set higher priorities to time-critical or business-critical applications).
- Applying security policy through traffic filtering.
- Provide predictable throughput for multimedia applications such as video conferencing or voice over IP by minimizing delay and jitter.
- Improve performance for specific types of traffic and preserve performance as the amount of traffic grows.
- Reduce the need to constantly add bandwidth to the network.
- Manage network congestion.

QoS Terminology

Classifier—classifies the traffic on the network. Traffic classifications are determined by protocol, application, source, destination, and so on. You can create and modify classifications. The Switch then groups classified traffic in order to schedule them with the appropriate service level.

DiffServ Code Point (DSCP) — is the traffic prioritization bits within an IP header that are encoded by certain applications and/or devices to indicate the level of service required by the packet across a network.

Service Level—defines the priority that will be given to a set of classified traffic. You can create and modify service levels.

Policy—comprises a set of “rules” that are applied to a network so that a network meets the needs of the business. That is, traffic can be prioritized across a network according to its importance to that particular business type.

QoS Profile—consists of multiple sets of rules (classifier plus service level combinations). The QoS profile is assigned to a port(s).

Rules—comprises a service level and a classifier to define how the Switch will treat certain types of traffic. Rules are associated with a QoS Profile (see above).

To implement QoS on your network, you need to carry out the following actions:

1. Define a service level to determine the priority that will be applied to traffic.
2. Apply a classifier to determine how the incoming traffic will be classified and thus treated by the Switch.
3. Create a QoS profile which associates a service level and a classifier.
4. Apply a QoS profile to a port(s).

4.8.2 QOS Configuration

QoS settings allow customization of packet priority in order to facilitate delivery of data traffic that might be affected by latency problems. The IEEE 802.1p Priority specification uses 8 priority levels to classify data packets. In 802.1p compliant devices, a tag inserted into the packet header is used to identify the priority level of data packets. The Switch supports four kinds of Traffic classifiers: 802.1P/ Port/MAC/VLANs and four queues.



NOTE: COS: Priority classifiers of the Switch forward packet. COS range is from 0 to 7. Seven is the high class. Zero is the less class. The user may configure the mapping between COS and Traffic classifiers.

1. MAC-COS Mapping

QoS settings allow customization of MAC address to Traffic classifiers.

1. Fill the MAC Address field in the MAC-CoS Mapping Configuration Table in the In the format “xx-xx-xx-xx-xx-xx “.
2. Fill the mapping number in the **CoS (0-7)** field.
3. Click on the “**OK**” button to save.
4. To remove the MAC-CoS mapping item, simply click on the “**Delete**” button in the **Show MAC-CoS Mapping** table.

MAC-CoS Mapping		
MAC-CoS Mapping Configuration		
MAC Address	CoS (0-7)	
<input type="text" value="00-E0-4F-48-3A-7E"/>	<input type="text" value="7"/>	
<input type="button" value="OK"/>		
Show MAC-CoS Mapping		
MAC Address	CoS	Delete

MAC-CoS Mapping		
MAC-CoS Mapping Configuration		
MAC Address	CoS (0-7)	
<input type="text"/>	<input type="text"/>	
<input type="button" value="OK"/>		
Show MAC-CoS Mapping		
MAC Address	CoS	Delete
00-E0-4F-48-3A-7E	7	<input type="button" value="Delete"/>

2. VLAN-COS Mapping

QoS settings allow customization of VLAN ID to Traffic classifiers

1. Fill the **VID (1-2094)** field in the **VLAN-CoS Mapping** Table.
2. Fill the mapping number in the **CoS (0-7)** field.
3. Click on the “**OK**” button to save.
4. To remove the VLAN-CoS mapping item, simply click on the “**Delete**” button in the **Show VLAN-CoS Mapping** table.

VLAN-CoS Mapping			
VLAN-CoS Mapping			
VID (1-4094)		CoS (0-7)	
<input type="text" value="255"/>		<input type="text" value="3"/>	
<input type="button" value="OK"/>			
Show VLAN-CoS Mapping			
VID	VLAN Name	CoS	Delete

VLAN-CoS Mapping

VLAN-CoS Mapping	
VID (1-4094)	CoS (0-7)
<input type="text"/>	<input type="text"/>
<input type="button" value="OK"/>	

Show VLAN-CoS Mapping			
VID	VLAN Name	CoS	Delete
255	vlan3	5	<input type="button" value="Delete"/>

3. 802.1p-CoS Mapping

QoS settings allow customization of packet priority in order to facilitate delivery of data traffic that might be affected by latency problems. The IEEE 802.1p Priority specification uses 8 priority levels to classify data packets. In 802.1p compliant devices, a tag inserted into the packet header is used to identify the priority level of data packets.

1. Fill the **802.1p Priority (0-7)** field in the **802.1p-priority-CoS Mapping Configuration** Table.
2. Fill the mapping number in the **CoS (0-7)** field.
3. Click on the **“OK”** button to save.

802.1p-priority-CoS Configuration

802.1p-priority-CoS Mapping Configuration	
802.1p Priority (0-7)	CoS (0-7)
<input type="text" value="2"/>	<input type="text" value="3"/>
<input type="button" value="OK"/>	

Show 802.1p-priority-CoS Mapping Table	
802.1p Priority	CoS
0	0
1	1
2	2
3	3
4	4
5	5
6	6
7	7

802.1p-priority-CoS Configuration

802.1p-priority-CoS Mapping Configuration	
802.1p Priority (0-7)	CoS (0-7)
<input type="text"/>	<input type="text"/>
<input type="button" value="OK"/>	
Show 802.1p-priority-CoS Mapping Table	
802.1p Priority	CoS
0	0
1	1
2	3
3	3
4	4
5	5
6	6
7	7

4. Port-COS Mapping

QoS settings allow customization of VLAN ID to Traffic classifiers

1. Fill the **Port List (e.g. 1-3,7)** field in the **port-based QoS Configuration** Table.
2. Fill the mapping number in the **CoS (0-7)** field.
3. Click on the “**OK**” button to save.

Port-based QoS	
port-based QoS Configuration	
Port List(e.g. 1-3,7)	CoS (0-7)
<input type="text" value="4"/>	<input type="text" value="5"/>
<input type="button" value="OK"/>	
Show port-based QoS Table	
Port	CoS
1	0
2	0
4	0
6	0
7	0

5. COS-Queue Mapping

1. Fill the **CoS (0-7)** field in the **CoS-Queue Mapping Configuration** Table.
2. Fill the mapping number in the **Queue (0-3)** field.
3. Click on the “**OK**” button to save.

CoS-Queue Mapping

CoS-Queue Mapping Configuration	
CoS (0-7)	Queue (0-3)
<input type="text"/>	<input type="text"/>
<input type="button" value="OK"/>	
Show CoS-Queue Mapping Table	
CoS	Queue
0	0
1	0
2	1
3	1
4	2
5	2
6	3
7	3

6. Queue Management

There are two rules for the Priority Queue: Weighted Round Robin (**WRR**) and **Always Hight**.

To configure Queue Rule, select the **Queue Policy** drop down menu in the **Queue Rule Configuration** table. And Click on the “**OK**” button to save.

Queue Rule Configuration	
Queue Policy	WRR <input type="button" value="v"/>
<input type="button" value="OK"/>	

If the WRR was chosen as the Queue Policy, the page would show in the main page.

Queue Management

Queue Rule Configuration	
Queue Policy	WRR <input type="button" value="v"/>
<input type="button" value="OK"/>	
Show Queue Weight	
Queue	Weight
Queue 3	8
Queue 2	4
Queue 1	2
Queue 0	1

4.9 Multicast

4.9.1 IGMP Snooping

Theory

Computers and network devices that want to receive multicast transmissions need to inform nearby routers that they will become members of a multicast group. The Internet Group Management Protocol (IGMP) is used to communicate this information. IGMP is also used to periodically check the multicast group for members that are no longer active. In the case where there is more than one multicast router on a sub network, one router is elected as the 'queried'. This router then keeps track of the membership of the multicast groups that have active members. The information received from IGMP is then used to determine if multicast packets should be forwarded to a given sub network or not. The router can check, using IGMP, to see if there is at least one member of a multicast group on a given subnet work. If there are no members on a sub network, packets will not be forwarded to that sub network.

IGMP Versions 1 and 2

Multicast groups allow members to join or leave at any time. IGMP provides the method for members and multicast routers to communicate when joining or leaving a multicast group.

IGMP version 1 is defined in RFC 1112. It has a fixed packet size and no optional data.

The format of an IGMP packet is shown below:

IGMP Message Format

Octets

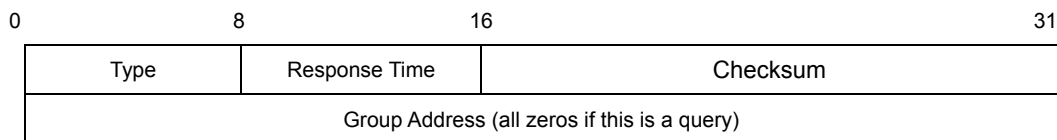

The IGMP Type codes are shown below:

Type Meaning

- 0x11** Membership Query (if Group Address is 0.0.0.0)
- 0x11** Specific Group Membership Query (if Group Address is Present)
- 0x16** Membership Report (version 2)
- 0x17** Leave a Group (version 2)
- 0x12** Membership Report (version 1)

IGMP packets enable multicast routers to keep track of the membership of multicast groups, on their respective sub networks. The following outlines what is communicated between a multicast router and a multicast group member using IGMP.

A host sends an IGMP “**report**” to join a group

A host will never send a report when it wants to leave a group (for version 1).

A host will send a “**leave**” report when it wants to leave a group (for version 2).

Multicast routers send IGMP queries (to the all-hosts group address: 224.0.0.1) periodically to see whether any group members exist on their sub networks. If there is no response from a particular group, the router assumes that there are no group members on the network.

The Time-to-Live (TTL) field of query messages is set to 1 so that the queries will not be forwarded to other sub networks.

IGMP version 2 introduces some enhancements such as a method to elect a multicast queried for each LAN, an explicit leave message, and query messages that are specific to a given group.

The states a computer will go through to join or to leave a multicast group are shown below:

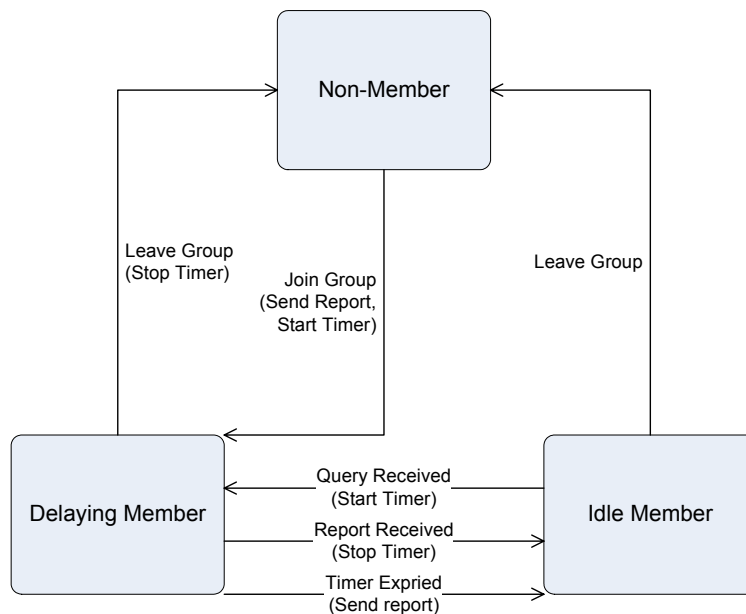

IGMP State Transitions

IGMP Snooping Configuration

The default status of the IGMP Snooping function is disabled. To turn on the IGMP Snooping, select “**Enable**” of the **IGMP Snooping Status** field and click on the “**OK**” button to save.

IGMP Snooping

IGMP Snooping Status:

Show The Multicast Group Table

Multicast	VID	Port

4.9.2 Static Routing Port

This function is to configure ports to be the member of IGMP Groups in VLANs.

To do this, fill the **Port List** field and the **VID** field for the static routing and click on the “**Add**” button to save.

Static Routing Port

Static Routing Port Configuration

Port List(e.g. 1-3,7)	VID(VLAN 0 means All VLAN)
<input type="text"/>	<input type="text"/>
<input type="button" value="Add"/>	

Show Static Routing Port Table

Port	VID	VLAN Name	Type	Delete
Port3	2	Vlan 2	Static	<input type="button" value="Delete"/>

4.10 Port Analysis

4.10.1 Port Analysis

This function shows the statistical information of each port, it helps to diagnose the network malfunction.

The following example shows the statistic table of port #6.

Port Analysis

Port Selecting

Port:

Show Statistic Table

Statistic Item	Total	Average	Max
Tx bytes:	6577715	469836	469836
Tx packets:	22661	1618	1618
Rx bytes:	1357570	96969	96969
Rx packets:	11629	830	830
Rx Unicast packets:	11493	820	820
Rx Multicast packets:	0	0	0
Rx Broadcast packets:	136	9	9
Tx/Rx packets of 64 bytes:	22953	1639	1639
Tx/Rx packets of 65~127 bytes:	2594	185	185
Tx/Rx packets of 128~255 bytes:	2110	150	150
Tx/Rx packets of 256~511 bytes:	1956	139	139
Tx/Rx packets of 512~1023 bytes:	2444	174	174
Tx/Rx packets of 1024~1518 bytes:	2188	156	156
Rx correct packets of less than 64 bytes:	0	0	0
Rx correct packets of exceed 1518 bytes:	0	0	0
Rx error packets of less than 64 bytes:	0	0	0
Rx error packets of exceed 1518 bytes:	0	0	0

4.10.2 Port Mirror

Port Mirroring is a method of monitoring network traffic that forwards a copy of each incoming and/or outgoing packet from one port of a network switch to another port where the packet can be studied. It enables the manager to keep close track of switch performance and alter it if necessary.

Configuring the port mirroring by assigning a source port from which to copy all packets and a sniffer port where those packets will be sent.

Capture Port: Use this option to select the destination port for monitored traffic. This is the port that your network analyzer would be connected to.

Ingress Port: Duplicate the data transmitted from the source port and forward it to the Capture port.

Egress Port: Duplicate the data sent to the source and forward it to the Capture port.

Port Mirror

Flow Capture Configuration

Capture Port:

Capture Status:

Mirror Port Configuration

Ingress Port List(e.g. 1-3,7)	Egress Port List(e.g. 1-3,7)
<input type="text" value="5"/>	<input type="text" value="6"/>

4.11 Storm Control

This function is to control the Braodcast Storm, Multicast Storm and Flooded Storm packet on each port.

To configure the Storm Control, click on the **Storm Control** menu button. The web main page then shows the Strom Restricting function table.

1. Fill the **Port List** field in the **Broadcast Storm Restricting** table, select the type in the **Restricting Type** drop down menu and enter the packet size in the **Flow** field.
2. Click on the “**OK**” button to save.
3. To remove the Storm Restricting function on the port, simply click on the “**Delete**” button in the **Show Port Restricting Table** table.

Storm Restricting

Broadcast Storm Restricting

Port List(e.g.1-3,7)	Restricting Type	Flow(64~80000Kbps)
<input type="text"/>	<input type="text" value="Broadcast"/>	<input type="text"/>

Show Port Restricting Table

Port	Restricting Type	Flow	Delete
1	Broadcast only	64	<input type="button" value="Delete"/>
1	Broadcast only	64	<input type="button" value="Delete"/>
3	Broadcast,Multicast And Flooded	256	<input type="button" value="Delete"/>

4.12 IP Stacking

4.12.1 About IP Stacking

IP Stacking function enables you to use a single IP address and standard network cabling to manage a group of up to 8 PLANET WSW-2401A/WGSW-2840/5240 switches in the same IP subnet (broadcast domain).

Once one switch had been operated as the Master of a stack, additional switches can join the IP stack by manual methods to setting with the same group name. After a switch becomes a Client and stack group member, you can work through the Master switch to further configure the Member switch as necessary for all of the IP Stack features available in the switch.

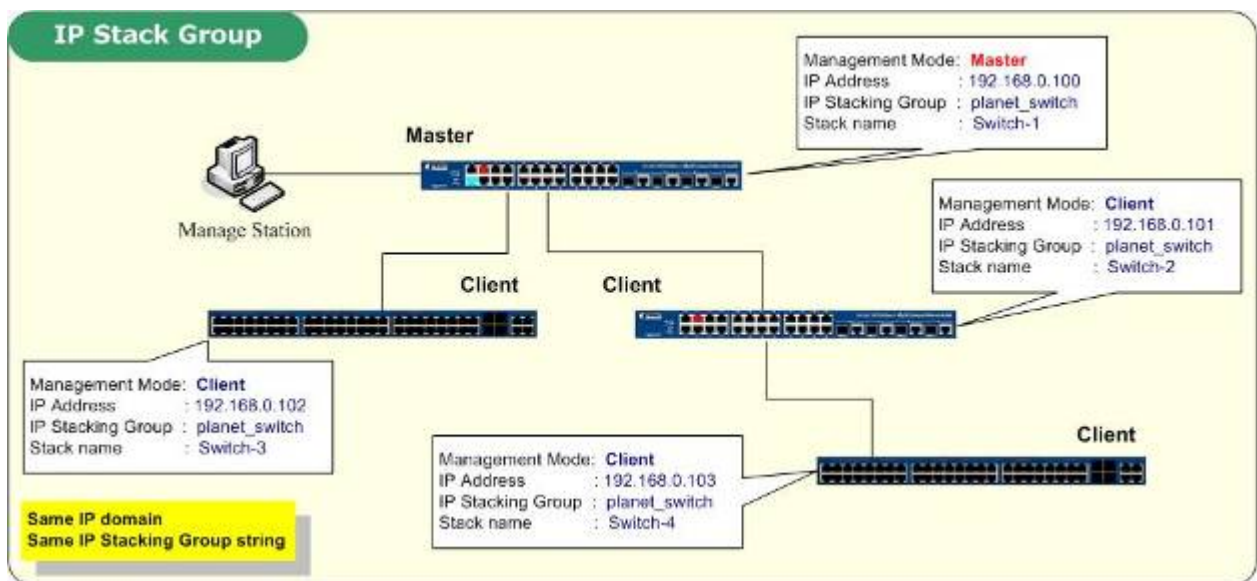

4.12.2 IP Stacking Configuration

Before the IP Stacking Configuration, the network manager have to identify the roles of the stackable switches – the **Master** mode and **Client** mode. At a IP stacking group domain, there is only one Master switch and many Client switches. If there're more than one switch be configured to the Master mode, the it will depends on the "System Priority" to elect a active Master. The others with Master mode would be Backup Master.

To join a IP Stack group, both the Master and Client have to be assigned with the same string at "**IP Stacking Group**" filed.

Once the switch be assigned as a Client switch, it's not allowed to management the Client switch with its original system IP address. That is, the administrator has to configure the Client switch via the Master switch management UI.

The following fields can be set for IP Stacking configuration:

Current mode: Display the current mode of IP Stacking, there're three possible statuses:

- Disable – The IP Stacking function is disabled.

- Master – The IP Stacking Management status is enabled and the current switch is a Master switch at this IP Stack Group.
- Client.- The IP Stacking Management status is enabled and the current switch is a Client switch at this IP Stack Group.

Manamement status: This filed is to Enable or Disable the IP Stack function.

Management mode: Identify the management mode of the current switch. There're two possible selections:

- Master – The switch plays as a Master of the IP Stack Group.
- Client - The switch plays as a Client of the IP Stack Group.

IP Stacking group: This filed effects if the switches be joined to the same IP Stack group. With the same “string” entry, both the Master and Client will be assigned to the same IP Stack group. If not, the switches will not be the IP Stack group members.

System priority: If there're more than one switch be configured to the Master mode, the it will depends on the “System Priority” to elect a active Master. The others with Master mode would be Backup Master. If there is no other Master switch, it's no need to modify this value.

IPStacking MAC: The Master will base on the MAC address to find out the Cleint switches. Generally the entry would be the burn-in MAC address of the switch.

Stack name: Identify the name at a IP Stack group. The entry will be displayed at the Master switch management UI for Master and Client switches identify.

Following we'll show you how to configure the Master switch and Client switch.

• Master Switch configuration

1. Please enter into switch web main screen and choose “**Enable**” in Management status field. It will enable the stack function of the switch and the following screen appears.

IP Stacking	
Current mode:	Disable
Management status:	Disable ▾
Management mode:	<div style="border: 1px solid black; padding: 2px;"> Disable Enable </div>
IP Stacking group:	planet_switch
System priority:	100
IPStacking MAC:	08-DA-71-57-2D-D1
Stack name:	Switch
<input type="button" value="OK"/>	

2. Then assign a role to the WGSW-2840 as **Master** in Management mode field, the following screen appears.

IP Stacking	
Current mode:	Master
Management status:	Enable
Management mode:	Master
IP Stacking group:	planet_switch
System priority:	100
IPStacking MAC:	08-07-F0-F7-D7-17
Stack name:	Switch-1

OK

3. Enter a string in the "IP Stacking Group" field; the default string of the WGSW-2840/5240 is "**planet_switch**". This string must be the same with the Client switches that to be assigned to the same IP Stack group.
4. Modify the "System priority" and "Stack name" if necessary. At this sample we change the Stack name of the Master to "Switch-1"
5. Click "**OK**" if the configuration is down.

• Client Switch configuration

6. Please enter into Client switch web main screen and choose "**Enable**" in Management status field. It will enable the stack function of the switch.
7. Then assign a role to the WGSW-2840 as **Client** in Management mode field, the following screen appears.

IP Stacking

Current mode:	Disable
Management status:	Enable <input type="button" value="v"/>
Management mode:	Client <input type="button" value="v"/>
IP Stacking group:	Master ch
System priority:	100
IPStacking MAC:	08-58-F1-A4-AC-06
Stack name:	Switch

8. Enter a string in the "IP Stacking Group" field; the default string of the WGSW-2840/5240 is "planet_switch". This string must be the same with the Master switch that to be assigned to the same IP Stack group.

IP Stacking

Current mode:	Disable
Management status:	Enable <input type="button" value="v"/>
Management mode:	Client <input type="button" value="v"/>
IP Stacking group:	planet_switch
System priority:	100
IPStacking MAC:	08-58-F1-A4-AC-06
Stack name:	Switch

9. Modify the "System priority" and "Stack name" if necessary. At this sample we change the Stack name of the Client to "Switch-2"
10. Click "OK" if the configuration is down.
11. Please use a UTP cable to uplink together through its Ethernet interface
12. Back to login the WEB main screen of **Master switch**- then you can see two WGSW-2840 stacks together from its web interface. The following screen appears.

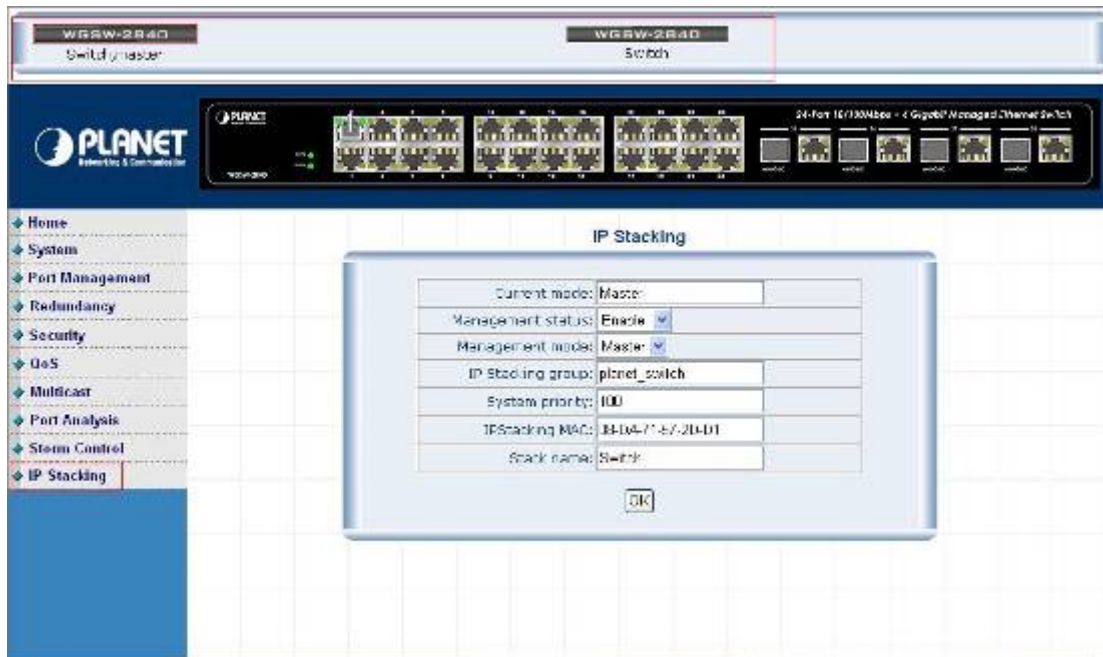

13. After setup complete, please go to system and choose **“Saving parameters”** to save current configuration.
The following screen appears.

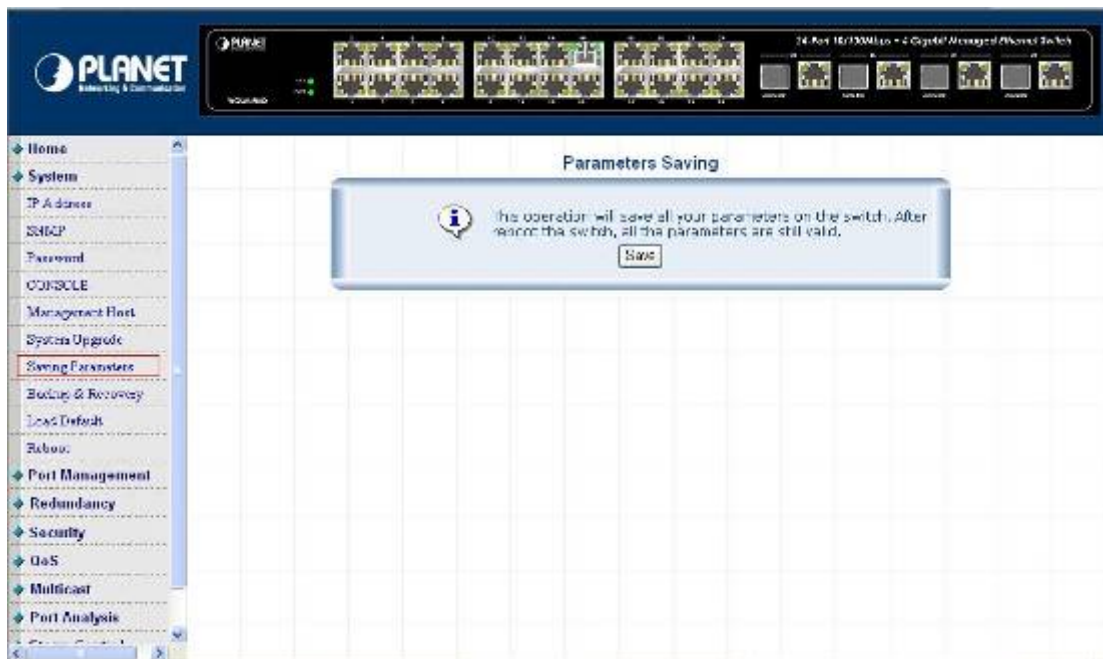

NOTE: Please do not assign role for whole stack member Switch as client, it cannot detect the Master device with minimum MAC address.

5. TROUBLE SHOOTING

This section is intended to help you solve the most common problems on the WSD-800 Managed Ethernet Switch

5.1 Incorrect connections

The switch port can auto detect straight or crossover cable when you link switch with other Ethernet device. For the RJ-45 connector should use correct UTP or STP cable, 10/100Mbps port use 2 pairs twisted cable. If the RJ-45 connector is not correct pin on right position then the link will fail. For fiber connection, please notice that fiber cable mode and fiber module should be match.

5.1.1 Faulty or loose cables

Look for loose or obviously faulty connections. If they appear to be OK, make sure the connections are snug. IF that does not correct the problem, try a different cable.

5.1.2 Non-standard cables

Non-standard and miss-wired cables may cause numerous network collisions and other network problem, and can seriously impair network performance. A category 5-cable tester is a recommended tool for every 100Base-T network installation.

5.1.3 Improper Network Topologies

It is important to make sure that you have a valid network topology. Common topology faults include excessive cable length and too many repeaters (hubs) between end nodes. In addition, you should make sure that your network topology contains no data path loops. Between any two ends nodes, there should be only one active cabling path at any time. Data path loops will cause broadcast storms that will severely impact your network performance.

5.2 Diagnosing LED Indicators

The Switch can be easily monitored through panel indicators to assist in identifying problems, which describes common problems you may encounter and where you can find possible solutions.

IF the power indicator does turn on when the power cord is plugged in, you may have a problem with power outlet, or power cord. However, if the Switch powers off after running for a while check for loose power connections, power losses or surges at power outlet. IF you still cannot resolve the problem, contact your local dealer for assistance.

5.2.1 Cabling

RJ-45 ports: use unshielded twisted-pair (UTP) or shield twisted-pair (STP) cable for RJ-45 connections: 100Ω

Category 3, 4 or 5 cable for 10Mbps connections or 100Ω Category 5 cable for 100Mbps connections. Also be sure that the length of any twisted-pair connection does not exceed 100 meters (328 feet).

6. APPENDIX

6.1 Console Port Pin Assignments

The DB-9 serial port on the front panel is used to connect to the switch for out-of-band console configuration. The console menu-driven configuration program can be accessed from a terminal or a PC running a terminal emulation program. The pin assignments used to connect to the serial port are provided in the following tables.

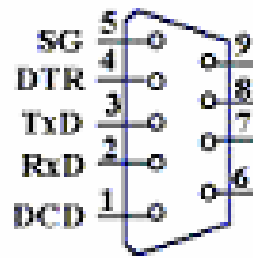

DB-9

DB-9 Console Port Pin Numbers

DB-9 Port Pin Assignments

EIA Circuit	CCITT Signal	Description	Switch's DB9 DTE Pin #	PC DB9 DTE Pin #
BB	104	RxD (Received Data)	2	2
BA	103	TxD (Transmitted Data)	3	3
AB	102	SGND (Signal Ground)	5	5

Console Port to 9-Pin DTE Port on PC

Switch's 9-Pin Serial Port	CCITT Signal PC's 9-Pin	DTE Port
2 RXD	<-----RXD ----->	3 TxD
3 TXD	-----TXD ----->	2 RxD
5 SGND	-----SGND -----	5 SGND

Cable Types and Specifications

Cable	Type	Max. Length	Connector

10BASE-T	Cat. 3, 4, 5 100-ohm	UTP 100 m (328 ft)	RJ-45
100BASE-TX	Cat. 5 100-ohm UTP	100 m (328 ft)	RJ-45
100BASE-FX	50/125 or 62.5/125 micron core multimode fiber (MMF)	2 km (1.24 miles)	SC or ST

6.2 100BASE-TX/10BASE-T Pin Assignments

With 100BASE-TX/10BASE-T cable, pins 1 and 2 are used for transmitting data, and pins 3 and 6 for receiving data.

RJ-45 Pin Assignments

Pin Number	Assignment
1	Tx+
2	Tx-
3	Rx+
6	Rx-

Note: "+" and "-" signs represent the polarity of the wires that make up each wire pair.

All ports on this switch support automatic MDI/MDI-X operation, you can use straight-through cables for all network connections to PCs or servers, or to other switches or hubs. In straight-through cable, pins 1, 2, 3, and 6, at one end of the cable, are connected straight through to pins 1, 2, 3 and 6 at the other end of the cable. The table below shows the 10BASE-T/ 100BASE-TX MDI and MDI-X port pin outs.

Pin MDI-X	Signal Name	MDI Signal Name
1	Receive Data plus (RD+)	Transmit Data plus (TD+)
2	Receive Data minus (RD-)	Transmit Data minus (TD-)
3	Transmit Data plus (TD+)	Receive Data plus (RD+)
6	Transmit Data minus (TD-)	Receive Data minus (RD-)

7. APPENDIX-B

■ 802.1Q VLAN Multi-Untagged VLAN setting sample 1

The version V.1.4.27 of WGSW-2840 had added the multiple untagged VLAN function on a port. The function could be applied at if the members of two or more different VLAN groups all have to access the same server/AP/Printer. But the two VLAN groups are separated and can't access to each other. The graphic in Figure 7-1 appears.

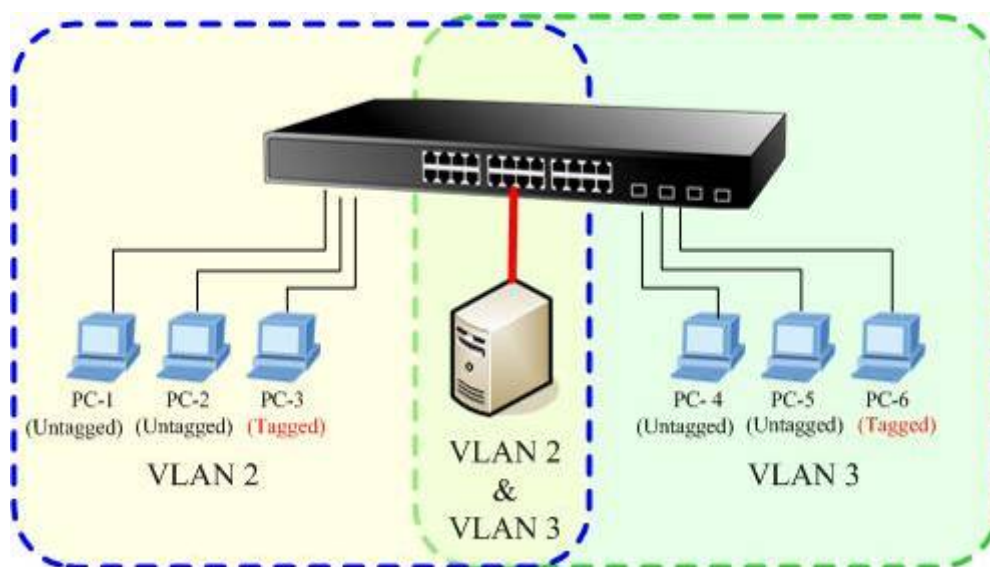

Figure 7-1 Overlap VLAN graphic

The next will be a configure sample- how to setup the WGSW-2840 802.1Q VLAN with a multiple untagged port.

1. At the menu bar ,click **“Security”** > **“VLAN”**
2. After the VLAN configuration page appear, select **“802.1Q VALN”** and click **“OK”** to apply. Then the following screen in Figure 7-2 appears.

802.1Q VLAN

Port	Link Type	PVID	Egress Policy
port1	Access	1	Untagged=1
port2	Access	1	Untagged=1
port3	Access	1	Untagged=1
port4	Access	1	Untagged=1
port5	Access	1	Untagged=1
port6	Access	1	Untagged=1
port7	Access	1	Untagged=1
port8	Access	1	Untagged=1
port9	Access	1	Untagged=1
port10	Access	1	Untagged=1

Figure 7-2 802.1Q VLAN page screen

3. Move the mouse course to the port, which had be assigned to be connect to the server/AP/printer, then click on the port. For this case, we set the Port-1 to be the multiple untagged port. The screen in Figure 7-3 appears.
4. At the Link Type, select “**Always Untag**” at the draw bar. Click “OK” to apply.

802.1Q VLAN Port Configuration---Port 1

Link Type: Access PVID: 1 OK

Access
Trunk
Always Untag

Set Trunk Port for VLAN

VLAN Table VID-----VLAN NAME 1-----default vlan	Add Delete	VLAN with The Trunk Port VID-----VLAN NAME
--	---	--

Set VLAN's VID & Name

VID 	VLAN Name
Add/Modify Delete	

close

Figure 7-3 802.1Q VLAN Port Configuration – Port1 screen

5. Click the “**Add/Modify**” button to create new VLAN groups with VID=2 and VID=3.

- At the **Port 1-VLAN** Port configuration page, select **VLAN 2** and **VLAN 3** to **add** to the **Port 1**. The right information window at this table shows the status. The screen in Figure 7-4 appears.

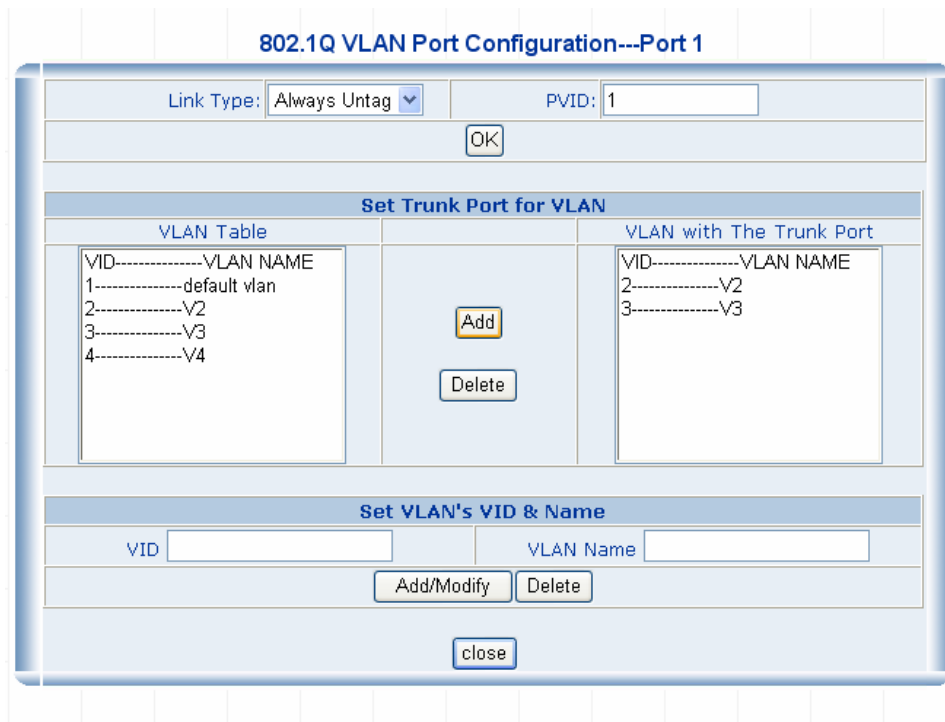

Figure 7-4 Assign Port-1 to be VLAN 2 and VLAN 3 member.

- After the down the Port 1 VLAN configuration, press **“close”** to back to the 802.1Q VLAN main screen. And check if the setting be applied to Port 1 at the **“Egress Policy”** column. The screen in Figure 7-5 appears.

802.1Q VLAN

Port	Link Type	PVID	Egress Policy
port1	Always Untag	1	Untagged=1,2,3,4
port2	Access	1	Untagged=1
port3	Access	1	Untagged=1
port4	Access	1	Untagged=1

Figure 7-5 Port 1 VLAN status

- Assign the **VLAN 2** and **VLAN 3** group member. At this case, **Port 2** had been assigned to as **VLAN 2** group member and **Port 3** be assigned to as **VLAN 3** group member.
- Repeat step 2 to step 7, expect that :
 - Configure the Port 2 with **PVID=2**, Port 3 with **PVID=3**.
 - The link type of both Port-2 and Port 3 are **“Always Untag”**.

- And both Port 2 and Port 3 are **VLAN 1** members.

10. After properly configure the 802.1Q VLAN per port setting, it should be as the screen in Figure 7-6 appears.

802.1Q VLAN			
Port	Link Type	PVID	Egress Policy
port1	Always Untag	1	Untagged=1,2,3,4
port2	Always Untag	2	Untagged=1,2
port3	Always Untag	3	Untagged=1,3
port4	Access	1	Untagged=1
port5	Access	1	Untagged=1
port6	Access	1	Untagged=1
port7	Access	1	Untagged=1

Figure 7-6 Port 1, Port 2 and Port 3 VLAN configuration

Although **Port 2** and **Port 3** are VLAN 1 members, with different PVID setting, the two ports are not able to access each other. But they all can access with the server/AP/Printer which connect to the Port 1 now.

Free Manuals Download Website

<http://myh66.com>

<http://usermanuals.us>

<http://www.somanuals.com>

<http://www.4manuals.cc>

<http://www.manual-lib.com>

<http://www.404manual.com>

<http://www.luxmanual.com>

<http://aubethermostatmanual.com>

Golf course search by state

<http://golfingnear.com>

Email search by domain

<http://emailbydomain.com>

Auto manuals search

<http://auto.somanuals.com>

TV manuals search

<http://tv.somanuals.com>