

Instruction manual

73999 MODEL 7310
Trimmer

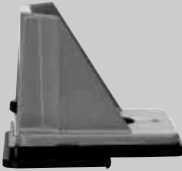

MODEL 7320
Base



Double Insulated Laminate Trimmers

MODEL 7312
Offset Trimmer



MODEL 7319
Tilt Base Trimmer



Attachment
For 97311



To learn more about Porter-Cable
visit our website at:
<http://www.porter-cable.com>

PORTER-CABLE®

IMPORTANT!

Please make certain that the person who is to use this equipment carefully reads and understands these instructions before starting operations.

The Model and Serial No. plate is located on the main housing of the tool. Record these numbers in the spaces below and retain for future reference.

Model No. _____

Type _____

Serial No. _____

TABLE OF CONTENTS

IMPORTANT SAFETY INSTRUCTIONS	2
SAFETY GUIDELINES.	3
GENERAL SAFETY RULES	4
ADDITIONAL SPECIFIC SAFETY RULES	6
FUNCTIONAL DESCRIPTION	8
CARTON CONTENTS	9
ASSEMBLY	9
OPERATION	9
TROUBLESHOOTING	16
MAINTENANCE.	20
SERVICE	20
ACCESSORIES	21
WARRANTY.	22
ESPAÑOL.	23
FRANÇAISE.	43

IMPORTANT SAFETY INSTRUCTIONS

Read and understand all warnings and operating instructions before using any tool or equipment. When using tools or equipment, basic safety precautions should always be followed to reduce the risk of personal injury. Improper operation, maintenance or modification of tools or equipment could result in serious injury and property damage. There are certain applications for which tools and equipment are designed. Porter-Cable strongly recommends that this product NOT be modified and/or used for any application other than for which it was designed.

If you have any questions relative to its application DO NOT use the product until you have written Porter-Cable and we have advised you.

Online contact form at www.porter-cable.com

Postal Mail: Technical Service Manager

Porter-Cable
4825 Highway 45 North
Jackson, TN 38305

Information regarding the safe and proper operation of this tool is available from the following sources:

Power Tool Institute

1300 Sumner Avenue, Cleveland, OH 44115-2851

www.powertoolinstitute.org

National Safety Council

1121 Spring Lake Drive, Itasca, IL 60143-3201

American National Standards Institute, 25 West 43rd Street, 4 floor, New York, NY 10036 www.ansi.org ANSI 01.1 Safety Requirements for Woodworking Machines, and the U.S. Department of Labor regulations www.

SAVE THESE INSTRUCTIONS!

SAFETY GUIDELINES - DEFINITIONS

It is important for you to read and understand this manual. The information it contains relates to protecting YOUR SAFETY and PREVENTING PROBLEMS. The symbols below are used to help you recognize this information.



▲ DANGER

indicates an imminently hazardous situation which, if not avoided, will result in death or serious injury.

▲ WARNING

indicates a potentially hazardous situation which, if not avoided, could result in death or serious injury.

▲ CAUTION

indicates a potentially hazardous situation which, if not avoided, may result in minor or moderate injury.

CAUTION

used without the safety alert symbol indicates potentially hazardous situation which, if not avoided, may result in property damage.

CALIFORNIA PROPOSITION 65

▲ WARNING Some dust created by power sanding, sawing, grinding, drilling, and other construction activities contains chemicals known (to the State of California) to cause cancer, birth defects or other reproductive harm. Some examples of these chemicals are:

- lead from lead-based paints
- crystalline silica from bricks and cement and other masonry products
- arsenic and chromium from chemically-treated lumber

Your risk from these exposures varies, depending on how often you do this type of work. To reduce your exposure to these chemicals: work in a well ventilated area, and work with approved safety equipment, always wear NIOSH/OSHA approved, properly fitting face mask or respirator when using such tools.

GENERAL SAFETY RULES

Read all instructions. Failure to follow all instructions listed below may result in electric shock, fire and/or serious injury. The term "power tool" in all of the warnings listed below refers to your mains-operated (corded) power tool or battery-operated (cordless) power tool.



SAVE THESE INSTRUCTIONS

1) Work area safety

- a) **Keep work area clean and well lit.** Cluttered or dark areas invite accidents.
- b) **Do not operate power tools in explosive atmospheres, such as in the presence of flammable liquids, gases or dust.** Power tools create sparks which may ignite the dust or fumes.
- c) **Keep children and bystanders away while operating a power tool.** Distractions can cause you to lose control.

2) Electrical safety

- a) **Power tool plugs must match the outlet. Never modify the plug in any way. Do not use any adapter plugs with earthed (grounded) power tools.** Unmodified plugs and matching outlets will reduce risk of electric shock.
- b) **Avoid body contact with earthed or grounded surfaces such as pipes, radiators, ranges and refrigerators.** There is an increased risk of electric shock if your body is earthed or grounded.
- c) **Do not expose power tools to rain or wet conditions.** Water entering a power tool will increase the risk of electric shock.
- d) **Do not abuse the cord. Never use the cord for carrying, pulling or unplugging the power tool. Keep cord away from heat, oil, sharp edges or moving parts.** Damaged or entangled cords increase the risk of electric shock.
- e) **When operating a power tool outdoors, use an extension cord suitable for outdoor use.** Use of a cord suitable for outdoor use reduces the risk of electric shock.

3) Personal safety

- a) **Stay alert, watch what you are doing and use common sense when operating a power tool. Do not use a power tool while you are tired or under the influence of drugs, alcohol or medication.** A moment of inattention while operating power tools may result in serious personal injury.
- b) **Use safety equipment. Always wear eye protection.** Safety equipment such as dust mask, non-skid safety shoes, hard hat, or hearing protection used for appropriate conditions will reduce personal injuries.
- c) **Avoid accidental starting. Ensure the switch is in the off-position before plugging in.** Carrying power tools with your finger on the switch or plugging in power tools that have the switch on invites accidents.
- d) **Remove any adjusting key or wrench before turning the power tool**

GENERAL SAFETY RULES continued

on. A wrench or a key left attached to a rotating part of the power tool may result in personal injury.

- e) **Do not overreach. Keep proper footing and balance at all times.** This enables better control of the power tool in unexpected situations.
- f) **Dress properly. Do not wear loose clothing or jewelry. Keep your hair, clothing and gloves away from moving parts.** Loose clothes, jewelry or long hair can be caught in moving parts.
- g) **If devices are provided for the connection of dust extraction and collection facilities, ensure these are connected and properly used.** Use of these devices can reduce dust-related hazards.

4) Power tool use and care











- a) **Do not force the power tool. Use the correct power tool for your application.** The correct power tool will do the job better and safer at the rate for which it was designed.
- b) **Do not use the power tool if the switch does not turn it on and off.** Any power tool that cannot be controlled with the switch is dangerous and must be repaired.
- c) **Disconnect the plug from the power source before making any adjustments, changing accessories, or storing power tools.** Such preventive safety measures reduce the risk of starting the power tool accidentally.
- d) **Store idle power tools out of the reach of children and do not allow persons unfamiliar with the power tool or these instructions to operate the power tool.** Power tools are dangerous in the hands of untrained users.
- e) **Maintain power tools. Check for misalignment or binding of moving parts, breakage of parts and any other condition that may affect the power tools operation. If damaged, have the power tool repaired before use.** Many accidents are caused by poorly maintained power tools.
- f) **Keep cutting tools sharp and clean.** Properly maintained cutting tools with sharp cutting edges are less likely to bind and are easier to control.
- g) **Use the power tool, accessories and tool bits etc., in accordance with these instructions and in the manner intended for the particular type of power tool, taking into account the working conditions and the work to be performed.** Use of the power tool for operations different from those intended could result in a hazardous situation.

5) Service

- a) **Have your power tool serviced by a qualified repair person using only identical replacement parts.** This will ensure that the safety of the power tool is maintained.

ADDITIONAL SPECIFIC SAFETY RULES

1. **HOLD POWER TOOLS BY INSULATED GRIPPING SURFACES WHEN PERFORMING AN OPERATION WHERE THE CUTTING TOOL MAY CONTACT HIDDEN WIRING OR ITS OWN CORD.** Contact with a "live" wire will make exposed metal parts of the tool "live" and shock the operator.
2. **USE CLAMPS OR OTHER PRACTICAL WAY TO SECURE AND SUPPORT THE WORKPIECE TO A STABLE PLATFORM.** Holding the work by hand or against your body is unstable and may lead to loss of control.
3. **DISCONNECT TOOL FROM POWER SOURCE** before making adjustments or changing bits.
4. **TIGHTEN COLLET NUT** securely to prevent the bit from slipping.
5. **USE A CLAMP** or some other device to hold the workpiece rigidly in position. and clear the path of the tool of obstructions.
6. **CHECK TO SEE THAT THE CORD** will not "hang up" during trimming operation.
7. **CLEAR THE TRIMMER BIT AREA** before starting motor.
8. **MAINTAIN FIRM GRIP** on trimmer to resist starting torque.
9. **KEEP HANDS CLEAR OF CUTTER** when motor is running to prevent personal injury.
10. **KEEP CUTTING PRESSURE CONSTANT.** Do not overload motor.
11. **LET THE MOTOR COME TO A COMPLETE STOP** before putting the tool down.
12. **NEVER TOUCH** router bits after use. They may be extremely hot.
13. **NEVER TIGHTEN COLLET NUT** without a bit.
14. **DO NOT USE LAMINATE TRIMMER MOTOR WITHOUT THE LAMINATE TRIMMER BASE INSTALLED.** Loss of control could result, causing personal injury or damage to work.
15. **WEAR EYE AND HEARING PROTECTION. ALWAYS USE SAFETY GLASSES.** Everyday eyeglasses are NOT safety glasses. USE CERTIFIED SAFETY EQUIPMENT. Eye protection equipment should comply with ANSI Z87.1 standards. Hearing equipment should comply with ANSI S3.19 standards.
16. **⚠️ WARNING USE OF THIS TOOL CAN GENERATE AND DISBURSE DUST OR OTHER AIRBORNE PARTICLES, INCLUDING WOOD DUST, CRYSTALLINE SILICA DUST AND ASBESTOS DUST.** Direct particles away from face and body. Always operate tool in well ventilated area and provide for proper dust removal. Use dust collection system wherever possible. Exposure to the dust may cause serious and permanent respiratory or other injury, including silicosis (a serious lung disease), cancer, and death. Avoid breathing the dust, and avoid prolonged contact with dust. Allowing dust to get into your mouth or eyes, or lay on your skin may promote absorption of harmful material. Always use properly fitting NIOSH/OSHA approved respiratory protection appropriate for the dust exposure, and wash exposed areas with soap and water.

SYMBOL	DEFINITION
V	volts
A	amperes
Hz	hertz
W	watts
kW	kilowatts
F	farads
μ F	microfarads
l.....	litres
g	grams
kg.....	kilograms
bar	bars
Pa	pascals
h	hours
min.....	minutes
s.....	seconds
n_0	no-load speed
.../min or ...min ⁻¹	Revolutions or reciprocations per minute
 or d.c.....	direct current
 or a.c.	alternating current
2 	two-phase alternating current
2N 	two-phase alternating current with neutral
3 	three-phase alternating current
3N 	three-phase alternating current with neutral
 A	rated current of the appropriate fuse-link in amperes
	time-lag miniature fuse-link where X is the symbol for the time/current characteristic, as given in IEC 60127
	protective earth
	class II tool
IPXX.....	IP symbol

MOTOR

Many Porter-Cable tools will operate on either D.C., or single phase 25 to 60 cycle A.C. current and voltage within plus or minus 5 percent of that shown on the specification plate on the tool. Several models, however, are designed for A.C. current only. Refer to the specification plate on your tool for proper voltage and current rating.

CAUTION

Do not operate your tool on a current on which the voltage is not within correct limits. Do not operate tools rated A.C. only on D.C. current. To do so may seriously damage the tool.

EXTENSION CORD SELECTION

If an extension cord is used, make sure the conductor size is large enough to prevent excessive voltage drop which will cause loss of power and possible motor damage. A table of recommended extension cord sizes will be found in this section. This table is based on limiting line voltage drop to 5 volts (10 volts for 230 volts) at 150% of rated amperes.

If an extension cord is to be used outdoors it must be marked with the suffix W-A or W following the cord type designation. For example – SJTW-A to indicate it is acceptable for outdoor use.

RECOMMENDED EXTENSION CORD SIZES FOR USE WITH PORTABLE ELECTRIC TOOLS

		Length of Cord in Feet									
		115V	25 Ft.	50 Ft.	100 Ft.	150 Ft.	200 Ft.	250 Ft.	300 Ft.	400 Ft.	500 Ft.
		230V	50 Ft.	100 Ft.	200 Ft.	300 Ft.	400 Ft.	500 Ft.	600 Ft.	800 Ft.	1000 Ft.
Nameplate Ampere Rating	0-2	18	18	18	16	16	14	14	12	12	12
	2-3	18	18	16	14	14	12	12	10	10	10
	3-4	18	18	16	14	14	12	12	10	10	8
	4-5	18	18	14	12	12	10	10	8	8	8
	5-6	18	16	14	12	10	10	8	8	6	6
	6-8	18	16	12	10	10	8	6	6	6	6
	8-10	18	14	12	10	8	8	6	6	4	4
	10-12	16	14	10	8	8	6	6	4	4	4
	12-14	16	12	10	8	6	6	6	4	2	2
	14-16	16	12	10	8	6	6	4	4	2	2
	16-18	14	12	8	8	6	4	4	2	2	2
18-20	14	12	8	6	6	4	4	2	2	2	

FUNCTIONAL DESCRIPTION

FOREWORD

Porter-Cable Laminate Trimmers are designed for the flush and bevel trimming of laminated plastics, phenolics, and other similar materials that have a bonding agent too hard to be trimmed with ordinary tools.

The Tilt-Base model allows trimming into corners inaccessible to standard trimmers. This model also allows the trimming of laminated surfaces joining at angles of 45° to 90°. This feature eliminates the need for hand-trimming in many applications.

The Off-Set Base Trimmer is designed for trimming into the corner of a back splash and for trimming narrow ledges.

The Underscribe Base is designed for making accurate “butt” joints in laminated plastics, phenolics and other similar materials. The Underscribe Base is used with the Model 7301 Trimmer Motor and the 43109 Trim Bit.

SELECTING THE BIT

These trimmers are equipped with a 1/4" diameter collet to accept laminate trimming bits having 1/4" diameter shanks. Bits are available as an accessory.

CARTON CONTENTS

1. Trimmer motor
2. Trimmer base (or bases, if a kit is purchased)
3. Wrench (or wrenches, if a kit is purchased)

ASSEMBLY

NOTE: This tool is shipped completely assembled. No assembly time or tools are required.

OPERATION

MODEL 7301 MOTOR UNIT

All laminate trimmers in this manual use the Model 7301 Motor Unit.

TO START AND STOP THE MOTOR

The "ON/OFF" switch (A) Fig. 1 is located on the side of the unit, close to the top. To start the trimmer, move the switch down to the "ON" position. To stop the trimmer, move the switch up to the "OFF" position.

Prior to starting the tool, make sure that the switch is in the "OFF" position and that the power circuit voltage is the same as that shown on the specification plate of the trimmer.

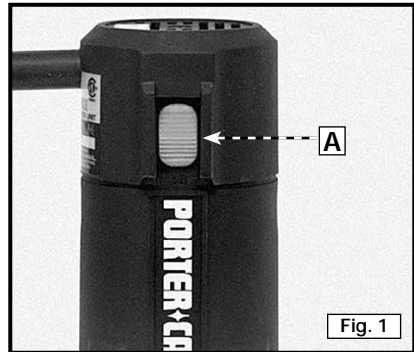

CAUTION

Grasp trimmer firmly to resist starting torque and make sure bit is clear of workpiece and foreign objects.

⚠ WARNING

To avoid personal injury or damage to finished work always allow the motor to come to a COMPLETE STOP before setting trimmer down.

TO INSTALL THE BIT

⚠ WARNING DISCONNECT THE TOOL FROM THE POWER SOURCE.

1. On Models 7310 and 7319, you can install bits either with the motor unit attached or removed.

NOTE: See the instructions (Model 7312) for installing the bit in the OFFSET trimmer. See instructions (Model 7320) for installing the bit in the UNDERSCRIBE trimmer.

2. Clean and insert the shank of the bit (C) Fig. 2 into the collet until the end of the shank bottoms. Then withdraw the bit approximately 1/16".
3. Depress the spindle lock (A) Fig. 2 and rotate the collet nut (B) clockwise by hand until the lock engages the hole in the motor spindle.
4. While holding the spindle lock, use the provided wrench to tighten the collet nut (clockwise) securely.

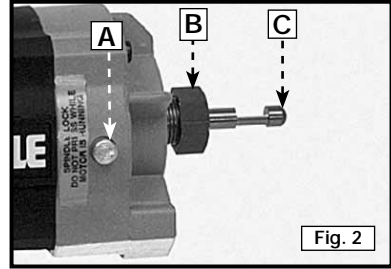

CAUTION To prevent damage to the collet, do not tighten the collet without a bit inserted.

TO REMOVE THE BIT

⚠ WARNING DISCONNECT THE TOOL FROM THE POWER SOURCE.

CAUTION Do not touch the trimmer bits immediately after use. They can get very hot.

1. On Models 7310 and 7319, you can remove bits either with the motor unit attached or removed.

NOTE: See the instructions (Model 7312) for installing the bit in the OFFSET trimmer.

2. Depress the spindle lock and rotate the collet nut counter-clockwise by hand until the lock engages the hole in the motor spindle.
3. While holding the spindle lock engaged, loosen the collet nut by turning it counter-clockwise with the provided wrench.
4. If the bit is tight on the collet, tap the collet nut with a wrench to release the bit.

MODEL 7310 TRIMMER ASSEMBLY

The Model 7310 Trimmer comes completely assembled from the factory. The base is attached to (or removed from) the motor with a base locking screw (Fig. 3).

NOTE: The locking screw (A) Fig. 3 utilizes a spring (B) Fig. 3 and a flat washer (C). Position the spring (B) with its small end against the head of the screw (A). Attach the washer (C) after the spring.

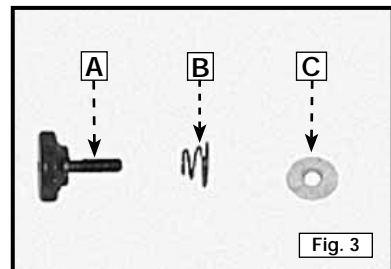

ADJUSTING THE DEPTH OF CUT

1. Loosen the base-locking screw (A) Fig. 4) approximately 1/4 turn.
2. Turn the depth-adjusting wheel (B) Fig. 4 to reduce or increase the depth of cut.
3. Tighten the base-locking screw securely. Make a test cut in scrap material to check the depth of cut.
4. Repeat steps 1 through 3 until the desired depth of cut is achieved.

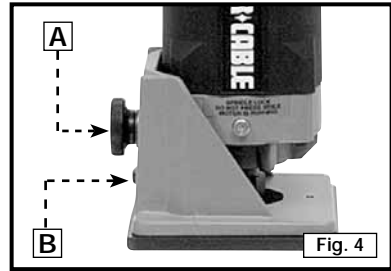

ADJUSTING THE SUB-BASE ALIGNMENT

Applications using a template guide require the bit to be centered within the guide, and the center hole in the sub-base to be in line with the collet of the motor unit. Your model has an adjustable sub-base. To adjust:

1. Install the 42054 Template Guide (available as an accessory) on the sub-base and tighten securely.
2. Loosen the sub-base mounting screws just enough to allow the sub-base to move on the base.
3. Install a straight 1/4" diameter bit in the collet of the motor unit and tighten securely.
4. Attach the motor unit to the base. Align the hole in the template guide with the bit and adjust the depth of cut so that the bit extends through the template guide. Tighten the motor unit in the base.
5. Tighten the sub-base mounting screws securely.

THE OPTIONAL 73100 EDGE GUIDE KIT

The optional Model 73100 Edge Guide Kit is available for use with the Model 7310 trimmer. This kit is designed for use with non-piloted bits on curved or straight applications. Non-piloted bits can produce a 90° straight cut, a 10° bevel cut, or a 22° bevel cut. The kit (Fig. 5) contains:

- A. Base and roller guide - for flush or bevel trimming
- B. Edge guide - for flush trimming
- C. Edge guide - for bevel trimming
- D. Straight edge guide - for straight trimming
- E. Guide setting gauge
- F. Mounting screws
- G. Wrench

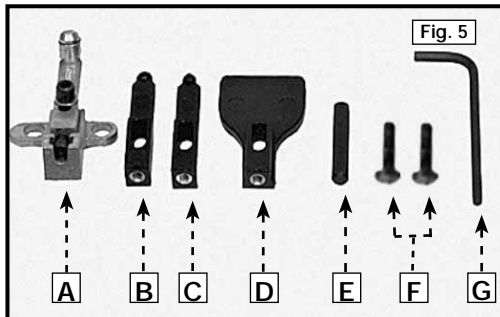

ATTACHING AND ADJUSTING THE BASE AND THE ROLLER GUIDE

1. Remove the power unit from the base unit (see "TO INSTALL BIT").
2. Install the bit.
3. The base and roller guide (A) Fig. 5 is assembled at the factory. To install, remove a sub-base mounting screw (A) Fig. 6 and insert the alignment pin (in the guide base) into the hole (C) in the bottom of the trimmer sub-base. Fasten with two mounting screws (F) Fig. 5 and (C) Fig. 7. Hand tighten for further adjustment.
4. Install the bit (See "TO INSTALL THE BIT."). Then, install the motor to base and adjust the depth of cut (See "ADJUSTING DEPTH OF CUT").
5. Align the roller guide with the bit by loosening the locking screw (A) Fig. 7 and turning the adjusting screw (B) with the provided hex wrench until the guide is in the desired location.

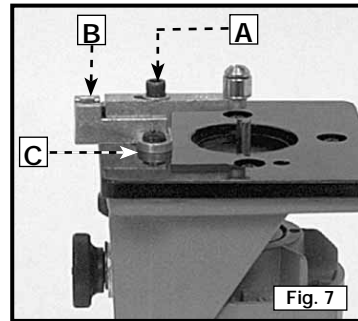
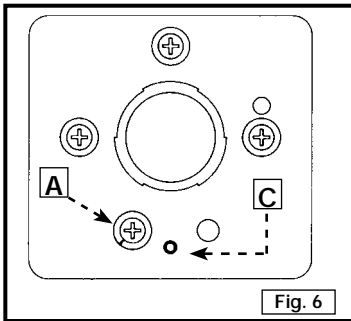

FLUSH TRIMMING

1. Attach the base and guide to the trimmer as outlined in "ATTACHING AND ADJUSTING THE BASE AND ROLLER".
2. Remove the roller guide and replace it with the flush trimming guide (B) Fig. 4. Identify this guide by the molded letter "F". Make sure that the stud on the end of this guide faces the trimmer base.
3. Install the guide setting gauge (E) Fig. 4 in the trimmer collet (see "TO INSTALL THE BIT"). Install the trimmer motor to the base. Adjust the guide so that hole in the end of the gauge is positioned over the guide stud.
4. Remove the guide setting gauge from the trimmer and install a flush trimming bit.
5. Adjust the depth of cut so that the straight portion of the bit extends below the trimmer base at least the thickness of the workpiece.
6. Make a trial cut on scrap material.

BEVEL TRIMMING

1. Follow Steps 1 through 5 under "FLUSH TRIMMING", except install the bevel trimming guide (C) Fig. 4. This guide is identified by the molded letter "B".
2. Adjust the depth of cut so that only the bevel portion of the bit extends below the trimmer base at least the thickness of the material to be trimmed.
3. Make a trial cut on scrap material to check alignment.

USING STRAIGHT EDGE GUIDE

You can use the straight edge guide (D) Fig. 5 with either bit for trimming straight edges.

Attach it to the guide base and adjust similar to the other guides.

MODEL 7319 TILT BASE TRIMMER ASSEMBLY

Model 7319 Tilt Base Trimmer is completely attached at the factory. You can remove the base from the Model 7301 motor with a base locking screw (A) Fig. 8.

NOTE: A flat washer (B) Fig. 8 is on the locking screw.

Model 7319 Tilt Base is designed for use with 43216PC flush trim bit for trimming into corners. You may also use it with other "self pilot" trim bits for conventional trimming at 90° setting.

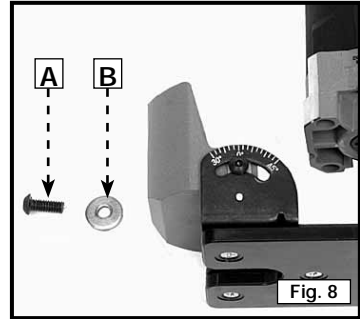

ADJUSTING THE DEPTH OF CUT

⚠ WARNING DISCONNECT THE TOOL FROM THE POWER SOURCE!

Loosen the base locking screw and move the motor unit up or down to decrease or increase the depth-of-cut.

You may have to slightly withdraw some bits in the collet to obtain a maximum depth of cut.

⚠ CAUTION When you withdraw a bit, be certain that at least 1/2" of the bit shank is engaged in the collet. Do not use bits that result in having less than 1/2" of the bit shank engaged in the collet. To do so may cause poor gripping of the collet, resulting in a loose bit. If the bit comes out of the collet, it could cause damage to the workpiece and/or personal injury.

ADJUSTING THE TILT

1. Loosen two tilt locking screws (C) Fig. 9 (one on each side of base) using the provided wrench.
2. Match the base-aligning index mark (D) Fig. 9 with the desired angle and tighten securely.
3. Make a trial cut on scrap material to check the alignment.

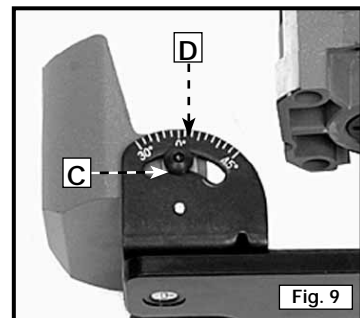

MODEL 7312 OFFSET TRIMMER ASSEMBLY

Your Model 7312 Offset Trimmer was assembled at the factory. However, if you choose to attach an auxiliary base, use the following instructions:

⚠ WARNING DISCONNECT THE TOOL FROM THE POWER SOURCE!

1. Remove the collet nut and collet from the motor unit.
2. Attach the drive pulley (A) Fig. 10 to the motor spindle. Tighten securely.
3. Use a phillips screwdriver to remove the three sub-base mounting screws (A) Fig. 11 from the base. Remove the sub-base.
4. Position the base on the motor and the drive pulley assembly (from **STEP 2**). Be sure that the motor drive pulley engages the drive belt inside the base housing.
5. Secure the motor to the base (Fig. 9) with the thumbscrew (A), spring (B), and washer (C).
6. Use the Phillips screwdriver to install a #6-32 x 3/8" screw (D) as shown in Fig. 12. Tighten securely.
7. Clean the collet nut and collet, and attach to the spindle in the offset base. Hand tighten for further adjustment.

CAUTION Tightening the collet nut without a bit installed in the collet is likely to damage the collet.

8. Position the sub-base to the base housing and secure with the three screws that were removed in **STEP 3**.

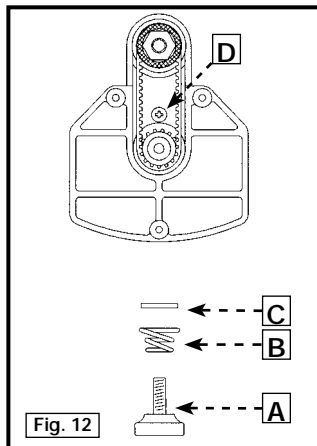
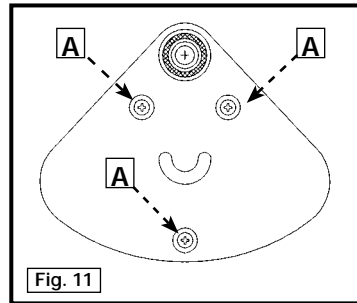
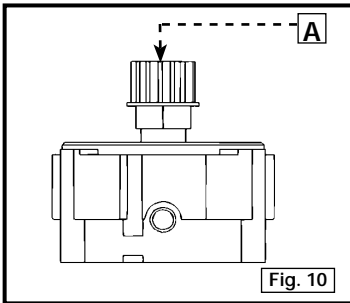

TO INSTALL & REMOVE THE BIT

⚠ WARNING DISCONNECT THE TOOL FROM THE POWER SOURCE!

1. Insert the long portion of the hex wrench (A) Fig. 13 through the spindle lock hole (B) Fig. 13, so that the wrench protrudes from both sides of the base housing. Rotate the spindle by hand to align the hole in the spindle with the holes in the housing.
2. Clean and insert the bit shank into the collet. Tighten the collet nut securely with the collet wrench.

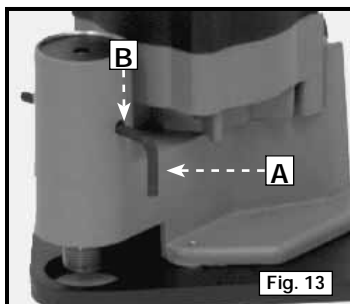

CAUTION To prevent damage to the drive belt, never tighten or loosen the collet nut with the spindle lock engaged.

3. To remove the bit, reverse the procedure. If the bit will not remove easily, lightly tap the bit shank with a wrench.

CAUTION To prevent damage to the collet, never tighten the collet without a bit inserted.

ADJUSTING THE DEPTH OF CUT

⚠ WARNING DISCONNECT THE TOOL FROM THE POWER SOURCE!

1. Loosen the bit in the collet (See "TO INSTALL & REMOVE THE BIT").
2. Place the hex wrench (A) Fig. 14 in the depth-adjusting screw (B).
3. Hold the spindle (C) Fig. 14 with your fingers. Apply light upward pressure on the bit to maintain contact between the bit shank and the adjusting screw. Turn the hex wrench counter-clockwise to increase exposure and clockwise to decrease exposure.
4. To turn the sub-base over for long-shank bits:
 - A. Remove three sub-base mounting screws.
 - B. Turn sub-base over and re-attach using screws removed in **STEP A**.

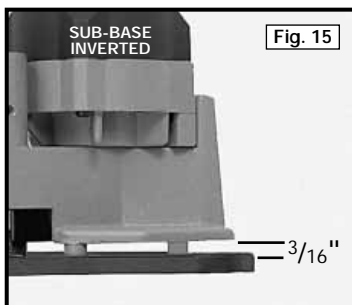
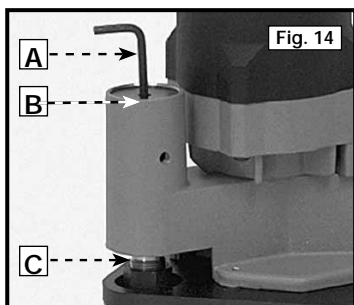

OPERATION

⚠ WARNING DISCONNECT THE TOOL FROM THE POWER SOURCE.

⚠ CAUTION Always wear safety glasses while operating a laminate trimmer.

1. Allow your workpiece to overhang the base material by at least 1/8".
2. Firmly grasp the motor housing, being sure switch is in the "OFF" position.
3. Ensure that the bit is clear of foreign objects and that the cord will not "hang up" on any obstructions.
4. Hold the workpiece firmly in place. Use clamps when necessary.
5. Plug in the power supply cord. Be alert to resist the starting torque of the motor. Turn motor "ON".
6. Allow the motor to reach "full speed". Place the base of the trimmer on the surface of the workpiece. Feed the trimmer into the work until the bit pilot contacts the base material. When guiding on a previously laminated surface, always wax or lubricate the area where the guide will ride.

NOTE: While operating the trimmer with the tilt base at any tilt setting other than "0" degrees, keep the long side of the base perpendicular to the piloting surface to prevent possible work spoilage.

7. Feed from left to right with a smooth steady motion (See Fig. 16).
8. When the operation is complete, turn the switch "OFF". Allow the motor to come to a complete stop before laying the trimmer down.

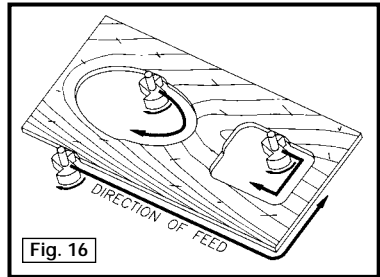

UNDERSCRIBE 7320 TRIMMER ASSEMBLY

To attach the Underscribe Trimmer Base to the Model 7301 Trimmer Motor:

NOTE: The 43109 Trim Bit must be installed into the Trimmer Motor before attaching the motor to the Underscribe Base.

⚠ WARNING DISCONNECT THE TOOL FROM THE POWER SOURCE!

1. Clean and insert the shank of the bit (A) Fig. 17, into the collet until the end of the shank bottoms. Then pull the bit out approximately 1/8".
2. Depress the spindle lock (B) Fig. 17, and rotate the collet nut (C) clockwise by hand until the lock engages the hole in the motor spindle.
3. While holding the spindle lock engaged, tighten the collet nut securely by turning it clockwise, using the provided wrench.

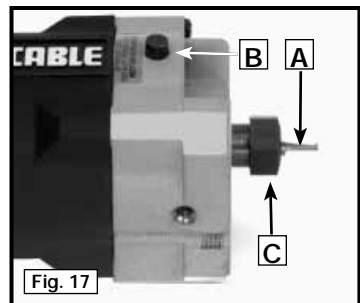

CAUTION To prevent damage to the collet, never tighten the collet without a bit inserted.

- Secure the base (A) Fig. 19 on the motor (B) using the locking screw (E), spring (D) and washer (C) Fig. 18.

NOTE: Orient the spring with the small end against the head of the locking screw.

- Align the two holes in the underscribe attachment (G) Fig. 18 with the two holes in the base (A).
- Attach the underscribe attachment (G) Fig. 19 to the base (A) with two screws and an eccentric washer.

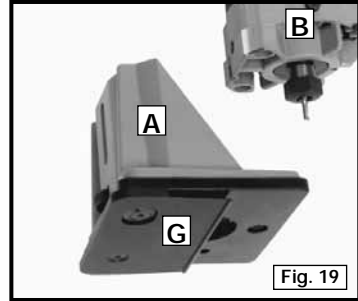
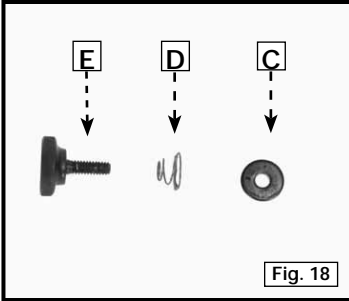

TYPICAL APPLICATIONS

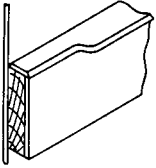
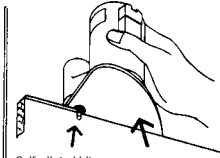
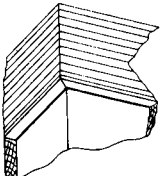
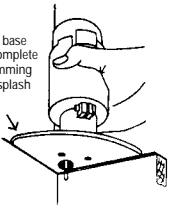
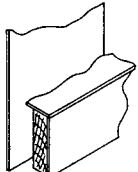
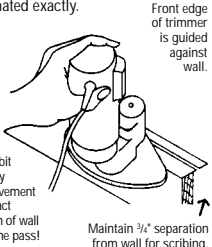
TRIMMING $\frac{3}{4}$ " VERTICAL BACKSPASH	IN-AND-OUT TRIMMING OF INSTALLED CORNER	SCRIBING OF BACKSPASH TO WALL
 <p>APPLICATION – Trimming front edge of $\frac{3}{4}$" vertical backsplash. This is an operation standard trimmers with round or square bases are unable to do without the use of a special bit.</p>  <p>Self-piloted bit guides trimmer for one-pass trimming every time.</p> <p>Triangular base enables trimming with backsplash in place.</p> <p>OPERATION – Trimming $\frac{3}{4}$" backsplash with the new Porter-Cable Offset Laminate Trimmer fitted with a solid carbide self-piloted bit.</p>	 <p>APPLICATION – Trimming into and out of installed backsplash corner with little or no hand trimming required.</p>  <p>Triangular base enables complete corner trimming with backsplash in place.</p> <p>OPERATION – The new Porter-Cable Offset Trimmer will trim into and out of 90° corners with ease using self-piloted bit.</p>	 <p>APPLICATION – Accurately scribing the back side of a preassembled panel or post-formed backsplash. Once the lip is accurately scribed, the trimmed portion is then pushed against the wall and mated exactly.</p>  <p>Self-piloted bit follows every trimmer movement to create exact reproduction of wall surface in one pass!</p> <p>Front edge of trimmer is guided against wall.</p> <p>Maintain $\frac{1}{8}$" separation from wall for scribing.</p> <p>OPERATION – The guide assembly must be removed. Using the self-piloted bit, the Porter-Cable Offset Trimmer scribes accurately to the wall surface.</p>

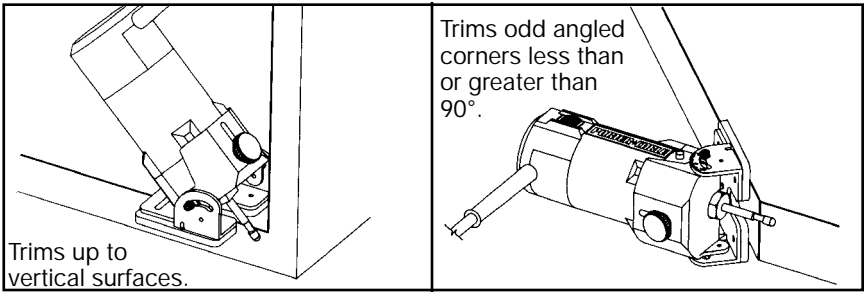

ADJUSTING THE BIT EXPOSURE

⚠ WARNING DISCONNECT THE TOOL FROM THE POWER SOURCE.

1. Loosen the base locking screw (E) Fig. 20 approximately 1/4 turn.
2. Turn the depth-adjusting wheel (D) Fig. 20 counter-clockwise (looking at top of wheel) to lower the bit until it touches the guide plate.
3. Firmly tighten the locking screw (E).

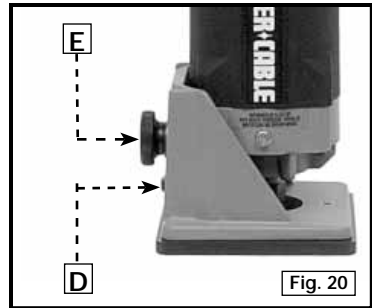

Fig. 20

ADJUSTING GUIDE PLATE

The Underscribe Trimmer Base is equipped with an adjustable guide plate (Fig. 21). Adjust the guide plate by rotating the eccentric, using the special wrench that is supplied with the Trimmer Base. To adjust the guide:

1. Make a trial cut using scrap material and check the fit.

⚠ WARNING DISCONNECT THE TOOL FROM THE POWER SOURCE.

2. Turn the eccentric to correct fit.

NOTE: If the joint is too loose (with a crack between the two pieces of laminate), turn the eccentric clockwise. If joint is too tight so that the laminate will not snap into place, turn the eccentric counter-clockwise.

3. Repeat Steps 1 through 3 as required to achieve a good fit.

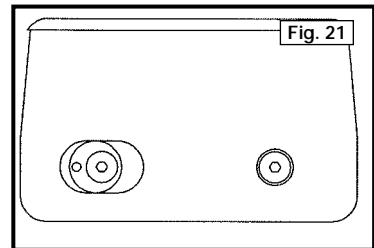

USING THE UNDERSCRIBE TRIMMER

The bottom plate of the Underscribe Trimmer has a guide lip (Fig. 22). This guide lip is moved along an installed piece of laminate as the trimmer bit cuts the mating piece of laminate.

The "butt" joint is commonly used in the construction of face frames. To install a laminate covering on a face frame:

CAUTION Always wear safety glasses while operating a laminate trimmer.

- A Trimmer Base
- B Sub-Base
- C Installed laminate
- D Guide Lip
- E Bit
- F Laminate

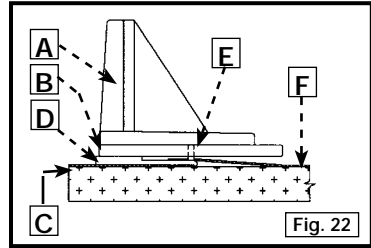

1. Cut the pieces of laminate covering to rough size. Apply contact cement to the face frame and the laminate pieces in the normal manner.

NOTE: Cut the rail covering approximately 1" longer than the rail (to allow material for trimming).

2. Apply the laminate to all stiles.
3. Position the laminate to a rail with at least 1/4", and no more than 3/4", overlapping each stile (see Fig. 23). Use a roller to secure the center section of the laminate to the rail. Leave at least 4" of the laminate loose, at both ends of the rail (Do not roll it down).

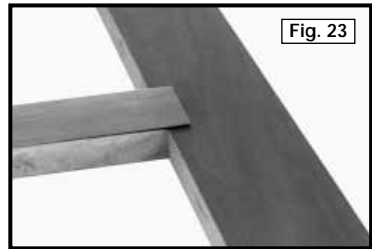

4. Securely clamp the face frame assembly to the worktable to prevent movement during the trimming operation.
5. Position the underscribe trimmer onto the face frame so that the top (see Fig. 24), is against the edge of the stile.

NOTE: The trimmer should be to the right of the rail, so that the cutting action will move from right to left (see Fig. 24).

NOTE: The finished cut is illustrated in Fig.25.

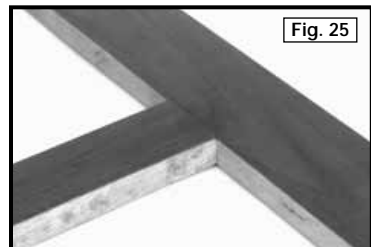
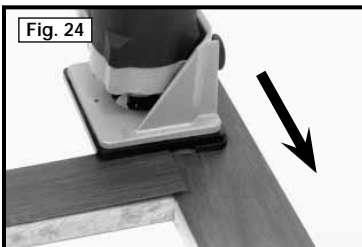

6. Verify that the bit is clear of foreign objects and that the cord will not get caught on any obstructions.
7. Grasp the motor firmly to resist starting torque and move the switch button to the "ON" position.
8. Allow the motor to reach full-speed. Feed the trimmer from right to left with a smooth steady motion.

NOTE: The tapered edge of the underscribe base will slide underneath the rail covering, lifting the laminate into the cutter.

9. After completing the cut, move the switch button to the "OFF" position and allow the motor to come to a complete stop before putting the trimmer down.
10. Press the rail end into position and roll down.
11. Repeat this process as necessary to complete the face frame.

TROUBLESHOOTING

For assistance with your tool, visit our website at www.porter-cable.com for a list of service centers, or call the Porter-Cable Customer Care Center at 1-800-223-7278.

MAINTENANCE

KEEP TOOL CLEAN

Periodically blow out all air passages with dry compressed air. All plastic parts should be cleaned with a soft damp cloth. NEVER use solvents to clean plastic parts. They could possibly dissolve or otherwise damage the material.

▲ WARNING Wear ANSI Z87.1 safety glasses while using compressed air.

FAILURE TO START

Should your tool fail to start, check to make sure the prongs on the cord plug are making good contact in the outlet. Also, check for blown fuses or open circuit breakers in the line.

LUBRICATION

This tool has been lubricated with a sufficient amount of high grade lubricant for the life of the unit under normal operating conditions. No further lubrication is necessary.

BRUSH INSPECTION (If applicable)

For your continued safety and electrical protection, brush inspection and replacement on this tool should ONLY be performed by an AUTHORIZED PORTER-CABLE SERVICE STATION or a PORTER-CABLE•DELTA FACTORY SERVICE CENTER.

At approximately 100 hours of use, take or send your tool to your nearest authorized Porter-Cable Service Station to be thoroughly cleaned and inspected. Have worn parts replaced and lubricated with fresh lubricant. Have new brushes installed, and test the tool for performance.

Any loss of power before the above maintenance check may indicate the need for immediate servicing of your tool. DO NOT CONTINUE TO OPERATE TOOL UNDER THIS CONDITION. If proper operating voltage is present, return your tool to the service station for immediate service.

SERVICE

REPLACEMENT PARTS

Use only identical replacement parts. For a parts list or to order parts, visit our website at servicenet.porter-cable.com. You can also order parts from your nearest factory-owned branch, or by calling our **Customer Care Center** at 1-800-223-7278 to receive personalized support from highly-trained technicians.

SERVICE AND REPAIRS

All quality tools will eventually require servicing and/or replacement of parts. For information about Porter-Cable, its factory-owned branches, or an Authorized Warranty Service Center, visit our website at www.porter-cable.com or call our **Customer Care Center** at 1-800-223-7278. All repairs made by our service centers are fully guaranteed against defective material and workmanship. We cannot guarantee repairs made or attempted by others.

You can also write to us for information at PORTER-CABLE, 4825 Highway 45 North, Jackson, Tennessee 38305 - Attention: Product Service. Be sure to include all of the information shown on the nameplate of your tool (model number, type, serial number, etc.).

ACCESSORIES

A complete line of accessories is available from your Porter-Cable•Delta Supplier, Porter-Cable•Delta Factory Service Centers, and Porter-Cable Authorized Service Stations. Please visit our Web Site www.porter-cable.com for a catalog or for the name of your nearest supplier.

▲ WARNING Since accessories other than those offered by Porter-Cable•Delta have not been tested with this product, use of such accessories could be hazardous. For safest operation, only Porter-Cable•Delta recommended accessories should be used with this product.

WARRANTY

To register your tool for warranty service visit our website at www.porter-cable.com.

PORTER-CABLE LIMITED ONE YEAR WARRANTY

Porter-Cable warrants its Professional Power Tools for a period of one year from the date of original purchase. We will repair or replace at our option, any part or parts of the product and accessories covered under this warranty which, after examination, proves to be defective in workmanship or material during the warranty period. For repair or replacement return the complete tool or accessory, transportation prepaid, to your nearest Porter-Cable Service Center or Authorized Service Station. Proof of purchase may be required. This warranty does not apply to repair or replacement required due to misuse, abuse, normal wear and tear or repairs attempted or made by other than our Service Centers or Authorized Service Stations.

ANY IMPLIED WARRANTY, INCLUDING THE IMPLIED WARRANTIES OF MERCHANTABILITY AND FITNESS FOR A PARTICULAR PURPOSE, WILL LAST ONLY FOR ONE (1) YEAR FROM THE DATE OF PURCHASE.

To obtain information on warranty performance please write to: PORTER-CABLE, 4825 Highway 45 North, Jackson, Tennessee 38305; Attention: Product Service. THE FOREGOING OBLIGATION IS PORTER-CABLE'S SOLE LIABILITY UNDER THIS OR ANY IMPLIED WARRANTY AND UNDER NO CIRCUMSTANCES SHALL PORTER-CABLE BE LIABLE FOR ANY INCIDENTAL OR CONSEQUENTIAL DAMAGES. Some states do not allow limitations on how long an implied warranty lasts or the exclusion or limitation of incidental or consequential damages, so the above limitation or exclusion may not apply to you.

This warranty gives you specific legal rights and you may also have other legal rights which vary from state to state.

PORTER  CABLE®

4825 Highway 45 North

Jackson, TN 38305

1-800-223-7278

www.porter-cable.com

Free Manuals Download Website

<http://myh66.com>

<http://usermanuals.us>

<http://www.somanuals.com>

<http://www.4manuals.cc>

<http://www.manual-lib.com>

<http://www.404manual.com>

<http://www.luxmanual.com>

<http://aubethermostatmanual.com>

Golf course search by state

<http://golfingnear.com>

Email search by domain

<http://emailbydomain.com>

Auto manuals search

<http://auto.somanuals.com>

TV manuals search

<http://tv.somanuals.com>