

Poulan PRO®

ENGLISH

Instruction Manual Manual de Instrucciones Manuel d'Instructions

PPB1000E

ESPAÑOL



WARNING:

Read and follow all Safety Rules and Operating Instructions before using this product. Failure to do so can result in serious injury.

ADVERTENCIA:

Lea el manual de instrucciones y siga todas las advertencias e instrucciones de seguridad. El no hacerlo puede resultar en lesiones graves.

AVERTISSEMENT:

Lire le manuel d'instructions et bien respecter tous les avertissements et toutes les instructions de sécurité. Tout défaut de le faire pourrait entraîner des blessures graves.

Electrolux Home Products, Inc.
250 Bobby Jones Expressway
Augusta, GA 30907

 **The Electrolux Group.** *The world's No.1 choice.*
KITCHEN, CLEANING AND OUTDOOR APPLIANCES COMBINED

Copyright ©2003 Electrolux Home Products, Inc.

530164267 10/3/03

FRANÇAIS

IDENTIFICATION OF SYMBOLS



DANGER! This lawn edger can be dangerous! Careless or improper use can cause serious or even fatal injury.



Read and understand the instruction manual before using the lawn edger.



Always wear appropriate ear protection, eye protection and head protection.

SAFETY RULES

WARNING: When using gardening appliances, basic safety precautions must always be followed to reduce the risk of fire and serious injury. Read and follow all instructions.

This power unit can be dangerous! Operator is responsible for following instructions and warnings on unit and in manual. Read entire instruction manual before using unit! Be thoroughly familiar with the controls and the proper use of the unit. Restrict the use of this unit to persons who have read, understand and will follow the instructions and warnings on the unit and in the manual. Never allow children to operate this unit.



SAFETY INFORMATION
ON THE UNIT

OPERATOR SAFETY

WARNING: RISK OF CUT. KEEP HANDS AND FEET AWAY FROM BLADE AND CUTTING AREA. Do not attempt to clear away cut material or hold material to be cut when the blade is in motion. Make sure powerhead is stopped and spark plug wire is disconnected (or powerhead is disconnected from power source) when removing jammed material from the cutting blade. Do not grab or hold attachment by the cutting blade.

- Dress properly. Always wear safety glasses or similar eye protection when operating, or performing maintenance on your unit (safety glasses are available). Eye protection should be marked Z87.
- Always wear face or dust mask if operation is dusty.
- Always wear heavy, long pants, long sleeves, boots, and gloves.
- Always wear foot protection. Do not go barefoot or wear sandals.
- Secure hair above shoulder length. Secure or remove loose clothing or clothing with loosely hanging ties, straps, tassels, etc. They can be caught in moving parts.

- Being fully covered also helps protect you from debris and pieces of toxic plants thrown by spinning blade.
- Stay alert. Do not operate when you are tired, ill, upset, or under the influence of alcohol, drugs, or medication. Watch what you are doing; use common sense.
- Wear hearing protection.
- Never start or run inside a closed room or building. Breathing exhaust fumes can kill.
- Keep handles free of oil and fuel.
- Only operate unit with handlebar installed.
- Keep hands and feet away from cutting area.
- Never direct discharge of material toward bystanders nor allow anyone near the area of operation. Use care in directing discharge to avoid glass enclosures, automobiles, and the like.

FUEL SAFETY (for gas powerheads)

- Mix and pour fuel outdoors.
- Keep away from sparks or flames.
- Use a container approved for fuel.
- Do not smoke or allow smoking near fuel or the powerhead.
- Avoid spilling fuel or oil. Wipe up all fuel spills before starting the powerhead.
- Move at least 10 feet (3 meters) away from fueling site before starting powerhead engine.
- Stop engine and allow to cool before removing fuel cap.
- Remove fuel cap slowly.

ELECTRICAL SAFETY (for electric powerheads)

- WARNING:** Avoid a dangerous environment. To reduce the risk of electrical shock, do not use in rain, in damp or wet locations, or around swimming pools, hot tubs, etc. Do not expose to snow, rain, or water to avoid the possibility of electrical shock. Do not handle extension cord plug or unit with wet hands.
- Use only a voltage supply as shown on the nameplate of the unit.
 - Avoid dangerous situations. Do not use in presence of flammable liquids or gases to avoid creating a fire or explosion and/or causing damage to unit.

- Avoid dangerous environments. Do not use in unventilated areas or where dust or explosive vapors can build up.
- To reduce the risk of electrical shock, use extension cords specifically marked as suitable for outdoor appliances. The electrical rating of the cord must not be less than the rating of the unit. The cord must be marked with the suffix "W-A" (in Canada, "W"). Make sure your extension cord is in good condition. Inspect extension cord before use and replace if damaged. An undersized extension cord will cause a drop in line voltage resulting in loss of power and overheating. If in doubt, use the next heavier gauge. The smaller the gauge number, the heavier the cord.
- Do not use multiple cords.
- The powerhead may have a polarized plug (one blade is wider than the other); if so, it will require the use of a polarized extension cord. The appliance plug will fit into a polarized extension cord only one way. If the plug does not fit fully into the extension cord, reverse the plug. If the plug still does not fit, obtain a correct polarized extension cord. A polarized extension cord will require the use of a polarized wall outlet. This plug will fit into the polarized wall outlet only one way. If plug does not fit fully into the wall outlet, reverse the plug. If it still does not fit, contact a qualified electrician to install the proper wall outlet. Do not change the equipment plug, extension cord receptacle, or extension cord plug in any way.
- Do not attempt to repair unit. Inspect the insulation and connectors on the powerhead and extension cord before each use. If there is any damage, do not use until damage is repaired by your authorized service dealer.
- Do not pull or carry by cord; do not use cord as a handle, close a door on cord, or pull cord around sharp edges or corners. Keep cord away from heated surfaces. Do not unplug by pulling on cord. To unplug, grasp the plug, not the cord.
- Do not use the powerhead if the switch does not turn the unit on and off properly. Have the unit repaired by your authorized service dealer.
- Keep the extension cord clear of operator and obstacles at all times. Do not expose cords to heat, oil, water, or sharp edges.
- Avoid any body contact with any grounded conductor, such as metal fences, or pipes, to avoid the possibility of electric shock. Don't handle plug or unit with wet hands.
- Do not use with damaged cord or plug. If powerhead is not working as it should, has been dropped, damaged, left outdoors, or dropped into water, return it to your authorized service for repair.
- Ground Fault Circuit Interrupter (GFCI) protection should be provided on the circuit or outlet to be used for the powerhead. Receptacles are available having built-in GFCI protection and may be used for this measure of safety.

Your powerhead should be double insulated to help protect against electric shock. Double insulation construction consists of two separate "layers" of electrical insulation instead of grounding. Tools and appliances built with a double insulation system are not intended to be grounded. Safety precautions must be observed when operating any electrical tool. The double insulation system only provides added protection against injury resulting from an internal electrical insulation failure.

⚠ WARNING: All repairs to an electric powerhead, including housing, switch, motor, etc., must be diagnosed and repaired by qualified service personnel. Replacement parts for a double insulated appliance must be identical to the parts they replace. A double insulated appliance is marked with the words "double insulation" or "double insulated". The symbol  (square within a square) may also be marked on the appliance. Failure to have the unit repaired by your authorized service dealer can cause the double insulation construction to become ineffective and result in serious injury.

UNIT/MAINTENANCE SAFETY

⚠ WARNING: Disconnect powerhead spark plug (or disconnect powerhead from power source) before performing maintenance.







- Inspect entire unit before each use. Replace damaged parts. Check for fuel leaks. Make sure all fasteners are in place and securely fastened.
- Maintain unit according to recommended procedures.
- Throw away blades that are bent, warped, cracked, broken, or damaged in any other way. Replace parts that are cracked, chipped, or damaged before using the unit.
- Use only recommended Poulan PRO® parts and accessories. Never use wire, wire rope, string, flailing devices, etc.
- Be sure blade stops turning when engine idles (see CARBURETOR ADJUSTMENTS section of powerhead manual).
- Remove the blade before making carburetor adjustments. Hold the unit by hand. Do not make carburetor adjustments from the blade side of the unit.
- Keep others away when making carburetor adjustments.
- Never start the unit with the clutch housing removed. The clutch can fly off and cause serious injury.
- Have all maintenance and service not explained in this manual performed by an authorized service dealer.
- If blade strikes a foreign object, follow these steps: stop unit and disconnect spark plug wire (or disconnect from power source), inspect for damage, and repair any damage before resuming operation of the unit.

EDGING SAFETY

WARNING: Inspect the area to be edged before each use. Remove objects (rocks, broken glass, nails, wire, string, etc.) which can be thrown by the blade or can wrap around the shaft.

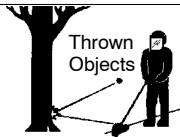
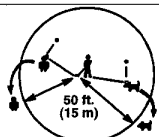
- Keep others including children, animals, bystanders, and helpers at least 50 feet (15 meters) away. Stop the unit immediately if you are approached.
- Hold the unit firmly with both hands.
- Keep firm footing and balance. Do not over-reach or stand on unstable surfaces.
- Always keep the wheel in contact with the ground.
- Keep all parts of your body away from the blade and muffler.

- Always push the unit slowly over the ground. Stay alert for uneven sidewalks, holes in the terrain, large roots, etc.
- Do not force the unit. Use only for jobs explained in this manual. Use only for edging. Do not abuse unit. Do not use in rain or wet locations.
- To reduce the risk of fire, do not allow excessive grass, leaves, or grease to accumulate on the attachment.
- Objects struck by the cutting member can cause serious injuries to persons. The lawn should always be carefully examined and cleared of all objects prior to edging.
- Never operate without blade shield in place.

| | | |
|---|--|--|
|  Safety Glasses  Boots |  Thrown Objects | <p>WARNING:</p> <p>Blades can throw objects violently.</p> <ul style="list-style-type: none"> • You can be blinded or injured. • Wear safety glasses and boots. |
|  | | <p>WARNING:</p> <p>Hazard zone for thrown objects.</p> <ul style="list-style-type: none"> • Blades can throw objects violently. • Others can be blinded or injured. • Keep people and animals 50 feet (15 m) away. |
| <p>Blades move momentarily after the trigger is released.</p>  | <p>Allow blades to stop before removing them from the cut.</p>  | <p>WARNING:</p> <p>Blades move momentarily after the trigger is released.</p> <ul style="list-style-type: none"> • The blades can seriously cut you or others. • Allow blades to stop before removing them from the cut. |
|  Instruction Manual |  Safety Decals | <p>WARNING:</p> <p>Read Instruction Manual.</p> <ul style="list-style-type: none"> • Follow all warnings and instructions. • Failure to do so can result in serious injury. |

TRANSPORTING AND STORAGE

- Do not grasp or hold exposed blade.
- Stop powerhead before leaving work area.
- Allow powerhead and gearbox to cool before storing or transporting it in a vehicle.
- Store unit and fuel in area where fuel vapors cannot reach sparks or open flames from water heaters, electric motors or switches, furnaces, etc.
- Store attachment so blade cannot accidentally cause injury.
- Store attachment indoors, out of reach of children.

If situations occur which are not covered in this manual, use care and good judgment. If you need assistance, call 1-800-554-6723.

SPECIAL NOTICE: Exposure to vibrations through prolonged use of gasoline powered hand tools could cause blood vessel or nerve damage in the fingers, hands, and joints of people prone to circulation disorders or abnormal swellings. Prolonged use in cold weather has been linked to blood vessel damage in otherwise healthy people. If symptoms occur such as numbness, pain, loss of strength, change in skin color or texture, or loss of feeling in the fingers, hands, or joints, discontinue the use of this tool and seek medical attention. An anti-vibration system does not guarantee the avoidance of these problems. Users who operate power tools on a continual and regular basis must monitor closely their physical condition and the condition of this unit.

SAVE THESE INSTRUCTIONS

STANDARDS: This edger attachment is Listed by Underwriter's Laboratories, Inc., in accordance with UL Standard 1602, "Gasoline-Engine-Powered, Rigid-Cutting-Member, Edgers and Edger Trimmers," only when used with the following models:

| | |
|--|-------|
| 31cc Powerhead (with trimmer attachment) | PP036 |
| 31cc Powerhead (with trimmer attachment) | PP136 |

ASSEMBLY

WARNING: If received assembled, repeat all steps to ensure your unit is properly assembled and all fasteners are secure.

Examine parts for damage. Do not use damaged parts.

NOTE: If you need assistance or find parts missing or damaged, call 1-800-554-6723.

TOOLS REQUIRED

- Hex wrench (provided)

HANDLEBAR ASSEMBLY

DANGER: RISK OF CUT. To avoid serious injury, the barrier portion of the handlebar must be installed as shown on the upper shaft of the powerhead to provide a barrier between operator and the spinning blade. Attach handlebar mounting bracket above arrow on safety warning decal on the upper shaft (powerhead end of unit). Ensure handlebar is positioned on mounting bracket at the end of the arrow on the handlebar decal.

NOTE: Two mounting brackets are included with this attachment. Both brackets are provided to adapt this attachment for use with powerheads that have either a 1" (2.5 cm) diameter or a 7/8" (2.2 cm) diameter upper shaft. The correct bracket must be used to ensure that the handlebar is mounted securely to the upper shaft before use.

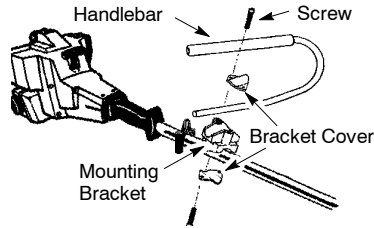

1. Place the mounting bracket over the upper shaft above the arrow on the safety label. Be sure to use the correct mounting bracket for either the 1" (2.5 cm) or 7/8" (2.2 cm) diameter upper shaft.
2. Position one of the bracket covers under the upper shaft and align the mounting bracket and the bracket cover screw holes. Insert two screws into the screw holes.
3. Secure the mounting bracket by tightening the screws with the hex wrench.
4. Locate the decal on the handlebar. This decal includes an arrow. Position the handlebar with the mounting bracket at the end of the arrow.
5. Position the second bracket cover over the handlebar. Align the mounting bracket and the bracket cover screw holes. Again make sure the handlebar is at the end of the arrow.
6. Insert two screws and hand tighten only. Be sure the handlebar is installed correctly; then, tighten each screw securely with the hex wrench.

OPERATION

KNOW YOUR EDGER ATTACHMENT

READ THIS INSTRUCTION MANUAL AND SAFETY RULES BEFORE OPERATING YOUR EDGER ATTACHMENT. Compare the illustrations with your attachment to familiarize yourself with the location of the various controls and adjustments. Save this manual for future reference.

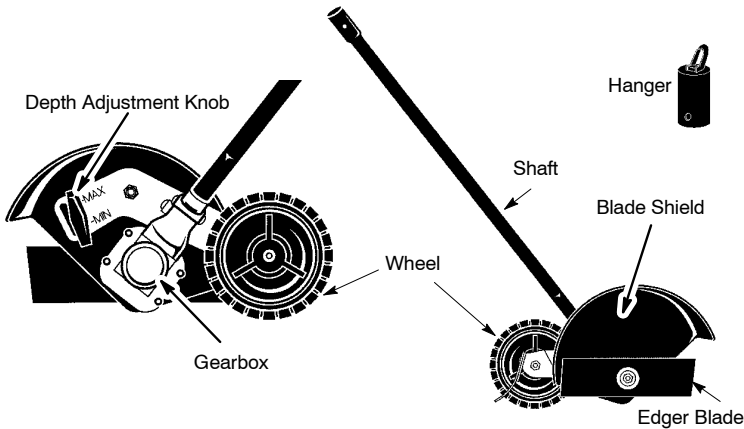

BLADE

The BLADE is designed to cut sod.

DEPTH ADJUSTMENT KNOB

The DEPTH ADJUSTMENT KNOB is used to adjust the wheel for blade cutting depth.

OPERATING THE COUPLER

Your powerhead is equipped with a coupler which enables optional attachments to be installed. The optional attachments are:

| | |
|-------------------|---------------|
| | MODEL: |
| Cultivator | PPB2000T |
| Blower | PPB3000B |
| Brushcutter | PPB4000C |

WARNING: Always disconnect powerhead spark plug (or disconnect powerhead from power source) before removing or installing attachments.

REMOVING ATTACHMENT

CAUTION: When removing or installing attachments, place the powerhead and attachment on a flat surface for stability.

1. Loosen the coupler by turning the knob counterclockwise.

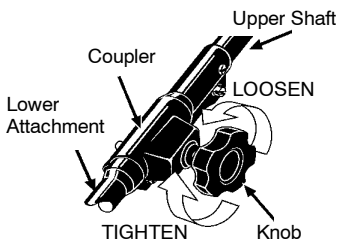

2. Press and hold the locking/release button.



3. While securely holding the upper shaft, pull the attachment straight out of the coupler.

INSTALLING ATTACHMENT

1. Remove the shaft cap from the attachment (if present) and discard.
2. Position locking/release button of attachment into guide recess of upper shaft coupler.

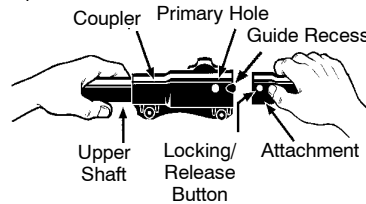

3. Push the attachment into the coupler until the locking/release button snaps into the primary hole.
4. Before using the unit, tighten the knob securely by turning clockwise.

INSTALLING ATTACHMENT HANGER

An attachment hanger is provided for storage when attachment is not in use.

To install hanger on attachment:

1. Remove the shaft cap from the attachment (if present) and discard.
2. Press and hold the locking/release button.
3. Push hanger onto the attachment until the locking/release button snaps into the hole.

OPERATING POSITION

ALWAYS WEAR:

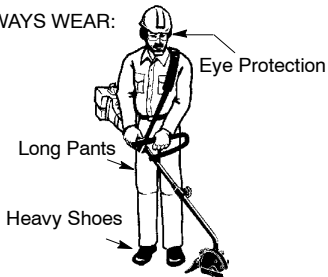

When operating unit, stand as shown and check for the following:

- Wear eye protection and heavy clothing.
- Keep right arm slightly bent with right hand holding the trigger handle of powerhead.
- Keep left arm extended with left hand holding the handlebar.
- Keep unit below waist level.
- Adjust edger wheel for proper cut depth.

WARNING: Never attempt to adjust the edger wheel when the unit is in operation. Always stop the powerhead, wait until the blade stops turning, and disconnect the spark plug (or disconnect powerhead from power source) before making adjustments.

EDGING

As you become familiar with use of your edger attachment, you will be able to determine your own operating pace. Conditions such as depth of cut and material being cut will regulate the speed and time required for your edging job.

- Allow the engine to warm up before you begin edging.

- Increase the engine speed before placing the blade in the cut. For best results, run the engine at full throttle while cutting.
- Always work going away from people and solid objects such as walls, large stones, trees, automobiles, etc.
- Be careful when edging near trees or valuable plants. The high speed metal blade may cut roots and cause damage to the plants.
- If the blade stalls, immediately move the unit back slightly to allow the blade to restart. If the blade continues to stall, stop the engine, disconnect the spark plug, and inspect for blockage or damage.

WARNING: Keep the blade area clean. Always release the throttle trigger, move the powerhead ON/OFF switch to the OFF position, disconnect the spark plug (or disconnect powerhead from power source), and make sure the blade has completely stopped turning before cleaning.

SETTING THE EDGING DEPTH

WARNING: Never attempt to adjust the cut depth when the engine is running. Always release the throttle trigger, wait until the blade stops turning, move the powerhead ON/OFF switch to the OFF position, and disconnect spark plug (or disconnect from power source) before making adjustments.

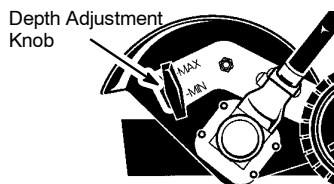

1. Loosen the depth adjustment knob.
2. Slide the wheel to the desired position.
 - Raising the wheel will increase the cutting depth.
 - Lowering the wheel will decrease the cutting depth.
3. Tighten the depth adjustment knob securely.

MAINTENANCE

⚠ WARNING: Always stop unit and disconnect spark plug wire (or disconnect powerhead from power source) before performing maintenance.

CHECK FOR DAMAGED OR WORN PARTS

Contact an authorized service dealer for replacement of damaged or worn parts.

- Blade Shield - Discontinue use of edger if blade shield is damaged.

CHECK FOR LOOSE FASTENERS AND PARTS

- Blade nut
- Fasteners

INSPECT AND CLEAN UNIT AND DECALS

- After each use, inspect complete unit for loose or damaged parts. Clean the unit and decals using a damp cloth with a mild detergent.
- Wipe off unit with a clean dry cloth.

BLADE MAINTENANCE

⚠ WARNING: The blade will continue to spin after the engine stops or after the throttle trigger has been released. To avoid serious injury, make sure the blade has stopped coasting and disconnect the spark plug (or disconnect powerhead from power source) before performing work on the blade.

⚠ WARNING: Always replace a blade that is bent, warped, cracked, broken, or damaged in any other way. Never attempt to straighten and reuse a damaged blade. Use only specified replacement blade. Wear protective gloves when handling or performing maintenance on the blade to help avoid injury.

- The blade is reversible. When the cutting edge on one side becomes worn, turn the blade over (see BLADE REPLACEMENT in the SERVICE AND ADJUSTMENTS section).
- Check blade for flatness periodically. Lay the blade on a flat surface to inspect for flatness. Throw away a blade that is not flat.

SERVICE AND ADJUSTMENTS

BLADE REPLACEMENT

⚠ WARNING: The blade will continue to spin after the engine stops or after the throttle trigger has been released. To avoid serious injury, make sure the blade has stopped coasting and disconnect the spark plug (or disconnect powerhead from power source) before performing work on the blade.

⚠ WARNING: Wear protective gloves when handling or performing maintenance on the blade to avoid injury. The blade is sharp and can cut you even when it is not moving.

1. To remove the blade, align hole in the dust cup with the hole in the side of the gearbox by rotating the blade.
2. Insert a small screwdriver into aligned holes. This will keep the shaft from turning while loosening the blade nut.

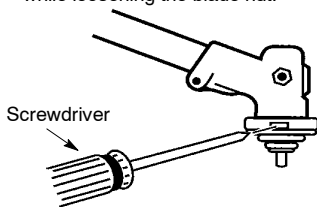

3. While holding the screwdriver in position, remove blade nut by turning clockwise.
4. Remove both washers, and the blade from the blade shaft.

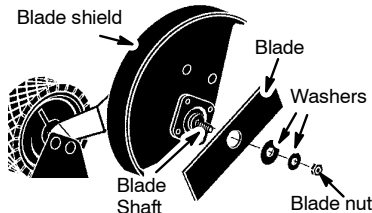

5. Install new blade onto blade shaft.
6. Reinstall both washers and blade nut (counterclockwise).
7. Tighten blade nut firmly with a wrench while holding screwdriver in position.
8. Remove the screwdriver.
9. Turn blade by hand. If the blade binds against the shield, or appears to be uneven, the blade is not centered, and you must reinstall.

STORAGE

⚠ WARNING: Perform the following steps after each use:

- Allow attachment and gearbox to cool before storing or transporting.
- Store attachment with blade shield in place. Position attachment so that any sharp object cannot accidentally cause injury.
- Store the attachment in a dry, well ventilated area out of the reach of children.

SEASONAL STORAGE

Prepare attachment for storage at end of season or if it will not be used for 30 days or more. If your edger attachment is to be stored for a period of time:

- Clean the entire attachment.
- Inspect the blade shield area and clean any dirt, grass, leaves, or debris that has collected. Inspect the blade and blade shield; replace a blade that is bent, warped, cracked, broken or damaged in any other way.

- Lightly oil external metal surfaces.
- Apply a coating of oil to the entire surface of the blade; wrap it in heavy paper or cloth.
- Check entire attachment for loose screws or nuts. Replace any damaged, worn or broken parts.
- At the beginning of the next season, use only fresh fuel having the proper gasoline to oil ratio.

LIMITED WARRANTY

ELECTROLUX HOME PRODUCTS, INC., warrants to the original purchaser that each new **Poulan PRO®** brand gasoline tool or attachment is free from defects in material and workmanship and agrees to repair or replace under this warranty any defective gasoline product or attachment as follows from the original date of purchase.

2 YEARS- Parts and Labor, when used for household purposes.

90 DAYS - Parts and Labor, when used for commercial, professional, or income producing purposes.

30 DAYS - Parts and Labor, if used for rental purposes.

This warranty is not transferable and does not cover damage or liability caused by improper handling, improper maintenance, or the use of accessories and/or attachments not specifically recommended by **ELECTROLUX HOME PRODUCTS, INC.**, for this tool. Additionally, this warranty does not cover tune-ups, spark plugs, filters, cutting line, or rotating head parts that will wear and require replacement with reasonable use during the warranty period. This warranty does not cover pre-delivery setup or normal adjustments explained in the instruction manual.

THIS WARRANTY GIVES YOU SPECIFIC LEGAL RIGHTS, AND YOU MAY HAVE OTHER RIGHTS WHICH VARY FROM STATE TO STATE. NO CLAIMS FOR CONSEQUENTIAL OR OTHER DAMAGES WILL BE ALLOWED, AND THERE ARE NO OTHER EXPRESS WARRANTIES EXCEPT THOSE EXPRESSLY STIPULATED HEREIN.

SOME STATES DO NOT ALLOW LIMITATIONS ON HOW LONG AN IMPLIED WARRANTY LASTS OR THE EXCLUSION OR LIMITATIONS OF INCIDENTAL OR CONSEQUENTIAL DAMAGES, SO THE ABOVE LIMITATIONS OR EXCLUSION MAY NOT APPLY TO YOU.

The policy of **ELECTROLUX HOME PRODUCTS, INC.**, is to continuously improve its products. Therefore, **ELECTROLUX HOME PRODUCTS, INC.**, reserves the right to change, modify, or discontinue models, designs, specifications, and accessories of all products at any time without notice or obligation to any purchaser.

Free Manuals Download Website

<http://myh66.com>

<http://usermanuals.us>

<http://www.somanuals.com>

<http://www.4manuals.cc>

<http://www.manual-lib.com>

<http://www.404manual.com>

<http://www.luxmanual.com>

<http://aubethermostatmanual.com>

Golf course search by state

<http://golfingnear.com>

Email search by domain

<http://emailbydomain.com>

Auto manuals search

<http://auto.somanuals.com>

TV manuals search

<http://tv.somanuals.com>