

# WEED EATER

® Trademark

ENGLISH



**Please do not return unit to retailer.  
Por favor, no devuelva el aparato al lugar de compra.  
Veuillez ne pas retourner l'outil au détaillant.**

**1-800-554-6723**

**www.weedeater.com**

## Instruction Manual Manual de Instrucciones Manuel d'Instructions



**MINI TRIM AUTO**

ESPAÑOL



**WARNING:**

Read and follow all Safety Rules and Operating Instructions before using this product. Read instructions carefully before assembling. Failure to do so can result in serious injury.

**ADVERTENCIA:**

Lea el manual del operador y siga todas las advertencias e instrucciones de seguridad. Antes de ensamblar el producto lea cuidadosamente el instructivo. El no hacerlo puede resultar en lesiones graves.

**AVERTISSEMENT:**

Veuillez lire le manuel de l'utilisateur et bien respecter tous les avertissements et toutes les instructions de sécurité. Bien lire les instructions avant d'assembler l'outil. Tout défaut de le faire pourrait entraîner des blessures graves.

WEED EATER  
1030 Stevens Creek Road  
Augusta, GA 30907

WEED EATER  
850 Matheson Blvd. West  
Mississauga, Ontario L5V 0B4

FRANÇAIS

**545186764 Rev. 2 3/4/09 BRW**

# IDENTIFICATION OF SAFETY SYMBOLS

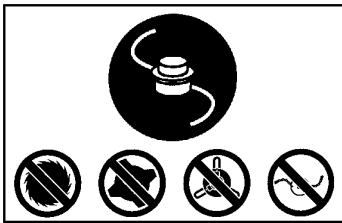

**⚠ DANGER:** Use only specified trimmer head, spool, and 0.065 inch (1.65 mm) recommended trimmer line. Never use blades, flailing devices, wire, rope, string, etc. Unit is designed for line trimmer use only. Failure to follow these instructions may result in serious injury.



**⚠ WARNING:** This unit can be dangerous! Careless or improper use can cause serious injury.

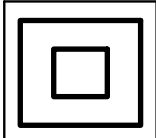

**⚠ WARNING:** This unit is double insulated. Failure to have the unit repaired by qualified service personnel can cause the double insulation construction to become ineffective and result in serious injury.



Read the operator's manual before use. Failure to follow instructions could result in serious injury. Save operator's manual.



To reduce the risk of electric shock, do not expose unit to water. Do not operate unit on wet ground or in rain.



Trimmer line can throw objects violently. You can be blinded or injured. Always wear hearing protection and safety glasses marked Z87. Always wear heavy, long pants, long sleeves, boots and gloves.

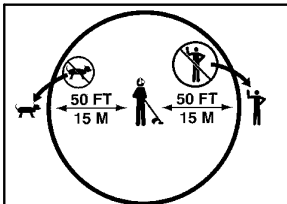

Hazard zone for thrown objects.

- Trimmer line throws objects violently.
- You and others can be blinded/injured.
- Keep children, bystanders, and animals 50 feet (15 meters) away.



Secure hair above shoulder length. Do not wear jewelry, loose clothing, or clothing with loosely hanging straps, ties, tassels, etc. They can be caught in moving parts.

## IDENTIFICATION OF SAFETY SYMBOLS



This unit is double insulated. All internal service must be completed by an authorized service dealer. Disconnect unit from power source before cleaning or servicing.

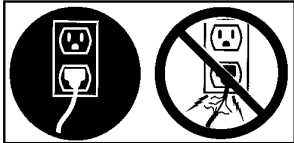

Do not use with damaged cord. Repair or replace damaged cord immediately.

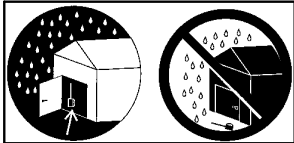

Store unit indoors in a high, dry place out of the reach of children. Store unit unplugged.



This unit is for household use only and not for commercial use.



When servicing unit, use only identical replacement parts.

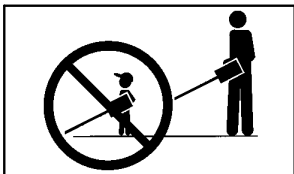

Never allow children to operate this unit.

## SAFETY RULES

**WARNING:** When using electric gardening appliances, basic safety precautions must always be followed to reduce the risk of fire, electric shock, and serious injury. Read and follow all instructions.



SAFETY INFORMATION  
ON THE UNIT

*This power unit can be dangerous!* Operator is responsible for following the warnings and instructions in this manual and on the unit. Read entire instruction manual before using unit! Be thoroughly familiar with the controls

and the proper use of the unit. Restrict the use of this unit to persons who read, understand, and follow unit and manual warnings and instructions. Never allow children to operate this unit. Close attention is necessary when used near children.

**DANGER:** Never use blades or flailing devices. Unit is designed for line trimmer use only. Use of any other accessories or attachments will increase the risk of injury.



**⚠ WARNING:** Trimmer line throws objects violently. You and others can be blinded/injured. Wear safety glasses, boots, and leg protection. Keep body parts clear of rotating line. Keep children, bystanders, and animals 50 feet (15 meters) away. If approached stop unit immediately.

If situations occur which are not covered in this manual, use care and good judgement. If you need assistance, call 1-800-554-6723.

### OPERATOR SAFETY

- Dress properly. Always wear safety glasses or similar eye protection when operating, or performing maintenance on your unit. (Safety glasses are available.) Always wear face or dust mask if operation is dusty. Always wear heavy, long pants, long sleeves, boots, and gloves. Do not go barefoot or wear sandals.
- Secure hair above shoulder length. Secure or remove loose clothing and jewelry or clothing with loosely hanging ties, straps, tassels, etc. They can be caught in moving parts.
- Being fully covered also helps protect you from debris and pieces of toxic plants thrown by spinning line.
- Stay Alert. Do not operate unit when you are tired, ill, upset or under influence of alcohol, drugs, or medication. Watch what you are doing; use common sense.
- Avoid unintentional starting of the unit. Never carry unit with your finger on the switch. Be sure the switch is in the OFF position and never touch the switch when connecting extension cord.

### ELECTRICAL SAFETY

**⚠ WARNING:** Avoid a dangerous environment. To reduce the risk of electrical shock, do not use in rain, in damp or wet locations, or around swimming pools, hot tubs, etc. Do not expose to snow, rain, or water to avoid the possibility of electrical shock.

- Use a voltage supply as shown on unit.
- Avoid dangerous situations. Do not use in the presence of flammable liquids or gases to avoid creating a fire or explosion and/or causing damage to unit.
- To reduce the risk of electrical shock, this equipment has a polarized plug (one blade is wider than the other) and will require the use of a polarized extension cord. The appliance plug will fit into a polarized extension cord only one way. If the plug does not fit fully into the extension cord, reverse the plug. If the plug still does not fit, obtain a correct polarized extension cord. A polarized extension cord will require the use of a polarized wall outlet. This plug will fit into the polarized wall outlet only one way. If plug does not fit fully into the wall outlet, reverse the plug. If it still does not fit, contact a qualified electrician to install the proper wall outlet. Do not change the equipment plug, extension cord receptacle, or extension cord plug in any way.

- To reduce risk of electrical shock, use extension cords specifically marked as suitable for outdoor appliances having electrical rating not less than the rating of unit. Cord must be marked with suffix "W-A" (in Canada "W"). Make sure your extension cord is in good condition. Inspect extension cord before use and replace if damaged. Do not use a damaged cord. Cord insulation must be intact with no cracks or deterioration. Plug connectors must be undamaged. An undersized extension cord will cause a drop in line voltage resulting in loss of power and overheating. If in doubt, use the next heavier gauge. The lower the gauge number, the heavier the cord (see SELECT AN EXTENSION CORD in the OPERATION section).
- Do not use multiple cords.
- Do not abuse cord. Never carry the unit by the extension cord or yank extension cord to disconnect unit.
- Use cord retainer to prevent disconnection of extension cord from unit and possible damage to the unit due to plug movement (see ATTACH THE EXTENSION CORD TO YOUR TRIMMER in the OPERATION section).
- Do not use the unit if the switch does not turn the unit on and off properly. Repairs to the switch must be made by your authorized service dealer.
- Keep the extension cord clear of operator and obstacles at all times. Do not expose cords to heat, oil, water, or sharp edges.
- To avoid the possibility of electric shock, avoid body contact with any grounded conductor, such as metal fences or pipes.
- Ground Fault Circuit Interrupter (GFCI) protection should be provided on circuit or outlet to be used. Receptacles are available having built-in GFCI protection and may be used for this measure of safety.

### UNIT SAFETY

- Inspect unit before use. Replace damaged parts. Make sure all handles, guards, and fasteners are in place and securely fastened. Parts that are damaged must be repaired or replaced by an authorized service dealer. These include head parts that are cracked, or chipped, guards, and any other part that is damaged.
- Do not repair unit yourself.
- Use only 0.065 inch (1.65 mm) diameter recommended trimmer line (see USER REPLACEABLE SERVICE PARTS in the SERVICE AND ADJUSTMENTS section). Never use wire, rope, string, etc.
- Use specified trimmer spool. Make sure spool is properly installed and all parts are securely fastened.
- Use only WEED EATER replacement parts and accessories as recommended.

### CUTTING SAFETY

**⚠ WARNING:** Inspect area to be cut. Remove objects (rocks, broken glass, nails, wire, string, etc.) which can be thrown or become entangled in cutting head.

- Do not overreach or stand on unstable support. Keep firm footing and balance.
- Keep the cutting head below waist level. Do not raise handles above your waist. Cutting head can come dangerously close to your body.
- Keep away from cutting head and spinning line.
- Use unit properly. Use only for trimming, scalping, and mowing. Do not force unit. It will do the job better and with less risk of injury at the rate for which it was designed.
- Use only in daylight or in good artificial light.

#### MAINTENANCE SAFETY

**⚠ WARNING:** Disconnect unit from the power supply before performing maintenance, or when changing trimmer line.

- Maintain unit according to recommended procedures. Keep cutting line at proper length. Follow instructions for changing trimmer line.
- Have all service and maintenance not explained in this manual performed by an authorized service dealer to avoid creating a hazard.
- Never douse or squirt the unit with water or any other liquid. Clean unit and labels with a damp sponge. Keep handles dry, clean, and free from oil and grease.
- Keep the air vents clean and free of debris to avoid overheating the motor. Clean after each use.

#### TRANSPORTING AND STORAGE

- Stop the unit and disconnect the power source when not in use.
- Carry the unit with motor stopped.
- Store the unit so the line limiter blade (on underside of shield) cannot cause injury.

- Store unit indoors in a high, dry place out of the reach of children. Store unit unplugged.
- Do not hang unit so that the trigger switch is depressed.

#### DOUBLE INSULATION CONSTRUCTION

This unit is double insulated to help protect against electric shock. Double insulation construction consists of two separate "layers" of electrical insulation instead of grounding.

Tools built with this insulation system are not intended to be grounded. No grounding means is provided on this unit, nor should a means of grounding be added to this unit. As a result, the extension cord used with your unit can be plugged into any standard 120 volt electrical outlet.

Safety precautions must be observed when operating any electrical tool. The double insulation system only provides added protection against injury resulting from an internal electrical insulation failure.

**⚠ WARNING:** All electrical repairs to this unit, including housing, switch, motor, wires, etc., must be diagnosed and repaired by qualified service personnel. Replacement parts for a double insulated appliance must be recommended by the manufacturer. A double insulated appliance is marked with the words "double insulation" or "double insulated". The symbol (square within a square)  may also be marked on the appliance. Failure to have the unit repaired by qualified service personnel can cause the double insulation construction to become ineffective and result in serious injury.

#### SAVE THESE INSTRUCTIONS

## ASSEMBLY

**⚠ WARNING:** If received assembled, review all assembly steps to ensure your unit is properly assembled and all fasteners are secure.

#### SHAFT ASSEMBLY

1. Align the upper shaft and lower shaft.
2. Push shafts together until they snap into place.

**NOTE:** When the unit is assembled correctly, there should not be a gap between the two shafts.

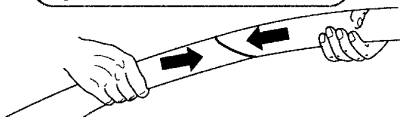
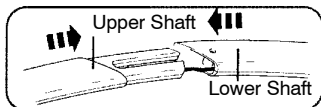

#### ATTACHING THE SHIELD

**⚠ WARNING:** The shield must be properly installed. The shield provides partial protection from the risk of thrown objects to the operator and others. Your unit is equipped with a line limiter blade, which cuts excess line to the proper length while running. The line limiter blade (on underside of shield) is sharp and can cut you.

**NOTE:** If shield is not properly installed, damage to unit (including motor failure) will result.

1. Place the shield onto the motor housing. Ensure the cutting head remains free to rotate and the line is not caught between the shield and the motor housing (see illustration).

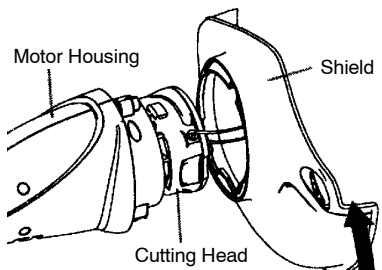

2. Twist the shield as illustrated until it snaps securely into place. Make sure the shield is assembled to the unit as shown in the illustration below and in the **KNOW YOUR TRIMMER** section of this manual.

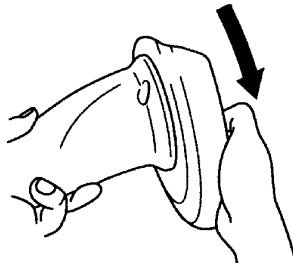

**CAUTION:** Sharp line limiter blade

## OPERATION

### KNOW YOUR TRIMMER

READ THIS INSTRUCTION MANUAL AND SAFETY RULES BEFORE OPERATING YOUR UNIT. Compare the illustrations with your unit to familiarize yourself with the location of the various controls and adjustments. Save this manual for future reference.

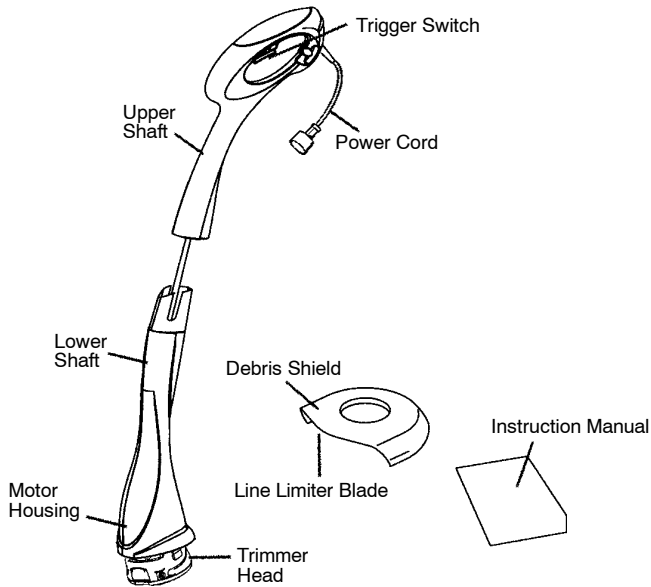

### POWER CORD

The **POWER CORD** is where you attach your extension cord to the unit.

### TRIGGER SWITCH

The **TRIGGER SWITCH** is used to turn on the unit. Squeeze the trigger switch to operate the unit. Release to stop.

### LINE LIMITER BLADE

The **LINE LIMITER BLADE** cuts the cutting line to the proper cutting length.

### TRIMMER HEAD

The **TRIMMER HEAD** holds cutting line and rotates during operation.

## OPERATING INSTRUCTIONS

Use only a voltage supply as specified on your unit.

### SELECT AN EXTENSION CORD

Extension Cord Gauge Chart	
Length of Cord	Gauge
25 Ft. (7.5 m)	18 Gauge
50 Ft. (15 m)	16 Gauge
100 Ft. (30 m)	16 Gauge

Extension cords are available for this unit.

### ATTACH THE EXTENSION CORD TO YOUR TRIMMER

1. Form a loop in your extension cord.
2. Push the loop through the slot in the handle (see illustration).

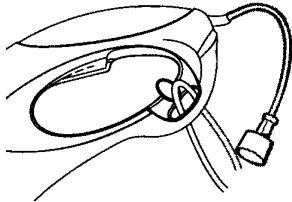

3. Position the loop over the cord retainer and pull back to secure.
4. Connect power cord of unit to extension cord.

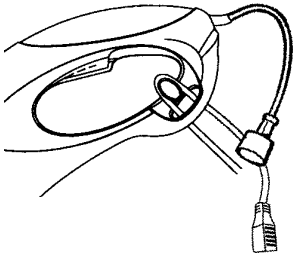

### CORRECT OPERATING POSITION



Trimming

**⚠ WARNING:** Always wear eye protection. Never lean over the trimmer head. Rocks or debris can ricochet or be thrown into eyes and face and cause blindness or other serious injury.

When operating unit, stand as shown and check for the following:

- Wear eye protection and heavy clothing.
- Hold trigger handle; squeeze trigger to start unit.
- Keep unit below waist level.
- Hold trimmer with one hand. The trimmer will hang naturally in the correct cutting position.
- Cut only from your right to your left to ensure debris is thrown away from you. Without bending over, keep line near and parallel to the ground and not crowded into material being cut.

### AUTOMATIC LINE FEED SYSTEM

When the trimmer is initially started, a small length of cutting line is fed out.

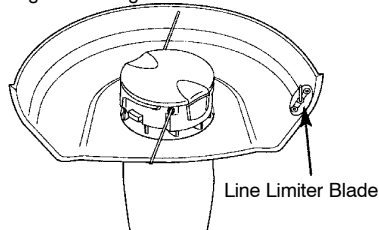

After approximately 5 seconds, the line will be cut to the correct length by the line limiter blade as the motor reaches full speed. **Make sure the motor is up to full speed before trimming.** If the noise of the cutting line being cut cannot be heard, more line will need to be fed out.

#### To feed more line:

- Allow the motor to stop completely; then, restart the motor and allow it to reach full speed.
- Repeat until you hear the line hitting against the line limiter blade (do not repeat this procedure more than 6 times).

If problems are experienced with the automatic line feed, refer to the TROUBLESHOOTING TABLE.

#### To manually feed the nylon line:

- If required, the cutting line can be fed out manually.
- To operate, press and release manual line feed button while gently pulling on one of the lines until the line reaches the line limiter blade.

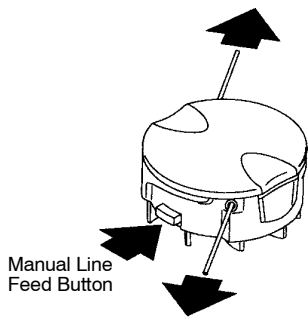

- When the required amount of line is fed out, gently pull on the second line (there is no need to press the manual line feed button again).
- If the line extends past the line limiter blade, too much line has been fed out. If too much line is fed out, remove the spool cap and click spool counterclockwise until the line is at the desired length.

#### To remove spool cap:

1. Press and hold in the two cap release latches.
2. Pull cap away from the hub.

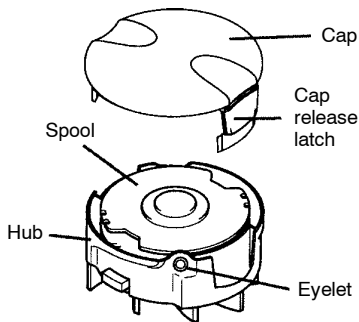

#### To reinstall spool cap:

1. Keep all areas of the cap and hub clean. Failure to do so may prevent the cap being securely located in the hub.
2. Replace the cap, pressing firmly down towards the hub to ensure cap is fully secured.
3. Check that the cap is secure by trying to remove it without pressing the two latches.

**WARNING:** Use only 0.065 inch (1.65 mm) diameter line. Other sizes of line will not advance properly and will result in improper cutting head function or can cause serious injury. Do not use other materials such as wire, string, rope, etc. Wire can break off during cutting and become a dangerous missile that can cause serious injury. See page 3 for warning concerning other cutting devices.

#### TRIMMING

Hold the bottom of the trimmer head about 3 inches (8 cm) above the ground and at an angle. Allow only the tip of the line to make contact. Do not force trimmer line into work area.

##### Trimming

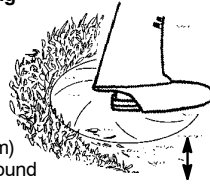

#### SCALPING

The scalping technique removes unwanted vegetation down to the ground. Hold the bottom of the trimmer head about 3 inches (8 cm) above the ground and at an angle. Allow the tip of the line to strike the ground around trees, posts, monuments, etc. This technique increases line wear.

##### Scalping

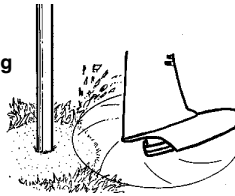

#### MOWING

Your trimmer is ideal for mowing in places conventional lawn mowers cannot reach. In the mowing position, keep the line parallel to the ground. Avoid pressing the head into the ground as this can scalp the ground and damage the tool.

##### Mowing

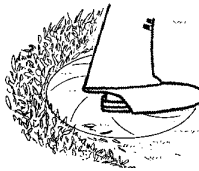

#### SWEEPING

The fanning action of the rotating line can be used for a quick and easy clean up. Keep the line parallel to and above the surfaces being swept and move the tool from side to side.

##### Sweeping

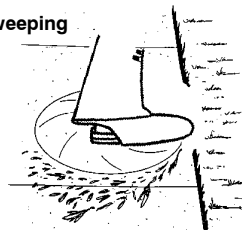



## MAINTENANCE

**WARNING:** Disconnect unit from power source before performing maintenance.

### GENERAL RECOMMENDATIONS

The warranty on this unit does not cover items that have been subjected to operator abuse or negligence. To receive full value from the warranty, the operator must maintain unit as instructed in this manual. Various adjustments will need to be made periodically to properly maintain your unit.

### BEFORE EACH USE

#### CHECK FOR LOOSE FASTENERS AND PARTS

- Housing Screws
- Debris Shield

#### CHECK FOR DAMAGED OR WORN PARTS

Contact an authorized service dealer for replacement of damaged or worn parts.

- Trigger Switch - Ensure switch functions properly by pressing and releasing the trigger switch. Make sure motor stops.
- Debris Shield - Discontinue use of unit if debris shield is damaged.

### AFTER EACH USE INSPECT AND CLEAN UNIT AND LABELS

- After each use, inspect complete unit for loose or damaged parts. Never use a damaged trimmer.
- Clean the unit using a damp cloth with a mild detergent.
- Wipe off unit with a clean dry cloth.
- Use a soft brush to clean around the inside of the debris shield, the cutting head and the motor housing air vents.

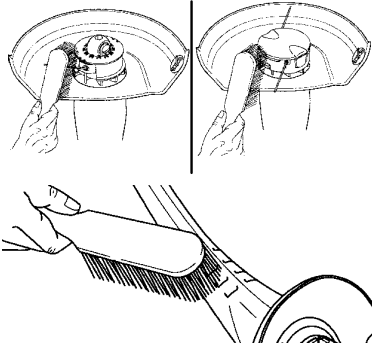

## SERVICE AND ADJUSTMENTS

**WARNING:** Disconnect unit from power source before servicing.

### REPLACING THE LINE

1. Press and hold in the two cap release latches.
2. Pull cap away from the hub.

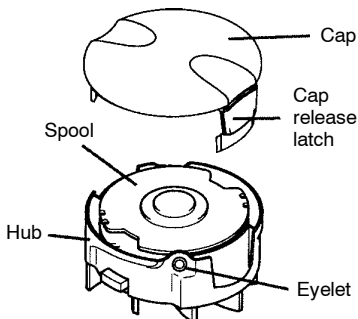

3. Remove old spool.
4. Clean entire surface of hub and spool.
5. Replace with a pre-wound spool or cut two lengths of 13 feet (4 meters) of 0.065" (1.65 mm) diameter WEED EATER brand line. Use of heavier lines could overload and damage unit.

**WARNING:** Never use wire, rope, string, etc., which can break off and become a dangerous missile.

6. Insert one end of the line about 1/2 inch (1 cm) into one of the small holes in the upper section of the inside of the spool.

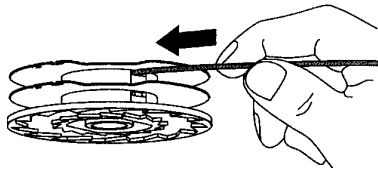

7. Wind the line evenly and tightly onto the spool. Wind in the direction of the arrow found on the spool.
8. Push the line into the notch, leaving 3 to 5 inches (7 - 12 cm) unwound.
9. Repeat on the lower section of the spool.

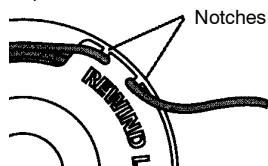

10. Place spool into hub with cut out area of spool in line with eyelets (see illustration).

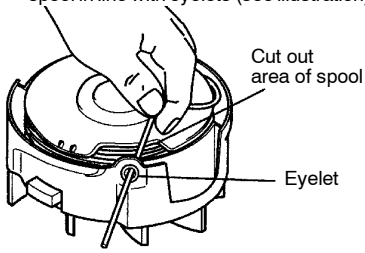

11. Remove one line from notch and feed line through eyelet. Repeat for second line.

12. Reinstall the spool cap.

#### USER REPLACEABLE SERVICE PARTS

REPLACEMENT PART	PART NUMBER
Spool with 0.065" Trimmer Line	545124402
Spool Cap	545124417

## STORAGE

**WARNING:** Perform the following steps after each use.

- Stop the unit and disconnect the power source when not in use.
- Carry the unit with motor stopped.
- Store the unit so the line limiter blade cannot cause injury.

- Store unit and extension cord indoors in a high, dry place out of the reach of children. Store unit unplugged.
- Store unit with all guards in place. Position unit so that any sharp object cannot accidentally cause injury.

## TROUBLESHOOTING TABLE

**⚠ WARNING:** Always stop unit and disconnect from the power source before performing all of the recommended remedies below except remedies that require unit to be operating.

TROUBLE	CAUSE	REMEDY
Trimmer head stops under a load or does not turn when switch is pressed.	<ol style="list-style-type: none"> <li>1. Crowding trimmer line against material being cut.</li> <li>2. Electrical failure.</li> <li>3. Thrown circuit breaker.</li> <li>4. Debris stopping head.</li> </ol>	<ol style="list-style-type: none"> <li>1. Allow tip of line to do the cutting.</li> <li>2. Contact your authorized service dealer.</li> <li>3. Check Breaker Box.</li> <li>4. Remove debris.</li> </ol>
Line does not advance, line is too short, or trimmer vibrates.	<ol style="list-style-type: none"> <li>1. Line improperly routed in head.</li> <li>2. Line improperly wound into spool.</li> <li>3. Incorrect line size</li> <li>4. Not enough line outside of head.</li> <li>5. Automatic line feed not working.</li> <li>6. Dirt buildup on unit.</li> </ol>	<ol style="list-style-type: none"> <li>1. Check line routing.</li> <li>2. Rewind line tightly and evenly.</li> <li>3. Use only 0.065 in. (1.65 mm) dia. line.</li> <li>4. Remove spool cap and spool. Manually feed line. Reinstall cap and spool. See Automatic Line Feed System section.</li> <li>5. Rewind line tightly and evenly. Check that line is in correct section of spool.</li> <li>6. Clean unit.</li> </ol>
Excessive noise when unit is running.	<ol style="list-style-type: none"> <li>1. Motor has not reached full speed before use.</li> <li>2. Too much line has been released from the spool.</li> <li>3. Line limiter blade missing from shield.</li> </ol>	<ol style="list-style-type: none"> <li>1. Allow the motor to reach full speed before use.</li> <li>2. Rewind line tightly and evenly. See Automatic Line Feed System section.</li> <li>3. Contact your authorized service dealer.</li> </ol>
Line releases continuously.	<ol style="list-style-type: none"> <li>1. Line improperly routed in head.</li> <li>2. Spool damaged.</li> </ol>	<ol style="list-style-type: none"> <li>1. Check line routing.</li> <li>2. Replace spool.</li> </ol>
Line usage is excessive.	<ol style="list-style-type: none"> <li>1. Line improperly routed in head.</li> <li>2. Line size is incorrect.</li> <li>3. Crowding line against material being cut.</li> <li>4. Spool worn or damaged.</li> </ol>	<ol style="list-style-type: none"> <li>1. Check line routing.</li> <li>2. Replace spool.</li> <li>3. Cut with tip of line fully extended.</li> <li>4. Replace spool.</li> </ol>

## LIMITED WARRANTY

**WEED EATER**, a division of Husqvarna Consumer Outdoor Products N.A., Inc., warrants to the original consumer purchaser that each new **WEED EATER** brand electric or cordless product is free from defects in material and workmanship and agrees to repair or replace under this warranty any defective **WEED EATER** brand electric or cordless product within two (2) years from the original date of purchase.

If your **WEED EATER** brand electric or cordless product should fail within the limited warranty period, you may return it in complete condition, prepaid, with proof of purchase, to the dealer from whom it was purchased for repair or replacement at the option of **WEED EATER**.

This warranty is not transferable and does not cover damage or liability caused by improper handling, improper maintenance or alteration, or the use of accessories and/or attachments not specifically recommended by **WEED EATER** for this product. Additionally, this warranty does not cover parts that will wear and require replacement with reasonable use during the warranty period. This warranty does not cover pre-delivery set-up or normal adjustments explained in the instruction manual.

Should you have any unanswered questions concerning this warranty, please contact:

**WEED EATER**, a division of Husqvarna Consumer Outdoor Products N.A., Inc.  
1030 Stevens Creek Road  
Augusta, GA 30907  
1-800-554-6723

In Canada, contact:

**WEED EATER**  
850 Matheson Blvd. West  
Mississauga, Ontario L5V 0B4

Giving the model number, serial number and date of purchase of your product and the name and address of the authorized dealer from whom it was purchased.

THIS WARRANTY GIVES YOU SPECIFIC LEGAL RIGHTS, AND YOU MAY HAVE OTHER RIGHTS WHICH VARY FROM STATE TO STATE.

NO CLAIMS FOR CONSEQUENTIAL OR OTHER DAMAGES WILL BE ALLOWED, AND THERE ARE NO OTHER EXPRESS WARRANTIES EXCEPT THOSE EXPRESSLY STIPULATED HEREIN.

SOME STATES DO NOT ALLOW LIMITATIONS ON HOW LONG AN IMPLIED WARRANTY LASTS OR THE EXCLUSION OR LIMITATIONS OF INCIDENTAL OR CONSEQUENTIAL DAMAGES, SO THE ABOVE LIMITATIONS OR EXCLUSION MAY NOT APPLY TO YOU.

This is a limited warranty within the meaning of that term as defined in the Magnuson-Moss Act of 1975.

The policy of **WEED EATER** is to continuously improve its products. Therefore, **WEED EATER** reserves the right to change, modify, or discontinue models, designs, specifications, and accessories of all products at any time without notice or obligation to any purchaser.

## Free Manuals Download Website

<http://myh66.com>

<http://usermanuals.us>

<http://www.somanuals.com>

<http://www.4manuals.cc>

<http://www.manual-lib.com>

<http://www.404manual.com>

<http://www.luxmanual.com>

<http://aubethermostatmanual.com>

Golf course search by state

<http://golfingnear.com>

Email search by domain

<http://emailbydomain.com>

Auto manuals search

<http://auto.somanuals.com>

TV manuals search

<http://tv.somanuals.com>