

Poulan PRO

ENGLISH



Please do not return unit to retailer.
Por favor, no devuelva el aparato al lugar de compra.
Veuillez ne pas retourner l'outil au détaillant.

1-800-554-6723

www.poulan.com

Operator's Manual Manual del Operador Manuel de l'utilisateur

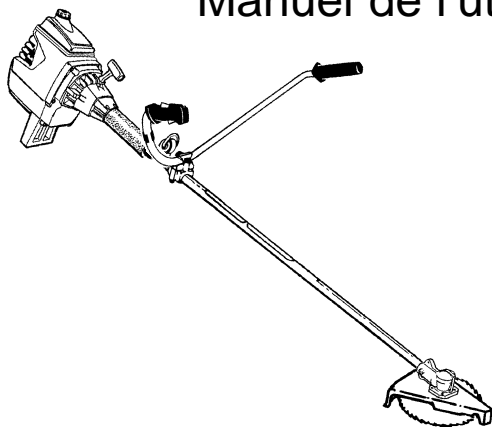

PP196

ESPAÑOL



DANGER:

Read and follow all Safety Rules and Operating Instructions before using this product. Failure to do so can result in serious injury.

ADVERTENCIA:

Lea el manual del operador y siga todas las advertencias e instrucciones de seguridad. El no hacerlo puede resultar en lesiones graves.

AVERTISSEMENT:

Lire le manuel de l'utilisateur et bien respecter tous les avertissements et toutes les instructions de sécurité. Tout défaut de le faire pourrait entraîner des blessures graves.

FRANÇAIS

Frigidaire Home Products, Augusta, GA 30907
WCI Outdoor Products, Inc.

530085855 3/28/00

SAFETY RULES

⚠ DANGER: This power tool can be dangerous! This unit can cause serious injury including amputation or blindness to the operator and others. The warnings and safety instructions in this manual must be followed to provide reasonable safety and efficiency in using the unit. The operator is responsible for following the warnings and instructions in this manual and on the unit. Read the entire Operator's Manual before assembling and using the unit! Restrict the use of this unit to persons who read, understand, and follow the warnings and instructions in this manual and on the unit. Never allow children to use this unit.



⚠ WARNING: Follow all warnings and instructions. Failure to do so can result in serious injury.



⚠ DANGER: Blade can thrust violently away from material it does not cut. Blade thrust can cause amputation of arms or legs. Keep people and animals 50 feet (15 meters) away.

ALWAYS WEAR:

Eye Protection

Leg Guards

Boots

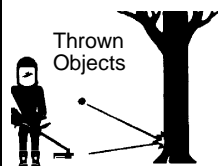

⚠ WARNING: Trimmer line can throw objects violently. You can be blinded or injured. Wear eye and leg protection.

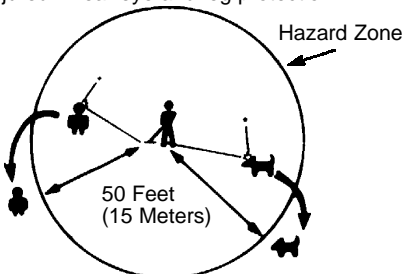

⚠ WARNING: Hazard zone for thrown objects. Blade/Trimmer line can throw objects

violently. Others can be blinded or injured. Keep people and animals 50 feet (15 meters) away.



⚠ WARNING: Do not use trimmer head as a fastening device for the blade.

Stop coasting blade by contact with cut material.



⚠ WARNING: The blade continues to spin after the throttle is released or, engine is turned off. The coasting blade can throw objects or seriously cut you if accidentally touched. Stop the blade by contacting the left hand side of the coasting blade with material already cut.

OPERATOR SAFETY

- Dress properly. Always wear safety glasses or similar eye protection when operating, or performing maintenance on your unit. (Safety glasses are available.) Always wear face or dust mask if operation is dusty. Always wear heavy, long pants, long sleeves, boots, and gloves. Do not go barefoot or wear sandals.
- Secure hair above shoulder length. Secure or remove loose clothing and jewelry or clothing with loosely hanging ties, straps, tassels, etc. They can be caught in moving parts.
- Being fully covered also helps protect you from debris and pieces of toxic plants thrown by spinning line.
- Stay Alert. Do not operate unit when you are tired, ill, or under influence of alcohol, drugs, or medication. Watch what you are doing; use common sense.
- Wear hearing protection if you use the unit for more than 1-1/2 hours per day.
- Never start or run the engine inside a closed room or building. Breathing exhaust fumes can kill.
- Keep handles free of oil and fuel.
- Always use the handlebar and a properly adjusted shoulder strap with a blade. See ASSEMBLY.

UNIT/MAINTENANCE SAFETY

- Look for and replace damaged or loose parts before each use. Look for and repair fuel leaks before use. Keep unit in good working condition.
- Throw away blades that are bent, warped, cracked, broken, or damaged in any other way. Replace trimmer head parts that are cracked, chipped, broken, or damaged in any other way before using the unit.

- Maintain unit according to recommended procedures. Keep blade sharp. Keep cutting line at the proper length.
- Use only .080" (2 mm) diameter line. Never use wire, rope, string, etc.
- Install required shield properly before using the unit. Use the metal shield for all metal blade use. Use the plastic shield for all line trimmer use.
- Use only specified blade or trimmer head; make sure it is properly installed and securely fastened.
- Never start engine with clutch shroud removed. The clutch can fly off and cause serious injury.
- Be sure blade or trimmer head stops turning when engine idles.
- Disconnect the spark plug before performing maintenance (except carburetor adjustments).
- Make carburetor adjustments with the lower end supported to prevent blade or trimmer line from contacting any object. Hold unit by hand; do not use the shoulder strap for support.
- Keep others away when making carburetor adjustments.
- Use only recommended POULAN PRO accessories and replacement parts.
- Have all maintenance and service not explained in this manual performed by your Authorized Service Dealer.

FUEL SAFETY

- Mix and pour fuel outdoors.
- Keep away from sparks or flames.
- Use a container approved for fuel.
- Do not smoke or allow smoking near fuel or the unit or while using the unit.
- Wipe up all fuel spills before starting engine.
- Move at least 10 feet (3 meters) away from fueling site before starting engine.
- Stop engine and allow it to cool before removing fuel cap.
- Empty the fuel tank before storing the unit. Use up fuel left in the carburetor by starting the engine and letting it run until it stops.
- Store unit and fuel in area where fuel vapors cannot reach sparks or open flames from water heaters, electric motors or switches, furnaces, etc.

CUTTING SAFETY

- Inspect the area to be cut before each use. Remove objects (rocks, broken glass, nails, wire, string, etc.) which can be thrown or become entangled in the blade or trimmer head.
- Keep others including children, animals, bystanders, and helpers at least 50 feet (15 meters) away. Stop engine immediately if you are approached.
- Always keep engine on the right-hand side of your body.
- Hold the unit firmly with both hands.
- Keep firm footing and balance. Do not overreach.
- Keep blade or trimmer head below waist level.
- Do not raise engine above your waist.

- Keep all parts of your body away from blade, trimmer head, and muffler when engine is running.
- Cut from your right to your left.
- Use only for jobs explained in this manual.

TRANSPORTING AND STORAGE

- Stop the unit before carrying.
- Allow engine to cool and secure unit before storing or transporting it in a vehicle.
- Empty the fuel tank before storing or transporting the unit. Use up fuel left in the carburetor by starting the engine and letting it run until it stops.
- Store unit and fuel in an area where fuel vapors cannot reach sparks or open flames from water heaters, electric motors or switches, furnaces, etc.
- Store unit so the blade or line limiter cannot accidentally cause injury. The unit can be hung by the tube.
- Store unit out of reach of children.

SPECIAL NOTICE: Exposure to vibrations through prolonged use of gasoline powered hand tools could cause blood vessel or nerve damage in the fingers, hands, and joints of people prone to circulation disorders or abnormal swellings. Prolonged use in cold weather has been linked to blood vessel damage in otherwise healthy people. If symptoms occur such as numbness, pain, loss of strength, change in skin color or texture, or loss of feeling in the fingers, hands, or joints, discontinue the use of this tool and seek medical attention. An anti-vibration system does not guarantee the avoidance of these problems. Users who operate power tools on a continual and regular basis must monitor closely their physical condition and the condition of this tool.

SPECIAL NOTICE: This unit is not equipped with a temperature limiting muffler and spark arresting screen which meets the requirements of California Codes 4442 and 4443. All U.S. forest land and the states of California, Idaho, Maine, Minnesota, New Jersey, Oregon, and Washington require by law that many internal combustion engines to be equipped with a spark arrestor screen. If you operate in a locale where such regulations exist, you are legally responsible for installing and maintaining the operating condition of these parts. Failure to do so is a violation of the law.

ASSEMBLY

CARTON CONTENTS

Check carton contents for the following:

- Brushcutter
- tube mounting screws (2)
- tube mounting nuts (2)
- handlebar screws (2)
- blade shield screws (4)
- cupped washer (1)
- large nut for installing blade (1)
- long hex key wrench (1)
- short hex key wrench (1)
- bracket cover
- shield for use with blades

- shield for use with trimmer head
- semi-automatic trimmer head
- shoulder strap with warning
- brush blade
- handlebar

Examine parts for damage. Do not use damaged parts.

NOTE: If you need assistance or find that parts are missing or damaged, call 1-800-554-6723.

It is normal for the fuel filter to rattle in the empty fuel tank.

Finding fuel or oil residue on muffler is normal due to carburetor adjustments and testing done by the manufacturer.

ASSEMBLY

WARNING: If received assembled, repeat all steps to ensure your unit is properly assembled and all fasteners are secure.

TOOLS REQUIRED

- 2 hex key wrenches (provided)
- adjustable wrench or large pliers
- phillips screwdriver

ATTACHING THE TUBE

NOTE: Illustrations within this section will help in identifying the assembly steps. Be sure to read each section and review the illustrations, before you begin.

NOTE: A drive shaft is located in the center of the tube. Make sure this shaft does not fall out of the tube. Dirt on the shaft will significantly reduce the life of the unit. If this shaft falls out, clean, relubricate, and re-install.

- Insert the 2 tube assembly screws and nuts as illustrated. Keep loose at this time, you will tighten them during a later step.

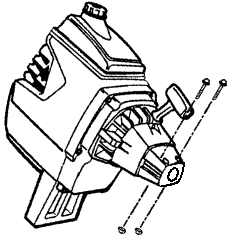

- Some units may include a plastic cover over the end of the tube. If your unit includes any covering, remove the cover at this time.
- Pull about 1/2 inch of the drive shaft out of the inside of the tube.

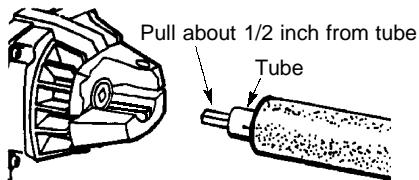

NOTE: The end of the drive shaft is square. This square end fits inside a square hole in a shaft inside the engine. Look inside the end of

the engine and you will see the square hole in the shaft.

NOTE: The end of the tube has a groove that aligns with a ridge in the engine opening. Locate the groove and ridge.

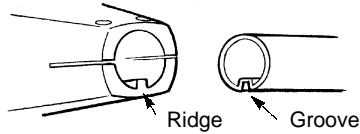

- Align the groove in the tube with the ridge in the engine opening. Insert the tube into the opening.
- Firmly push the tube into engine until it will no longer go into the opening.
- Tighten the screws, using one of the hex keys provided with the unit.

ATTACHING THE HANDLEBAR

DANGER: The barrier portion of the handlebar must be installed as shown to provide a barrier between operator and the spinning blade.

- Locate the decal on the handlebar. This decal includes two arrows. Position the handlebar on the mounting bracket between these arrows.
- Position the bracket cover over the handlebar. Again make sure the handlebar is between the arrows.
- Insert screws and hand tighten only. These screws will be tightened later.

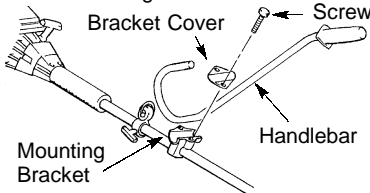

ATTACHING THE CONTROL HANDLE TO THE HANDLEBAR

NOTE: Make sure the wire going to the control handle is routed below the tube and remains on the right side of the handlebar and the tube.

- Remove screw from control handle.

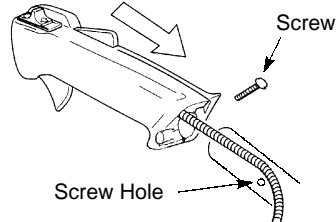

- Slide handle onto the right side of the handlebar and align the screw hole.
- Re-insert screw and tighten securely.

NOTE: Make sure the control handle is on the right side of the unit as shown in the illustration below, and the On/Stop switch is located on the top of the control handle.

- Adjust the handlebar to the proper position and tighten the two screws you left loose during handlebar assembly. Make sure these screws are securely tightened.
- After attaching the control handle and tightening the handlebar, route the wire from the control handle through the slit in the bottom of the foam grip.

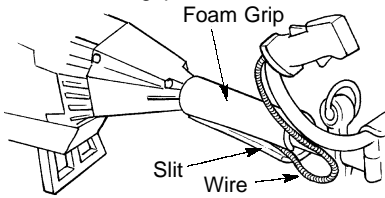

ASSEMBLY OF SHOULDER STRAP

WARNING: Proper shoulder strap and handlebar adjustments before starting the engine are required.

- Try on shoulder strap and adjust for fit and balance before starting the engine or beginning a cutting operation.
- Insert your right arm and head through the shoulder strap and allow it to rest on your left shoulder. Make sure the danger sign is on your back and the hook is to the right side of your waist.

NOTE: A one-half twist is built in the shoulder strap to allow the strap to rest flat on the shoulder.

- Adjust the strap, allowing the hook to be about 6 inches below the waist.
- Fasten the strap hook to the clamp located between the foam grip and the mounting block and lift the tool to the operating position.

CONFIGURING YOUR UNIT

You can configure your unit using a cutting head for grass and light weeds, or a brush blade for cutting saplings and similar size material. Go to the section for the desired configuration and follow the instructions for assembling your unit.

ASSEMBLY INFORMATION - TRIMMER HEAD

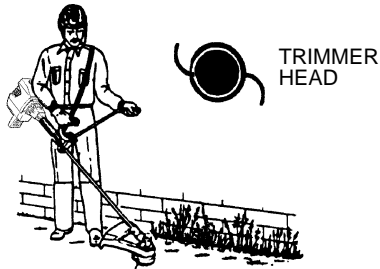

NOTE: If your unit has been assembled for brushblade use, refer to the section AS-

SEMBLY INFORMATION FOR USING YOUR UNIT WITH A BRUSHBLADE and reverse the steps to remove the metal shield and blade before you mount the plastic shield and trimmer head.

ATTACHING THE PLASTIC SHIELD AND TRIMMER HEAD

WARNING: The shield must be properly installed. The shield provides partial protection from the risk of thrown objects to the operator and others and is equipped with a line limiter which cuts excess line to the proper length. The line limiter (on underside of shield) is sharp and can cut you.

- Remove wing nut from shield.
- Insert bracket into slot on shield.
- Pivot shield until bolt passes through hole in bracket.
- Tighten the wing nut securely.
- If your unit has a plastic cover over the threads on the threaded shaft, remove the covering to expose the threads.
- Before installing the trimmer head, make sure the dust cup and retaining washer are positioned on the gearbox as shown below.

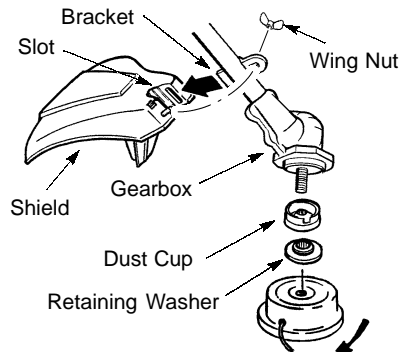

NOTE: Make sure all parts are properly installed as illustrated in the illustration before installing the trimmer head.

- Align hole in the dust cup with the hole in the side of the gearbox by rotating the dust cup.
- Insert a hex wrench into aligned holes. This will keep the shaft from turning while tightening the trimmer head.

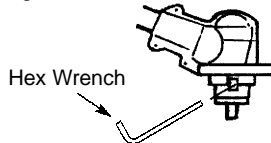

- While holding the hex wrench in position, thread trimmer head onto the shaft and tighten until secure.

NOTE: The retaining washer must be positioned with the raised section facing toward the gearbox.

ASSEMBLY INFORMATION - BRUSH BLADE

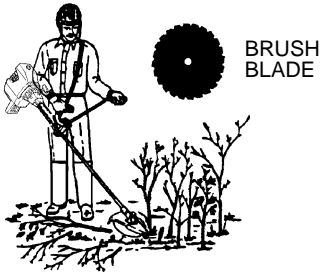

NOTE: If your unit has been assembled for trimmer head use, refer to the section ATTACHING THE PLASTIC SHIELD AND TRIMMER HEAD and reverse the steps to remove the plastic shield and trimmer head before you mount the metal shield and blade. Store these parts for future use. Never use the trimmer head with the metal blade installed.

ASSEMBLY OF THE METAL SHIELD

⚠ DANGER: The metal shield must be properly installed on the tool anytime the tool is used with the blade. The forward tip of the metal shield helps to reduce the occurrence of blade thrust which can cause serious injury such as amputation to the operator or bystanders. Failure to install the shield in the position shown can result in serious injury to the operator. The length of the shield must be aligned with the length of the tube. The blade is sharp and can cut you. Be sure to wear gloves while working with blades.

- If your unit has a plastic cover over the threads on the shaft, remove the covering to expose the threads.
- Place the metal shield under the gearbox, and align the screw holes.

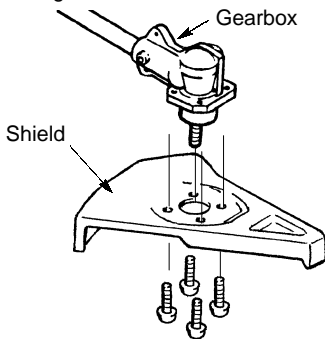

- Insert the 4 mounting screws through the bottom of the shield. Thread them into the gearbox. Tighten evenly and securely with one of the hex key wrenches provided.

ASSEMBLY OF THE METAL BLADE

⚠ WARNING: Do not use any blades, or fastening hardware other than the washers and nuts illustrated in the following illustrations. These parts must be provided by POULAN PRO, and installed as shown below. Failure to use proper parts can cause the blade to fly off and seriously hurt you or others.

NOTE: When installing the blade, make sure you install it with the correct side facing up (marked on the blade). If you are re-installing an older blade and the writing has worn off, use the following illustration as a guide.

Top view of blade

Teeth on blade point in this direction

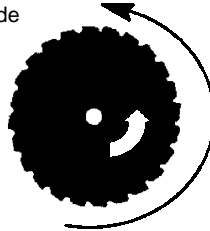

NOTE: The dust cup and retaining washer are located on the gearbox and not in the parts bag.

- Remove the retainer washer from the gearbox, and leave the dust cup on the gearbox.

NOTE: It may be necessary to remove a plastic protective covering from the threaded shaft before removing the retaining washer.

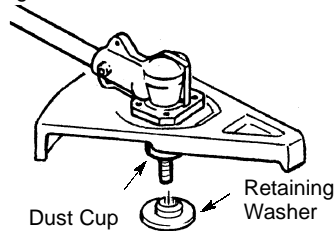

- Install the blade over the threaded shaft extending from the gearbox between the dust cup and the retaining washer. Make sure the raised part of the retaining washer is facing the gearbox, and the raised area fits into the hole in the center of the blade.
- Slide the blade and retaining washer onto the shaft of the gearbox.
- Now place the cupped washer onto the shaft. Make sure the cupped side of the washer is toward the blade.

- Install the blade nut by threading onto the shaft counterclockwise.

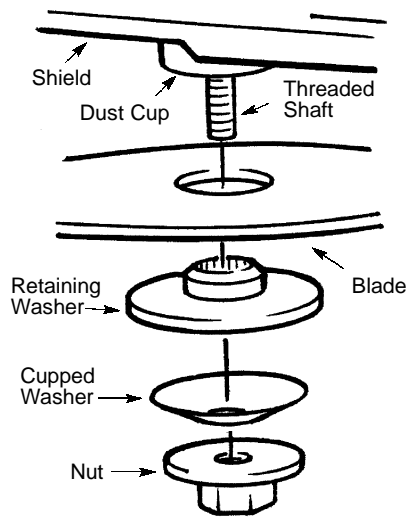

WARNING: Do not use any blades, or fastening hardware other than the washers and nuts illustrated. These parts must be provided by POULAN PRO, and installed as shown below. Failure to use proper parts can cause the blade to fly off and seriously hurt you or others.

NOTE: Make sure all parts are in place as illustrated, and the blade is sandwiched between the dust cup and the retaining washer. There should be no space between the blade and the dust cup or the retaining washer.

- Align hole in the dust cup with the hole in the side of the gearbox.
- Insert a hex wrench into the aligned holes. This will keep the shaft from turning while tightening the blade nut.

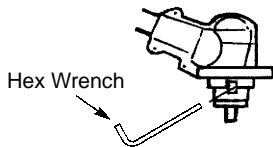

- Tighten the blade nut firmly with a wrench while holding hex wrench in position.
- Remove the hex wrench.
- Turn blade by hand. If the blade binds against the shield, or appears to be uneven, the blade is not centered, and you must reinstall.

NOTE: To remove blade, insert hex wrench into aligned holes. Un-thread nut and remove parts. Be sure to store parts and instructions for future use.

FUEL YOUR UNIT

This engine is certified to operate on unleaded gasoline. Gasoline must be mixed with a good quality 2-cycle air-cooled engine oil designed to be mixed at a ratio of 40:1. Poulan/Weed Eater brand oil is recommended. (A 40:1 ratio is obtained by mixing 3.2 ounces of oil with 1 gallon of unleaded gasoline). When mixing fuel follow the instructions printed on the container. Always read and follow the safety rules under FUEL SAFETY.

STARTING

HOW TO STOP YOUR UNIT

- Move the ON/STOP switch to the STOP position (toward the cutting head).
- If engine does not stop, move choke to the FULL CHOKE position.

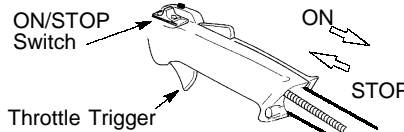

STARTING YOUR ENGINE

WARNING: The blade or trimmer head will turn while starting the engine. Avoid any contact with the muffler. A hot muffler can cause serious burns.

NOTE: A special feature called the "Throttle Lock" holds the throttle trigger in the depressed position during starting.

- Lock throttle trigger into the starting position by first pressing the lockout lever on the top of the control handle. While the lockout lever is depressed, squeeze and hold the throttle trigger.

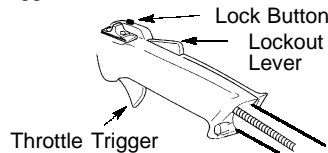

- Before releasing the throttle trigger, press the lock button. While this button is still depressed release the throttle trigger.

NOTE: This should allow the throttle trigger to remain in the depressed position for starting. You may want to practice this a few times before you first start the unit.

- DO NOT squeeze throttle trigger during starting; otherwise, it will be necessary to reset the throttle lock.

COLD ENGINE OR WARM ENGINE AFTER RUNNING OUT OF FUEL

- Rest engine and shield on ground, supporting trimmer head off ground.
- Move the switch to the ON position.
- Slowly press the primer bulb 6 times.
- Move the choke lever to FULL CHOKE position.

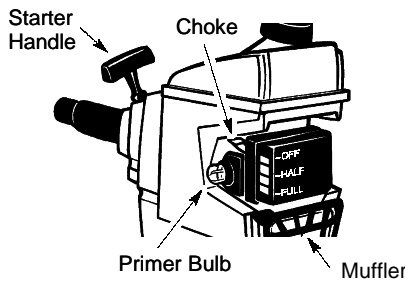

- Set the throttle trigger in the starting position using the throttle lock feature. Keep throttle trigger in the starting position until engine runs smoothly.
- Pull starter rope handle sharply 6 times.
- Move choke lever to HALF CHOKE position.
- Pull starter rope handle no more than 6 pulls, until engine runs.
- Allow engine to run 10 seconds, then move choke lever to OFF CHOKE position. Allow unit to run for 30 more seconds at OFF CHOKE before releasing throttle trigger from the starting position. Release throttle trigger by squeezing the trigger and then releasing it.

STARTING A WARM ENGINE

- Move the switch to the ON position.
- Move the choke lever to the OFF CHOKE position.
- Pull starter rope handle until engine runs.
- If engine does not start in 5 pulls, follow instructions in STARTING A COLD ENGINE.

USING YOUR UNIT

OPERATING POSITION

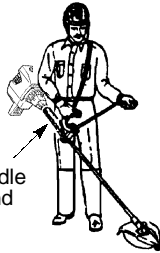

- Left arm extended with hand holding the handlebar grip.
- Right hand holding control handle, with fingers on throttle trigger.
- Engine below waist level.
- Shoulder strap pad centered on left shoulder.
- Danger sign centered on your back.
- Full weight of tool on left shoulder.
- Without operator bending over, the blade or trimmer head is near and parallel to the ground and easily contacts material to be cut.

OPERATING INSTRUCTIONS FOR USE WITH TRIMMER HEAD

Bring the engine to cutting speed before entering the material to be cut.

Do not run engine at a higher speed than necessary. The cutting line will cut efficiently when the engine is run at less than full throttle. At lower speeds, there is less engine noise and vibration. The cutting line will last longer and will be less likely to "weld" onto the spool.

If the trimmer head does not turn when the engine is in operation, make sure the drive shaft housing is properly seated in engine shroud.

Always release the throttle trigger and allow the engine to return to idle speed when not cutting.

ADVANCING THE TRIMMER LINE

Trimmer line will advance approximately 2 in. (5 cm) each time the bottom of the trimmer head is tapped on the ground with the engine running at full throttle.

The most efficient line length is the maximum length allowed by line limiter.

Always keep the shield in place when the tool is being operated.

To Advance Line:

- Operate the engine at full throttle.
- Hold the trimmer head parallel to and above the grassy area.
- Tap bottom of trimmer head lightly on the ground one time. Approximately 2 in. (5 cm) of line will be advanced with each tap. A blade on the shield will cut the line to the correct length.

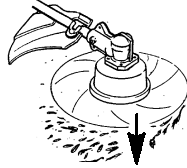

Always tap the trimmer head on a grassy area. Tapping on surfaces such as concrete or asphalt can cause excessive wear to the trimmer head.

If line is worn down to 2 in. (5 cm) or less, more than one tap will be required to obtain the most efficient line length.

WARNING: Use only .080" (2 mm) diameter line. Other sizes of line will not advance properly and can cause serious injury. Do not use other materials such as wire, string, rope, etc. Wire can break off during cutting and become a dangerous missile that can cause serious injury.

OPERATING INSTRUCTIONS FOR USE WITH BRUSHBLADE

- Blade Thrust is a reaction that only occurs when using a bladed unit. This reaction can cause serious injury such as amputation. Carefully study this section. It is important that you understand what causes blade thrust, how you can reduce the chance of its occurring, and how you can remain in control of unit if blade thrust occurs.

- **WHAT CAUSES BLADE THRUST** Blade Thrust can occur when the spinning blade contacts an object that it does not cut. This contact causes the blade to stop for an instant and then suddenly move or "thrust" away from the object that was hit. The "thrusting" reaction can be violent enough to cause the operator to be propelled in any direction and lose control of the unit. The uncontrolled unit can cause serious injury if the blade contacts the operator or others.
- **WHEN BLADE THRUST OCCURS.** Blade thrust can occur without warning if the blade snags, stalls, or binds. This is more likely to occur in areas where it is difficult to see the material being cut. By using the unit properly, the occurrence of blade thrust will be reduced and the operator will be less likely to lose control.



- Cut only grass, weeds, and woody brush up to 2 inches in diameter with the brush blade. Do not let the blade contact material it cannot cut such as stumps, rocks, fences, metal, etc., or clusters of hard, woody brush having a diameter greater than 2 inches.
- Keep the blade sharp. A dull blade is more likely to snag and thrust.
- Cut only at full throttle. The blade will have maximum cutting power and is less likely to bind or stall.
- "Feed" the blade deliberately and not too rapidly. The blade can thrust away if it is fed too rapidly.
- Cut only from your right to your left. Swinging the unit in the same direction as the blade spins increases the cutting action.
- Use the shoulder strap and keep a firm grip on the unit with both hands. A properly adjusted shoulder strap will support the weight of the unit, freeing your arms and hands to control and guide the cutting motion.
- Keep feet comfortably spread apart and braced for a possible sudden, rapid thrust of unit. Do not overreach. Keep firm footing and balance.
- Keep blade below waist level; it will be easier to maintain control of unit.
- Do not raise the engine above your waist as the blade can come dangerously close to your body.
- Do not swing unit with such force that you are in danger of losing your balance.

Bring the engine to cutting speed before entering the material to be cut.

If the blade does not turn when you squeeze the throttle trigger, make sure tube is fully inserted into the engine.

Always release the throttle trigger and allow engine to return to idle speed when not cutting.

The blade should not turn while the engine is running at idle. If the blade turns at idle, do not use your unit. Refer to the Carburetor adjustment section or contact your Authorized Service Dealer.

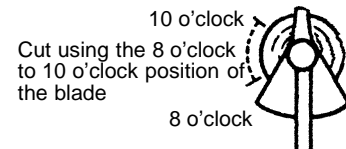

WARNING: The operator or others must not try to clear away cut material with the engine running or the blade turning to avoid serious injury. Stop engine and blade before removing materials wrapped around blade or tube.

REPLACING THE LINE

WARNING: Trimmer head parts that are chipped, cracked, broken, or damaged in any other way can fly apart and cause serious injury. Do not use. Replace damaged parts before using unit.

- Press the tab on the side of the trimmer head and twist the lock ring.
- Remove the lock ring and tap button.

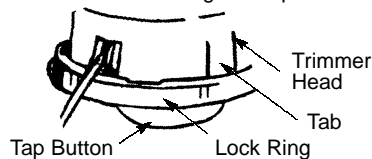

- Pull spool out of the trimmer head.
- Clean dirt and debris from all parts.
- Replace with a pre-wound spool, or replace line using two 20 foot lengths of .080" (2 mm) diameter line.
- When installing new line on an existing spool, insert 1/16" of the line into the anchoring hole in the bed of the spool, and wrap the line evenly and firmly around the spool in the direction of the arrow found on the spool.

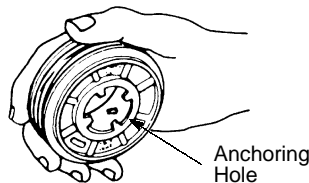

- Insert ends of the lines through the exit holes in the sides of the trimmer head.

NOTE: A metal insert is located in the exit hole. As your unit wears from use, you can re-install this insert upside down to provide a new surface for the exit of the line from the trimmer head.

WARNING: When installing the metal insert, you must install from the inside of the trimmer head. If installed on the outside of the trimmer head, this insert can fly off and become a dangerous missile.

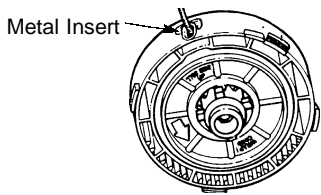

- Once line is passed through the exit hole, place the spool in the trimmer head. Press the spool down and turn it until it locks down and does not pop up when you release it.
- Make sure the line is not caught between the rim of the spool and the wall of the trimmer head.
- Replace the tap button, and place the lock ring onto the trimmer head.
- Align the lock ring over the catches on the trimmer head. Push the ring down and turn until catches lock into place.

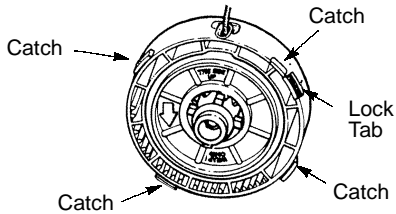

- Make sure the lock ring is securely fastened by pulling on it and twisting it in both directions.

WARNING: All catches must be fastened and lock tab latched in the lock ring. If installed incorrectly, lock ring can fly off and become a dangerous missile.

- Pull the line extending from the trimmer head. This will allow the spool to release from the locked position.

SPOOL REPLACEMENT

Replace the spool when the square corners on the lugs are rounded off, reduced in size, or broken. Follow instructions under REPLACING THE LINE for removing and installing the spool.

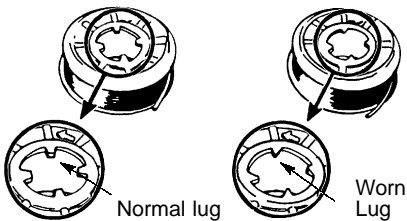

SERVICE

We recommend all service and adjustments not listed in this manual be performed by an Authorized Service Dealer.

CARBURETOR ADJUSTMENT

Your carburetor is equipped with limiter caps. Damage will occur if you turn the needles beyond the limiter caps. Carburetor adjustment is a complicated task. We recommend that you take your unit to an Authorized Service Dealer.

SPARK PLUG

Replace spark plug yearly with a Champion C.J-8Y plug; spark plug gap is .025 in.

IGNITION TIMING

Ignition timing is fixed, non-adjustable.

TROUBLESHOOTING

Engine will not start.

- Fuel tank empty.
- Engine flooded.
- Spark plug not firing.
- Fuel not reaching carburetor.
- Carburetor requires adjustment.

Engine will not idle properly.

- Carburetor requires adjustment.
- Throttle trigger problems.

Engine will not accelerate, lacks power, or dies under a load.

- Air filter dirty.
- Spark plug fouled.
- Carburetor requires adjustment.

Engine smokes excessively.

- Air filter dirty.
- Too much oil mixed with gasoline.
- Carburetor requires adjustment.

Line does not advance or breaks while cutting.

- Line improperly routed in head.
- Line improperly wound on spool.
- Line size incorrect.

Line welds onto spool.

- Line size incorrect
- Line improperly wound on spool.
- Crowding line on material being cut.

Line pulls back into head

- Too little line outside of head.
- Line size incorrect.

Need Assistance?

Call 1-800-554-6723 for assistance.

Need Service Parts?

Contact your dealer or call 1-800-554-6723.

LIMITED WARRANTY

Frigidaire Home Products Division WCI Outdoor Products, Inc., warrants to the original purchaser that each new **POULAN PRO** brand gasoline tool or attachment is free from defects in material and workmanship and agrees to repair or replace under this warranty any defective gasoline product or attachment as follows from the original date of purchase.

2 YEARS-Parts and Labor, when used for household purposes.

90 DAYS-Parts and Labor, when used for commercial, professional, or income producing purposes.

30 DAYS—Parts and Labor, if used for rental purposes.

This warranty is not transferable and does not cover damage or liability caused by improper handling, improper maintenance, or the use of accessories and/or attachments not specifically recommended by Frigidaire Home Products for this tool. Additionally, this warranty does not cover tune-ups, spark plugs, filters, etc., that will wear and require replacement with reasonable use during the warranty period. This warranty does not cover predelivery setup or normal adjustments explained in the operator's manual.

THIS WARRANTY GIVES YOU SPECIFIC LEGAL RIGHTS, AND YOU MAY HAVE OTHER RIGHTS WHICH VARY FROM STATE TO STATE.

NO CLAIMS FOR CONSEQUENTIAL OR OTHER DAMAGES WILL BE ALLOWED, AND THERE ARE NO OTHER EXPRESS WARRANTIES EXCEPT THOSE EXPRESSLY STIPULATED HEREIN.

SOME STATES DO NOT ALLOW LIMITATIONS ON HOW LONG AN IMPLIED WARRANTY LASTS OR THE EXCLUSION OR LIMITATIONS OF INCIDENTAL OR CONSEQUENTIAL DAMAGES, SO THE ABOVE LIMITATIONS OR EXCLUSION MAY NOT APPLY TO YOU.

Frigidaire Home Products' policy is to continuously improve its products. Therefore, Frigidaire Home Products reserves the right to change, modify, or discontinue models, designs, specifications, and accessories of all products at any time without notice or obligation to any purchaser.

U.S. EPA EMISSION CONTROL WARRANTY STATEMENT

YOUR WARRANTY RIGHTS AND OBLIGATIONS: The U. S. Environmental Protection Agency and **POULAN/WEED EATER, DIVISION OF WCI OUTDOOR PRODUCTS** are pleased to explain the emissions control system warranty on your lawn and garden equipment engine. All new utility and lawn and garden equipment engines must be designed, built, and equipped to meet the stringent anti-smog standards. **POULAN/WEED EATER** must warrant the emission control system on your lawn and garden equipment engine for the periods of time listed below provided there has been no abuse, neglect, or improper maintenance of your lawn and garden equipment engine. Your emission control system includes parts such as the carburetor and the ignition system. Where a warrantable condition exists, **POULAN/WEED EATER** will repair your lawn and garden equipment engine at no cost to you. Expenses covered under warranty include diagnosis, parts and labor. **MANUFACTURER'S WARRANTY COVERAGE:** If any emissions related part on your engine (as listed under Emissions

Control Warranty Parts List) is defective or a defect in the materials or workmanship of the engine causes the failure of such an emission related part, the part will be repaired or replaced by **POULAN/WEED EATER**.

OWNER'S WARRANTY RESPONSIBILITIES: As the lawn and garden equipment engine owner, you are responsible for the performance of the required maintenance listed in your Owner's Manual. **POULAN/WEED EATER** recommends that you retain all receipts covering maintenance on your lawn and garden equipment engine, but **POULAN/WEED EATER** cannot deny warranty solely for the lack of receipts or for your failure to ensure the performance of all scheduled maintenance. As the lawn and garden equipment engine owner, you should be aware that **POULAN/WEED EATER** may deny you warranty coverage if your lawn and garden equipment engine or a part of it has failed due to abuse, neglect, improper maintenance, unapproved modifications, or the use of parts not made or approved by the original equipment manufacturer. You are responsible for presenting your lawn and garden equipment engine to a **POULAN/WEED EATER** authorized repair center as soon as a problem exists. Warranty repairs should be completed in a reasonable amount of time, not to exceed 30 days. If you have any questions regarding your warranty rights and responsibilities, you should contact your nearest authorized service center or call **POULAN/WEED EATER** at **1-800-554-6723**.

WARRANTY COMMENCEMENT DATE: The warranty period begins on the date the lawn and garden equipment engine is purchased. **LENGTH OF COVERAGE:** This warranty shall be for a period of two years from the initial date of purchase. **WHAT IS COVERED: REPAIR OR REPLACEMENT OF PARTS.** Repair or replacement of any warranted part will be performed at no charge to the owner at an approved **POULAN/WEED EATER** servicing center. If you have any questions regarding your warranty rights and responsibilities, you should contact your nearest authorized service center or call **POULAN/WEED EATER** at **1-800-554-6723**.

WARRANTY PERIOD: Any warranted part which is not scheduled for replacement as required maintenance, or which is scheduled only for regular inspection to the effect of "repair or replace as necessary" shall be warranted for 2 years. Any warranted part which is scheduled for replacement as required maintenance shall be warranted for the period of time up to the first scheduled replacement point for that part. **DIAGNOSIS:** The owner shall not be charged for diagnostic labor which leads to the determination that a warranted part is defective if the diagnostic work is performed at an approved **POULAN/WEED EATER** servicing center. **CONSEQUENTIAL DAMAGES:** **POULAN/WEED EATER** may be liable for damages to other engine components caused by the failure of a

warranted part still under warranty. **WHAT IS NOT COVERED:** All failures caused by abuse, neglect, or improper maintenance are not covered. **ADD-ON OR MODIFIED PARTS:** The use of add-on or modified parts can be grounds for disallowing a warranty claim. **POULAN/WEED EATER** is not liable to cover failures of warranted parts caused by the use of add-on or modified parts. **HOW TO FILE A CLAIM:** If you have any questions regarding your warranty rights and responsibilities, you should contact your nearest authorized service center or call **POULAN/WEED EATER** at 1-800-554-6723. **WHERE TO GET WARRANTY SERVICE:** Warranty services or repairs shall be provided at all **POULAN/WEED EATER** service centers. call:

1-800-554-6723 **MAINTENANCE, REPLACEMENT AND REPAIR OF EMISSION RELATED PARTS:** Any **POULAN/WEED EATER** approved replacement part used in the performance of any warranty maintenance or repair on emission related parts will be provided without charge to the owner if the part is under warranty. **EMISSION CONTROL WARRANTY PARTS LIST:** Carburetor, Ignition System: Spark Plug (covered up to maintenance schedule), Ignition Module. **MAINTENANCE STATEMENT:** The owner is responsible for the performance of all required maintenance as defined in the owner's manual.

Free Manuals Download Website

<http://myh66.com>

<http://usermanuals.us>

<http://www.somanuals.com>

<http://www.4manuals.cc>

<http://www.manual-lib.com>

<http://www.404manual.com>

<http://www.luxmanual.com>

<http://aubethermostatmanual.com>

Golf course search by state

<http://golfingnear.com>

Email search by domain

<http://emailbydomain.com>

Auto manuals search

<http://auto.somanuals.com>

TV manuals search

<http://tv.somanuals.com>