

# SEARS Kenmore

## CONTENTS

### SAFETY

..... 1-4

### USE AND CARE

Your Range and Its Features .....	5
Range Control .....	6-8, 21
Cooktop Cooking .....	9, 10
Oven Cooking .....	11
Broiling .....	12
Self-clean Cycle .....	13, 14
Cleaning Tips .....	15
Removable Parts .....	16-18

### BEFORE CALLING FOR SERVICE

What to Do Before Calling for Service .....	19, 20
Thermostat Adjustments .....	21

### WARRANTY

MODEL    46725  
            46729

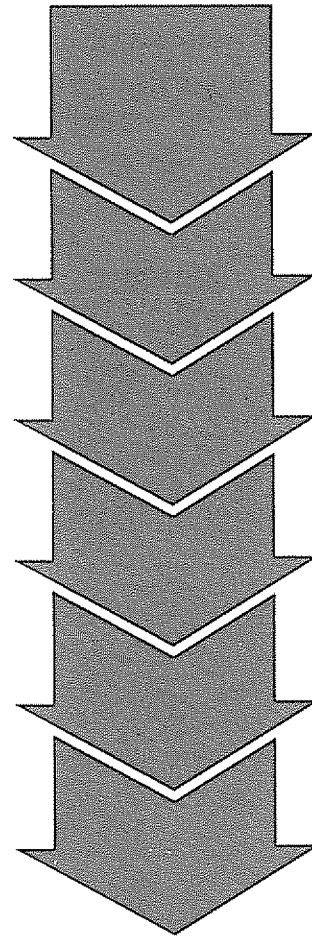

# USE • CARE • SAFETY MANUAL

MNM233(SR10059)

IMPORTANT IMPORTANT IMPORTANT IMPORTANT IMPORTANT IMPORTANT IMPORTANT IMPORTANT IMPORTANT

# IMPORTANT INSTRUCTIONS FOR YOUR SAFETY

## SAVE THESE INSTRUCTIONS

Read all instructions before using this appliance. When using electrical appliances, basic safety precautions should be followed, including the following:

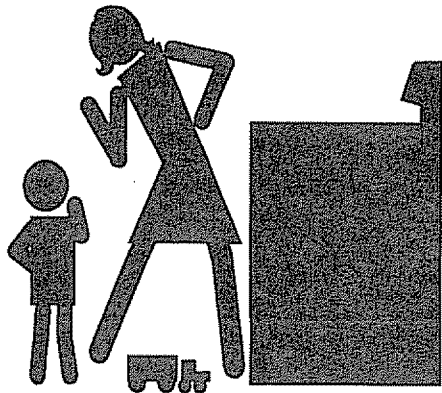

Teach children not to play with range knobs or any other part of the range.  
Never leave children alone or unattended where a range is in use.

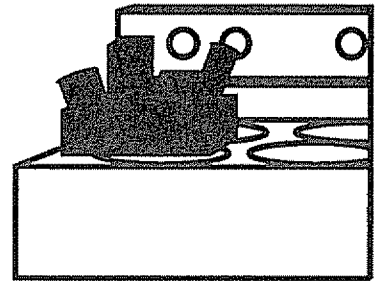

**CAUTION:**  
Never store things children might want above a range.  
Never let anyone climb, sit or stand on the open door or any other part of the range. Their weight may make the range tip over.

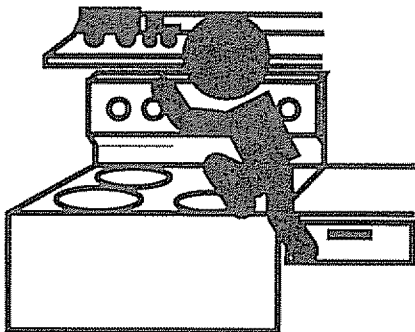
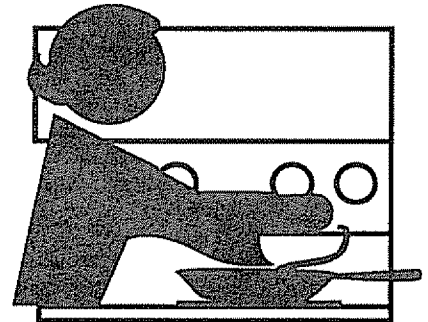

Never leave the oven door open when you are not watching the range.

**WARNING:**  
To prevent accidental tipping of the range from abnormal usage, including excess loading of the oven door, attach it to the wall or floor by installing the anti-tip bracket supplied. If the range is moved for cleaning, servicing or any reason, be sure anti-tip device is re-engaged properly when the range is replaced. Failure to take this precaution could result in tipping of the range and cause injury.

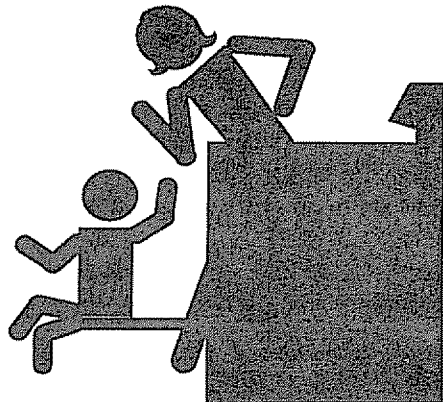

IMPORTANT IMPORTANT IMPORTANT IMPORTANT IMPORTANT IMPORTANT IMPORTANT IMPORTANT IMPORTANT

To insure safety for yourself and your home, please read your Owner's Manual carefully. Keep it handy for quick easy reference. Pay close attention to the safety sections of your manual. You can recognize the safety sections by looking for the  symbol or the word "Safety".

Always keep the range area clear and free from things that will burn.

**CAUTION:**

Never store things in an oven or near cooktop elements/burners. These things may catch fire and plastic items could melt.

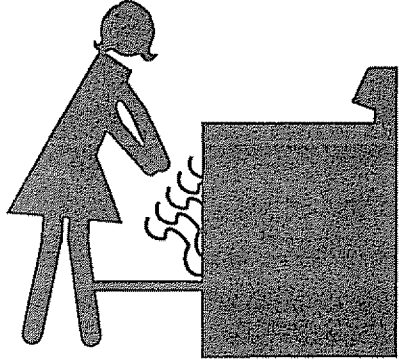

Never use your range for warming or heating a room. You could be burned or seriously injured. Such misuse could also cause damage to the range.

Never wear loose clothing when using your range. Such clothing could catch fire.



Never use a towel or other bulky cloth as a potholder. Such cloths could catch fire on a hot element/burner.

Never let pot handles stick out over the front of the range. Turn handles in so that they cannot be bumped into. Keep the handles away from other hot surface elements/burners.

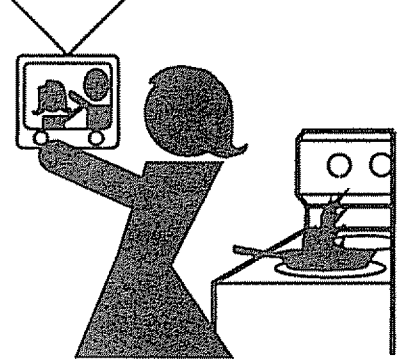

Never leave cooktop elements/burners unwatched at high heat settings. Boilovers cause smoking and greasy spllovers could catch fire.

# IMPORTANT SAFETY INSTRUCTIONS

Keep this book for later use.

Be sure your range is installed and grounded properly by a qualified technician.

Choose pots and pans with flat bottoms, large enough to cover the entire cooktop element. This will cut down the risk of setting potholders or clothing on fire with an uncovered element and waste less energy.

Always use care when touching the cooktop, oven heating elements or inside the oven. Heating elements could be hot enough to burn you even if they are dark in color. The oven vent duct and oven door may also become hot during range use. The glass surface of the cooktop will retain heat after the controls are turned off.

Only some kinds of glass or ceramic pans can be used for cooktop cooking. Be sure that the pan you use will not break when heated on the cooktop elements.

Place oven racks in desired position while oven is cool. If rack must be moved while oven is hot, do not let potholder contact hot heating element in oven.

After broiling, always take the broiler pan out of the range and clean it. Leftover grease in the broiler pan can catch on fire next time you use the pan.

Always use dry potholders when removing pans from the oven or cooktop. Moist or damp potholders can cause steam burns.

Always use care when opening oven door. Let hot air and steam out before moving food.

Always follow cleaning instructions in this book.

Always keep the range and oven clean. Food and grease are easy to ignite. Clean the range, oven and vents regularly.

**Do Not Use Oven Cleaners** — No commercial oven cleaner or oven liner protective coating of any kind should be used in or around any part of the oven.

**Clean Only Parts Listed in Manual.**

Always remove broiler pan and other utensils from the oven before a self-clean cycle.

**CAUTION: Do not store items of interest to children in cabinets above a range or on the backguard of a range. Children climbing on a range to reach items could be seriously injured.**

Always keep combustible wall coverings, curtains, or drapes a safe distance away from your range and oven.

Always keep dish towels, dish cloths, potholders and other linens a safe distance away from your range. Never store such items on your range.

Always keep the appliance area clear and free from things that will burn (gasoline and other flammable vapors and liquids).

Never try to repair or replace any part of the range unless instructions are given in this book. All other work should be done by a skilled technician.

Never heat unopened food containers. Pressure buildup may make container burst and cause injury.

Never leave jars or cans of fat or drippings on or near the range. Never let grease build up on your range. You can keep grease fires from starting if you clean up grease and spills after each range use.

Never use aluminum foil to line drip bowls or oven bottoms. Improper use of foil could start a fire.

Never block free airflow through the oven vent.

Never try to move a pan of hot fat, especially a deep fat fryer. Wait until the fat has cooled.

Never put removable heating elements in water. Do not put them in a dishwasher. Do not put them in the self-clean cycle of self-cleaning ovens.

**Do not cook on broken cooktop.** If cooktop should break, cleaning solutions and spillovers may penetrate the broken cooktop and create a risk of electrical shock. Contact a qualified technician immediately.

Never rub, move, or damage the door gasket on self-cleaning ranges. The gasket is essential for a good seal. Only clean the gasket by soaking it with hydrogen peroxide, as described in the self-clean section of the manual.

Never touch surface units, heating elements, or interior surfaces of the oven. They may be hot even though they appear dark in color.

**If the self-cleaning mode malfunctions,** turn off and disconnect the power supply. Have serviced by a qualified technician.

**Always keep wooden utensils, plastic utensils or canned food a safe distance away from your range.**

**Be sure everyone in your home knows what to do in case of fire.**

**For major spills** — Turn unit to LO; use dry paper towels to wipe up major spills, and then use a razor scraper (held in a potholder) to scrape major spills from a hot cooking zone. **DO NOT** attempt further cleaning until cooktop surface has cooled.

Some cleaners produce noxious fumes and wet cloths could cause steam burns if used on a hot surface.

Never try to clean utensils, cookware or removable parts of your range during a self-clean cycle.

## **SAFETY INSTRUCTIONS (continued)**

---

**Read and understand this information NOW!**

**Should you ever need it, you will not have time for reading.**

**Never use water on a grease fire - it will only spread the flames.**

### **COOKTOP GREASE FIRE**

**Never pick up a flaming pan...Instead:**

- 1. Turn off the element.**
- 2. Smother the fire with a tightly fitting pan lid, baking soda or an extinguisher.**

### **OVEN FIRE —**

**Do not try to move the pan!**

- 1. Close oven door and turn controls off.**
  - 2. If fire continues, throw baking soda on the fire, or use a dry chemical foam, or halon type extinguisher.**
- 

## **IMPORTANT SAFETY NOTICE**

The California Safe Drinking Water and Toxic Enforcement Act requires the governor of California to publish a list of substances known to the state to cause birth defects or other reproductive harm and requires businesses to warn customers of potential exposure to such substances.

The fiberglass insulation in self-clean ovens gives off a very small amount of carbon monoxide during the cleaning cycle. Exposure can be minimized by venting with an open window or using a ventilation fan or hood.

---

## **IMPORTANT INSTRUCTIONS TO AVOID DAMAGE TO YOUR COOKTOP:**

- **Never slide cookware across your cooktop.**
- **DO NOT use a dish towel or sponge to wipe up the cooktop.** They may leave a detergent film on the cooktop which may cause discoloration when heated. If this occurs, remove the discoloration with a recommended cooktop cleaner.
- **Melted materials (plastic, aluminum foil, sugar, or foods with high sugar content) can cause damage to the cooktop.** If you accidentally melt anything on your cooktop, turn unit to LO; wipe hot cooktop immediately with several dry paper towels. Scrape off remainder of burned material with razor scraper (held in potholder) at 30° angle while unit is warm. Be careful not to burn yourself! After cooking is complete, turn unit to OFF. **DO NOT** attempt further cleaning until cooktop surface has cooled.
- **DO NOT use scouring powders, plastic, nylon or metal cleaning pads.** They may scratch the cooktop.
- **DO NOT use chlorine bleach, ammonia, hydrofluoric acid, chemical oven cleaners, or any other kind of chemical cleaner.** They may discolor the cooktop.

# YOUR RANGE

## IMPORTANT:

The model and serial number of your range can be found on a tag behind the storage drawer panel on the left side of the front frame.

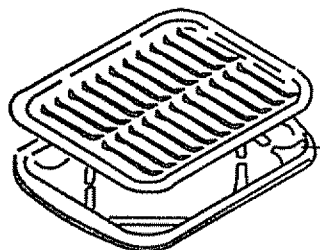
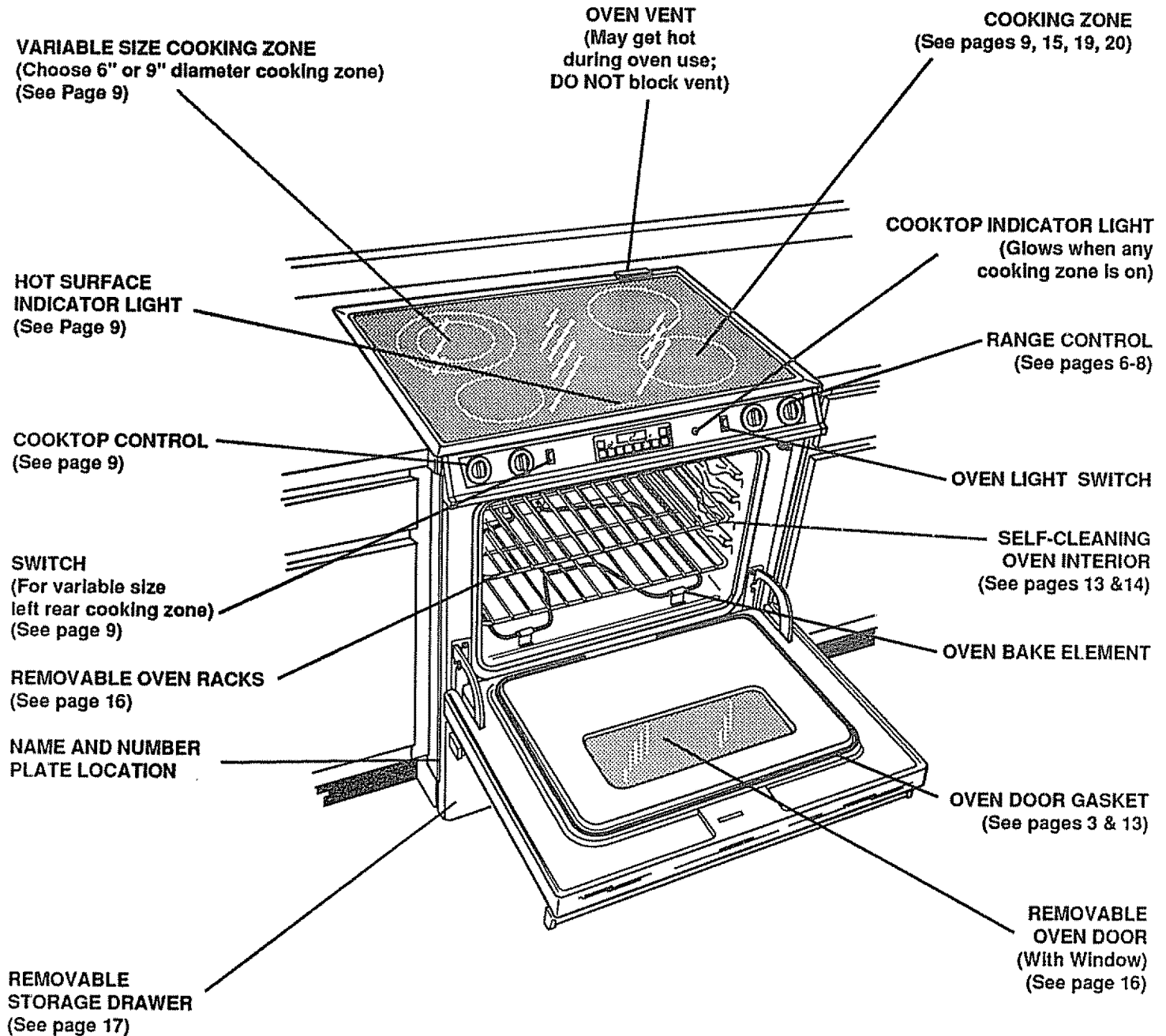

**BROILER PAN and GRID**  
(See pages 12 & 15)

# Range Control

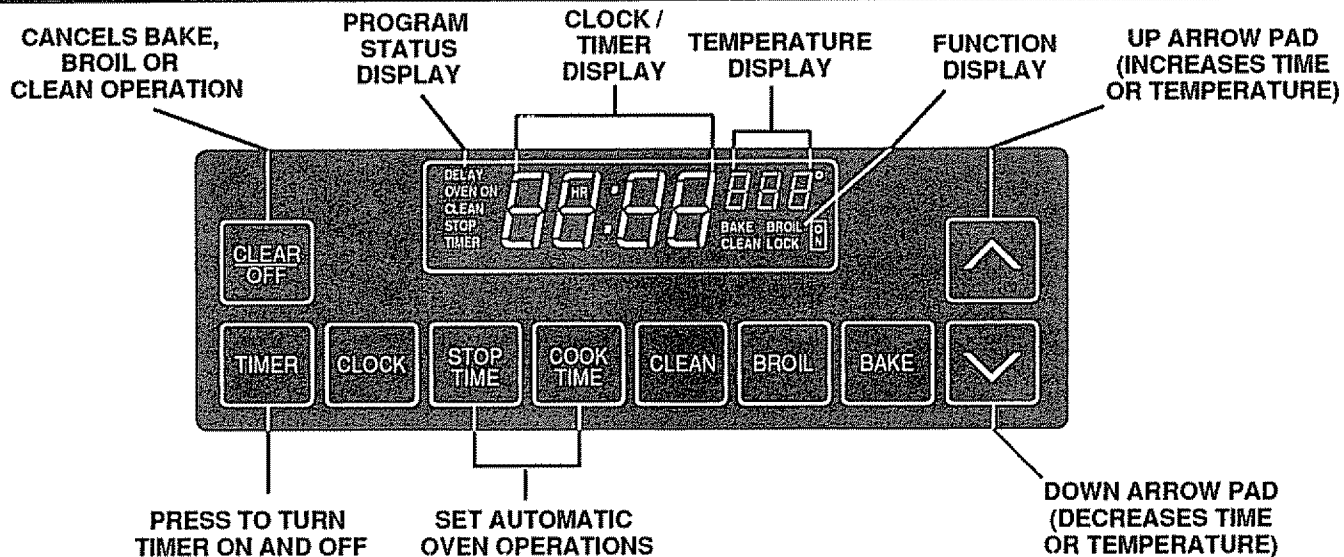

Your range control is touch controlled. To set BAKE, BROIL, TIMER or CLEAN, touch the desired function pad and select the temperature or time by touching the arrow pad.

## TO SET THE CLOCK:

1. Press CLOCK. The word "TIME" will flash in the display.
2. Press the UP or DOWN arrow pad to select the correct time of day. Hold your finger on the arrow pad to change display numbers quickly. Touch and release the arrow pad to change the time slowly. See Fig. 4.

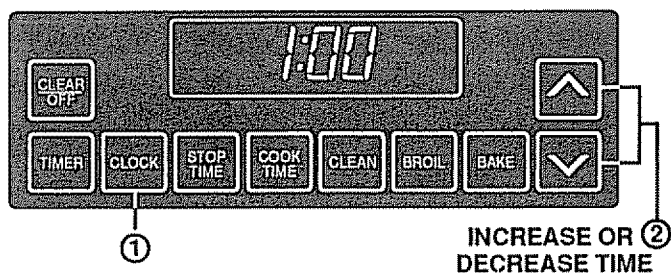

Fig. 1

## TO SET THE TIMER:

**NOTE:** The TIMER does not control oven operations. The maximum time setting is 9 hours and 55 minutes.

1. Press TIMER. "TIMER" will flash in the display.
2. Press the UP or DOWN arrow pad to select the amount of time. Hold your finger on the arrow pad to change the time quickly. Touch and release the arrow pad to change the time slowly. The TIMER will automatically begin counting down after a few seconds.
3. When the time is up, the end-of-cycle tone will beep. Press CLOCK to return the time of day to the display.

The TIMER display will increase as follows:

:10	TEN SECONDS	See Fig. 2
1:00	ONE MINUTE	See Fig. 3
1HR:00	ONE HOUR	See Fig. 4

When the display reaches one hour, the display will change. "HR" will appear in the display.

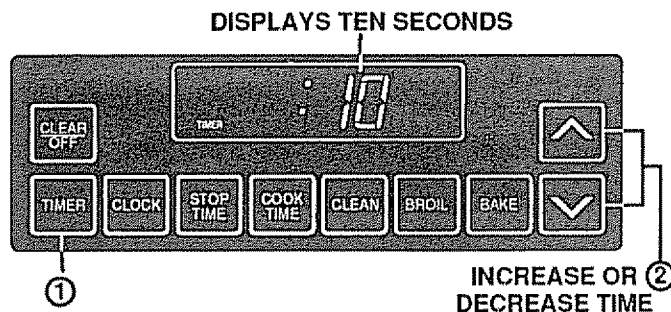

Fig. 2

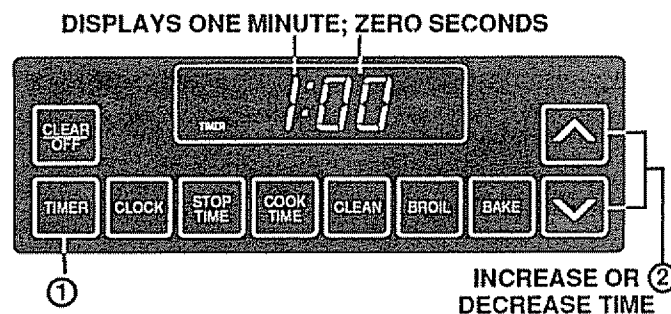
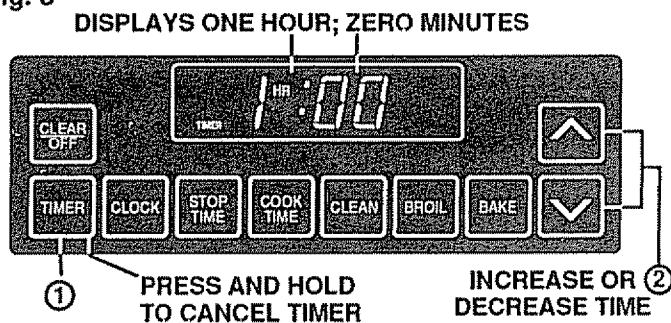

Fig. 3



6 Fig. 4

NCERC08

## TO RESET THE TIMER:

"TIMER" will stop flashing and the TIMER will start counting down a few seconds after you stop touching the UP or DOWN arrow. If you pause while selecting the time and the timer activates, press TIMER again and continue to set the time.

## TO CANCEL THE TIMER:

After TIMER begins to count down, press TIMER and hold TIMER in at least four seconds until "TIMER" quits flashing and time of day returns to display.

## TO SET BROIL:

1. Press BROIL. "BROIL" will flash and (---) will appear in the display. See Fig. 5.
2. Select LO Broil by pressing the UP arrow once. Select HI Broil by pressing the UP arrow twice. To change from HI Broil to LO Broil, press the DOWN arrow.
3. After cooking is complete, press CLEAR/OFF.

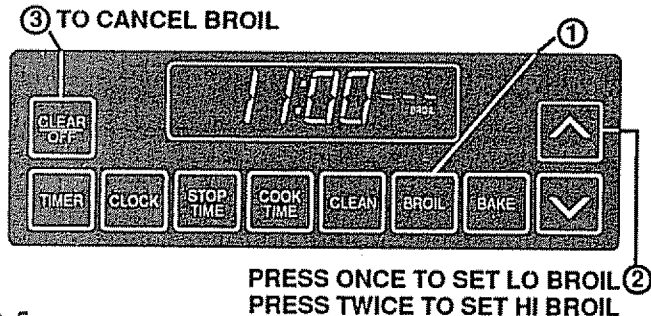

FIG. 5

## TO RESET BROIL:

If you do not select LO or HI Broil the function display will go blank. Repeat Steps 1 and 2.

## TO SET BAKE:

1. Press BAKE. "BAKE" will flash.
2. Select the desired temperature by touching the UP or DOWN arrow pad. The last used bake temperature will appear in the temperature display. Increase the temperature with the UP arrow. Decrease the temperature with the DOWN arrow.

If you do not set a temperature after you press BAKE, the display will go blank. Repeat steps 1 and 2.

3. After baking is complete, press CLEAR/OFF. See Fig. 6.

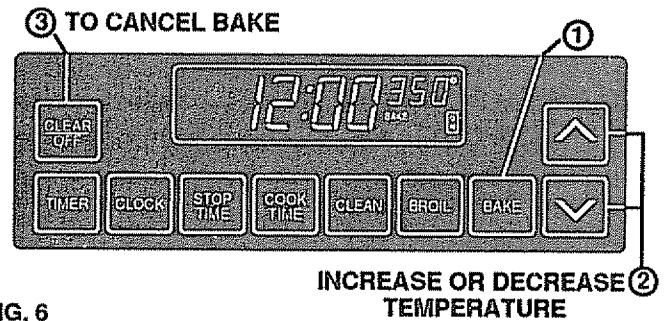

FIG. 6

## TIMED BAKING:

### AUTOMATIC OVEN OFF:

You can begin baking now and set the oven to turn OFF automatically.

1. Press COOK TIME.
2. Press UP or DOWN arrow to set how long you want to bake.
3. Press BAKE.
4. Select temperature using UP or DOWN arrow. See Fig. 7.

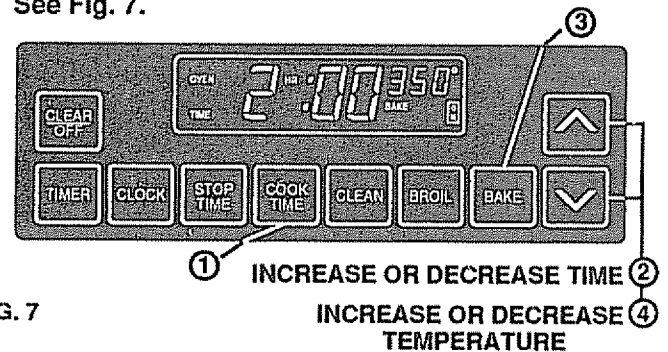

FIG. 7

**NOTE:** You should consider that food will continue to cook after controls turn OFF unless you remove the food immediately.



## DELAYED ON AND OFF:

You can set the oven to turn on and off automatically. The control will calculate the time to start cooking.

1. Press **COOK TIME**.
2. Press **UP** or **DOWN** arrow to set how long you want to bake.
3. Press **STOP TIME**. The earliest stop time you can set will appear in the display.
4. Set **STOP TIME** (the time of day when you want the oven to turn OFF) by pressing the **UP** or **DOWN** arrow.
5. Press **BAKE**.
6. Select temperature by pressing **UP** or **DOWN** arrow. See Fig. 8.

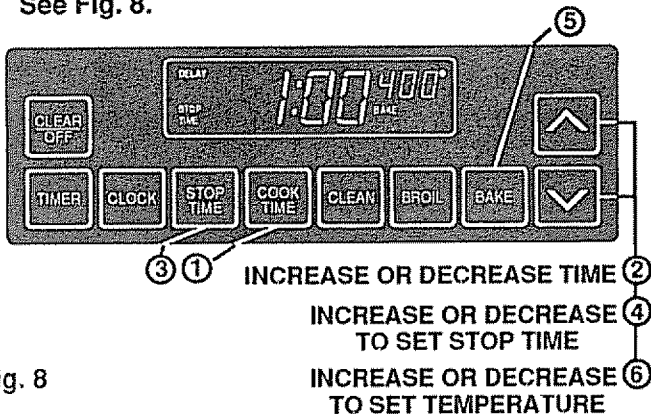

Fig. 8

### NOTE:

If the control beeps, you have not completed your timed oven setting. Press **CLEAR/OFF** and start again with Step 1.



The low temperature zone of this range (between 150°F and 200°F) is available to keep hot cooked foods warm. Food kept longer than two hours at these low temperatures may spoil.



Never let food, such as dairy products, fish, meat, poultry, etc., sit for more than 1 hour before cooking starts when you set your oven for a delay start. Room temperature promotes the growth of harmful bacteria. Be sure the oven light is off because heat from the bulb will speed bacteria growth.

## DISPLAY:

Once you have programmed your control for any operation, you can display the setting by pressing the appropriate pad. For example, if you are using the **TIMER** and want to see the time of day, press **CLOCK**. The display will show the time of day.

You cannot set **BAKE**, **BROIL**, or **COOK TIME** while the oven door is in the locked position. If you try, the word "door" will appear in the display. The oven door lock is to be used for **Self-Cleaning** only.

## TONES:

The end-of-cycle tone will sound at the end of timer use and automatic oven functions. The end-of-cycle tone is 3 short beeps followed by 1 beep every 6 seconds that repeat until you press any operation. If you would like to eliminate the repeating beeps, push and hold **CLEAR/OFF** for ten seconds. To return the 1 beep every 6 seconds, push and hold **CLEAR/OFF** for 10 seconds.

To cancel the end-of-cycle tone, press **CLOCK**.

## F-CODE:

If the time display beeps continuously and flashes an "F" followed by a number, you have a function error code. Note the number after the "F". Press **CLEAR/OFF**. Allow oven to cool for 1 hour. If problem repeats, disconnect all power to the range and call for service. Advise your service technician of the number following the "F" in the display.

# To Start Things Cooking

## Cooktop Cooking

Before you use the cooktop for the first time, clean it with cooktop cleaner. The sign near each cooktop control knob shows which element is turned on by that knob.

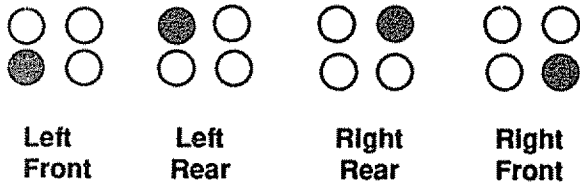

The cooking zones are shown by the outlines on the glass surface of the cooktop.

### To operate cooktop controls:

1. Push to turn.
2. Set on or between marks for desired heat.

The indicator light will glow when any cooking zone is activated.

### The left rear element has two cooking zones:

- To use the large 9" cooking area, push to turn the control knob to desired setting and push in top portion of the rocker switch next to the control knob.
- To use the small 6" cooking area, push to turn the control knob to desired setting and push in bottom portion of the rocker switch.

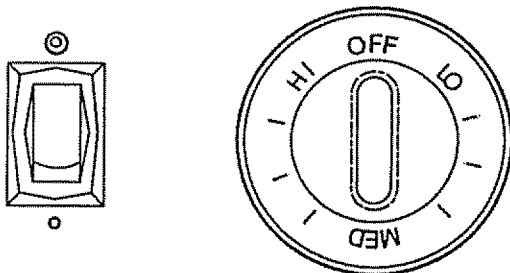

When a cooking zone is activated, coils beneath the zone radiate heat through the glass to the utensil. The red glow of the coils will be visible through the glass. It will take the cooking zone on the surface a few moments to heat up. The coil cycles on and off to maintain your selected control setting.

See the **Cleaning Tips** for important information about maintaining your cooktop.

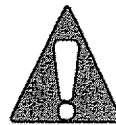

The surface will retain heat after controls have been turned off. The HOT SURFACE Indicator light glows until the cooktop has cooled to a safe temperature. This may take up to an hour after use. The temperature of the metal frame around the glass will also rise during cooktop use. Use caution when working around your cooktop, especially if more than one cooking zone is on or if using the cooktop for an extended period of time. Be careful not to get burned when the unit has not had time to cool after use.

Do not slide cookware on the surface as it may scratch the glass.

Never cook food directly on the glass. You must use proper cookware. Do not use surface as a cutting board.

For best cooking results and energy efficient operation, you should use pans that:

- A. Have flat bottoms and straight sides.
- B. Have light handles that do not tilt pans.
- C. Are about the same size as the element.

**Note:** A slight odor is normal when a new cooktop is used for the first time. It is caused by the heating of new parts and insulating materials and will disappear in a short time.

## Questions & Answers

- Q. Can I use special cooking equipment, like an oriental wok, on any of the cooking zones?
- A. We recommend that you use only flat bottomed woks. Cookware without flat surfaces is not recommended.
- Q. May I can foods and preserves on my maintop cooking zones?
- A. Yes, but only use cookware designed for canning purposes. Check the manufacturer's instructions and recipes for preserving foods. Be sure canner is flat-bottomed and fits over the center of the cooking zone selected. Canning should only be done on the maintop cooking zones. Canning generates large amounts of steam; be careful to avoid burns.
- Q. Why am I not getting the heat I need from my selected cooking zone even though the knob is on the right setting?
- A. Use cookware with flat bottoms and center the cookware inside the circle for the cooking zone selected. Metal cookware will conduct heat best.

## HOME CANNING TIPS

**Canning should be done on cooktop only.**

In surface cooking of foods other than canning, the use of large-diameter pots (extending more than 1" beyond edge of drip pan) is not recommended. However, when canning with water-bath or pressure canner, large-diameter pots may be used. This is because boiling water temperatures (even under pressure) are not harmful to cooktop surfaces surrounding heating unit.

**HOWEVER, DO NOT USE LARGE DIAMETER CANNERS OR OTHER LARGE DIAMETER POTS FOR FRYING OR BOILING FOODS OTHER THAN WATER.**

Most syrup or sauce mixtures — and all types of frying — cook at temperatures much higher than boiling water. Such temperatures could eventually harm cooktop surfaces surrounding heating units.

### OBSERVE FOLLOWING POINTS IN CANNING

1. Bring water to boil on HIGH heat, then after boiling has begun, adjust heat to lowest setting to maintain boil (saves energy and best uses surface unit).
2. Be sure canner fits over center of surface unit. If your range does not allow canner to be centered on surface unit, use smaller-diameter pots for good canning results.

3. Flat-bottomed canners give best canning results. Be sure bottom of canner is flat or slight indentation fits snugly over surface unit. Canners with flanged or rippled bottoms (often found in enamelware) are not recommended.

RIGHT



WRONG

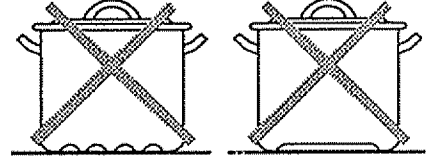

4. When canning, use recipes from reputable sources. Reliable recipes are available from the manufacturer of your canner; manufacturers of glass jars for canning, such as Ball and Kerr; and the United States Department of Agriculture Extension Service.
5. Remember, in following the recipes, that canning is a process that generates large amounts of steam. Be careful while canning to prevent burns from steam or heat.

**NOTE:** If your range is being operated on low power (voltage), canning may take longer than expected, even though directions have been carefully followed. The process may be improved by:

- (1) using a pressure canner, and
- (2) for fastest heating of large water quantities, begin with HOT tap water.

## OVEN COOKING

- When cooking a food for the first time in your new oven, use time given on recipes as a guide.

Your new oven has been set correctly at the factory and is more apt to be accurate than the oven it replaced.

After you have used your oven for awhile, if you feel your oven should be hotter or cooler, you can adjust it yourself. See **THERMOSTAT ADJUSTMENTS** in this manual.

- Always follow recipe carefully.
- Measure ingredients properly.
- Use proper pan placement.
- Place pans on the oven racks with 1" to 1 1/2" of air space on all sides of each pan. Avoid overcrowding the oven.
- Pans too close to each other, to oven walls or to the oven bottom block the free movement of air. Improper air movement causes uneven browning and cooking.



2 cake layers

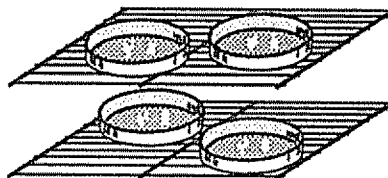

4 cake layers

- When baking several items stagger pans so that no pan is directly above another.
- Let the oven preheat thoroughly before cooking baked products. Listen for preheat notification tone and put the food in the oven.
- Opening the door too often to check food during baking will allow heat loss and may cause poor baking results.

- Cakes, cookies, muffins, and quick breads should be baked in shiny pans — to reflect the heat — because they should have a light golden crust. Yeast breads and pie crusts should be baked in glass or dull (non-shiny) pans — to absorb the heat — because they should have a brown, crisp crust.
- Be sure the underside of the pan is shiny, too. Darkened undersides will absorb the heat and may cause over-browning on the bottom of your food.

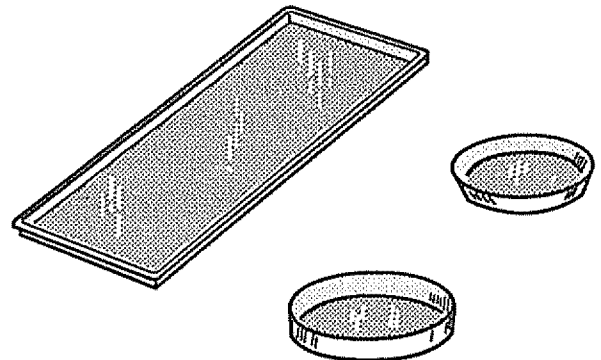

- Oven temperatures should be reduced 25 degrees below recommended temperatures if exterior of pan is predarkened, darkened by age or oven proof glass.
- There may be some odor when the oven is first used. This is caused by the heating of new parts and insulation.
- Do not cover an entire oven rack with foil. The foil can block normal heat flow and cause poor baking results. Do not place any foil directly above the bake element. Foil used on the oven bottom under the element may damage the oven surface; therefore, it should not be used.
- Cookies should be baked on flat cookie sheets without sides to allow the air to circulate properly.
- When recipes require preheating, have food nearby before you open the oven door. If the oven door is allowed to remain open for more than a brief time, the preheat temperature will be lost.

# BROILING

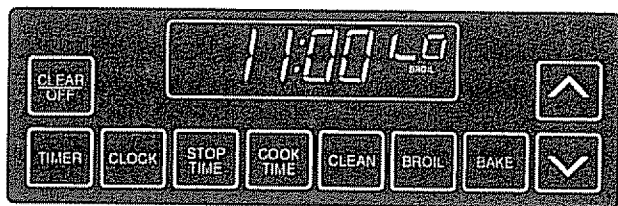

Most foods can be broiled at the HI Broil Setting. Select the LO Broil setting to avoid excessive browning or drying of foods that should be cooked to the well-done stage (such as thick pork chops or poultry).

## BROILING TIPS

- Your oven door should be open to the broil stop position while broiling. If the door is closed, the food will roast and not broil.
- Use only the broiler pan and grid that came with your range for broiling. They are designed for proper drainage of fat and liquids and help prevent spatter, smoke or fire.
- Do not preheat when broiling. For even broiling on both sides, start the food on a cold pan.
- Trim the outer layer of fat from steaks and chops. Silt the fatty edges to keep the meat from curling.
- For maximum juiciness, salt the first side just before turning the meat. Salt the second side just before serving.
- Brush chicken and fish with butter several times as they broil. When broiling fish, grease the grid to prevent sticking and broil with skin side down. It is not necessary to turn fish.
- Never leave a soiled broiler pan in the range. Grease in the pan may smoke or burn the next time the oven is used.
- Be sure you know the correct procedure for putting out a grease fire. See the section on safety.

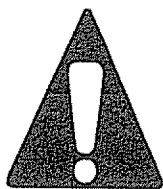

**Do not cover the entire broiler grid with foil. Poor drainage of hot fat may cause a broiler fire.**

**If a fire starts, close the oven door and turn controls off. If fire continues, throw baking soda on the fire. Do not put water on the fire.**

# POSITIONING BROILER PAN

Broiling is cooking by direct heat from the broil element. Tender cuts of meat or marinated meat should be selected for broiling. For best results steaks and chops should be at least 3/4" thick.

After placing food on the broiler pan, put the pan on an oven rack in the proper position. The recommended rack position and cooking time can be found in the chart below.

The closer the food is to the broil element, the faster the meat browns on the outside, yet stays red to pink in the center. Moving the meat farther away from the element lets the meat cook to the center while browning outside. Side one should be cooked 1 - 2 minutes longer than side two.

Food	Rack Position 4 = Highest 1 = Lowest	Total Time (minutes)
Steak - 1" Thick		
Rare	4	9-11
Medium	3	13-15
Well Done	3	21-23
Ground Beef Patties		
Medium-1" Thick	3	16-18
Medium-1/2" Thick	4	7-9
Lamb Chops - 1" Thick	3	18-21
Pork Chops - 1" Thick	3	27-29
Pork Chops - 1/2" Thick	3	16-18
Ham Slice - 1/2" Thick	3	11-12
Fish (Fillets)	3	11-13
Chicken (Pieces)	2	45-55
Frankfurters	3	8-11
Bacon	3	9-11

This chart is a general guide. The size, weight, thickness, and starting temperature of the food, as well as your own personal preference, will affect the cooking time. Times in the chart are based on the food being at refrigerator temperature.

# The Self-Clean Cycle

## BEFORE A CLEAN CYCLE

1. Remove the broil pan and grid, oven racks, all utensils and any foil that may be in the oven. Do not try to clean utensils or any other objects in the oven during a self-clean cycle. If oven racks are left in the range during a clean cycle, they will darken, lose their luster and become hard to slide. If you choose to leave the racks in the oven, you can polish the edges of the racks with steel wool and apply a small amount of vegetable oil to the rack edges after the self-clean cycle. This will make the racks easier to slide.
2. Soil on the oven front frame, under the front edge of the cooktop, the door liner outside the door seal and the front edge of the oven cavity (about 1" into the oven) will not be cleaned during a clean cycle (see illustration below). Clean these areas by hand before starting a clean cycle.  
Use hot water with a soap-filled steel wool pad, then rinse well.

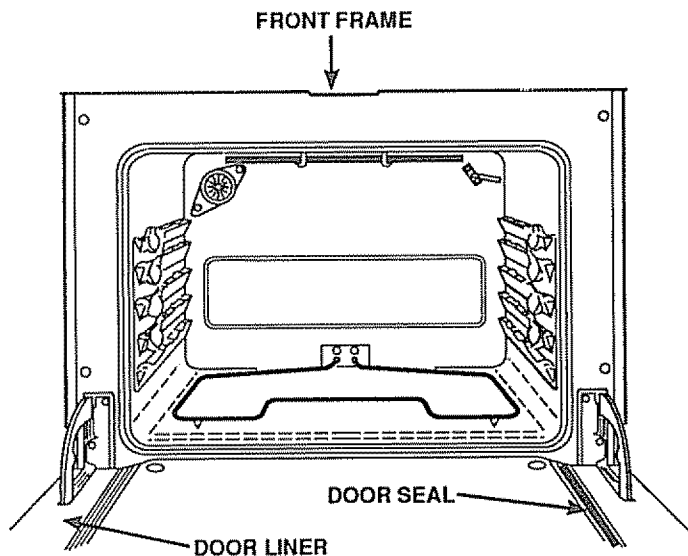

3. Wipe up heavy spillovers on the oven bottom. Too much soil may cause smoking during the clean cycle.
4. Clean the door seal by using a clean sponge to soak the soiled area with hydrogen peroxide. Repeated soaking may be needed depending on the amount of soil. Frequent cleaning will help prevent excessive soil buildup. Do not rub the door seal. The fiberglass material of the seal has an extremely low resistance to abrasion. An intact and well fitting oven door seal is essential for energy efficient oven operation and good baking results. If you notice the seal becoming worn, frayed or damaged in any way or if it has become displaced on the door, you should replace the seal.

## AFTER A CLEAN CYCLE

After a clean cycle, you may notice some white ash in the oven. Just wipe it up with a damp cloth.

If white spots remain, remove them with a soap-filled steel wool pad. Be sure to rinse thoroughly with a vinegar and water mixture. These deposits are usually a salt residue that cannot be removed by the clean cycle.

If the oven is not clean after one clean cycle, the cycle may be repeated.

**NOTE:** Your oven light should be OFF during a self-clean cycle to prolong the life of the bulb.

This range has a fan that will turn "ON" and "OFF" by itself to keep the electronics cool. Sometimes it will run after the range has been turned off.

## TO SET SELF-CLEAN CYCLE:

1. Close oven door. The door locks automatically after control is set.
2. Push **CLEAN**. The time display will show (----). See Fig. 1.

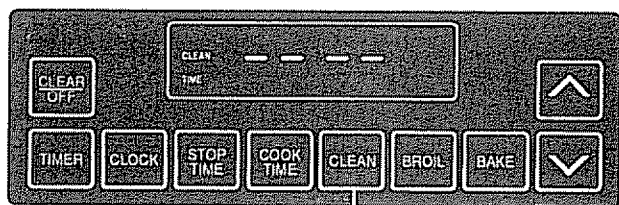

Fig. 1

3. Press the UP or DOWN arrow pad to set the desired length of clean time. Clean time is normally 3 hours. You can change it between 2 and 4 hours, depending on how dirty the oven is. See Fig. 2.

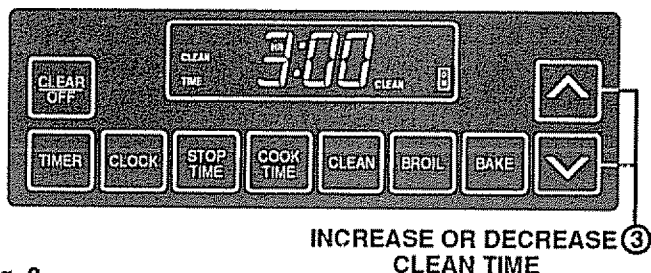

Fig. 2

You can push **STOP TIME** to find out when the cycle will end. Push **CLEAN** to return to countdown.

## WHEN A CLEAN CYCLE IS FINISHED:

1. Wait until the **LOCK** display goes out. Allow 30 minutes for oven to cool. The oven temperature must drop to a safe level before the door can be opened. See Fig. 3.

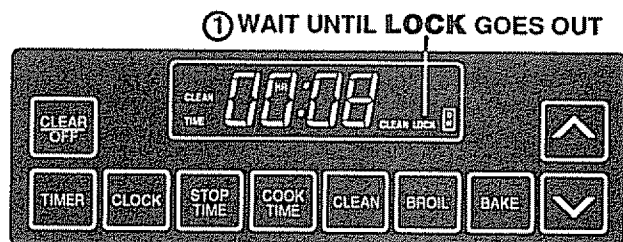

Fig. 3

## TO INTERRUPT A CLEAN CYCLE:

1. Push **CLEAR**.

Follow instructions under "WHEN A CLEAN CYCLE IS FINISHED".

## TO SET DELAYED SELF-CLEAN CYCLE:

Follow steps 1-3 under "TO SET SELF-CLEAN CYCLE", THEN:

4. Press **STOP TIME**.
5. Set the time of day when you want the clean cycle to end. See Fig. 4.

The control will calculate the start clean time.

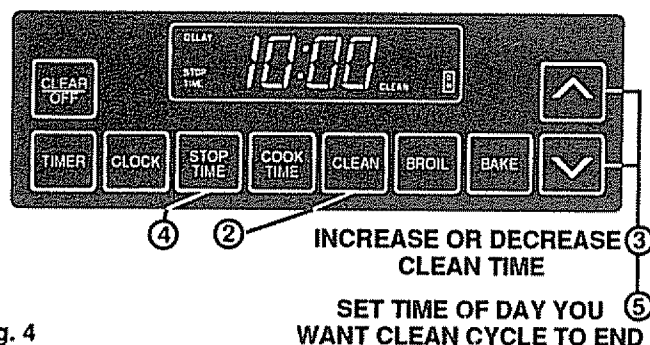

Fig. 4

**Note:** When selecting a stop time for a delayed clean cycle, you must allow time for the 2-4 hour clean time.

"Door" will flash in display if you forget to lock the door.

**NOTE:** Your oven light should be OFF during a self-clean cycle to prolong the life of the bulb.

## CLEANING TIPS

On the following pages, all removable parts on your range are shown. Refer to those pages when cleaning your range.

Warm water, a mild detergent and a soft cloth are safe to use on all cleanable parts of your range. Do not use metal scouring pads, except where recommended.

PART	CLEANING MATERIALS	REMARKS
Control panel and knobs	Detergent, warm water, soft cloth	Do not use abrasive cleaners. Knobs pull off for easier cleaning.
Glass	<p>Sears Cooktop Cleaning Creme® (Stock No. 40079) or other all-purpose non-abrasive cleaner, single-edge razor scraper, soft cloth</p> <p>Do not use a cooktop cleaner on a hot cooktop. The fumes can be hazardous to your health and can chemically attack the cooktop surface.</p> <p>If you accidentally melt anything on your cooktop, turn unit to LO; wipe hot cooktop immediately with several dry paper towels. Scrape off remainder of burned material with razor scraper (held in potholder) at 30° angle while unit is warm. Be careful not to burn yourself!</p>	<p>Correct and consistent cleaning is essential to maintaining your cooktop. If soil, mineral deposits from evaporated water spills or metal rub-off from aluminum cookware are not removed, they will burn onto the cooktop and cause permanent discoloration. Be sure that the cooktop is cool before cleaning. Do not use cooktop cleaner on a hot surface. The fumes can be hazardous to your health and can chemically attack the cooktop. Wipe surface clean after each use. Do not use a dish cloth or sponge to wipe up the cooktop. They may leave a film of detergent which can discolor your cooktop when heated. If this happens, remove the film with the recommended cleaner. We recommend that you use paper towels or a clean cloth which is used only for cooktop cleaning. After the cooktop has cooled, remove any crusty soil with the razor scraper. Hold the scraper at about a 30° angle to the cooktop and scrape off spot. Scrub cooktop with Sears Cooktop Cleaning Creme® or other all-purpose, non-abrasive cleaner. Rinse well and wipe dry. NEVER USE ANY ABRASIVE SCOURING PADS OR POWDERS ON YOUR COOKTOP. Plastic mesh pads, such as Doble®, may be used.</p>
Oven interior	Detergent, warm water and/or soap-filled steel wool pad; do not use oven cleaner in or around any part of the oven	Cleaning inside the oven need only be done as an optional touch-up between self-clean cycles. Rinse oven interior thoroughly after cleaning.
Oven door gasket	Hydrogen peroxide	Soak with hydrogen peroxide, using a sponge. Frequent soaking helps prevent soil buildup. Do not rub. See self-clean section for more information.
Oven racks	Detergent, warm water, scouring pad or soap-filled steel wool pad	Remove from oven to clean. Rinse thoroughly.
Broiler pan and grid	Detergent, warm water, soap-filled scouring pad, plastic scouring pad, commercial oven cleaner (pan only)	Remove soiled pan from oven to cool. Drain fat or drippings. Fill pan with warm water. Sprinkle grid with detergent and cover with damp cloth or paper towels. Let pan and grid soak for a few minutes. Rinse or scour as needed. Dry well. Pan and grid may be washed in a dishwasher.



## REMOVABLE OVEN RACKS

Be careful not to scratch the oven finish when installing or removing oven racks.

To install:

1. Set the raised back edge of the rack on a pair of rack guides.
2. Push the rack in until you reach the bump in the rack guide, then lift the front of the rack and push the rack all the way in.

To remove:

1. Pull the oven rack out, then up.

Some models have one standard oven rack and one folding oven rack.

The folding rack can be easily stored away when not in use.

**NOTE:** For best performance, remove oven racks during a clean cycle. If oven racks are left in the range during a self-clean cycle, they will darken, lose their luster and become hard to slide. If you choose to leave the racks in the oven, you can polish the edges of the racks with steel wool and apply a small amount of vegetable oil to the rack edges after the self-clean cycle.

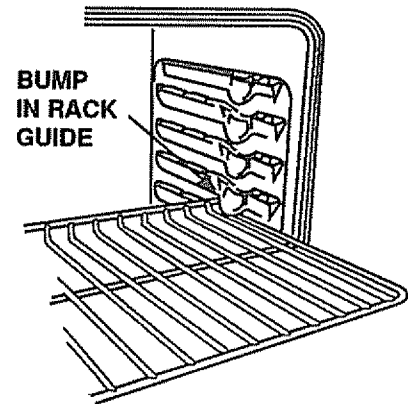

## REMOVABLE OVEN DOOR

To remove:

1. Open the door to the stop position (see illustration).
2. Grasp the door at each side and lift up and off the hinges.

**NOTE:** When the door is removed and hinge arms are at stop position, do not bump or try to remove the hinge arms. The hinges could snap back causing an injury to the hands or damage to the porcelain on the front of the range. Cover the hinges with toweling or empty towel rolls while working in the oven area.

2. Slide the door down onto the hinges as far as it will go and close the door.

STOP (BROIL) POSITION

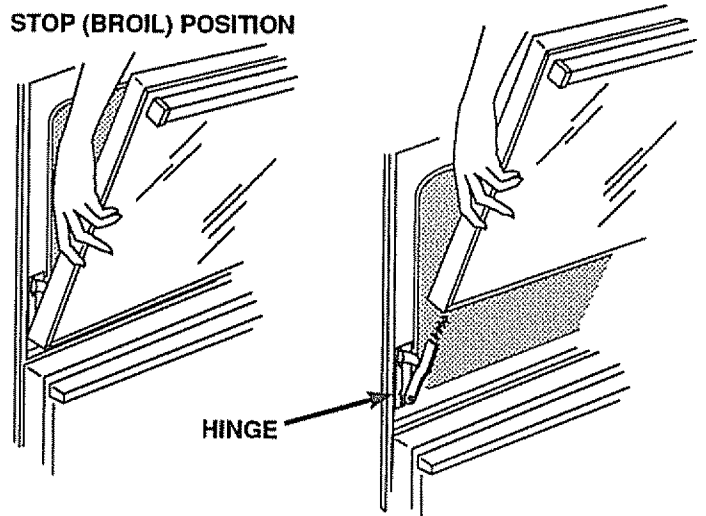

To replace:

1. Hold the door over the hinges with the slots at the bottom edge of the door lined up with the hinges. The hinge arms must still be in the stop position.

## REMOVABLE STORAGE DRAWER

This drawer gives you space for keeping cookware and bakeware. Plastics and flammable material should not be kept in this drawer.

Do not overload the storage drawer. If the drawer is too heavy, it may slip off the track when opened. To open the drawer, grasp the center of the handle and pull straight out.

**To remove:** Pull drawer straight out and lift over the guide stops.

**To replace:** Lift over the guide stops and slide drawer into place.

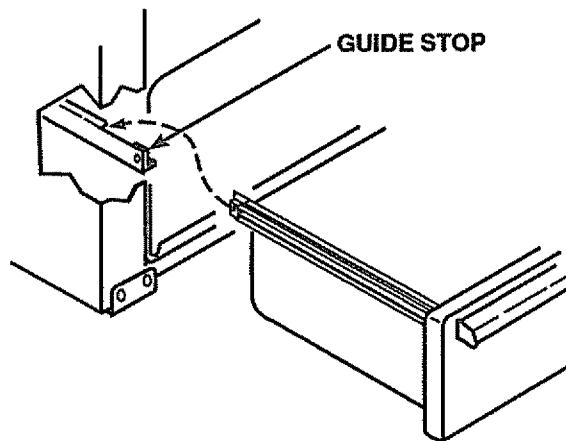

---

## REPLACING THE OVEN LIGHT

Be sure that the light switch is in the off position.

Do not touch hot oven bulb. Do not touch oven bulb with wet hands. Do not wipe oven light area with wet cloth.

Never touch the electrically live collar on the bulb when replacing it.

Electrical power must be shut off if you have to replace a broken bulb.

1. Unscrew glass cover and remove.
2. Replace the bulb with a 40 watt appliance bulb.
3. Replace the cover.

**Note:** We recommend you use a 40 watt appliance bulb that is no longer than 3 1/2".

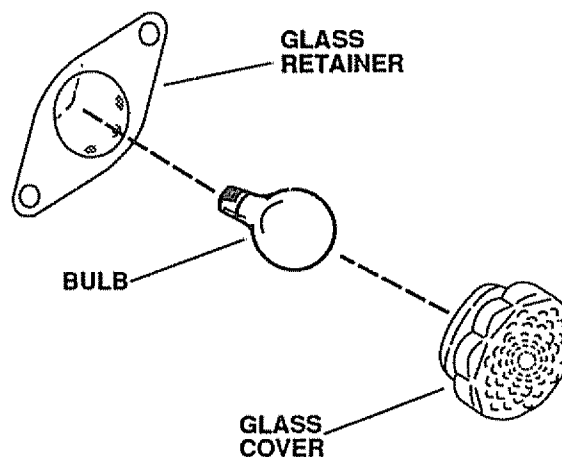

## REMOVABLE KNOBS

All control knobs may be removed for easy cleaning by pulling the knob straight off the stem. Be sure that the knob is in the OFF position before removal.

Hint: Slip a thin cloth (such as a handkerchief) or a piece of string under and around the knob edge and pull up.

**Caution:** Read these instructions carefully before replacing the knobs. Replacing the knobs improperly will damage the knobs and the spring clip on the stems. If this happens, the knobs will fit loosely.

### To replace the knob:

1. The knob stem has a groove in each side. The groove on one side has a spring clip. The other groove is clear (see illustration).

2. Check the inside of the knob and find the molded rib.
3. Replace the knob by fitting the molded rib inside the knob into the clear groove on the stem.

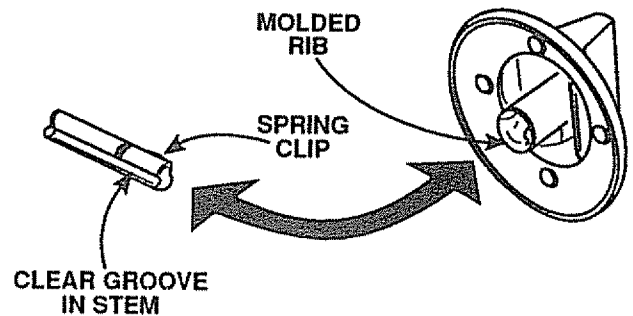

**Note:** Be sure to replace knobs on correct stems from which they came.

## ANTI-TIP DEVICE



If your range is removed for cleaning, servicing or any reason, be sure anti-tip device is re-engaged properly when the range is replaced. Failure to take this precaution could result in tipping of the range and cause injury.

When replacing the range:

1. Hook the loose end of the chain onto the bracket by slipping the nearest link of the chain into the slot in the bracket, making sure the chain is pulled as tight as possible and that there is no excess slack in the chain after chain is attached to the bracket.
  - Excess slack in the chain could allow the range to tip over.
2. Slide the range all the way back into the counter. Once the range is pushed back in place, there will be a small amount of slack in the chain. This is normal.

**NOTE:** To insure the device is installed and re-engaged properly, carefully try to tip the range forward. The device should secure the range and not allow it to tip.

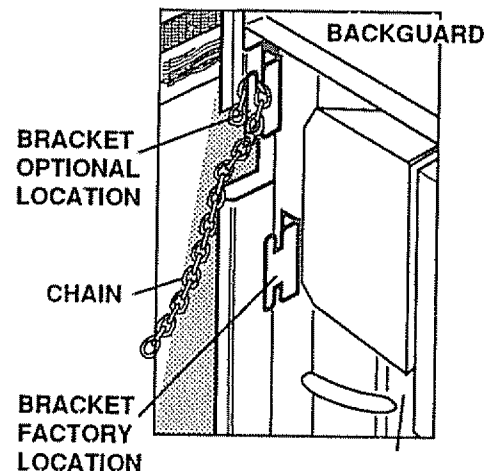

(Electric model shown;  
Opposite side used for Gas models)

# BEFORE CALLING FOR SERVICE

Save time and money - Check this list before you call for service.

To eliminate unnecessary service calls, first, read all the instructions in this manual carefully. Then, if you have a problem, always check this list of common problems and possible solutions before you call for service.

If you do have a problem you cannot fix yourself, call your nearest Sears Store or Service Center for help. When calling, have this manual and your Repair Parts List handy with the model, serial number and purchase date.

PROBLEM	POSSIBLE CAUSE	DON'T CALL FOR SERVICE UNTIL YOU CHECK
<ul style="list-style-type: none"> <li>Tiny scratches or abrasions on cooktop</li> </ul>	<ul style="list-style-type: none"> <li>Use of incorrect cleaning materials</li> <li>Coarse particles (salt, etc.) between cookware bottoms and cooktop. Be sure cookware bottoms and cooktop are clean before use</li> <li>Cookware with rough bottoms</li> </ul>	<ul style="list-style-type: none"> <li>Tiny scratches are not removable and do not affect cooking. In time, the scratches will become smoother and less visible.</li> </ul>
<ul style="list-style-type: none"> <li>Metal marking on cooktop</li> </ul>	<ul style="list-style-type: none"> <li>Sliding or scraping metal utensils and cookware across cooktop</li> </ul>	<ul style="list-style-type: none"> <li>Use recommended cooktop cleaners.</li> </ul>
<ul style="list-style-type: none"> <li>Foods do not broil properly</li> </ul>	<ul style="list-style-type: none"> <li>Improper rack position</li> <li>Oven preheated</li> <li>Improper utensil used</li> <li>Oven door closed during broil</li> </ul>	<ul style="list-style-type: none"> <li>Check broil pan placement. See broiling section.</li> <li>Do not preheat when broiling.</li> <li>Use broiler pan and grid supplied with range.</li> <li>Open door to broil stop position; see removable oven door section.</li> </ul>
<ul style="list-style-type: none"> <li>Oven smokes</li> </ul>	<ul style="list-style-type: none"> <li>Improper broiling time</li> <li>Dirty oven</li> <li>Broiler pan containing grease left in oven</li> </ul>	<ul style="list-style-type: none"> <li>Check broiling chart in broiling section.</li> <li>Check for heavy spillover.</li> <li>Clean pan and grid after each use.</li> </ul>
<ul style="list-style-type: none"> <li>Oven light does not work</li> </ul>	<ul style="list-style-type: none"> <li>Light switch in off position</li> <li>Light bulb burned out</li> </ul>	<ul style="list-style-type: none"> <li>Check switch setting; see operating instructions.</li> <li>Check or replace light bulb; see use and care instructions.</li> </ul>
<ul style="list-style-type: none"> <li>Oven does not clean or poor cleaning results (self-clean models only)</li> </ul>	<ul style="list-style-type: none"> <li>Controls not set properly</li> <li>Clean cycle interrupted too soon</li> <li>Oven too dirty</li> </ul>	<ul style="list-style-type: none"> <li>Check self-clean instructions.</li> <li>Heavily soiled ovens require a 3-1/2 hour clean cycle.</li> <li>Heavy spillovers should be removed before setting clean cycle. Repeat clean cycle.</li> </ul>
<ul style="list-style-type: none"> <li>Oven door will not open</li> </ul>	<ul style="list-style-type: none"> <li>Clean cycle not complete</li> </ul>	<ul style="list-style-type: none"> <li>Oven must cool below lock temperature</li> </ul>
<ul style="list-style-type: none"> <li>Repeating tone does not sound</li> </ul>	<ul style="list-style-type: none"> <li>Tone has been altered by pushing and holding CLEAR/OFF button</li> </ul>	<ul style="list-style-type: none"> <li>Push and hold CLEAR/OFF button to activate tone.</li> </ul>

## Before Calling for Service

PROBLEM	POSSIBLE CAUSE	DON'T CALL FOR SERVICE UNTIL YOU CHECK
<ul style="list-style-type: none"> <li>Dark streaks and specks on cooktop</li> </ul>	<ul style="list-style-type: none"> <li>Encrusted boilovers or grease spatters</li> <li>Incorrect cleaning materials</li> </ul>	<ul style="list-style-type: none"> <li>Use razor scraper and follow directions in cleaning chart.</li> <li>Use recommended cleaners in cleaning chart.</li> </ul>
<ul style="list-style-type: none"> <li>Areas of discoloration on cooktop</li> </ul>	<ul style="list-style-type: none"> <li>Mineral deposits from water or food</li> </ul>	<ul style="list-style-type: none"> <li>Use recommended cleaners.</li> </ul>
<ul style="list-style-type: none"> <li>Range does not work; totally inoperative</li> </ul>	<ul style="list-style-type: none"> <li>No power to range</li> </ul>	<ul style="list-style-type: none"> <li>Check household circuit breaker or fuse.</li> <li>Check power cord to be sure it is plugged in.</li> </ul>
<ul style="list-style-type: none"> <li>Oven does not heat; cooktop zones OK</li> </ul>	<ul style="list-style-type: none"> <li>Clock set incorrectly</li> <li>Oven controls set incorrectly</li> </ul>	<ul style="list-style-type: none"> <li>Check clock instructions.</li> <li>Check oven control instructions.</li> </ul>
<ul style="list-style-type: none"> <li>Cooktop zone does not work; oven OK</li> </ul>	<ul style="list-style-type: none"> <li>Improper operation of control</li> </ul>	<ul style="list-style-type: none"> <li>Be sure knob is pushed in while turning.</li> </ul>
<ul style="list-style-type: none"> <li>Foods cook slowly on the cooktop</li> </ul>	<ul style="list-style-type: none"> <li>Improper cookware</li> </ul>	<ul style="list-style-type: none"> <li>Use pans that have flat bottoms and a tight fitting lid (if applicable). Pans should match cooking zone size. Read the cooktop cooking section for complete information.</li> </ul>
<ul style="list-style-type: none"> <li>Foods do not bake properly</li> </ul>	<ul style="list-style-type: none"> <li>Oven not preheated long enough</li> <li>Improper rack or pan placement</li> <li>Oven vent blocked or covered</li> <li>Improper use of foil</li> <li>Improper temperature setting for utensil used</li> <li>Recipe not followed</li> <li>Improper thermostat calibration</li> <li>Range and oven rack not level</li> <li>Using improper cookware</li> </ul>	<ul style="list-style-type: none"> <li>Be sure to preheat: Until notification tone sounds.</li> <li>Maintain uniform air space around pans and utensils; see oven cooking section.</li> <li>Keep vent area clear.</li> <li>Foil use not recommended.</li> <li>Reduce temperature 25 degrees for glass or dull/darkened pans.</li> <li>Is recipe tested and reliable?</li> <li>Check oven temperature adjustment procedures (next page).</li> <li>Check the installation section for leveling instructions.</li> <li>See cooking hints section.</li> </ul>
<ul style="list-style-type: none"> <li>Range display is flashing "F" and a number; oven stops working - surface works</li> </ul>	<ul style="list-style-type: none"> <li>Possible range malfunction</li> </ul>	<ul style="list-style-type: none"> <li>Press CLEAR/OFF. Let range cool down for one hour. Place range back into cooking or cleaning cycle. If problem repeats, call for service.</li> </ul>
<ul style="list-style-type: none"> <li>Oven temperature seems inaccurate</li> </ul>	<ul style="list-style-type: none"> <li>Thermostat Calibration</li> </ul>	<ul style="list-style-type: none"> <li>See adjustments described following this section.</li> </ul>
<ul style="list-style-type: none"> <li>Fan comes on during bake, broil or clean</li> </ul>	<ul style="list-style-type: none"> <li>This is normal operation of a fan designed to cool the range's internal components</li> </ul>	<ul style="list-style-type: none"> <li>Fan should turn OFF after the internal components have cooled.</li> </ul>

## ADJUSTING OVEN TEMPERATURE

The temperature in your new oven has been set correctly at the factory, so be sure to follow the recipe temperatures and cooking times the first few times you bake in your oven.

If you think the oven should be hotter or cooler, you can adjust the oven temperature yourself. To decide how much to change the temperature, set the oven temperature 25°F higher or lower than the temperature in your recipe, then bake. The results of this "test" should give you an idea of how much the temperature should be changed.

To adjust temperature follow these instructions:

1. Push **BAKE**.
2. Select a temperature between 500°F and 550°F by pressing the UP arrow. See Fig. 1.

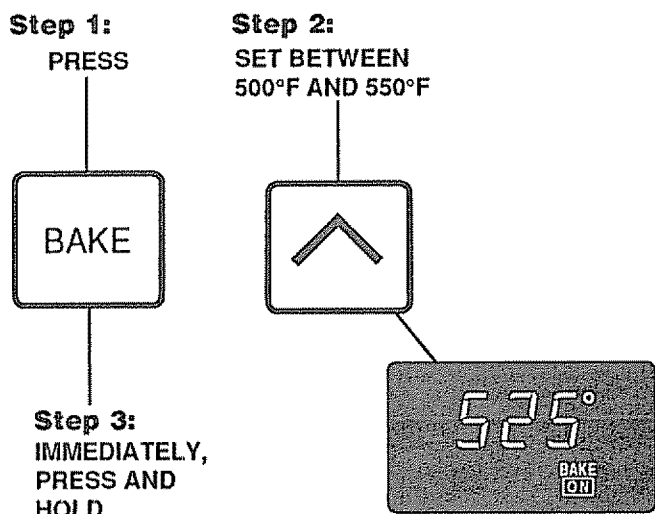

Fig. 1

3. IMMEDIATELY, press **BAKE** again and hold for about 4 seconds. This display will show "ON" and "BAKE" will flash in the display. See Fig. 2.

Continue to hold **BAKE** until the display changes to show the preset oven display. See Fig. 3.

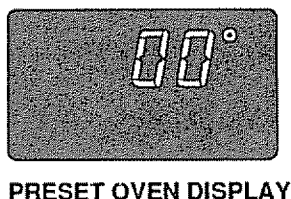

Fig. 2

4. The temperature can be adjusted up to +35°F hotter or -35°F cooler. Use the UP or Down arrow to select the temperature adjustment you want. See Fig. 3. The temperature you select is the new preset oven display.

Step 4:

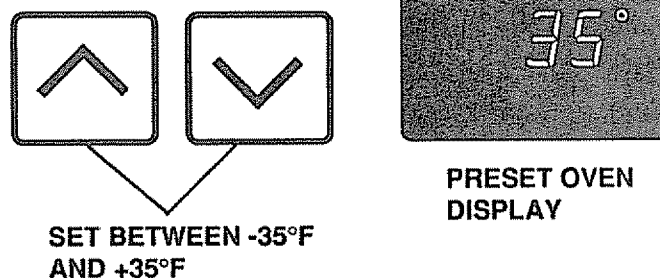

Fig. 3

**NOTE:**

This adjustment will not affect Broil or Clean temperatures. It will be remembered when power is removed.

5. When you have made the adjustment, push **CLOCK** to return the display to the time of day. Use your oven as you would normally.

Step 5:



# NOTES

# KENMORE ELECTRIC RANGE WARRANTY

Dear Customer:

Our constant efforts are directed toward making sure your new Kenmore Range will arrive at your home in perfect condition and will give you proper performance. As part of these efforts, we feel it is our responsibility to provide you with this warranty for your range.

## FULL ONE YEAR WARRANTY ON THE FUNCTIONING OF ALL PARTS EXCEPT GLASS PARTS

If, within one year from the date of installation, any part, other than a glass part, fails to function properly due to a defect in material or workmanship, Sears will repair or replace it, free of charge.

## FULL 30-DAY WARRANTY ON GLASS PARTS AND FINISH OF PORCELAIN ENAMEL, PAINTED OR BRIGHT METAL FINISHED PARTS

If, within 30 days from the date of installation, any glass part or the finish on any porcelain enamel, painted or bright metal part is defective in material or workmanship, Sears will replace the part, free of charge.

## FULL 90-DAY WARRANTY ON MECHANICAL ADJUSTMENTS

For 90 days from the date of installation, Sears will provide, free of charge, any mechanical adjustments necessary for proper operation of the range, except for normal maintenance.

If the range is subjected to other than private family use, the above warranty coverage is effective for only 90 days.

## WARRANTY SERVICE IS AVAILABLE BY CONTACTING THE NEAREST SEARS SERVICE CENTER/DEPARTMENT IN THE UNITED STATES

This warranty applies only while this product is in use in the United States. This warranty gives you specific legal rights, and you may also have other rights which vary from state to state.

**SEARS, ROEBUCK and CO.**  
Dept. 731 CR-W  
Sears Tower  
Chicago, IL 60684

## WE SERVICE WHAT WE SELL

"We Service What We Sell" is our assurance to you that you can depend on Sears for service because Sears service is nationwide.

Your Kenmore Range has added value when you consider that Sears has a service unit near you staffed by Sears trained technicians. . . professional technicians specifically trained on Sears appliances, having the parts, tools and equipment to ensure that we meet our pledge to you — "We Service What We Sell!"

**TO FURTHER ADD TO THE VALUE OF YOUR RANGE, BUY A SEARS MAINTENANCE AGREEMENT.**

Kenmore Ranges are designed, manufactured and tested for years of dependable operation. Yet, any modern appliance may require service from time to time. The Sears warranty plus the Sears Maintenance Agreement provides protection from unexpected repair bills and assures you of enjoying maximum range efficiency.

Here's a comparative warranty and Maintenance Agreement chart showing you the benefits of a Sears Range Maintenance Agreement.

Years of Ownership Coverage		1st Year	2nd Year	3rd Year
1	Replacement of Defective Parts other than Porcelain or Glass	W	MA	MA
2	Mechanical Adjustment	90 DAYS W	MA	MA
3	Porcelain and Glass Parts	30 DAYS W	MA	MA
4	Annual Preventive Maintenance Check at your request	MA	MA	MA

W - Warranty MA - Maintenance Agreement

**CONTACT YOUR SEARS SALESPERSON OR LOCAL SEARS SERVICE CENTER TODAY AND PURCHASE A SEARS MAINTENANCE AGREEMENT.**

# Kenmore® America's Best Selling Appliance Brand

Sold by SEARS, ROEBUCK AND CO., Chicago, IL 60684



## Free Manuals Download Website

<http://myh66.com>

<http://usermanuals.us>

<http://www.somanuals.com>

<http://www.4manuals.cc>

<http://www.manual-lib.com>

<http://www.404manual.com>

<http://www.luxmanual.com>

<http://aubethermostatmanual.com>

Golf course search by state

<http://golfingnear.com>

Email search by domain

<http://emailbydomain.com>

Auto manuals search

<http://auto.somanuals.com>

TV manuals search

<http://tv.somanuals.com>