

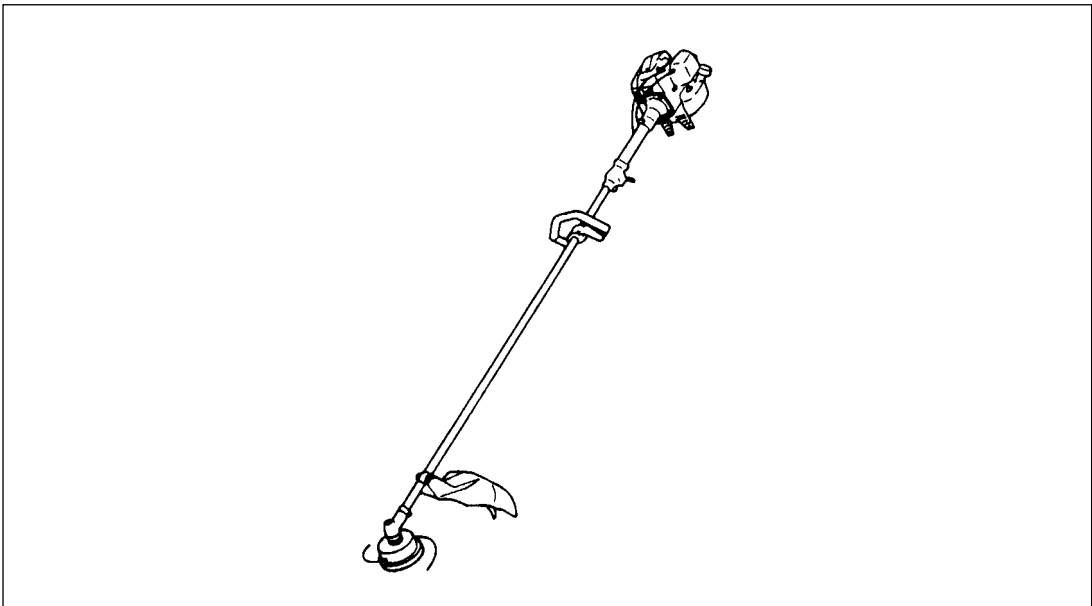

OWNER/OPERATOR MANUAL

BRUSHCUTTERS

BC2601DL



WARNING



The engine exhaust from this product contains chemicals known to the State of California to cause cancer, birth defects or other reproductive harm.

Thank you for purchasing a RedMax product.

Before using our brushcutters, please read this manual carefully to understand the proper use of your unit.

APPLICABLE SERIAL NUMBERS :

DRIVE UNIT 900101 and up

ENGINE UNIT 900101 and up



Read this manual carefully to understand all safety precautions, controls, proper operation and maintenance of your RedMax brushcutters. Failure to do so could result in serious injury.



SAFETY FIRST

Instructions contained in warnings within this manual marked with a  symbol concern critical points which must be taken into consideration to prevent possible serious bodily injury, and for this reason you are requested to read all such instructions carefully and follow them without fail.

Note that there may be times when warning seals peel off or become soiled and impossible to read. If this happens, you should contact the dealer from which you purchased the product to order new seals and affix the new seal(s) in the required location(s).

■ Notes on types of warnings



Instructions labeled as shown at left, concern critical steps or procedures which must be followed in order to prevent accidents which could lead to serious bodily injury or death. This mark is used to indicate instructions which must be followed without exception.



Instructions labeled as shown at left concern steps or procedures which, if not followed correctly, could lead to mechanical failure, breakdown, or damage.



Used to label supplementary instructions designed to provide hints or directions useful in the use of the product.

CONTENTS

SAFETY PRECAUTIONS	4
IN ORDER TO ENSURE PROPER AND SAFE OPERATION OF YOUR BRUSHCUTTER	
WORK GEAR AND CLOTHING	
WARNINGS CONSIDERING HANDLING OF FUEL	
THINGS TO CHECK BEFORE USING YOUR BRUSHCUTTER	
THINGS TO CHECK BEFORE STARTING UP THE ENGINE	
AVOID NOISE PROBLEM	
THINGS TO BE CAREFUL ABOUT WHEN USING YOUR BRUSHCUTTER	
NOTES ON CARE AND MAINTENANCE OF YOUR BRUSHCUTTER	
SET UP	9
MOUNTING ENGINE	
INSTALLING HANDLE	
INSTALLING DEBRIS GUARD	
CONNECTING THROTTLE WIRE	
CONNECTING SWITCH WIRES	
PUTTING ON WAIST PAD	
INSTALLING CUTTING HEAD	
FUEL	10
HOW TO MIX FUEL	
FUELING THE UNIT	
OPERATION	11
STARTING ENGINE	
STOPPING ENGINE	
ADJUSTING IDLING SPEED	
LINE HEAD USAGE	
METAL BLADE USAGE	
MAINTENANCE	15
REFILLING TRIMMING LINE	
AIR FILTER	
FUEL FILTER	
SPARK PLUG	
MUFFLER	
SPARK ARRESTER	
GEAR CASE	
STORAGE	17
SPECIFICATIONS	18
PARTS LIST	19



Safety Precautions

■ In order to ensure proper and safe operation of your brushcutter

- Read this Owner/Operator Manual carefully. Be sure you understand how to operate this unit properly before you use it. Failure to do so could result in serious injury.



- Be sure to keep this manual handy so that you may refer to it later whenever any questions arise. Also note that you are requested to contact the dealer from whom you purchased the product for assistance in the event that you have any questions which cannot be answered herein.
 - Always be sure to include this manual when selling, lending, or otherwise transferring the ownership of this product.
- This product has been designed for use in cutting grass, and it should never be used for any other purpose since doing so could result in unforeseen accidents and injuries occurring.
 - You should never use this brushcutter when under the influence of alcohol, when suffering from exhaustion or lack of sleep, when suffering from drowsiness as a result of having taken cold medicine, or at any other time when a possibility exists that your judgment might be impaired or that you might not be able to operate the brushcutter properly and in a safe manner. Also be sure never to allow children or anyone unable to fully understand the directions given in this manual to use this brushcutter.



- Avoid running the engine indoors. The exhaust gases contain harmful carbon monoxide.

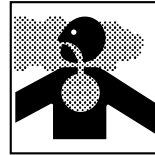

- Never use your brushcutter under circumstances like those described below:
 1. When the ground is slippery or when other conditions exist which might make it not possible to maintain a steady posture while using the brushcutter.
 2. At night, at times of heavy fog, or at any other times when your field of vision might be limited and it would be difficult to gain a clear view of the area where the brushcutter is to be used to ensure safety.
 3. During rain storms, during lightning storms, at times of strong or gale-force winds, or at any other times when weather conditions might make it unsafe to use this product.
- When using this product for the first time, before beginning actual work, take the brushcutter to a wide, clear, open space, turn on the power, and practice handling the brushcutter until you are sure that you will be able to handle it properly in actual operation.
- Lack of sleep, tiredness, or physical exhaustion results in lower attention spans, and this in turn leads to accidents and injury. When planning your work schedule, allow plenty of time to perform the work of cutting and allow plenty of time for rest. Limit the amount of time over which the brushcutter is to be used continuously to somewhere around 30~40 minutes per session, and take 10~20 minutes of rest between work sessions. Also try to keep the total amount of work performed in a single day under 2 hours or less.



Safety Precautions

■ Work gear and clothing

- When using your brushcutter, always be sure to wear strong, durable, work clothing; shirts should be long-sleeved shirts and pants should be full-length pants reaching down to the ankles.
- Always be sure to wear helmet and face protector when using your brushcutter.
- When using your brushcutter, always be sure to wear thick work gloves to protect your hands and non-slip-sole work boots to prevent you from slipping. Never use your brushcutter when wearing pants with loose cuffs, when wearing sandals, or when barefoot.
- When using your brushcutter for an extended period of time, you should wear ear protectors to protect yourself from loss of hearing from overexposure to high levels of sound.

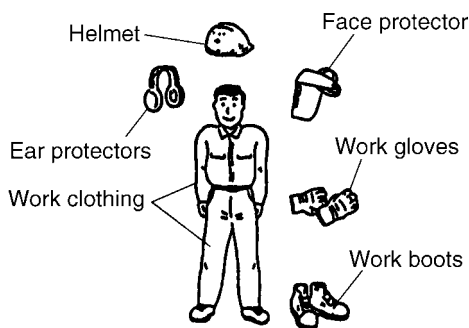

■ Warnings considering handling of fuel

- The engine of the RedMax® brushcutter is designed to run on a mixed fuel which contains highly flammable gasoline. This fuel is highly flammable and you should never store cans of fuel or refill the tank of the brushcutter in any place where there is a boiler, stove, wood fire, electrical sparks, welding sparks, or any other source of heat or fire which might ignite the fuel.



- Smoking while operating the brushcutter or refilling its fuel tank is extremely dangerous. Always be sure to keep lit cigarettes away from the brushcutter at all times.
- When refilling the tank, always turn off the engine first and take a careful look around to make sure that there are no sparks or open flames anywhere nearby before refueling.
- If any fuel spillage occurs during refueling, always be sure to use a dry rag to wipe any fuel which has been spilled onto the brushcutter before turning the engine back on again.
- After refueling, screw the fuel cap back tightly onto the fuel tank and then carry the brushcutter to a spot 10 feet (3m) or more away from where it was refueled before turning on the engine.



Safety Precautions

■ Things to check before using your brushcutter

- Before beginning work, look around carefully to get a feel for the shape of the land, grass to be trimmed, and whether or not there are any obstacles which might get in the way while working, and remove any obstacles before beginning work.
- The area within a perimeter of 50 feet (15m) of the person using the brushcutter should be considered a hazardous area into which no one should enter while the brushcutter is in use, and when necessary yellow warning rope, warning signs, or some other form of warnings should be placed around the perimeter of the area. When work is to be performed simultaneously by two or more persons, care should also be taken to constantly look around or otherwise check for the presence and locations of other people using brushcutters within the work area so as to maintain a distance between each person sufficient to ensure safety.
- Before beginning work, each component of the brushcutter should be checked to make sure that it is in proper working order and to make sure that there are no loose screws or bolts, fuel leaks, ruptures, dents, or any other problems which might interfere with safe operation. Be especially careful at this time to check that there is nothing wrong with the blades or with the joints by which the blades are attached to the brushcutter.

■ Things to check before starting up the engine

- Take a careful look around to make sure that no obstacles exist within a perimeter of 15 feet (5m) or less around the brushcutter before starting the engine.

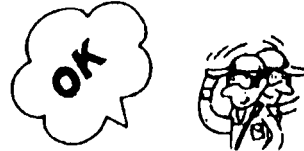

- The RedMax brushcutter is equipped with a centrifugal clutch mechanism which causes the cutting blades to begin to rotate as soon as the engine is started by putting the throttle into the start position. When starting the engine, place the body of the engine brushcutter onto the ground in a flat clear area and hold it firmly in place so as to ensure that neither the blades nor the throttle come into contact with any obstacles when the engine starts up.
- Never place the throttle into the high speed position when starting the engine.
- After starting up the engine, check to make sure that the blades stop rotating when the throttle is moved fully back to its original position. If the blades continue to rotate even after the throttle has been moved fully back, turn off the engine and take the unit to your authorized Red Max servicing dealer for repair.

■ AVOID NOISE PROBLEM

NOTE

Check and follow the local regulations as to sound level and hours of operations for brushcutter.

- In general, operate brushcutters between 8a.m. and 5p.m. on week days and 9a.m. to 5p.m. weekends. Avoid using brushcutter late at night and/or early in the morning.



Safety Precautions

■ Things to be careful about when using your brushcutter

- When using your brushcutter, grip the handles of the brushcutter firmly with both hands, place your feet slightly apart (slightly further apart than the width of your shoulders) so that your weight is distributed evenly across both legs, and always be sure to maintain a steady, even posture while working.
- Maintain the speed of the engine at the level required to perform cutting work, and never raise the speed of the engine above the level necessary.
- Always be sure never to allow other persons to come within the work area while cutting.
- Be especially careful not to slip if it is raining or if rain has just stopped, as the ground is likely to be slippery at such times.
- If the grass or other object gets caught in the blade during operation, always be sure to turn off the engine before removing the object.
- Guard against hazardous situations at all times. Warn adults to keep pets and children away from the area. Establish a safe method for gaining your attention during operation. Be careful if you are approached.
- If someone calls out or otherwise interrupts you while working, always be sure to turn off the engine before turning around.
- Keep operation area clear of all persons, particularly small children and pets. Injury may result from flying debris.
- Never touch the spark plug or plug cord while the engine is in operation. Doing so may result in being subjected to an electrical shock.



- Never touch the muffler, spark plug, or other metallic parts of the engine while the engine is in operation or immediately after shutting down the engine. These metallic parts reach high temperatures during operation and doing so could result in serious burns.



- When you finish cutting in one location and wish to continue work in another spot, turn off the engine, place the protective cover over the blades, and turn the brushcutter so that the blade face away from your body before carrying it to the new location.
- Never transport the brushcutter over rough roads over long distances without removing all fuel from the fuel tank. If doing so, fuel might leak from the tank during transport.



Safety Precautions

■ Notes on care and maintenance of your brushcutter

- In order to maintain your brushcutter in proper working order, perform the maintenance and checking operations described in this manual at regular intervals. In the event that any parts must be replaced or any maintenance or repair work not described in this manual must be performed, please contact a representative from the store nearest RedMax authorized servicing dealer for assistance.
- Under no circumstances should you ever take apart the brushcutter or alter it in any way. Doing so might result in the brushcutter becoming damaged during operation or the brushcutter becoming unable to operate properly.
- Always be sure to turn off the engine before performing any maintenance or checking procedures.
- When sharpening, removing, or reattaching the blade, be sure to wear thick, sturdy gloves and use only proper tools and equipment to prevent injury.
- When replacing blade or any other parts or when replacing the oil or any lubricants, always be sure to use only RedMax products or products which have been certified by RedMax for use with the RedMax brushcutter.
- Do not use any accessory or attachment other than those bearing the RedMax mark and recommended for the unit.

Set up

■ MOUNTING ENGINE

1. Loosen the bolts temporarily attached to the clutch housing.
2. Push the driveshaft toward the gearcase and rotate it by hand to check that the driveshaft is engaged with the gears.
3. Insert the shaft tube into the clutch housing until it bottoms. When difficult to engage, twist the engine slightly.
4. Align the positioning holes on the clutch housing and the shaft tube and fit the boss on the clamp into the holes. And fasten the bracket with 2 bolts securely.

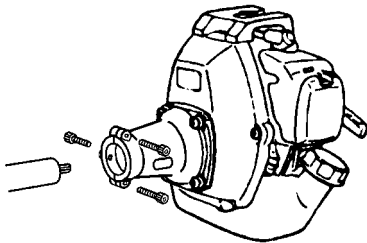

■ INSTALLING HANDLE

- Mount the handle to the shaft tube and clamp it at your best operating position.

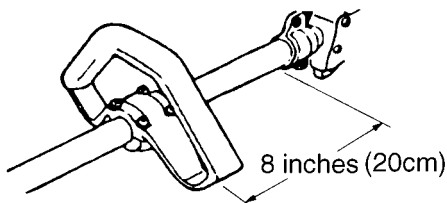

■ INSTALLING DEBRIS GUARD

- Put the debris guard on the shaft tube near the gear box, attach it with the 2 screws and hardware provided.

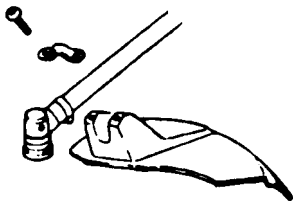

■ CONNECTING THROTTLE WIRE

1. Remove the air cleaner cover.

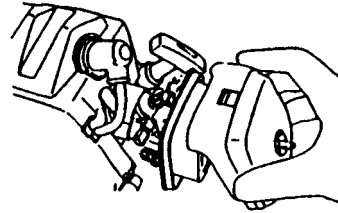

2. Connect the end of the throttle wire to the joint on the top of the carburetor.

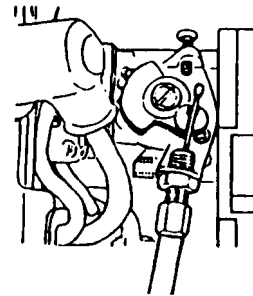

■ CONNECTING SWITCH WIRES

- Connect the switch wires between the engine and the main unit. Pair the wires of the same color.

■ INSTALLING CUTTING HEAD

1. While locking the gear shaft by inserting the attached bar into the upper holder and the gear box, loosen and remove the hexagon bolt(left-handed)
2. Fit the spacer attached to the head assembly between the upper and lower holders. Then screw in the cutting head to the gear shaft over the holders. Hand-tighten it securely.

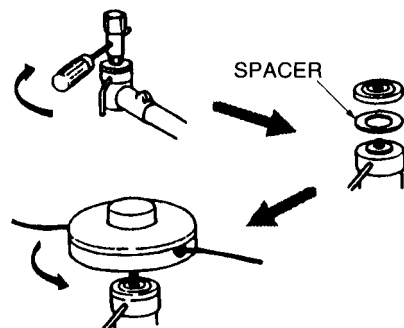

Fuel

⚠ WARNING

- **Gasoline is very flammable. Avoid smoking or bringing any flame or sparks near fuel. Make sure to stop the engine and allow it cool before refueling the unit. Select outdoor bare ground for fueling and move at least 3m(10ft) away from the fueling point before starting the engine.**



- The RedMax engines are lubricated by oil specially formulated for air-cooled 2-cycle gasoline engine use. If RedMax oil is not available, use an anti-oxidant added quality oil expressly labeled for air-cooled 2-cycle engine use.

RECOMMENDED MIXING RATIO GASOLINE 32:OIL 1



- **Exhaust emission are controlled by the fundamental engine parameters and components(eq., carburation, ignition timing and port timing) without addition of any major hardware or the introduction of an inert material during combustion.**

32:1 MIXING CHART

GASOLINE	gal.	1	2	3	4	5
2-CYCLE OIL	fl.oz	4	8	12	16	20

GASOLINE	liter	1	2	3	4	5
2-CYCLE OIL	ml	32	64	96	128	160

- These engines are certified to operate on unleaded gasoline.
- Make sure to use gasoline with a minimum octane number of 90 ROZ(USA/Canada : pump octane min.87)
- Unleaded gasoline is recommended to reduce the contamination of the air for the sake of your health and the environment.

- Poor quality gasolines or oils may damage sealing rings, fuel lines or fuel tank of the engine.

■ HOW TO MIX FUEL

1. Measure out the quantities of gasoline and oil to be mixed.
2. Put some of the gasoline into a clean, approved fuel container.
3. Pour in all of the oil and agitate well.
4. Pour in the rest of gasoline and agitate again for at least one minute.
5. Put a clear indication on the outside of the container to avoid mixing up with gasoline or other containers.
6. Indicate the contents on outside of container for easy identification.

■ FUELING THE UNIT

1. Untwist and remove the fuel cap. Rest the cap on a dustless place.
2. Put fuel into the fuel tank to 80% of the full capacity.
3. Fasten the fuel cap securely and wipe up any fuel spillage around the unit.

⚠ WARNING

1. Select bare ground for fueling.
2. Move at least 10 feet (3 meters) away from the fueling point before starting the engine.
3. Stop the engine before refueling the unit.

FOR YOUR ENGINE LIFE, AVOID;

1. **FUEL WITH NO OIL(RAW GASOLINE)** – It will cause severe damage to the internal engine parts very quickly.
2. **GASOHOL** – It can cause deterioration of rubber and/or plastic parts and disruption of engine lubrication.
3. **OIL FOR 4-CYCLE ENGINE USE or WATER COOLED 2-CYCLE ENGINE USE** – It can cause spark plug fouling, exhaust port blocking, or piston ring sticking.
4. **Mixed fuels which have been left unused for a period of one month or more** may clog the carburetor and result in the engine failing to operate properly.

Operation

■ STARTING ENGINE

1. Rest the unit on a flat, firm place. Keep the cutting head off the ground and clear of surrounding objects as it will start rotating upon starting of the engine.
2. Pump the primer until fuel flows out in the clear tube.

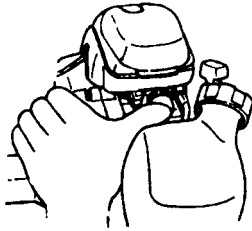

3. Move the choke lever upward to close the choke.

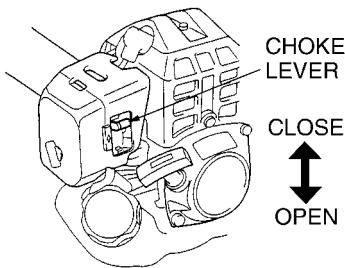

4. Shift the ignition switch to the START position.

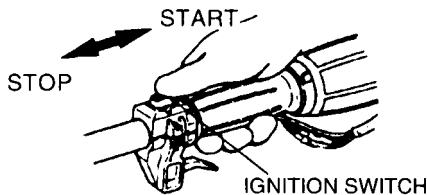

5. While pulling the throttle lever with the little finger of your left hand, pull the starter rope.

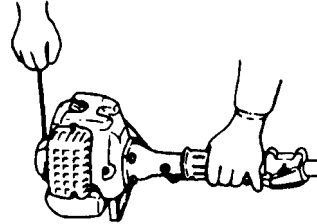

NOTE

- Avoid pulling the rope to its end or returning it by releasing the knob. Such actions can cause starter failures.

6. When the engine has started, move the choke lever gradually downward to open the choke.

7. Allow the engine to warm up for a half minute before starting operation.

NOTE

1. When restarting the engine immediately after stopping it, leave the choke open.
2. Overchoking can make the engine hard to start due to excess fuel. When the engine failed to start after several attempts, open the choke and repeat pulling the rope, or remove the spark plug and dry it.

Operation

■ STOPPING ENGINE

1. Release the throttle lever and run the engine for a half minute.
2. Shift the ignition switch to the STOP position.

NOTE

- Except for an emergency, avoid stopping the engine while pulling the throttle lever.

■ ADJUSTING IDLING SPEED

1. When the engine tends stop frequently at idling mode, turn the adjusting screw clockwise.
2. When the cutting head keeps rotating after releasing the trigger, turn the adjusting screw counter-clockwise.

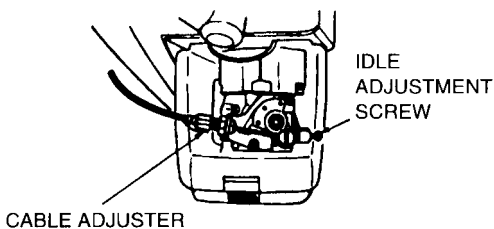

NOTE

- Warm up the engine before adjusting the idling speed.

■ LINE HEAD USAGE

⚠ WARNING

1. Always wear eye protection such as safety goggles. Never lean over the rotating cutting head. Rocks or other debris could be thrown into eyes and face and cause serious personal injury.
2. Keep the debris guard attached in place at all times when the unit is operated.

TRIMMING GRASS AND WEEDS

- Always remember that the TIP of the line does cutting. You will achieve better results by not crowding the line into the cutting area. Allow the unit to trim at its own pace.

1. Hold the unit so the head is off the ground and is tilted about 20 degrees toward the sweep direction.
2. Use full throttle when cutting.
3. You can avoid thrown debris by sweeping from your left to the right.
4. Use a slow, deliberate action to cut heavy growth. The rate of cutting motion will depend on the material being cut. Heavy growth will require slower action than will light growth.
5. Never swing the unit so hard as you are in danger of losing your balance or control of the unit.
6. Try to control the cutting motion with the hip rather than placing the full workload on the arm and hands.
7. Take precautions to avoid wire, grass and dead, dry, long-stem weeds from wrapping around the head shaft. Such materials can stall the head and cause the clutch to slip, resulting in damage to the clutch system if repeated frequently.

ADJUSTING THE LINE LENGTH

- Your brushcutters is equipped with a semi-auto type nylon line head that allows the operator to advance the line without stopping the engine. When the line becomes short, lightly tap the head on the ground while running the engine at full throttle.
- Each time the head is bumped, the line advance about 1 inch(25.4 mm). For better effect, tap the head on bear ground or hard soil. Avoid bumping in thick, tall grass as the engine may stall by overload.

Operation

■ METAL BLADE USAGE

- Always cut by guiding the head from your right to left.
- When moving a wide area, start working from the left side to avoid interference of cut grass.
- A metal blade cut best up to the point 1/3 from the edge. Use that area for cutting shrubs, tough and thick weeds. For cutting young grass, you can use up to 2/3 from the tip of blade.

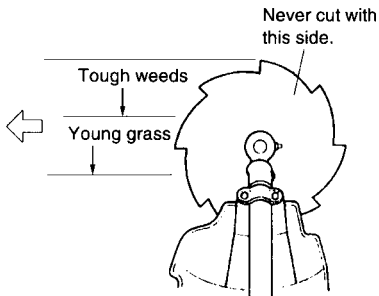

NOTE

Do not use the Metal Cutting Blade for cutting trees or thick branches. The blade is designed to cut grass, weeds or shrubs only.



Working on a slope increases the danger of losing your balance. Do not use your unit on a slope until you have mastered its operation.

FOR SAFE OPERATION ON A SLOPE:

1. Always use anti-slip shoes.
2. Do not work in and/or right after the rain when the ground is wet and slippery.
3. Do not use your unit on a slope where firm footholds are not secured.
4. Do not cut material above you waist or below your ankle.
5. Be sure to stop the engine before moving to the next row.



The operator must keep his own path of advance clear due to the possibility of swinging around and seriously injuring a bystander or helper.

CONTROLLING BLADE BOUNCE

- Blade bounce can cause serious personal injury. **Carefully study this section.** It is important that you understand what causes bounce, how you can reduce the chance of bounce and how you can remain in control of the unit if bounce does occur.

1. What causes blade bounce:

- Bounce can occur when the moving blade contacts an object that it cannot cut. This contact causes the blade to stop for an instant and then suddenly move or "bounce" away from the object that was hit. The operator can lose control of the unit and the blade can cause serious personal injury to the operator or any person nearby if the blade contacts any part of the body.

2. How you can reduce the chance of blade bounce:

- a. Recognize that bounce can happen. By understanding and knowing about bounce, you can help eliminate the element of surprise.
- b. Cut fibrous weeds and grass only. Do not let the blade contact materials it cannot cut such as hard, woody vines and brush or rocks, fences, metal, etc
- c. Be extra prepared for bounce if you must cut where you cannot see the blade making contact such as in areas of dense growth.
- d. Keep the blade sharp. A dull blade increase the chance of bounce.
- e. Cut only at full throttle.
- f. Avoid feeding the blade too rapidly. The blade can bounce away from material being cut if the blade is fed faster than its cutting capability.

Operation

- g. Cut only from your right to your left.
- h. Keep your path of advance clear of material that has been cut and other debris.

3. How you can maintain the best control:

- a. Keep a good, firm grip on the unit with both hands. A firm grip can help neutralize bounce. Keep your right and left hands completely around the respective handles.
- b. Keep both feet spread apart in a comfortable stance and yet braced for the possibility that the unit could bounce. Do not overreach. Keep firm footing and balance.
- c. Always use the shoulder harness. Adjust the harness for comfort before starting the engine. The harness should be adjusted so the left hand can comfortably hold the handlebar grip approximately waist high.
- d. Do not cut material waist high or over to avoid loss of unit control.
- e. Do not swing the unit with such force that you are in danger of losing your balance.



Stop engine before removing grass or weed wrappings to avoid injury from accidental blade rotation.

TO SHARPEN BLADE:

1. Grind away each cutting edge and its back evenly and maintain similar shape to original.
2. Sharpen each cutting edge and make sure the bottom corner is rounded.

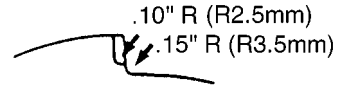

- If edge bottom is finished square, the blade will tend to crack from the corner during operation.
- Do not cool the blade with water in case of using grinder. It may cause cracks on blade.

Maintenance

⚠ WARNING

- Always be sure to stop the engine before inspecting the brushcutter for problems or performing maintenance.
- Never alter the brushcutter or take the engine apart.
- When replacing parts, always be sure to use only RedMax products or products which have been certified by RedMax for use with the RedMax brushcutter.
- Things to check before using brushcutter

■ REFILLING TRIMMING LINE

1. For replacement line, use a diameter of .095 in(2.4 mm). The spool is capable for a line upto 27 ft(8 m)on the 4" head, and 46 ft(14m)on the 6" head. Avoid using a larger line as it may cut down the trimming performance. For safety reasons, do not use metalreinforced line.
2. Pinch the slotted area on the both sides of the spool housing to unhook the bottom cap.

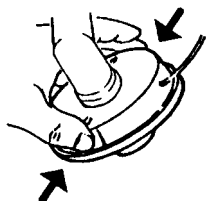

3. Take out the spool and pull off the old line. Put one end of new line through the spool holes and pull it until the length is equal between each part of the line.

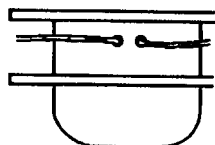

4. Wind up the line in the correct as indicated on the spool.

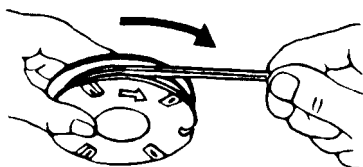

5. Hook each end of the line in the slot on the edge of the spool, and then put the ends through the eyelets on the housing. Make sure that the spring and the washers are in place.

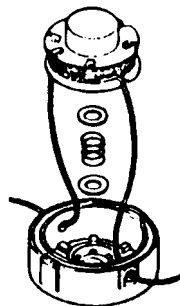

6. While holding the spool against the housing, pull the line ends to release them from the slot.
7. Line up the slot on the bottom cap with the hook on the housing, press the cap against the housing until it clicks.

⚠ WARNING

- Make sure that the engine has stopped and is cool before performing any service to the brushcutter. Contact with moving cutting head or hot muffler may result in a personal injury.

■ AIR FILTER

- The air filter, if clogged, will reduce the engine performance. Monthly check and clean the filter element in warm, soapy water as required. Dry completely before installing. If the element is broken or shrunk, replace with a new one.

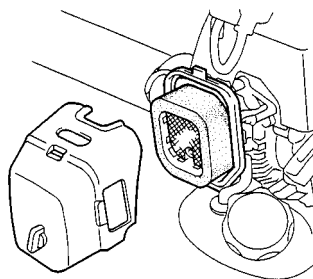

Maintenance

■ FUEL FILTER

- When the engine runs short of fuel supply, check the fuel cap and the fuel filter for blockage.

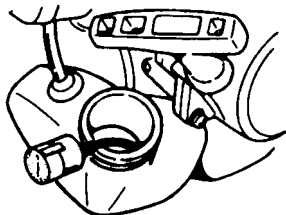

■ SPARK PLUG

- Starting failure and mis-firing are often caused by a fouled spark plug. Periodically clean the spark plug and check that the spark gap is in the correct range. For a replacement plug, use the correct type specified by RedMax (See SPECIFICATIONS on the page 18).

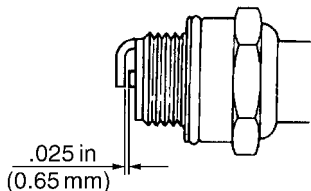

- **REPLACEMENT PLUG IS A CHAMPION RCJ6Y OR THE EQUIVALENT, SUCH AS BOSCH WSR8E OR NGK BPMR7A.**

IMPORTANT

- Note that using any spark plugs other than those designated may result in the engine failing to operate properly or in the engine becoming overheated and damaged.
- To install the spark plug, first turn the plug until it is finger tight, then tighten it a quarter turn more with a socket wrench.

■ MUFFLER

▲ WARNING

- Inspect periodically, the muffler for loose fasteners, any damage or corrosion. If any sign of exhaust leakage is found, do not use the brushcutter and have it repaired immediately.

- **Note that failing to do so may result in the engine catching on fire.**

■ SPARK ARRESTER

- The muffler is equipped with a spark arrester to prevent red hot carbon from flying out of the exhaust outlet. Periodically inspect and clean as necessary with a wire brush. In the State of California it is required by law (Section 4442 of the California Public Resources Code) to equip a spark arrester when a gas powered tool is used in any forest covered, brush covered, or grass covered unimproved land.

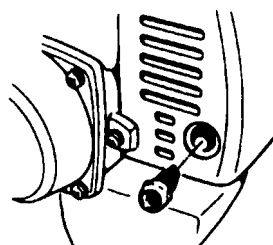

■ GEAR CASE

- The reduction gears are lubricated by multipurpose, lithium-based grease in the gear case. Supply new grease every 50 hours of use or more often depending on the job condition.

Remove the cutter holders before installing new grease to arrange for old grease to exit.

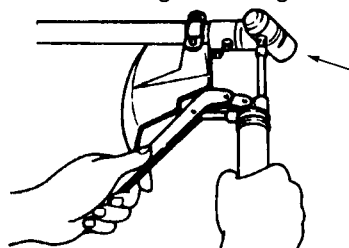

Maintenance

■ INTAKE AIR COOLING VENT

⚠ WARNING

- **Never touch the cylinder, muffler, or spark plugs with your bare hands immediately after stopping the engine. The engine can become very hot when in operation, and doing so could result in severe burns.**
- **When checking the brushcutter to make sure that it is okay before using it, check the area around the muffler and remove any wood chips or leaves which have attached themselves to the brushcutter. Note that failing to do so could cause the muffler to become overheated, and that this in turn could cause the brushcutter to catch on fire. Always make sure that the muffler is clean and free of wood chips, leaves, and other waste before use.**
- Check the intake air cooling vent and the area around the cylinder cooling fins after every 25 hours of use for blockage, and remove any waste which has attached itself to the brushcutter. Note that it is necessary to remove the plug guard shown in Figure 20 in order to be able to view the upper part of the cylinder.

IMPORTANT

- If waste gets stuck and causes blockage around the intake air cooling vent or between the cylinder fins, it may cause the engine to overheat, and that in turn may cause mechanical failure on the part of the brushcutter.

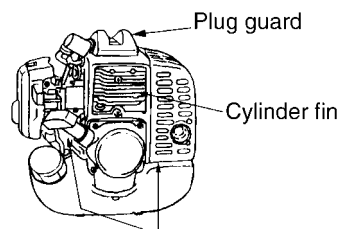

Intake air cooling vent (back)

■ PROCEDURES TO BE PERFORMED AFTER EVERY 100 HOURS OF USE

1. Remove the muffler, insert a screwdriver into the vent, and wipe away any carbon buildup. Wipe away any carbon buildup on the muffler exhaust vent at the same time.

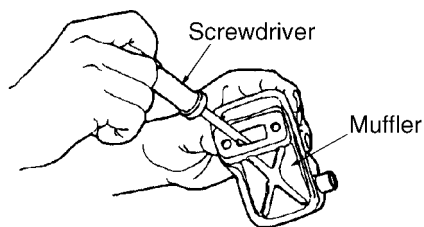

2. Tighten all screws, bolts, and fittings.
3. Check to see if any oil or grease has worked its way in between the clutch lining and drum, and if it has wipe it away using oil-free, lead-free gasoline.

Storage

- Aged fuel is one of major causes of engine starting failure. Before storing the unit, empty the fuel tank and run the engine until it uses all the fuel left in the fuel line and the carburetor. Store the unit indoor taking necessary measures for rust prevention.

Specifications

■ BC2601DL

Overall size(LxWxH)	71.7x12.4x13.2(in) / 1821x315x335(mm)
Dry weight w/o acc.	9.6(lbs) / 4.8(kg)
Engine Type.....	Air-cooled 2-stroke gasoline
Model	Zenoah G26L
Displacement	25.4(cc)
Max. output.....	1.2(HP)at 7500rpm
Fuel	Mixture(Gasoline 32:Oil 1)
Carburetor	Walbro Diaphragm type
Spark plug	Champion RCJ6Y
Fuel tank capacity	25.0(fl.oz) / 0.7(ℓ)
Transmission.....	Centrifugal clutch,Rigid driveshaft
Reduction ratio	1.357
Cutting head rotating direction	Counter-clockwise(Operator view)
Standard Accessories	
4 in. 2-line Head	1 pc.
Shoulder Strap	1 pc.
Goggle.....	1 pc.
Tool Kit	1 pc.

Specifications are subject to change without notice.

BRUSHCUTTERS

BC2601DL

NOTE :

1. Use KOMATSU ZENOAH genuine parts as specified in the parts list for repair and/or replacement.
2. KOMATSU ZENOAH does not warrant the machines, which have been damaged by the use of any parts other than those specified by the company.
3. When placing parts orders for repair and/or replacement, check if the model name and the serial number are applicable to those specified in the parts list, then use parts number described in the parts list.
4. The contents described in the parts list may change due to improvement.
5. The parts for the machine shall be supplied seven (7) years after the machine is discontinued. [It is possible that some specific parts may be subject to change of their delivery term and list price within the limit of ten (7) years after the machine is discontinued. It is also possible that some parts may be available even after the limit of seven (7) years.]

APPLICABLE SERIAL NUMBERS :

Oct.1999

DRIVE UNIT 900101 and up

ENGINE UNIT 900101 and up

Parts List

Fig.1 TRIMMER GROUP BC2601DL

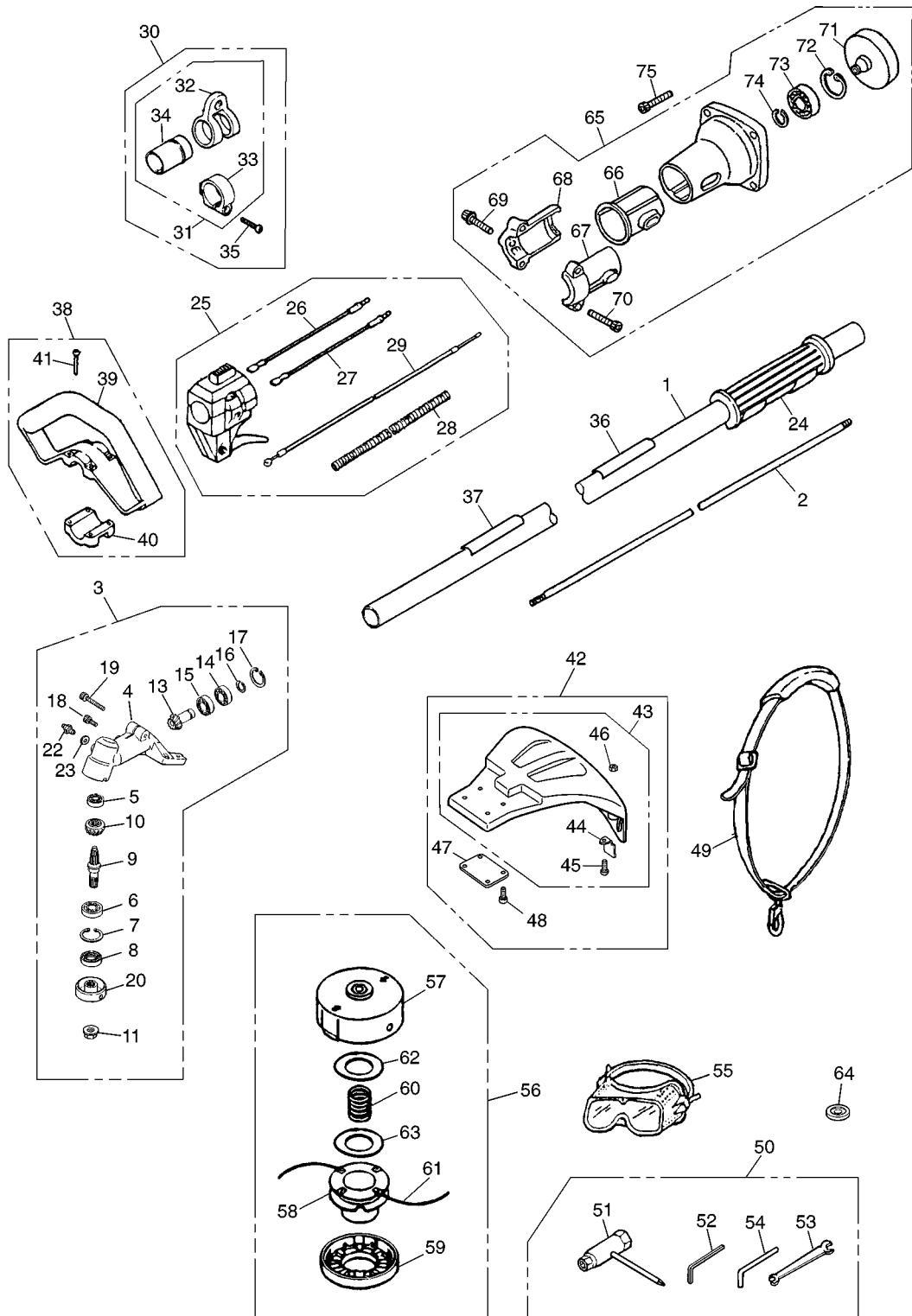

Fig.1 TRIMMER GROUP BC2601DL

Key#	Description	Part Number	Q'ty	Key#	Description	Part Number	Q'ty
1	PIPE-COMP	T3002-12100	1	51	• SOCKET	T3051-91310	1
2	SHAFT	3520-12212	1	52	• WRENCH	09007-00425	1
3	GEARCASE-ASS'Y	T3002-13001	1	53	• SPANNER	3540-91120	1
4	• GEARCASE	6489-13110	1	54	• BAR	3540-91110	1
5	• BEARING	06000-00626	1	55	GOGGLE	T3002-91190	1
6	• BEARING	06000-06000	1	56	TAP. HEAD 4"	PT104	1
7	• RING	04065-02612	1	57	• CASE	6460-15113	1
8	• SEAL	3565-13130	1	58	• CORD HOLDER	6460-15142	1
9	• SHAFT	T3002-13210	1	59	• COVER	6460-15131	1
10	• GEAR	6440-13220	1	60	• SPRING	6041-99162	1
11	• NUT	T3002-13260	1	61	• TRIMMER LINE	6460-15180	1
—	—	—	1	62	• PLATE, large	3268-15150	1
13	• PINION	T3002-13310	1	63	• PLATE, small	3268-15170	1
14	• BEARING	06001-00609	1	64	HOLDER (B)	6019-13250	1
15	• BEARING	06000-00609	1	65	HOUSING, ASS'Y	T3051-11000	1
16	• RING	3210-13330	1	66	• CUSHION	6470-31230	1
17	• RING	04065-02412	1	67	• BRACKET (A)	6470-31211	1
18	• BOLT	01252-30510	1	68	• BRACKET (B)	6470-31221	1
19	• BOLT	3350-21320	1	69	• BOLT	01252-30514	1
20	• HOLDER (A)	6440-13242	1	70	• BOLT	01252-30530	2
—	—	—	1	71	• DRUM	6460-12111	1
22	• FITTING, grease	3199-13350	1	72	• SNAPRING	04065-02812	1
23	• WASHER	01641-20608	1	73	• BEARING	06004-06001	1
24	GRIP	3577-32141	1	74	• SNAPRING	04064-01210	1
25	LEVER-COMP	T3002-12200	1	75	BOLT	6468-91150	4
26	• CORD (A)	T3002-12220	1				
27	• CORD (B)	T3002-12230	1				
28	• TUBE	T3002-12240	1				
29	• CABLE	T3002-83100	1				
30	HANGER-ASS'Y	6420-17300	1				
31	• HANGER-COMP	6420-17400	1				
32	•• HANGER	9366-17110	1				
33	•• CLAMP	9366-17120	1				
34	•• SLEEVE	6420-17410	1				
35	• SCREW	00263-90525	1				
36	PLATE-NAME	T3051-12510	1				
37	PLATE	6425-12552	1				
38	HANDLE-ASS'Y	6420-14100	1				
39	• HANDLE	6420-14311	1				
40	• CLAMP	6420-14320	1				
41	• SCREW	00263-90535	4				
42	GUARD-ASS'Y	T3002-24001	1				
43	• GUARD COMP	T3002-24101	1				
44	•• BLADE	T3002-24121	1				
45	•• SCREW	00263-90516	1				
46	•• NUT	3320-15310	1				
47	• PLATE	6489-24120	1				
48	• BOLT	01252-30514	4				
49	STRAP-ASS'Y	T3002-17200	1				
50	TOOL-SET	T3051-91000	1				

Parts List

Fig.2 ENGINE GROUP BC2601DL

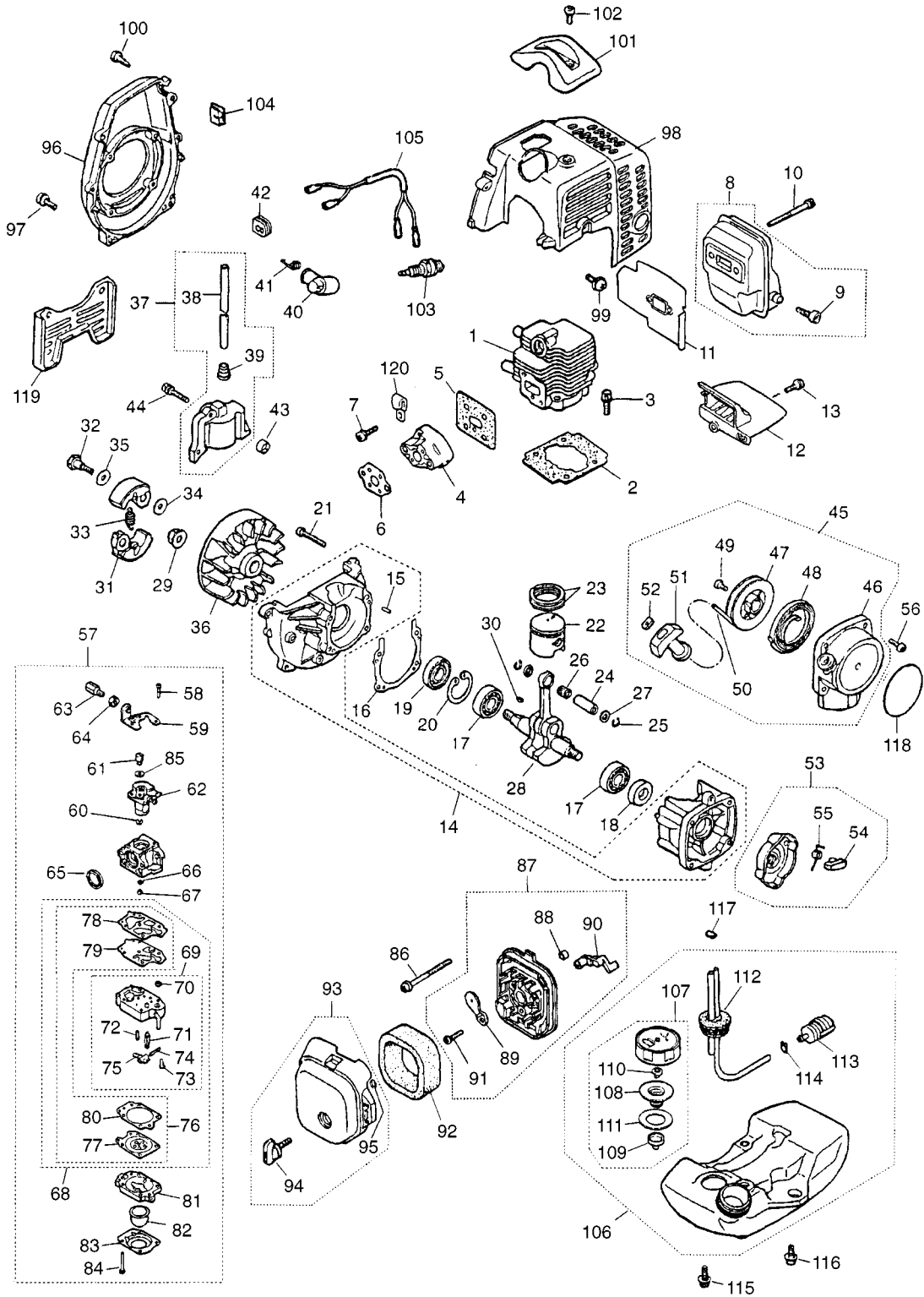

Fig.2 ENGINE GROUP BC2601DL

Key#	Description	Part Number	Q'ty	Key#	Description	Part Number	Q'ty
1	CYLINDER	5911-12110	1	61	• SWIVEL	1881-81140	1
2	GASKET, base	5500-12212	1	62	• VALVE ASS'Y	_____	1
3	BOLT	1850-12130	2	63	• SCREW, adjuster	1918-81170	1
4	INSULATOR	1920-13162	1	64	• NUT, adjuster	1751-81180	1
5	GASKET, insulator	5500-13121	1	65	• RING	1881-81130	1
6	GASKET, carburetor	5500-13131	1	66	• O-RING	1751-81240	1
7	SCREW	0263-90520	2	67	• JET	5500-81251	1
8	MUFFLER ASS'Y	5850-15100	1	68	• Rebuilt Kit	5602-06030	1
9	• ARRESTER	1601-15120	1	69	•• Body ASS'Y	1850-81450	1
10	BOLT	01252-30550	2	70	••• Screen	_____	-
11	GASKET, muffler	5910-15211	1	71	••• Valve	_____	-
12	PLATE, muffler	5500-15220	1	72	••• Spring	_____	-
13	SCREW	0263-90416	1	73	••• Screw	_____	-
14	CRANKCASE COMP.	5500-21100	1	74	••• Pin	_____	-
15	• PIN	2629-21130	3	75	••• Lever	_____	-
16	GASKET, case	5500-21141	1	76	•• Gasket kit	5602-06020	1
17	BEARING	06030-06001	2	77	••• Washer	_____	-
18	OIL SEAL	2169-21210	1	78	••• Gasket, pump	_____	-
19	OIL SEAL	1850-21220	1	79	••• Diaphragm, pump	_____	-
20	SNAP RING	04065-02812	1	80	••• Gasket, diaphragm	_____	-
21	SCREW	01252-30530	4	81	• BODY, purge	1850-81490	1
22	PISTON	5910-41110	1	82	• PUMP, priming	1751-81510	1
23	RING	5910-41210	2	83	• COVER, pump	1850-81520	1
24	PIN	1600-41310	1	84	• SCREW	1850-81530	4
25	SNAP RING	1260-41320	2	85	• WASHER	5500-81160	1
26	BEARING	1140-41330	1	86	SCREW	0263-30555	2
27	WASHER	1101-41340	2	87	BODY ASS'Y	5500-82102	1
28	CRANKSHAFT COMP.	5500-42001	1	88	• SLEEVE	1970-82190	2
29	NUT	1650-43230	1	89	• PLATE, choke	5500-82131	1
30	KEY	1000-43240	1	90	• LEVER, choke	5500-82140	1
31	SHOE, clutch	1140-51111	2	91	• SCREW	2630-33610	1
32	SCREW	1140-51250	2	92	ELEMENT	5500-82171	1
33	SPRING	1970-51221	1	93	COVER ASS'Y	5600-82202	1
34	WASHER	1140-51230	2	94	• KNOB	5500-82221	1
35	WASHER	1970-51241	2	95	• RING	5500-82230	1
36	ROTOR	5501-71110	1	96	COVER, fan	5501-31111	1
37	COIL ASS'Y	5501-71201	1	97	SCREW	0263-90520	4
38	• CORD	5500-71220	1	98	COVER, engine	5580-32112	1
39	• CAP	2616-71320	1	99	SCREW	1850-32160	1
40	CAP, plug	1900-72111	1	100	SCREW	1900-31410	2
41	SPRING	1900-72120	1	101	GUARD, plug	5500-32210	1
42	GROMMET	5500-72130	1	102	SCREW	0263-90514	1
43	SPACER	1260-71261	2	103	SPARKPLUG	5602-73110	1
44	BOLT	3310-72150	2	104	GROMMET	1852-72121	1
45	RECOIL ASS'Y	5500-75100	1	105	CORD COMP.	5500-73201	1
46	• CASE COMP.	5500-75110	1	106	TANK ASS'Y	5911-85002	1
47	• REEL	1850-75120	1	107	• CAP ASS'Y	5601-85200	1
48	• SPRING, spiral	1850-75130	1	108	•• HOLDER	5601-85230	1
49	• SCREW	1850-75151	1	109	•• CAP, holder	5600-85240	1
50	• ROPE	1850-75160	1	110	•• VALVE	5600-85250	1
51	• KNOB	1140-75320	1	111	•• PACKING	5500-85220	1
52	• PLATE, stopper	5500-75170	1	112	• PIPE COMP.	5911-85300	1
53	PULLEY ASS'Y	1850-75201	1	113	• FILTER ASS'Y	5500-85400	1
54	• RATCHET	1850-75221	1	114	• CLIP	1260-85460	1
55	• SPRING	1850-75230	1	115	SCREW	5500-85510	2
56	SCREW	0263-90416	4	116	SCREW	5910-85510	1
57	CARBURETOR ASS'Y	5911-81000	1	117	CLIP	1950-86120	1
58	• SCREW	1752-81110	2	118	LABEL	T1077-91120	1
59	• BRACKET	5500-81120	1	119	STAND	1897-31911	1
60	• RING	1751-81130	1	120	CLAMP	1140-72231	1

CALIFORNIA EMISSION CONTROL WARRANTY STATEMENT
YOUR WARRANTY RIGHTS AND OBLIGATIONS

THE CALIFORNIA AIR RESOURCES BOARD AND KOMATSU ZENOAH Co. ARE PLEASED TO EXPLAIN THE **EMISSION CONTROL SYSTEM WARRANTY** ON YOUR **1995 AND LATER** LAWN AND GARDEN EQUIPMENT ENGINE. IN CALIFORNIA, NEW UTILITY AND LAWN AND GARDEN EQUIPMENT ENGINES MUST BE DESIGNED, BUILT AND EQUIPPED TO MEET THE STATE'S STRINGENT ANTI-SMOG STANDARDS.

KOMATSU ZENOAH Co, MUST WARRANT THE EMISSION CONTROL SYSTEM ON YOUR LAWN AND GARDEN EQUIPMENT ENGINE FOR THE PERIODS OF TIME LISTED BELOW PROVIDED THERE HAS BEEN NO ABUSE, NEGLIGENCE OR IMPROPER MAINTENANCE OF YOUR LAWN AND GARDEN EQUIPMENT ENGINE.

YOUR EMISSION CONTROL SYSTEM. MAY INCLUDE PARTS SUCH AS THE CARBURETOR, THE IGNITION SYSTEM, AND CATALYTIC CONVERTER. ALSO INCLUDED MAY BE THE HOSES, BELTS, CONNECTORS AND OTHER EMISSION-RELATED ASSEMBLIES.

WHERE A WARRANTABLE CONDITION EXISTS, KOMATSU ZENOAH Co. WILL REPAIR YOUR LAWN AND GARDEN EQUIPMENT ENGINE AT NO COST TO YOU INCLUDING DIAGNOSIS, PARTS AND LABOR.

MANUFACTURER'S WARRANTY COVERAGE:

THE 1995 AND LATER UTILITY AND LAWN AND GARDEN EQUIPMENT ENGINES ARE WARRANTED FOR **TWO YEARS**. IF ANY EMISSION-RELATED PART ON YOUR ENGINE IS DEFECTIVE, THE PART WILL BE REPAIRED OR REPLACED BY KOMATSU ZENOAH Co.

OWNER'S WARRANTY RESPONSIBILITIES:

—AS THE LAWN AND GARDEN EQUIPMENT ENGINE OWNER, YOU ARE RESPONSIBLE FOR THE PERFORMANCE OF THE **REQUIRED MAINTENANCE LISTED IN YOUR OWNER'S MANUAL**. KOMATSU ZENOAH Co. RECOMMENDS THAT YOU RETAIN ALL RECEIPTS COVERING MAINTENANCE ON YOUR LAWN AND GARDEN ENGINE, BUT KOMATSU ZENOAH Co. CAN NOT DENY WARRANTY SOLELY FOR THE LACK OF RECEIPTS OR FOR YOUR FAILURE TO ENSURE THE PERFORMANCE OF ALL SCHEDULED MAINTENANCE.

—AS THE LAWN AND GARDEN EQUIPMENT ENGINE OWNER, YOU SHOULD BE AWARE, HOWEVER, THAT KOMATSU ZENOAH Co. MAY DENY YOU WARRANTY COVERAGE IF YOUR LAWN AND GARDEN EQUIPMENT ENGINE OR A PART HAS FAILED DUE TO ABUSE, NEGLIGENCE, IMPROPER MAINTENANCE OR UNAPPROVED MODIFICATION.

—YOU ARE RESPONSIBLE FOR PRESENTING YOUR LAWN AND GARDEN EQUIPMENT ENGINE TO A KOMATSU ZENOAH Co. DISTRIBUTION CENTER AS SOON AS A PROBLEM EXISTS. THE WARRANTY REPAIRS SHOULD BE COMPLETED IN A REASONABLE AMOUNT OF TIME, NOT TO EXCEED **30 DAYS**.

IF YOU HAVE ANY QUESTIONS REGARDING YOU WARRANTY RIGHTS AND RESPONSIBILITIES, YOU SHOULD CONTACT KOMATSU ZENOAH AMERICA INC. AT (770)-381-5147.

**Red Max TRIMMER/BRUSHCUTTER
MODEL BC2601DL
2-YEAR LIMITED WARRANTY**

EMISSION-RELATED PARTS, FOR TWO (2) YEARS FROM THE DATE OF ORIGINAL DELIVERY OF THE MODEL BC2601DL UNIT, KOMATSU ZENOAH AMERICA INC. (THE COMPANY), THROUGH ANY RedMax DEALER, WILL REPAIR OR REPLACE, FREE OF CHARGE, FOR THE ORIGINAL AND EACH SUBSEQUENT PURCHASER, ANY PART OR PARTS FOUND TO BE DEFECTIVE IN MATERIAL AND/OR WORKMANSHIP. EMISSION-RELATED PARTS ARE:

**THE CARBURETOR ASSY, COIL ASSY, ROTOR, SPARKPLUG,
AIR FILTER, FUEL FILTER, INTAKE MANIFOLD, AND THE GASKETS**

ALL OTHER PARTS EXCEPT ABOVE PARTS, FOR TWO (2) YEARS OF HOME USE [ONE (1) YEAR FOR ANY OTHER USE] FROM THE DATE OF ORIGINAL ANY DELIVERY OF THE MODEL BC2601DL UNIT, THE COMPANY, THROUGH ANY RedMax DEALER, WILL REPAIR OR REPLACE, FREE OF CHARGE, FOR THE ORIGINAL PURCHASER, ANY PART OF PARTS FOUND TO BE DEFECTIVE IN MATERIAL AND/OR WORKMANSHIP. **THIS IS THE EXCLUSIVE REMEDY.**

THE PURCHASER SHALL BEAR COSTS OF TRANSPORTING THE UNIT TO AND FROM THE RedMax DEALER.

THE PURCHASER SHALL NOT BE CHARGED FOR DIAGNOSTIC LABOR WHICH LEADS TO THE DETERMINATION THAT A WARRANTED PART IS DEFECTIVE, IF THE DIAGNOSTIC WORK IS PERFORMED AT THE RedMax DEALER.

THE PURCHASER OR OWNER IS RESPONSIBLE FOR THE PERFORMANCE OF THE REQUIRED MAINTENANCE AS DEFINED BY THE MANUFACTURER IN THE OWNER/OPERATOR MANUAL.

ANY WARRANTED PART WHICH IS NOT SCHEDULED FOR REPLACEMENT AS REQUIRED MAINTENANCE, OR WHICH IS SCHEDULED ONLY FOR REGULAR INSPECTION TO THE EFFECT OF "REPAIR OR REPLACE AS NECESSARY" SHALL BE WARRANTED FOR THE WARRANTY PERIOD. ANY WARRANTED PART WHICH IS TIME UP TO THE FIRST SCHEDULED REPLACEMENT POINT FOR THE PART.

ANY REPLACEMENT PART THAT IS EQUIVALENT IN PERFORMANCE AND DURABILITY MAY BE USED IN NON-WARRANTY MAINTENANCE OR REPAIRS, AND SHALL NOT REDUCE THE WARRANTY OBLIGATION OF THE COMPANY.

THE COMPANY IS LIABLE FOR DAMAGES TO OTHER ENGINE COMPONENTS CAUSED BY THE FAILURE OF A WARRANTED PARTS STILL UNDER WARRANTY.

THE WARRANTY DOES NOT APPLY TO THOSE UNITS WHICH HAVE BEEN DAMAGED BY NEGLIGENCE OF INSTRUCTION LISTED IN THE OWNER/OPERATOR MANUAL FOR PROPER USE AND MAINTENANCE OF THE UNITS, ACCIDENT MISHANDLING, ALTERATION, ABUSE, IMPROPER LUBRICATION, USE OF ANY PARTS OR ACCESSORIES OTHER THAN THOSE SPECIFIED BY THE COMPANY, OR OTHER CAUSES BEYOND THE COMPANY'S CONTROL.

THIS WARRANTY DOES NOT COVER THOSE PARTS REPLACED BY NORMAL WEAR OR HARMLESS CHANGES IN THEIR APPEARANCE.

THERE ARE NO OTHER EXPRESS WARRANTIES.

IMPLIED WARRANTIES INCLUDING THOSE OF MERCHANTABILITY AND FITNESS FOR A PARTICULAR PURPOSE **ARE LIMITED TO TWO (2) YEARS OF HOME USE [ONE (1) YEAR FOR ANY OTHER USE] FROM THE ORIGINAL DELIVERY DATE.**

LIABILITIES FOR INCIDENTAL OR CONSEQUENTIAL DAMAGE UNDER ANY AND ALL WARRANTIES ARE EXCLUDED.

SOME STATES DO NOT ALLOW LIMITATION ON HOW LONG AN IMPLIED WARRANTY LASTS OR EXCLUSION OR LIMITATION OF INCIDENTAL OR CONSEQUENTIAL DAMAGES, SO THE ABOVE LIMITATION OR EXCLUSION MAY NOT APPLY TO YOU.

THIS WARRANTY GIVES YOU SPECIFIC LEGAL RIGHTS, AND YOU MAY ALSO HAVE OTHER RIGHTS WHICH VARY FROM STATE TO STATE.

IF YOU NEED TO OBTAIN INFORMATION ABOUT THE NEAREST SERVICE CENTER, PLEASE CALL KOMATSU ZENOAH AMERICA INC. AT (770)-381-5147.

IMPORTANT: YOU WILL RECEIVE A WARRANTY REGISTRATION CARD AT TIME OF PURCHASE. PLEASE FILL OUT THE CARD AND SEND IT TO RedMax / KOMATSU ZENOAH AMERICA WITHIN SEVEN (7) DAYS. BE SURE TO KEEP A COPY FOR YOUR RECORDS.

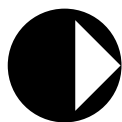

RedMax[®]

KOMATSU ZENOAH AMERICA INC.
4344 Shackelford Road Suite 500
Norcross, Georgia 30093



KOMATSU ZENOAH AMERICA INC.
4344 Shackleford Road Suite 500
Norcross, Georgia 30093

© Printed in Japan

Free Manuals Download Website

<http://myh66.com>

<http://usermanuals.us>

<http://www.somanuals.com>

<http://www.4manuals.cc>

<http://www.manual-lib.com>

<http://www.404manual.com>

<http://www.luxmanual.com>

<http://aubethermostatmanual.com>

Golf course search by state

<http://golfingnear.com>

Email search by domain

<http://emailbydomain.com>

Auto manuals search

<http://auto.somanuals.com>

TV manuals search

<http://tv.somanuals.com>