



Trimmer

Owner's Manual

IMPORTANT: Please read this manual carefully before operating your Trimmer.

INTRODUCTION

Before operating your RedMax® Trimmer, read this manual carefully and completely. This manual will provide you with a full understanding of the necessary instructions for assembly, operation and maintenance of the equipment. For continued safe and reliable operation, use only parts supplied by manufacturer. Adhere to all notes and warnings.

CONTENTS

1. For Safe Operation.....	1
2. Identification of Parts.....	4
3. Assembly.....	5
4. Controlling Engine.....	8
5. Operation.....	11
6. Replacing the Cutting Line	15
7. Maintenance.....	17
8. Troubleshooting Guide.....	20
9. Specifications.....	21

1. For Safe Operation

Know your unit

- * Read this Owner's Manual carefully until you completely understand and can follow all safety notes, precautions, and operating instructions before operating the unit.
- * Restrict your unit to users who understand and follow all safety notes, precautions, and operating instructions found in this manual. Children should not be allowed to operate this unit.

Plan ahead

- * Always wear eye protection such as safety goggles. The shield/line limiter will not prevent rocks or debris from being thrown or ricocheting into eyes and face which could result in loss of vision or serious personal injury.
- * Dress in a long-sleeved shirt and long pants and wear boots or safety shoes. Wear leg guards when cutting large or thorny material. Do not wear loose clothing, jewelry, short pants or sandals. Do not go barefoot.
- * Guard against hazardous situations at all times. Warn adults to keep pets and children away from the work area. Establish a safe method for gaining your attention during operation. Be careful if you are approached.
- * Keep children, pets, and bystanders a minimum of 30 feet away when starting or operating the unit.
- * Do not operate the unit when you are tired, ill, or upset; or if you are under the influence of alcohol, drugs, or medication.
- * Inspect the area to be cut before each use. Remove all debris and objects that could be thrown, become entangled in the cutting head, or cause damage during cutting.

Handle fuel with caution

- * Eliminate all sources of sparks or flame (including smoking, open flames, or work that could cause sparks) in the areas where fuel is mixed, poured, or stored.
- * Mix, pour, and store fuel in an approved, marked container and in a well ventilated area.
- * Do not smoke while handling fuel or while operating the unit.
- * Wipe up all spills before starting the engine. Move at least 10 feet (3 meters) away from fuel and fueling site before starting the engine.

Operate your unit safely

- * Inspect the entire unit before each use for worn, loose, or damaged parts. Do not use until the unit is in proper working order.
- * Keep the handles free of oil and fuel.
- * Never start or run the engine inside a closed room or building. Exhaust fumes contain dangerous carbon monoxide.
- * Never use the unit without the debris guard attached in place.
- * Never use wire in place of the nylon monofilament cutting lines. The wire tip can break off during cutting and become a dangerous missile.
- * Stop engine before removing the fuel cap.
- * Do not use any accessory or attachment other than those supplied by the manufacturer for use with this particular unit.
- * Use only for jobs explained in this manual.

Maintain your unit Properly

- * Maintain the unit according to recommended procedures. Keep the cutting lines at the proper length.
- * Disconnect spark plug before performing maintenance except for carburetor adjustment.
- * Use only recommended, genuine replacement parts to avoid creating a hazard and/or voiding your warranty.
- * Start the engine with the cutting head supported off the ground and unable to contact any object.
- * Drain fuel from the tank after each use. Do not store without draining fuel from the unit.
- * Do not store the unit or fuel in a closed area where fuel vapors can reach an open flame from hot water heaters, furnaces, etc.
- * Store in a dry area out of the reach of children.

2. Identification of Parts

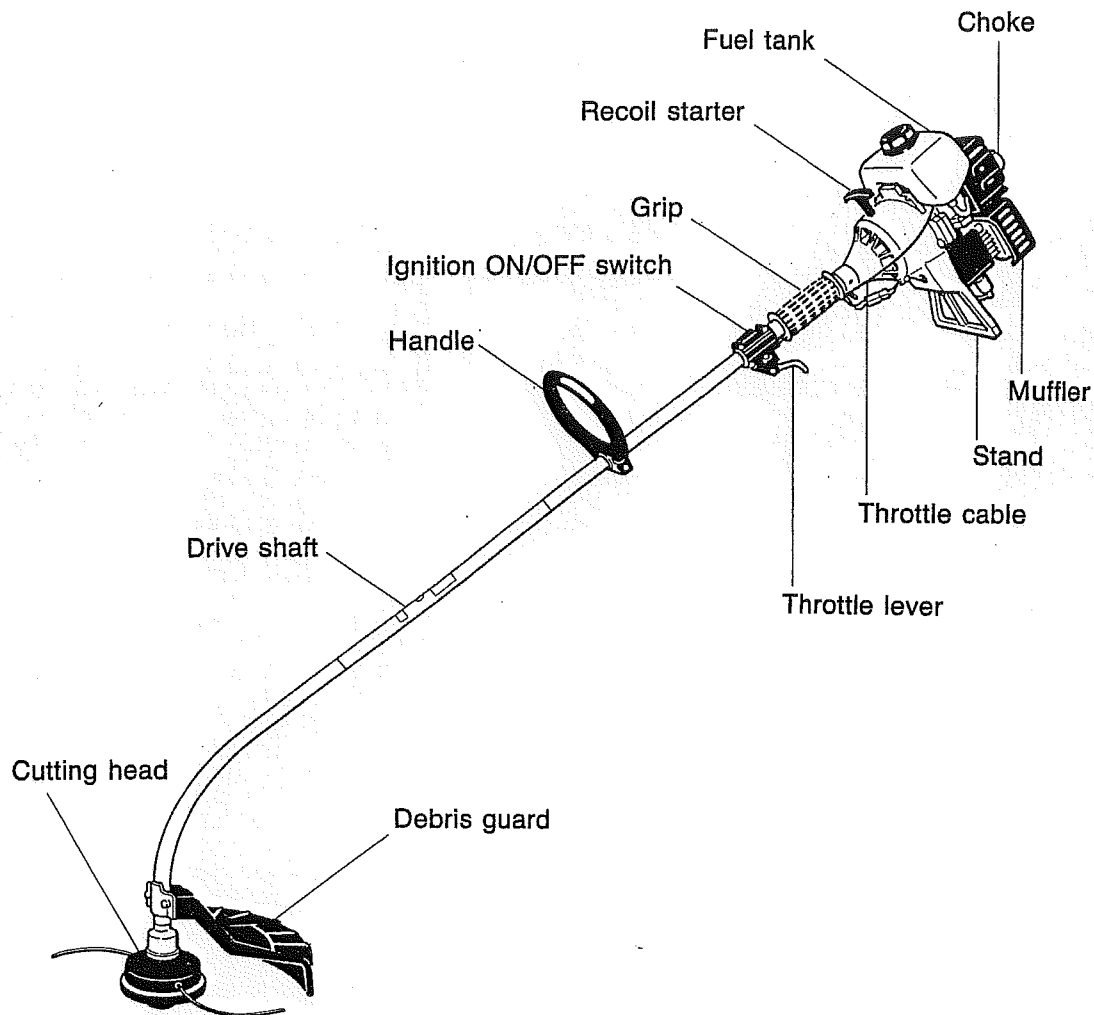

3. Assembly

A. Engine and Shaft

- 1) Align the square end of the drive shaft with the square hole inside the housing.
- 2) Slide the outer pipe into the housing, twisting slightly to ensure the flexible drive engages.

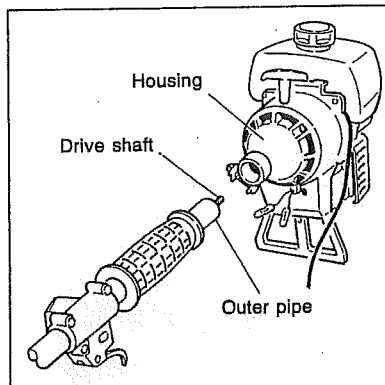

- 3) Tighten the fixing bracket over the housing with the supplied nuts.
- 4) Connect ignition wires (Red → Red/Black → Black).

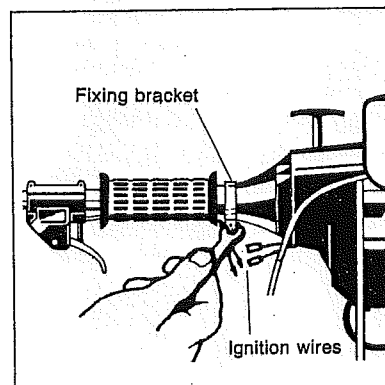

- 5) Feed the throttle cable through the two holes in the handle grip and insert cable lead into the throttle trigger.
- 6) Ensure cable lead is located in the trigger, then tighten screw to secure.

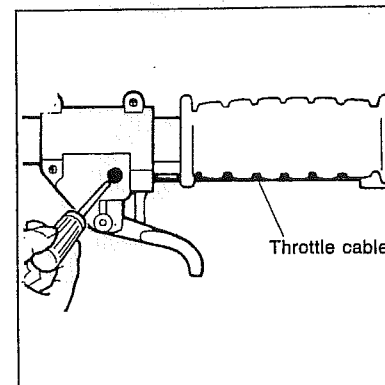

B. Handle

- 1) Extend the handle gap and fit it over the shaft. Ensure that the rubber sleeves are aligned correctly.
- 2) Secure with the supplied screw, washer and wing nut.
- 3) Note that the handle position is adjustable. Adjust so the face of the nylon cord head will come flat to the ground when you take operating position.

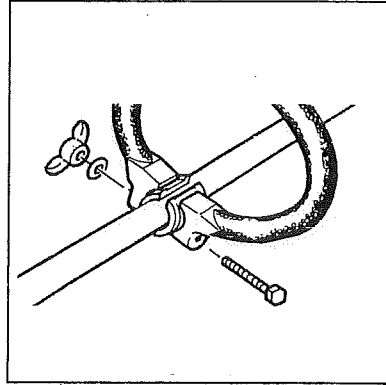

C. Debris Guard

- 1) Insert the two nuts into the attaching side of the guard.
- 2) Align the protrusion in the fixing bracket with the hole in the shaft. Point the head of the bracket upwards.
- 3) Tighten with the two screws.

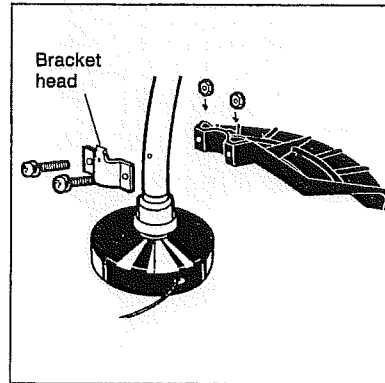

• As the cutting blade on the guard is sharp, and could cause bodily harm if handled incorrectly, care should be taken at all times.

D. Nylon line head

- 1) Screw nylon line head onto end of shaft.
- 2) Press the line adjustment cap and pull the nylon cord out to a length of about 5".

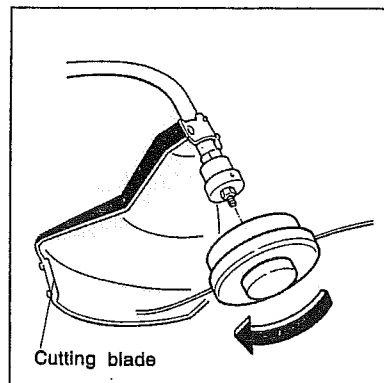

3) The cord will be cut automatically to the correct length upon rotation of the head.

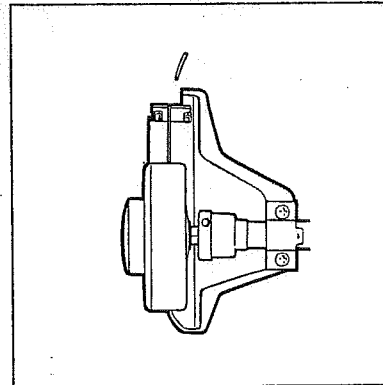
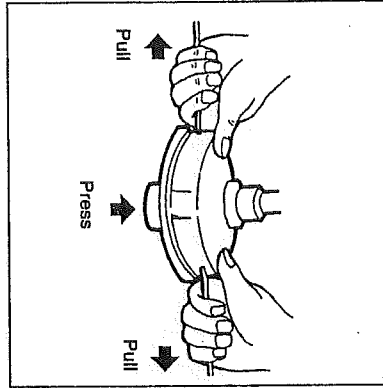

4. Controlling Engine

1. Fueling

- Mix a regular grade gasoline (leaded or unleaded, alcohol-free) and RedMax® motor oil or a quality-proven air cooled 2-cycle engine oil. **Recommended mixing ratio is 32 to 1.**

32:1 Mix Chart

Gasoline	-gallons	1	2	3	4	5
2-cycle oil	-ounces	4	8	12	16	20



- Keep open flames away from the area where fuel is handled or stored.
- Mix and store fuel only in an approved gasoline container.

Make sure to use the proper fuel as most engine failures are caused by or closely related to the fuel used at that time. For example;

- If no oil is mixed in the fuel, the engine will undergo a poor lubrication, resulting in heavy damage to the piston and cylinders in a very short time.
- An alcohol-mixed fuel can deteriorate the rubber parts used in the fuel supply system.
- The use of a motor oil for 4-cycle engines will lead to the spark plug fouling, carbon accumulation, and the piston ring sticking.
- The use of an aged fuel can cause a starting failure and lack of power.
- Water-contaminated fuel can cause fluctuated engine revolution and carburetor corrosion.

2. Cold Engine Starting

1. Press primer until fuel flows through the overflow pipe.

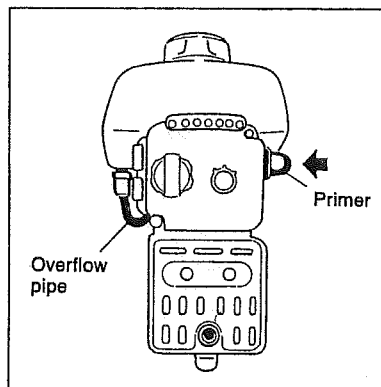
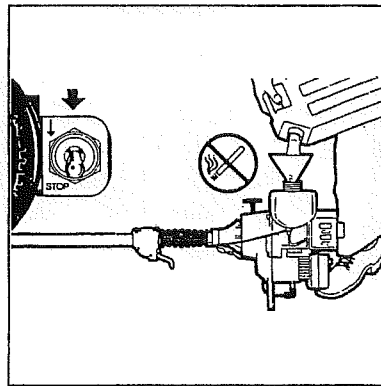
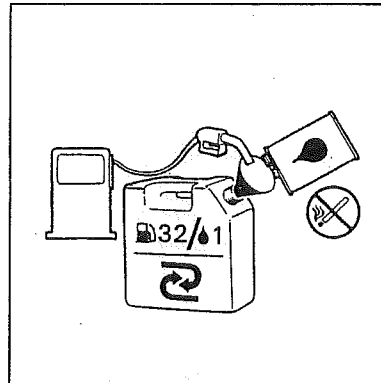

2. Set ignition switch to ON.

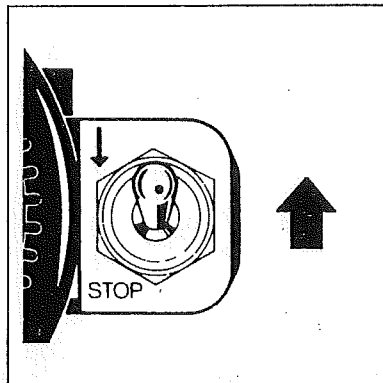

3. Turn choke knob to the ON position.

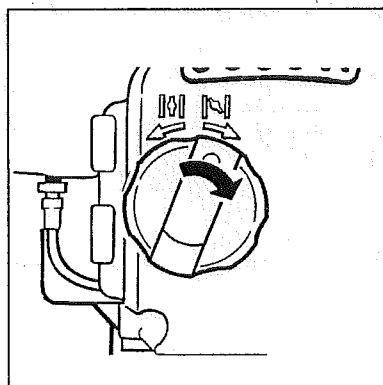

4. While pulling throttle lever with the little finger of your left hand, pull starter rope until engine fires once.

5. Turn choke to center position.

6. While pulling throttle lever, pull starter rope until engine fires. Run for 30 seconds to warm engine.

7. After engine is warmed turn choke to OFF position.

8. The unit is now ready for use.

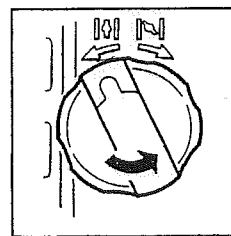
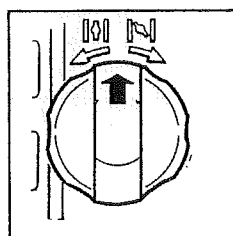
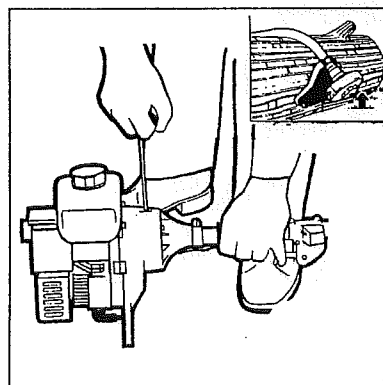

3. Hot Engine Start

1. Set ignition switch to ON.
2. Turn choke knob to the OFF position.
3. While pulling throttle lever, pull starter rope until engine fires.
4. If engine fails to start follow cold start procedure.

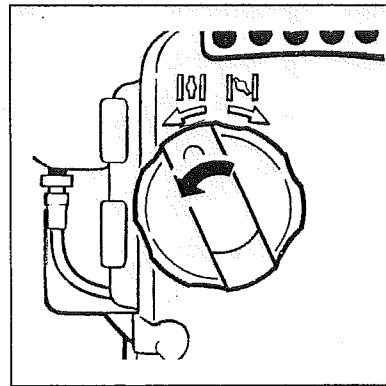
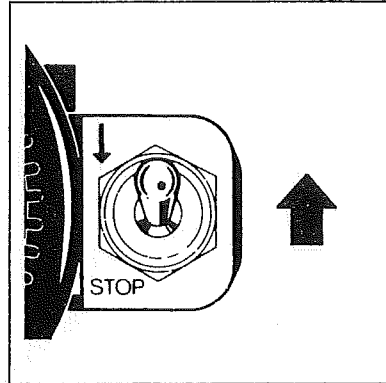

5. Operation

Cutting Position

1. Hold the unit on your right side.
2. The handle should be adjusted so the face of the cutting head will come flat to the ground when you take operating position.
3. Hold the unit so the head is tilted up, approximately 20 degrees to your left when viewed from the operating position.



- Always wear eye protection such as safety goggles. Never lean over the rotating cutting head. Rocks or other debris could be thrown into eyes and face and cause serious personal injury.
- Always keep the debris guard in place when the unit is being operated.

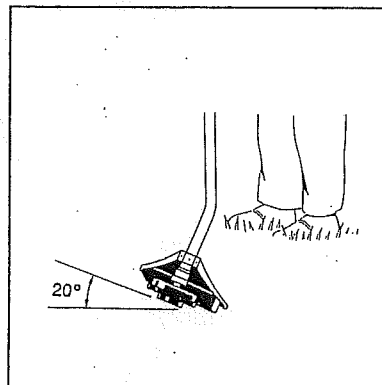
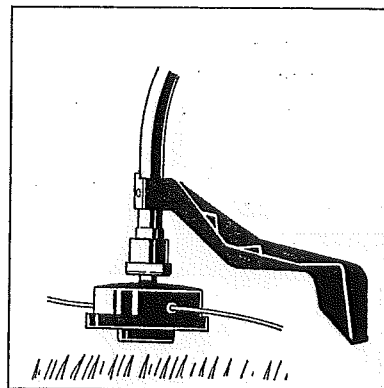

Cutting Methods

Always remember — the tip of the line does the cutting. You will achieve better results by not crowding the line into the cutting area. Allow the unit to trim at its own pace.

- * Always do cutting with engine running at full throttle. A slow turning head can easily be caught by cut grass.
- * Guide the unit in a semicircular motion from your right to left. To clear large areas, guide the unit over a semicircular area of about 6-7 feet at a time. Advance forward about five inches after each cut.

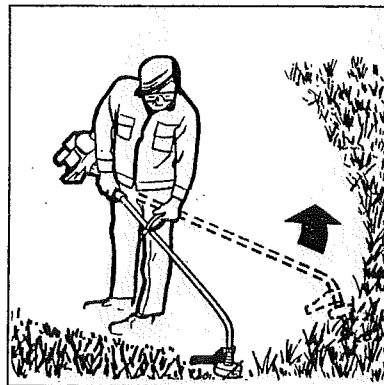

- * Use a slow, deliberate action to cut heavy growth. The rate of cutting motion will depend upon the material being cut. Heavy growth will require slower action than will light growth.
- * Never swing the unit so hard that you are in danger of losing your balance or control of the unit.
- * Try to control the cutting motion with the hip rather than placing the full workload on the arms and hands.
- * Take precautions to avoid wire, grass, and dead, dry, long-stem weeds from wrapping around the head shaft. Such materials can stall the head and cause the clutch to slip.

4. Stopping Engine

1. Release throttle lever and allow engine to idle for a minute.
2. Set the ON/STOP switch to STOP.

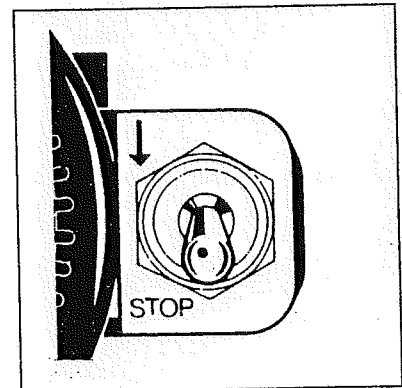

5. Adjustment of Idling speed

1. Adjust the idle speed screw until the engine idles without rotating the nylon cord head.

To **increase** idling speed turn screw clockwise.

To **decrease** idling speed turn screw counter-clockwise.

Note: The "LO" "HI" screws are for service personnel only — do not adjust.

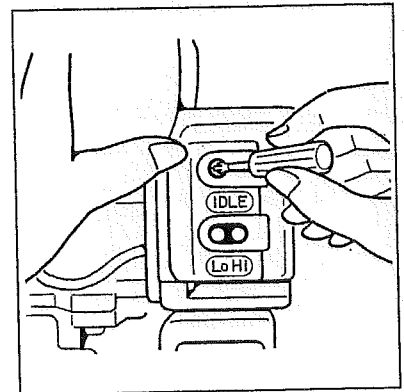

Adjusting the Cutting Line

1) Automatic adjustment

1. Operate the engine at least one-half throttle.
2. Hold cutting head parallel to and above a grassy area of the ground.
3. Tap the cutting head lightly on the ground one time. Approximately 1-1/4 inches of line will be advanced after each tap.

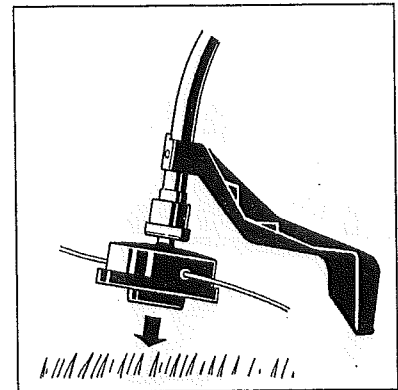



NOTE:

Always tap the cutting head on a grassy area or the ground. Tapping on hard surfaces such as concrete or asphalt can cause excessive wear to the cutting head. Avoid tapping the cutting head unnecessarily as too long a line makes the engine speed slow and thus not cut to its best efficiency.

2) Manual adjustmentment

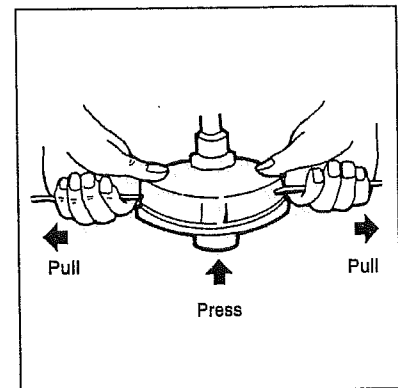
1. Depress and hold the protruding section at the center of the cutting head.
2. Pull the nylon cords out to a length of about 5".
3. Release the center of the cutting head.



 • When adjusting the cord manually, confirm that the ignition switch is set to STOP, and the spark plug lead removed.

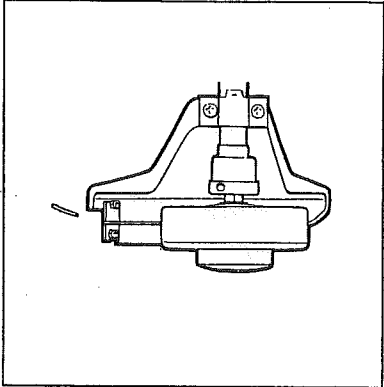

6. Replacing the Cutting line

1. Remove cutting head from shaft.

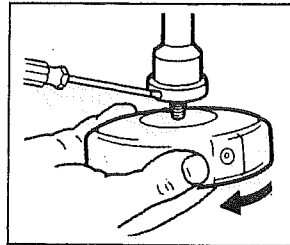

2. Depress each side and remove top of head.

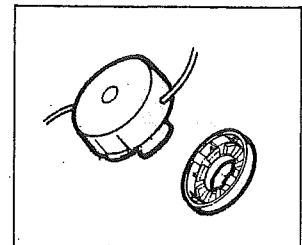
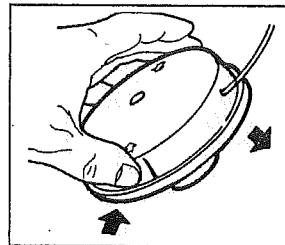

3. Twist the center counterclockwise and remove.

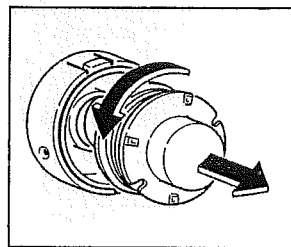

4. Feed nylon cord, in equal lengths about the center, from the inside of the cord holder.

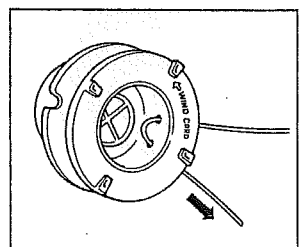
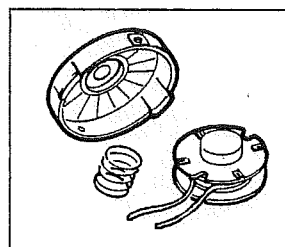

5. Wind both cords in direction of arrow. Do not wind too tightly, as it could inhibit the automatic line cord adjustment function.

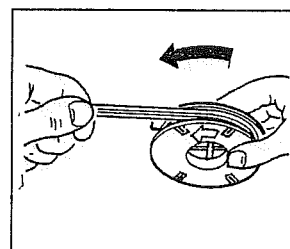

6. Feed the line cords through the holes in the outer covering.

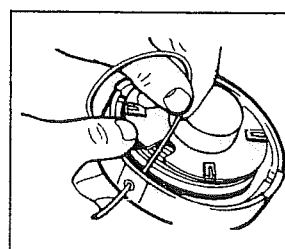

7. Pull to take up slack, then press down the center line cord holder ensuring the spring is correctly placed.

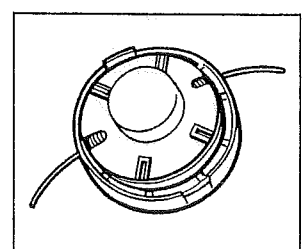

-
8. Confirm the slits in the outer case are aligned with slits on the cord holder.
9. Press together until the outer case and cord holder are securely fixed.

10. While pushing the center of the cutting head pull each line cord out to about 5 inches in length.

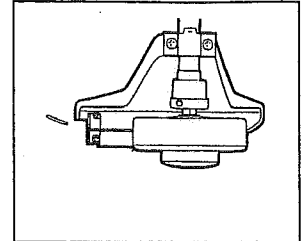
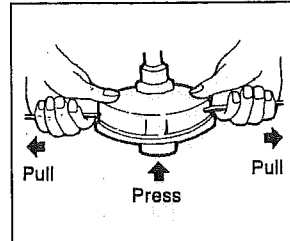
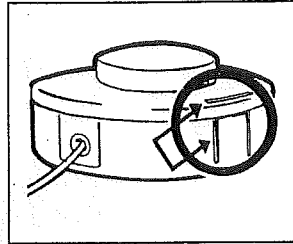

7. Maintenance



- Before cleaning, inspecting or repairing your unit, make sure that engine has stopped and is cool. make sure to disconnect the spark plug lead.

A. After every use:

- Remove all dust, dirt and grass from the entire unit.
- Check complete unit for loose or missing fasteners or parts. Correct if found.
- Check engine for any fuel leaks.

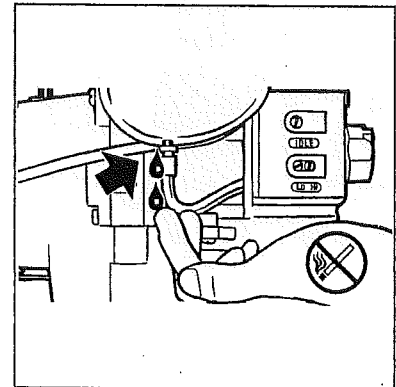
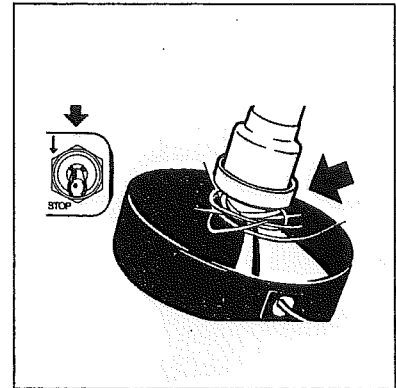

B. Every 30 hours use:

- Clean air filter with gasoline.
1. Remove grommets around adjusting screws.
 2. Unfasten the two screws, to remove the cover.

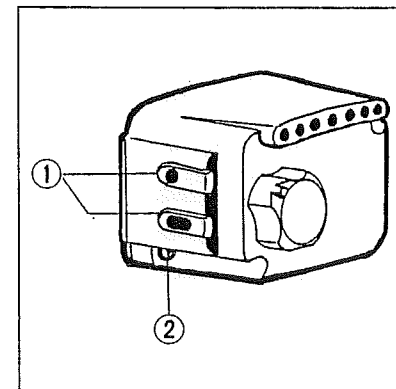

3. Take out air filter from the cover.
4. When replacing, insert both ends first as shown in the figure.
5. Place choke plate and the knob at open position equally.
6. Install the cover and fit grommets as before.

NOTE:

Dry completely before re-installing.

- Remove and clean spark plug. Check and adjust air gap to .024".
- Use Champion RCJ-8 or N.G.K. BMR6A for replacement plug.
- Check fuel filter in tank and clean or replace if needed.
- Remove cylinder cover, clean out all dust and dirt.
- Spark Arrester—Lack of power and starting failure can be caused by carbon built up in the exhaust passage. Clean or replace the spark arrester as necessary.

1. Loosen two screws and remove the muffler.
2. Ply off the spark arresting screen from the exhaust port, using the flat blade of the attached screwdriver.
3. When installing the spark arresting screen, press it until it clicks.

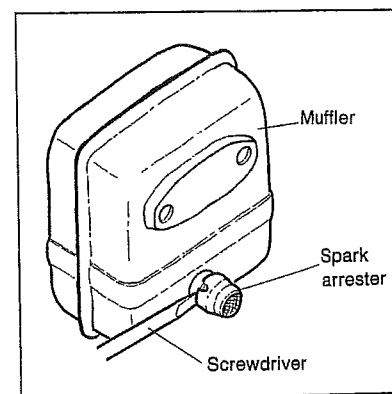
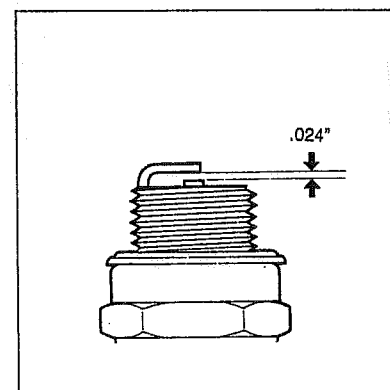
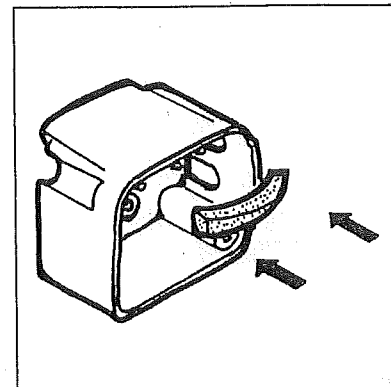

C. Storage:

- Drain fuel tank and run engine out until all fuel in carburetor is used up.
- Remove spark plug and drop a spoonful of oil into the cylinder. Crank engine several times and replace spark plug. Pull starter until compression is felt.
- Store unit in a dry, dust-free place.

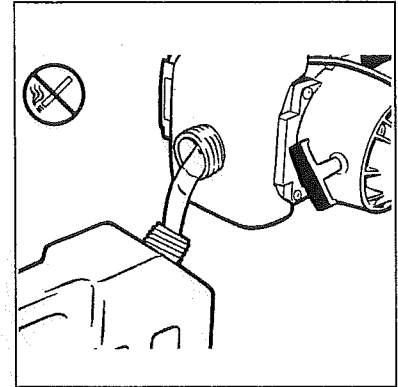

 Do not use any accessory or attachment other than those specifically designed for use with this unit. Serious personal injury to the user or damage to the engine could result.

8. Troubleshooting Guide

Case 1. Engine does not start:

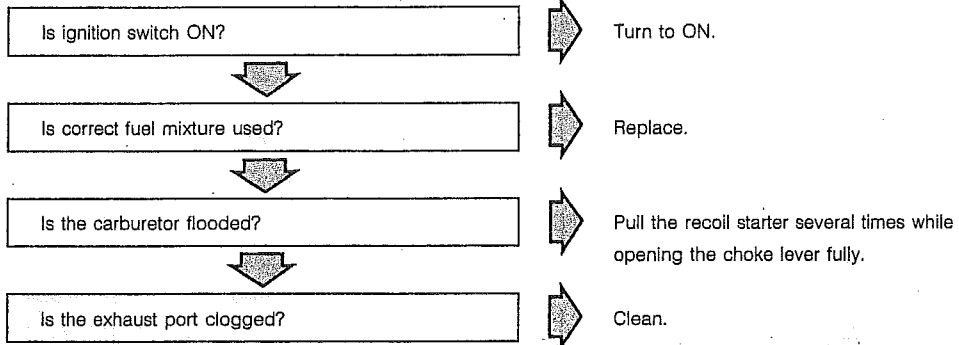

Case 2. Shortage of output power:

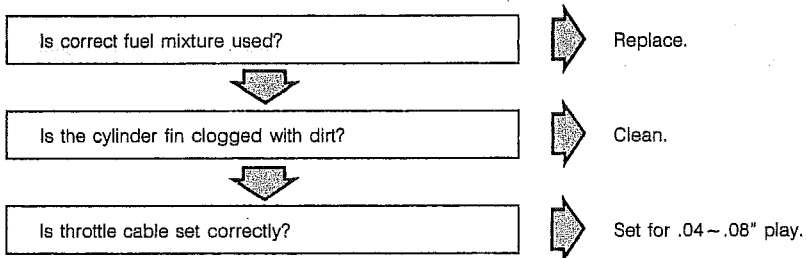

When your unit seems to need further service, please consult our service shop in your area.

9. Specifications

Model Name	BT17
Weight	10.8 lbs (4.9 kg)
Type	Single cylinder gasoline engine
Engine	G1E
Type	Two cycle air cooled gasoline engine
Displacement	1.05 cu in (17.2cc)
Ignition	Solid-state
Carburetor	Diaphragm type
Fuel	Two cycle oil premixed gasoline (Gas 32 : Oil 1)
Spark plug	RCJ8
Fuel tank capacity	1.05 pints (0.5 liter)
Max. output	0.6 HP/6500 rpm
Rotation	Clockwise (operator view)

Specifications are subject to change without notice.

**RedMax® TRIMMER MODEL BT17
2-YEAR LIMITED WARRANTY**

For two (2) years [90 days if used commercially] from the date of original purchase of the BT17 unit, KOMATSU ZENOAH AMERICA INC., through any RedMax® dealer, will repair or replace, free of charge, for the original purchaser, any part or parts found to be defective in material and/or workmanship. **This is the exclusive remedy.**

The purchaser shall bear costs of transporting the unit to and from the RedMax® dealers.

This warranty does not apply to those units which have been damaged by accident, mishandling, alteration, abuse, improper lubrication, the use of any parts or accessories other than those specified by the Company, or other causes beyond our control.

This warranty does not cover those parts replaced for normal wear or harmless changes in their appearance.

There are no other express warranties.

IMPLIED WARRANTIES including those of merchantability and fitness for a particular purpose ARE LIMITED to one (1) year [90 days for commercial use] from the original purchase date. **Liabilities for incidental or consequential damages under any and all warranties are excluded.**

Some states do not allow limitations on how long an implied warranty lasts or the exclusion or limitation of incidental or consequential damages, so the above limitation or exclusion may not apply to you.

This warranty gives you specific legal rights, and you may also have other rights which vary from state to state.

IMPORTANT: You will receive a Warranty Registration Card at time of purchase. Please keep the card and return it when sending your machine in for a repair.



KOMATSU ZENOAH AMERICA INC.
1505 Pavilion Place Suite A
Norcross, Georgia, 30093

Form No. 21A-0212-77120-05
Printed in Japan 12/90



Trimmer

Service Parts List

Note: The parts indicated by " * " in the Part Number column are supplied, not individually but, as an assembly. Please see the Remarks for assembly part number.

Those parts with "OP" in the Remarks column are not supplied with standard unit, but available by separate order.

Fig. 2 DRIVESHAFT • ACCESSORIES • TOOLS

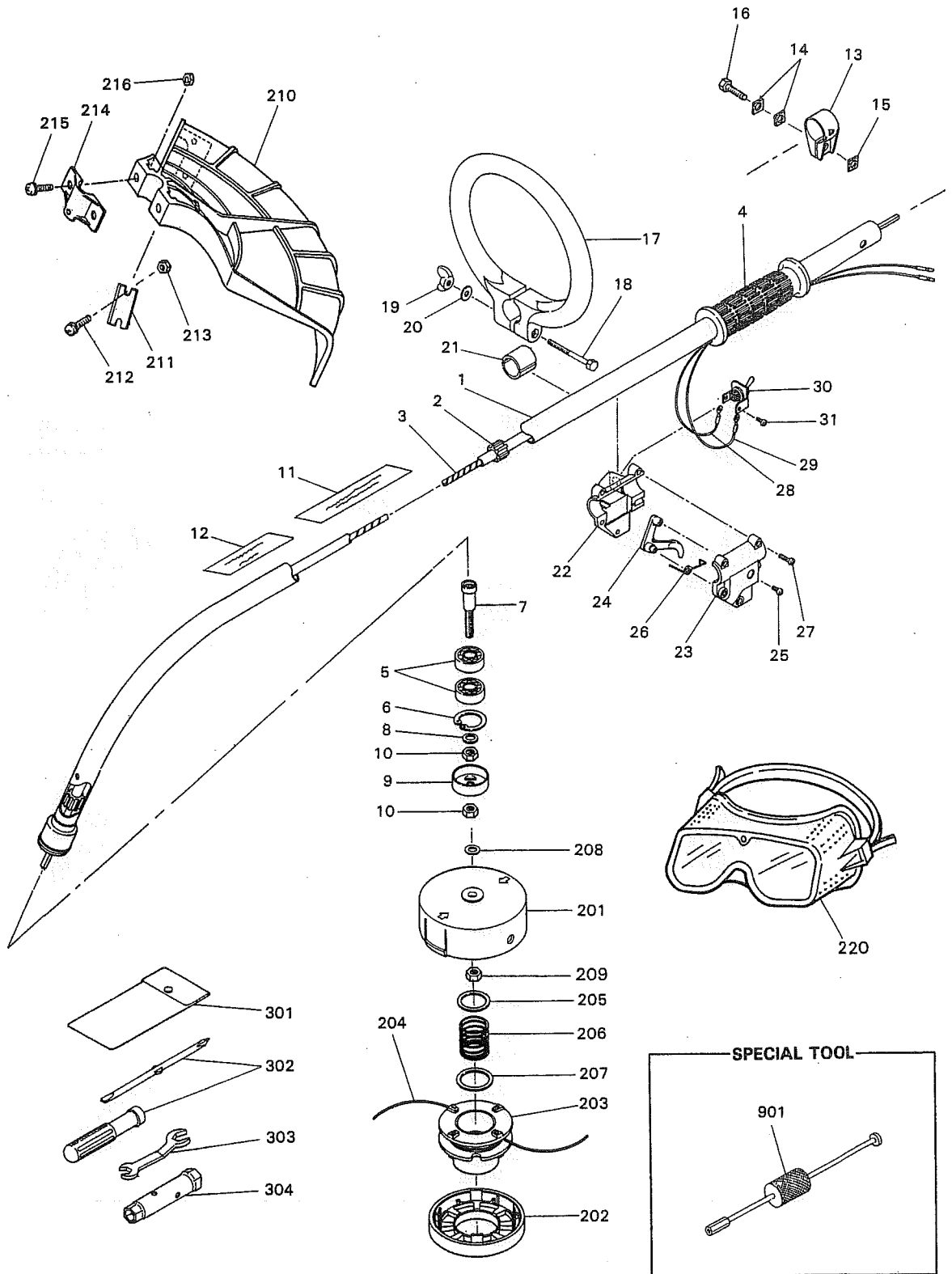

DRIVESHAFT • ACCESSORIES • TOOLS

Index No.	Part Number	Description	Q'ty per Unit	Remarks
	3238-11001	Pipe assy		1 to 10
1	3238-11102	Pipe comp.		1 & 2
2	*	Pipe	1	*3238-11102
	*	Liner comp.	1	*3238-11102
3	3238-11230	Shaft, flexible	1	
4	3238-14550	Grip	1	
5	06031-06201	Ball bearing	2	
6	04065-03212	Snap ring	1	
7	3238-11130	Shaft	1	
8	0291-20816	Washer	1	
9	3238-11140	Cover	1	
10	0280-10806	Nut	2	
11	6049-11530	Plate, name	1	
12	3584-11540	Plate, caution	1	
13	3238-11350	Clamp, engine	1	
14	3238-11360	Plate	2	
15	3238-11370	Nut	1	
16	0224-00635	Bolt	1	
17	3238-12110	Handle	1	
18	0224-00650	Bolt	1	
19	3238-12130	Wing nut	1	
20	0291-20616	Washer	1	
21	3238-12140	Spacer	2	
22	6049-12400	Throttle lever assy		22 to 31
	3238-14512	Case (R)	1	
23	3238-14522	Case (L)	1	
24	3238-14531	Lever, throttle	1	
25	0260-00506	Screw, cable retaining	1	
26	3238-14540	Spring, return	1	
27	1900-31410	Screw	3	
28	3238-14150	Cord (A)	1	Black
29	3238-14161	Cord (B)	1	Red
30	3238-06020	Switch kit		30 & 31
	*	Switch	1	
31	0260-00405	Screw	2	
201	3510-15000	Auto head assy		201 to 209
202	3231-99111	Case (A)	1	
203	3231-99131	Case (B)	1	
204	3503-99140	Cord holder	1	
205	3238-15180	Cord	1	
206	3268-15150	Plate	1	
207	3268-15160	Spring	1	
208	3268-15170	Plate	1	
209	0291-20816	Washer	1	
	3268-15140	Nut	1	
210	6333-23101	Guard assy		210 to 216
	6333-23111	Guard	1	
211	3238-23130	Cutter	1	
212	0260-30412	Screw	2	
213	3238-13150	Nut	2	
214	3238-23120	Clamp, guard	1	
215	0260-30620	Screw	2	
216	0280-10605	Nut	2	
220	6242-92110	Goggle	1	
301	3238-91001	Tool set		
	3238-91110	Bag	1	
302	1030-91340	Screwdriver	1	Convertible
303	3239-91131	Spanner	1	
304	3239-91310	Socket	1	
901	3238-99100	Bearing puller		OP

Fig. 1 ENGINE SECTION

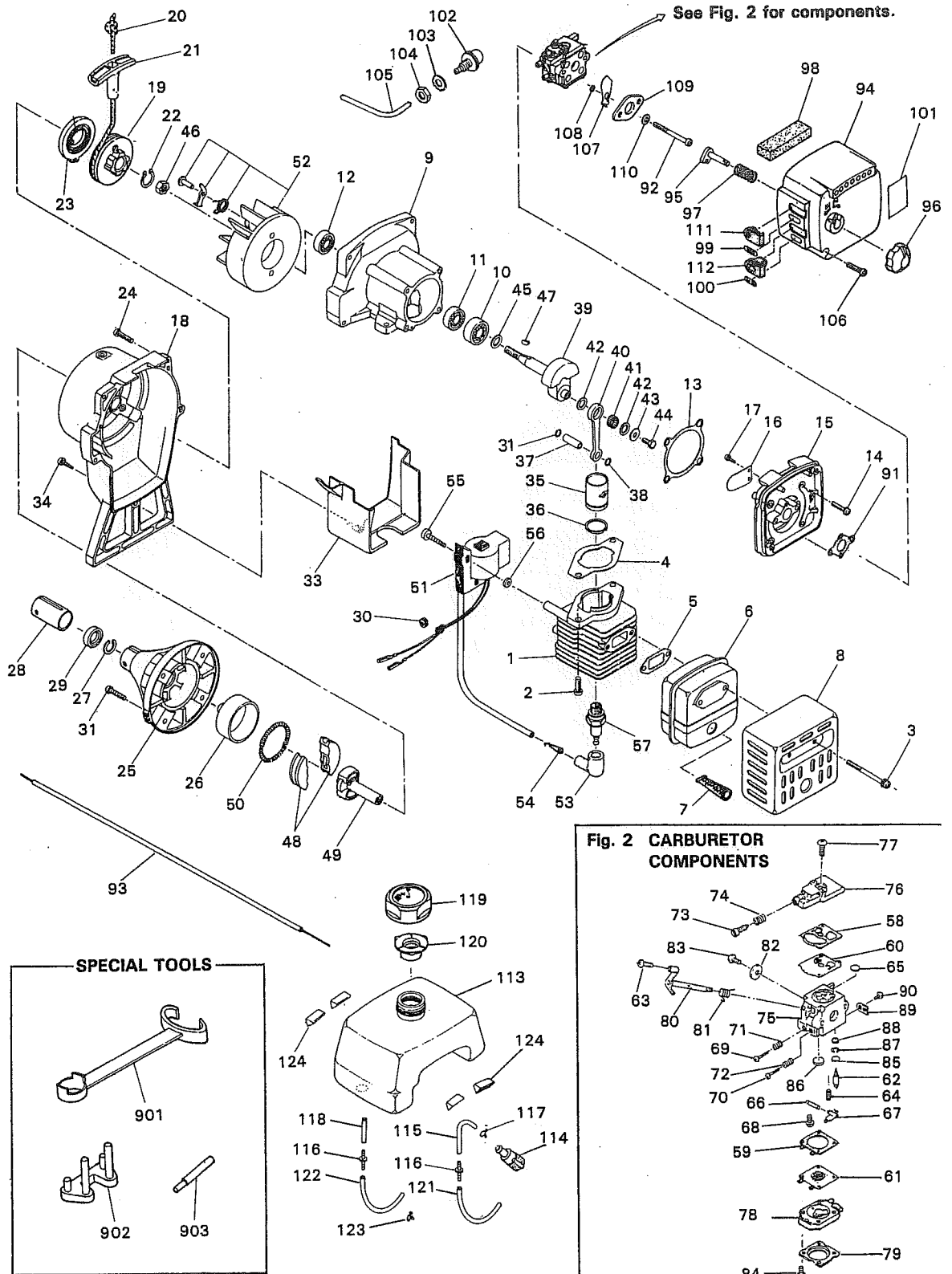

ENGINE SECTION

Index No.	Part Number	Description	Q'ty per Unit	Remarks	Index No.	Part Number	Description	Q'ty per Unit	Remarks
1	1260-12110	Cylinder	1		68	3310-81240	Screw, lever pin	1	
2	0260-00616	Screw, cylinder mtg.	2		69	1270-81070	Needle, low speed	1	Standard: 1 1/4 turns open
3	0260-30555	Screw, muffler mtg.	2		70	1262-81330	Needle, low speed	1	Standard: 1 turn open
4	1260-13120	Gasket, cylinder	1		71	3310-81160	Spring, low speed	1	
5	1260-13140	Gasket, muffler	1		72	3310-81320	Spring, high speed	1	
	1267-15100	Muffler assy	1	6 & 7	73	1282-81540	Screw, idle adjust	1	
6	1267-15110	Muffler	1		74	1282-81460	Spring, idle screw	1	
7	1601-15120	Spark arrester	1		75	*	Body assy	1	*1270-81000
8	1260-15210	Guard, muffler	1		76	1262-81020	Cover, pump	1	
	1260-21100	Crankcase comp.	1	9 to 12	77	3310-81130	Screw, pump cover	1	
9	1260-21110	Crankcase	1		78	1270-81490	Body assy, air purge	1	
10	06030-06201	Ball bearing, inner	1		79	1751-81520	Cover, primer pump	1	
11	1260-21180	Oil seal	1		80	1262-81370	Shaft assy, throttle	1	
12	06035-06001	Ball bearing, outer	1		81	1282-81410	Spring, throttle return	1	
13	1260-21170	Gasket, crankcase	1		82	1262-81340	Valve, throttle	1	
14	1260-21190	Screw, crankcase	4		83	3310-81360	Screw, shutter	1	
	1262-21201	Cover comp., crankcase	1	15 to 17	84	1148-81530	Screw, pump cover	4	
15	1262-21211	Cover, crankcase	1		85	3304-81420	Plug, main welch	1	Press-fit to Body
16	1260-21220	Reed valve	1		86	3304-81430	Plug, idle welch	1	Press-fit to Body
17	1260-21241	Screw, reed valve	2		87	3304-81440	Ring, valve retaining	1	
18	1266-31101	Cover comp., fan	1		88	3304-81450	Screen, check valve	1	
19	3330-75311	Reel, starter	1		89	3310-81390	Clip, throttle shaft	1	
20	1260-75151	Rope, starter	1		90	3310-81351	Screw, shaft retaining	1	
21	1260-75170	Knob, starter	1		91	1185-13130	Gasket, carburetor	1	
22	04064-01812	Snap ring	1		92	0260-00540	Screw, carburetor	2	
23	3330-75201	Spring holder comp.	1		93	1260-83110	Cable, throttle	1	
24	0261-00516	Screw, fan cover	4			1272-84100	Cover comp., air cleaner	1	94 to 101 *1272-84100
	1266-31200	Housing comp., clutch	1	25 to 27	94	*	Cover, air cleaner	1	
25	1266-31210	Housing, clutch	1		95	1260-84120	Lever choke	1	
26	1260-31220	Drum, clutch	1		96	1263-84130	Knob, choke	1	
27	3130-13270	Snap ring	1		97	1260-84140	Spring, friction	1	
28	1260-31233	Sleeve	1		98	1260-84160	Element, air filter	1	
29	1260-31260	Spacer	1		99	1260-84210	Label (Idle)	1	
30	1260-31250	Grommet, switch wire	1		100	1260-84220	Label (Lo-Hi)	1	
	0260-00520	Screw, housing	4		101	1267-84230	Label (Choke)	1	
33	1260-32210	Cover, cylinder	1		102	1270-82610	Body, primer pump	1	
34	1260-32220	Screw, cylinder cover	1		103	1270-82620	Washer	1	
35	1260-41111	Piston	1		104	1270-82630	Nut	1	
36	1260-41220	Ring, piston	1		105	1270-82640	Hose, pump	1	
37	1260-41310	Pin, piston	1		106	0260-00520	Screw, cleaner cover	2	
38	1260-41320	Snap ring	2		107	1260-84150	Plate, choke	1	
39	1260-42201	Crackshaft comp.	1		108	3310-82110	Washer, choke plate	2	
40	1260-42111	Connecting rod	1		109	1256-84171	Plate, choke retaining	1	
41	1260-00609	Roller set	1	13 pcs. a set	110	01642-20508	Washer, carb. screw	1	Used on left side only
42	1260-42252	Thrust washer	2		111	1260-84180	Grommet, idle screw	1	
43	1260-42260	Washer	1		112	1260-84190	Grommet, speed needle	1	
44	1260-42270	Bolt	1	Left-Handed		1270-85000	Fuel tank assy	1	113 to 120
45	1900-42410	Washer	1			1270-85100	Tank comp.	1	113 to 118
46	0282-10805	Nut	1		113	*	Fuel tank	1	*1270-85100
47	1260-43240	Key	1		114	1850-85300	Fuel filter assy	1	
	1260-51002	Clutch assy	1	48 to 50	115	1260-85420	Pipe, suction	1	
48	1260-51110	Shoe, clutch	2		116	1260-85411	Joint	2	
49	1260-51120	Boss, clutch	1		117	1260-85460	Clip	1	
50	1260-51222	Spring, clutch	1		118	1270-85430	Pipe, return	1	
51	1260-71112	Module	1			1260-85202	Fuel cap comp.	1	119 & 120
52	1260-71200	Rotor comp.	1		119	*	Fuel cap	1	*1260-85202
53	1400-72111	Cap, spark plug	1		120	1260-85222	Valve, vent	1	
54	1400-72121	Spring, plug cap	1		121	1270-85141	Pipe, fuel	1	ℓ= 105 mm (4.1")
55	1260-71250	Screw, module	2		122	1270-85150	Pipe, return	1	ℓ= 165 mm (6.5")
56	1260-71260	Spacer	2		123	1950-86120	Clip	1	
57	1115-73111	Spark plug	1	Champion RCJ-8	124	1180-86230	Cushion	4	
	1270-81000	Carburetor assy	1	WA180 58 to 90					
58	1262-81140	Gasket, pump	1	K1 K2	901	1260-99150	Wrench, clutch	1	OP
59	1751-81470	Gasket, diaphragm	1	K1 K2	902	1260-99120	Stopper, crankshaft	1	OP
60	3304-81150	Diaphragm, pump	1	K1 K2	903	1260-99140	Guide, piston pin	1	OP
61	3310-81260	Diaphragm assy	1	K1 K2					
62	3310-81310	Valve, inlet	1	K2	K1	1270-06020	Gasket kit	1	OP
63	1282-81550	Screw, cable retaining	1		K2	1270-06030	Repair kit	1	OP
64	1262-81270	Spring, metering lever	1						
65	3306-81380	Screen, inlet	1						
66	3310-81250	Pin, metering lever	1						
67	3310-81230	Lever, metering	1						

Free Manuals Download Website

<http://myh66.com>

<http://usermanuals.us>

<http://www.somanuals.com>

<http://www.4manuals.cc>

<http://www.manual-lib.com>

<http://www.404manual.com>

<http://www.luxmanual.com>

<http://aubethermostatmanual.com>

Golf course search by state

<http://golfingnear.com>

Email search by domain

<http://emailbydomain.com>

Auto manuals search

<http://auto.somanuals.com>

TV manuals search

<http://tv.somanuals.com>